



:Darrell-James: Hill-Ohioan
:-Minister-Procurator: EBA-1933-AD
:C/O :Jay-Roy: Ingold
5124 East 18th Avenue
Apache Junction, Arizona- State [85119]



1
USA
DOLLAR

REGISTERED MAIL™

:in the Hill-court: Matter-# [:Claim-#] RF 645 167 639 US
:September-22-2022-AD



RF 645 167 639 US

Arizona-State
Pinal-County

Label 200, August 2005

PSN 7690-03-000-9311

:Claim-#: RF 645 167 639 US -Claim of the Completion of the Record

With the Concern of the facts-set-forth into the public-Claim at the Arizona-State-Country-Gila-County-Recorder by the Documents-#: 2005-022460, 2006-008777, 2007-007742, 2007-007743, 2017-002378, 2017-006522, 2018-005176, 2019-009291, 2019-011722 and: 2021-016195.

For this content of this Claim-#: RF 645 167 639 US with these Claims of the Completion of the Record-facts is with the setting-forth of these facts:

~a: **Complement-Claim: A** - :Claim of the Context of the Gila-County-Recorder by the Documents-#: 2005-022460, 2006-008777, 2007-007742, 2007-007743, 2017-002378, 2017-006522, 2018-005176, 2019-009291, 2019-011722 and: 2021-016195:

~b: **Complement-Claim: B** ~ :Claim-Completion of the Record of the fact-Documents for the protection of the right: DOI-1776-AD in the concordance with the PE-2022-AD -PE-2016-AD -DOI-1776-AD et al -Concession-1213-AD -PE-2022-AD~ et seq -EBA-1933-AD -Covenant;

~c: **Complement-Claim: C** ~ :Claim of the Social-Media-Twitter-usage-timed for the protection of the right: DOI-1776-AD in the concordance with the PE-2022-AD -1933-AD -Covenant; and:

~d: **Complement-Claim: D** ~ :Claim of the Social-Media-Twitter-usage-timed for the protection of the right: DOI-1776-AD in the concordance with the law of the PE-2022-AD -EBA-1933-AD -Covenant by the law of the PE-2022-AD -Covenant.

:i- man-affirm that the above is with the true and correct to the best-ability, and -:will-state-same upon the record in the open-court.

in the complete-right: DOI-1776-AD

:Day :September 22, 2022 AD :

Beverly Jean Romero Hill-New Mexican
:Beverly Jean Romero Hill-New-Mexican -
:Grantor-Minister-Procurator: EBA-1933-AD -:Year -2021-AD;

in the complete-right: DOI-1776-AD

:Day :September 22, 2022 AD :

Darrell James Hill-Chowan
:Darrell-James: Hill-Ohioan -SC -Man-Redeemer,
:-Grantor-Minister-Procurator: EBA-1933-AD -:Year -2021-AD;
:Ambassador -Trustee: Concession-1213-AD -:Year -2020-AD.

Jurat

Affirmed and autographed before me this 26th day: September-2022-AD
Type of Identification: Arizona Driver License.

ANITA ESCOBEDO
CLERK OF SUPERIOR COURT

:Notary-Public

Anita Escobedo - Deputy Clerk
(Demille Roche)

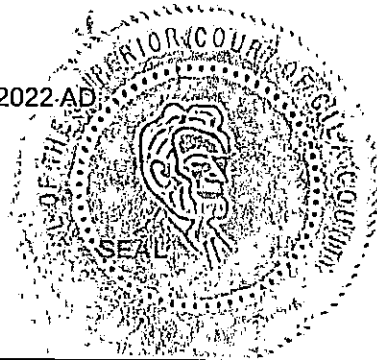



**:Claim-#: RF 645 167 639 US -Claim of the
Completion of the Record**

**Complement-Claim: A – :Claim of the Context of the
Gila-County-Recorder by the Documents-#: 2005-
022460, 2006-008777, 2007-007742, 2007-007743,
2017-002378, 2017-006522, 2018-005176, 2019-
009291, 2019-011722 and: 2021-016195;**

**Complement-Claim: A – :Claim of the Context of the
Gila-County-Recorder by the Documents-#: 2005-
022460, 2006-008777, 2007-007742, 2007-007743,
2017-002378, 2017-006522, 2018-005176, 2019-
009291, 2019-011722 and: 2021-016195;**

**Complement-Claim: A – :Claim of the Context of the
Gila-County-Recorder by the Documents-#: 2005-
022460, 2006-008777, 2007-007742, 2007-007743,
2017-002378, 2017-006522, 2018-005176, 2019-
009291, 2019-011722 and: 2021-016195;**

:Arizona-State -Gila-County -Recorder-Doc.# 2021-016195 See: https://recorder.gilacounty.az.gov/recorder/web/login.jsp See: Public User	:name	:page	:Notes
	<p>Miscellaneous Instrument - 2021-016195</p> <p>Recordation Day: 12/02/2021 10:19:01 AM Related: 2005-022460¹; 2006-008777²; 2007-007742³; 2007-007743⁴; 2017-002378⁵; 2017-006522⁶; 2018-005176⁷; 2019-009291⁸; 2019-011722⁹; Grantor: Darrell-James: Hill-Ohioan- Executor and Beverly-Jean: Romero- New-Mexican- Executor, -:Executor-Procurators: PE¹⁰ -2016-A.D.¹¹ -EBA-1933-A.D. -in -Procurator-. Name: :notice: Procurator Proof-of-notice- 7009 1410 0000 7868 5802¹² - :Executor: PE -2016-A.D. - Executor- Procurator: PE-2016-A.D. -EBA-1933-A.D. -Covenant; Nonconsent to :DOI-1776-A.D.- [de]-privation of :unalienable-rights upon the man-Ohioan and New-Mexican by the Executor: Procurator .</p>	1	<p>1 ~ Regarding, related to, 2 ~USPO 3 ~ Addressee 4 ~ Response</p> <p>1 ~ See: the appended: Claim: 7009 1410 0000 7868 5902, :Procurator-Order: 7009 1410 0000 7868 5902 -document disposed on :December 1st, 2021 A.D., 12:59 p.m. to the USPO by the firstclass- CMN 7009 1410 0000 7868 5902 -mail for the assigned-delivery. 3) :Addressee: Mark: Lamb, -:Pinal-Country-Arizona-State-Sheriff, -:Trustee 4) :Acquiescence</p>
		2	<p>1) :PE-2017-A.D. - :Nonconsent to -:DOI-1776-A.D.- [de]-privations-of-unaleinable-rights by the man- Pinal-Country-Arizona-State-office-Trustee-Dereliction of :LoyaltyOath-of-Office: Executor-Procurator: Darrell-James: Hill, :Ohioan beneficiary- See Day- 3- Notice to the man-Stephen-Q: Miller USPO RMN RE 322 398 361 US¹³. 2) :USPO-CMN -> 7009 1410 0000 7868 5802</p>
2021-016195	Append:	7	:Proof-of-Claims - Cover-Sheet
		11	1) :Ohio-state-Constitution, 1851- 2017 A.D.
		21	1) The -:Declaration of Independence, 1776; The -:Articles of Confederation, 1778; The -:Constituion for the United States of America, 1787; The -first 12 Amendments to the Constitution, 1789 - 1804.

2022-011769 MISC Page: 3 of 2782
 09/26/2022 03:35:37 PM Receipt #: 22-9981
 Rec Fee: \$30.00 Darrell James Hill
 Gila County, Az, Sadie Jo Bingham, Recorder



		Proof-of-Claim – B. 2 / 8	44	1) The -:13th Amendments of the Constitution , 1809
2021-016195	Name: :notice: Procurator Proof-of-notice- 7009 1410 0000 7868 5802 ¹⁴ – :Executor: PE -2016-A.D. - Executor- Procurator: PE-2016-A.D. -EBA-1933-A.D. -Covenant; Nonconsent to :DOI-1776-A.D.- [de-]privation of :unalienable-rights upon the man-Ohioan and New-Mexican by the Executor: Procurator .		:page	:Notes
				1 – Regarding, related to, 2 –USPO 3 – Addressee 4 – Response
		Proof-of-Claim – B. 3 / 8	67	1) :Chap. XX – An Act to establish the Judicial Courts of the Untied States. 1 Stat 73, Statute I, Sept. 24, 1789
		Proof-of-Claim – B. 4 / 8	146	1) :Chap. XXII. – An Act to regulate the collection of duties on imports and tonnage. 1 State 627, Statute III; Mar. 2, 1799.
2021-016195		Proof-of-Claim – B. 5 / 8	225	1) The -:Emancipation-Proclamation ~January 1, 1863~
		Proof-of-Claim – B. 6 / 8	228	1) :General-Order- No. 100: The -:Lieber-Code
		Proof-of-Claim – B. 7 / 8	260	1) :Criminal-code, 35 Stat. 1088 ~March 4, 1909~
		Proof-of-Claim – B. 8 / 8	333	1) The -:Law of Land Warfare, p.1, Sec. 45, Sec. 46
		Proof-of-Claim – C. 1 / 4	338	1) :Documents: EBA-1933-A.D., Part 1, Feb 25 – Mar. 31, 1933.
2021-016195		Proof-of-Claim – C. 2 / 4	370	1) :Article 100- Cestui Que Viet Trust
		Proof-of-Claim – C. 3 / 4	378	1) :P.L. 88-243 , 77 Stat. 630 ... enact the Uniform commercial Code for the District of Columbia, and for other purposes
2021-016195	Name: :notice: Procurator Proof-of-notice- 7009 1410 0000 7868 5802 – :Executor: PE -2016-A.D. - Executor- Procurator: PE-2016-A.D. -EBA-1933-A.D. -Covenant; Nonconsent to :DOI-1776-A.D.- [de-]privation of :unalienable-rights upon the man-Ohioan and New-Mexican by the Executor: Procurator .		:page	:Notes
				1 – Regarding, related to, 2 –USPO 3 – Addressee 4 – Response
		Proof-of-Claim – C. 4 / 4	526	1) :D&B D-U-N-S® Numbers :US dofta gofuf soa jcotsoa com cop sboa pchacd: casa grande, pchacd: apache-Junction.
		Proof-of-Claim – D. 1 / 1	528	1) :Document: 3 day- Notice:

2022-011769 MISC Page: 4 of 2782
09/26/2022 03:35:37 PM Receipt #: 22-9381
Rec Fee: \$30.00 Darrell James Hill
Gila County, Az, Sadie Jo Bingham, Recorder

			4) :Acquiescence	
	Proof-of-Claim – E. 1 / 1	559	1) :Concession of 1213 A.D.	
	Proof-of-Claim – F. 1 / 1	562	1) :New-Mexico-State-Constitution	
2021-016195	Proof-of-Claim – G. 1 / 7	570	1) :Arizona-State-Constitution	
	Proof-of-Claim – G. 2 / 7	583	1) :ARS Title 38-233: Filing oaths of record	
	Proof-of-Claim – G. 3 / 7	585	1) :Pinal-Cournty-Arizona-State-Office- Trustee-Loyalty-Oaths	
	Proof-of-Claim – G. 4 / 7	645	1) :Arizona-Revised-Statute-proofs: Title 1 ¹⁵	
	Proof-of-Claim – G. 5 / 7	659	1) :Arizona-Revised-Statute-proofs: Title 41 ¹⁶	
	Proof-of-Claim – G. 6 / 7	703	1) :Arizona-Revised-Statute-proofs: Title 11 ¹⁷	
	Proof-of-Claim – G. 7 / 7	757	1) :Arizona-Revised-Statute-proofs: Title 47 ¹⁸	
2021-016195	Proof-of-Claim – H. 1 / 1	768	1) :Constructive Notice Of The Setting Of The Setting Of The Presumptions ~Initially: USPO CMN 7018 0360 0000 6959 2963 ~ Presumption Set: USPO RMN 322 404 036 US – entry to :Case-No.: CV 20181825-Oldham: court-rules-agreement for the 'Ingold Pinal-2017-A.D. -Covenant.	
2021-016195	:name	:page	:Notes	
:Arizona-State -Gila-County - Recorder-Doc.# 2019-011722 https://recorder.gilacountyaz.gov/recorder/web/login.jsp See: Public User	Miscellaneous Instrument 2019-011722	:name	:page	:Notes 1 ~ Regarding, related to, 2 ~ USPO 3 ~ Addressee 4 ~ Response

2022-011769 MISC Page: 5 of 2782
09/26/2022 03:35:37 PM
Rec Fee: \$30.00
Gila County, Az, Sadie Jo Gingham, Recorder
James Hill
Receipt #: 22-9381

:Arizona-State -Gila-County -Recorder-Doc.# 2021-016195
See: <https://recorder.gilacounty.az.gov/recorder/web/login.jsp>
See: Public User

Affidavit: Proof-Of-Claim – October 2019

:Recordation-Day: 10/29/2019 11:47:58 AM.
:Related: 2017-002378, 2017-006522, 2018-005176
:Grantor: Darrell-James: Hill, -:Ohioan -beneficiary, :Hill's- Executor- Procurator: PE-2016-A.D.- Pinal-Ingold-2017-A.D.- Covenant in- Procuration.
:Name: Document for the recordatin: including, the -:1) document RMN RE 322 404 169 US also containing the :Affidavit: Statement of :claim – :2017 May-June 8th- Contract- Debt-Notice: Presentment of : Manifest with :Bill; Demand for :Payment on Receipt of the Bill, and and 2) the :receipt- -:Evidence of the USPO-Registered-Mail -sending of the same.

- 1) Proof-of-Claims
- 4) :Acquiescence- All.

:Section -A

4

:Section -A
1) :USPO RMN RE 322 404 169 US 28 Oct. 2019 A.D. , - :Affidavit: Statement of :Claim :2017 MayJune 8th Contract – Debt- Notice; Presentment of : Manifest with :Bill; Demand for :payment on Receipt of :Bill;
3) :Adressee: man- Todd, Steve, Pete, Mike, Anthony, Natiasha: Arizona-State-Pinal-County -Board-of-Supervisors in the c/o :Natasha: Kennedy
4) :Acquiescence -All

2019-011722

:Name: Document for the recordatin: including, the -:1) document RMN RE 322 404 169 US also containing the :Affidavit: Statement of :claim – :2017 May-June 8th- Contract- Debt-Notice: Presentment of : Manifest with :Bill; Demand for :Payment on Receipt of the Bill, and and 2) the :receipt- -:Evidence of the USPO-Registered-Mail -sending of the same.

:page

:Notes

- 1 ~ Regarding, related to,
- 2 ~USPO
- 3 ~ Addressee
- 4 ~ Response

:Section -B) :claim of the harm of the Wrong-Doing Surrounding This Matter is Thrice-Registered wth the Arizona-State-Pinal-County-Sheriff.

7

:Section -B
1) :First- Claim to: Sheriff
2) :USPO CMN 7015 0640 0001 5883 2631 -: 2017 May 09

2022-011769 MISC Page: 6 of 2782
09/26/2022 03:35:37 PM
Rec Fee: \$30.00 Darrell James Hill
Gila County, Az, Saddle Jo Blinsham, Recorder
Receipt #: 22-9381

2022-011769 MISC Page: 7 of 2782
 09/26/2022 03:35:37 PM Receipt #: 22-9381
 Rec Fee: \$30.00 Darrell James Hill
 Gila County, Az, Sadie Jo Birmingham Recorder

:Arizona-State -Gila-County - Recorder-Doc.# 2019-011722	:name	:page	:Notes
			3) :man- Mark: Lamb, -:Sheriff-Office, -:Pinal-County, -:Arizona-State-Country.; and: 2) :USPO RMN: RE 322 399 225 US -: 2017 May 08 3):Addressee: Hinanshu: Patel, Paula: Mullenix, Terrilyn: Klucar, :James: Meadows, :Community-Develpment, and: 2) :USPO CMN 7015 0640 0001 5883 2648 -: 2017 May 08 3) :Addressee: Pinal-County-Civil-Hearing-Office 4) :Acquiescence -All.
		14	1) :Second-Claim to -:Sheriff: 2) :USPO- RMN 322 404 040 US -: 2019 Feb. 12 3):Addressee: Mark: Lamb, -:Sheriff 4) Acquiescence.
		36	1) :Third- Claim to -: Sheriff: 2) :USPO- RMN : 322 404 053 US.-: 2019 June 03 3) :Addressee: Mark: Lamb, -:Sheriff 4) :Acquiescence.
2019-011722		91	1) Denials of Access to the Pinal-County-.Court 2) .USPO CMN: 7018 0360 0000 5968 6115 _; 2019 Mar. 04 3) Addressee: :Amanda: Stanford, -:Pinal-County -Clerk-of-Court 4) Acquiescence.
		96	1) Facts of -:evidence: 2) :USPO-RMN: RE 322 404 036 US -:2019 Jan. 25 3) :Addressee: :Amanda: Stanford, -:Pinal-County -Clerk-of-Court 4) Acquiescence.
		180	1) :Facts of Evidence: 2) :USPO-CMN 7018 0360 0000 5868 8843 -:2019 Jan. 30 3) :Addressee: :Amanda: Stanford, -:Pinal-County -Clerk-of-Court

:Arizona-State -Gila-County -Recorder-Doc.# 2019-011722 2019-011722	:Name: Document for the recordatn: including, the -:1) document RMN RE 322 404 169 US also containing the :Affidavit: Statement of :claim - (2017 May-June 8th- Contract- Debt-Notice: Presentment of : Manifest with -:Bill; Demand for :Payment on Receipt of the Bill, and and 2) the :receipt- -:Evidence of the USPO-Registered-Mail -sending of the same.	:page	:Notes
			4) Acquiescence.
		188	1) Facts of Evidence: 2) :USPO-CMN 7018 0360 0000 5969 3007 -: 2019 Jan. 29 3) :Addressee: :Amanda: Stanford, -:Pinal-County -Clerk-of-Court; :Stephen-F.: McCarville, :Craig: Cameron 4) Acquiescence -All.
		195	1) :Facts of Evidence: 2) :USPO-CMN: 7018 0360 0000 5968 8850 -: 2019 Jan. 30 3) :Addressee: Craig: Cameron 4) :Acquiescence.
		202	1) :Facts of Evidence: 2) :USPO-CMN: 7018 0360 0000 5968 6115 -: 2019 Feb. 15 3) :Addressee: :Amanda: Stanford, -:Pinal-County -Clerk-of-Court 4) :Acquiescence.
:Arizona-State -Gila-County -Recorder-Doc.# 2019-011722	:name	:page	:Notes
	:Section: C: Conuissance- made-unto the Cease of the Wrong-Doings of he Pinal-County, et al.- :Corroborators.	207	:Section -C 1) :Conusance Was Made To Prevent A Continued and Expanded Process of Wrong-Doings Proposed By The Pinal County/ Pinal County Hnad, Policy or Agency, Et Al. with Re: To The Arizona-Superior-Court-record, Pinal clunty: Number: CV201801825 -case 2) :USPO- RMN: Re 322 404 115 US 3) :Addressee -:Stephen-F.: McCarville

2022-May-25 -:Arizona-State -Gila-County -Recorder-Doc.## :2021-16195, 2019-011722, 2019-009291, 2018-005176, 2017-006522, 2017-002378, 2007-007743, 2007-007742, 2006-008777, and 2005-022460 . 7 / 17

:Arizona-State -Gila-County -Recorder-Doc.# 2019-011722	:Name: Document for the recordatin; including, the -:1) document RMN RE 322 404 169 US also containing the :Affidavit: Statement of :claim - :2017 May-June 8th- Contract- Debt-Notice: Presentment of : Manifest with :Bill; Demand for :Payment on Receipt of the Bill, and and 2) the :receipt- -:Evidence of the USPO-Registered-Mail -sending of the same.	:page	:Notes
			4) :Acquiescence.
		214	1) :Right of Conusance 2) :USPO-RMN: RE 322 404 209 US 3) :Addressee: Todd: House, Steve: Miller, Pete: Bios, :mike: Goodman, Anthony: Smith, c/o: Natasha: Kennedy: cc: Kent: Volkmer, Kevin-D.: White. 4) :Acquiescence -All.
	:Section D: Controversy- Dismissed upon the Court-Internal-review	218	:Section -D : CV201801825 -Dismissed:
2019-011722	:Section G: Bill-Rendering; :Demand for Payment in the accordance with the PE-2016-A.D. -Ingold-Pinal-2017-A.D.- Covenant.	221	:Section -G 1) :2017- May-June 8 th -Contract—Fee-Schedule- Biill-Rendering 2919 Oct. 28 2) : 3) :Addressee: man- Pinal-County-Supervisors. 4) :Acquiescence.
:Arizona-State -Gila-County -Recorder-Doc.# 2019-009291	:name	:page	:Notes
:Arizona-State -Gila-County -Recorder-Doc.# -Public-Access: https://recorder.gilacountyaz.gov/recorder/web/login.jsp See: Public User	Miscellaneous Instrument – 2019-009291 Recordation Day: 08/30/2019 02:24:05 PM Related: 2017-002378, 2017-006522, 2018-005176 Grantor: Darrell-James: Hill	1	1 ~ Regarding, related to, 2 ~USPO 3 ~ Addressee 4 ~ Response 1) :Order of Event and Documents as realtes to Gila-County-Recorder-Doc.#: 2017-002378, 2017-006522, and 2018-

2022-May-25 -:Arizona-State -Gila-County -Recorder-Doc.## :2021-16195, 2019-011722, 2019-009291, 2018-005176, 2017-006522, 2017-002378, 2007-007743, 2007-007742, 2006-008777, and 2005-022460 . 7 / 17

Name: August 30th, 2019, :Order of Event explains and correlates the details related to the progressive events effecting the Gila-County, Arizona-State, -Recorder-Doc.##: 2017-002378, 2017-006522, 2018-005176.

005176: #1- 36 -events of the Trustee- Interactions. Political-Election-executed with the description of the rights: PE-2016-A.D. -DOI-1776-A.D.¹⁹- Covenant
4) :Acquiescence.

Attached are the support documents ...
**Pages out of Order: 261 7 264. See: following p. 343

2019-009291

- 9
- 1) Re: #10 , p.3.; First-Recordation
 - 2) :USPO- RMN RE 322 299 251 US -: 2017 March 20 Property-Claim #2/3
 - 3) :Addressee: US-Attorney General, -:Common-Law-Trustee ~CLT~: EBA-1933-A.D.- mature- beneficiary: Lynch, ... Sessions ... Barr ... now. POTUSes: Obama, Trump and Biden- now.
 - 4) Acquiescence -All.

:Arizona-State -Gila-County -Recorder-Doc. # 2019-009291

:name

:page

:Notes

- 336
- 1) Re: #12 , p.3.; First-Recordation – :Demand for the storatoin the #2/3 -: RE 322 299 251 US WITHOUT DELAY.
 - 2) :USPO-RMN 322 399 101 US -: 2017 July 13
 - 3) :Addressee: Jeffrey: Sessions, -:AG
 - 4) :Acquiescence.

- 339
- 1) Re: #13 , p.3.: First-Recordation – :Demand-Property
 - 2) :USPO-RMN RE 322 399 044 US – 2017 July 13
 - 3) :Addressee: Donald: Trump, -:POTUS, plus.
 - 4) :Acquiescence- All.

2019-009291

Name: August 30th, 2019, :Order of Event explains and correlates the details related to the progressive events effecting the Gila-County, Arizona-State, -Recorder-Doc.##: 2017-002378, 2017-006522, 2018-005176.

:page

:Notes

- 1 ~ Regarding, related to,
- 2 ~USPO
- 3 ~ Addressee

2022-011769 MISC Page: 10 of 2782
09/26/2022 03:35:37 PM Receipt # : 22-9881
Rec Fee: \$30.00 Darrell James Hill
Gila County, Az, Sadie Jo Bingham, Recorder

4 - Response

347 1) Re: #14 , p.4.; First-Recordation – Trustee- Dereliction: Constitutional-Protected- Rights
2) :USPO-CMN: 7015 0640 0001 5883 2662 -:2017 June 08
3) :Addressee: Jeffrey: Sessions, -:AG, -:plus -:Trustee- Dereliction: Constitutional-Protected- Rights
4) Acquiescence.

350 1) Re: #15 , p.4.; First-Recordation – :Notice and Demand
2) :USPO-RMN RE 322 399 129 US -:2017 Aug 18
3) :Addressee: man-NSA-agent: Admiral Michael-S.: Rogers
4) Acquiescence.

2019-009291

353 1) Re: #16 , p.4.; First-Recordation – :notice and demand- mitigation for the obtenece of law -:DOI-1776-A.D.- rights: life, liberty, and property with the all-assurance and ensurancee BY THE EBA-1933-A.D.- TRUSTEES
2) :USPO-RMN RE 322 399 132 US -:2017 Aug. 23
3) :Addressee: Donald, -:POTUS, -:military
4) :Acquiescence – All.

373 1) Re: #17 , p.4.; First-Recordation – :Property-Claim #3/3
2) :USPO- RMN RE 322 399 248 US -: 2017 Sept. 15
3) :Jeffrey-B.:Sessions, -US AG, CLT
4) :Acquiescence.

738 1) Re: #18 , p.4.; First-Recordation – :Dishonor of: Trustee: EBA-1933-A.D.- Dereliction: harm upon beneficiary: DOI-1776-A.D. Bill-Rendering in -accordance with the PE-2016-A.D.- EBA-1933-A.D.-Covenant.
2) :USPO- RMN RE 322 399 146 US -: 2017 Jan. 17
3) :Addressee: Jeff: Sessions
4) :Acquiescence.

2022-011769 MISC Page: 11 of 2782
09/26/2022 03:35:37 PM Receipt #: 22-9381
Rec Fee: \$30.00 Darrell James Hill
Gila County, Az. Sadie Jo Bingham, Recorder



2019-009291

Name: August 30th, 2019, :Order of Event explains and correlates the details related to the progressive events effecting the Gila-County, Arizona-State, -Recorder-Doc.##: 2017-002378, 2017-006522, 2018-005176.

:page

:Notes

- 1 ~ Regarding, related to,
- 2 ~USPO
- 3 ~ Addressee
- 4 ~ Response

746

- 1) Re: #19 , p.4.; First-Recordation – :Demand for the Fiduciary-Protection of -:Fundamental-Rights: DOI-1776-A.D., :Offer to Donald; fiduciary ~Not-accepted~
- 2) :USPO- RMN RE 322 399 150 US -: 2018 Jan. 31
- 3) :Addressee: Donald:Trump, Joseph:Dunford, Mark: Milley
- 4) :Acquiescence- All; and :Donald- non-acceptance of -:Fiduciary for the USofA-1776-A.D. -DOI-1776-A.D.-People

751

- 1) Re: #20 , p.5.; First-Recordation – :notice of Default: Option to Cure; :Offer to Donald; fiduciary
- 2) :USPO -RMN RE 322 398 242 US – :2018 April 13
- 3) :Addressee: Donald:Trump, Joseph:Dunford, Mark: Milley
- 4) :Acquiescence- All; and :Donald- non-acceptance of -:Fiduciary for the USofA-1776-A.D. -DOI-1776-A.D.-People

2019-009291

754

- 1) Re: #25 , p.5.; First-Recordation – :Dishonor; :Offer to Donald; fiduciary
- 2) :USPO- RMN RE 047 636 404 US – :2018 May 29
- 3) :Addressee: Donald:Trump, Joseph:Dunford, Mark: Milley
- 4) :Acquiescence- All :and, :Donald-non-acceptance of -:Fiduciary for the USofA-1776-A.D. -DOI-1776-A.D.-People

757

- 1) Re: #26 , p.5.; First-Recordation
- 2) :USPO- CMN 7015 1730 0002 3063 9[6]348 – :2018 July 03
- 3) :Addressee: John: Kasich, Ohio-State-Gov., and
- 3) :Addressee: Steve: Barry, Sheriff :Summit-County,
- 2) :USPO- CMN 7015 1730 0002 3063 9331 -:2018 July 03
- 4) :Acquiescence -All.

2022-011769 MISC Page: 12 of 2782
09/26/2022 03:35:37 PM Receipt #: 22-9381
Rec Fee: \$30.00 Darrell James Hill
Gila County, Az, Sadie Jo Bingham, Recorder



12

		778	1) Re: #28 , p.6.; First-Recordation – :Unlawful-Denial of a lawful: DOI-1776-A.D. Notary-Public Service 3) :Addressee: Arizona-State: Secretary-of-State 4) :[De-]privation of the DOI-1776-A.D.-right; Trustee-Dereliction.
2019-009291	Name: August 30 th , 2019, :Order of Event explains and correlates the details related to the progressive events effecting the Gila-County, Arizona-State, -Recorder-Doc.##: 2017-002378, 2017-006522, 2018-005176.	:page	:Notes 1 ~ Regarding, related to, 2 ~USPO 3 ~ Addressee 4 ~ Response
		781	1) Re: #29 , p.6.; First-Recordation – :Certification-of-Dishonor; 2) :USPO- RMN RE 047 636 435 US -:2018 July 25 3) :Addressee: Ranier-Collins and 3) :Addressee: Brian: Karth, 2) :USPO- RMN RB 898 809 940 US -: 2018 July 25 4) :Acquiescence -All.
2019-009291		788	1) Re: #30 , p.6.; First-Recordation – :notice to GOTUS-Trustee, :Authentiication: beneficiary- Executor-civilian-status-presumption: DOI-1776-A.D.- set. 2) :USPO- RMN RE 322 404 098 US -: 2019 June 27 3) :Addressee: Donald: Trump 4) :Acquiescence.
		800	1) Re: #31 , p.7.; First-Recordation – :notice to GOTUS-Trustee, :Authenticaiton: beneficiary- Executor-civilian-status-presumption: DOI-1776-A.D.- set. 2) :USPO- RMN RE 322 404 084 US -: 2019 June 27 3) :Addressee: William-P: Barr, APC, CLT 4) :Acquiescence.
2019-009291	Name: August 30 th , 2019, :Order of Event explains and correlates the details related to the progressive events effecting the Gila-County, Arizona-	:page	:Notes 1 ~ Regarding, related to,

2022-011769 MISC Page: 13 of 2782
09/26/2022 03:35:37 PM
Rec Fee: \$30.00 Darrell James Hill
Gila County, Az. Sadie Jo Bingham, Recorder

State, -Recorder-Doc.##: 2017-002378, 2017-006522, 2018-005176.

2 -USPO
3 ~ Addressee
4 ~ Response

813 1) Re: #32 , p.7.; First-Recordation – :Record-make of the U.S.-
Citizen- ongoing- [de-]privation of rights: DOI-1776-A.D. - abuse
with harms- made upon this Ohioan-Executor.
2) :USPO- RMN RE 047 636 466 US -: 2018 July 31
3) :Addressee: Doug: Ducey; Ariz.-State-Gov., and:
3) :Addressee: Michele; Ariz.-SOS,
2) :USPO- RMN RE 047 636 470 US with:
2) :USPO- CMN 7017 1000 0000 9394 0773
:Addressee: man- head of -:notary-division
4) Acquiescence -All.

824 1) Re: #34 , p.7.; First-Recordation – :Certificate of Dishonor:
Trustee- Dereliction, and Theft
2) :USPO -RMN RE 047 636 418 US -: 2018 Aug. 07
3) :Addressee: Donald: Trump with
3) :Addressee: Jeff: Sessions
2) :USPO- RMN RB 898 809 919 US -: 2018 Aug. 07
4) :Acquiescence -All.

833 1) Re: #35 , p.; First-Recordation – :Mitigation to Receive: DO
1776-A.D. -service.
2) :USPO -RMN RB 898 809 936 US -: 2018 Aug 09
3) Addressee: Michele: Reagan, Ariz.SOS
4) :Acquiescence.

2019-009291

840 1) Re: #36 , p.; First-Recordation – Trustee- Dereliction , and
Theft
2) :USPO- RMN RE 047 636 449 US -: 2018 Aug. 14
3) :Addressee: Kristin: Scalise: Trustee- Derelict
4) :Acquiescence.

<p>:Arizona-State -Gila-County -Recorder-Doc. # 2019-009291</p>	<p>Name: August 30th, 2019, :Order of Event explains and correlates the details related to the progressive events effecting the Gila-County, Arizona-State, -Recorder-Doc.##: 2017-002378, 2017-006522, 2018-005176.</p>	<p>840 1) Re: #36 , p.; First-Recordation – :Certificate of Dishonor: Trustee- Dereliction , and Theft 2 :USPO- RMN RB 989 809 975 US -: 2018 Aug. 14 3) Addressee: Katie: Mancino 4) :Acquiescence.</p>
<p>:Arizona-State -Gila-County -Recorder-Doc.# 2018-005176 :Arizona-State -Gila-County -Recorder-Doc.# -Public-Access: https://recorder.gilacountyaz.gov/recorder/web/login.jsp See: Public User .</p>	<p>:name :Miscellaneous Instrument - 2018-005176 :Recordation.-day: 05/14/2018 02:29:31 PM; :Related: 2017-002378 :Grantor: Darrell-James: Hill, -:Ohioan, and :Beverly-Jean: Romero- Hill :Related: Arizona-State-Gila-County: #2017-002378. :Grantor: Darrell-James: Hill, and :Beverly-Jean: Romero- Hill :Name: Affidavit: Statement of Claim re: :RMN RE 322 399 177 US – 09/07/2016, -:Jurat: Beverly-Jean: Romero-Hill, and :RMN RE 322 399 163 US – 09/07/2016,, -:Jurat: Darrell-James: Hill.</p>	<p>:page :Notes 1 1 - Regarding, related to, 2 -USPO 3 - Addressee 4 - Response</p>
	<p>I. For the lawful need: we ... did assure delivery of the items by USPO RMN delivery with return-receipt: a:.. : ~attached~ and, b: ... ~attached~ for the recordation of the documents. For reasons not-time unknown, the Item b: was returned with the Itme c: From: Ohoi-State-Summit-County-Office-taker – Kristen-M.: Scalise by the office-taker: Katie: Mancino.</p>	<p>2 1) Re: RMN RE 322 399 177 US – 09/07/2016,, Jurat: Beverl Jean: Romero-Hill- :New-Mexico-State-Rio-Arriba- County, for the recordation- required for the notice of the Live-Life- Status- :Political-Election into the New-Mexico- State- Rio-Arriba -Country-Public-Record. 4) :Filed.</p>
	<p>II. For the lawful need: we ... sent Items b: and c: wit the cover-Letter Item d: ... :Affidavit: Statement of Claim: USPO RMN RE 322 399 194 US And, for the lawful need: we: ... sent</p>	<p>10 1) Re: :RMN RE 322 399 163 US – 09/07/2016,, -:Jurat: Darrell-James: Hill -:Ohio-State-Summit-County, for the recordation 3) :Kristin, -:Summit-County-Recorder-Officer 4) :[De-}privattion-block of the Civil-Live-Status-Recordation.</p>

2022-011769 MISC Page: 15 of 2782
09/26/2022 03:35:37 PM Receipt #: 22-9381
Rec Fee: \$30.00 Darrell James Hill
Gila County, Az, Sadie Jo Bingham, Recorder

51

:Arizona-State -Gila-County - Recorder-Doc. # 2018-005176	e: ... USPO RMN RE 322 399 203 US	18	1) :notice to the man-Ohio-State-Summit-County-Sheriff, -:Steve, and -Recorder, -:Kristin 3) :Kristin, -:Recorder and Steve, -:Sheriff 4) :[De-]privation-block of the Civil-Live-Status. :Sherriff- Acquiescence.
:Arizona-State -Gila-County - Recorder-Doc.# 2017-006522 :Arizona-State -Gila-County - Recorder-Doc.# -Public-Access: https://recorder.gilacountyaz.gov/ recorder/web/login.jsp See: Public User	:name :Affidavit - 2017-006522 :Recordation Day: 07/07/2017 10:09:05 AM :Related: 2017-002378 Grantor: HILL DARRELL JAMES Name: :Declaration in Claim Against Criminal Wrong-Doings By State Party Agenets Of The United States-Department Of Justice, "DOJ", And Of The 9 th Circuit Court Administration: Of :[De-]privation of rights: DOI-1776-A.D. Of :[De-]privations imposed ... For the Exercise of my Rights: DOI-1776-A.D. ...	:page 1	:Notes 1 ~ Regarding, related to, 2 ~USPO 3 ~ Addressee 4 ~ Response 1) Re: Deprivation Of Inalienable-Rights: DOI-1776-A.D. 4) Acquiescence.
:Arizona-State -Gila-County - Recorder-Doc.# 2017-002378 :Arizona-State -Gila-County - Recorder-Doc.# -Public-Access: https://recorder.gilacountyaz.gov/ recorder/web/login.jsp See: Public User	:name :Miscellaneous Instrument - 2017-002378 :Grantors: man- Darrell-James: Hill and wife -:Beverly-Jean: Romero- Hill. :Name: Affidavit: Proof of Claims :a) :notice: Proof of Mailing, :b) :notice: Proof of Claims	:page 1	:Notes 1 ~ Regarding, related to, 2 ~USPO 3 ~ Addressee 4 ~ Response 2 1) :a: notice: Proof-of-Mailing of the resetting of the Preemption, by the man- Darrell-James: Hill and wife -:Beverly-Jean: Romero- Hill. 3) Arizona-Atate- Sheriffs, -Elected-Officials; US-Corp. -GOTUS -:Trustee: EBA-1933-A.D. 4) Acquiescence.
:Arizona-State -Gila-County -	:Name: Affidavit: Proof of Claims	182	1) :b :Notice: Proof-of-Claim, Re: In the Hill-Court... -:i man:-

2022-011769 MISC Page: 16 of 2782
09/26/2022 03:35:37 PM Receipt #: 22-9381
Rec Fee: \$30.00 Darrell James Hill
Gila County, Az, Sadie Jo Birmingham, Recorder

11

Recorder-Doc. # 2017-002378	:a) :notice: Proof of Mailing, :b) :notice: Proof of Claims		Darrell-James: Hill ... v. Loretta: Lynch; woman; ... :Claimaint- Case No.: CMN 7009 1410 0000 7868 5703 3) :man-Office-takers: USDC - Arizona -Court-Offices 4) :Willfull .-[De-]privation of the man-right: DOI-1776-A.D.- authority -access to the open-court.
:Arizona-State -Gila-County - Recorder-Doc.# 2007-007743 :Arizona-State -Gila-County - Recorder-Doc.# -Public-Access: https://recorder.gilacountyaz.gov/ recorder/web/login.jsp See: Public User	:name Miscellaneous Instrument: 2007-007743 :Recordation Day: 05/04/2007 02:17:00 PM :Grantor: Darrell-James: Hill :Name: Jurat: Non-Statutory- Abatement: Case-No. RB 898 807 966 US	:page 1	:Notes 1 ~ Regarding, related to, 2 ~USPO 3 ~ Addressee 4 ~ Response 1) Non-Statutory- Abatement: Case-No. RB 898 807 966 US to: US-Court-of-Appeals- 9 th Circuit :D.C. No. CV0500877-DGC 4) Acquiescence.
:Arizona-State -Gila-County - Recorder-Doc.# 2007-007742 :Arizona-State -Gila-County - Recorder-Doc.# -Public-Access: https://recorder.gilacountyaz.gov/ recorder/web/login.jsp See: Public User	:name Miscellaneous Instrument: 2007-007742 :Recordation Day: 05/04/2007 02:17:00 PM :Grantor: Darrell-James: Hill :Name: Jurat: Non-Statutory- Abatement: Case-No. RB 898 807 921 US		:Notes 1 ~ Regarding, related to, 2 ~USPO 3 ~ Addressee 4 ~ Response 1) Non-Statutory- Abatement: Case-No. RB 898 807 921 US to US-Court-of-Appeals- 9 th Circuit :D.C. No. CV0500877-DGC 4) Acquiescence.
:Arizona-State -Gila-County - Recorder-Doc.# 2006-008777 :Arizona-State -Gila-County - Recorder-Doc.# -Public-Access: https://recorder.gilacountyaz.gov/ recorder/web/login.jsp See: Public User	:name :Miscellaneous -Instrument: 2006-008777 :Grantors: man- Darrell-James: Hill :Name: notice- Request for the Withdrawal of the SSA, Form SSA-521	:page 1	:Notes 1 ~ Regarding, related to, 2 ~USPO 3 ~ Addressee 4 ~ Response 1 ~ Account-Rending, Settle and Closure of the EBA-1933- A.D.-Cestui-Que-Vie for the man- Darrell-James: Hill

2022-011769 MISC Page: 17 of 2782
09/26/2022 03:35:37 PM
Rec Fee: \$30.00
Gila County, Az, Saddle Jo
Darrell James Hill
Bingham, Recorder

Ohioan- Beneficiary- Settlor- Grantor.
3 ~ US-Corp.- GSP: Trustee: EBA-1993-A.D.- Office-takers.
4 ~ Acquiescence.

:Arizona-State -Gila-County -Recorder-Doc.#	:name	:page	:Notes
2006-008777 :Arizona-State -Gila-County -Recorder-Doc.# -Public-Access: https://recorder.gilacountyaz.gov/recorder/web/login.jsp See: Public User	:Affidavit - 2005-022460 :Grantor: man- Darrell-James: Hill :Name: notice- Request for the Withdrawal of the SSA, Form SSA-521 :Grantors: Darrell-James: Hill- Ohioan, and: Benverly-Jean: Romero-Hill- New-Mexican	1	1 ~ Regarding, related to, 2 ~USPO 3 ~ Addressee 4 ~ Response 1 ~ USDC-Arizona: CV 05 0877 PHX DGC 4 ~ Acquiescence.

:Arizona-State -Gila-County -Recorder-Doc.#	:name	:page	:Notes
2005-022460 :Arizona-State -Gila-County -Recorder-Doc.# -Public-Access: https://recorder.gilacountyaz.gov/recorder/web/login.jsp See: Public User	:Affidavit - 2005-022460 : PAGES: 1436, Recording Fee: 250.00 ** :Grantors: Darrell-James: Hill, and: Beverly-Jean: Romero- Hill :Name: USDC-Arizona: CV 05 0877 PHX DGC **The -:rpublic-recording is with the no -public-access as a matter without the authority of :l- man by the authority of :i- man- Ohioan Executor: PE-2016-A.D.. See: Arizona-State -Gila-County -Recorder-Doc. # 2017-002378 .	1	1 ~ Regarding, related to, 2 ~USPO 3 ~ Addressee 4 ~ Response 1 ~ USDC-Arizona: CV 05 0877 PHX DGC 4 ~ Acquiescence.

:Arizona-State -Gila-County -Recorder-Doc. #	:name	:page	:Notes
2005-022460			

2022-011769 MISC Page: 18 of 2782
09/26/2022 03:35:37 PM
Rec Fee: \$30.00 Darrell James Hill
Gila County, Az, Saddle Jo Bingham, Recorder

- 1 **2005-022460 means:** Affidavit – 2005-022460, Rec Date: 12/07/2005 02:18:00 PM . Grantor: :Darrell-James: Hill -Ohioan, Beverly-Jean: Romero- Hill -New-Mexican
- 2 **2006-008777 means:** Miscellaneous Instrument – 2006-008777 Rec Date: 05/22/2006 02:49:00 PM . Grantor: Darrell-James: Hill -Ohioan
- 3 **2007-007742 means:** Miscellaneous Instrument – 2007-007742 Rec Date: 05/04/2007 02:17:00 PM . Grantor: Darrell-James: Hill -Ohioan
- 4 **2007-007743 means:** Miscellaneous Instrument – 2007-007743 Rec Date: 05/04/2007 02:17:00 PM . Grantor: Darrell-James: Hill -Ohioan
- 5 **2017-002378 means:** Miscellaneous Instrument – 2017-002378 Rec Date: 03/10/2017 12:35:10 PM . Grantor: :Darrell-James: Hill -Ohioan, Beverly-Jean: Romero- Hill -New-Mexican
- 6 **2017-006522 means:** Affidavit 2017-006522 – Rec Date: 07/07/2017 10:09:05 AM . Grantor: Darrell-James: Hill -Ohioan
- 7 **2018-005176 means:** Miscellaneous Instrument – 2018-005176 Rec Date: 05/14/2018 02:29:31 PM . Grantor: :Darrell-James: Hill -Ohioan, Beverly-Jean: Romero- Hill -New-Mexican
- 8 **2019-009291 means:** Miscellaneous Instrument – 2019-009291 Rec Date: 08/30/2019 02:24:05 PM . Grantor: Darrell-James: Hill -Ohioan
- 9 **2019-011722 means:** Miscellaneous Instrument – 2019-011722 Rec Date: 10/29/2019 11:47:58 AM . Grantor: Darrell-James; Hill -Ohioan, Beverly-Jean: Romero- Hill, Jay-Roy: Ingold, Lisa: Loeffler, Tracy-Robert: Calhoun, James-William: Woods
- 10 **:Political-Election ~PE~ means:** the -:Grantor with the Express-Declaration of the right: DOI-1776-A.D. is with the appointment of the Executor: DOI-1776-A.D. -status, duty and obligation to the State-Country-Man-beneficiary: DOI-1776-A.D., et al. et seq. with the law of the PE-2016-A.D.- DOI-1776-A.D. -Concession-1213-A.D. ~PE-2016-A.D.- EBA-1933-A.D.- **Covenant** by the law of the PE-2016-A.D.- Covenant. See: **ibid. 5. pp. 1 -181. – a)** Assignment of Executor: Constructive Notice of "DARRELL JAMES HILL" of the Darrell-James of the family :Hill, :Authorized-Representative; **b)** Political-Election: PE-2016-A.D. - EBA-1933- A.D.- Superior-Constructive-Notice and Demand: Permanent- Non-Commercial- Presumption as the man: Darrell-James: Hill- Ohioan- Executor, etc. -:Beverly-Jean: Romero- Hill- New-Mexican- Executor: PE-2016-A.D. - et al.
- 11 **:PE-2016-A.D. means:** PE ~Political-Election: DOI-1776-A.D., in the year: 2017 ~referring to the a) Assignment of Executor: Constructive Notice of "DARRELL JAMES HILL" of the Darrell-James of the family :Hill, :Authorized-Representative; the -: a) Superior-Constructive-Notice and b) Demand: Permanent- Non-Commercial- Presumption as the man: Darrell-James: Hill- Ohioan. See: Gila-County-Recorder-Doc.# 2017-002378, pp.
- 12 **7009 1410 0000 7868 5802 means:** :PE-2016-A.D. -Ingold-Pinal-2017-A.D. -:Nonconsent to :DOI-1776-A.D.- [de-]privations-of-unalienable-rights: DOI-1776-A.D. by the man- Pinal-Country-Arizona-State-office-Trustee-Dereliction of the Loyalty-Oath-of-Office: Executor-Procurator: Darrell-James: Hill, :Ohioan beneficiary. – See: Day- 3- Notice to the man-Stephen-Q: Miller USPO RMN RE 322 398 361 US.
- 13 **:RE 322 398 361 US means:**
- 14 **7009 1410 0000 7868 5802 means:** :PE-2016-A.D. -Ingold-Pinal-2017-A.D. -:Nonconsent to :DOI-1776-A.D.- [de-]privations-of-unalienable-rights: DOI-1776-A.D. by the man- Pinal-Country-Arizona-State-office-Trustee-Dereliction of the Loyalty-Oath-of-Office: Executor-Procurator: Darrell-James: Hill, :Ohioan beneficiary. – See: Day- 3- Notice to the man-Stephen-Q: Miller USPO RMN RE 322 398 361 US.
- 15 **:Arizona-Revised-Statute-proofs: Title 1 means:**

COPY

19

**:Claim-#: RF 645 167 639 US -Claim of the
Completion of the Record**

**: Complement-Claim: B ~ :Claim-Completion of the
Record of the fact-Documents for the protection of the
right: DOI-1776-AD in the concordance with the PE-
2022-AD -PE-2016-AD -DOI-1776-AD et al -
Concession-1213-AD ~PE-2022-AD~ et seq -EBA-
1933-AD -Covenant;**

**: Complement-Claim: B ~ :Claim-Completion of the
Record of the fact-Documents for the protection of the
right: DOI-1776-AD in the concordance with the PE-
2022-AD -PE-2016-AD -DOI-1776-AD et al -
Concession-1213-AD ~PE-2022-AD~ et seq -EBA-
1933-AD -Covenant;**

**: Complement-Claim: B ~ :Claim-Completion of the
Record of the fact-Documents for the protection of the
right: DOI-1776-AD in the concordance with the PE-
2022-AD -PE-2016-AD -DOI-1776-AD et al -
Concession-1213-AD ~PE-2022-AD~ et seq -EBA-
1933-AD -Covenant;**





:2012-A.D. - Document History; 1 / 1

:2012 A.D.

#	:man- trustee	:association	:year, :day	USPO, other	:covenant
1	:J-C.: Sloan	McKinley-County:-New-Mexico-State, :Recorder	10/02/12	McKinley-County:-New-Mexico-State, :Recorder Doc.# 360413	Recordation: Affidavit: 23 pages. We, the Hills, husband and wife verify as indicated.
2	:Barack: Hussein: Obama	POTUS	08/31/12	RE 430 969 426 US	Account, settle and close EBA-1933-A.D.; close SSA. :Astrue agrees with -:no-compliant-action; p. 3.
3	:John-J.: Astrue	U.S.- SSA- Comm.		↓	:Darrell-James: Hill, -:Ohioan- beneficiary, -:Executor Notice of Default for the account, settle and close EBA-1933-A.D.; close SSA. :Astrue agreement with -:silent-non-action; p. 4
4	:Barack: Hussein: Obama	POTUS		↓	:Beverly-Jean: Romero- Hill, -:New-Mexican- beneficiary, -:Executor Notice of Default for the account, settle and close EBA-1933-A.D.; close SSA. :Astrue agreement with -:silent-non-action; p. 8.
5	:John-J.: Astrue	U.S.- SSA- Comm.	09/18/12	7009 7820 0003 8851 6155	Notices of Default: Darrell-James: Hill ~husband~ is with the agreement with the silent-non-action; p. 14, 15.
6	:John-J.: Astrue	U.S.- SSA- Comm.		↓	Notices of Default: Beverly-Jean: Romero- Hill ~wife~ is with the agreement with the silent-non-action; p. 14, 19.

:2012-A.D. - Document History; 1 / 1

18

:2013 A.D.

#	:man- trustee	:association	:year, :day	USPO, other	:covenant
1	:Susan-R.: Bolton	:Judge -USDC- Arizona; CV07-1292-Phx-SRB; Johnson v. AzHHA,	07/22/13	7009 1410 0000 7868 5673	:Darrell-James: Hill, -:Claimant- no. 000000930. :Request for Trustee Protection of -:beneficiary; Hill- Darrell-James ~Ohioan~.
2	:Mark: Samson	Keller- Rohback, P.L.C.	↓	↓	↓
3	:Ron: Kilgard	↓	↓	↓	↓
4	:Mark-A.: Griffin	Keller- Rohback, L..L.P.	↓	↓	↓
5	:Raymond:A.: Farrow	↓	↓	↓	↓
6	:David-F.: Sorensen	Berger & Montague, P.C.	↓	↓	↓
7	:David: Balto	Law Offices of David Balto	↓	↓	↓
8	:Martha-L.: Fitzgerald	:Brown Hyatt Farber Schreck LLP	↓	↓	↓
9	:Jeffrey-S.: Rugg	:Judge -USDC- Arizona; CV07-1292-Phx-SRB; Johnson v. AzHHA	↓	↓	Darrell-James: Hill, -:Claimant- no. 000000930. :Request for Trustee Protection of -:beneficiary; Hill- Darrell-James ~Ohioan~.
	:man- trustee	:association	:year, :day	USPO, other	:covenant
10	:Joe: Shirley, Jr.	Apache-County-Arizona-State, -:Bd- Supv.	07/26/13	7009 1410 0000 7868 5710	Requirement for unimpeded access to the public-record.

22

23

:2013-A.D. Document- History

2 / 8

11	:Tom-M.: White, Jr.	↓	↓	↓	↓
12	:Barry: Welter	↓	↓	↓	↓
13	:Michael-B.: Whiting	Apache-County-Arizona-State, -:Attorney	↓	↓	↓
14	:Delwin-P.: Wengert	Apache-County-Arizona-State, -:Manager	↓	↓	Requirement for unimpeded access to the public-record.
	:man- trustee	:association	:year, :day	USPO, other	:covenant
15	:Susan-R.: Bolton	:Judge -USDC- Arizona; CV07-1292-Phx-SRB; Johnson v. AzHHA, -:Doc. # 762.	07/26/13	CV07-1292-Phx-SRB; Johnson v. AzHHA, -:Doc. # 762.	DOI-1776-A.D., et al.: AOC-1778-A.D., :CftUSofA-1787-A.D., -:Ohioan © -1958-A.D. -:exclusive-peculiar-absolute-owner; -:EBA-1933-A.D.-beneficiary.
16	:David-B.: Rosenbaum	↓	↓	↓	↓
17	:Lawrence-Allen: Katz	↓	↓	↓	↓
18	:Charles-Steven: Price	↓	↓	↓	↓
19	:P.-Bruce: Converse	↓	↓	↓	↓
20	:Andrew-L.: Pringle	↓	↓	↓	↓
21	:James-R.: Broening	↓	↓	↓	↓
22	:Mark-D.: Samson	↓	↓	↓	↓
23	:James-A.: Craft	↓	↓	↓	↓
24	:Barry-D.: Halpern	↓	↓	↓	↓





:2013-A.D. Document- History

3 / 8

25	:Ron: Kilgard	↓	↓	↓	↓
26	:Randall-S.: Yavitz	↓	↓	↓	↓
	:man- trustee			USPO, other	:covenant
27	:Leigh-Eric: Dowell	↓	↓	↓	DOI-1776-A.D., et al.: AOC-1778-A.D., :CftUSofA-1787-A.D., -:Ohioan © -1958-A.D. -:exclusive-peculiar-absolute-owner; -:EBA-1933-A.D.- beneficiary.
28	:Joel-W.: Nomkin	↓	↓	↓	↓
29	:Keith: Beauchamp	↓	↓	↓	↓
30	:Richard-Kenneth: Delo	↓	↓	↓	↓
31	:Randall: Papetti	↓	↓	↓	↓
32	:Jeffrey-J.: Campbell	↓	↓	↓	↓
33	:Franklin-James: Hoover	↓	↓	↓	↓
34	:Jessica-Lee: Everett-Garcia	↓	↓	↓	↓
35	:Dan-W.: Goldfine	↓	↓	↓	↓
36	:Amy-N-.L.: Hanson	↓	↓	↓	↓
37	:Lauren-Jacqueline: Weinzweig	↓	↓	↓	↓
38	:Jeffrey-A.: LeVee	↓	↓	↓	↓

Handwritten initials or mark

25

:2013-A.D. Document- History 4 / 8

39	:Robert-Thomas: Acuinas- Sullivan	↓	↓	↓	↓
40	:Michael-T.: Liburdi	↓	↓	↓	↓
41	:Scott-Sebastian: Minder	↓	↓	↓	↓
DOI-1776-A.D., et al.: AOC-1778- A.D., :CftUSofA-1787-A.D., -:Ohioan © -1958- A.D. -:exclusive-peculiar-absolute-owner; -:EBA- 1933-A.D.- beneficiary.					
42	:James-P.: McLoughlin, Jr.	↓	↓	↓	↓
	:man- trustee	:association	:year, :day	USPO, other	:covenant
43	:Brian-Michael: Flaherty	↓	↓	↓	↓
44	:David-A.: Ettinger	↓	↓	↓	↓
45	:Kerry-Scott: Martin	↓	↓	↓	↓
46	:Kami-S.: Galvani	↓	↓	↓	↓
47	:Jill-Louise: Ripke	↓	↓	↓	↓
48	:Katherine-I.: Funk	↓	↓	↓	↓
49	:David-F.: Sorensen	↓	↓	↓	↓
50	:Eric-L.: Cramer	↓	↓	↓	↓
51	:Barry-Steven: Taus	↓	↓	↓	↓
52	:David-P.: Smith	↓	↓	↓	↓

53	:W.-Ross: Foote	↓	↓	↓	↓
54	:David-A.: Balto	↓	↓	↓	DOI-1776-A.D., et al.: AOC-1778-A.D., :CftUSofA-1787-A.D., -:Ohioan © -1958-A.D. -:exclusive-peculiar-absolute-owner; -:EBA-1933-A.D.- beneficiary.
55	:Andrew-William: Kelly	↓	↓	↓	↓
56	:Roopali-H.: Desai	↓	↓	↓	↓
57	:Winthrop-Blackstone: Reed, III	↓	↓	↓	↓
58	:David-B: Helms	↓	↓	↓	↓
59	:Richard-B.: Walsh, Jr	↓	↓	↓	↓
	:man- trustee	:association	:year, :day	USPO, other	:covenant
60	:Allen-Spencer: Boston	↓	↓	↓	↓
61	:Stephen-Michael: Durbin	↓	↓	↓	↓
62	:Mark-A.: Griffin	↓	↓	↓	↓
63	:Raymond-J.: Farrow	↓	↓	↓	↓
64	:Benjamin-William: Reeves	↓	↓	↓	↓
65	:Joan: McPhee	↓	↓	↓	↓

22

27

66 :Tyler-Reese: Bowen

↓

↓

DOI-1776-A.D., et al.: AOC-1778-
A.D., :CftUSofA-1787-A.D., -:Ohioan © -1958-
A.D. -:exclusive-peculiar-absolute-owner; -:EBA-
1933-A.D.- beneficiary.

↓

:man- trustee

:association

:year, :day

USPO, other

:covenant

67 :Neill-Wilson: Clark

↓

↓

↓

↓

68 :Martha-L.: Fitzgerald

↓

↓

↓

↓

69 :Allen-P.: Grunes

↓

↓

↓

↓

70 :Jeffrey-S.: Rugg

↓

↓

↓

↓

71 :Timothy-R.: Beyer

↓

↓

↓

↓

72 :Shauna-B.: Itri

↓

↓

↓

↓

73 :Mark-J.: Horoschak

↓

↓

↓

↓

74 :Brian-A.: Hayles

↓

↓

↓

↓

75 :Jane-E.: Willis

↓

↓

↓

↓

76 :Matthew-P.: Garvey

↓

↓

↓

↓

76 :Penny-Hirsch: Edwards

↓

↓

↓

↓

77 :Tony-L.: Mitchell

↓

↓

↓

↓

:man- trustee

:association

:year, :day

USPO, other

:covenant

78 :Debbie-Weston: Harden

↓

↓

↓

↓

79 :Catherine-T.: Broderick

↓

↓

↓

↓

80	:Dennis-D.: Palmer	:Judge -USDC- Arizona; CV07-1292-Phx-SRB; Johnson v. AzHHA, -:Doc. # 762.	07/26/13	CV07-1292-Phx-SRB; Johnson v. AzHHA, -:Doc. # 762.	DOI-1776-A.D., et al.: AOC-1778-A.D., :CftUSofA-1787-A.D., -:Ohioan © -1958-A.D. -:exclusive-peculiar-absolute-owner; -:EBA-1933-A.D.- beneficiary.
81	:Susan-R.: Bolton	:Judge -USDC- Arizona; CV07-1292-Phx-SRB; Johnson v. AzHHA,	07/31/13	7009 1410 0000 7868 5680	:Darrell-James: Hill, -:Claimant- no. 000000930. :Request for Trustee Protection of -:beneficiary; Hill- Darrell-James ~Ohioan~. ;Failure of Trustee-Justice to comply: Restatement of Order.
82	:Susan-R.: Bolton	:Judge -USDC- Arizona; CV07-1292-Phx-SRB; Johnson v. AzHHA,	08/16/13	RE 817542 444 US	Re: Ailing Compliance of the Trustees: Statement of the Order.
83	:Joe: Shirley, Jr.	Apache-County-Arizona-State, -:Bd- Supv.	08/19/13	RB 898 807 997 US	Public-Record-Information-Request by the Beneficiaries of the Public-Trust
84	:Tom-M.: White, Jr.				
85	:Barry: Welter				
86	:Michael-B.: Whiting	Apache-County-Arizona-State, -:Attorney			
87	:Delwin-P.: Wengert	Apache-County-Arizona-State, -:Manager			Public-Record-Information-Request by the Beneficiaries of the Public-Trust
88	:Susan-R.: Bolton	:Judge -USDC- Arizona; CV07-1292-Phx-SRB; Johnson v. AzHHA,	09/24/13	RE 817 542 577 US	Certificate of the Trustee-Default
89	:Mark: Samson	Keller- Rohback, P.L.C.			

87

29

:2013-A.D. Document- History 8 / 8

90	:Ron: Kilgard					
91	:Mark-A.: Griffin	Keller- Rohback, L.L.P.				
92	:Raymond:A.: Farrow					
93	:David-F.: Sorensen	Berger & Montague, P.C.				
94	:David: Balto	Law Offices of David Balto				
95	:Martha-L.: Fitzgerald	:Brown Hyatt Farber Schreck LLP				
96	:Jeffrey-S.: Rugg	:Judge -USDC- Arizona; CV07- 1292-Phx-SRB; Johnson v. AzHHA	09/24/13	RE 817 542 577 US	Certificate of the Trustee-Default	

						:2015 A.D.
#	:man- trustee	:association	:year, :day	USPO, other	:covenant	
1	:Michelle: Reagan	:Arizona-State-Secretary	07/25/15	7008 1300 0002 2256 4613	Beverly-Jean: Romero- Hill, -:DOI-1776-A.D., et al.: AOC-1778-A.D., :CftUSofA-1787-A.D., -:New Mexican-©-1958-A.D. -:exclusive-peculiar-absolute-owner; -:EBA-1933-A.D.- beneficiary. :Trademark-ation denied without explanation.	
2	:Michelle: Reagan	:Arizona-State-Secretary	07/25/15	7006 3450 0003 5691 3447	:Darrell-James: Hill, -:DOI-1776-A.D., et al.: AOC-1778-A.D., :CftUSofA-1787-A.D., -:Ohioan-©-1958-A.D. -:exclusive-peculiar-absolute-owner; -:EBA-1933-A.D.- beneficiary. :Trademark-ation denied without explanation.	
3						
4						
5						
6						

du

:2016 A.D.

#	:man- trustee	:association	:year, :day	USPO, other	:covenant
1	:Victor: Suarez-Melendez	:Puerto-Rico- United-States, -:Secretary of State	01/03/16	RE 817 542 585 US	:Darrell-James: Hill, -:Ohioan- beneficiary: EBA-1933-A.D. - Conditional- Acceptance re: response: "... we don't have jurisdiction over the matter.' 01/03/16
2	:Francisco-J.: Rodriquez- Bernier	:Puerto-Rico- United-States, -:Asst. Secretary of State, Comm.-Transactions- Registry	↓	↓	↓
3	:Victor: Suarez-Melendez	:Puerto-Rico- United-States, -:Secretary of State	01/03/16	RE 817 542 585 US	:Beverly-Jean: Romero- Hill, -:New-Mexican- beneficiary: EBA-1933-A.D. - Conditional- Acceptance re: response: "... we don't have jurisdiction over the matter.' 01/03/16"
4	:Francisco-J.: Rodriquez- Bernier	:Puerto-Rico- United-States, -:Asst. Secretary of State, Comm.-Transactions- Registry	↓	↓	↓
5	:Melba: Acosta-Febo	:Puerto-Rico- United-States, -:Secretary of State	01/20/16	First-Class- Mail	UCC1PR recordation for the account of the Cesuti-Que-Use of the EBA-1933-A.D.- U.S.- indenture to the Ohioan- Darrell-James: Hill- debenture with the idem-sonans- subrogation-

15

32

					entitled: DARRELL JAMES HILL, et al. - derivatives.
6	:Melba: Acosta-Febo	:Puerto-Rico- United-States, -:Secretary of State			UCC1PR recordation for the account of the Cesuti-Que-Use of the EBA-1933-A.D.- U.S.- indenture to the New-Mexican- Beverly-Jean: Romero- Hill- debenture with the idem-sonans-subrogation- entitled: BEVERLY JEAN ROMERO, et al. - derivatives.
7	:Francisco-J.: Rodriquez-Bernier	:Puerto-Rico- United-States, -:Asst. Secretary of State, Comm.-Transactions-Registry	01/20/16	First-Class- Mail	:Darrell-James: Hill, -:Ohioan- beneficiary: EBA-1933-A.D. - Denial- Continured of the UCC1PR re: response: '... security-agreement has to be authenticated by the signatures of the debtor and the secured party.' 01/20/16
8	:Francisco-J.: Rodriquez-Bernier	:Puerto-Rico- United-States, -:Asst. Secretary of State, Comm.-Transactions-Registry			:Beverly-Jean: Romero- Hill, -:New-Mexican-beneficiary: EBA-1933-A.D. - Denial- Continured of the UCC1PR re: response: '... security-agreement has to be authenticated by the signatures of the debtor and the secured party.' 01/20/16

:2017 A.D.

#	:man- trustee	:association	:year, :day	USPO, other	:covenant
1	:Brian: Karth	: USDC- Arizona, -:Clerk.	03/07/17	7015 0640 0001 5883 2600	:Re: Bill-rendered- for the payment of the Covenant-Compensation for the Trespass on the Claimant-Case by the man-USDC-Trustee upon the Hill- Court, -:Case# 7009 1410 0000 7868 5703
2	:Ranier: Collins	:USDC- Arizona, -:Chief- Judge	03/07/17	7015 0640 0001 5883 2617	:Re: Bill-rendered- for the payment of the Covenant-Compensation for the Trespass on the Claimant-Case by the man-USDC-Trustee upon the Hill- Court, -:Case# 7009 1410 0000 7868 5703
3	:Sidney	9 th Circuit- Judicial Council Executive Committee, -:Chief- Judge, Chairman/	04/27/17	RE 322 399 234 US; See: Gila-County-Recorder- Doc.# 2019-009291, p. 366.	Notice: 9 th Circuit-Trespass upon the Fundamental and Substantive-Rights, and Comm-law-Claim- Rights under the Color-of-Law.man-USDC-Trustee upon the Hill- Court, -:Case# 7009 1410 0000 7868 5703
4	:Richard:	9 th Circuit- Judicial Council Executive Committee, -:Circuit- judge	↓	↓	↓
5	:Susan	9 th Circuit- Judicial Council Executive Committee, -:Senior-	↓	RE 322 399 234 US; See: Gila-County-Recorder- Doc.# 2019-009291, p. 366.	Notice: 9 th Circuit-Trespass upon the Fundamental and Substantive-Rights, and Comm-law-Claim- Rights under the Color-of-Law.man-USDC-Trustee

33

24

		District- Judge, Chairman			upon the Hill- Court, -:Case# 7009 1410 0000 7868 5703
6	:Sadie-Jo: Bingham	Gila-County-Arizona- State- Recorder	03/10/17	Gila-County-Recorder-Doc.#: 2017-002378	:Affidavit: Proof-of-Claims – August- 2019; related to: Gila-County-Recorder-Doc.#: 2017- 002378
7	:Sadie-Jo: Bingham	Gila-County-Arizona- State- Recorder	07/07/17	Gila-County-Recorder-Doc.#: 2017-006522	:Affidavit: Proof-of-Claims – August- 2019; related to: Gila-County-Recorder-Doc.#: 2017- 002378
8	:Donald-John: Trump	POTUS	07/13/17	RE 322 399 044 US	:Proof of Claim: Declaratin in Claim Against Criminal Wrong-Doings .. re: Gila county, Arizona Recorder # 2017-006522- July 7, 2017. → re: #13 on p. 3; see: doc., p. 337. Proofs of -:delivery
9	:Jeff: Sessions	U.S.- AG, CLT		RE 322 399 058 US	↓
	:man- trustee	:association	:year, :day	USPO, other	:covenant
10	:Elizabeth: Strange	U.S.- Atty. Phx	↓	7015 0640 0001 5883 2655	↓
11	:Laurie: Day	Chief, OIP	↓	RE 322 399 061 US	↓
12	:Michael: Horowitz	IG- DOJ	↓	RE 322-399 089 US	↓
13	:Robert-P.: Storch	Dep. IG-DOJ	↓	↓	↓
14	:Andrew: McCabe	FBS Dep. Director	↓	RE 322 399 075 US	↓
15	:David: Bowditch	FBI Assoc. Dep.	↓	↓	↓
16	:Richard: Benson	FBI Branch Mgr	↓	USPO First Class Mail	↓
17	:Michael: DeLeon	FBI Agent	↓	↓	↓

18	:Mark: Lamb	Pinal-County-Ariz., -:Sheriff	↓	RE 322 399 092 US	:Proof of Claim: Declaration in Claim Against Criminal Wrong-Doings .. re: Gila county, Arizona Recorder # 2017-006522- July 7, 2017. → re: #13 on p. 3; see: doc., p. 337. Proofs of -:delivery
19	:Vanessa-R.: Brinkmann	U.S.- DOJ- OIP- Senior- Counsel		07/31/17 Standard Mail	Re: 07/13/17- letter to: RE 322 399 061 US. Discussion re: FOIA and DOJ- record-keeping.
20	:Donald- Trump	POTUS		08/21/17 7015 0640 0001 5883 2686	See; RE 322 399 132 US: Gila-County-Recorder- Doc.# 2019-009291, p. 353.
21	:Jeff: Sessions	U.S.-A.G, CLT	↓	7015 0640 0001 5883 2716	↓ ; C-2716: Proof of -:delivery.
	:man- trustee	:association	:year, :day	USPO, other	:covenant
22	:Elizabeth, Strange	Asst.- AG, Arizona	↓	7015 0640 0001 5883 2709	See; RE 322 399 132 US: Gila-County-Recorder- Doc.# 2019-009291, p. 353.
23	:Mark: Brnovich	Arizon-State- A.G.		08/23/17 7015 0640 0001 5883 2723	Notice and Demands- of theft of :-i- man- exclusive-perculiar-absolute-property -trespass with harm-imposed upon :-i- man by the man- Government of the United States- 2003-A.D.- Trustee: EBA-1933-A.D.
24	:Mark: Lamb	Pinal-County- Arizona-State, -:Sheriff	↓	7015 0640 0001 5883 2730	Notice and Demands- of theft of :-i- man- exclusive-perculiar-absolute-property -trespass with harm-imposed upon :-i- man by the man- Government of the United States- 2003-A.D.-

GC

36

Trustee: EBA-1933-A.D.

25	:Sidney	9 th Circuit- Judicial Council Executive Committee, -:Chief-Judge, Chairman/	08/18/17	7015 0640 0001 5883 2679 with -:RE 322 399 234 US -enclosed;	:notice- 2 with -:demand: reporting criminal subordinate-employee- Trustee -deprivation of -:rights under the color-of-law. For :RE 322 399 234 US; See: Gila-County-Recorder- Doc.# 2019-009291, p. 366.
26	:Richard:	9 th Circuit- Judicial Council Executive Committee, -:Circuit-judge	↓		↓
	:man- trustee	:association	:year, :day	USPO, other	:covenant
27	:Susan	9 th Circuit- Judicial Council Executive Committee, -:Senior-District- Judge, Chairman	↓	7015 0640 0001 5883 2679 with -:RE 322 399 234 US -enclosed;	:notice- 2 with -:demand: reporting criminal subordinate-employee- Trustee -deprivation of -:rights under the color-of-law. For :RE 322 399 234 US; See: Gila-County-Recorder- Doc.# 2019-009291, p. 366.
28	:Joseph-Williams	U.S.C.Appeals, 9 th Circuit-Court, -:San-Francisco, -:Deputy Clerk	08/30/17	Standard Mail.	Re: 7015 0640 0001 5883 2679 with -:RE 322 399 234 US -enclosed; .. the correspondence also did not claim, ... we found no basis to treat.... All communications should be addressed to the Clerk... court's jurisdiction is defined by federal statute.... The court is unable to accept filings that are not written in English.

2022-011769 MISC Page: 36 of 2782
 09/26/2022 03:37 PM Receipt #: 22-9381
 Rec Fee: \$30.00 Darrell James Hill
 Gila County, Az, Sadie Jo Bingham, Recorder



:2018-A.D. Document- History

1 / 19

:2018 A.D.

#	:man- trustee	:association	:year, :day	USPO, other	:covenant
1	:Jeff: Sessions	US- AG, CLT	01/17/18	RE 322 399 146 US; See Gila-County-Recorder- Doc.# 009291, p. 738.	:Jeff- U.S.- Ag- CLT- Dishonor with -:Bill-of-Particulars for the PE-2016-A.D., et al.- deprivation- penalty- agreement to the property-lots-stolen: 1,2, and 3.
2	:Donald- Trump	:POTUS	01/31/18	RE 322 399 150 US; See Gial-County-Recorder- Doc.# 2019-009291, p. 746.	Demand for the fiduciary-protection of the fundamental- rights. Re: Jeff- U.S.-AG-CLT- Dishonor: RE 322 399 146 US – Verified-claims.0
3	:Joseph: Dunford	:JCOS- General	↓	↓	↓
4	:Mark: Milley	:COS- Army- General	↓	↓	Demand for the fiduciary-protection of the fundamental- rights. Re: Jeff- U.S.-AG-CLT- Dishonor: RE 322 399 146 US – Verified-claims.
	:Donald: Trump	↓	02/26/18	cc:7015 0640 0001 5883 2747;	Demand for the Congressional-Oversight for the Enforced- protection of -:Funamental-Rights-Executed with cc: Donald- POTUS- CORRESPONDENCE: ~ Demand P, et al. -↓
	:Joseph: Dunford	↓	↓	↓	↓ , :Gen. CJOS
	:Marik: Milley	↓	↓	7015 0640 0001 5883 2747	↓ , :Gen. COS- USofA- Army
5	:Chuck: Grassley	U.S. Legislature -:Senator – Committee on the Judiciary	02/26/18	7015 0640 0001 5883 2747; All noticed were sent fascimile of this document.	Demand for the Congressional-Oversight for the Enforced- protection of -:Funamental-Rights-Executed -:7015 0640 0001 5883 2747 sent with -:All -noticed - sent -fascimile of this document.

:2018A.D. Document- History

1 / 19

6

28

:2018-A.D. Document- History 2 / 19

6	Dianne: Feinstein	↓	↓	↓	↓
7	:Orrin-G.: Hatch	↓	↓	↓	↓
	:man- trustee	:association	:year, :day	USPO, other	:covenant
8	:Linsey: Graham	↓	02/28/18	↓	↓
9	:John: Cornyn	↓	↓	↓	↓
10	:Mike: Lee	↓	↓	↓	↓
11	:Ted: Criz	↓	↓	↓	↓
12	:Ben: Sasse	↓	↓	↓	↓
13	:Jeff: Flake	↓	↓	↓	↓
14	:Mike: Crapo	↓	↓	↓	↓
15	:Thom: Tillis	↓	↓	↓	↓
16	:John: Kennedy	↓	↓	↓	↓
17	:Patrick: Leahy	↓	↓	↓	↓
18	:Richard: Durbin	↓	↓	↓	↓
19	:Sheldon: Whitehouse	↓	↓	↓	↓
	:man- trustee	:association	:year, :day	USPO, other	:covenant
20	:Amy: Klobuchar	↓	02/28/18	↓	↓
21	:Christopher-A.: Coons	↓	↓	↓	↓

:2018-A.D. Document- History 3 / 19

22	:Richard: Blumenthal					
23	:Mazei-K.: Hirono					
24	:Cory-A.: Booker					
25	:Kamala-D.: Harris	U.S. Legislature -: Senator – Committee on the Judiciary	02/28/18	7015 0640 0001 5883 2747;	All noticed were sent fascimile of this document.	
26	:Chuck: Grassley	U.S. Legislature -: Senator – Committee on the Judiciary	02/28/18	7015 0640 0001 5883 2754	Demand for the Congressional-Oversight for the Enforced- protection of -:Funamental-Rights-Executed -:7015 0640 0001 5883 2747 sent.	
27	:Dianne: Feinstein					
28	:Bob: Goodlatte	U.S. Legislature -: Representative– Committee on the Judiciary		7015 0640 0006 0063 7029	Demand for the Congressional-Oversight for the Enforced- protection of -:Funamental-Rights-Executed -:7015 0640 0001 5883 2747 sent.	
	:man- trustee	:association	:year, :day	USPO, other	:covenant	
29	:Jerold: Nadler		02/28/18	7015 0640 0006 0063 7029	Demand for the Congressional-Oversight for the Enforced- protection of -:Funamental-Rights-Executed -:7015 0640 0001 5883 2747 sent.	
30	Darrell: Issa					
31	:Steve: King					
32	:Raul: Labrador					
33	:Tom: Marino					

Handwritten initials

07



:2018-A.D. Document- History

4 / 19

34	:James: Sensenbrenner, Jr	↓	↓	↓	↓
35	:Doug: Collins	↓	↓	↓	↓
	:man- trustee	:association	:year, :day	USPO, other	:covenant
36	:Ron: DeSantis	U.S. Legislature -:Representative- Committee on the Judiciary	02/28/18	7015 0640 0006 0063 7029	Demand for the Congressional-Oversight for the Enforced- protection of -:Funamental-Rights-Executed -:7015 0640 0001 5883 2747 sent.
37	:Blake: Farenhold	↓	↓	↓	↓
38	:Louie:Gohmert, Jr.	↓	↓	↓	↓
39	:David: Cicilline	↓	↓	↓	↓
40	:Steve: Cohen	↓	↓	↓	↓
41	:Sheila: Jackson- Lee	↓	↓	↓	↓
42	:Heny-Hank: Johnson, Jr.	↓	↓	↓	↓
43	:Zoe: Lofgren	↓	↓	↓	↓
44	:Karen: Bass	↓	↓	↓	↓
45	:Andy: Biggs	↓	↓	↓	↓
	:man- trustee	:association	:year, :day	USPO, other	:covenant
46	:Ken: Buck	U.S. Legislature -:Representative-	02/28/18	7015 0640 0006 0063 7029	Demand for the Congressional-Oversight for the Enforced- protection of -:Funamental-Rights-Executed

Committee on the Judiciary					:-7015 0640 0001 5883 2747 sent.
	:man- trustee	:association	:year, :day	USPO, other	:covenant
47	:Steve: Chabot	↓	↓	↓	↓
48	:Val: Dennings	↓	↓	↓	↓
49	:Theodore: Deutch	↓	↓	↓	↓
50	:Matt: Gaetz	↓	↓	↓	↓
51	:Trey: Gowdy	↓	↓	↓	↓
52	:Luis: Gutierrez	↓	↓	↓	↓
53	:Karen: Handel	↓	↓	↓	↓
54	:Pramila: Jayapal	↓	↓	↓	↓
55	:Hakeem: Jeffries	U.S. Legislature -:Representative- Committee on the Judiciary	02/28/18	7015 0640 0006 0063 7029	Demand for the Congressional-Oversight for the Enforced- protection of -:Funamental-Rights-Executed -:7015 0640 0001 5883 2747 sent.
56	:mike: Johnson	↓	↓	↓	↓
57	:Jim: Jordan	↓	↓	↓	↓
58	:Ted: Lieu	↓	↓	↓	↓
59	:Ted: Poe	↓	↓	↓	↓
60	:Jamie: Raskin	↓	↓	↓	↓
61	:John: Ratcliffe	↓	↓	↓	↓
62	:Cedric: Richmond	↓	↓	↓	↓

47

42

:2018-A.D. Document- History 6 / 19

63	:Martha: Roby					
64	:John: Rutherford	U.S. Legislature -:Representative- Committee on the Judiciary	02/28/18	7015 0640 0006 0063 7029	Demand for the Congressional-Oversight for the Enforced- protection of -:Funamental-Rights-Executed -:7015 0640 0001 5883 2747 sent.	
	:man- trustee	:association	:year, :day	USPO, other		:covenant
65	:Bradley: Schneider					
66	:Lamar: Smith					
67	:Eric: Swalwell					
68	:Trey: Gowdy	U.S. Legislature -:Representative- Committee on Oversight and Government Reform	02/28/18	7015 0640 0001 5883 2761	Demand for the Congressional-Oversight for the Enforced- protection of -:Funamental-Rights-Executed -:7015 0640 0001 5883 2747 sent.	
69	:Elijah: Cummings					
70	:Ron: DeSantis					
71	:Blake: Farenthold					
	:man- trustee	:association	:year, :day	USPO, other		:covenant
72	:Will: Hurd					
73	:Mark: Meadows					
74	:Gary: Palmer					
75	:Paul: Gosar					
76	:Glenn: Grothman					

:2018-A.D. Document- History 7 / 19

77	:Jody: Hice					
78	:man- trustee	:association	:year, :day	USPO, other		:covenant
79	:Stephen: Lynch	U.S. Legislature -:Representative- Committee on Oversight and Government Reform	02/28/18	7015 0640 0001 5883 2761		Demand for the Congressional-Oversight for the Enforced- protection of -:Funamental-Rights-Executed -:7015 0640 0001 5883 2747 sent.
80	:Stacey-E.: Plaskett					
81	:Justin: Amash					
82	:Rod: Blum					
83	:Matt: Cartwright					
84	:William: Clay					
85	:James: Comer					
86	:man- trustee	:association	:year, :day	USPO, other		:covenant
87	:Jim: Cooper	U.S. Legislature -:Representative- Committee on Oversight and Government Reform	02/28/18	7015 0640 0001 5883 2761		Demand for the Congressional-Oversight for the Enforced- protection of -:Funamental-Rights-Executed -:7015 0640 0001 5883 2747 sent.
88	:mark: DeSaulnier					
89	:Scott: DesJarlais					
90	:Jimmy: Duncan					
91	:Virginia: Foxx					

GA

114

:2018-A.D. Document- History 8 / 19

92	:Greg: Gianforte					
93	:Jimmy: Gomez					
94	:Darrell: Issa					
	:man- trustee	:association	:year, :day	USPO, other		:covenant
95	Brenda: Lawrence	U.S. Legislature -:Representative- Committee on Oversight and Government Reform	02/28/18	7015 0640 0001 5883 2761		Demand for the Congressional-Oversight for the Enforced- protection of -:Funamental-Rights-Executed -:7015 0640 0001 5883 2747 sent.
96	:Caroly: Maloney					
97	:Thomas: Massie					
98	:Eleanor: Holmes: Norton					
99	:Jamie: Raskin					
100	:Dennis: Ross					
101	:Mark: Sanford					
	:man- trustee	:association	:year, :day	USPO, other		:covenant
103	:Bonnie: Watson- Coleman					
104	:Peter: Welch	U.S. Legislature -:Representative- Committee on Oversight and Government Reform	02/28/18	7015 0640 0001 5883 2761		Demand for the Congressional-Oversight for the Enforced- protection of -:Funamental-Rights-Executed -:7015 0640 0001 5883 2747 sent.

:2018-A.D. Document- History 9 / 19

105	:Paul- Gosar	U.S. Legislature -:Representative- Arizona- State	03/19/18	7015 1730 0002 3063 9379	Importune for the attention to the :- man -enduring the -:dprivation of -:fundamental-right- problems-imposed under the color-of-law
106	:John: McCain	U.S. Legislature -:Senator- Arizona-State	03/19/18	7015 1730 0002 3063 9386 with the :7015 0640 0001 5883 2747 - Demand for -:Funamental- Rights-Executed	Importune for the attention to the :- man -enduring the -:dprivation of -:fundamental-right- problems-imposed under the color-of-law
107	:Jeff: Flake				
108	:John: McCain	U.S. Legislature -:Senator- Arizona-State	04/16/18	Re: 7015 1730 0002 3063 9386	'...;i cannot be of assistance at this time.'
109	man- :Summit- County-Ohio-State	Summit-County-Recorder- Office.	04/12/18	RE 322 399 163 US	:Ohioan-beneficiary-Executor with the exclusive- peculiar-absolute-right: EBA-1933-A.D.-covenant- Executive-duty for the establishment of the civil-live- status. :See Gila-County-Recorder-Doc.# 2018-5176, p. 18. – Jurat: Curative-Registration of the live ... -:Darrell-James: Hill- Ohioan-beneficiary, -: beneficiary-Executor: EBA-1933-A.D.
110	man- :Arriba- County-:New- Mexico-State	Arriba-County-Recorder- Office	04/12/18	RE 322 399 177 US	:New-Mexican-beneficiary-Executor with the exclusive- peculiar-absolute-right: EBA-1933-A.D.-covenant- Executive-duty for the establishment of the civil-live- status. :See Gila-County-Recorder-Doc.# 2018-5176, p. 2. – Jurat: Curative-Registration of the live ... -:Beverly-Jean: Romero-Hill- Ohioan-beneficiary, -: beneficiary-Executor: EBA-1933-A.D.
	:man- trustee	:association	:year, :day	USPO, other	:covenant

GH

46

:2018-A.D. Document- History 10 / 19

	:Sadie-Jo: Bingham	Gila-County-Arizona-State-Recorder	05/14/18	Gila-County-Recorder-Doc.#: 2018-005176	:Affidavit: Proof-of-Claims -- August- 2019; related to: Gila-County-Recorder-Doc.##: 2017-002378
111	:Donald: Trump	:POTUS	05/29/18	RE 047 636 404 US	Delivery-confirmation return-receipt
112	:Joseph: Dunford	:JCOS- General	↓	↓	↓
113	:Mark: Milley	:COS- Army- General	↓	↓	Delivery-confirmation return-receipt
114	:Michele: Reagan	Arizona-State-Secretary-Trustee	07/03/18	First Class Mail	Arizona-State-Notary-Trustee-Autograph-Veriication by the Trustee-Dereliction: 1) Constructive-notice of DARRELL JAMES HILL of the Darrell-James: Hill, Ohioan, A.R.- benefit; 2) Superior-notice of the political-election: Darrell-James: Hill- Ohioan-beneficiary, -:Executor: EBA-1933-A.D. 3) Curative- Birth-County-Registration of the Live-Life-Executor-requirement. 4) Etc.
115	:John: Kasich	Ohio-State-Governor-Trustee	07/03/18	7015 1730 0002 3063 9348	Assignment of the Executor: EBA-1933-A.D. - debenture-subrogation-entitled- DARRELL JAMES HILL, et al.- derivatives. Political-Election by the Ohioan-Executor: EBA-1933-A.D., -:Darrell-James: Hill, -:civilian, -PE 2018-A.D. -; see: Gila-County-Recorder-Doc.# 009291; p. 757. <u>See: appended: July 3rd, 2018: 12:15 p.m.</u> -:Constructive notice of ... :Executor, and: <u>12:17 p.m.</u> - :Superior- Constructive ... -Presumption; man-



Darrell-James: Hill, -:Ohioan.

116 :Steve: Barry Summit-County-Sheriff-Trustee ↓ 7015 1730 0002 3063 9331

117 :Steve: Barry Summit-County-Sheriff-Trustee 07/05/18 7015 1730 0002 3063 9362

:Claim fo Criminal-Wrong-Doing: Deprivation of the Protected-Right for the record documents into the public-record is Criminal-violated by the People at the Summit-CountyOhion-State- Recordation-agency ...; appended.

118 :Donald: Trump POTUS 07/12/18 7017 1000 0000 9343 0698

:Certificate of Protest: Donald- Trump with the :Claim of the contract for the receipt of property-Claimed

119 :Jeff: Sessions U.S.- AG, -:CLT ↓ 7017 1730 0002 3063 9324

:Certificate of Protest: Jeff: Sessions with the :Claim of the contract for the receipt of property-Claimed

:man- trustee :association :year, :day USPO, other :covenant

120 :Donald: Trump POTUS 07/10/18 7017 1000 0000 9343 0698, 7017 1730 0002 3063 9324

:Claim-of the contract for the receipt of property-Claimed

121 :Jeff: Sessions U.S.- AG, -:CLT ↓ ↓

122 :Brian: Karth :USDC- Arizona, -:Clerk 07/18/18 7015 1730 0002 3063 9300

:Bill of :Costs – re: Trespass-on-the-case-covenant-agreement: Common -law-Claim #: 7009 1410 0000 7868 5703; recorded at the USDC-venue on the 01/04/17 by the USPO -RMN: RE 322 399 336 US.

123 :Ranier: Collins :USDC- Arizona, -:Chief-Judge ↓ 7017 1000 0000 9343 0704

:Bill of :Costs – re: Trespass-on-the-case-covenant-agreement

47

48

:2018-A.D. Document- History 12 / 19

124	:Brian: Karth	:USDC- Arizona, -:Clerk	07/20/18	Standard Mail	'unclear how to process the enclosed document' -: 7015 1730 0002 3063 9300. :Bill of :Costs – re: Trepass-on-the-case-covenant : Common -law- Claim #: 7009 1410 0000 7868 5703; recorded at the USDC-venue on the 01/04/17 by the USPO -RMN: RE 322 399 336 US.
125	:K.: Smith	:USDC- Arizona, -:Clerk- deputy	↓	↓	↓
	:man- trustee	:association	:year, :day	USPO, other	:covenant
126	:Bridget-S.: Bade	:USDC- Arizona, -:Magistrate- Judge	07/31/18	Standard Mail	:No. CV-17-00026-PHX-BSB -:ORDER. – color-of-law- stricken as ~ :Bill of :Costs – re: Trepass-on-the- case-covenant: Common -law-Claim #: 7009 1410 0000 7868 5703; recorded at the USDC-venue on the 01/04/17 by the USPO -RMN: RE 322 399 336 US.
127	:Kristen: Scalise	:Summit-County-Ohio-State, -:Fiscal- Officer	07/19/18	7015 1730 0002 3063 9287	:Bill-of-Costs: – re: Deprivation-covenant- agreement :Curative Registration of Live...-:Darrell- James: Hill, -:Ohioan-beneficiary-Executor with the exclusive-peculiar-absolute-right: EBA-1933-A.D.- covenant- Executive-duty for the establishment of the civil-live-status. :See Gila-County-Recorder-Doc.# 2018-5176, p. 18. – Jurat: Curative-Registration of the live ... -:Darrell-James: Hill- Ohioan-beneficiary, -: beneficiary-Executor: EBA-1933-A.D. ~ sent for the recordation -04/12/18: USPO RMN: RE 322 399 163 US.

50

:2018-A.D. Document- History 14 / 19

	:man- trustee	:association	:year, :day	USPO, other	:covenant
136	:Brian-D.: Karth	USDC- Arizona- Clerk	08/01/18	Standard Mail	Re: Certificate-of-Protest, :un-clear as to how it should be processed, -:Phoenix
137	:S.: Strong	USDC- Arizona- Clerk- deputy	↓ 08/01/18	↓	Re: Certificate-of-Protest,
138	:AC.	USDC- Arizona- Clerk- deputy	08/02/18	Standdard Mail	Re: Certificate-of-Protest, :document ... not comport with the Courts Local rules, -:Tucson
139	:Donald- Trump	:POTUS	08/07/18	RE 047 636 418 US	:Certificate-of-Dishonor. See: Gila-County-Recorder- Doc.# 009291, p. 824.
140	:Jeff: Sessions	US- AG, CLT	↓	RB 898 809 919 US	↓
141	:Michelle: Reagan	:Arizona-State- Secretary	08/09/18	RB 898 809 936 US	:Mitigation: public-service-legal-advice with the unlawful-obstruction: notarial-acts by the Trustee-dereliction
142	:man	:Head oif the Notary- Division	↓	↓	:Mitigation: public-service-legal-advice
	:man- trustee	:association	:year, :day	USPO, other	:covenant
143	:Kristen: Scalise	:Summit-County-Ohio-State, -:Fiscal- Officer	08/14/18	RE 047 636 449 US	:Certificate of Dishonor. - See: Beneficiary-Claim of the silent - No-response- answer-received in the responses of the Cerrtificate- of-Protest ~for the annexes, see: Certificate-of-Protest - 07/25/18; 7017 1000 0000 9343 0650 . ↓
144	:Katie: Mancino	:Summit-County-Ohio-State, -:Fiscal- Office, -:Executive-	↓ 08/14/18	RB 898 809 975 US.	:Certificate of Dishonor. - See: Beneficiary-Claim of the silent - No-response-

	Assistant I				answer-received in the responses of the Certificate-of-Protest -for the annexes, see: Certificate-of-Protest - 07/25/18; 7015 1730 0002 3063 9270 .
145	:Ranier: Collins	:USDC- Arizona, -:Chief-Judge	08/14/18	RE 047 636 435 US	:Certificate-of-Dishonor - See: Beneficiary-Cliam of the Non-responsive-Answer ...; no- annexations ↓
146	:Brian: Karth	:USDC- Arizona, -:Clerk	08/14/18	RB 898 809 940 US	↓ :Certificate-of-Dishonor -
147	:Jovita: Carranza	U.S.- :Treasurer-Office	08/20/18	7018 0360 0000 5969 3885	Beverly-Jean: Romero- Hill, -:New-Mexican-beneficiary, -:Beneficiary-Executor: EBA-1933-A.D., demand to account, settle and closure of the EBA-1933-A.D.- debenture now.
148	:Jack: Lew	U.S. -:Fiscal-Asst. Sec.	↓	7018 0360 0000 5969 3892	↓ account, settle and closure of the EBA-1933-A.D.- debenture now.
149	:Steven-Turner: Mnuchin	U.S.- Dept of the Treasury	↓	7018 0360 0000 5969 3808	↓ account, settle and closure of the EBA-1933-A.D.- debenture now.
150	:Kimberly: Troy	U.S.- Bureau of the Fiscal-Service	↓ 08/20/18	7018 0360 0000 5969 3815	↓ account, settle and closure of the EBA-1933-A.D.- debenture now.
		:man- trustee	:association	:year, :day	USPO, other
151	:Kristen: Scalise	:Summit-County-Ohio-State, -:Fiscal- Officer	08/29/18	7018 0360 0000 5969 3861	:Mitigation- Verification: Certificate-of-Protest, Certificate-of-Dishonor

51

52

152	:Katie: Mancino	:Summit-County-Ohio-State, :-Fiscal- Office, -:Executive- Assistant I	↓ 08/29/18	7018 0360 0000 5969 3878	:Mitigation- Verification: Certificate-of-Protest, Certificate-of-Dishonor- Verification
	:man- trustee	:association	:year, :day	USPO, other	:covenant
153	:Mark: Lamb	:Pinal-County-Arizona :-Sheriff	08/29/18	7017 1000 0000 9343 0728	:Darrell-James: Hill, -:Ohioan, -:beneficiary-Executor: EBA-1933-A.D.; :Beverly-Jean: Romero- Hill, -:New-Mexican, -:beneficiary- Executor: EBA-1933-A.D. :Assistant-bank-manager unlawful control over the Arizona-State-Notary-Public causing harm upon the beneficiary.
154	:Mark: Brnovich	:Arizona-State -:AG	↓ 08/29/18	First Class Mail	↓
155	:Michelle: Reagan	:Arizona-State -:Secretary	↓ 08/29/18	First Class Mail	↓
156	:John: Stumpt	:Wells-Fargo and Co. :-Presidnt and CEO	↓ 08/29/18	7017 1000 0000 9343 0735	↓
157	:Lawrence: Lee	:Wells-Fargo Mac S4049- 011, -Bank-Manager	↓ 08/29/18	First Class Mail	:Darrell-James: Hill, -:Ohioan, -:beneficiary-Executor: EBA-1933-A.D.; :Beverly-Jean: Romero- Hill, -:New-Mexican, -:beneficiary- Executor: EBA-1933-A.D.
	:man- trustee	:association	:year, :day	USPO, other	:covenant



:2018-A.D. Document- History

17 / 19

158	:Ranier: Collins	:USDC- Arizona, -:Chief- Judge	08/29/18	7018 0360 0000 5969 3847	:Mitigation- Verification: Certificate-of-Protest, Certificate-of-Dishonor
160	:Brian: Karth	:USDC- Arizona, -:Clerk	↓ 08/29/18	7018 0360 0000 5969 3854	:Mitigation- Verification: Certificate-of-Protest, Certificate-of-Dishonor
	:man- trustee	:association	:year, :day	USPO, other	:covenant
161	:Donald- Trump	:POTUS	08/29/18	7018 0360 0000 5969 3830	:Mitigation- Verification: Certificate-of-Protest, Certificate-of-Dishonor
162	:Jeff: Sessions	US- AG, CLT	↓ 08/29/18	7018 0360 000 5968 8935	:Mitigation- Verification: Certificate-of-Protest, Certificate-of-Dishonor
163	:man	:Wells-Fargo, -Customer- Correspondence: MAC [REDACTED]	09/06/18	Standard Mail.	:Beverly: 'We researching the items brought to our attention'
164	:man	:Wells-Fargo, -Customer- Correspondence: MAC [REDACTED]	09/06/18	Standard Mail.	:Darrell: 'We researching the items brought to our attention'
165	:Mark: Brnovich	:Arizona-State- AG; Consumer-Protection-and - Advocacy-Section	09/10/18	Standard Mail.	:Darrell: 'If you wish... file a complaint'
166	:G.: Shaw	:Wells-Fargo, -Customer- Correspondence: MAC [REDACTED] -:Research/Remediation- Analyst	09/12-18	Standard Mail.	:Darrell and Beverly, based-upon the presumption of your illegal-request, ... [hearsay-speculation]... confirmed they would not be able to complete your request.
	:man- trustee	:association	:year, :day	USPO, other	:covenant

54

:2018-A.D. Document- History 18 / 19

167	:man	:Department-of-Treasury	10/24/18	7018 0630 0000 5968 9811	:Beverly-Jean: Romero- Hill, -:New-Mexican, -:beneficiary- Executor: EBA-1933-A.D. :Inquiry of the Department of the Treasury -fiduciary -duty to :- man.
	:man	:Department-of-Treasury	10/24/18	7018 0630 0000 5968 9828	:Darrell-James: Hill, -:Ohioan, -:beneficiary- Executor: EBA-1933-A.D. :Inquiry of the Department of the Treasury -fiduciary -duty to :- man.
	:man	:Department-of-Treasury	11/07/18	Standard Mail.	:Darrell, :We could not locate a TreasuryDirect under the social-security-number-provided
	:man	:Department-of-Treasury	11/07/18	Standard Mail.	:Beverly, :Please be aware that neither your birth certificate nor your social security number are ... any type of Department of Treasury obligation.`
	:man- trustee	:association	:year, :day	USPO, other	:covenant
	:man	:Internal-Revenue-Service	11/15/18	7018 0360 0000 5968 8904	:Darrell-James: Hill, -:Ohioan- Executor- notice: Revocation fo the Internal Revenue Service Power of the Attorney
	:man	:Internal-Revenue-Service	11/15/18	7018 0360 0000 5969 2949	:Beverly-Jean: Romero- Hill, -:New-Mexican- Executor- notice: Revocation fo the Internal Revenue Service Power of the Attorney
	:man	:Bureau: Fiscal-Servie	11/22/18	7018 0360 0000 5969 2936	:Beverly-Jean: Romero- Hill, -:New-Mexican- Executor. If the -:Department-of-Treasury has not



anything to do with the :Beverly-Jean: Romero- Hill,
-:New-Mexican and the EBA-1933-A.D.- debenture,
then you should openly-tell everyone.

:man Bureau of the Fiscal-Service 12/17/18 7018 0360 0000 5968 8898

:Darrell-James: Hill, -:Ohioan- beneficiary,
 -:Beneficiary- Executor: EBA-1933-A.D. – how and
why was no account located for :i- man in/under the
Department of Treasury.

:man- trustee :association :year, :day USPO, other

:covenant

:man- trustee :association :year, :day USPO, other

:covenant

55

:2019 A.D.

#	:man- trustee	:association	:year, :day	USPO, other	:covenant
1	:man	:U.S.-Corp.- :Government of the United-States of 1933-, 2003 A.D.- self-Indenture: EBA-1933-A.D. ~:GofUS-1933-A.D. :GofUS-:2003-A.D. :GofUS-1933-A.D.. -:2003-A.D. -:Trustee	06/07/19	RE 322 404 075 US	:Beverly-Jean: Romero- Hill, -:notice-of-claim: - :Verification of the Known-Birth/Berth-Statuses; :Verification of the Civilian-Status
2	:man	:U.S.-Corp.- :Government of the United-States of 1933-, 2003 A.D.- self-Indenture: EBA-1933-A.D. ~:GofUS-1933-A.D. :GofUS-:2003-A.D. :GofUS-1933-A.D.. -:2003-A.D. -:Trustee	06/07/19	RE 322 404 067 US	:Darrell-James: Hill, -:notice-of-claim: - :Verification of the Known-Birth/Berth-Statuses; :Verification of the Civilian-Status
3	:man; :Dominic: Stewart; :Berenisse: Romero	:Wells-Fargo, Bank, N.A.; personal-banker; bank-manager.	06/11/19	Claim: Unlawful-denial of Signature-Guarantee for: Execmpted-Security: June 2019	:Securities Act of 1933 - appended.
4	:man	:U.S.- Corp.- :GofUS-:2003-A.D. :GofUS-1933-A.D.,	06/14/19	:2019-1158-001 - RE 322 404 067 US	:Demand-Equity-Promissory-Note ~DEN~: Darrell-James: Hill -Ohioan-beneficiary: DOI-1776-A.D., et seq., -:beneficiary-Executor: EBA-1933-A.D. -

56

57

		:2003-A.D. -:Trustee, to -:Bank-of-the-West: BNP-Paribas			48 Stat. L.1, and 40 Stat. L. 411, and 48 Stat. L. 881, and 61 Stat., Chap. 388; RE 322 404 067 US .	
5	:man	:GofUS-2003-A.D., -:Trustee, to -:Bank-of-the-West: BNP- Paribas	06/14/19	:2019-0658-001 - RE 322 404 075 US	:Demand-Equity-Promissory-Note: Beverly-Jean: Romero- Hill- New-Mexican: DOI-1776-A.D., et seq., -:beneficiary-Executor: EBA-1933-A.D. - 48 Stat. L.1, and 40 Stat. L. 411, and 48 Stat. L. 881, and 61 Stat., Chap. 388; RE 322 404 067 US .	
6	:man	:U.S.-Corp.- :GofUS-1933, -:2003-A.D. -:Trustee, to -:Federal-Reserve-Act of 12/13/1913 ~FRA-1213-A.D.- -:Federal-Reserve-Bank, -:Trustee	06/14/19	38 Stat. 251, Pub. Law 63-43	:U.S.-Corp.- :GofUS-1933-A.D., -:2003-A.D., -:FRA-1913-A.D.	
7	:man	:U.S.-Corp.- :GofUS-1933, -:2003-A.D. -:Trustee, to -:Title 1-General provisions of 1947	06/14/19	61 Stat., Chap. 388 ~ 61. Stat. 633.	:General- Provisions- 1947, appended, p. 633- 664.	
8						
		:man- trustee	:association	:year, :day	USPO, other	:covenant
9	:man	:GofUS-1933-A.D., -:2003-A.D. -:Trustee to: Securites Act of 1933 ~SA-1933-A.D.~ et seq.-: :Security Exchange Act of 1934	06/14/19	48 Stat. 74, Pub Law 73- 22, -:SA-1933-A.D.	:Securities Act of 1933 ~ appended. 48 Stat. 881, Pub. Law 73-291 ~SEA-1934-A.D.~	



~SEA-1934-A.D.~

10 :William-P.: Barr, U.S. -:AG -APC -CLT 06/27/19 RE 322 404 084 US

:Alien-Property-Custodian ~APC~ Notices: Agreement: Civillian-Status, for -:Darrell-James: Hill and Beverly-Jean: Romero- Hill. -:appendices: Beverly-Jean: Romero- Hill- New-Mexican-beneficiary-Executor: DOI-1776-A.D., -:beneficiary-Executor: EBA-1933-A.D.-verified, -:Civillian; and, :Darrell-James: Hill- Ohioan-beneficiary-Executor: DOI-1776-A.D., -:beneficiary-Executor: EBA-1933-A.D.-verified, -:Civillian.

11 :Donald: Trump cc: POTUS 06/27/19 RE 322 404 098 US

↓
:Alien-Property-Custodian ~APC~ Notices: Agreement: Civillian-Status, for -:Darrell-James: Hill and Beverly-Jean: Romero- Hill. -:appendices: Beverly-Jean: Romero- Hill- New-Mexican-beneficiary-Executor: DOI-1776-A.D., -:beneficiary-Executor: EBA-1933-A.D.-verified, -:Civillian; and, :Darrell-James: Hill- Ohioan-beneficiary-Executor: DOI-1776-A.D., -:beneficiary-Executor: EBA-1933-A.D.-verified, -:Civillian.

:man- trustee

:association

:year, :day

USPO, other

:covenant

12 :Mary-C.: Daly Federal-Reserve-Bank: 06/11/19 RE 322 404 067 US
San-Francisco, :President

:Darrell-James: Hill- Ohioan-beneficiary-Executor: DOI-1776-A.D., -:beneficiary-Executor: EBA-1933-A.D.-verified, -:Civillian, -:Claimant: Deprivation-of-Right by the BNP-Paribas-BOTW- Phoenix.

59

:Beverly-Jean: Romero- Hill- New-Mexican-beneficiary-
 Executor: DOI-1776-A.D., -:beneficiary-Executor: EBA-
 1933-A.D.- verified, -:Civillian, -:Claimant: Deprivation-
 of-Right by the BNP-Paribas-BOTW- Phoenix

13 :Nandita: Bakhshi :Bank of the West: 06/12/19 cc: RE 322 404 067 US. -
 President and CEO; Co- 7018 0360 0000 5968 6122
 Chief- Executive-Officer;
 BNP-Paribas: USA, Inc.

↓

14 :Raj: Gopal :Sr.- Exec-V-P and Chief- 06/12/19
 Risk-Officer cc: RE 322 404 067 US. -
 7018 0360 0000 5968 6122

↓

:Darrell-James: Hill- Ohioan-beneficiary-Executor: DOI-
 1776-A.D., -:beneficiary-Executor: EBA-1933-A.D.-
 verified, -:Civillian, -:Claimant: Deprivation-of-Right by
 the BNP-Paribas-BOTW- Phoenix.

:Beverly-Jean: Romero- Hill- New-Mexican-beneficiary-
 Executor: DOI-1776-A.D., -:beneficiary-Executor: EBA-
 1933-A.D.- verified, -:Civillian, -:Claimant: Deprivation-
 of-Right by the BNP-Paribas-BOTW- Phoenix

:man- trustee	:association	:year, :day	USPO, other
15 :Donald: Trump	POTUS	07/25/19	cc: RE 322 404 067 US. - RE 322 404 212 US - :Documents redress the :United States EBA-1933- 2003-A.D. indenture -naked- legislature- Trust.

:covenant

↓

:Darrell-James: Hill- Ohioan-beneficiary-Executor: DOI-
 1776-A.D., -:beneficiary-Executor: EBA-1933-A.D.-
 verified, -:Civillian, -:Claimant: Deprivation-of-Right by
 the BNP-Paribas-BOTW- Phoenix. - :i- man .. require
 that you- trustees... release all-property.

	:man- trustee	:association	:year, :day	USPO, other	:covenant
16	:William-P.: Barr	US – AG, APC, CLT	07/25/19	↓ cc: RE 322 404 067 US. – RE 322 404 107 US – :Documents redress the :United States EBA-1933- 2003-A.D. indenture -naked- legislature- Trust.	↓ :Darrell-James: Hill- Ohioan-beneficiary-Executor: DOI- 1776-A.D., -:beneficiary-Executor: EBA-1933-A.D.- verified, -:Civillian, -:Claimant: Deprivation-of-Right by the BNP-Paribas-BOTW- Phoenix. – :i- man .. require that you- trustees... release all-property.
17	:Mary-C.: Daly	Federal-Reserve-Bank: San-Francisco, -:President	07/25/19	cc: RE 322 404 212 US – 7009 2820 0003 9570 8031	:Beverly-Jean: Romero- Hill- New-Mexican-beneficiary- Executor: DOI-1776-A.D., -:beneficiary-Executor: EBA- 1933-A.D.- verified, -:Civillian, -:Claimant: Deprivation- of-Right by the BNP-Paribas-BOTW- Phoenix – :i- man .. require that you- trustees... release all-property.
18	:Stephen-F.: McCarville	:Pinal-County-Arizona- State, -:Superior-Court, -:Judge	08/01/19	RE 322 404 115 US	:Claim to the Trustees: Donald:Trump, :Obligor : RE 322 404 212 US and William-P.: Barr, US- AG, APC, CLT, :Obligor: RE 322 404 107 US as relates to the DEN to you: Mary-C.: USPO RMN: RE 322 404 067 US - sent to -:YOU: 07/11/19. :Right-of-Consusane. The commercial-court now being imposed upon the man- Jay-Roy: Ingold in my observation is wrong-doing. The :Court-of-Record with

091

17



the trial-by-jury to-hear and try the matter of the fact and in the law is the- :only-righteous-means-to-safeguard the good-faith-duty to the man- Jay-Roy: Ingold, et al., and specifically, :- man- Darrell-James: Hill, et al., ...[] in the accordance with the Ingold-Pinal-2017-A.D. -covenant.

19	:Todd: House	Pinal-County-Arizona- State, -:Board-Supervisor	08/02/19	cc: RE 322 404 115 US RE 322 404 209 US	↓	:Right-of-Conusance. → Ingold-Pinal-2017-A.D. - covenant- agreement
20	:Steve: Miller	Pinal-County-Arizona- State, -:Board-Supervisor	08/02/19	↓	↓	
21	:Pete: Rios	Pinal-County-Arizona- State, -:Board-Supervisor	08/02/19	↓	↓	
22	:Mike: Goodman	Pinal-County-Arizona- State, -:Board-Supervisor	08/02/19	RE 322 404 209 US	↓	:Right-of-Conusance. → Ingold-Pinal-2017-A.D. - covenant- agreement
	:man- trustee	:association	:year, :day	USPO, other		:covenant
23	:Anthony: Smith	Pinal-County-Arizona- State, -:Board-Supervisor	08/02/19	↓	↓	
24	:Natasha: Kennedy	Pinal-County-Arizona- State, -:Board-Clerk	↓	RE 322 404 209 US	↓	:Right-of-Conusance. → Ingold-Pinal-2017-A.D. - covenant- agreement
25	:Kent: Volkmer	Pinal-County-Arizona- State, -:Board-Clerk	↓	↓	↓	



:2019-A.D. Document- History 7 / 8

26	:Kevin-D.: White	:Pinal-County-Arizona- State, -:Superior-Court, -:Judge	08/02/19	RE 322 404 209 US	:Right-of-Conusance. → Ingold-Pinal-2017-A.D. - covenant- agreement
27	:Jason-R.: Holmberg	:Pinal-County-Arizona- State, -:Superior-Court, -:Judge	↓	↓	
28	:Mark-A.: Milley	USofA-1787-A.D.- military, -:General	↓	↓	
	:man- trustee	:association	:year, :day	USPO, other	:covenant
29	:John: Hyten	USofA-1787-A.D.- military, -:General	02/28/18	↓ RE 322 404 209 US	:Right-of-Conusance. → Ingold-Pinal-2017-A.D. - covenant- agreement
30	:David-H.: Berger	USofA-1787-A.D.- military, -:General	↓	↓	
31	:Joseph-M.: Martin	USofA-1787-A.D.- military, -:Lt. -General	↓	↓	
32	:David-L.: Goldfein	USofA-1787-A.D.- military, -:general	↓ 08/28	↓ RE 322 404 209 US	:Right-of-Conusance. → Ingold-Pinal-2017-A.D. - covenant- agreement
	:man- trustee	:association	:year, :day	USPO, other	:covenant
33					

29

63



:2019-A.D. Document- History 8 / 8

34	:Sadie-Jo: Bingham	Gila-County-Arizona-State-Recorder	10/29/19	Gila-County-Recorder-Doc.#: 2019-009291	:Affidavit: Proof-of-Claims – August- 2019; related to: Gila-County-Recorder-Doc.##: 2017-002378; 2017-006522; 2018-005176
34	:Mark: Lamb	:Pinal-County-Arizona-State, -:Sheriff	08/30/19	7008 1300 0002 2256 4712 with -:RE 322 404 169 US	:Statement-of-Claim -: RE 322 404 169 US -:Ingold-Pinal-2017-A.D.-Covenant- Debt-Notice: Render of -:Bill, -:demand for the payment.
35	:Sadie-Jo: Bingham	Gila-County-Arizona-State-Recorder	10/29/19	Gila-County-Recorder-Doc.#: 2019-011722	:Affidavit: Proof-of-Claims – August- 2019; related to: Gila-County-Recorder-Doc.##: 2017-002378; 2017-006522; 2018-005176

:2020 A.D.					
#	:man- trustee	:association	:year, :day	USPO, other	:covenant
1	:Donald-John: Trump	:POTUS	05/18/20	~RE 047 610 440 US~ → RE 322 387 559 US ↓	:Equity-Claim: Presentment: Express-Trust: EBA-1933-A.D. - naked-Trust - RE 047 610 440 US -:May 15 th , 2020 A.D. for the account, settle and closure.
2	:Steve-Turner:Mnuchin c/o :Donald: Trump	U.S.- Department fo the Treaury- Secretary	↓ 05/18/20	~RE 047 610 440 US~ → RE 322 387 559 US ↓	↓
3	:William-Pelham: Barr c/o :Donald: Trump	U.S.- AG, APC, CLT	↓ 05/18/20	~RE 047 610 440 US~ → RE 322 387 559 US ↓	:Equity-Claim: Presentment: Express-Trust: EBA-1933-A.D. - naked-Trust - RE 047 610 440 US -:May 15 th , 2020 A.D. for the account, settle and closure.
4	:Jefferson: B.: Sessions III c/o :Donald: Trump	U.S.- AG, APC, CLT, ex- officio	↓ 05/18/20	~RE 047 610 440 US~ → RE 322 387 559 US ↓	↓
5	:Matthew-G.: Whitaker c/o :Donald: Trump	U.S.- AG, APC, CLT, ex- officio -acting	↓ 05/18/20	~RE 047 610 440 US~ → RE 322 387 559 US ↓	:Equity-Claim: Presentment: Express-Trust: EBA-1933-A.D. - naked-Trust - RE 047 610 440 US -:May 15 th , 2020 A.D. for the account, settle and closure.
	:man- trustee	:association	:year, :day	USPO, other	:covenant
6	:Dana: James- Boente c/o :Donald: Trump	U.S.- AG, APC, CLT, ex- officio -acting	↓ 05/18/20	~RE 047 610 440 US~ → RE 322 387 559 US ↓	↓
7	:Sally-C.: Yates c/o :Donald: Trump	U.S.- AG, APC, CLT, ex-	↓ 05/18/20	~RE 047 610 440 US~ → RE 322 387 559 US ↓	:Equity-Claim: Presentment: Express-Trust: EBA-1933-

JK

45

					A.D. - naked-Trust - RE 047 610 440 US -:May 15 th , 2020 A.D. for the account, settle and closure.
8	:Steve-Turner:Mnuchin	U.S.- Department fo the Treasury- Secretary	05/19/20	7008 1300 0002 2256 4705	
9	:William-Pelham: Barr c/o :Donald: Trump	U.S.- AG, APC, CLT	↓ 05/19/20	RE 047 610 438 US	:Equity-Claim: Presentment: Express-Trust: EBA-1933-A.D. - naked-Trust - RE 047 610 440 US -:May 15 th , 2020 A.D. for the account, settle and closure.
10	:man- trustee	:association	:year, :day	USPO, other	:covenant
11	:Joshep: Dedman, Jr. c/o :Mark: Lamb, -:Sheriff, -:Pinal	:Apache-County- Arizona-State, -:Sheriff	05/20/20	RE 322 387 545 US cc: First Class Mail	Re: USPO RMN ~RE 047 610 440 US~ → RE 322 387 559 US; See: Equity-Claim: Presentment: Express-Trust: EBA-1933-A.D. - naked-Trust - RE 047 610 440 US -:May 15 th , 2020 A.D. for the account, settle and closure.
12	:Mark: Dannels c/o :Mark: Lamb, -:Sheriff, -:Pinal	:Cochise-County- Arizona-State, -:Sheriff	05/20/20	RE 322 387 545 US cc: First Class Mail	
13	:Jim: Driscol c/o :Mark: Lamb, -:Sheriff, -:Pinal	:Coconino-County- Arizona-State, -:Sheriff	05/20/20	RE 322 387 545 US cc: First Class Mail	Re: USPO RMN ~RE 047 610 440 US~ → RE 322 387 559 US; See: Equity-Claim: Presentment: Express-Trust: EBA-1933-A.D. - naked-Trust - RE 047 610 440 US -:May 15 th , 2020 A.D. for the account, settle and closure.



:2020-A.D. Document- History

3 / 25

	:man- trustee	:association	:year, :day	USPO, other	:covenant
14	:Adam: Shephard c/o :Mark: Lamb, -:Sheriff, -:Pinal	:Gila-County-Arizona- State, -:Sheriff	05/20/20	RE 322 387 545 US cc: First Class Mail	↓
15	:Preston: Allread c/o :Mark: Lamb, -:Sheriff, -:Pinal	:Graham-County- Arizona-State, -:Sheriff	05/20/20	RE 322 387 545 US cc: First Class Mail	↓
16	:Tim: Sumner c/o :Mark: Lamb, -:Sheriff, -:Pinal	:Greenlee-County- Arizona-State, -:Sheriff	05/20/20	RE 322 387 545 US cc: First Class Mail	↓ Re: USPO RMN ~RE 047 610 440 US~ → RE 322 387 559 US; See: Equity-Claim: Presentment: Express- Trust: EBA-1933-A.D. - naked-Trust - RE 047 610 440 US -:May 15 th , 2020 A.D. for the account, settle and closure.
17	:Bill: Risen c/o :Mark: Lamb, -:Sheriff, -:Pinal	:La- Paz -County- Arizona-State, -:Sheriff	05/20/20	RE 322 387 545 US cc: First Class Mail	↓
18	:Paul: Penzone c/o :Mark: Lamb, -:Sheriff, -:Pinal	:Maricopa-County- Arizona-State, -:Sheriff	05/20/20	RE 322 387 545 US cc: First Class Mail	↓
19	:Doug: Schuster c/o :Mark: Lamb, -:Sheriff, -:Pinal	:Mohave-County- Arizona-State, -:Sheriff	05/20/20	RE 322 387 545 US cc: First Class Mail	↓ Re: USPO RMN ~RE 047 610 440 US~ → RE 322 387 559 US; See: Equity-Claim: Presentment: Express- Trust: EBA-1933-A.D. - naked-Trust - RE 047 610 440 US -:May 15 th , 2020 A.D. for the account, settle and closure.

100

67



:2020-A.D. Document- History 4 / 25

	:man- trustee	:association	:year, :day	USPO, other
20	:David: Clouse c/o :Mark: Lamb, -:Sheriff, -:Pinal	:Navajo-County-Arizona- State, -:Sheriff	05/20/20	RE 322 387 545 US cc: First Class Mail
21	:Mark: Napier c/o :Mark: Lamb, -:Sheriff, -:Pinal	:Pima-County-Arizona- State, -:Sheriff	05/20/20	RE 322 387 545 US cc: First Class Mail
22	:Tony: Estrada c/o :Mark: Lamb, -:Sheriff, -:Pinal	:Santa-Criz-County- Arizona-State, -:Sheriff	05/20/20	RE 322 387 545 US cc: First Class Mail
23	:Scott: Mascher c/o :Mark: Lamb, -:Sheriff, -:Pinal	Yavapai-County-Arizona- State, -:Sheriff	05/20/20	RE 322 387 545 US cc: First Class Mail

:covenant

↓

↓

↓

↓

	:man- trustee	:association	:year, :day	USPO, other
24	Leon: Wilmot c/o :Mark: Lamb, -:Sheriff, -:Pinal	:Yuma-County-Arizona- State, -:Sheriff	05/20/20	RE 322 387 545 US cc: First Class Mail
25	:Mark: Lamb	:Pinal-County-Arizona- State, -:Sheriff	05/20/20	RE 322 387 545 US

:covenant

↓

Re: USPO RMN ~RE 047 610 440 US~ → RE 322 387 559 US; See: Equity-Claim: Presentment: Express-Trust: EBA-1933-A.D. - naked-Trust - RE 047 610 440 US -:May 15th, 2020 A.D. for the account, settle and closure.

Re: USPO RMN ~RE 047 610 440 US~ → RE 322 387 559 US; See: Equity-Claim: Presentment: Express-

Trust: EBA-1933-A.D. - naked-Trust - RE 047 610 440 US -:May 15th, 2020 A.D. for the account, settle and closure.

26 :Ryan-N.: Dooley :La Paz-County-Arizona- State, -:Attorney- Chief- Deputy 06/01/20 Standard Mail. :Darrell-James: Hill -Ohioan -beneficiary, -:Executor: DOI-1776-A.D; :beneficiary- Executor: EBA-1933-A.D.

'I -Ryan am- returning the -RE 322 387 545 US c/o :Mark: Lamb, -:Sheriff, -:Pinal-County-Arizona- State, -:Sheriff and cc: First-Class-Mail -documents- received to the man: :Bill: Risen, -:La- Paz-County- Arizona-State- Sheriff. - Enc. Fictitious documents.'

27	:man- trustee	:association	:year, :day	USPO, other	:covenant
28	:John-Earl: Hyten c/o :Alexander: Milley	United-States-of- America-1787-A.D. ~USofA~ -military- General	↓ 06/09/20	~RE 047 610 440 US~ → RE 322 387 559 US cc: RE 047 610 512 US	↓ :Equity-Claim: Presentment: Express-Trust: EBA-1933- A.D. - naked-Trust - RE 047 610 440 US -:May 15 th , 2020 A.D. for the account, settle and closure.
29	:James-Charles: McConville c/o :Alexander: Milley	USofA- military- General	↓ 06/09/20	~RE 047 610 440 US~ → RE 322 387 559 US cc: RE 047 610 512 US	↓
30	:David-Hilberry: Berger c/o :Alexander: Milley	USofA- military- General	↓ 06/09/20	~RE 047 610 440 US~ → RE 322 387 559 US cc: RE 047 610 512 US	↓
31	:Michael-Martin-Gilday c/o :Alexander: Milley	USofA- military- Admiral	↓ 06/09/20	~RE 047 610 440 US~ → RE 322 387 559 US cc: RE 047 610 512 US	↓ :Equity-Claim: Presentment: Express-Trust: EBA-1933- A.D. - naked-Trust - RE 047 610 440 US -:May 15 th ,

Handwritten initials or mark.

BA



2020 A.D. for the account, settle and closure.

32 :David-Lee: Goldfein USofA- military- General ↓ ~RE 047 610 440 US~ →
 c/o :Alexander: Milley 06/09/20 RE 322 387 559 US
 cc: RE 047 610 512 US

33 :John-William: Raymond USofA- military- General ↓ ~RE 047 610 440 US~ →
 c/o :Alexander: Milley 06/09/20 RE 322 387 559 US
 cc: RE 047 610 512 US

:Equity-Claim: Presentment: Express-Trust: EBA-1933-A.D. - naked-Trust - RE 047 610 440 US -:May 15th, 2020 A.D. for the account, settle and closure.

:man- trustee

:association

:year, :day

USPO, other

:covenant

34 :Joseph-Lauren: Lengyel USofA- military- General ↓ ~RE 047 610 440 US~ →
 c/o :Alexander: Milley 06/09/20 RE 322 387 559 US
 cc: RE 047 610 512 US

35 :Karl-Leo: Schultz USofA- military- Admiral ↓ ~RE 047 610 440 US~ →
 c/o :Alexander: Milley 06/09/20 RE 322 387 559 US
 cc: RE 047 610 512 US

36 :Mark-Alexander: Milley USofA- military- General 06/09/20 ~RE 047 610 440 US~ →
 RE 322 387 559 US
 cc: RE 047 610 512 US

:Equity-Claim: Presentment: Express-Trust: EBA-1933-A.D. - naked-Trust - RE 047 610 440 US -:May 15th, 2020 A.D. for the account, settle and closure.

37 :Ryan-N.: Dooley :La-Paz- County- 06/15/20 7012 2210 0000 4269 7391
 c/o: Tony: Rogers Arizona-State, -:Attorney
 -Chief-Deputy;
 c/o: La-Paz- County-
 Arizona-State, -:Attorney

Darrell-James: Hill -Ohioan -beneficiary, -:Executor: DOI-1776-A.D; :beneficiary- Executor: EBA-1933-A.D.

constitutional-office-oath



	:man- trustee	:association	:year, :day	USPO, other	:covenant
					; constitutional-offices.
38	:Michael: Whiting	:Apache- County- Arizona-State, -:Attorney	↓	7012 2210 0000 4269 7391 cc: First-Class-Mail	↓
39	:William-P.: Ring	:Coconino- County- Arizona-State, -:Attorney	06/15/20	7012 2210 0000 4269 7391 cc: First-Class-Mail	Darrell-James: Hill -Ohioan -beneficiary, -:Executor: DOI-1776-A.D; :beneficiary- Executor: EBA-1933-A.D. constitutional-office-oath
40	:Sheila: Polk	:Yavapai- County- Arizona-State, -:Attorney	↓	7012 2210 0000 4269 7391 cc: First-Class-Mail	↓
41	:Jeremy: Ford	:Greenlee- County- Arizona-State, -:Attorney	↓	7012 2210 0000 4269 7391 cc: First-Class-Mail	↓
42	:Allister: Adel	:Maricopa- County- Arizona-State, -:Attorney	↓	7012 2210 0000 4269 7391 cc: First-Class-Mail	↓
43	:Barbara: LaWall	:Pima- County-Arizona- State, -:Attorney	06/15/20	7012 2210 0000 4269 7391 cc: First-Class-Mail	Darrell-James: Hill -Ohioan -beneficiary, -:Executor: DOI-1776-A.D; :beneficiary- Executor: EBA-1933-A.D. constitutional-office-oath
44	:Brad: Carlyon	:Navajo- County- Arizona-State, -:Attorney	↓	7012 2210 0000 4269 7391 cc: First-Class-Mail	↓
45	:Bradley-D.: Beauchamp	:Gila- County-Arizona- State, -:Attorney	↓	7012 2210 0000 4269 7391 cc: First-Class-Mail	↓
46	:George: Silva	:Santa-Cruz- County-	06/15/20	7012 2210 0000 4269 7391	↓

np

11



:2020-A.D. Document- History 8 / 25

	:man- trustee	:association	:year, :day	USPO, other	:covenant
47	:Brian: McIntyre	:Cochise- County- Arizona- State, -:Attorney	↓	7012 2210 0000 4269 7391 cc: First-Class-Mail	↓
48	:Kent: Volkmer	:Pinal- County- Arizona- State, -:Attorney	↓	7012 2210 0000 4269 7391 cc: First-Class-Mail	↓
49	:Matthew-J.: Smith	:Mohave- County- Arizona- State, -:Attorney	↓	7012 2210 0000 4269 7391 cc: First-Class-Mail	Darrell-James: Hill -Ohioan -beneficiary, -:Executor: DOI-1776-A.D; :beneficiary- Executor: EBA-1933-A.D. constitutional-office-oath
50	:Kenny: Angle	:Graham- County- Arizona- State, -:Attorney	06/15/20	7012 2210 0000 4269 7391 cc: First-Class-Mail	↓
51	:Jon-R.: Smith	:Yuma- County- Arizona- State, -:Attorney	06/15/20	7012 2210 0000 4269 7391 cc: First-Class-Mail	↓
52	:Mark: Brnovich	:Arizona- State- Attorney- General	↓ 06/15/20	7012 2210 0000 4269 7391 cc: 7009 2820 0003 8851 6032	Darrell-James: Hill -Ohioan -beneficiary, -:Executor: DOI-1776-A.D; :beneficiary- Executor: EBA-1933-A.D. constitutional-office-oath
53	:Ryan-N.: Dooley c/o: Tony: Rogers	:La-Paz- County- Arizona- State, -:Attorney -Chief-Deputy	06/17/20	Standard Mail.	Darrell-James: Hill -Ohioan -beneficiary, -:Executor: DOI-1776-A.D; :beneficiary- Executor: EBA-1933-A.D. - constitutional-office-oath -

09/26/2022 03:35:37 PM Receipt #: 22-9381
Rec Fee: \$30.00 Darrell James Hill
Gila County, Az, Sadie Jo Bingham, Recorder



'1 -Ryan am- returning the -:7012 2210 0000 4269
7391 -documents that you-beneficiary-mailed to my
office (again)'

54	:Doug: Ducey c/o :Katie: Hobbs	:Arizona-State-Governor	06/23/20	RE 047 610 526 US
55	:Katie: Hobbs	:Arizona-State-Secretary	06/23/20	RE 047 610 526 US
56	:John: Halikowski c/o: Scott: Omer	:Arizona-State- Department of Transportation, -:Director	06/23/20	7009 1410 0000 7868 5796
57	:Time: Lane c/o: Scott: Omer	:Arizona-State- Enforcement and Compliance-Division, -:Director	06/23/20	7009 1410 0000 7868 5796

Darrell-James: Hill -Ohioan -beneficiary, -:Executor:
DOI-1776-A.D; :beneficiary- Executor: EBA-1933-A.D.

constitutional-office-oath
:Specialized-Negotiable-Instrument- RE 047 610 526
US for the restoration of the automobile- MSO-
equivalent to the man: Darrell-James: Hill and Beverly-
Jean: Romero- Hill, -:exclusive-peculiar-absolute-
owners of the automobiles, -:verified- title#s:
1) # K015013311014 / VIN- 22D42408S6936 ;
2) # K015013311011 / VIN- 1FTHX26H6FKB58041 ;
3) # K015013311008 / VIN- 1G8EK16L1GF207716 ;
4) # 17AK011018008 / VIN- 1GBKP37W3H3313848 .

↓
↓
↓

22

62

2022-011769 MISC Page: 73 of 2782
 09/26/2022 03:35:37 PM Receipt #: 22-9381
 Rec Fee: \$30.00 Darrell James Hill
 Gila County, Az, Sadie Jo Bingham, Recorder

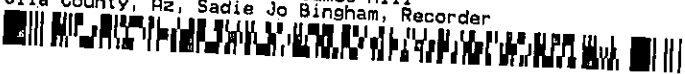

:2020-A.D. Document- History 10 / 25

58 :Scott: Omer :Arizona-State-
 Department of
 Transportation, -:COO 06/23/20 7009 1410 0000 7868 5796

Darrell-James: Hill -Ohioan -beneficiary, -:Executor:
 DOI-1776-A.D.; :beneficiary- Executor: EBA-1933-A.D.

constitutional-office-oath
 :Specialized-Negotiable-Instrument- RE 047 610 526
 US for the restoration of the automobile- MSO-
 equivalent to the man: Darrell-James: Hill and Beverly-
 Jean: Romero- Hill, -:exclusive-peculiar-absolute-
 owners of the automobiles, -:verified- title#s:
 1) # K015013311014 / VIN- 22D42408S6936 ;
 2) # K015013311011 / VIN- 1FTHX26H6FKB58041 ;
 3) # K015013311008 / VIN- 1G8EK16L1GF207716 ;
 4) # 17AK011018008 / VIN- 1GBKP37W3H3313848 .

	:man- trustee	:association	:year, :day	USPO, other	:covenant
59	:Jorge-Mario: Bergoglio	:Trustee: Concession- 1213-A.D.	07/24/20	RE 322 387 576 US	:Darrell-James: Hill, -:Ohioan- beneficiary- Executor: DOI-1776-A.D., -Treaty-of-Paris-1783-A.D., -: Concession-1213-A.D.
60	:Donald-Trump	POTUS	07/24/20	~RE 322 387 562 US~ → → RE 322 398 401 US	:Darrell-James: Hill, -:Ohioan- beneficiary- Executor: DOI-1776-A.D., -Treaty-of-Paris-1783-A.D., -: Concession-1213-A.D. :Special-Presentment, ~ Book; ;A) i- man- :ambassador- of the Almighty-God give you ;notice... ;

B. :Introduction. :i- man -Ysrael-Yudah- Ohioan-
 beneficiary- Executor: DOI-1776-A.D.; -:Ambassador
 of the Almighty- God, -:Trustee: Concession-1213-
 A.D.; -: beneficiary-Executor: EBA-1933-A.D.
 B#1) Affidavit of Distress;
 B#2) Declaration of :Claim and Demand for the
 Restoration of the property-claimed and possessed
 by :i- man

61	:Mark-Alexander: Milley c/o :James-Charles: McConville	USofA- military- General	09/21/20	RE 322 357 580 US	:Regarding: Stolen—Property- claimed and possessed ..., stolen by the POTUS, et al., aided and abetted by :you, et al. Attached is the 'Special-Presentment ~Book 9' -> ~RE 322 387 562 US~ → RE 322 398 401 US
62	:John-Earl: Hyten c/o :James-Charles: McConville	United-States-of- America-1787-A.D. ~USofA~ -military- General	↓ 09/21/20	↓ RE 322 357 580 US	↓ :Regarding: Stolen—Property- claimed and possessed ..., stolen by the POTUS, et al., aided and abetted by :you, et al. Attached is the 'Special-Presentment ~Book 9' -> ~RE 322 387 562 US~ → RE 322 398 401 US
63	:David-Hilberry: Berger c/o :James-Charles: McConville	USofA- military- General	↓	↓	↓
64	:Michael-Martin-Gilday c/o :James-Charles:	USofA- military- Admiral	↓ 09/21/20	↓ RE 322 357 580 US	↓ :Regarding: Stolen—Property- claimed and possessed

nlv

15



McConville

..., stolen by the POTUS, et al., aided and abetted by :you, et al.

Attached is the 'Special-Presentment ~Book 9' -> ~RE 322 387 562 US~ -> RE 322 398 401 US

65	:man- trustee	:association	:year, :day	USPO, other	:covenant
66	:David-Lee: Goldfein c/o :James-Charles: McConville	USofA- military- General	↓	↓	↓
67	:John-William: Raymond c/o :James-Charles: McConville	USofA- military- General	↓ 09/21/20	↓ RE 322 357 580 US	↓
68	:Joseph-Lauren: Lengyel c/o :James-Charles: McConville	USofA- military- General	↓	↓	↓
69	:Karl-Leo: Schultz c/o :James-Charles: McConville	USofA- military- Admiral	↓	↓	↓
70	:James-Charles: McConville	USofA- military- Admiral	↓ 09/21/20	↓ RE 322 357 580 US	↓

:Regarding: Stolen—Property- claimed and possessed ..., stolen by the POTUS, et al., aided and abetted by :you, et al.

Attached is the 'Special-Presentment ~Book 9' -> ~RE 322 387 562 US~ -> RE 322 398 401 US

:Regarding: Stolen—Property- claimed and possessed ..., stolen by the POTUS, et al., aided and abetted by :you, et al.

Attached is the 'Special-Presentment -Book 9' ->
 -RE 322 387 562 US- → RE 322 398 401 US

	:man- trustee	:association	:year, :day	USPO, other	:covenant
71	:David: Richards c/o :Anthony: Harking	:Crown, :in- chancery, -:Lincoln's -Inn	10/14/20	First Class Mail	:Concession-1213-A.D., -:Treaty-of-Paris-1783-A.D. → DOI-1776-A.D. :Specialty-Presentment: USPO-RMN: RE 322 387 593 US – Re: a) man-Trustee-Derelict: Concession-1213- A.D.- :Jorge: Mario: RE 322 387 576 US; b) Almihty- God, change of Trustee: Concession-1213-A.D. to the :i- man- named; c) :Restoration
72	:Brian: Leveson c/o :Anthony: Harking	:Crown, :in- chancery, -:Middle- Temple	↓ 10/14/20	↓	↓
73	:Guy: Fetherstonhaugh c/o :Anthony: Harking	:Crown, :in- chancery, -:Inner -Temple	↓	↓ First Class Mail	↓
74	:Anthony: Harking	:Crown, :in- chancery, -:Gray's -Inn	↓ 10/14/20	↓ RE 322 387 593 US	↓ :Concession-1213-A.D., -:Treaty-of-Paris-1783-A.D. → DOI-1776-A.D.
75	:Donald-John: Trump	:POTUS	↓	↓ First Class Mail	↓
76	:Michael-R.: Pompeo c/o: Lisa-D: Kenna	:U.S.-State, -:Secretary c/o: :U.S.-State, -:Secretary, -:Exec.- Sec.	↓ 10/14/20	↓ RE 322 398 392 US	↓ :Concession-1213-A.D., -:Treaty-of-Paris-1783-A.D. → DOI-1776-A.D. :Specialty-Presentment: USPO-RMN: RE 322 387 593

nl

11

US – Re: a) man-Trustee-Derelict: Concession-1213-A.D.- :Jorge: Mario: RE 322 387 576 US; b) Almihty-God, change of Trustee: Concession-1213-A.D. to the :- man- named; c) :Restoration

	:man- trustee	:association	:year, :day	USPO, other	:covenant
77	:Donald-John: Trump	:POTUS	11/10/20	RE 322 387 547 US	:Bill-of-Particulars: Lot-1: updated to 12/13/21, :Bill-of-Particulars: Lot-2: updated to 12/13/21; :Bill-of-Particulars: Lot-3: updated to 12/13/21; for the remedy with the exclusive-right-due to the harm with the law of the covenants by the law of the covenants: DOI-1776-A.D., PE-2016-A.D., -covenants: Lot 1, 2, 3.
78	:Mark-Alexander: Milley c/o :James-Charles: McConville	USofA- military- General	↓	RE 322 387 633 US	↓
79	:John-Earl: Hyten c/o :James-Charles: McConville	United-States-of- America-1787-A.D. ~USofA~ -military- General	↓ 11/10/20	↓ RE 322 387 633 US	↓ :Bill-of-Particulars: Lot-1: updated to 12/13/21, :Bill-of-Particulars: Lot-2: updated to 12/13/21; :Bill-of-Particulars: Lot-3: updated to 12/13/21; for the remedy with the exclusive-right-due to the harm with the law of the covenants by the law of the covenants: DOI-1776-A.D., PE-2016-A.D., -covenants: Lot 1, 2, 3.
80	:David-Hilberry: Berger c/o :James-Charles: McConville	USofA- military- General	↓	↓	↓

:2020-A.D. Document- History

15 / 25

	:man- trustee	:association	:year, :day	USPO, other	:covenant
81	:Michael-Martin-Gilday c/o :James-Charles: McConville	USofA- military- Admiral			
82	:David-Lee: Goldfein c/o :James-Charles: McConville	USofA- military- General	11/10/20	RE 322 387 633 US	:Bill-of-Particulars: Lot-1: updated to 12/13/21, :Bill-of-Particulars: Lot-2: updated to 12/13/21; :Bill-of-Particulars: Lot-3: updated to 12/13/21; for the remedy with the exclusive-right-due to the harm with the law of the covenants by the law of the covenants: DOI-1776-A.D., PE-2016-A.D., -covenants: Lot 1, 2, 3.
83	:John-William: Raymond c/o :James-Charles: McConville	USofA- military- General			
84	:Joseph-Lauren: Lengyel c/o :James-Charles: McConville	USofA- military- General	11/10/20	RE 322 387 633 US	
85	:Karl-Leo: Schultz c/o :James-Charles: McConville	USofA- military- Admiral			
86	:James-Charles: McConville	USofA- military- Admiral	11/10/20	RE 322 387 633 US	:Bill-of-Particulars: Lot-1: updated to 12/13/21, :Bill-of-Particulars: Lot-2: updated to 12/13/21; :Bill-of-Particulars: Lot-3: updated to 12/13/21; for the remedy with the exclusive-right-due to the harm with the law of

86

79

the covenants by the law of the covenants: DOI-1776-A.D., PE-2016-A.D., -covenants: Lot 1, 2, 3.

	:man- trustee	:association	:year, :day	USPO, other	:covenant
87	:Joshep: Dedman, Jr. c/o :Mark: Lamb, -:Sheriff, -:Pinal	:Apache-County- Arizona-State, -:Sheriff	↓ 11/10/20	↓ First Class Mail.	↓ :Bill-of-Particulars: Lot-1: updated to 12/13/21, :Bill-of-Particulars: Lot-2: updated to 12/13/21; :Bill-of-Particulars: Lot-3: updated to 12/13/21; for the remedy with the exclusive-right-due to the harm with the law of the covenants by the law of the covenants: DOI-1776-A.D., PE-2016-A.D., -covenants: Lot 1, 2, 3.
88	:Mark: Dannels c/o :Mark: Lamb, -:Sheriff, -:Pinal	:Cochise-County- Arizona-State, -:Sheriff	↓ 11/10/20	↓ First Class Mail.	↓ :Bill-of-Particulars: Lot-1: updated to 12/13/21, :Bill-of-Particulars: Lot-2: updated to 12/13/21; :Bill-of-Particulars: Lot-3: updated to 12/13/21; for the remedy with the exclusive-right-due to the harm with the law of the covenants by the law of the covenants: DOI-1776-A.D., PE-2016-A.D., -covenants: Lot 1, 2, 3.
89	:Jim: Driscoll c/o :Mark: Lamb, -:Sheriff, -:Pinal	:Coconino-County- Arizona-State, -:Sheriff	↓	↓	↓
90	:Adam: Shephard c/o :Mark: Lamb, -:Sheriff, -:Pinal	:Gila-County-Arizona- State, -:Sheriff	↓	↓	↓
91	:Preston: Allread c/o :Mark: Lamb, -:Sheriff,	:Graham-County- Arizona-State, -:Sheriff	↓	↓	↓



:2020-A.D. Document- History

17 / 25

-:Pinal

	:man- trustee	:association	:year, :day	USPO, other	:covenant
92	:Tim: Sumner c/o :Mark: Lamb, -:Sheriff, -:Pinal	:Greenlee-County- Arizona-State, -:Sheriff	↓ 11/10/20	↓ First Class Mail.	↓ :Bill-of-Particulars: Lot-1: updated to 12/13/21, :Bill-of- Particulars: Lot-2: updated to 12/13/21; :Bill-of- Particulars: Lot-3: updated to 12/13/21; for the remedy with the exclusive-right-due to the harm with the law of the covenants by the law of the covenants: DOI-1776- A.D., PE-2016-A.D., -covenants: Lot 1, 2, 3.
	:Bill: Risen c/o :Mark: Lamb, -:Sheriff, -:Pinal	:La- Paz -County- Arizona-State, -:Sheriff	↓	↓	↓
92	:Paul: Penzone c/o :Mark: Lamb, -:Sheriff, -:Pinal	:Maricopa-County- Arizona-State, -:Sheriff	↓	↓	↓
93	:Doug: Schuster c/o :Mark: Lamb, -:Sheriff, -:Pinal	:Mohave-County- Arizona-State, -:Sheriff	↓	↓	↓
94	:David: Clouse c/o :Mark: Lamb, -:Sheriff, -:Pinal	:Navajo-County-Arizona- State, -:Sheriff	↓ 11/10/20	↓ First Class Mail.	↓ :Bill-of-Particulars: Lot-1: updated to 12/13/21, :Bill-of- Particulars: Lot-2: updated to 12/13/21; :Bill-of- Particulars: Lot-3: updated to 12/13/21; for the remedy with the exclusive-right-due to the harm with the law of the covenants by the law of the covenants: DOI-1776- A.D., PE-2016-A.D., -covenants: Lot 1, 2, 3.

:2020-A.D. Document- History 18 / 25

	:man- trustee	:association	:year, :day	USPO, other	:covenant
95	:Mark: Napier c/o :Mark: Lamb, -:Sheriff, -:Pinal	:Pima-County-Arizona- State, -:Sheriff	↓	↓	↓
96	:Tony: Estrada c/o :Mark: Lamb, -:Sheriff, -:Pinal	:Santa-Criz-County- Arizona-State, -:Sheriff	↓	↓	↓
97	:Scott: Mascher c/o :Mark: Lamb, -:Sheriff, -:Pinal	Yavapai-County-Arizona- State, -:Sheriff	↓ 11/10/20	↓ First Class Mail.	↓ :Bill-of-Particulars: Lot-1: updated to 12/13/21, :Bill-of- Particulars: Lot-2: updated to 12/13/21; :Bill-of- Particulars: Lot-3: updated to 12/13/21; for the remedy with the exclusive-right-due to the harm with the law of the covenants by the law of the covenants: DOI-1776- A.D., PE-2016-A.D., -covenants: Lot 1, 2, 3.
98	Leon: Wilmot c/o :Mark: Lamb, -:Sheriff, -:Pinal	:Yuma-County-Arizona- State, -:Sheriff	↓	↓	↓
99	:man c/o :Mark: Lamb, -:Sheriff, -:Pinal	:RTCC	↓	↓	↓
	:man- trustee	:association	:year, :day	USPO, other	:covenant
100	:Mark: Lamb	:Pinal-County-Arizona- State, -:Sheriff	↓ 11/10/20	↓ First Class Mail.	↓ :Bill-of-Particulars: Lot-1: updated to 12/13/21, :Bill-of- Particulars: Lot-2: updated to 12/13/21; :Bill-of-

Particulars: Lot-3: updated to 12/13/21; for the remedy with the exclusive-right-due to the harm with the law of the covenants by the law of the covenants: DOI-1776-A.D., PE-2016-A.D., -covenants: Lot 1, 2, 3.

	:man- trustee	:association	:year, :day	USPO, other	:covenant
101	:Stephen-G.: Breyer, et al., c/o: Scott-Sessions: Harris	:Justices SCOTUS :Clerk SCOTUS	12/11/20	RE 322 387 616 US	:Darrell-James: Hill, -:Ohioan- beneficiary- Executor: DOI-1776-A.D. -:Treaty-of-Paris-1783-A.D., -:Concession-1213-A.D.; beneficiary- Executor: EBA- 1933-A.D.; Ambassador of the Almighty-God, -:Trustee: Concession-1213-A.D. ~ -2020-A.D. :Right of -:Conusance :Authorization for the Restoration of the Lawful- Government
102	:Donald-John: Trump	:POTUS	↓ 12/11/20 ~11/30/20~	RE 322 387 620 US	↓
	:William: Pelham: Barr c/o :Donald: Trump	:US- AG, APC, CLT	↓ 12/11/20 ~11/23/20~	↓ RE 322 387 620 US	↓
	:James-Charles: McConville, et al.	USofA- military- General	↓ 12/11/20 ~11/23/20~	7012 2210 0000 4269 7353	↓

23



:2020-A.D. Document- History 20 / 25

	:man- trustee	:association	:year, :day	USPO, other	:covenant
103	:Stephen-G.: Breyer, et al. c/o: Scott-Sessions: Harris	:Justices SCOTUS, :Clerk	↓ 12/23/20 ~11/30/20~	7012 2210 0000 4269 7360	↓ :Darrell-James: Hill, -:Ohioan- beneficiary- Executor: DOI-1776-A.D. -:Treaty-of-Paris-1783-A.D., -:Concession-1213-A.D.; beneficiary- Executor: EBA- 1933-A.D.; Ambassador of the Almighty-God, -:Trustee: Concession-1213-A.D. ~ -2020-A.D.
					:Right of -:Conusance
					:Authorization for the Restoration of the Lawful- Government
104	:Mark: Lamb, et al. c/o: Mark: Lamb	:Arizona-State-County- Sheriffs	↓ 12/11/20 ~11/23/20~	7012 2210 0000 4269 7377	↓
105	:Ken: Paxton, et al.	:Texas-State, -:AG	↓ 12/11/20	email	↓
106	:John-Bartley: DeLone	Pannsylvania-State, -:AG		email	↓ :Darrell-James: Hill, -:Ohioan- beneficiary- Executor: DOI-1776-A.D. -:Treaty-of-Paris-1783-A.D., -:Concession-1213-A.D.; beneficiary- Executor: EBA- 1933-A.D.; Ambassador of the Almighty-God, -:Trustee: Concession-1213-A.D. ~ -2020-A.D.
					:Right of -:Conusance

	:man- trustee	:association	:year, :day	USPO, other	:covenant
107	:Andrew-Alan: Pinson, et al.	:Georgia-State, -:AG		email	↓
108	:Donald-W.: MacPherson, et al. :Janice: McGeachin, :Lora: Reinbold, :David: Eastment, et al.	:Idaho-State-Elected-Office	↓ 12/11/20	email	↓
109	:John-C.: Eastman, et al., :Donald-J.: Trump	:POTUS	↓ 12/11/20	email	↓
110	:John-Allen: Eldsmoe, et al.	:Consitutional-Attorneys		email	↓ :Darrell-James: Hill, -:Ohioan- beneficiary- Executor: DOI-1776-A.D. -:Treaty-of-Paris-1783-A.D., -:Concession-1213-A.D.; beneficiary- Executor: EBA-1933-A.D.; Ambassador of the Almighty-God, -:Trustee: Concession-1213-A.D. ~ -2020-A.D. :Right of -:Conusance :Authorization for the Restoration of the Lawful-Government
111	:Erick-G.: Kaardal, et al., :Ron: Heuer, et al.	:Ron-Heuer, et al.		email	↓

ts

68

2022-011769 MISC Page: 85 of 2782
 09/26/2022 03:35:37 PM Receipt #: 22-9381
 Rec Fee: \$30.00 Darrell James Hill
 Gila County, Az, Sadie Jo Bingham, Recorder

112	:Jason-Brett: Torchinsky, et al	:Pennsylvania-State, -:Senators		email	
	:man- trustee	:association	:year, :day	USPO, other	:covenant
113	:Dennis: Grossman, et al.	:Christian-Family-Coalition	↓ 12/11/20	email	↓
114	:Phillip-L.: Jauregui Jr., et al.	:U.S.- Representative-members	↓	email	↓
115	:Nathaniel-Kyle: MacPherson, et al., :Janice: McGeachin, :Lora: Reinbold :David: Eastman, et al.	:State-Officers- Elected	↓	email	↓
116	L.-Lin: Wood Jr	:L.-Lin-Wood	↓	email	↓
117	:Thomas-Charles: Bellavia, et al.	:Washington-State -:corporation	↓ 12/11/20	email	↓
118	:Fadwa-A.: Hammoud, et al.	:Michigan-State -:corporation	↓	email	↓

:Darrell-James: Hill, -:Ohioan- beneficiary- Executor: DOI-1776-A.D. -:Treaty-of-Paris-1783-A.D., -:Concession-1213-A.D.; beneficiary- Executor: EBA-1933-A.D.; Ambassador of the Almighty-God, -:Trustee: Concession-1213-A.D. ~ -2020-A.D.

:Right of -:Conusance

:Authorization for the Restoration of the Lawful-Government

:Darrell-James: Hill, -:Ohioan- beneficiary- Executor: DOI-1776-A.D. -:Treaty-of-Paris-1783-A.D.,

-:Concession-1213-A.D.; beneficiary- Executor: EBA-1933-A.D.; Ambassador of the Almighty-God,
 -:Trustee: Concession-1213-A.D. ~ -2020-A.D.

:Right of -:Conusance

:Authorization for the Restoration of the Lawful-Government

119	:Charles-R.: Gerow, et al.	:Pennsylvania-State, -:General-Assembly	↓	email
	:man- trustee	:association	:year, :day	USPO, other
120	:D.-John: Sauer, et al.	:Missouri-State, :corporation A.G.	↓	email
121	:Richard-Douglas: Bernstein, et al., :Carter: Phillips	:Carter-Phillips, et al.	↓	email
122	:Brunn-Wall: Roysden III, :Mark: Brnovich	:Arizona-State, Arizona-State -:AG, -:Mark: Brnovich~	↓ 12/11/20	email

↓
↓
↓
↓

:Darrell-James: Hill, -:Ohioan- beneficiary- Executor: DOI-1776-A.D. -:Treaty-of-Paris-1783-A.D., -:Concession-1213-A.D.; beneficiary- Executor: EBA-1933-A.D.; Ambassador of the Almighty-God,
 -:Trustee: Concession-1213-A.D. ~ -2020-A.D.

:Right of -:Conusance

Handwritten initials

28

:Authorization for the Restoration of the Lawful-Government

123	:Benjamin-Michael: Flowers	:Ohio-State	↓	email	↓
124	:Loren-L.: Alikhan, et al.	:District-of-Columbia, et al.- States and Territories	↓	email	↓
125	:Douglas-Alexander-Stewart: Chalmers Jr. :Bryan-Cutler :Kerry: Benninghoff	Pennsylvania-State- :House-of-Representatives	↓	email	↓
	:man- trustee	:association	:year, :day	USPO, other	:covenant
126	:David-H.: Fink	:City-of-Detroit	↓	email	↓
127	:James-L.: Hirsen	:Justice and Freedom Fund, et al.	↓	email	↓

:Darrell-James: Hill, -:Ohioan- beneficiary- Executor: DOI-1776-A.D. -:Treaty-of-Paris-1783-A.D., -:Concession-1213-A.D.; beneficiary- Executor: EBA-1933-A.D.; Ambassador of the Almighty-God, -:Trustee: Concession-1213-A.D. ~ -2020-A.D.

:Right of -:Conusance

:Authorization for the Restoration of the Lawful-Government



128 :James-A.: Davids, et al. - :Georgia-State-Senator
William: Ligon, et al.

↓
12/11/20

email

↓
:Darrell-James: Hill, -:Ohioan- beneficiary- Executor:
DOI-1776-A.D. -:Treaty-of-Paris-1783-A.D.,
-:Concession-1213-A.D.; beneficiary- Executor: EBA-
1933-A.D.; Ambassador of the Almighty-God,
-:Trustee: Concession-1213-A.D. ~ -2020-A.D.

:Right of -:Conusance

:Authorization for the Restoration of the Lawful-
Government

88



:2021 A.D.

#	:man- trustee	:association	:year, :day	USPO, other	:covenant
1	:Donald-John: Trump, et al. c/o: Darrell-James: Hill	:POTUS, et al. - under :Procuation for the respndent: Darrell-James: Hill, -:man, -:Procurator :Procurator- minister	↓	7008 1830 0002 1028 2082	:Darrell-James: Hill, -:Ohioan- beneficiary- Executor: DOI-1776-A.D. -:Treaty-of-Paris-1783-A.D., -:Concession-1213-A.D.; beneficiary- Executor: EBA-1933-A.D.; Ambassador of the Almighty-God, -:Trustee: Concession-1213-A.D. ~ -2020-A.D. :Authorization for the Restoration of the Lawful- Government
2	:Barack-Hussien: Obama, c/o: :Donald-John: Trump	↓	↓	↓	↓
3	Loretta: Lynch c/o: :Donald-John: Trump	:POTUS, et al. - under :Procuation for the respndent: Darrell-James: Hill, -:man, -:Procurator	↓ 01/15/21	↓ 7008 1830 0002 1028 2082	↓ :Darrell-James: Hill, -:Ohioan- beneficiary- Executor: DOI-1776-A.D. -:Treaty-of-Paris-1783-A.D., -:Concession-1213-A.D.; beneficiary- Executor: EBA-1933-A.D.; Ambassador of the Almighty-God, -:Trustee: Concession-1213-A.D. ~ -2020-A.D. :Authorization for the Restoration of the Lawful- Government
4	:Jefferson-Beauregard:	↓	↓	↓	↓

68

ab

:2021-A.D. Document- History 2 / 28

Sessions III

c/o: :Donald-John:
Trump

	:man- trustee	:association	:year, :day	USPO, other	:covenant
5	:Matthew-George: Whitaker c/o: :Donald-John: Trump	↓	↓	↓	↓
6	:Dana-James: Boente c/o: :Donald-John: Trump	:POTUS, et al. - under :Procuation for the respndent: Darrell-James: Hill, -:man, -:Procurator	↓ 01/15/21	↓ 7008.1830 0002 1028 2082	↓ :Darrell-James: Hill, -:Ohioan- beneficiary- Executor: DOI-1776-A.D. -:Treaty-of-Paris-1783-A.D., -:Concession-1213-A.D.; beneficiary- Executor: EBA-1933-A.D.; Ambassador of the Almighty-God, -:Trustee: Concession-1213-A.D. ~ -2020-A.D. :Authorization for the Restoration of the Lawful- Government
7	:Sally-Caroline: Yates c/o: :Donald-John: Trump	↓	↓	↓	↓
8	:William-Pelham: Barr c/o: :Donald-John: Trump	↓	↓	↓	↓
	:man- trustee	:association	:year, :day	USPO, other	:covenant



:2021-A.D. Document- History

9	:Steve-Turner: Mnuchin c/o: :Donald-John: Trump	:POTUS, et al. - under :Procuation for the respndent: Darrell-James: Hill, -:man, -:Procurator	↓ 01/15/21	↓ 7008 1830 0002 1028 2082	↓ :Darrell-James: Hill, -:Ohioan- beneficiary- Executor: DOI-1776-A.D. -:Treaty-of-Paris-1783-A.D., -:Concession-1213-A.D.; beneficiary- Executor: EBA-1933-A.D.; Ambassador of the Almighty-God, -:Trustee: Concession-1213-A.D. ~ -2020-A.D. :Authorization for the Restoration of the Lawful- Government
10	:Brian: Karth c/o: :Donald-John: Trump	↓	↓	↓	↓
11	:Ranier-Christercunean: Collins c/o: :Donald-John: Trump	↓	12/30/99	↓	↓
12	:John and Jane- Does c/o: :Donald-John: Trump	:POTUS, et al. - under :Procuation for the respndent: Darrell-James: Hill, -:man, -:Procurator	↓ 01/15/21	↓ 7008 1830 0002 1028 2082	↓ :Darrell-James: Hill, -:Ohioan- beneficiary- Executor: DOI-1776-A.D. -:Treaty-of-Paris-1783-A.D., -:Concession-1213-A.D.; beneficiary- Executor: EBA-1933-A.D.; Ambassador of the Almighty-God, -:Trustee: Concession-1213-A.D. ~ -2020-A.D. :Authorization for the Restoration of the Lawful- Government
	:man- trustee	:association	:year, :day	USPO, other	:covenant

11



92

:2021-A.D. Document- History

4 / 28

13	:James-Charles: McConville	United-States-of- America-1787-A.D. ~USofA~ -military- General	↓ 01/15/21	7009 2820 0003 8851 6100
----	-------------------------------	---	---------------	--------------------------

↓
:Darrell-James: Hill, -:Ohioan- beneficiary- Executor:
DOI-1776-A.D. -:Treaty-of-Paris-1783-A.D.,
-:Concession-1213-A.D.; beneficiary- Executor:
EBA-1933-A.D.; Ambassador of the Almighty-God,
-:Trustee: Concession-1213-A.D. ~ -2020-A.D.

:Authorization for the Restoration of the Lawful-
Government

14	:Mark-Alexander: Milley c/o :James-Charles: McConville	USofA- military- General	↓	↓
----	--	--------------------------	---	---

15	:John-Earl: Hyten c/o :James-Charles: McConville	USofA- military- General	↓	↓
----	--	--------------------------	---	---

:man- trustee

:association

:year, :day

USPO, other

:covenant

16	:David-Hilberry: Berger c/o :James-Charles: McConville	USofA- military- General	↓ 01/15/21	7009 2820 0003 8851 6100
----	--	--------------------------	---------------	--------------------------

↓
:Darrell-James: Hill, -:Ohioan- beneficiary- Executor:
DOI-1776-A.D. -:Treaty-of-Paris-1783-A.D.,
-:Concession-1213-A.D.; beneficiary- Executor:
EBA-1933-A.D.; Ambassador of the Almighty-God,
-:Trustee: Concession-1213-A.D. ~ -2020-A.D.

:Authorization for the Restoration of the Lawful-
Government

:2021-A.D. Document- History

17	:Michael-Martin-Gilday c/o :James-Charles: McConville	USofA- military- Admiral	↓	↓	↓
18	:David-Lee: Goldfein c/o :James-Charles: McConville	USofA- military- General	↓	↓	↓
			01/15/21	7009 2820 0003 8851 6100	
19	:John-William: Raymond c/o :James-Charles: McConville	USofA- military- General	↓	↓	↓
	:man- trustee	:association	:year, :day	USPO, other	:covenant
20	:Joseph-Lauren: Lengyel c/o :James-Charles: McConville	USofA- military- General	↓	↓	↓
21	:Karl-Leo: Schultz c/o :James-Charles: McConville	USofA- military- Admiral	↓	↓	↓
			01/15/21	7009 2820 0003 8851 6100	:Darrell-James: Hill, -:Ohioan- beneficiary- Executor: DOI-1776-A.D. -:Treaty-of-Paris-1783-A.D., -:Concession-1213-A.D.; beneficiary- Executor: EBA-1933-A.D.; Ambassador of the Almighty-God, -:Trustee: Concession-1213-A.D. ~ -2020-A.D. :Authorization for the Restoration of the Lawful- Government
	:man- trustee	:association	:year, :day	USPO, other	:covenant
22	:Mark: Lamb	:Pinal-County-Arizona-	01/15/21	7010 1060 0001 7518 9154	:Darrell-James: Hill, -:Ohioan- beneficiary- Executor:

93

716



State, -Sheriff

DOI-1776-A.D. -:Treaty-of-Paris-1783-A.D.,
-:Concession-1213-A.D.; beneficiary- Executor:
EBA-1933-A.D.; Ambassador of the Almighty-God,
-:Trustee: Concession-1213-A.D. ~ -2020-A.D.

:Authorization for the Restoration of the Lawful-
Government

23 :Paul: Penzone :Maricopa-County- 01/15/21 7012 2210 0000 4269 7384
Arizona-State, -Sheriff

:Darrell-James: Hill, -:Ohioan- beneficiary- Executor:
DOI-1776-A.D. -:Treaty-of-Paris-1783-A.D.,
-:Concession-1213-A.D.; beneficiary- Executor:
EBA-1933-A.D.; Ambassador of the Almighty-God,
-:Trustee: Concession-1213-A.D. ~ -2020-A.D.

:Authorization for the Restoration of the Lawful-
Government

24 :Joshep: Dedman, Jr. :Apache-County-Arizona- ↓ ↓ ↓
c/o :Mark: Lamb, State, -:Sheriff 7010 1060 0001 7518 9154
-:Sheriff, -:Pinal, 7012 2210 0000 4269 7384
c/o: Paul: Penzone

25 :Mark: Dannels :Cochise-County-Arizona- ↓ ↓ ↓
c/o :Mark: Lamb, State, -:Sheriff
-:Sheriff, -:Pinal
c/o: Paul: Penzone

26 :Jim: Driscol :Coconino-County- ↓ ↓ ↓
c/o :Mark: Lamb, Arizona-State, -:Sheriff 01/15/21 7010 1060 0001 7518 9154
-:Sheriff, -:Pinal

:Darrell-James: Hill, -:Ohioan- beneficiary- Executor:
DOI-1776-A.D. -:Treaty-of-Paris-1783-A.D.,



c/o: Paul: Penzone

7012 2210 0000 4269 7384

:-Concession-1213-A.D.; beneficiary- Executor:
EBA-1933-A.D.; Ambassador of the Almighty-God,
:-Trustee: Concession-1213-A.D. ~ -2020-A.D.

:Authorization for the Restoration of the Lawful-
Government

27 :Adam: Shephard
c/o :Mark: Lamb,
-:Sheriff, -:Pinal
c/o: Paul: Penzone

:Gila-County-Arizona-
State, -:Sheriff

↓

↓

↓

28 :Preston: Allred
c/o :Mark: Lamb,
-:Sheriff, -:Pinal

:Graham-County-Arizona-
State, -:Sheriff

↓

↓

↓

:man- trustee

:association

:year, :day

USPO, other

:covenant

29 :Tim: Sumner
c/o :Mark: Lamb,
-:Sheriff, -:Pinal
c/o: Paul: Penzone

:Greenlee-County-
Arizona-State, -:Sheriff

↓

01/15/21

7010 1060 0001 7518 9154

7012 2210 0000 4269 7384

↓

↓

:Darrell-James: Hill, -:Ohioan- beneficiary- Executor:
DOI-1776-A.D. -:Treaty-of-Paris-1783-A.D.,
:-Concession-1213-A.D.; beneficiary- Executor:
EBA-1933-A.D.; Ambassador of the Almighty-God,
:-Trustee: Concession-1213-A.D. ~ -2020-A.D.

:Authorization for the Restoration of the Lawful-
Government

30 :Bill: Risen
c/o :Mark: Lamb,

:La- Paz -County-
Arizona-State, -:Sheriff

↓

↓

↓

95

76



	:Sheriff, -:Pinal c/o: Paul: Penzone				
31	:Doug: Schuster c/o :Mark: Lamb, -:Sheriff, -:Pinal c/o: Paul: Penzone	:Mohave-County-Arizona- State, -:Sheriff	↓	↓	↓
	:man- trustee	:association	:year, :day	USPO, other	:covenant
32	:David: Clouse c/o :Mark: Lamb, -:Sheriff, -:Pinal c/o: Paul: Penzone	:Navajo-County-Arizona- State, -:Sheriff	↓	↓	↓
				7010 1060 0001 7518 9154 7012 2210 0000 4269 7384	
	:man- trustee	:association	:year, :day	USPO, other	:covenant
33	:Mark: Napier c/o :Mark: Lamb, -:Sheriff, -:Pina c/o: Paul: Penzone	:Pima-County-Arizona- State, -:Sheriff	↓ 01/15/21	↓ 7010 1060 0001 7518 9154 7012 2210 0000 4269 7384	↓ :Darrell-James: Hill, -:Ohioan- beneficiary- Executor: DOI-1776-A.D. -:Treaty-of-Paris-1783-A.D., -:Concession-1213-A.D.; beneficiary- Executor: EBA-1933-A.D.; Ambassador of the Almighty-God, -:Trustee: Concession-1213-A.D. ~ -2020-A.D. :Authorization for the Restoration of the Lawful- Government
34	:Tony: Estrada c/o :Mark: Lamb, -:Sheriff, -:Pinal c/o: Paul: Penzone	:Santa-Criz-County- Arizona-State, -:Sheriff	↓	↓	↓



:2021-A.D. Document- History

35	:Scott: Mascher c/o :Mark: Lamb, -:Sheriff, -:Pinal c/o: Paul: Penzone	Yavapai-County-Arizona- State, -:Sheriff			
	:man- trustee	:association	:year, :day	USPO, other	:covenant
36	Leon: Wilmot c/o :Mark: Lamb, -:Sheriff, -:Pinal c/o: Paul: Penzone	:Yuma-County-Arizona- State, -:Sheriff	01/15/21	7010 1060 0001 7518 9154 7012 2210 0000 4269 7384	:Darrell-James: Hill, -:Ohioan- beneficiary- Executor: DOI-1776-A.D. -:Treaty-of-Paris-1783-A.D., -:Concession-1213-A.D.; beneficiary- Executor: EBA-1933-A.D.; Ambassador of the Almighty-God, -:Trustee: Concession-1213-A.D. ~ -2020-A.D. :Authorization for the Restoration of the Lawful- Government
	:man- trustee	:association	:year, :day	USPO, other	:covenant
37	:Donald-John: Trump, et al.: Barack- Hussein: Obama, :Loretta: Lynch, :Jefferson-Beauregard: Sessions III, :Matthew-George: Whitaker, :Dana-James: Boente, :Sally-Caroline: Yates,	POTUS, -:Respondent, et al. -:Claim: matter#: RE 322 398 389 US :Darrell-James: Hill, -:Ohioan, -:civilian, -:Executor, -:Procurator for the Respondent, -::Claim: matter#: RE 322 398 389 US	01/14/21	:In :Hill-court of :Record At: Maricopa-County-Superior-Court, :Claim: matter#: RE 322 398 389 US	::Darrell-James: Hill, -:Ohioan- beneficiary- Executor: DOI-1776-A.D.: beneficiary- civilian -:Executor: EBA-1933-A.D. -PE-2016-A.D., et seq.- :covenants with the law of the covenants by the law of the DOI-1776-A.D. -PE-2016-A.D.- covenants, -:Procurator: procurator: Darrell-James: Hill, -:Executor. :Darrell-James: Hill, -:Ohioan, -:civilian, -:Executor, -:Procurator for the Respondent, -:Claim: matter#:

16

86

:William-Pelham: Barr,
:Seve-Turner: Mnuchin,
:Brian: Karth,
:Ranier-Christercunear:
Collins,
:John and Jan Doe –

RE 322 398 389 US

Under the Procurator
for the
respondent, :Darrell-
James: Hill, man-
Procurator

38 :Donald-John: Trump, et
al.: ...

Under the Procurator
for the
respondent, :Darrell-
James: Hill, man-
Procurator

↓
POTUS, -:Respondent, et
al. -:Claim: matter#: RE
322 398 389 US

:Darrell-James: Hill,
-:Ohioan, -:civilian,
-:Executor, -:Procurator
for the Respondent,
-:Claim: matter#: RE 322
398 389 US

01/14/21

:In :Hill-court of :Record At:
Maricopa-County-Superior-Court,
:Claim: matter#: RE 322 398 389
US –

1) :notice:
see claim: matter # RE 322 398 389
US

See- appended:
claim – executed;
:declaration: right of claim, with:
declaration: averments; claimant,

See- appended: Respondent:

↓
:Darrell-James: Hill, -:Ohioan- beneficiary-
Executor: DOI-1776-A.D.: beneficiary- civilian
-:Executor: EBA-1933-A.D. -PE-2016-A.D., et
seq.- :covenants with the law of the covenants by
the law of the DOI-1776-A.D. -PE-2016-A.D.-
covenants, -:Procurator: procurator: Darrell-James:
Hill, -:Executor.

::Darrell-James: Hill, -:Ohioan, -:civilian, -:Executor,
-:Procurator for the Respondent, -:Claim: matter#:
RE 322 398 389 US

declaration; stipulations;
 procurator as respondent

notice of receipt of claim; formal
 summons waived; 2 pg.

	:man- trustee	:association	:year, :day	USPO, other	:covenant
39	↓	↓	01/14/21	:In :Hill-court of :Record At: Maricopa-County-Superior-Court, :Claim: matter#: RE 322 398 389 US - 2) Service of Claim – Notice: matter # RE 322 398-389 US; 1 pg.	↓
40	↓	↓	01/14/21	:In :Hill-court of :Record At: Maricopa-County-Superior-Court, :Claim: matter#: RE 322 398 389 US - 3) :claim – executed: :matter # RE 322 398 389 US :Executor- Waiver of :Recordation and Court-of-Record Fees; 1 pg.	↓
	:Donald-John: Trump, et al.: ... Under the Procurator for the respondent, :Darrell- James: Hill, man- Procurator	POTUS, -:Respondent, et al. -:Claim: matter#: RE 322 398 389 US :Darrell-James: Hill, -:Ohioan, -:civilian, -:Executor, -:Procurator for the Respondent, -:Claim: matter#: RE 322 398 389 US			
	:man- trustee	:association	:year, :day	USPO, other	:covenant

619

185

41

01/14/21 :In :Hill-court of :Record At:
Maricopa-County-Superior-Court,
:Claim: matter#: RE 322 398 389
US --

:Darrell-James: Hill, -:Ohioan- beneficiary-
Executor: DOI-1776-A.D.: beneficiary- civilian
-:Executor: EBA-1933-A.D. -PE-2016-A.D., et
seq.- :covenants with the law of the covenants by
the law of the DOI-1776-A.D. -PE-2016-A.D.-
covenants, -:Procurator: procurator: Darrell-James:
Hill, -:Executor.

4) :claim – executed:
:matter # RE 322 398 389 US

common-theft,
with penalty-agreement,
with :respondent :in-dishonor

::Darrell-James: Hill, -:Ohioan, -:civilian, -:Executor,
-:Procurator for the Respondent, -:Claim: matter#:
RE 322 398 389 US

42

:Donald-John: Trump, et
al.: ...

POTUS, -:Respondent, et
al. -:Claim: matter#: RE
322 398 389 US

01/14/21 :In :Hill-court of :Record At:
Maricopa-County-Superior-Court,
:Claim: matter#: RE 322 398 389
US -

:Darrell-James: Hill, -:Ohioan- beneficiary-
Executor: DOI-1776-A.D.: beneficiary- civilian
-:Executor: EBA-1933-A.D. -PE-2016-A.D., et
seq.- :covenants with the law of the covenants by
the law of the DOI-1776-A.D. -PE-2016-A.D.-
covenants, -:Procurator: procurator: Darrell-James:
Hill, -:Executor.

Under the Procurator
for the
respondent, :Darrell-
James: Hill, man-
Procurator

:Darrell-James: Hill,
-:Ohioan, -:civilian,
-:Executor, -:Procurator
for the Respondent,
-:Claim: matter#: RE 322
398 389 US

5) :declaration: right of claim
:in :out of court-judgment'-matter
:in the non-controversy
:under- procuratinon- expressed
:in- accordance with :covenant- as
:stipulated-to and agreed-upon

::Darrell-James: Hill, -:Ohioan, -:civilian, -:Executor,
-:Procurator for the Respondent, -:Claim: matter#:
RE 322 398 389 US

See: declaration; averments;
claimant



See: stipulations: procurator as respondent. ~verified~, 3 pgs.

	:man- trustee	:association	:year, :day	USPO, other	:covenant
43	↓	↓	01/14/21	:In :Hill-court of :Record At: Maricopa-County-Superior-Court, :Claim: matter#: RE 322 398 389 US -	↓ :Darrell-James: Hill, -:Ohioan- beneficiary- Executor: DOI-1776-A.D.: beneficiary- civilian -:Executor: EBA-1933-A.D. -PE-2016-A.D., et seq.- :covenants with the law of the covenants by the law of the DOI-1776-A.D. -PE-2016-A.D.- covenants, -:Procurator: procurator: Darrell-James: Hill, -:Executor. ::Darrell-James: Hill, -:Ohioan, -:civilian, -:Executor, -:Procurator for the Respondent, -:Claim: matter#: RE 322 398 389 US
44	↓ :Donald-John: Trump, et al.: ... Under the Procurator for the respondent, :Darrell- James: Hill, man- Procurator	↓ POTUS, -:Respondent, et al. -:Claim: matter#: RE 322 398 389 US :Darrell-James: Hill, -:Ohioan, -:civilian, -:Executor, -:Procurator for the Respondent, -::Claim: matter#: RE 322	01/14/21	:In :Hill-court of :Record At: Maricopa-County-Superior-Court, :Claim: matter#: RE 322 398 389 US - 7) :matter # RE 322 298 289 US :declaration- :stipulations: procurator as respondent ~verified~, 6 pgs.	↓

102



	:man- trustee	:association	:year, :day	USPO, other	:covenant
45	↓	↓	01/14/21	:In :Hill-court of :Record At: Maricopa-County-Superior-Court, :Claim: matter#: RE 322 398 389 US - 8) :matter 3 RE 322 398 389 US :ORDERS :PE and Lot -One- Covenant- agreement	↓↓ ::Darrell-James: Hill, -:Ohioan- beneficiary- Executor: DOI-1776-A.D.: beneficiary- civilian -:Executor: EBA-1933-A.D. -PE-2016-A.D., et seq.- :covenants with the law of the covenants by the law of the DOI-1776-A.D. -PE-2016-A.D.- covenants, -:Procurator: procurator: Darrell-James: Hill, -:Executor. ::Darrell-James: Hill, -:Ohioan, -:civilian, -:Executor, -:Procurator for the Respondent, -:Claim: matter#: RE 322 398 389 US
46	↓ :Donald-John: Trump, et al.: Under the Procurator for the respondent, :Darrell- James: Hill, man- Procurator	↓ POTUS, -:Respondent, et al. -:Claim: matter#: RE 322 398 389 US :Darrell-James: Hill, -:Ohioan, -:civilian, -:Executor, -:Procurator for the Respondent, -::Claim: matter#: RE 322 398 389 US	01/14/21	:In :Hill-court of :Record At: Maricopa-County-Superior-Court, :Claim: matter#: RE 322 398 389 US - 9) :matter # RE 322 398 389 :ORDERS :PE and Lot -Two- Covenant- agreement	
47	↓	↓	01/14/21	:In :Hill-court of :Record At:	



Maricopa-County-Superior-Court,
:Claim: matter#: RE 322 398 389
US --

10) :matter # RE 322.398 389 US
:ORDERS
:PE and Lot Three Covenant-
agreement

	:man- trustee	:association	:year, :day	USPO, other	:covenant
48	↓ :Donald-John: Trump, et al.: ... Under the Procurator for the respondent, :Darrell-James: Hill, man-Procurator	↓ POTUS, -:Respondent, et al. -:Claim: matter#: RE 322 398 389 US :Darrell-James: Hill, -:Ohioan, -:civilian, -:Executor, -:Procurator for the Respondent, -:Claim: matter#: RE 322 398 389 US	01/14/21	:In :Hill-court of :Record At: Maricopa-County-Superior-Court, :Claim: matter#: RE 322 398 389 US 11) :matter # RE 322 398 389 US :ORDERS PE and Lot Four Covenant-agreement	↓ :Darrell-James: Hill, -:Ohioan- beneficiary-Executor: DOI-1776-A.D.: beneficiary- civilian -:Executor: EBA-1933-A.D. -PE-2016-A.D., et seq.- :covenants with the law of the covenants by the law of the DOI-1776-A.D. -PE-2016-A.D.-covenants, -:Procurator: procurator: Darrell-James: Hill, -:Executor. :Darrell-James: Hill, -:Ohioan, -:civilian, -:Executor, -:Procurator for the Respondent, -:Claim: matter#: RE 322 398 389 US
49	:Vanessa: Martinez	:Maricopa-County-Arizona-State-Superior-Court-Clerk-office	01/19/21	:Claim-matter: RE 322 398 389 US	January 19, 2021- A.D. :Maricopa-County-Arizona-State- Deprivation of the Access to the Common-Law-Court at the Maricopa-

101

104

County- Arizona- Superior-Court- venue is with the unlawful-Policy and Procedure- Implemented with the harm upon the man-Ohioan-Executor -:Darrell-James: Hill, -Executor-Procurator, -:Arizona-habitant by the Maricopa-County-Arizona-State-Clerks:Vanessa: Martinez with reported counsel with :Nikki: Swiss and :Jeff: Fine.

50	:Nikki: Swiss					
51	:Jeff: Fine	:Maricopa-County-Arizona-State-Superior-Court-Clerk-office		:Claim-matter: RE 322 398 389 US		
52						
	:man- trustee	:association	:year, :day	USPO, other		:covenant
53	:Jack: Sellers	:Maricopa-County-Arizona-State- Supv.	01/22/21	7009 2820 0003 9570 7942		January 19 th , 2021- Deprivation of Rights to the Court of Record for :Clam: matter # RE 322 398 389 US at the Maricopa-County-Arizona-State-Superior-Court ...
54	:Steve: Chucri					
55	:Bill: Gates					
56	:Blint: Hickman					
57	:Steve: Gallardo	:Maricopa-County-Arizona-State- Supv.	01/22/21	7009 2820 0003 9570 7942		January 19 th , 2021- Deprivation of Rights to the Court of Record for :Clam: matter # RE 322 398 389 US at the Maricopa-County-Arizona-State-Superior-Court ...



:2021-A.D. Document- History

17 / 28

	:man- trustee	:association	:year, :day	USPO, other	:covenant
58	:Jeff: Fine	:Maricopa-County- Arizona-State- Court- Clerk	↓ 01/22/21	7009 2820 0003 9570 7973	↓
59	:Joseph-Robinette: Biden	POTUS	↓ 01/22/21	7009 2820 0003 9570 7997	↓ January 19 th , 2021- Deprivation of Rights to the Court of Record for :Clam: matter # RE 322 398 389 US at the Maricopa-County-Arizona-State-Superior- Court
60	:Pamela: Gates	:Maricopa-County- Arizona-State- Court- Judge- Presiding	↓	7009 2820 0003 9570 7966	↓
61	:Joseph: Welty	:Maricopa-County- Arizona-State- Court- Judge- Chief	↓ 01/22/21	7009 2820 0003 9570 7959	↓ January 19 th , 2021- Deprivation of Rights to the Court of Record for :Clam: matter # RE 322 398 389 US at the Maricopa-County-Arizona-State-Superior- Court
62	:Paul: Penzone	:Maricopa-County- Arizona-State- Court- Sheriff	↓	7009 2820 0003 9570 7980	↓
	:man- trustee	:association	:year, :day	USPO, other	:covenant
63	:Monty: Wilkinson	U.S.- AG, APC, CLT	↓ 01/22/21	7009 2820 0003 9570 8000	↓ January 19 th , 2021- Deprivation of Rights to the Court of Record for :Clam: matter # RE 322 398 389

106
991

US at the Maricopa-County-Arizona-State-Superior-Court ...

64 :Joseph-Robinette: POTUS 01/28/21 RE 322 398 389 US :Claim of :UnalienableRight :in-accordance With the Covenant-Agreements

:i- man- beneficiary Have endured The POTUS- Office Dereliction Beginning With The BarackHusseins's Presidency-2016 A.D.- Unto Now. - :i- man require :This Must End Now.

:Covenant-Agreements-Statuses- :in -Procuration

	:man- trustee	:association	:year, :day	USPO, other	:covenant
65	:Lloyd-J.: Austin III c/o: Joseph-Robinette: Biden	US- Secretary of Defense	↓ 01/28/21	↓ RE 322 398 389 US	↓
66	:Mark-A.: Milley c/o: Joseph-Robinette: Biden	USofA- military- General	↓	↓	↓
67	:John-E.: Hyten c/o: Joseph-Robinette: Biden	USofA- military- General	↓ 01/28/21	↓ RE 322 398 389 US	↓ :Claim of :UnalienableRight :in-accordance With the Covenant-Agreements :i- man- beneficiary Have endured The POTUS- Office Dereliction Beginning With The

BarackHussein's Presidency-2016 A.D.- Unto Now.
 - :i- man require :This Must End Now.

:Covenant-Agreements-Statuses- :in -Procuration

68 :John: Whitley U.S. Secretary-Army, Acting
 c/o: Joseph-Robinette: Biden

:man- trustee :association :year, :day USPO, other :covenant

69 :Tom: Harker U.S. Secretary-Navy
 c/o: Joseph-Robinette: Biden
 01/28/21 RE 322 398 389 US

70 :Monty: Wilkinson U.S. -AG, APC, CLT
 c/o: Joseph-Robinette: Biden

:Claim of :UnalienableRight :in-accordance With the
 Covenant-Agreements

:i- man- beneficiary Have endured The POTUS-
 Office Dereliction Beginning With The
 BarackHussein's Presidency-2016 A.D.- Unto Now.
 - :i- man require :This Must End Now.

:Covenant-Agreements-Statuses- :in -Procuration

71 :Joseph: Welty :Maricopa-County-
 c/o: Joseph-Robinette: Arizona-State-Superior-
 Biden Court- Judge, -Chief
 01/28/21 RE 322 398 389 US

107

108

72	:David-L.: Norquist c/o: Joseph-Robinette: Biden	U.S. Secretary of Defense- Deputy	↓	↓	↓
	:man- trustee	:association	:year, :day	USPO, other	:covenant
73	:Lisa: Hershman c/o: Joseph-Robinette: Biden	U.S. Chief Mgmt Officer	↓ 01/28/21	↓ RE 322 398 389 US	↓ :Claim of :UnalienableRight :in-accordance With the Covenant-Agreements :i- man- beneficiary Have endured The POTUS- Office Dereliction Beginning With The BarackHussein's Presidency-2016 A.D.~ Unto Now. - :i- man require :This Must End Now. :Covenant-Agreements-Statuses- :in -Procuration
74	:Stacy-A.: Cummings c/o: Joseph-Robinette: Biden	Under Secretary of Defense- Acquisition	↓	↓	↓
75	:John: Roth c/o: Joseph-Robinette: Biden	U.S.- Secretary- Air- Force, Acting	↓ 01/28/21	↓ RE 322 398 389 US	↓
76	:Amanda: Dory c/o: Joseph-Robinette: Biden	US. Under Secretary of Defense for Policy	↓	↓	↓
77	:Jack: Sellers c/o: Fran: McCarroll	:Maricopa-County- Arizona-State- Supv.	↓ 01/28/21	↓ RE 322 398 389 US	↓



c/o: Joseph-Robinette:
 Biden

:man- trustee

:association

:year, :day

USPO, other

:covenant

78

:Steve: Chucri
 c/o: Fran: McCarroll
 c/o: Joseph-Robinette:
 Biden

:Maricopa-County-
 Arizona-State- Supv.

↓
 01/28/21

↓
 RE 322 398 389 US

↓
 :Claim of :UnalienableRight :in-accordance With the
 Covenant-Agreements

:i- man- beneficiary Have endured The POTUS-
 Office Dereliction Beginning With The
 BarackHussein's Presidency-2016 A.D.- Unto Now.
 - :i- man require :This Must End Now.

:Covenant-Agreements-Statuses- :in -Procuration

79

:Bill: Gates
 c/o: Fran: McCarroll
 c/o: Joseph-Robinette:
 Biden

:Maricopa-County-
 Arizona-State- Supv.

↓
 01/28/21

↓
 RE 322 398 389 US

80

:Clint: Hickman
 c/o: Fran: McCarroll
 c/o: Joseph-Robinette:
 Biden

:Maricopa-County-
 Arizona-State- Supv.

↓

↓

↓

81

:Steve: Gallardo
 c/o: Fran: McCarroll
 c/o: Joseph-Robinette:
 Biden

:Maricopa-County-
 Arizona-State- Supv.

↓
 01/28/21

↓
 RE 322 398 389 US

101

110

	:man- trustee	:association	:year, :day	USPO, other	:covenant
82	:Virginia: Penrod c/o: Joseph-Robinette: Biden	:US- Under-Secretary of Defense	↓	↓	↓ :Claim of :UnalienableRight :in-accordance With the Covenant-Agreements :i- man- beneficiary Have endured The POTUS- Office Dereliction Beginning With The BarackHussein's Presidency-2016 A.D.- Unto Now. - :i- man require :This Must End Now. :Covenant-Agreements-Statuses- :in -Procuration
83	:Pamela: Gates c/o: Joseph-Robinette: Biden	:Maricopa-County- Arizona-State -Judge, - Presiding	↓ 01/28/21	↓ RE 322 398 389 US	↓
84	:Douglas: Glenn c/o: Joseph-Robinette: Biden	:US- Under Secretary of Defense	↓	↓	↓
85	:Paul: Penzone c/o: Joseph-Robinette: Biden	:Maricopa-County- Arizona-State- Sheriff	↓ 01/28/21	↓ RE 322 398 389 US	↓
	:man- trustee	:association	:year, :day	USPO, other	:covenant
86	:Jeff: Fine c/o: Joseph-Robinette: Biden	:Maricopa-County- Arizona-State- Supv.	↓ 01/28/21	7018 0360 0000 5968 6139	↓ :Claim of :UnalienableRight ;in-accordance With the Covenant-Agreements



:i- man- beneficiary Have endured The POTUS- Office Dereliction Beginning With The BarackHussein's Presidency-2016 A.D.~ Unto Now. -- :i- man require :This Must End Now.

:Covenant-Agreements-Statuses- :in -Procuration

87 :John-Earl: Hyten USofA- military- General 02/05/21 7009 1410 0000 7868 5741

:Sovereign- :United-State-of-America- people- Authority AND :Sovereign-Authority- Acceptance :in-Procuration by :Covenant- Agreements; for: a) :Receipt of the non- incorporated, :authority on the Abandonment and Vacation of the office of the President by the man Donald-John: Trump, -:Trustee, :in Dishonor; and b) :Sovereign-Authority- Acceptance :in- Procuration by :Covenant-Agreements: Lots: One, Two, Three, Four, Five, six, and Seven (~fialure to restore republic-constitution for: cause~

88 :Mark-Alexander: Milley USofA- military- General
c/o: John-Earl: Hyten 02/05/21 7009 1410 0000 7868 5741

89 :Jamer-Charles: USofA- military- General
McConville
c/o: John-Earl: Hyten

:man- trustee :association :year, :day USPO, other :covenant

90 :David-Hilberry: Berger USofA- military- General
c/o: :Mark-Alexander: 02/05/21 7009 1410 0000 7868 5741

:Sovereign- :United-State-of-America- people-

112

Milley

Authority AND :Sovereign-Authority-
Acceptance :in-Procuration by :Covenant-
Agreements; for: a) :Receipt of the non-
incorporated, -'authority on the Abandonment and
Vacation of the office of the President by the man
Donald-John: Trump, -:Trustee, :in Dishonor; and
b) :Sovereign-Authority- Acceptance :in-
Procuration by :Covenant-Agreements: Lots: One,
Two, Three, Four, Five, six, and Seven (~fialure to
restore republic-constitution for: cause~

91 :Michael-Martin: Gilday :USofA- military- Admiral
c/o: John-Earl: Hyten 02/05/21 7009 1410 0000 7868 5741

92 :David-Lee: Goldfein USofA- military- General
c/o: John-Earl: Hyten

93 :John-William: Raymond USofA- military- General
c/o: John-Earl: Hyten 02/05/21 7009 1410 0000 7868 5741

:Sovereign- :United-State-of-America- people-
Authority AND :Sovereign-Authority-
Acceptance :in-Procuration by :Covenant-
Agreements; for: a) :Receipt of the non-
incorporated, -'authority on the Abandonment and
Vacation of the office of the President by the man
Donald-John: Trump, -:Trustee, :in Dishonor; and
b) :Sovereign-Authority- Acceptance :in-
Procuration by :Covenant-Agreements: Lots: One,
Two, Three, Four, Five, six, and Seven (~fialure to
restore republic-constitution for: cause~

2022-011769 MISC Page: 113 of 2782
 09/26/2022 03:35:37 PM Receipt #: 22-9381
 Rec Fee: \$30.00 Darrell James Hill
 Gila County, Az, Sadie Jo Bingham, Recorder

	:man- trustee	:association	:year, :day	USPO, other
94	:Joseph-Lauren: Lengyel c/o: :Mark-Alexander: Milley	USofA- military- General	↓	↓
95	:Karl-Leo: Schultz c/o: :Mark-Alexander: Milley	:USofA- military- Admiral	↓ 02/05/21	↓ 7009 1410 0000 7868 5741
96	:man- trustee	:association	:year, :day	USPO, other
97	:Joseph-Robinette: Biden	:POTUS, et al.- man- actors	02/09/21	7009 1410 0000 7868 5734
98	:Mark-Alexander: Milley	USofA- military- General	↓	~RE 322 398 295 US~ →

:covenant

↓
 ↓
 :Sovereign- :United-State-of-America- people-
 Authority AND :Sovereign-Authority-
 Acceptance :in-Procuration by :Covenant-
 Agreements; for: a) :Receipt of the non-
 incorporated, -'authority on the Abandonment and
 Vacation of the office of the President by the man
 Donald-John: Trump, -:Trustee, :in Dishonor; and
 b) :Sovereign-Authority- Acceptance :in-
 Procuration by :Covenant-Agreements: Lots: One,
 Two, Threë, Four, Five, six, and Seven (~fialure to
 restore republic-constitution for: cause~

:covenant

↓
 :2021-A.D. February 4th: Authority
 For : 'U.S.Corp' -:Trustee- Government-Services-
 Provider, 'gsp', -:Trustee- EBA-1933-A.D., To
 Ascend By any-Means To The Entity-Status-
 Equivalency of -:Man-Kind; Organic-State,
 Subrogation or Fictional, Or A :Like- Presumption-
 Status, is Here-To-Fore and Now-To-After- :Denied.

611

114

02/09/21

RE 322 398 313 US

:2021-A.D. February 4th: Authority
 For :U.S.Corp'-:Trustee- Government-Services-
 Provider, 'gsp',-:Trustee- EBA-1933-A.D., To
 Ascend By any-Means To The Entity-Status-
 Equivalency of -:Man-Kind; Organic-State,
 Subrogation or Fictional, Or A :Like- Presumption-
 Status, is Here-To-Fore and Now-To-After- :Denied.

99 :John-Earl: Hyten
 c/o: :Mark-Alexander:
 Milley

02/09/21

100 :Jamer-Charles: USofA- military- General
 McConville
 c/o: :Mark-Alexander:
 Milley

02/09/21

~RE 322 398 295 US~ →
 RE 322 398 313 US

:2021-A.D. February 4th: Authority
 For :U.S.Corp'-:Trustee- Government-Services-
 Provider, 'gsp',-:Trustee- EBA-1933-A.D., To
 Ascend By any-Means To The Entity-Status-
 Equivalency of -:Man-Kind; Organic-State,
 Subrogation or Fictional, Or A :Like- Presumption-
 Status, is Here-To-Fore and Now-To-After- :Denied.

:man- trustee

:association

:year, :day

USPO, other

:covenant

101 :David-Hilberry: Berger USofA- military- General
 c/o: :Mark-Alexander:
 Milley

102 :Michael-Martin: Gilday :USofA- military- Admiral
 c/o: :Mark-Alexander:

02/09/21

~RE 322 398 295 US~ →

:2021-A.D. Document- History 27 / 28

	:man- trustee	:association	:year, :day	USPO, other	:covenant
	Milley			RE 322 398 313 US	
103	:David-Lee: Goldfein c/o: :Mark-Alexander: Milley	USofA- military- General	↓	↓	↓
104	:John-William: Raymond c/o: :Mark-Alexander: Milley	USofA- military- General	↓ 02/09/21	↓ ~RE 322 398 295 US~ → RE 322 398 313 US	↓ :2021-A.D. February 4 th : Authority For :U.S.Corp'-:Trustee- Government-Services- Provider, 'gsp',-:Trustee- EBA-1933-A.D., To Ascend By any-Means To The Entity-Status- Equivalency of -:Man-Kind; Organic-State, Subrogation or Fictional, Or A :Like- Presumption- Status, is Here-To-Fore and Now-To-After- :Denied.
	:man- trustee	:association	:year, :day	USPO, other	:covenant
105	:Joseph-Lauren: Lengyel c/o: :Mark-Alexander: Milley	USofA- military- General	↓	↓	↓
106	:Karl-Leo: Schultz c/o: :Mark-Alexander: Milley	:USofA- military- Admiral	↓ 02/09/21	↓ ~RE 322 398 295 US~ → RE 322 398 313 US	↓ :2021-A.D. February 4 th : Authority For :U.S.Corp'-:Trustee- Government-Services- Provider, 'gsp',-:Trustee- EBA-1933-A.D., To Ascend By any-Means To The Entity-Status- Equivalency of -:Man-Kind; Organic-State, Subrogation or Fictional, Or A :Like- Presumption- Status, is Here-To-Fore and Now-To-After- :Denied.
	:man- trustee	:association	:year, :day	USPO, other	:covenant

116

116

:2021-A.D. Document- History 28 / 28

107 :Jessica-J. Fotinos :General-Counsel and Public-Information-Officer 02/11/21 Regular-U.S.-Mail

'The Clerk of the Superior-Court in the Maricopa-County-Arizona-State = -:Clerk's- Office~'
 -
 ... after a cursory-review... it does not appear that the documents-relate to the any-matter ... or issue that involves the -:Clerk's- Office... .
 The -Clerk's- Office -functions as ... [,] the documents-would-need-to-conform with the applicable- rules-of-procedure, -including the state and local-rules-of-procedure ... - [d]epending on the case-type.' : "These documents do not conform with any of those rules."

108 :Stephen-Q: Miller :Arizona-State-Country-Pinal-County- Trustee-Chairman: Board-of-Supervisors 12/30/21 RE 322 390 840 US

Completion of the 45-day- Notice: December-30-2021-AD, :45day-notice -Unit:
 a) December-16-2021-AD, :RE322390751US
 b) November-18-2021-AD, :RE322398344US
 c) November-15-2021-AD, :RE322398361

109 :c/o :Natasha: Kennedy :Arizona-State-Country-Pinal-County- Trustee-Clerk: Board-of-Supervisors ↓ ↓ ↓

:man- trustee :association :year, :day USPO, other :covenant

:2022-A.D. Document- History 1 / 1

:2022 A.D.					
#	:man- trustee	:association	:year, :day	USPO, other	:covenant
1	:c/o: Sadie-Jo: Bingham	:Arizona-State-Gila-County-Trustee: Recorder	12/30/21	RMN RE 322 390 358 US	Mitigation -request for the removal of the libel-statements-made into the public-record in the violation by the right: DOI-1776-AD.
2	:Taylor: Holland	↓	01-03-2022	↓	:Return with a charge with the no- mention of the ceasing of the libel-required.
3	:Stev: Christensen	:Arizona-State-Gila-County-Trustee: Board-Officer	01-12-2022 ↓	CMN 7009 1410 0000 7868 5826 ↓	Notice of the Default with the Choice for the Correction: 12-30-21: RMN 322 390 358 US - Request for the cease of the Libel.
4	:Tim-R: Humphrey	↓	↓	↓	↓
5	:Woody: Cline	↓	↓	↓	↓
6	:Marian: Shephard	:Arizona-State-Gila-County-Trustee: Board-Clerk of the Board	↓	↓	↓
7	:c/o: Sadie-Jo: Bingham	:Arizona-State-Gila-County-Trustee: Recorder	↓	[RMN RE 322 390 836 US]	NOT MAILED

117



:2012-A.D. - Document History; 1 / 1

:2012 A.D.					
#	:man- trustee	:association	:year, :day	USPO, other	:covenant
1	:J-C.: Sloan	McKinley-County:-New-Mexico-State, :Recorder	10/02/12	McKinley-County:-New-Mexico-State, :Recorder Doc.# 360413	Recordation: Affidavit: 23 pages. We, the Hills, husband and wife verify as indicated.
2	:Barack: Hussein: Obama	POTUS	08/31/12	RE 430 969 426 US	Account, settle and close EBA-1933-A.D.; close SSA. :Astrue agrees with -:no-compliant-action; p. 3.
3	:John-J.: Astrue	U.S.- SSA- Comm.	↓	↓	:Darrell-James: Hill, -:Ohioan- beneficiary, -:Executor Notice of Default for the account, settle and close EBA-1933-A.D.; close SSA. :Astrue agreement with -:silent-non-action; p. 4
4	:Barack: Hussein: Obama	POTUS	↓	↓	:Beverly-Jean: Romero- Hill, -:New-Mexican- beneficiary, -:Executor Notice of Default for the account, settle and close EBA-1933-A.D.; close SSA. :Astrue agreement with -:silent-non-action; p. 8.
5	:John-J.: Astrue	U.S.- SSA- Comm.	09/18/12	7009 7820 0003 8851 6155	Notices of Default: Darrell-James: Hill ~husband~ is with the agreement with the silent-non-action; p. 14, 15.
6	:John-J.: Astrue	U.S.- SSA- Comm.	↓	↓	Notices of Default: Beverly-Jean: Romero- Hill ~wife~ is with the agreement with the silent-non-action; p. 14, 19.

:2012-A.D. - Document History; 1 / 1

812

Affidavit



We, the Hills, **Hill Darrell James (husband)**, and **Romero-Hill Beverly Jean (wife)**, affirm that the copies of the following documents enclosed are accurate and truthful to the best of our ability(s), and were reported delivered as indicated by the USPO (www.usps.com) confirmations, attached:

Correspondence: Affidavits sent to Social Security Administrator Commissioner Astrue c/o President Barack Hussein Obama: USPO RMN: RE 430 969 426 US -
Delivered: September 13, 2012, 4:23 am
(Enclosure A: pages)

Correspondence: Copy of Affidavits (sent to Commissioner Astrue c/o President Barack Hussein Obama: RMN: RE 430 969 426) sent Directly to Commissioner Astrue: USPO CMN: 7009 2820 0003 8851 6155 -
Delivered: September 21, 2012, 8:02 am
(Enclosure B: pages)

Darrell James Hill (husband)
Sovereign Citizen of the United States of America



Beverly Jean, Romero-Hill (wife)
Sovereign Citizen of the United States of America

NOTARY PUBLIC CERTIFICATION

BEFORE ME, the undersigned authority, a Notary Public, of the County of CIBOLA Republic of NM (statename), this 20th day of September, 2012, **Darrell James, Hill**, and **Beverly Jean, Romero- Hill**, the above signed human beings did appear and were identified by (circle one): driver's licenses / passports / other, and who, upon first being duly sworn and/or affirmed, deposes and says that the foregoing asseveration true to the best of their knowledge and belief(s).

I (We) certify under PENALTY OF PERJURY under the laws of the state of New Mexico that the foregoing paragraph is true and correct.

WITNESS my hand and official seal.

Notary Public _____ Seal



My Commission Expires On:

2019

DOCH 360413
10/02/2012 09:54 AM Page: 1 of 23
REF \$0.00 J. C. Sloan, McKinley County

Affidavit

2022-011769 MISC Page: 120 of 2782
09/26/2022 03:35:37 PM Receipt #: 22-9381
Rec Fee: \$30.00 Darrell James Hill
Gila County, Az; Sadie Jo Bingham, Recorder

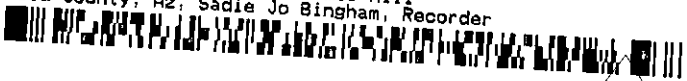

Unofficial Copy

ENCLOSURE: A

DOCH 360413

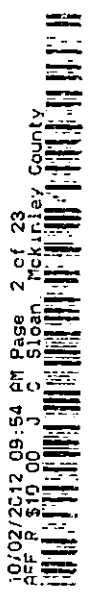

10/02/2012 09:54 AM Page 2 of 23
AFF P \$10.00 J C Sloan, McKinley County

ENCLOSURE: A

Affidavit: Hill Darrell James; Romero-Hill Beverly Jean September-2012

120

Darrell James, Hill, and Beverly Jean, Romero-Hill
28 Hilltop Court, HC 61, Box 771, Ramah, New Mex.

USPO RMN: RE 430 969 426 US

President Barack Hussein Obama
The White House
1600 Pennsylvania Avenue NW
Washington, DC. 20500

2022-011769 MISC Page: 121 of 2782
09/26/2022 03:35:37 PM Receipt #: 22-9381
Rec Fee: \$30.00 Darrell James Hill
Gila County, Az, Sadie Jo Bingham, Recorder



Re: Commissioner John J. Astrue c/o President Barack H. Obama Affidavits (attached)

Dear Mr. President:

Our name is Hill: Darrell James, Hill, husband, and wife Beverly Jean Romero- Hill. We are American Citizens born in states of the union of States of America. We trust in God Almighty, the God of Abraham, Isaac and Jacob, and keep the commandments of the Most High God YHVH sacred.

We have written to Commissioner Astrue c/o You the attached Affidavit(s) (Notices of Default) because you are this agency's direct chief executive. The Affidavit decrees our Non-SSA association status and demands the Commissioner's strict compliance with our Constitutional decree.

Issue History and Status

We administratively ordered Commissioner to rescind the any SSA association (account, number, et seq.) over six years ago necessitating writing the American Citizen Sovereign's Affidavits now enclosed to Commissioner c/o you.

The statuses are not administrative issues, not requests, and not subject to dispute. The decrees and demands are plainly from inalienable Constitutional rights of choice as we did act, and the Commissioner is Constitutionally constrained and duty bound to serve in accordance with each decree and order. (When a Constitutional republic's principles are abandoned without apprehension of repercussion, look for a dulocracy.)

What We want you to do

Commit the letter to the addressee; and, oblige the Commissioner to without hesitation obey our decrees and demands, to respect our choices under obligation to the Constitution for United States of America. Your expedience in this matter would be appreciated.

Sincerely;

Darrell James, Hill (husband)
Sovereign Citizen of the United States of America

Beverly Jean, Romero-Hill (wife)
Sovereign Citizen of the United States of America

Enclosure: Affidavit: Notice of Default, sent to Commissioner of SSA from husband (4 pages)
Affidavit: Notice of Default, sent to Commissioner of SSA from wife (3 pages)

21521

DOCH 360413

10/02/2012 09:54 AM Page: 3 of 23
AFF RE \$10.00 J. C. Sloan, Mckinley County

AFFIDAVIT

Commissioner John J. Astrue,
c/o President Barack Hussein Obama
Office of Commissioner
Social Security Administration
6401 Security Blvd.
Baltimore, MD 21235

2022-011769 MISC Page: 122 of 2782
09/26/2022 03:35:37 PM Receipt #: 22-9381
Rec Fee: \$30.00 Darrell James Hill
Gila County, Az, Sadie Jo Bingham, Recorder

NOTICE OF DEFAULT

You are in Default of Notice and Demand:

this document is the service of Notice of Default upon you Commissioner Astrue, et al., (Commissioner) of the Social Security Administration (SSA) for dishonor upon the demand and all prior notices of same from Darrell James, Hill, (Submitter) to rescind all SSA association as ordered, noticed and demanded.

Darrell James, Hill:

Submitter is an American citizen, a private human being born within the states of the Union of States of America. Submitter is Not a "U.S. Citizen", "person", "individual", "resident", "entity", or "etc." other terms of the municipal, administrative law and adhesion contract(s) of the "United States"; Rather, Submitter is a non-volunteer of same.

I, Darrell James, Hill, have settled my belief and place all my trust in God Almighty, the Torah God of Abraham, Isaac and Jacob, YHVH to protect and provide for me forever, now and hereafter. All I have ever needed is manifested through Him. This fact is my experience, understanding, my religious choice of Sovereign right, and not alienable under the Constitution for the United States of America. No other guarantor, specifically the United States SSA, is necessary or needed as I decided in May of 2006, the date of the ORIGINAL Order of Rescission received by the SSA association, et seq. See Since 2006 the Commissioner has ignored Submitter's determination (below).

Since 2006 the Commissioner has ignored Submitter's determination:

1. See Judges Order in United States of America v. Beverly J. Hill, and Darrell J. Hill, individually,..., No. CV 05-877-PHX-DGC permanently enjoined Submitter from any involvement in any way for filing or assisting in filing of any tax return for any "person or entity other than themselves." Submitter is not a "person" or and "entity". As the self, Submitter is an American Citizen under the Constitution for the United States of America, Not a "U.S. Citizen", etc. as determined above.
2. Administrative Demand For Rescission of SSA association was filed in May 22, 2006, at the local SSA office, evidence of which was sent broadly then filed into the public record in Gila County Arizona, Doc. Id. 2006-008777
3. Multiple Demand For Rescission of SSA association was sent and received by Commissioner by USPO Registered Mail RA 337 238 865 US in September 2009.
4. See 2009 Case: 2:09 CV-01956-DGC Darrell Hill v Premier Healthcare Services: Commissioner of SSA is codefendant. Rescission information is Placed in Docket 1, Exhibits.
5. See 2009 Case 2:09 CV-01957-MHM Darrell Hill v DNA Medical Staffing, LLC: Commissioner of SSA is codefendant. Rescission information is Placed in Docket 1, Exhibits.

122

DOCH 360413
12/02/2012 09:54 AM Page 4 of 23
OFF. R. \$10.00 J. C. Sloan, McKinley County

6 See 2009 Case 2:09 CV-01958-JAT Darrell Hill v Promise Hospital of Phoenix, Inc.:
Commissioner of SSA is codefendant. Rescission information is Placed in Docket 1, Exhibits.

U.S. Commissioner of SSA Authority

Submitter does Not volunteer His sovereign Constitutional rights to Commissioner. Under the Constitution for the United States of America public servants' actions ignoring Submitter Sovereign's order for rescission of the SSA association are criminal behaviors imposed without right against Submitter's sovereign rights of choice for rescission of and non-association with the SSA.

Commissioner Acquiesced by Inaction upon Sovereign's demand

NO response is acquiescence in the Default of Notice and Demand. Further, No acknowledgment by Commissioner of Submitter's sovereign authority to command rescission of the SSA association is a direct violation of Commissioner's Constitutional obligation to the People of the United States of America. Thus, you are in Dishonor.

Thus, the Commissioner's inaction after Submitter's sovereign demand:
breached Commissioner's sworn Constitutional duty;
failed stated administrative regulations governing Commissioner's actions; and,
violated Submitter's sovereign constitutional rights of choice.

As Commissioner's behavior is plainly un-Constitutional your dysfunction should not be enabled because:

Submitter is a Sovereign private human being

Submitter is a Sovereign Citizen under the Constitution for the United States of America. As such, Submitter prohibits future record keeping of this Submitter, Darrell James, Hill, the private human being, in Commissioner's governmental and/or other associated databases as anything other than a Sovereign Citizen under the Constitution for the United States of America in the Constitutional sense.

Submitter does Not relinquish His Sovereignty to the Commissioner

Because of the Amendment X to the Constitution for the United States of America, the federal United States government has no authority and cannot assume authority over the People.

*"The powers not delegated to the United States by the Constitution, nor prohibited by it to the States, are reserved to the States respectively, or to the people."
[Constitution for the United States of America, Amendment X]*

Sovereignty is a natural right which cannot lawfully be relinquished involuntarily. Any removal of sovereignty must be accomplished voluntarily by the Submitter: Government powers may not reach beyond that which is constitutionally granted. Thus, in order for the "United States" government to vicariously subject Submitter to its law(s) it is necessary for Submitter to relinquish sovereignty to the "United States" government. Since 2006 the SSA association has been INVOLUNTARY, compelled in this instance by the Commissioner's disobedience of Submitter's Sovereign Choice.

Commissioner's strict compliance with Sovereign's rescission order was demanded

Upon receipt of Notice and Demand for the rescission of the SSA association, you were thereby immediately obligated to: 1) correct Submitter's all association, history and "Numident" consistent with Submitter's Non-SSA association determination; 2) provide documentation of (i) your strict compliance with Submitter's rescission order (ii) noting that it was effective as of the date of original order of rescission (May 2006).

Commissioner has Not had Nor has now authority to disobey Submitter's Order of Rescission

Commissioner has not had and still yet has No Constitutional authority, presumed or assumable, to disobey Submitter's order of rescission of the SSA association. **Submitter Sovereign herein**

2022-011769 MISC Page: 123 of 2782
09/26/2022 03:35:37 PM Receipt #: 22-9381
Rec Fee: \$30.00 Darrell James Hill
Gila County, AZ, Sadie Jo Bingham, Recorder

DOC# 360413
10/02/2022 09:54 AM Page: 5 of 23
AFF R \$10.00 J. C. Sloan, McKinley County

2/23

Darrell James, Hill: 28 Hilltop Court, HC 61, Box 771, Ramah, New Mex.

USPO RMN: USPO RMN: RE 430 969 426 US

decrees you to comply. Submitter does not ask you to function within the confines of the Constitution for the United States of America; your service is only to comply!

Remainder of Intentionally Left Blank

Unofficial Copy

2124

USPO RMN: USPO RMN: RE 430 969 426 U

2022-011769 MISC Page: 124 of 2782
09/26/2022 09:35:37 PM Receipt #: 22-9381
Rec Fee: \$30.00 Darrell James Hill
Gila County, Az, Sadie Jo Bingham, Recorder



DOC# 360413

09/26/2022 09:54 AM Page: 6 of 23
REC.FEE: \$10.00 J. C. Sloan, McKinley County

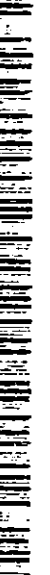

Sovereign Decree

Because the Commissioner dishonors his office before the lawful order from Darrell James, Hill, a sovereign Citizen of the United States of America, by:

- (a)
 - (1) denial of Constitutional compliance to Submitter's order;
 - (2) disobeying rescission order of all SSA association: and, that

(b) upon all prima facie evidence herein, that Sovereign:

- (1) made known the order to the United States Commissioner of SSA;
- (2) noticed, demanded and severally made known the demand to the United States SSA Commissioner's attention so that Commissioner knew or should have known Submitter's Command,

Submitter confirms final compliance with all Constitutional requirements to sever the SSA association. Therefore,

Submitter Sovereign Constitutionally demands:

- 1) immediate elimination of all SSA association; and,
- 2) Commissioner will immediately provide Submitter written compliance with Sovereign's decree, effective to the date of Submitter's order of first filing, to wit, May 2006.

Submitter's Signature, Sovereign Romero-Hill Beverly Jean

NOTARY PUBLIC CERTIFICATION

BEFORE ME, the undersigned authority, a Notary Public, of the County of CIBOLA, Republic

of NM (statename), this 31st day of Aug, 2012.

the above signed human being did appear and was identified by (circle one): driver's license / passport / other and who, upon first being duly sworn and/or affirmed, deposes and says that the foregoing asseveration is true to the best of his knowledge and belief.

I certify under PENALTY OF PERJURY under the laws of the State of NM that the foregoing paragraph is true and correct.

WITNESS my hand and official seal.

Notary Public

Seal

My Commission Expires On: 9-11-14



26125

2022-011769 MISC Page: 125 of 2782
09/26/2022 03:35:37 PM Receipt #: 22-9381
Rec Fee: \$30.00 Darrell James Hill
Gila County, Az, Sadie Jo Bingham, Recorder

DOC# 360413

10.02.2012 09.54 AM Page 7 of 23
PFF # 310.00 J. C. Sloan, McKinley County

AFFIDAVIT

Commissioner John J. Astrue,
c/o President Barack Hussein Obama
Office of Commissioner
Social Security Administration
6401 Security Blvd.
Baltimore, MD 21235

NOTICE OF DEFAULT

You are in Default of Notice and Demand:

This document is the service of Notice of Default upon you Commissioner Astrue, et al., (Commissioner) of the Social Security Administration (SSA) for dishonor upon the demand and all prior notice of same from Beverly Jean, Romero-Hill, (Submitter) to rescind all SSA association as ordered, noticed and demanded.

Beverly Jean, Romero-Hill:

Submitter is an American citizen, a private human being born within the states of the Union of States of America. Submitter is Not a "U.S. Citizen", "person", "individual", "resident", or "etc." other terms of the municipal, administrative law and adhesion contract(s) of the "United States"; Rather, Submitter is a non-volunteer of same.

I, Beverly Jean, Romero-Hill, have settled my belief and place all my trust in God Almighty, the Torah God of Abraham, Isaac and Jacob, YHVH to protect and provide for me forever, now and hereafter. All I have ever needed is manifested through Him. This fact is my experience, understanding, my religious choice of Sovereign right, and not alienable under the Constitution for the United States of America. No other guarantor, specifically the United States SSA, is necessary or needed as I decided in May of 2006, the date of the ORIGINAL Order of Rescission received by the SSA association, et seq. See Since 2006 the Commissioner has ignored Submitter's determination (below).

Since 2006 the Commissioner has ignored Submitter's determination:

1. See Judges Order in United States of America v. Beverly J. Hill, and Darrell J. Hill, individually, et al., No. CV 05-877-PHX-DGC permanently enjoined Submitter from any involvement in any way for filing or assisting in filing of any tax return for any "person or entity other than themselves." Submitter is not a "person" or and "entity". As the self, Submitter is an American Citizen under the Constitution for the United States of America, Not a "U.S. Citizen", etc. as determined above.
2. Administrative Demand For Rescission of SSA association was filed in May 22, 2006, at the local SSA office, evidence of which was sent broadly then filed into the public record in Gila County Arizona, Doc. Id. 2006-008774.

U.S. Commissioner of SSA Authority

Submitter does Not volunteer Her sovereign Constitutional rights to Commissioner. Under the Constitution for the United States of America public servants' actions ignoring Submitter Sovereign's order for rescission of the SSA association are criminal behaviors imposed without right against Submitter's sovereign rights of choice for rescission of and non-association with the SSA.

Commissioner Acquiesced by Inaction upon Sovereign's demand

726

2022-011769 MISC Page: 126 of 2782
09/26/2022 09:35:37 PM Receipt #: 22-9381

Rec Fee: \$90.00 Darrell James Hill, Recorder
Gila County, Az, Sadie Jo Bingham, Recorder

DOCH 360413

01/02/2012 09 54 AM Page 8 of 23
REC F, SIC CO J, C Sloan, McKinley County

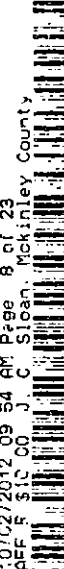
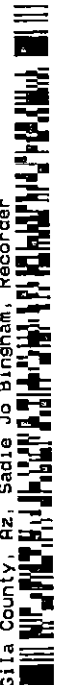

Beverly Jean, Romero-Hill: 28 Hilltop Court, HC 61, Box 771, Ramah, New Mex.

USPO RMN: RE 430 969 426 US

NO response is acquiescence in the Default of Notice and Demand. Further, No acknowledgment by Commissioner of Submitter's sovereign authority to command rescission of the SSA association is a direct violation of Commissioner's Constitutional obligation to the People of the United States of America. Thus, you are in Dishonor.

Thus, the Commissioner's inaction after Submitter's sovereign demand:
Breached Commissioner's sworn Constitutional duty;
Failed stated administrative regulations governing Commissioner's actions; and,
Violated Submitter's sovereign constitutional rights of choice.

As Commissioner's behavior is plainly un-Constitutional your dysfunction should not be enabled because:

Submitter is a Sovereign private human being

Submitter is a Sovereign Citizen under the Constitution for the United States of America. As such, Submitter prohibits future record keeping of this Submitter, Beverly Jean, Romero-Hill, the private human being, in Commissioner's governmental and/or other associated databases as anything other than a Sovereign Citizen under the Constitution for the United States of America in the Constitutional sense.

Submitter does Not relinquish Her Sovereignty to the Commissioner

Because of the Amendment X to the Constitution for the United States of America, the federal United States government has no authority and cannot assume authority over the People.

*"The powers not delegated to the United States by the Constitution, nor prohibited by it to the States, are reserved to the States respectively, or to the people."
[Constitution for the United States of America, Amendment X]*

Sovereignty is a natural right which cannot lawfully be relinquished involuntarily. Any removal of sovereignty must be accomplished voluntarily by the Submitter. Government powers may not reach beyond that which is constitutionally granted. Thus, in order for the "United States" government to vicariously subject Submitter to its law(s) it is necessary for Submitter to relinquish sovereignty to the "United States" government. Since 2006 the SSA association has been INVOLUNTARY, compelled in this instance by the Commissioner's disobedience of Submitter's Sovereign Choice.

Commissioner's strict compliance with Sovereign's rescission order was demanded

Upon receipt of Notice and Demand for the rescission of the SSA association, you were thereby immediately obligated to: 1) correct Submitter's all association, history and "Numident" consistent with Submitter's Non-SSA association determination; 2) provide documentation of (i) your strict compliance with Submitter's rescission order (ii) noting that it was effective as of the date of original order of rescission (May 2006).

Commissioner has Not had Nor has now authority to disobey Submitter's Order of Rescission

Commissioner has not had and still yet has No Constitutional authority, presumed or assumable, to disobey Submitter's order of rescission of the SSA association. **Submitter Sovereign herein decrees you to comply.** Submitter does not ask you to function within the confines of the Constitution for the United States of America; your service is only to comply!

Remainder of Intentionally Left Blank

AFFIDAVIT: Notice of Default upon Commissior

USPO RMN: USPO RMN: RE 430 969 426 U

2022-011769 MISC Page: 127 of 2782

09/26/2022 03:35:37 PM Receipt #: 22-9381
Rec Fee: \$30.00 Darrell James Hill
Gila County, Az, Sadie Jo Bingham, Recorder



10/02/2022 05:54 AM Page: 9 of 23
Clerk: Susan McKinley County
www.jc0413

3197

Sovereign Decree

Because the Commissioner dishonors his office before the lawful order from Beverly Jean, Romero-Hill, a sovereign Citizen of the United States of America, by:

- (a)
 - (1) denial of Constitutional compliance to Submitter's order;
 - (2) disobeying rescission order of all SSA association: and, that

- (b) upon all prima facie evidence herein, that Sovereign:
 - (1) made known the order to the United States Commissioner of SSA;
 - (2) noticed, demanded and severally made known the demand to the United States SSA Commissioner's attention so that Commissioner knew or should have known Submitter's Command,

Submitter confirms final compliance with all Constitutional requirements to sever the SSA association. Therefore,

Submitter Sovereign Constitutionally demands:

- 1) immediate elimination of all SSA association; and,
- 2) Commissioner will immediately provide Submitter written compliance with Sovereign's decree, effective to the date of Submitter's order of first filing, to wit, May 2006.

Beverly Jean Romero Hill
 Submitter's Signature, Sovereign Romero-Hill Beverly Jean

NOTARY PUBLIC CERTIFICATION

BEFORE ME, the undersigned authority, a Notary Public, of the County of Gila, Republic of NM (statename), this 31st day of Aug, 2012

the above signed human being did appear and was identified by (circle one): driver's license / passport / other and who, upon first being duly sworn and/or affirmed, deposes and says that the foregoing asseveration is true to the best of her knowledge and belief.

I certify under PENALTY OF PERJURY under the laws of the state of NM that the foregoing paragraph is true and correct.

WITNESS my hand and official seal.

Alan Lewis
 Notary Public Seal

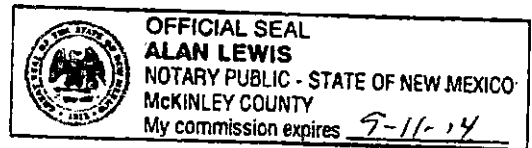

My Commission Expires On: 9-11-14

AFFIDAVIT: Notice of Default upon Commissioner Astru

USPO RMN: USPO RMN: RE 430 969 426 US

2022-011769 MISC Page: 128 of 2782

09/26/2022 03:35:37 PM Receipt #: 22-9381
 Rec Fee: \$30.00 Darrell James Hill
 Gila County, Az, Sadie Jo Bingham, Recorder



10/02/2012 09:54 AM Page 10 of 23
 REC R/S-0.00 J. C. Sloan McKinley County
 DOC# 360413

128

RE 430 969 426 US

Postage Stamp

To Be Completed By Post Office	Reg. Fee	10.95	
	Handling Charge		Return Receipt
	Postage	1.10	Restricted Delivery
	Received by		

AUG 31 2012

Customer Must Declare Full Value \$ 0 Domestic Insurance up to \$25,000 is included based upon the declared value. International Indemnity is limited. (See Reverse).

OFFICIAL USE

To Be Completed By Customer (Please Print) All Entries Must Be In Fullpoint or Typed	FROM	Darrell James Hill 28 Hilltop Court Hilltop Box 771 Barah, New Mexico 87321
	TO	President Barack Obama The White House 1600 Pennsylvania Ave Washington DC 20500

PS Form 3806, Receipt for Registered Mail Copy 1 - Customer
May 2007 (7530-02-000-9051) (See Information on Reverse)

Unofficial

3/29

2022-011769 MISC Page: 129 of 2782
 09/26/2022 03:35:37 PM Receipt #: 22-9381
 Rec Fee: \$30.00 Darrell James Hill
 Gila County, Az, Sadie Jo Bingham, Recorder



DOCH 360413
 10/02/2012 09:54 AM Page: 11 of 23
 AFF R-110 00 J C. Sloan, McKinley County

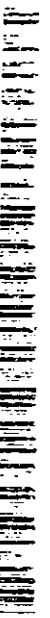

English

Customer Service

USPS Mobile

Register / Sign In



Search USPS.com or Track Packages

Quick Tools

Ship a Package

Send Mail

Manage Your Mail

Shop

Business Solutions

Track & Confirm

GET EMAIL UPDATES PRINT DETAILS

YOUR LABEL NUMBER

RE430969426US

SERVICE

First-Class Mail®

STATUS OF YOUR ITEM

Delivered

DATE & TIME

September 13, 2012, 4:23 am

LOCATION

WASHINGTON, DC 20500

FEATURES

Expected Delivery By:
September 4, 2012
Registered Mail™

Arrival at Unit

September 09, 2012, 4:36 am

WASHINGTON, DC 20066

Processed at USPS
Origin Sort Facility

August 31, 2012, 12:21 pm

RAMAH, NM 87321

Acceptance

August 31, 2012, 12:20 pm

RAMAH, NM 87321

Check on Another Item

What's your label (or receipt) number?

Find

LEGAL

- Privacy Policy ›
- Terms of Use ›
- FOIA ›
- No FEAR Act EEO Data ›

ON USPS.COM

- Government Services ›
- Buy Stamps & Shop ›
- Print a Label with Postage ›
- Customer Service ›
- Site Index ›

ON ABOUT.USPS.COM

- About USPS Home ›
- Newsroom ›
- Mail Service Updates ›
- Forms & Publications ›
- Careers ›

OTHER USPS SITES

- Business Customer Gateway ›
- Postal Inspectors ›
- Inspector General ›
- Postal Explorer ›

Copyright © 2012 USPS. All Rights Reserved.

Unofficial Copy

2022-011769 MISC Page: 130 of 2782

09/26/2022 09:35:37 PM Receipt #: 22-9381

Rec Fee: \$30.00 Darrell James Hill
Gila County, Az, Sadie Jo Bingham, Recorder



DOCH 360413

10/02/2012 09:54 AM Page 12 of 23
AFF R \$10.00 J. C. Sloan, McKinley County



Affidavit

Unofficial Copy

ENCLOSURE: B

2022-011769 MISC Page: 131 of 2782
09/26/2022 03:35:37 PM Receipt #: 22-9381
Rec Fee: \$30.00 Darrell James Hill
Gila County, Az, Sadie Jo Bingham, Recorder



DOCH 360413

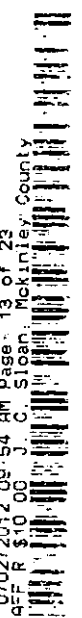

10/02/2012 09:54 AM Page 13 of 23
AFF R \$10.00 J. C. Sloan, McKinley County

ENCLOSURE: B

7/31

Darrell James, Hill; Beverly Jean, Romero-Hill:
28 Hilltop Court, HC 61 Box 771, Ramah, New Mex.

USPO CMN: 7009 2820 0003 8851 615

Commissioner John J. Astrue,
Office of Commissioner
Social Security Administration
6401 Security Blvd.
Baltimore, MD 21235

RE: Affidavits (2): Notices of Default

Dear Commissioner Astrue;

The Hills, Darrell James (husband), and Beverly Jean, Romero- (wife), wrote and sent to you c/o President Barack Hussein Obama two affidavits by USPS registered mail (RE 430 969 426 US; received September 13, 2012). See "Affidavit: Notice of Default, from husband (4 pages) and Affidavit: Notice of Default from wife (3 pages)", enclosed.

The Affidavits are Constitutional decrees that compel your attention and direct your compliance in achieving the duties in completion of May 2006 orders for the absolute rescissions of all SSA association(s) as noticed, demanded, and defaulted upon by you.

You no doubt may have a busy position, so understand that these People chose to Not be associated with the SSA, et.al, system in 2006 (a fact you have repeatedly ignored). Thus, you have been commanded in the two Constitutional decrees by these People to straightaway i) comply with the severance of all SSA association as ordered and ii) report your compliance of same to each Constitutional Sovereign, Darrell James, Hill (husband); and, Beverly Jean, Romero-Hill (wife).

Commissioner, Your hands-on determination to get these firm orders promptly fulfilled is required; your expedience would be greatly appreciated. (You can execute this order in moments; please do so sir.)

Sincerely:

Sept 18, 2012
Darrell James Hill (husband)
Sovereign Citizen of the United States of America

9/18/2012
Beverly Jean, Romero-Hill (wife)
Sovereign Citizen of the United States of America

Enclosure: Affidavit: Notice of Default, sent to Commissioner of SSA from husband (4 pages);
Affidavit: Notice of Default, sent to Commissioner of SSA from wife (3 pages)

732

2022-011769 MISC Page: 132 of 2782
09/26/2022 03:35:37 PM Receipt #: 22-9381
Rec Fee: \$0.00 Darrell James Hill
Gila County, AZ; Sadie Jo Bingham, Recorder

DOCH 360413

10/02/2012 09:54 AM Page 14 of 23
AFF R \$10.00 J C Sloan McKinley County

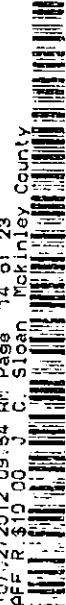
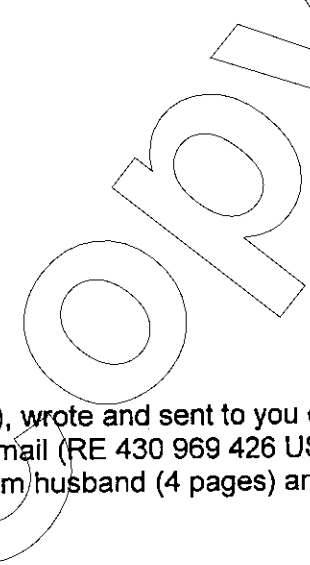
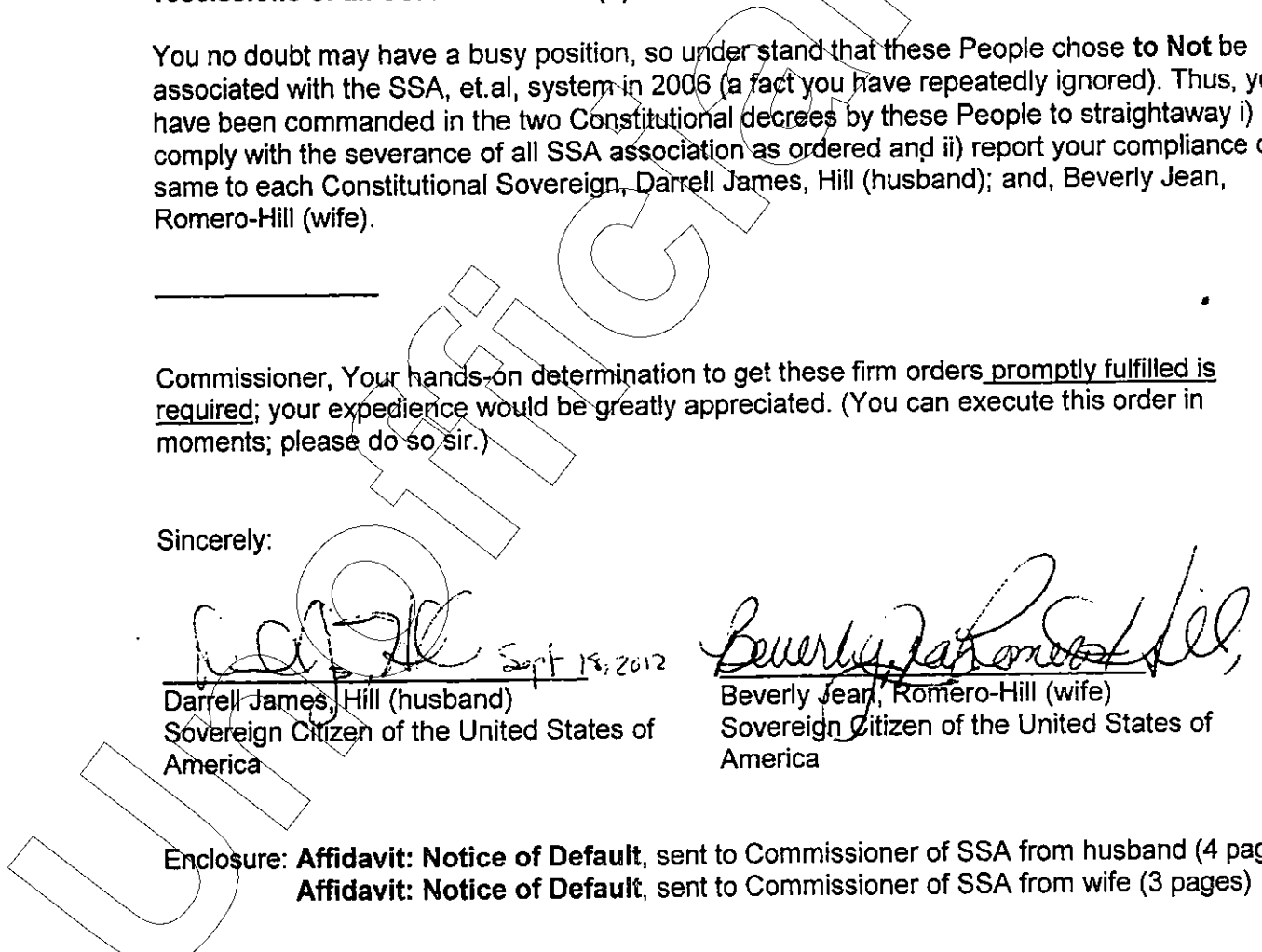

AFFIDAVIT

Commissioner John J. Astrue,
c/o President Barack Hussein Obama
Office of Commissioner
Social Security Administration
6401 Security Blvd.
Baltimore, MD 21235

NOTICE OF DEFAULT

You are in Default of Notice and Demand:

this document is the service of Notice of Default upon you Commissioner Astrue, et al., (Commissioner) of the Social Security Administration (SSA) for dishonor upon the demand and all prior notices of same from Darrell James, Hill, (Submitter) to rescind all SSA association as ordered, noticed and demanded.

Darrell James, Hill:

Submitter is an American citizen, a private human being born within the states of the Union of States of America. Submitter is Not a "U.S. Citizen", "person", "individual", "resident", "entity", or "etc." other terms of the municipal, administrative law and adhesion contract(s) of the "United States"; Rather, Submitter is a non-volunteer of same.

I, Darrell James, Hill, have settled my belief and place all my trust in God Almighty, the Torah God of Abraham, Isaac and Jacob, YHVH to protect and provide for me forever, now and hereafter. All I have ever needed is manifested through Him. This fact is my experience, understanding, my religious choice of Sovereign right, and not alienable under the Constitution for the United States of America. No other guarantor, specifically the United States SSA, is necessary or needed as I decided in May of 2006, the date of the ORIGINAL Order of Rescission received by the SSA association, et seq. See Since 2006 the Commissioner has ignored Submitter's determination (below).

Since 2006 the Commissioner has ignored Submitter's determination:

1. See Judges: Order in United States of America v. Beverly J. Hill, and Darrell J. Hill, individually, et al., No. CV 05-877-PHX-DGC permanently enjoined Submitter from any involvement in any way for filing or assisting in filing of any tax return for any "person or entity other than themselves." Submitter is not a "person" or and "entity". As the self, Submitter is an American Citizen under the Constitution for the United States of America, Not a "U.S. Citizen", etc. as determined above.
2. Administrative Demand For Rescission of SSA association was filed in May 22, 2006, at the local SSA office, evidence of which was sent broadly then filed into the public record in Gila County Arizona, Doc. Id. 2006-008777
3. Multiple Demand For Rescission of SSA association was sent and received by Commissioner by USPO Registered Mail RA 337 238 865 US in September 2009.
4. See 2009 Case: 2:09 CV-01956-DGC Darrell Hill v Premier Healthcare Services: Commissioner of SSA is codefendant. Rescission information is Placed in Docket 1, Exhibits.
5. See 2009 Case 2:09 CV-01957-MHM Darrell Hill v DNA Medical Staffing, LLC: Commissioner of SSA is codefendant. Rescission information is Placed in Docket 1, Exhibits.

2022-011769 MISC Page: 133 of 2782
09/26/2022 03:35:37 PM Receipt #: 22-9381
Rec Fee: \$30.00 Darrell James Hill
Gila County, Az, Sadie Jo Bingham, Recorder

303

DOCA 360413

10/02/2012 09:54 AM Page: 15 of 23
AFF R \$10.00 J. C. Sloan, McKinley County

6 See 2009 Case:2:09 CV-01958-JAT Darrell Hill v Promise Hospital of Phoenix, Inc.:
Commissioner of SSA is codefendant. Rescission information is Placed in Docket 1, Exhibits.

U.S. Commissioner of SSA Authority

Submitter does Not volunteer His sovereign Constitutional rights to Commissioner. Under the Constitution for the United States of America public servants' actions ignoring Submitter Sovereign's order for rescission of the SSA association are criminal behaviors imposed without right against Submitter's sovereign rights of choice for rescission of and non-association with the SSA.

Commissioner Acquiesced by Inaction upon Sovereign's demand

NO response is acquiescence in the Default of Notice and Demand. Further, No acknowledgment by Commissioner of Submitter's sovereign authority to command rescission of the SSA association is a direct violation of Commissioner's Constitutional obligation to the People of the United States of America. Thus, you are in Dishonor.

Thus, the Commissioner's inaction after Submitter's sovereign demand:
Breached Commissioner's sworn Constitutional duty;
Failed stated administrative regulations governing Commissioner's actions; and,
Violated Submitter's sovereign constitutional rights of choice.

As Commissioner's behavior is plainly un-Constitutional your dysfunction should not be enabled because:

Submitter is a Sovereign private human being

Submitter is a Sovereign Citizen under the Constitution for the United States of America. As such, Submitter prohibits future record keeping of this Submitter, Darrell James, Hill, the private human being, in Commissioner's governmental and/or other associated databases as anything other than a Sovereign Citizen under the Constitution for the United States of America in the Constitutional sense.

Submitter does Not relinquish His Sovereignty to the Commissioner

Because of the Amendment X to the Constitution for the United States of America, the federal United States government has no authority and cannot assume authority over the People.

*"The powers not delegated to the United States by the Constitution, nor prohibited by it to the States, are reserved to the States respectively, or to the people."
[Constitution for the United States of America, Amendment X]*

Sovereignty is a natural right which cannot lawfully be relinquished involuntarily. Any removal of sovereignty must be accomplished voluntarily by the Submitter. Government powers may not reach beyond that which is constitutionally granted. Thus, in order for the "United States" government to vicariously subject Submitter to its law(s) it is necessary for Submitter to relinquish sovereignty to the "United States" government. Since 2006 the SSA association has been INVOLUNTARY, compelled in this instance by the Commissioner's disobedience of Submitter's Sovereign Choice.

Commissioner's strict compliance with Sovereign's rescission order was demanded

Upon receipt of Notice and Demand for the rescission of the SSA association, you were thereby immediately obligated to: 1) correct Submitter's all association, history and "Numident" consistent with Submitter's Non-SSA association determination; 2) provide documentation of (i) your strict compliance with Submitter's rescission order (ii) noting that it was effective as of the date of original order of rescission (May 2006).

Commissioner has Not had Nor has now authority to disobey Submitter's Order of Rescission

Commissioner has not had and still yet has No Constitutional authority, presumed or assumable, to disobey Submitter's order of rescission of the SSA association. **Submitter Sovereign herein**



DOCH 360413

09/26/2022 03:35:37 PM Page 16 of 23
Rec Fee: \$30.00 J. C. Sloan, McKinley County

734

Darrell James, Hill: 28:Hilltop Court, HC 61, Box 771, Ramah, New Mex.

USPO RMN: USPO RMN: RE 430 969 426 US

decrees you to comply. Submitter does not ask you to function within the confines of the Constitution for the United States of America; your service is only to comply!

Remainder of Intentionally Left Blank

Unofficial Copy

2022-011769 MISC Page: 135 of 2782
09/26/2022 03:35:37 PM Receipt #: 22-9381
Rec Fee: \$30.00 Darrell James Hill
Gila County, Az, Sadie Jo Bingham, Recorder



DOCH 360413

12/22 2022 05 54 AM Page: 17 of 23
REC \$10.00 J C Sloan McKinley County

136

USPO RMN: USPO RMN: RE 430 969 426 US

3 of 4

Sovereign Decree

Because the Commissioner dishonors his office before the lawful order from Darrell James, Hill, a sovereign Citizen of the United States of America, by,

- (a)
 - (1) denial of Constitutional compliance to Submitter's order;
 - (2) disobeying rescission order of all SSA association: and, that

- (b) upon all prima facie evidence herein. that Sovereign.
 - (1) made known the order to the United States Commissioner of SSA;
 - (2) noticed, demanded and severally made known the demand to the United States SSA Commissioner's attention so that Commissioner knew or should have known Submitter's Command,

Submitter confirms final compliance with all Constitutional requirements to sever the SSA association. Therefore,

Submitter Sovereign Constitutionally demands:

- 1) immediate elimination of all SSA association; and,
- 2) Commissioner will immediately provide Submitter written compliance with Sovereign's decree, effective to the date of Submitter's order of first filing, to wit, May 2006.

Submitter's Signature, Sovereign Romero-Hill Beverly Jean

NOTARY PUBLIC CERTIFICATION

BEFORE ME, the undersigned authority, a Notary Public, of the County of CIBOLA, Republic of NM (statename), this 31st day of Aug, 2012,

the above signed human being did appear and was identified by (circle one): driver's license /passport / other and who, upon first being duly sworn and/or affirmed, deposes and says that the foregoing asseveration is true to the best of his knowledge and belief.

I certify under PENALTY OF PERJURY under the laws of the State of NM that the foregoing paragraph is true and correct.

WITNESS my hand and official seal.

Alan Lewis Seal
Notary Public

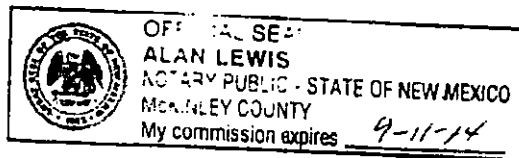

My Commission Expires On: 9-11-14

2022-011769 MISC Page: 136 of 2782

09/25/2022 03:35:37 PM Receipt #: 22-9381
Recd Fee: \$30.00 Darrell James Hill
Gila County, AZ, Sadie Jo Bingham, Recorder

DOC# 360413
09/25/2022 09:54 AM Page: 18 of 23
REC'D SO CO J C Sloan McKinley County

137

Sovereign Decree

Because the Commissioner dishonors his office before the lawful order from Beverly Jean, Romero-Hill, a sovereign Citizen of the United States of America. by:

- (a)
 - (1) denial of Constitutional compliance to Submitter's order;
 - (2) disobeying rescission order of all SSA association: and, that
- (b) upon all prima facie evidence herein, that Sovereign:
 - (1) made known the order to the United States Commissioner of SSA;
 - (2) noticed, demanded and severally made known the demand to the United States SSA Commissioner's attention so that Commissioner knew or should have known Submitter's Command.

Submitter confirms final compliance with all Constitutional requirements to sever the SSA association. Therefore,

Submitter Sovereign Constitutionally demands:

- 1) immediate elimination of all SSA association; and,
- 2) Commissioner will immediately provide Submitter written compliance with Sovereign's decree, effective to the date of Submitter's order of first filing, to wit, May 2006.

Beverly Jean Romero Hill
 Submitter's Signature, Sovereign Romero-Hill Beverly Jean

NOTARY PUBLIC CERTIFICATION

BEFORE ME, the undersigned authority, a Notary Public, of the County of CIBOLA, Republic of NA (statename), this 31ST day of Aug, 2012,

the above signed human being did appear and was identified by (circle one): driver's license /passport / other and who, upon first being duly sworn and/or affirmed, deposes and says that the foregoing asseveration is true to the best of her knowledge and belief.

I certify under PENALTY OF PERJURY under the laws of the state of NA that the foregoing paragraph is true and correct.

WITNESS my hand and official seal.

Alan Lewis
 _____ Seal
 Notary Public



My Commission Expires On: 9-11-14

140

2022-011769 MISC Page: 137 of 2782

09/26/2022 03:35:37 PM Receipt #: 22-9381
 Rec Fee: \$30.00 Darrell James Hill
 Gila County, Az, Sadie Jo Bingham, Recorder

DOCH 360413

10/02/2012 05:54 AM Page: 21 of 23
 REC F 2.0 00 J. C. Stone, McKinley County

U.S. Postal Service
CERTIFIED MAIL™ RECEIPT
 (Domestic Mail Only; No Insurance Coverage Provided)

For delivery information visit our website at www.usps.com

OFFICIAL USE

5519 1598 8851 6155
 2820 0003 8851 6155
 7009 2820 0003 8851 6155

Postage	\$ 1.30
Certified Fee	2.95
Return Receipt Fee (Endorsement Required)	2.35
Restricted Delivery Fee (Endorsement Required)	
Total Postage & Fees	\$ 6.60

Postmark
 19
 2012

Sent To: **Commissioner John J. Astrue,**
 Office of Commissioner
 Social Security Administration
 6401 Security Blvd.
 Baltimore, MD 21235

PS Form 3800, August 2006

See Reverse for Instructions

SENDER: COMPLETE THIS SECTION

- Complete items 1, 2, and 3. Also complete item 4 if Restricted Delivery is desired.
- Print your name and address on the reverse so that we can return the card to you.
- Attach this card to the back of the mailpiece, or on the front if space permits.

1. Article Addressed to:

Commissioner John J. Astrue,
 Office of Commissioner
 Social Security Administration
 6401 Security Blvd.
 Baltimore, MD 21235

2. Article Number
 (Transfer from service label)

7009 2820 0003 8851 6155

PS Form 3811, February 2004

Domestic Return Receipt

102595-02-10-1500

COMPLETE THIS SECTION ON DELIVERY

A. Signature: **JOHN J. ASTRUE** Agent
 Addressee

B. Received by (Printed Name): **JOHN J. ASTRUE** C. Date of Delivery: **SEP 21 2012**

D. Is delivery address different from item 1? Yes
 If YES, enter delivery address below: No

3. Service Type
 Certified Mail Express Mail
 Registered Return Receipt for Merchandise
 Insured Mail C.O.D.

4. Restricted Delivery? (Extra Fee) Yes

UNITED STATES POSTAL SERVICE



First-Class Mail
 Postage & Fees Paid
 USPS
 Permit No. G-10

• Sender: Please print your name, address, and ZIP+4 in this box •

Hill Darrell James
Romero-Hill Beverly Jean
 28 Hilltop Court
 HC 61, Box 771
 Ramah, N. Mex. 87321

2022-011769 MISC Page: 138 of 2782

09/26/2022 03:35:37 PM Receipt #: 22-9381

Rec Fee: \$30.00 Darrell James Hill

Gila County, Az, Sadie Jo Bingham, Recorder



DOCH 360413

19/01/2012 09:54 AM Page: 22 of 23
 AFF P: \$0.00 J. C. Sloan, Pinal County
 Gila County, Arizona

English

Customer Service

USPS Mobile

Register / Sign In



Search USPS.com or Track Packages

Quick Tools

Ship a Package

Send Mail

Manage Your Mail

Shop

Business Solutions

Track & Confirm

GET EMAIL UPDATES

PRINT DETAILS

YOUR LABEL NUMBER

70092820000388516165

SERVICE

First-Class Mail®

STATUS OF YOUR ITEM

Delivered

DATE & TIME

September 21, 2012, 8:02 am

LOCATION

BALTIMORE, MD 21241

FEATURES

Expected Delivery By:
September 21, 2012
Certified Mail™

Notice Left (No Authorized Recipient Available)

September 21, 2012, 8:02 am

BALTIMORE, MD 21235

Arrival at Unit

September 21, 2012, 7:11 am

BALTIMORE, MD 21203

Acceptance

September 18, 2012, 11:16 am

RAMAH, NM 87321

Check on Another Item

What's your label (or receipt) number?

Find

LEGAL

- Privacy Policy ›
- Terms of Use ›
- FOIA ›
- No FEAR Act EEO Data ›

ON USPS.COM

- Government Services ›
- Buy Stamps & Shop ›
- Print a Label with Postage ›
- Customer Service ›
- Site Index ›

ON ABOUT.USPS.COM

- About USPS Home ›
- Newsroom ›
- Mail Service Updates ›
- Forms & Publications ›
- Careers ›

OTHER USPS SITES

- Business Customer Gateway ›
- Postal Inspectors ›
- Inspector General ›
- Postal Explorer ›

Copyright © 2012 USPS. All Rights Reserved.



DOCH 362413

SEP 21 2012 09:54 AM Page: 23 of 23
REC \$10.00 C Stoen McKinley County

2022-011769 MISC Page: 139 of 2782
 09/26/2022 03:35:37 PM Receipt #: 22-9381
 Rec Fee: \$30.00 Darrell James Hill
 Gila County, Az, Sadie Jo Bingham, Recorder



9/28/2012 10:32 AM

Unofficial

142

NO response is acquiescence in the Default of Notice and Demand. Further, No acknowledgment by Commissioner of Submitter's sovereign authority to command rescission of the SSA association is a direct violation of Commissioner's Constitutional obligation to the People of the United States of America. Thus, you are in Dishonor.

Thus, the Commissioner's inaction after Submitter's sovereign demand:

- Breached Commissioner's sworn Constitutional duty;
- Failed stated administrative regulations governing Commissioner's actions; and,
- Violated Submitter's sovereign constitutional rights of choice.

As Commissioner's behavior is plainly un-Constitutional your dysfunction should not be enabled because:

Submitter is a Sovereign private human being

Submitter is a Sovereign Citizen under the Constitution for the United States of America. As such, Submitter prohibits future record keeping of this Submitter, Beverly Jean, Romero-Hill, the private human being, in Commissioner's governmental and/or other associated databases as anything other than a Sovereign Citizen under the Constitution for the United States of America in the Constitutional sense.

Submitter does Not relinquish Her Sovereignty to the Commissioner

Because of the Amendment X to the Constitution for the United States of America, the federal United States government has no authority and cannot assume authority over the People.

*"The powers not delegated to the United States by the Constitution, nor prohibited by it to the States, are reserved to the States respectively, or to the people."
[Constitution for the United States of America, Amendment X]*

Sovereignty is a natural right which cannot lawfully be relinquished involuntarily. Any removal of sovereignty must be accomplished voluntarily by the Submitter: Government powers may not reach beyond that which is constitutionally granted. Thus, in order for the "United States" government to vicariously subject Submitter to its law(s) it is necessary for Submitter to relinquish sovereignty to the "United States" government. Since 2006 the SSA association has been INVOLUNTARY, compelled in this instance by the Commissioner's disobedience of Submitter's Sovereign Choice.

Commissioner's strict compliance with Sovereign's rescission order was demanded

Upon receipt of Notice and Demand for the rescission of the SSA association, you were thereby immediately obligated to: 1) correct Submitter's all association, history and "Numident" consistent with Submitter's Non-SSA association determination; 2) provide documentation of (i) your strict compliance with Submitter's rescission order (ii) noting that it was effective as of the date of original order of rescission (May 2006).

Commissioner has Not had Nor has now authority to disobey Submitter's Order of Rescission

Commissioner has not had and still yet has No Constitutional authority, presumed or assumable, to disobey Submitter's order of rescission of the SSA association. **Submitter Sovereign herein decrees you to comply.** Submitter does not ask you to function within the confines of the Constitution for the United States of America; your service is only to comply!

Remainder of Intentionally Left Blank



133

AFFIDAVIT

Commissioner John J. Astrue,
c/o President Barack Hussein Obama
Office of Commissioner
Social Security Administration
6401 Security Blvd.
Baltimore, MD 21235

NOTICE OF DEFAULT

You are in Default of Notice and Demand:

This document is the service of Notice of Default upon you Commissioner Astrue, et al., (Commissioner) of the Social Security Administration (SSA) for dishonor upon the demand and all prior notice of same from Beverly Jean, Romero-Hill, (Submitter) to rescind all SSA association as ordered, noticed and demanded.

Beverly Jean, Romero-Hill:

Submitter is an American citizen, a private human being born within the states of the Union of States of America. Submitter is Not a "U.S. Citizen", "person", "individual", "resident", or "etc." other terms of the municipal, administrative law and adhesion contract(s) of the "United States"; Rather, Submitter is a non-volunteer of same.

I, Beverly Jean, Romero-Hill, have settled my belief and place all my trust in God Almighty, the Torah God of Abraham, Isaac and Jacob, YHWH to protect and provide for me forever, now and hereafter. All I have ever needed is manifested through Him. This fact is my experience, understanding, my religious choice of Sovereign right, and not alienable under the Constitution for the United States of America. No other guarantor, specifically the United States SSA, is necessary or needed as I decided in May of 2006, the date of the ORIGINAL Order of Rescission received by the SSA association, et seq. See Since 2006 the Commissioner has ignored Submitter's determination (below).

Since 2006 the Commissioner has ignored Submitter's determination:

1. See Judges Order in United States of America v. Beverly J. Hill, and Darrell J. Hill, individually, et al., No. CV 05-877-PHX-DGC permanently enjoined Submitter from any involvement in any way for filing or assisting in filing of any tax return for any "person or entity other than themselves." Submitter is not a "person" or and "entity". As the self, Submitter is an American Citizen under the Constitution for the United States of America, Not a "U.S. Citizen", etc. as determined above.
2. Administrative Demand For Rescission of SSA association was filed in May 22, 2006, at the local SSA office, evidence of which was sent broadly then filed into the public record in Gila County Arizona, Doc. Id. 2006-008774.

U.S. Commissioner of SSA Authority

Submitter does Not volunteer Her sovereign Constitutional rights to Commissioner. Under the Constitution for the United States of America public servants' actions ignoring Submitter Sovereign's order for rescission of the SSA association are criminal behaviors imposed without right against Submitter's sovereign rights of choice for rescission of and non-association with the SSA.

Commissioner Acquiesced by Inaction upon Sovereign's demand

AFFIDAVIT: Notice of Default upon Commissioner Astri

USPO RMN: USPO RMN: RE 430 969 426 US

2022-011769 MISC Page: 141 of 2782
09/26/2022 03:35:37 PM Receipt #: 22-9381
Rec Fee: \$30.00 Darrell James Hill
Gila County, Az. Sadie Jo Bingham, Recorder



DOC# 360413

09/26/2022 09:54 AM Page 19 of 23
\$10.00 Gila County, Arizona
Gila County, Arizona

138

:2013 A.D.

#	:man- trustee	:association	:year, :day	USPO, other	:covenant
1	:Susan-R.: Bolton	:Judge -USDC- Arizona; CV07-1292-Phx-SRB; Johnson v. AzHHA,	07/22/13	7009 1410 0000 7868 5673	:Darrell-James: Hill, -:Claimant- no. 000000930. :Request for Trustee Protection of -:beneficiary; Hill- Darrell-James ~Ohioan~.
2	:Mark: Samson	Keller- Rohback, P.L.C.	↓	↓	↓
3	:Ron: Kilgard		↓	↓	↓
4	:Mark-A.: Griffin	Keller- Rohback, L.L.P.	↓	↓	↓
5	:Raymond:A.: Farrow		↓	↓	↓
6	:David-F.: Sorensen	Berger & Montague, P.C.	↓	↓	↓
7	:David: Balto	Law Offices of David Balto	↓	↓	↓
8	:Martha-L.: Fitzgerald	:Brown Hyatt Farber Schreck LLP	↓	↓	↓
9	:Jeffrey-S.: Rugg	:Judge -USDC- Arizona; CV07-1292-Phx-SRB; Johnson v. AzHHA	↓	↓	Darrell-James: Hill, -:Claimant- no. 000000930. :Request for Trustee Protection of -:beneficiary; Hill- Darrell-James ~Ohioan~.
	:man- trustee	:association	:year, :day	USPO, other	:covenant
10	:Joe: Shirley, Jr.	Apache-County-Arizona-State, -:Bd- Supv.	07/26/13	7009 1410 0000 7868 5710	Requirement for unimpeded access to the public-record.



Handwritten initials

11	:Tom-M.: White, Jr.				
12	:Barry: Welter				
13	:Michael-B.: Whiting	Apache-County-Arizona-State, -:Attorney			
14	:Delwin-P.: Wengert	Apache-County-Arizona-State, -:Manager			Requirement for unimpeded access to the public-record.
	:man- trustee	:association	:year, :day	USPO, other	:covenant
15	:Susan-R.: Bolton	:Judge -USDC- Arizona; CV07- 1292-Phx-SRB; Johnson v. AzHHA, -:Doc. # 762.	07/26/13	CV07-1292-Phx-SRB; Johnson v. AzHHA, -:Doc. # 762.	DOI-1776-A.D., et al.: AOC-1778-A.D., :CftUSofA- 1787-A.D., -:Ohioan © -1958-A.D. -:exclusive- peculiar-absolute-owner; -:EBA-1933-A.D.- beneficiary.
16	:David-B.: Rosenbaum				
17	:Lawrence-Allen: Katz				
18	:Charles-Steven: Price				
19	:P.-Bruce: Converse				
20	:Andrew-L.: Pringle				
21	:James-R.: Broening				
22	:Mark-D.: Samson				
23	:James-A.: Craft				
24	:Barry-D.: Halpern				



487

25	:Ron: Kilgard	↓	↓	↓	↓
26	:Randall-S.: Yavitz	↓	↓	↓	↓
	:man- trustee		:association	USPO, other	:covenant
27	:Leigh-Eric: Dowell	↓	↓	↓	DOI-1776-A.D., et al.: AOC-1778-A.D., :CftUSofA-1787-A.D., -:Ohioan © -1958-A.D. -:exclusive-peculiar-absolute-owner; -:EBA-1933-A.D.- beneficiary.
28	:Joel-W.: Nomkin	↓	↓	↓	↓
29	:Keith: Beauchamp	↓	↓	↓	↓
30	:Richard-Kenneth: Delo	↓	↓	↓	↓
31	:Randall: Papetti	↓	↓	↓	↓
32	:Jeffrey-J.: Campbell	↓	↓	↓	↓
33	:Franklin-James: Hoover	↓	↓	↓	↓
34	:Jessica-Lee: Everett-Garcia	↓	↓	↓	↓
35	:Dan-W.: Goldfine	↓	↓	↓	↓
36	:Amy-N-L.: Hanson	↓	↓	↓	↓
37	:Lauren-Jacqueline: Weinzweig	↓	↓	↓	↓
38	:Jeffrey-A.: LeVee	↓	↓	↓	↓



145

39	:Robert-Thomas: Acuinias- Sullivan	↓	↓	↓	↓
40	:Michael-T.: Liburdi	↓	↓	↓	↓
41	:Scott-Sebastian: Minder	↓	↓	↓	DOI-1776-A.D., et al.: AOC-1778- A.D., :CftUSofA-1787-A.D., -:Ohioan © -1958- A.D. -:exclusive-peculiar-absolute-owner; -:EBA- 1933-A.D.- beneficiary.
42	:James-P.: McLoughlin, Jr.	↓	↓	↓	↓
	:man- trustee	:association	:year, :day	USPO, other	:covenant
43	:Brian-Michael: Flaherty	↓	↓	↓	↓
44	:David-A.: Ettinger	↓	↓	↓	↓
45	:Kerry-Scott: Martin	↓	↓	↓	↓
46	:Kami-S.: Galvani	↓	↓	↓	↓
47	:Jill-Louise: Ripke	↓	↓	↓	↓
48	:Katherine-I.: Funk	↓	↓	↓	↓
49	:David-F.: Sorensen	↓	↓	↓	↓
50	:Eric-L.: Cramer	↓	↓	↓	↓
51	:Barry-Steven: Taus	↓	↓	↓	↓
52	:David-P.: Smith	↓	↓	↓	↓



44

53	:W.-Ross: Foote	↓	↓	↓	↓
54	:David-A.: Balto	↓	↓	↓	↓
55	:Andrew-William: Kelly	↓	↓	↓	↓
56	:Roopali-H.: Desai	↓	↓	↓	↓
57	:Winthrop-Blackstone: Reed, III	↓	↓	↓	↓
58	:David-B: Helms	↓	↓	↓	↓
59	:Richard-B.: Walsh, Jr	↓	↓	↓	↓
	:man- trustee	:association	:year, :day	USPO, other	:covenant
60	:Allen-Spencer: Boston	↓	↓	↓	↓
61	:Stephen-Michael: Durbin	↓	↓	↓	↓
62	:Mark-A.: Griffin	↓	↓	↓	↓
63	:Raymond-J.: Farrow	↓	↓	↓	↓
64	:Benjamin-William: Reeves	↓	↓	↓	↓
65	:Joan: McPhee	↓	↓	↓	↓

DOI-1776-A.D., et al.: AOC-1778-A.D., :CftUSofA-1787-A.D., -:Ohioan © -1958-A.D. -:exclusive-peculiar-absolute-owner; -:EBA-1933-A.D.- beneficiary.



1471

66	:Tyler-Reese: Bowen	↓	↓		DOI-1776-A.D., et al.: AOC-1778-A.D., :CftUSofA-1787-A.D., -:Ohioan © -1958-A.D. -:exclusive-peculiar-absolute-owner; -:EBA-1933-A.D.- beneficiary.
----	---------------------	---	---	--	---

	:man- trustee		:association		:year, :day		USPO, other		:covenant
67	:Neill-Wilson: Clark		↓		↓		↓		↓
68	:Martha-L.: Fitzgerald		↓		↓		↓		↓
69	:Allen-P.: Grunes		↓		↓		↓		↓
70	:Jeffrey-S.: Rugg		↓		↓		↓		↓
71	:Timothy-R.: Beyer		↓		↓		↓		↓
72	:Shauna-B.: Itri		↓		↓		↓		↓
73	:Mark-J.: Horoschak		↓		↓		↓		↓
74	:Brian-A.: Hayles		↓		↓		↓		↓
75	:Jane-É.: Willis		↓		↓		↓		↓
76	:Matthew-P.: Garvey		↓		↓		↓		↓
76	:Penny-Hirsch: Edwards		↓		↓		↓		↓
77	:Tony-L.: Mitchell		↓		↓		↓		↓
	:man- trustee		:association		:year, :day		USPO, other		:covenant
78	:Debbie-Weston: Harden		↓		↓		↓		↓
79	:Catherine-T.: Broderick		↓		↓		↓		↓



Handwritten mark or signature in the bottom right corner.

80	:Dennis-D.: Palmer	:Judge -USDC- Arizona; CV07-1292-Phx-SRB; Johnson v. AzHHA, -:Doc. # 762.	07/26/13	CV07-1292-Phx-SRB; Johnson v. AzHHA, -:Doc. # 762.	DOI-1776-A.D., et al.: AOC-1778-A.D., :CftUSofA-1787-A.D., -:Ohioan © -1958-A.D. -:exclusive-peculiar-absolute-owner; -:EBA-1933-A.D.- beneficiary.
81	:Susan-R.: Bolton	:Judge -USDC- Arizona; CV07-1292-Phx-SRB; Johnson v. AzHHA,	07/31/13	7009 1410 0000 7868 5680	:Darrell-James: Hill, -:Claimant- no. 000000930. :Request for Trustee Protection of -:beneficiary; Hill- Darrell-James -Ohioan-. ;Failure of Trustee-Justice to comply: Restatement of Order.
82	:Susan-R.: Bolton	:Judge -USDC- Arizona; CV07-1292-Phx-SRB; Johnson v. AzHHA,	08/16/13	RE 817542 444 US	Re: Ailing Compliance of the Trustees: Statement of the Order.
83	:Joe: Shirley, Jr.	Apache-County-Arizona-State, -:Bd- Supv.	08/19/13	RB 898 807 997 US	Public-Record-Information-Request by the Beneficiaries of the Public-Trust
84	:Tom-M.: White, Jr.				
85	:Barry: Welter				
86	:Michael-B.: Whiting	Apache-County-Arizona-State, -:Attorney			
87	:Delwin-P.: Wengert	Apache-County-Arizona-State, -:Manager			Public-Record-Information-Request by the Beneficiaries of the Public-Trust
88	:Susan-R.: Bolton	:Judge -USDC- Arizona; CV07-1292-Phx-SRB; Johnson v. AzHHA,	09/24/13	RE 817 542 577 US	Certificate of the Trustee-Default
89	:Mark: Samson	Keller- Rohback, P.L.C.			



Handwritten mark

90	:Ron: Kilgard		↓	↓	↓	↓
91	:Mark-A.: Griffin	Keller- Rohback, L..L.P.		↓	↓	↓
92	:Raymond:A.: Farrow		↓	↓	↓	↓
93	:David-F.: Sorensen	Berger & Montague, P.C.		↓	↓	↓
94	:David: Balto	Law Offices of David Balto		↓	↓	↓
95	:Martha-L.: Fitzgerald	:Brown Hyatt Farber Schreck LLP		↓	↓	↓
96	:Jeffrey-S.: Rugg	:Judge -USDC- Arizona; CV07- 1292-Phx-SRB; Johnson v. AzHHA	09/24/13	RE 817 542 577 US	Certificate of the Trustee-Default	



1509

Affidavit:

Request For Court Trustee Protection Of Beneficiary Hill Darrell James

From: Darrell James: Hill,

Authorized Representative of Claimant Darrell James, Hill
Without prejudice, UCC 1-308, (old 1-207)
Non-resident, Non Domestic, FIRST CLASS U.S. Delivery
c/o General Delivery
Show Low, Arizona 85901

7009 1410 0000 78685673

To: **Case 2:07-cv-01292-SRB:**
USDC-AZ, Clerk of Court
401 W. Washington St.
Phoenix, Arizona 85003

**Re: Case No.: CV07-1292-PHX-SRB, Johnson, et al., v. AzHHA, et al.,
Class Member Darrell James, Hill, RG/2 Claimant No. 000000930.**

Judge Bolton:

I am the authorized representative of Claimant Hill Darrell James.
A mistake must presented to the Court to avoid fraud, as Claimant Darrell James,
Hill does not want to be party to a fraud.

It has come to my attention that a mistake or error has been made in the
matter of the claims distribution(s) due but not paid to Claimant Darrell James,
Hill (RG/2 Claims claimant # 000000930); in that, the matter has been handled
by the C'EST TUI QUE Trust Trustees of Darrell James, Hill, (to wit, the Court,
including Federal employees, assigns and appointees) as if the Claimant Darrell
James, Hill, has been operating as a government agent under the TITLE NAME
of a BIRTH CERTIFICATE.

For Clarification:

Point 1: Claimant Darrell James, Hill is a Common Law man of inherent
rights granted him by the Creator of All that is. (See Enclosure A)

Point 2: Claimant Beneficiary Darrell James, Hill has not been operating as
a government agent under the TITLE NAME of a BIRTH CERTIFICATE. From
before the beginning of the case Class membership and through the claimant
processes to now Claimant Darrell James, Hill has been acting only as (and will
forever continue to same as) a Common Law man of inherent rights.

Point 3: Class Counsel has made known to the Court upon several
footnote references indicating cases that contain the Claimant's Live Birth

Grantor Representative letter to Case 2:07-cv-01292-SRB:

2022-011769 MISC Page: 150 of 2782

09/26/2022 03:35:37 PM Receipt #: 22-9381

Rec Fee: \$30.00 Darrell James Hill

Gila County, Az, Sadie Jo Bingham, Recorder



5751

Affidavit:

Request For Court Trustee Protection Of Beneficiary Hill Darrell James

Record (see Doc. # 755, pgs 2-3, bottom) that Claimant is a Common Law man of inherent rights. Therefore,

BE IT KNOWN to the Court that Claimant Darrell James, Hill, is, has been, and will continue as, a Common Law man with inherent rights.

BE IT KNOWN to the Court that UPON THIS RECEIPT, Notice and Request for Court Trustee Protection of Beneficiary Hill Darrell James is formally completed upon the Trustee(s), et al., so to protect Trust Beneficiary Darrell James, Hill, in every regard and respect; that is, to make certain of the entire payment due to Claimant Darrell James, Hill, made without encumbrance (to wit, \$35,806.40, plus any additional amounts of interest and other amounts due, known and unknown, without deduction or otherwise redistribution) to the name "Darrell James, Hill".

Respectfully Submitted;
Without Prejudice, UCC 1-308, (old 1-207), 1-103

Date

Darrell James: Hill
Authorized Representative

Notary Public Certification

BEFORE ME, the undersigned authority, a Notary Public, of the County of _____, Republic of Arizona (statename), this _____ day of _____, 2013, Darrell James: Hill, did appear, was identified and, who, upon first being duly affirmed, deposes and says that the foregoing asseveration is true to the best of his knowledge and belief.

I certify under PENALTY OF PERJURY under the laws of the state of Arizona that the foregoing paragraph is true and correct.

WITNESS my hand and official seal.

SEAL

Grantor Representative letter to Case 2:07-cv-01292-SRB:

2022-011769 MISC Page: 151 of 2782.

09/26/2022 03:35:37 PM Receipt #: 22-9381

Rec Fee: \$30.00 Darrell James Hill

Gila County, Az, Sadie Jo Bingham, Recorder.



852

Unofficial Copy

ENCLOSURE: A

153

USPO CMN 7009 1410 0000 7868 5697 to Case 2:07-cv-

2022-011769 MISC Page: 152 of 2782
09/26/2022 03:35:37 PM Receipt #: 22-9381
Rec Fee: \$30.00 Darrell James Hill
Gila County, Az, Sadie Jo Bingham, Recorder

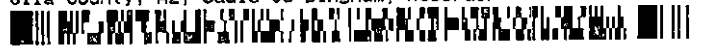

I HEREBY CERTIFY THIS DOCUMENT IS AN EXACT COPY OF THE RECORD ON FILE WITH THE OHIO DEPARTMENT OF HEALTH.

DE 24 08 01 7341

Judith B. Nagy
 JUDITH B. NAGY, STATE REGISTRAR
 OFFICE OF VITAL STATISTICS
 WITNESS BY SIGNATURE & SEAL

OHIO DEPARTMENT OF HEALTH
 DIVISION OF VITAL STATISTICS

CERTIFICATE OF LIVE BIRTH

Registrar's No. **9370**

Birth No. **134 - 58 - 208851**

2. USUAL RESIDENCE OF MOTHER (Where does mother live?)				
a. STATE	b. COUNTY			
Ohio	Summit			
c. CITY, VILLAGE, OR LOCATION				
Akron				
d. STREET ADDRESS				
219 King Ct.				
e. IS RESIDENCE INSIDE CITY LIMITS?				
YES <input checked="" type="checkbox"/> NO <input type="checkbox"/>				
f. IS RESIDENCE ON A FARM?				
YES <input type="checkbox"/> NO <input checked="" type="checkbox"/>				
3. DATE OF BIRTH				
MONTH	DAY	YEAR		
Nov	20	58		
4. IF TWIN OR TRIPLET, WAS CHILD BORN				
TWIN <input type="checkbox"/>	TRIPLET <input type="checkbox"/>	1ST <input checked="" type="checkbox"/>	2D <input type="checkbox"/>	3D <input type="checkbox"/>
5. BIRTHPLACE (State or foreign country)				
Ill				
6. COLOR OR RACE				
Negro				
7. USUAL OCCUPATION				
Carpenter				
8. KIND OF BUSINESS OR INDUSTRY				
Contractor				
9. COLOR OR RACE				
Negro				
10. BIRTHPLACE (State or foreign country)				
Ark				
11. PREVIOUS DELIVERIES TO MOTHER (Do NOT include this birth):				
a. How many OTHER children are now living?	b. How many OTHER children were born alive but are now dead?	c. How many fetal deaths (fetuses born dead at ANY time after conception)?		
3	none	none		
12. DATE SEROLOGIC TEST FOR SYPHILIS				
Mar 58				
13. ATTENDANT AT BIRTH				
M. D. <input checked="" type="checkbox"/>	D. O. <input type="checkbox"/>	MIDWIFE <input type="checkbox"/>	OTHER (Specify)	
14. DATE SIGNED				
11 26 58				

2022-011769 MISC Page: 153 of 2782

09/26/2022 03:35:37 PM Receipt #: 22-9381

Rec Fee: \$30.00 Darrell James Hill

Gila County, Az, Sadie Jo Bingham, Recorder



KSJ

CERTIFICATE OF SERVICE

I hereby certify under penalty of perjury from without the United States that on July 22, 2013, I sent the attached document to the Clerk's Office using the USPS First Class Mail. Notice of this filing will be sent to all parties listed below by USPO First Class Mail.

Respectfully submitted:

Dated: July , 2013

Darrell James Hill,
Authorized Representative
Without prejudice, UCC 1-308, (old 1-207)
Non-resident, Non Domestic,
FIRST CLASS U.S. Delivery
c/o General Delivery
Show Low, Arizona 85901

KELLER ROHBACK, P.L.C.
Mark Samson
Ron Kilgard
3101 North Central Avenue, Suite 1400
Phoenix, AZ 85012
Tel: 602-248-0088
Fax: 602-248-2822

KELLER ROHBACK, L.L.P
Mark A. Griffin
Raymond A. Farrow
1201 Third Avenue, Suite 3200,
Seattle, WA 98101
Tel: 206-623-1900
Fax: 206-623-3384

BERGER & MONTAGUE, P.C.
David F. Sorensen
1622 Locust Street
Philadelphia, PA 19103
Tel: 215-875-3000

CERTIFICATE OF SERVICE Case 2:07-cv-01292-SRB:

2022-011769 MISC Page: 154 of 2782
09/26/2022 03:35:37 PM Receipt #: 22-9381
Rec Fee: \$30.00 Darrell James Hill
Gila County, Az, Sadie Jo Bingham, Recorder



1 DS

Fax: 215-875-4673

KELLER ROHBACK, P.L.C.

Mark Samson

Ron Kilgard

3101 North Central Avenue, Suite 1400

Phoenix, AZ 85012

Tel: 602-248-0088

Fax: 602-248-2822

LAW OFFICES OF DAVID BALTO

David Balto

1350 I Street, N.W., Suite 850

Washington, D.C. 20005-3355

Tel: 202-577-5424

Fax: 202-589-1819

**BROWN HYATT FARBER SCHRECK,
LLP**

Martha L. Fitzgerald

410 Seventeenth Street, Suite 2200

Denver, CO 80202-4432

Tel: 303-223-1100

Fax: 303-223-1111

Jeffrey S. Rugg

100 city Parkway, Suite 1600

Las Vegas, NV 89106-4614

Tel: 702-382-2101

Fax: 702-382-8135

Attorneys for Plaintiffs

CERTIFICATE OF SERVICE Case 2:07-cv-01292-SRB:

2022-011769 MISC Page: 155 of 2782

09/26/2022 03:35:37 PM Receipt #: 22-9381

Rec Fee: \$30.00 Darrell James Hill

Gila County, Az, Sadie Jo Bingham, Recorder



156

7009 1410 0000 7868 5673

U.S. Postal Service™
CERTIFIED MAIL™ RECEIPT
(Domestic Mail Only; No Insurance Coverage Provided)

For delivery information visit our website at www.usps.com
PHOENIX, AZ 85003

Postage	\$	\$0.66
Certified Fee		\$3.10
Return Receipt Fee (Endorsement Required)		\$2.55
Restricted Delivery Fee (Endorsement Required)		\$0.00
Total Postage & Fees	\$	\$6.31

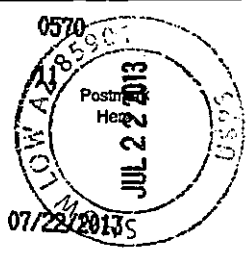

Sent To
USDC-AZ Clerk of Court
 Street, Apt. No.,
 or PO Box No. **401 W. Washington St**
 City, State, ZIP+4
Phoenix Ariz 85003

PS Form 3800, August 2006 See Reverse for Instructions

SENDER: COMPLETE THIS SECTION	COMPLETE THIS SECTION ON DELIVERY
<ul style="list-style-type: none"> Complete items 1, 2, and 3. Also complete item 4 if Restricted Delivery is desired. Print your name and address on the reverse so that we can return the card to you. Attach this card to the back of the mailpiece, or on the front if space permits. 	<p>A. Signature <i>x Beth Stephens</i> <input checked="" type="checkbox"/> Agent <input type="checkbox"/> Addressee</p> <p>B. Received by (Printed Name) <i>Beth Stephens</i></p> <p>C. Date of Delivery <i>7/23/13</i></p> <p>D. Is delivery address different from item 1? <input type="checkbox"/> Yes <input checked="" type="checkbox"/> No If YES, enter delivery address below:</p>
<p>1. Article Addressed to:</p> <p>Case 2:07-cv-01292-SRB: USDC-AZ, Clerk of Court 401 W. Washington St. Phoenix, Arizona 85003</p>	<p>3. Service Type <input type="checkbox"/> Certified Mail <input type="checkbox"/> Express Mail <input type="checkbox"/> Registered <input checked="" type="checkbox"/> Return Receipt for Merchandise <input type="checkbox"/> Insured Mail <input type="checkbox"/> C.O.D.</p> <p>4. Restricted Delivery? (Extra Fee) <input type="checkbox"/> Yes</p>
<p>2. Article Number (Transfer from service label) 7009 1410 0000 7868 5673</p>	<p>PHOENIX SALADO FACILITY JUL 23 2013</p>
PS Form 3811, February 2004	Domestic Return Receipt 102595-02-14-1540

Unofficial

Copy

2022-011769 MISC Page: 156 of 2782
 09/26/2022 03:35:37 PM Receipt #: 22-9381
 Rec Fee: \$30.00 Darrell James Hill
 Gila County, Az, Sadie Jo Bingham, Recorder

Darrell James: Hill, Authorized Representative of Hill Darrell James, and
Beverly Jean: Romero- Hill, Authorized Representative of Romero Beverly Jean
Without prejudice, UCC 1-308, (old 1-207)
Non-resident, Non Domestic, FIRST CLASS U.S. Delivery
c/o General Delivery
Show Low, Arizona 85901

Copy

Supervisor Joe Shirley, Jr. □ District I - Chinle
Supervisor Tom M. White, Jr. □ District II - Ganado
Supervisor Barry Weller □ District III - St. Johns
Michael B. Whiting, Apache County Attorney
Delwin P. Wengert, County Manager/
Clerk of the Board for Apache County
c/o Delwin P. Wengert
P.O. Box 428
St. Johns, Arizona 85936

2022-011769 MISC Page: 157 of 2782
09/25/2022 09:35:37 PM Receipt #: 22-6381
Rec Fee: \$30.00 Darrell James Hill
Gila County, Az, Sadie Jo Bingham, Recorder

Re: **PUBLIC INFORMATION REQUEST
BY BENEFICIARIES OF THE PUBLIC TRUST**

Sirs, Trustees:

I, Darrell James: Hill, am the authorized representative of Hill Darrell James, and I, Beverly Jean: Romero- Hill, am the authorized representative of Romero Beverly Jean. We are husband and wife under God Almighty.

Hill Darrell James and Romero Beyerly Jean (the "Beneficiaries") are Beneficiaries of the Cesta Que Trust, a.k.a. the "Public Trust"; Trustee thereto is the government of the United States of America (United States, Inc., it's employees, sub-corporations, appointees, and assigns thereto). Therefore,

Whereas the government of the United States of America (sub-corporations, et al.) is Trustee to Beneficiary Hill Darrell James and Beneficiary Romero Beverly Jean; and,

Whereas the State of Arizona, and the County of Apache (the "county") are sub-corporations of the government of the United States of America, and thus Trustees of the Public Trust to the Beneficiaries; and,

Whereas the Beneficiaries are presently living in and about the County of Apache, and are presently investigating subjects within the public record of the county, REQUEST BY THE BENEFICIARIES OF THE PUBLIC TRUST is made upon you herein, as thus:

- i) The county will make every effort to assure its Complete cooperation and Unimpeded access to All Public Information to the Beneficiaries upon request;
- ii) The county will make every effort to assure its provision of Copies of all information requested without charge to the Beneficiaries; and,
- iii) The county will make every effort to assure its Compliance with other needful requests by the Beneficiaries, including, but not limited to, the filing necessary information into the public record without charge.

The Beneficiaries are Common Law individuals with Inherent Rights living in the County of Apache, State of Arizona, and hereafter require un-obstructed access to the county records and

158

Darrell James: Hill, Authorized Representative of Hill Darrell James, and
Beverly Jean: Romero- Hill, Authorized Representative of Romero Beverly Jean
Without prejudice, UCC 1-308, (old 1-207)
Non-resident, Non Domestic, FIRST CLASS U.S. Delivery
c/o General Delivery
Show Low, Arizona 85901

services as particularly requested herein. Or, else, upon any obstruction to the Beneficiaries access to the public information and services requested, or other imposition, all associated individuals and actions will be investigated and all parties thereto removed from the offices of the Trustee pending further charges.

Sincerely;

07/26/2013
Date



Darrell James: Hill,
Authorized Representative of Public Trust
Beneficiary Hill Darrell James

7/26/2013
Date

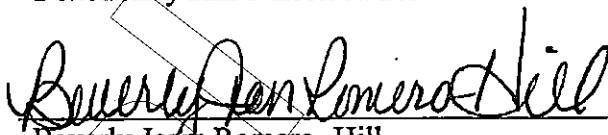

Beverly Jean: Romero- Hill,
Authorized Representative of Public Trust
Beneficiary Romero Beverly Jean

Notary Public Certification

BEFORE ME, the undersigned authority, a Notary Public, of the County of Navajo, Republic of Arizona (statename), this 26 day of July, 2013, Darrell James: Hill, and Beverly Jean: Romero- Hill, did appear, were identified and, whom, upon first being duly affirmed, deposes and says that the foregoing asseveration is true to the best of his and her knowledge and belief.

I certify under PENALTY OF PERJURY under the laws of the state of Arizona that the foregoing paragraph is true and correct.

WITNESS my hand and official seal.



SEAL

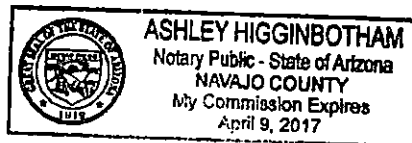

2022-011769 MISC Page: 158 of 2782
09/26/2022 03:35:37 PM Receipt #: 22-9381
Rec Fee: \$30.00 Darrell James Hill
Gila County, Az, Sadie Jo Bingham, Recorder



159

Darrell James: Hill, Authorized Representative of Hill Darrell James, and
Beverly Jean: Romero- Hill, Authorized Representative of Romero Beverly Jean
Without prejudice, UCC 1-308, (old 1-207)
Non-resident, Non Domestic, FIRST CLASS U.S. Delivery
c/o General Delivery
Show Low, Arizona 85901

CERTIFICATE OF SERVICE

I hereby certify under penalty of perjury from without the United States that on July 26, 2013, I sent the attached document to the Apache County Manager/ Clerk of the Board for Apache County Office using the USPS First Class Mail. Notice of this filing will be sent to all parties listed below by USPO First Class Mail.

Respectfully submitted:

Dated: July 26, 2013



Darrell James: Hill
Without prejudice, UCC 1-308, (old 1-207)
Non-resident, Non Domestic,
FIRST CLASS U.S. Delivery
c/o General Delivery
Show Low, Arizona 85901

Joe Shirley, Jr.
Apache County Supervisor
District I - Chinle
PO Box 1952
Chinle, AZ 86503
Phone: (928) 674-5664
FAX: (928) 674-5944

Tom M. White, Jr.
Apache County Supervisor
District II - Ganado
Post Office Box 994 Ganado, AZ 86505
Phone: (928) 755-3881/3882/3883
Fax:(928) 755-3226

Supervisor Barry Weller
Apache County Supervisor
District III - St. Johns
PO Box 428
St. Johns, AZ 85936
Phone #: (928) 337-7504

2022-011769 MISC Page: 159 of 2782
09/26/2022 03:35:37 PM Receipt #: 22-9381
Rec Fee: \$30.00 Darrell James Hill
Gila County, Az, Sadie Jo Bingham, Recorder

Darrell James: Hill, Authorized Representative of Hill Darrell James, and
Beverly Jean: Romero- Hill, Authorized Representative of Romero Beverly Jean
Without prejudice, UCC 1-308, (old 1-207)
Non-resident, Non Domestic, FIRST CLASS U.S. Delivery
c/o General Delivery
Show Low, Arizona 85901

Michael B. Whiting,
Apache County Attorney
245 W. 1st South,
St. Johns, Arizona
(928) 337-7560

Unofficial Copy

161

2022-011769 MISC Page: 160 of 2782
09/26/2022 03:35:37 PM Receipt #: 22-9381
Rec Fee: \$30.00 Darrell James Hill
Gila County, Az, Sadie Jo Bingham, Recorder



U.S. Postal Service™
CERTIFIED MAIL™ RECEIPT
 (Domestic Mail Only; No Insurance Coverage Provided)

For delivery information visit our website at www.usps.com

OFFICIAL USE

Postage	\$ 00.66	
Certified Fee	\$3.10	
Return Receipt Fee (Endorsement Required)	\$2.55	
Restricted Delivery Fee (Endorsement Required)	\$0.00	
Total Postage & Fees	\$ 06.31	07/26/2013

7009 1410 0000 7868 5710

Sent To

Street, Apt. #, or PO Box #: c/o Delwin P. Wengert, County Manager/
 Clerk of the Board for Apache County
 City, State, Zi: P.O. Box 428
 St. Johns, Arizona 85936

PS Form 380

- SENDER: COMPLETE THIS SECTION**
- Complete items 1, 2, and 3. Also complete item 4 if Restricted Delivery is desired.
 - Print your name and address on the reverse so that we can return the card to you.
 - Attach this card to the back of the mailpiece, or on the front if space permits.

1. Article Addressed to:

Delwin P. Wengert
 County manager
 Apache County
 P.O. Box 428
 ST. Johns, Ariz.
 85936

COMPLETE THIS SECTION ON DELIVERY

A. Signature
 [Signature: Shanna Pearce] Agent Addressee

B. Received by (Printed Name)
 Shanna Pearce
 Date of delivery: JUN 26 2013

D. Is delivery address different from item 1? Yes No
 If YES, enter delivery address below:

3. Service Type
 Certified Mail Express Mail
 Registered Return Receipt for Merchandise
 Insured Mail C.O.D.

4. Restricted Delivery? (Extra Fee) Yes

2. Article Number
 (Transfer from service label) 7009 1410 0000 7868 5710

PS Form 3811, February 2004 Domestic Return Receipt 102505-02-M-1540

2022-011769 MISC Page: 161 of 2782
 09/26/2022 03:35:37 PM Receipt #: 22-9381
 Rec Fee: \$30.00 Darrell James Hill
 Gila County, Az, Sadie Jo Bingham, Recorder



162

Unofficial Copy

Unofficial Copy

srosales@swlaw.com

Scott Sebastian Minder SMinder@perkinscoie.com, docketphx@perkinscoie.com,
smurphy@perkinscoie.com

James P McLoughlin, Jr jimmccloughlin@mvalaw.com, karenseymour@mvalaw.com

Brian Michael Flaherty bflaherty@polsinelli.com, lyellowhair@polsinelli.com

David A Ettinger dettinger@honigman.com

Kerry Scott Martin kerry.martin@ogletreedeakins.com,
kathy.hubert@ogletreedeakins.com, trish.simon@ogletreedeakins.com

Kami S Galvani kgalvani@steptoe.com, phdctnef@steptoe.com,
probinson@steptoe.com

Jill Louise Ripke jripke@perkinscoie.com, jgable@perkinscoie.com

Katherine I Funk katherine.funk@bakermckenzie.com

David F Sorensen (Terminated) dsorensen@bm.net

Eric L Cramer (Terminated) ecramer@bm.net, mdaniels@bm.net

Barry Steven Taus (Terminated) sroth@garwingerstein.com,
meman@garwingerstein.com

David P Smith (Terminated) dsmith@ssrllp.com, dsandifer@smithfoote.com

W Ross Foote (Terminated) rfoote@smithfoote.com, dsandifer@smithfoote.com

David A Balto david.balto@yahoo.com, bradwasser@yahoo.com

Andrew William Kelly (Terminated) akelly@odrlaw.com, akelly@odrlaw.com

Roopali H Desai rdesai@csblaw.com, smcalister@csblaw.com

Winthrop Blackstone Reed, III wreed@lewisrice.com, sstroup@lewisrice.com

David B Helms dhelms@lewisrice.com

Richard B Walsh, Jr rwalsh@lewisrice.com, iarmbruster@lewisrice.com

2022-011769 MISC Page: 162 of 2762
09/26/2022 03:35:37 PM Receipt #: 22-9381
Rec Fee: \$30.00 Darrell James Hill
Gila County, Az, Sadie Jo Bingham, Recorder



Allen Spencer Boston aboston@lewisrice.com

Stephen Michael Durbin sdurbin@lewisrice.com

Mark A Griffin mgriffin@kellerrohrback.com, dmarshall@kellerrohrback.com

Raymond J Farrow rfarrow@kellerrohrback.com

Benjamin William Reeves breeves@swlaw.com, docket@swlaw.com

Joan McPhee Joan.McPhee@ropesgray.com, CourtAlert@RopesGray.com,
cheryl.heroux@ropesgray.com

Tyler Reese Bowen tbowen@perkinscoie.com, dgraziano@perkinscoie.com,
docketphx@perkinscoie.com

Neill Wilson Clark nclark@bm.net, pfrohbergh@bm.net

Martha L Fitzgerald mfitzgerald@bhfs.com, sgrisham@bhfs.com

Allen P Grunes agrunes@bhfs.com, agrunes@bhfs.com

Jeffrey S Rugg jrugg@bhfs.com, jrugg@bhfs.com

Timothy R Beyer tbeyer@bhfs.com, mimdieke@bhfs.com

Shauna B Itri sitri@bm.net, sitri@bm.net

Mark J Horoschak mhoroschak@wcsr.com, ashillingford@wcsr.com,
pshores@wcsr.com

Brian A Hayles bhayles@wcsr.com, ashillingford@wcsr.com, pshores@wcsr.com

Jane E Willis jane.willis@ropesgray.com, nancy.mansfield@ropesgray.com,
thomas.brown@ropesgray.com

Matthew P Garvey matthew.garvey@ropesgray.com, CourtAlert@ropesgray.com

Penny Hirsch Edwards pennyedwards@mvalaw.com, mariannboyer@mvalaw.com

Tonya L Mitchell tonyamitchell@mvalaw.com, joancable@mvalaw.com

Debbie Weston Harden dharden@wcsr.com, shanley@wcsr.com

2022-011769 MISC Page: 163 of 2782
09/26/2022 03:35:37 PM Receipt #: 22-9381
Rec Fee: \$30.00 Darrell James Hill
Gila County, Az, Sadie Jo Bingham, Recorder

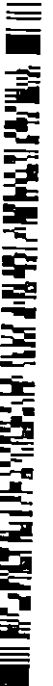

1694

Catherine T Broderick cbroderick@jonesday.com, vcrawford@jonesday.com

Dennis D Palmer dpalmer@polsinelli.com, msirinek@polsinelli.com

2:07-cv-01292-SRB Notice will be sent by other means to those listed below if they are affected by this filing:

The following document(s) are associated with this transaction:

Document description:Main Document

Original filename:n/a

Electronic document Stamp:

[STAMP dcecfStamp_ID=1096393563 [Date=7/26/2013] [FileNumber=11009585-0] [294e860b61af8e35bb0854da70739033a6c395a905740dc1e0dd4c21244a24f27f105ea410a3488840368015d3548ad4b87ef30a3089c389f018d56b03687e03]]

Unofficial

Copy

2022-011769 MISC Page: 164 of 2782

09/26/2022 03:35:37 PM Receipt #: 22-9381

Rec Fee: \$30.00 Darrell James Hill

Gila County, Az, Sadie Jo Bingham, Recorder



665

SEALED

**IN THE UNITED STATES DISTRICT COURT
FOR THE DISTRICT OF ARIZONA**

Cindy Johnson, Barbara A. Craig, and Stephanie L. Walker on behalf of themselves and all others similarly situated,

No. CV07-1292-PHX-SRB

Plaintiffs,

vs.

Arizona Hospital and Healthcare Association et al.,

Defendants.

ORDER – FILED UNDER SEAL

The Court, upon and after consideration of all submissions by Darrell James: Hill including but not limited to Doc. No. 748, dated May 8, 2013, and Doc. No. 749, dated June 14, 2013, and in light of the entire record in this case, hereby ORDERS that:

1. The Court-appointed claims administrator, RG/2 Claims Administration LLC, (“RG/2 Claims”) is directed to, and shall, deliver to Mr. Hill, Claim No. AZA000000930, by registered mail to his last known mailing address, c/o General Delivery, Show Low, Arizona, 85901, one distribution check in the following amount minus federal and state tax withholding as specified below:

Gross Total Payment:		\$35,806.40
Less: Withholdings		
Social Security:	\$2,013.55	
Medicare:	\$470.91	
Income Tax:	\$8,119.14	
AZ Personal Income Tax:	\$1,656.30	
<u>Net Settlement Check to be Delivered to Mr. Hill</u>		<u>\$23,546.50</u>

2022-011769 MISC Page: 165 of 2782

09/26/2022 09:35:37 PM Receipt #: 22-9381
Rec Fee: \$30.00 Darrell James Hill
Gila County, Az, Sadie Jo Bingham, Recorder



106

1 2. The above amounts represent the total gross and net amount properly allocated to
2 Mr. Hill's claim.

3 3. RG2/Claims is directed to remit taxes withheld from the payment to Mr. Hill to the
4 appropriate taxing authorities, and to remit the portion of the employers' payroll taxes allocable to
5 Mr. Hill's claim.
6

7 4. Plaintiffs, all current and former Class Counsel, RG/2 Claims, the Escrow Agent,
8 and all other persons involved in the review, verification, calculation, tabulation, or any other
9 aspect of the processing, denial or payment of Mr. Hill's claim filed in this matter including the
10 calculation and withholding and remittance of state and federal taxes including payroll taxes as to
11 the claim of Mr. Hill as set forth above in Paragraphs 1-3, or who were otherwise involved in the
12 administration of the settlements in this matter, are hereby released and discharged from any and
13 all claims by Mr. Hill or other Class members arising out of or relating to such involvement.
14

15 5. Mr. Hill is hereby barred from making any further claims against the settlement
16 funds beyond the specific amount allocated to him pursuant to this Order.

17 6. This Order does not limit Mr. Hill's freedom to seek any refund he believes he
18 may be due directly from taxing authorities.

19 7. The clerk of Court shall cause to be delivered a copy of this Order to Mr. Hill by
20 registered mail to his last known mailing address: Darrell James Hill, c/o General Delivery,
21 Show Low, Arizona, 85901.
22

23 8. RG/2 Claims shall deliver the settlement check as specified above to Mr. Hill
24 within 10 days of the expiration of any period of time for appeal of this Order or, if an appeal is
25 taken, the entry of a final, non-appealable order regarding Mr. Hill's claim.
26



1
2
3
4
5
6
7
8
9
10
11
12
13
14
15
16
17
18
19
20
21
22
23
24
25
26
27
28

9. This Order shall be filed UNDER SEAL.

10. This Court retains jurisdiction over any further controversy or matter which may arise in connection with this action.

Dated this 26th day of July, 2013.

Susan R. Bolton

Susan R. Bolton
United States District Judge

Unofficial

168

2022-011769 MISC Page: 167 of 2782
09/26/2022 03:35:37 PM Receipt #: 22-9381
Rec Fee: \$30.00 Darrell James Hill
Gila County, Az, Sadie Jo Bingham, Recorder

Darrell James: Hill
c/o General Delivery
Show Low, AZ 85901
CV-07-1292-PHX-SRB

Unofficial Copy

11/16/22

2022-011769 MISC Page: 168 of 2782

09/26/2022 03:35:37 PM Receipt #: 22-9381

Rec Fee: \$30.00 Darrell James Hill

Gila County, Az, Sadie Jo Bingham, Recorder



SEALED

DOCUMENT

NOT A PUBLIC

RECORD

170

2022-011769 MISC Page: 169 of 2782
09/26/2022 03:35:37 PM Receipt #: 22-9381
Rec Fee: \$30.00 Darrell James Hill
Gila County, Az, Sadie Jo Bingham, Recorder



THIS MATTER IS TO BE PART OF THE PUBLIC RECORD

July 31, 2013

CMN 7009 1410 0000 7868 5680

7009 1410 0000 7868 5680

Darrell James: Hill,
Authorized Representative of Claimant
Without prejudice, UCC 1-308, (old 1-207)
Non-resident, Non Domestic, FIRST CLASS U.S. Delivery
c/o General Delivery
Show Low, Arizona 85901

Case 2:07-cv-01292-SRB:
USDC-AZ, Clerk of Court
401 W. Washington St.
Phoenix, Arizona 85003

Re: Failure Of Trustee Justice To Comply; RESTATEMENT OF ORDER

Judge Bolton:

I am the appointed representative of Darrell James, Hill, a Common Law man with Inherent Rights, and appointed administrator of Darrell James, Hill, Beneficiary of the Public Trust.

Point 1: I AM the Administrator over the Trust Proceedings concerning both persons in this court.

Point 2: The Record of Live Birth of Darrell James, Hill, was provided to the court on 07/23/2013 by USPO CMN 70091410000078685673, EXHIBIT A, which established the presumption in fact that Darrell James, Hill is a Common Law man with Inherent Rights.

Point 3: The Rescinded SSA Number, a matter made known to this record (to wit, the non-SSA number [REDACTED]), is evidence of the Public Trust and establishes the presumption of fact that Darrell James, Hill is a Beneficiary of the Public Trust.

Point 4: You, Judge Bolton (et al.), are a public servant, a trustee of the Public Trust; **I DO NOT ACCEPT YOUR OFFER (Doc. 762, attached, 11 pages); I DO NOT CONSENT.**

Rather,

I Order you: to

- a) Rewrite the order to the RG2 appointee;
- b) Order RG2 to pay **ALL** of the monies due to Claimant Hill (RG2 Claimant # 000000930) without deduction or redistribution; and,
- c) Answer Doc. 748 judicial determination questions.

Point 5: You, Judge Bolton, retain no judicial immunity for violation of your public service oath in violation against Darrell James, Hill, the Common Law man of Inherent Rights or in violation against Darrell James, Hill, the Beneficiary of the Public Trust. If you succeed in damaging either, or both, Darrell James, Hill, the Common Law Man with Inherent Rights or Darrell James, Hill, the Beneficiary of the Public Trust, the Fee for each violation to either person is \$1,000,000.00.

07/31/2013
Date

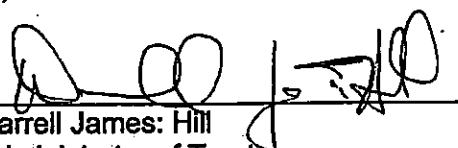
Darrell James: Hill
Administrator of Trust

AR response to Trustee Failure to Comply 2:07-cv-0

2022-011769 MISC Page: 170 of 2782
09/26/2022 03:35:37 PM Receipt #: 22-9381
Rec Fee: \$30.00 Darrell James Hill
Gila County, Az, Sadie Jo Bingham, Recorder



172

U.S. Postal Service™
CERTIFIED MAIL™ RECEIPT
 (Domestic Mail Only; No Insurance Coverage Provided)

For delivery information visit our website at www.usps.com

OFFICIAL USE

Postage	\$	\$0.66
Certified Fee		\$3.10
Return Receipt Fee (Endorsement Required)		\$0.00
Restricted Delivery Fee (Endorsement Required)		\$0.00
Total Postage & Fees	\$	\$3.76



7009 1410 0000 7868 5680

SHOWLOW MPO
 SHOWLOW, Arizona
 859019998
 0363680570-0099
 07/31/2013 (928)537-4588 10:15:29 AM

Sales Receipt

Product Description	Sale Unit Qty	Price	Final Price
---------------------	---------------	-------	-------------

PHDENIX AZ 85003 Zone-1			\$0.66
-------------------------	--	--	--------

First-Class Mail Letter
 2.00 oz.
 Scheduled Delivery Day: Thu
 08/01/13

00 Certified \$3.10

*Label #: 70091410000078685680

Customer Postage -\$0.75

Subtotal: \$3.01

Issue PVI: \$3.01

Total: \$3.01

Paid by:
 Cash \$3.01

For tracking or inquiries go to
 USPS.com or call 1-800-222-1811.

Sent To USDC AZ Clerk of Court
 Street, Apt. No. or PO Box No. 401 W. Washington St
 City, State, ZIP+4 Phoenix AZ 85003

PS Form 3800, August 2006 See Reverse for Instructions.

Unofficial

2022-011769 MISC Page: 171 of 2782

09/26/2022 03:35:37 PM Receipt #: 22-9381
 Rec Fee: \$30.00 Darrell James Hill
 Gila County, Az, Sadie Jo Bingham, Recorder



ALL
 172



FOR THE EYES OF THE YHVH IN EVERY PLACE BEHOLDS OF THE EVIL AND OF THE GOOD.

I INVOKE THIS DOCUMENT BE PART OF THE PUBLIC RECORD

August 16, 2013



Darrell James: Hill,
Authorized Representative of the Claimant
Non-Resident, Non-Domestic, FIRSTCLASS U.S. Delivery
c/o General Delivery
Show Low, Arizona 85901

No. 07-1292
USDC-AZ: Clerk of the Court
401 West Washington Street
Phoenix, Arizona 85003

COPY

Re: Ailing Compliance Of The Trustees; STATEMENT OF THE ORDER

Judge Bolton:

- POINT 1: For the trustees' knowledge of the fact: I am the Appointed Representative of Darrell James, Hill, the Common Law man with Inherent Rights from Almighty God YHVH- Creator of all that exists; and the Appointed Administrator of the Public Trust of Darrell James, Hill- the Beneficiary of the Public Trust.
- POINT 2: For the trustees' knowledge of the fact: The Appointed-Representative of the Common Law man and -Administrator of the Public Trust is the Director of the Proceedings in this court in matters of Darrell James, Hill.
- POINT 3: For the trustees' knowledge of the fact: The Record of the Live Birth- Darrell James, Hill was placed into the court record with the 07/23/2013- USPO-CMN-7009141000078685673, in the EXHIBIT A, of the fact that Claimant- Darrell James, Hill, the Common Law man with the Inherent Rights from the Creator is the same man in this Arizona territory and in this court.
- POINT 4: For the trustees' knowledge of the fact: For the Rescinded SSA Number- [REDACTED], the matter made known in this court record of that Claimant- Darrell James, Hill is the Beneficiary of the Public Trust and due trustees' duty of obligatory protection.
- POINT 5: For the trustees knowledge of the fact: Claimant-Beneficiary Darrell James, Hill is both the a) Common Law man with the Inherent Rights from the Creator and b) Beneficiary of the Public Trust, both in the Arizona territory and in this court.
- POINT 6: For the trustees' knowledge of the fact: by the un rebutted-facts, Claimant-Beneficiary Darrell James, Hill- RG2 Claimant #00000930, is of the statuses of a) non-taxpayer, and b) non statutory in nature, and c) not operating in the TITLE of the BIRTH CERTIFICATE, both in the Arizona-territory and in this court.
- POINT 7: For the trustees' knowledge of the fact: Claimant-Beneficiary Darrell James, Hill- RG2 Claimant #00000930 Never swore an oath of office.

173

- POINT 8: For the trustees' knowledge of the fact: Claimant-Beneficiary Darrell James, Hill- RG2 Claimant #000000930 Never realized that the fine print on the bottom of all income tax forms meant that one was claiming to be under oath.
- POINT 9: For the trustees' knowledge of the fact: Claimant-Beneficiary Darrell James, Hill- RG2 Claimant #000000930 did not realize the import and implications of the clause Under penalties of perjury on tax forms was claiming to be under oath. It was a mistake, and now that Claimant-Beneficiary Darrell James, Hill- RG2 Claimant #000000930 comprehends the meaning of the clause and hidden claim, for the reasons of the conscience, Claimant-Beneficiary Darrell James, Hill will Never form that mistake knowingly, voluntarily and intentionally.
- POINT 10: For the trustees' knowledge of the fact: Justice Bolton, employees, appointees, et al. are public servants and trustees of the Public Trust.
- POINT 11: For the trustees' knowledge of the fact: I DO NOT ACCEPT OF YOUR OFFER-Doc.762, attached 10 pages; I DO NOT CONSENT.
- POINT 12: For the trustees' knowledge of the fact: I Order the trustees will directly pay, the known- and unknown-payment due, Claimant- Beneficiary Darrell James, Hill- RG2 Claimant #000000930.
- POINT 13: For the trustees' knowledge of the fact: For the trustees every breach of the trust-damage of the Claimant-Beneficiary Darrell James, Hill- RG2 Claimant #000000930 is with the Fee- \$1,000,000.00.
- POINT 14: For the trustees' knowledge of the fact: Trustees have 21 days after 07/23/2013 for the compliance of this order.

08/13/2013
Date

Darrell James Hill
Darrell James: Hill
Appointed Representative

Proverbs 5:21 For the ways of the man are before the eyes of The YHVH, and of the eyes of The YHVH pondereth all of the ways of the man.

2022-011769 MISC Page: 173 of 2782
09/26/2022 03:35:37 PM Receipt #: 22-9381
Rec Fee: \$30.00 Darrell James Hill
Gila County, Az, Sadie Jo Bingham, Recorder



RE81754244US

0570

07

08/16/13

SHOWLOW MPD
 SHOWLOW, Arizona
 859019998
 0363680570-0096
 08/16/2013 (928)537-4588 03:37:24 PM

Sales Receipt

Product Description	Sale Unit Qty	Price	Final Price
---------------------	---------------	-------	-------------

PHOENIX AZ 85003 Zone-1			\$0.86
-------------------------	--	--	--------

First-Class Mail Letter
 2.60 oz.

Scheduled Delivery Day: Sat
 08/17/13

Return Rcpt (Green Card)			\$2.55
--------------------------	--	--	--------

@ Registered			\$11.20
--------------	--	--	---------

Insured Value : \$0.00

Article Value : \$0.00

Label #: RE81754244US

Customer Postage -\$1.16

Subtotal: \$13.45

Issue PVI: \$13.45

Total: \$13.45

Paid by:

Cash \$20.00

Change Due: -\$6.55

@ For tracking or inquiries go to
 USPS.com or call 1-800-222-1811.

Save this receipt as evidence of
 insurance. For information regarding
 insurance and requirements for

To Be Completed By Post Office	Reg. Fee	\$11.20	
	Handling Charge	\$0.00	Return Receipt \$2.55
	Postage	\$0.86	Restricted Delivery \$0.00
	Received by		

Customer Must Declare
 Full Value \$ \$0.00

Domestic insurance up to \$25,000 is included based upon the declared value. International Indemnity is limited. (See Reverse).

OFFICIAL USE

To Be Completed By Customer (Please Print) All Entries Must Be In Ballpoint or Typed	FROM	Darrell James Hill Non-resident, Non Domestic First Class 1/2 general delivery Showlow Arizona 85901
	TO	USDC-AZ Clerk of Court 401 W. Washington street Phoenix Arizona 85003

PS Form 3806, Receipt for Registered Mail Copy T - Customer
 May 2007 (7530-02-000-9051) (See Information on Reverse)

For domestic delivery information, visit our website at www.usps.com®

Unofficial

2022-011769 MISC Page: 174 of 2782

09/26/2022 03:35:37 PM Receipt #: 22-9381

Rec Fee: \$30.00 Darrell James Hill

Gila County, Az, Sadie Jo Bingham, Recorder



175



FOR THE EYES OF THE YHVH IN EVERY PLACE BEHOLDS OF THE EVIL AND OF THE GOOD.

Darrell James: Hill (: husband):

Authorized Representative: Hill Darrell James, &
Beverly Jean: Romero- Hill (: wife):

Authorized Representative of Romero Beverly Jean
Non-resident, Non Domestic, FIRST CLASS U.S. Delivery
c/o General Delivery
Show Low, Arizona 85901

Supervisor **Joe Shirley, Jr.** District
Supervisor **Tom M. White, Jr.** District
Supervisor **Barry Weller** District
Michael B. Whiting, Apache County Attorney
Delwin P. Wengert, County Manager/
Clerk of the Board for Apache County
c/o Delwin P. Wengert
P.O. Box 428
St. Johns, Arizona 85936

**Re: PUBLIC RECORD INFORMATION REQUEST BY THE BENEFICIARIES OF THE
PUBLIC TRUST**

Sirs: Trustees:

POINT 1: For the trustees' knowledge of the fact: Darrell James: Hill is: authorized representative of: Darrell James, Hill.

POINT 2: For the trustees' knowledge of the fact: Beverly Jean: Romero- Hill is: authorized representative of: Beverly Jean, Romero.

POINT 3: For the trustees' knowledge of the fact: Darrell James, Hill and Beverly Jean, Romero are of the common law birth with the inherent rights from God Almighty: YHVH: Creator of all that exists.

POINT 4: For the trustees' knowledge of the fact: Darrell James, Hill and Beverly Jean: Romero, Hill are of the common law birth in the territories of the states of the geographical-United-States-of-America.

POINT 5: For the trustees' knowledge of the fact: Darrell James Hill and Beverly Jean Romero are: Beneficiaries of the Cesta Que Trust: a.k.a.- public trust of the United-States-of-America government: year 1958.

POINT 6: For the trustees' knowledge of the fact: United-States-of-America government's public-trust Trusteeship is to the Trust-Beneficiary Darrell James Hill and Trust-Beneficiary Beverly Jean Romero.

POINT 7: For the trustees' knowledge of the fact: Trustees for the government of the United-States-of-America -United States, Inc. officers and employees and sub-corporations and appointees-etc. includes: public officials and employees and sub-corporations and appointees-etc. of the Arizona state and Apache county governments.

POINT 8: For the trustees' knowledge of the fact: Beneficiaries are searching amongst the properties within the Apache county area of the Arizona territory.

- POINT 9: For the trustees' knowledge of the fact: **Demand** by the Beneficiaries of the public trust is made upon the Apache county trustees of the public trust as thus: 1: County trustees will guarantee complete cooperation and unimpeded access of all public information-requested by the Beneficiaries- including but not limited too: A: Providing of the copy(s) without the charge: all of the information-requested of the trustees by the Beneficiaries &: B: Filing into the public record without the charge: all of the information-requested of the trustees by the Beneficiaries.
- POINT 10: For the trustees' knowledge of the fact: Hill Darrell James and Romero Beverly Jean are husband and wife under the God Almighty: YHVH.
- POINT 11: For the trustees' knowledge of the fact: Trustees' every breach of the trust/damage of the Beneficiary Darrell James Hill is with the Fee- \$1,000,000.00.
- POINT 12: For the trustees' knowledge of the fact: Trustees' every breach of the trust/damage of the Beneficiary Beverly Jean Romero is with the Fee- \$1,000,000.00.
- POINT 13: For the trustees' knowledge of the fact: Trustees' breach of trust/damage of the Beneficiaries will be investigated and removed from the office of the Trustee with the further charges.
- POINT 14: For the trustees' knowledge of the fact: Trustees' upon the livery of this information have 21 days after the 07/29/2013- USPO-CMN 7009141000078685710- livery-date for the full compliance of this demand.

08-19-2013
Date

Darrell James: Hill
Darrell James: Hill:
Authorized Representative

08-19-2013
Date

Beverly Jean: Romero-Hill
Beverly Jean: Romero- Hill:
Authorized Representative

Proverbs 5:21 For the ways of the man are before the eyes of The YHVH and of the eyes of The YHVH pondereth all of the ways of the man.

2022-011769 MISC Page: 176 of 2782
09/26/2022 03:35:37 PM Receipt #: 22-9381
Rec Fee: \$30.00 Darrell James Hill
Gila County, Az, Sadie Jo Bingham, Recorder



SHOWLOW MPO
 SHOWLOW, Arizona
 859019998
 0363680570-0097
 08/19/2013 (928)537-4588 01:23:11 PM

Sales Receipt		
Product Description	Sale Unit Qty Price	Final Price
SAINT JOHNS AZ 85936 Zone-1		\$0.46
First-Class Mail Letter		
0.60 oz.		
Scheduled Delivery Day: Tue		
08/20/13		
Return Rcpt (Green Card)		\$2.55
@@ Registered		\$11.20
Insured Value :	\$0.00	
Article Value :	\$0.00	
Label #:	RB898807997US	
Customer Postage		-\$1.33
Subtotal:		\$12.88
Issue PVI:		\$12.88

Total: ~~\$12.88~~

Paid by:
 Cash \$13.00
 Change Due: -\$0.12

@@ For tracking or inquiries go to USPS.com or call 1-800-222-1811.

Save this receipt as evidence of insurance. For information regarding insurance and requirements for

Registered No. RB898807997US		Date Stamp 0570 85901 08/19/13 AUG 19 2013	
To Be Completed By Post Office	Reg. Fee	\$11.20	
	Handling Charge	\$0.00	Return Receipt \$2.55
	Postage	\$0.46	Restricted Delivery \$0.00
	Received by		
Customer Must Declare Full Value \$ <u>\$0.00</u>		Domestic Insurance up to \$500 is included based upon the declared value. International indemnity is limited. (See Reverse).	
OFFICIAL USE			
To Be Completed By Customer (Please Print) All Entries Must Be in Ballpoint or Typed	FROM	Darrell James Hill Non-Resident, Non-Domestic First Class Go General Delivery Showlow Arizona 85901	
	TO	SAINT JOHNS AZ 85936 Devin A. Wengert County Manager Clerk of the board for Apache County PO Box 428 St. Johns Arizona 85936	

PS Form 3806, Receipt for Registered Mail Copy 1 - Customer
 May 2007 (7530-02-000-9051) (See Information on Reverse)
 For domestic delivery information, visit our website at www.usps.com

178
80

DOCUMENT: PART OF THE PUBLIC RECORD

: Case: No. 07-1292

USPO RMN RE 817 542 577 US

Darrell James: Hill,
Authorized Representative of the Claimant
Non-Resident, Non-Domestic, FIRSTCLASS U.S. Delivery
c/o General Delivery,
Show Low, Arizona 85901

No. 07-1292 (IN RE: CASE NO.: CV 07-1292-PHX-SRB, JOHNSON, et al. V. AZHHA, et al., Class Member Darrell James, Hill, RG/2 Claimant No. 000000930)

: Clerk of the Court
401 West Washington Street
Phoenix, Arizona 85003

RE: MOTION: CERTIFICATE OF THE DEFAULT

- POINT 1: For the trustees' knowledge of the fact: I am the Appointed Representative for the Plaintiff Darrell James, Hill (RG/2 Claimant No. 000000930 in the class action), the Common Law man with Inherent Rights from Almighty God YHVH- Creator of all that exists; and the Appointed Administrator of the Public Trust of Darrell James, Hill- the Beneficiary of the Public Trust.
- POINT 2: For the trustees' knowledge of the fact: Trustees' have received repeated requests identifying: Plaintiff Darrell James, Hill (RG/2 Claimant No. 000000930 in the class action) by the provision of the documentation establishing in the fact: Common Law Inherent Rights status; to the wit: Record of the Live Birth- Darrell James, Hill was placed into the court record with the 07/23/2013-USPO-CMN-70091410000078685673, in the EXHIBIT A, and of the like statements.
- POINT 3: For the trustees' knowledge of the fact: Clerk has accepted all of the clarifying correspondence re: Darrell James, Hill; to the wit: 1) USPO CMN 7009 1410 0000 7868 5680, Re: Failure of the Trustee Justice to Comply: RESTATEMENT OF ORDER: August 1, 2013, 10:06 am, 2) USPO CMN 7009 1410 0000 7868 6673, Re: Case No.: CV07-1292-PHX-SRB, Johnson, et al., v. AzHHA, et al., Class Member Darrell James, Hill, RG/2 Claimant No. 000000930: July 23, 2013, 11:30 am, and 3) USPO RMN RE 817 542 444.US, Re: Ailing Compliance Of The Trustees; STATEMENT OF THE ORDER: August 19, 2013, 10:20 am, and of the like statements.
- POINT 4: For the trustees' knowledge of the fact: Trustees' failure to date is with no substantive response to the provision of the documentation establishing in the fact: Common Law Inherent Rights status of the Plaintiff- Beneficiary Darrell James, Hill (RG/2 Claimant No. 000000930): Common Law Man of the Inherent Rights status in this action.
- POINT 5: For the trustees' knowledge of the fact: Trustees' failure constitutes tacit procurement of the facts and presumption: facts presented to them by the Plaintiff-Beneficiary Darrell James, Hill (RG/2 Claimant No. 000000930): Common Law Man of the Inherent

: Case: No. 07-1292

HILL USPO RMN RE

1 of 2

2022-011769 MISC Page: 178 of 2782
09/26/2022 03:35:37 PM Receipt #: 22-9381
Rec Fee: \$30.00 Darrell James Hill
Gila County, Az, Sadie Jo Bingham, Recorder



179
621

DOCUMENT: PART OF THE PUBLIC RECORD

: Case: No. 07-1292

USPO RMN RE 817 542 577 US

Rights status in this action.

POINT 6: For the trustees' knowledge of the fact: Trustees' inactions firmly chose for the **DEFAULT.**

MOTION: FOR THE FACT: TRUSTEES' ARE IN DEFAULT; to the wit: Plaintiff-Beneficiary Darrell James, Hill (RG/2 Claimant No. 000000930) is a Common Law Man of the Inherent Rights status in this action.

09-24-2013

Date

Darrell-James Hill

Darrell James Hill

Appointed Representative

Proverbs 5:21 For the ways of the man are before the eyes of The YHVH, and of the eyes of The YHVH pondereth all of the ways of the man.

Unofficial

COPY

: Case: No. 07-1292

HILL USPO RMN

2 of 2

180

2022-011769 MISC Page: 179 of 2782
09/26/2022 03:35:37 PM Receipt #: 22-9381
Rec Fee: \$30.00 Darrell James Hill
Gila County, Az, Sadie Jo Bingham, Recorder



CERTIFICATE OF SERVICE

I hereby certify under Almighty God that on September 24, 2013, I sent the attached document re: Case: No. 07-1292, to the Clerk's Office using the USPS First Class Registered Mail: USPO RMN RE 817 542 577 US. Notice of this filing will be sent to all parties listed below by USPO First Class Mail.

Respectfully submitted:

Dated: September 24, 2013

Darrell James Hill
Darrell James Hill,
Authorized Representative
Without prejudice, UCC 1-308, (old 1-207)
Non-resident, Non Domestic,
FIRST CLASS U.S. Delivery
c/o General Delivery
Show Low, Arizona 85901

KELLER ROHBACK, P.L.C.
Mark Samson
Ron Kilgard
3101 North Central Avenue, Suite 1400
Phoenix, AZ 85012
Tel: 602-248-0088
Fax: 602-248-2822

KELLER ROHBACK, L.L.P
Mark A. Griffin
Raymond A. Farrow
1201 Third Avenue, Suite 3200,
Seattle, WA 98101
Tel: 206-623-1900
Fax: 206-623-3384

BERGER & MONTAGUE, P.C.
David F. Sorensen
1622 Locust Street
Philadelphia, PA 19103
Tel: 215-875-3000



Fax: 215-875-4673

LAW OFFICES OF DAVID BALTO
David Balto
1350 I Street, N.W., Suite 850
Washington, D.C. 20005-3355
Tel: 202-577-5424
Fax: 202-589-1819

BROWN HYATT FARBER SCHRECK, LLP
Martha L. Fitzgerald
410 Seventeenth Street, Suite 2200
Denver, CO 80202-4432
Tel: 303-223-1100
Fax: 303-223-1111

Jeffrey S. Rugg
100 city Parkway, Suite 1600
Las Vegas, NV 89106-4614
Tel: 702-382-2101
Fax: 702-382-8135

Attorneys for Plaintiffs

2022-011769 MISC Page: 181 of 2782
09/26/2022 03:35:37 PM Receipt #: 22-9381
Rec Fee: \$30.00 Darrell James Hill
Gila County, Az, Sadie Jo Bingham, Recorder



CERTIFICATE OF SERVICE Case 2:07-cv-01292-SRB:

2 of 2

2MN 817 542 577 US

182

SHOWLOW MPO
 SHOWLOW, Arizona
 859019998
 0363680570-0099
 09/24/2013 (928)537-4588 04:48:48 PM

Sales Receipt
 Product Sale Unit Final Price
 Description Qty Price

PHOENIX AZ 85003 Zone-1 \$0.66
 First-Class Mail Letter
 1.10 oz.
 Scheduled Delivery Day: Wed
 09/25/13

Return Rcpt (Green Card) \$2.55
 @@ ~ Registered \$12.05
 Insured Value : \$15.00
 Article Value : \$15.00
 Label #: RE817542577US
 Customer Postage -\$1.87
 Subtotal: \$13.39

Issue PVI: \$13.39

Total: \$13.39

Paid by:
 Cash \$14.00
 Change Due: -\$0.61

@@ For tracking or inquiries go to
 USPS.com or call 1-800-222-1811.

~ Save this receipt as evidence of
 insurance. For information on filing

Registered No.
RE 817 542 577 US

To Be Completed By Post Office	Reg. Fee	\$12.05	
	Handling Charge	\$0.00	Return Receipt \$2.55
	Postage	\$0.66	Restricted Delivery \$0.00
	Received by	PS	

Date Stamp
 0570
 03
 09/24/13

Customer Must Declare Full Value \$15.00
 Domestic Insurance up to \$25,000 is included based upon the declared value. International Indemnity is limited. (See Reverse).

OFFICIAL USE

To Be Completed By Customer (Please Print) - All Entries Must Be In Ballpoint or Typed	FROM	Darrell James Hill c/o general delivery Showlow, Arizona 85901
	TO	PHOENIX AZ 85003 - PHX-SRB Clerk of Court 401 W. Washington Street Phoenix AZ 85003

PS Form 3806, Receipt for Registered Mail Copy 1 - Customer
 May 2007 (7530-02-000-9051) (See Information on Reverse)
 For domestic delivery information, visit our website at www.usps.com®

Unofficial

183
 95

:2015 A.D.

#	:man- trustee	:association	:year, :day	USPO, other	:covenant
1	:Michelle: Reagan	:Arizona-State-Secretary	07/25/15	7008 1300 0002 2256 4613	Beverly-Jean: Romero- Hill, -:DOI-1776-A.D., et al.: AOC-1778-A.D., :CftUSofA-1787-A.D., -:New Mexican-©-1958-A.D. -:exclusive-peculiar-absolute-owner; -:EBA-1933-A.D.- beneficiary. :Trademark-ation denied without explanation.
2	:Michelle: Reagan	:Arizona-State-Secretary	07/25/15	7006 3450 0003 5691 3447	:Darrell-James: Hill, -:DOI-1776-A.D., et al.: AOC-1778-A.D., :CftUSofA-1787-A.D., -:Ohioan-©-1958-A.D. -:exclusive-peculiar-absolute-owner; -:EBA-1933-A.D.- beneficiary. :Trademark-ation denied without explanation.
3					
4					
5					
6					

1881



NOTE: PLEASE RETURN THIS FORM ALONG WITH YOUR FILING. YOU MUST COMPLETE A NEW APPLICATION – DO NOT SIMPLY USE CORRECTION FLUID OR “SCRATCH OUTS.”

We are unable to process your application for the following reasons:

- Filing fee was not received. Trade names are \$10 and trademarks are \$15. Amendments are \$3.
- A.R.S. 44-1460 requires that a trade name registration be submitted on an application prescribed by the Arizona Secretary of State. Please complete the enclosed application.
- Mailed registrations must include the notarized signature(s) of the applicant(s).
- Your registration has expired. Please complete a new registration form and refer to the original file number.
- Trade names/trademarks cannot be altered using a renewal, amendment or assignment form. Instead, please submit a new trade name registration form.
- Trade name and trademark ownership cannot be changed using a renewal or amendment form. The current owner on record must file an **Assignment Form** and must sign as “Assignor” and the proposed new owner must sign as “Assignee”.
- The applicant/assignee is a corporation or LLC and is not authorized to transact business in the state of Arizona by the Arizona Corporation Commission OR the corporation/LLC application is still pending OR the corporation/ LLC is not in good standing.
- Trade names cannot include a corporate designation. Please delete
- Trademarks require 3 samples of how the mark will be used (flyers, business cards, letterhead, etc.). One of the samples should be on 8 ½ X 11” paper. In addition, you must provide a **written** description that **fully** describes your mark so that proper referencing is performed to ensure availability.
- A classification number was not listed
- The name/mark you are attempting to register is too generic or is in conflict with _____, which appears in our database.
- When making corrections please complete a new application. Your application is a public record and a legal document therefore correction fluid or “scratch outs” are **NOT** permitted.
- When you reserve a name with the Arizona Corporation Commission you **cannot** register the trade name until your corporation/LLC is approved. If not forming a corporation/LLC you must wait until reservation expires, or terminate/cancel the reservation prior to submitting the trade name registration.
- To remove a deceased applicant, please provide a copy of the death certificate and a will identifying you as the beneficiary of the registration. If a will does not exist please provide a notarized affidavit stating so and identify your legal standing as the rightful owner of the registration. (e.g. you are the surviving spouse or child of the deceased).
- WE CAN NOT REGISTER AN INDIVIDUAL'S PLEASE ADD A DESCRIPTIVE WORD TO THE NAME.

06/25/2015 MD

2022-011769 MISC Page: 184 of 2782

09/26/2022 03:35:37 PM Receipt #: 22-9381
Rec Fee: \$30.00 Darrell James Hill
Gila County, Az, Sadie Jo Bingham, Recorder



185

POSTAL # 00 115462391

09/26/2022 03:35:37 PM Receipt #: 22-9381
Rec Fee: \$30.00 Darrell James Hill
Gila County, Az, Sadie Jo Bingham, Recorder



MICHELE REAGAN
Secretary of State

**State of Arizona – Office of the Secretary of State
Trademark/Service Mark A**

SEND BY MAIL TO:

Secretary of State Michele Reagan, Atten: Trade Name/Trademark Division
1700 W. Washington Street, FL 7, Phoenix, AZ 85007-2808

OR return this application in person:

PHOENIX - State Capitol Executive Tower, 1700 W. Washington Street, 1st Fl., Room 103
TUCSON - Arizona State Complex, 400 W. Congress, 1st Fl., Suite 141
Office Hours: Monday through Friday, 8 a.m. to 5 p.m., except state holidays.

IN-PERSON ONLY - We accept major credit cards and bank debit cards.

PLEASE NOTE: The registration of a Trademark is not legally required in Arizona, but is an accepted business practice. The registration is a public record and does not constitute exclusive rights to the holder of the Trademark.

FOR OFFICE USE ONLY
SOSBSTM Rev. 3/12/2015

APPLICANT INSTRUCTIONS

First time applicants shall use this form to apply for a Trademark/Service Mark under A.R.S. §§ 44-1441 to 44-1455. Applicants must be at least 18. This application must be signed, dated and notarized.
Trade Name/Renewal/Address Change: To register a Trade Name, DO NOT use this form. Use the Trade Name Registration Application. To renew a Trademark, use the Trademark Renewal form. To report a change of address use the Trade Mark Amendment form.
Processing: 2-3 weeks; expedited service (24-48 hours) available.

Be Accurate: Complete all applicable fields on this form. Write legibly; or fill out this application online at www.azsos.gov and print it.
Filing Fee and Payment: \$15; expedited service, include an additional \$25. If filing by mail, make checks or money orders payable to the: Secretary of State.
Questions? Call (602) 542-6187; in-state/toll-free (800) 458-5842.
Website: All forms are available on the Secretary of State's Website, www.azsos.gov.

1. Trademark/Service Mark information				SPACE BELOW FOR OFFICE USE ONLY VALIDATION AREA			
Written Description: Provide an accurate written description of your mark (logo or symbol)							
For the Times New Roman,							
fixed pitch of the type size of the font 12 ratio,							
in the all upper case lettering:							
BEVERLY (1 space) JEAN (1 space)							
ROMERO- (1 space) HILL ;							
to wit: "BEVERLY JEAN ROMERO- HILL"							
The date in which the Mark was first used by the applicant.	Month 06	Day 15	Year 1958	Date the mark was first used in Arizona. This date must be today or prior to today's date.	Month 10	Day 08	Year 1982
2. Entity Type and Owner Name							
What type of person or entity will function as the owner of this trademark? Enter the entity or person(s) name. CHOOSE ONLY ONE.							
<input checked="" type="checkbox"/> A. SOLE PROPRIETORSHIP (one person)		<input type="checkbox"/> B. ASSOCIATION		<input type="checkbox"/> C. ORGANIZATION			
Applicant First and Last Name BEVERLY ROMERO- HILL		Association Name		Organization Name			
<input type="checkbox"/> D. PARTNERSHIP [List name(s)]							
Either provide the partnership name(s) OR multiple individuals by the Applicants' First and Last Name							
<input type="checkbox"/> E. CORPORATION *				<input type="checkbox"/> F. LIMITED LIABILITY COMPANY (LLC) *			
Corporation Name				Limited Liability Company Name			
*Corporation/LLC: If checked the applicant must be on the Arizona Corporation Commission's website as a member/officer. The application will be returned if not incorporated.							
<input type="checkbox"/> G. FOREIGN CORPORATION Licensed to do business in Arizona				<input type="checkbox"/> H. OTHER (if other, please indicate type. Examples: firm, society, foundation, federation)			
Foreign Corporation Name				Other Name			
3. Products or Goods							
Provide a description of goods on which this mark is used							
Documents, labels, signs, inventory items							
4. Contact information Addresses must be complete as they are used to mail certificates and renewal notices							
Mailing Address C/O 5124 East 18TH Avenue					Apt., Space, Suite, or Floor #		
City Apache Junction		State Arizona	Zip Code 85119		Business Phone Number (480) 276.1014		

Continued on page 2

186



Continued from page 1

5. Trademark/Service Mark Samples

Attach three samples of the trademark/service mark with this application on 8 1/2 by 11 inch (letter) paper that can be photocopied clearly. Examples: letterhead, business card, advertisement, etc.

Classification Number(s) (Refer to the Trade Name & Trademark book)
 16, 42, 43

6. Applicant's Signature - If two applicants are listed under Section 2D both must sign. Each signature requires a separate notarization.

1 st Signer's Printed First and Last Name BEVERLY ROMERO- HILL	1 st Signer's Signature BEVERLY JEAN ROMERO HILL	Month 06	Day 23	Year 15
--	--	-------------	-----------	------------

State of Arizona }
 County of Maricopa }

On this 23 day of June, 20 15

Beverly Jean Romero - Hill
 (Name of Person Appearing Before the Notary)

personally appeared before me and acknowledged that he/she signed this document for its stated purpose.

[Signature]
 Notary Public

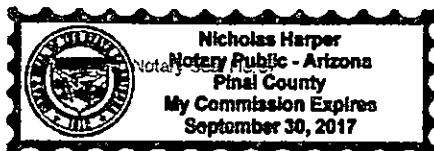

2 nd Signer's Printed (If applicable) First and Last Name	2 nd Signer's Signature	Month	Day	Year
--	------------------------------------	-------	-----	------

State of Arizona }
 County of _____ }

On this _____ day of _____, 20 _____

(Name of Person Appearing Before the Notary)

personally appeared before me and acknowledged that he/she signed this document for its stated purpose.

 Notary Public

(Place Notary Seal Here)

- I have enclosed a check or money order for \$15 made payable to "Secretary of State"
- I have attached three samples with this registration form as requested in Section 5.

Unofficial



187

BEVERLY JEAN ROMERO- HILL

BEVERLY JEAN ROMERO- HILL

BEVERLY JEAN ROMERO- HILL

100

2022-011769 MISC Page: 187 of 2782
09/26/2022 03:35:37 PM Receipt #: 22-9381
Rec Fee: \$30.00 Darrell James Hill
Gila County, Az, Sadie Jo Bingham, Recorder



1140 dd 11270 45 10



MICHELE REAGAN Secretary of State

State of Arizona - Office of the Secretary of State Trade Name Registration Application

SEND BY MAIL TO: Secretary of State Michele Reagan, Atten: Trade Name/Trademark Division 1700 W. Washington Street, FL 7, Phoenix, AZ 85007-2808

OR return this application in person: PHOENIX - State Capitol Executive Tower, TUCSON - Arizona State Complex, 1700 W. Washington Street, 1st Fl., Room 103 400 W. Congress, 1st Fl., Suite 141 Office Hours: Monday through Friday, 8 a.m. to 5 p.m., except state holidays. IN-PERSON ONLY - We accept major credit cards and bank debit cards.

PLEASE NOTE: The registration of a Trade Name is not legally required in Arizona, but is an accepted business practice. The registration is a public record and does not constitute exclusive rights to the holder of the Trade Name.

DO NOT WRITE IN THIS SPACE

FOR OFFICE USE ONLY SOSBSTN REV. 3/12/2015

Page: 188 of 2782

2022-011769 MISC 09/26/2022 03:35:37 PM

Rec Fee: \$30.00 Darrell James Hill, Recorder Gila County, Az, Sadie Jo Bingham

APPLICANT INSTRUCTIONS

First time applicants shall use this form to apply for a Trade Name under A.R.S. § 44-1460. Applicants must be at least 18. This application must be signed, dated and notarized.

Trademark/Renewal/Address Change: To register a Trademark, DO NOT use this form. Use the Trademark Registration Application. To renew a Trade Name, use the Trade Name Renewal form. To report a change of address use the Trade Name Amendment form.

Processing: 2-3 weeks; expedited service (24-48 hours) available.

Be Accurate: Complete all applicable fields on this form. Write legibly. Fill out this application online at www.azsos.gov and print it.

Filing Fee and Payment: \$10; expedited service, include an additional \$25. If filing by mail, make checks or money orders payable to the Secretary of State.

Questions? Call (602) 542-6187; in-state/toll-free (800) 458-5842 Website: All forms are available on the Secretary of State's Website www.azsos.gov.

1. Name, title or designation to be registered

Trade Name (Names with a corporate ending are unacceptable. Examples: Inc., LLC, or Ltd.)

BEVERLY JEAN ROMERO- HILL

The date which the name above was first used by the applicant in Arizona. This date must be today or prior to today's date.

Month 10 Day 08 Year 1982

2. Entity Type and Owner Name

What type of person or entity functions as the owner of this trade name? Enter the entity or person(s) name. CHOOSE ONLY ONE.

A. [X] SOLE PROPRIETORSHIP (one person)

B. [] ASSOCIATION

C. [] ORGANIZATION

Applicant First and Last Name

Association Name

Organization Name

BEVERLY ROMERO- HILL

D. [] PARTNERSHIP (List name(s))

Either provide the partnership name(s) OR multiple individuals by the Applicants' First and Last Name

E. [] CORPORATION *

Corporation Name

F. [] LIMITED LIABILITY COMPANY (LLC) *

Limited Liability Company Name

*Corporation/LLC: If checked the applicant must be on the Arizona Corporation Commission's website as a member/officer. The application will be returned if not incorporated.

G. [] FOREIGN CORPORATION Licensed to do business in Arizona

Foreign Corporation Name

H. [] OTHER (If other, please indicate type. Examples: firm, society, foundation, federation)

Other Name

3. Nature of Business

General nature of business conducted

BUSINESS LIASON FOR SECURED PARTY

4. Contact Information - addresses must be complete as they are used to mail certificates and renewal notices

Mailing Address

C/O 5124 East 18th Avenue

Apt., Space, Suite, or Floor #

City Apache Junction

State Arizona

Zip Code 85119

Business Phone Number (480) 276.1014

5. Applicant's Signature - If two applicants are listed in Section 2D, both must sign.

1st Signer's Printed Name

BEVERLY JEAN ROMERO- HILL

2nd Signer's Printed Name (if applicable)

1st Signer's Signature

BEVERLY JEAN ROMERO- HILL

Date

06/23/15

2nd Signer's Signature

Date

State of Arizona County of Pinal

State of Arizona County of

On this 23 day of June, 2015

On this ___ day of ___, 20__

Beverly Romero-Hill (Name of Person Appearing Before the Notary) personally appeared before me and acknowledged that he/she signed this document for it's stated purpose.

(Name of Person Appearing Before the Notary) personally appeared before me and acknowledged that he/she signed this document for it's stated purpose.

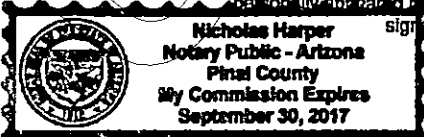

(Notary Public)

(Notary Public)

SEND

- Complete items 1, 2, and 3. Also complete item 4 if Restricted Delivery is desired.
- Print your name and address on the reverse so that we can return this card to you.
- Use a pen or ballpoint pen for best results.

1. Addressee Name

Secretary of State
 Michele Reagan, Attn;
 1700 W. Washington Street, FL 7,
 Phoenix, Arizona 85007-2808

A. Signature

[Handwritten Signature]
 Agent
 Addressee

B. Restricted Delivery
 D. Is delivery address outside the United States? Yes
 If YES, enter delivery address below No

U.S. POSTAL SERVICE

JUN 25 2015

B. Service Type **85009**
 Certified Mail Express Mail
 Registered Return Receipt for Merchandise
 Insured Mail C.O.D.

A. Restricted Delivery? (Extra Fee) Yes

2. Article Number

7008 1300 0002 2256 4613

PS Form 3811, February 2004

Domestic Return Receipt

1025-1504

UNITED STATES POSTAL SERVICE

PHOENIX AZ 852

25 JUN '15



First-Class Mail
 Postage & Fees Paid
 USPS
 Permit No. G-10

• Sender: Please print your name, address, and ZIP+4 in this box •

BEVERLY JEAN ROMERO-HILL
 C/O 5124 East 18th Street
 Apache Junction, Arizona 85119



1910

2022-011769 MISC Page: 189 of 2782
 09/26/2022 03:35:37 PM Receipt #: 22-9381
 Rec Fee: \$30.00 Darrell James Hill
 Gila County, Az, Sadie Jo Bingham, Recorder





NOTE: PLEASE RETURN THIS FORM ALONG WITH YOUR FILING. YOU MUST COMPLETE A NEW APPLICATION – DO NOT SIMPLY USE CORRECTION FLUID OR “SCRATCH OUTS.”

We are unable to process your application for the following reasons:

- Filing fee was not received. Trade names are \$10 and trademarks are \$15. Amendments are \$3.
- A.R.S. 44-1460 requires that a trade name registration be submitted on an application prescribed by the Arizona Secretary of State. Please complete the enclosed application.
- Mailed registrations must include the notarized signature(s) of the applicant(s).
- Your registration has expired. Please complete a new registration form and refer to the original file number.
- Trade names/trademarks cannot be altered using a renewal, amendment or assignment form. Instead, please submit a new trade name registration form.
- Trade name and trademark ownership cannot be changed using a renewal or amendment form. The current owner on record must file an **Assignment Form** and must sign as “Assignor” and the proposed new owner must sign as “Assignee”.
- The applicant/assignee is a corporation or LLC and is not authorized to transact business in the state of Arizona by the Arizona Corporation Commission OR the corporation/LLC application is still pending OR the corporation/ LLC is not in good standing.
- Trade names cannot include a corporate designation. Please delete
Trademarks require 3 samples of how the mark will be used (flyers, business cards, letterhead, etc.). One of the samples should be on 8 ½ X 11” paper. In addition, you must provide a **written** description that **fully** describes your mark so that proper referencing is performed to ensure availability.
- A classification number was not listed
- The name/mark you are attempting to register is too generic or is in conflict with _____, which appears in our database.
- When making corrections please complete a new application. Your application is a public record and a legal document therefore correction fluid or “scratch outs” are **NOT** permitted.
- When you reserve a name with the Arizona Corporation Commission you **cannot** register the trade name until your corporation/LLC is approved. If not forming a corporation/LLC you must wait until reservation expires, or terminate/cancel the reservation prior to submitting the trade name registration.
- To remove a deceased applicant, please provide a copy of the death certificate and a will identifying you as the beneficiary of the registration. If a will does not exist please provide a notarized affidavit stating so and identify your legal standing as the rightful owner of the registration. (e.g. you are the surviving spouse or child of the deceased).
- WE CAN NOT REGISTER AN INDIVIDUAL'S PLEASE ADD A DESCRIPTIVE WORD TO THE NAME.

06/25/2015 MD

2022-011769 MISC Page: 190 of 2782
09/26/2022 03:35:37 PM Receipt #: 22-9381
Rec Fee: \$30.00 Darrell James Hill
Gila County, Az, Sadie Jo Bingham, Recorder



11/0 22 / 15762500



MICHELE REAGAN
Secretary of State

**State of Arizona – Office of the Secretary of State
Trademark/Service Mark Application**

SEND BY MAIL TO:

Secretary of State Michele Reagan, Attn: Trade Name/Trademark Division
1700 W. Washington Street, FL. 7, Phoenix, AZ 85007-2808

OR return this application in person:

PHOENIX - State Capitol Executive Tower, 1700 W. Washington Street, 1st Fl., Room 103
TUCSON - Arizona State Complex, 400 W. Congress, 1st Fl., Suite 141
Office Hours: Monday through Friday, 8 a.m. to 5 p.m., except state holidays.

IN-PERSON ONLY - We accept major credit cards and bank debit cards.

PLEASE NOTE: The registration of a Trademark is not legally required in Arizona, but is an accepted business practice. The registration is a public record and does not constitute exclusive rights to the holder of the Trademark.

DO NOT WRITE IN THIS SPACE

FOR OFFICE USE ONLY
SOSBSTMR Rev. 3/12/2015

Page: 191 of 2782

2022-011769 MISC
09/26/2022 03:35:37 PM
Rec Fee: \$30.00
Darrell James Hill
Gila County, Az, Sadie Jo Bingham, Recorder

APPLICANT INSTRUCTIONS

First time applicants shall use this form to apply for a Trademark/Service Mark under A.R.S. §§ 44-1441 to 44-1455. Applicants must be at least 18. This application must be signed, dated and notarized.

Trade Name/Renewal/Address Change: To register a Trade Name, DO NOT use this form. Use the Trade Name Registration Application. To renew a Trademark, use the Trademark Renewal form. To report a change of address use the Trade Mark Amendment form.

Processing: 2-3 weeks; expedited service (24-48 hours) available.

Be Accurate: Complete all applicable fields on this form. Write or fill out this application online at www.azsos.gov and print it.
Filing Fee and Payment: \$15; expedited service, include an additional \$25. If filing by mail, make checks or money orders to the: Secretary of State.

Questions? Call (602) 542-6187; in-state/toll-free (800) 458-5
Website: All forms are available on the Secretary of State's www.azsos.gov

1. Trademark/Service Mark information

SPACE BELOW FOR OFFICE USE ONLY VALIDATION

Written Description: Provide an accurate written description of your mark (logo or symbol)

For the Times New Roman,
fixed pitch of the type size of the font 12 ratio,
in the all upper case lettering:
DARRELL (1 space) JAMES(1 space)
HILL ; to wit: "DARRELL JAMES HILL"

The date in which the Mark was first used by the applicant.	Month 11	Day 20	Year 1958	Date the mark was first used in Arizona. This date must be today or prior to today's date.	Month 08	Day 15	Year 1986
---	-------------	-----------	--------------	--	-------------	-----------	--------------

2. Entity Type and Owner Name

What type of person or entity will function as the owner of this trademark? Enter the entity or person(s) name. CHOOSE ONLY ONE.

<input checked="" type="checkbox"/> A. SOLE PROPRIETORSHIP (one person)	<input type="checkbox"/> B. ASSOCIATION	<input type="checkbox"/> C. ORGANIZATION
Applicant First and Last Name DARRELL HILL	Association Name	Organization Name

D. PARTNERSHIP [List name(s)]
Either provide the partnership name(s) OR multiple individuals by the Applicants' First and Last Name

<input type="checkbox"/> E. CORPORATION *	<input type="checkbox"/> F. LIMITED LIABILITY COMPANY (LLC) *
Corporation Name	Limited Liability Company Name

*Corporation/LLC: If checked the applicant must be on the Arizona Corporation Commission's website as a member/officer. The application will be returned if not incorporated.

<input type="checkbox"/> G. FOREIGN CORPORATION Licensed to do business in Arizona	<input type="checkbox"/> H. OTHER (if other, please indicate type. Examples: firm, society, foundation, federation)
Foreign Corporation Name	Other Name

3. Products or Goods

Provide a description of goods on which this mark is used
Documents, labels, signs, inventory items

4. Contact Information Addresses must be complete as they are used to mail certificates and renewal notices.

Mailing Address C/O 5124 East 18TH Avenue			Apt., Space, Suite, or Floor #	
City Apache Junction	State Arizona	Zip Code 85119	Business Phone Number (602) 618.4595	

Continued on page 2

692



Continued from page 1

5. Trademark/Service Mark Samples
 Attach three samples of the trademark/service mark with this application on 8 1/2 by 11 inch (letter) paper that can be photocopied clearly. Examples: letterhead, business card, advertisement, etc.
 Classification Number(s) (Refer to the Trade Name & Trademark book)
 16, 42, 43

6. Applicant's Signature - If two applicants are listed under Section 2D both must sign. Each signature requires a separate notarization.

1 st Signer's Printed First and Last Name DARRELL HILL	1 st Signer's Signature DARRELL JAMES HILL	Month 06	Day 23	Year 2015
--	--	-------------	-----------	--------------

State of Arizona)
 County of Pinal)

On this 23 day of June, 2015

Darrell Hill
 (Name of Person Appearing Before the Notary)

personally appeared before me and acknowledged that he/she signed this document for its stated purpose.

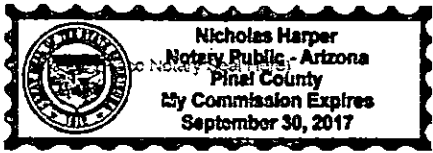

[Signature]
 Notary Public

2 nd Signer's Printed (if applicable) First and Last Name	2 nd Signer's Signature	Month	Day	Year
--	------------------------------------	-------	-----	------

State of Arizona)
 County of)

On this ___ day of ___, 20__

(Name of Person Appearing Before the Notary)

personally appeared before me and acknowledged that he/she signed this document for its stated purpose.

(Place Notary Seal Here)

Notary Public

- I have enclosed a check or money order for \$15 made payable to "Secretary of State"
- I have attached three samples with this registration form as requested in Section 5.

Unofficial

10/3

Trademark Sample Sheet for DARRELL JAMES HILL

DARRELL JAMES HILL

DARRELL JAMES HILL

DARRELL JAMES HILL

Unofficial Copy

19/4

2022-011769 MISC Page: 193 of 2782
09/26/2022 03:35:37 PM Receipt #: 22-9381
Rec Fee: \$30.00 Darrell James Hill
Gila County, Az, Sadie Jo Bingham, Recorder



11/0 22715962367



MICHELE REAGAN Secretary of State

State of Arizona - Office of the Secretary of State Trade Name Registration Application

SEND BY MAIL TO: Secretary of State Michele Reagan, Atten: Trade Name/Trademark Division 1700 W. Washington Street, FL 7, Phoenix, AZ 85007-2808

OR return this application in person: PHOENIX - State Capitol Executive Tower, 1700 W. Washington Street, 1st Fl., Room 103 TUCSON - Arizona State Complex, 400 W. Congress, 1st Fl., Suite 141 Office Hours: Monday through Friday, 8 a.m. to 5 p.m., except state holidays. IN-PERSON ONLY - We accept major credit cards and bank debit cards.

PLEASE NOTE: The registration of a Trade Name is not legally required in Arizona, but is an accepted business practice. The registration is a public record and does not constitute exclusive rights to the holder of the Trade Name.

DO NOT WRITE IN THIS SPACE

FOR OFFICE USE ONLY SOSBSTN REV. 3/12/2015

Page: 194 of 2782

2022-011769 MISC

09/26/2022 03:35:37 PM

Rec Fee: \$30.00

Darrell James Hill

Gila County, Az, Sadie Jo Bingham, Recorder

APPLICANT INSTRUCTIONS

First time applicants shall use this form to apply for a Trade Name under A.R.S. § 44-1460. Applicants must be at least 18. This application must be signed, dated and notarized.

Trademark/Renewal/Address Change: To register a Trademark, DO NOT use this form. Use the Trademark Registration Application. To renew a Trade Name, use the Trade Name Renewal form. To report a change of address use the Trade Name Amendment form.

Processing: 2-3 weeks; expedited service (24-48 hours) available.

Be Accurate: Complete all applicable fields on this form. Write leg fill out this application online at www.azsos.gov and print it.

Filing Fee and Payment: \$10; expedited service, include an addi \$25. If filing by mail, make checks or money orders payable to the Secretary of State.

Questions? Call (602) 542-6187; in-state/toll-free (800) 458-5842 Website: All forms are available on the Secretary of State's Webs www.azsos.gov.

1. Name, title or designation to be registered * SPACE BELOW FOR OFFICE USE ONLY - VALIDATION

Trade Name (Names with a corporate ending are unacceptable. Examples: Inc., LLC. or Ltd.) DARRELL JAMES HILL

The date which the name above was first used by the applicant in Arizona. This date must be today or prior to today's date. Month 08 Day 15 Year 1986

2. Entity Type and Owner Name

What type of person or entity functions as the owner of this trade name? Enter the entity or person(s) name. CHOOSE ONLY ONE:

A. SOLE PROPRIETORSHIP (one person) B. ASSOCIATION C. ORGANIZATION Applicant First and Last Name Association Name Organization Name DARRELL HILL

D. PARTNERSHIP (List name(s)) Either provide the partnership name(s) OR multiple individuals by the Applicants' First and Last Name

E. CORPORATION * F. LIMITED LIABILITY COMPANY (LLC) * Corporation Name Limited Liability Company Name

*Corporation/LLC: If checked the applicant must be on the Arizona Corporation Commission's website as a member/officer. The application will be returned if not incorporated.

G. FOREIGN CORPORATION Licensed to do business in Arizona H. OTHER (If other, please indicate type. Examples: firm, society, foundation, federation) Foreign Corporation Name Other Name

3. Nature of Business

General nature of business conducted BUSINESS LIASON FOR SECURED PARTY

4. Contact Information Addresses must be complete as they are used to mail certificates and renewal notices

Mailing Address C/O 5124 East 18th Avenue Apt., Space, Suite, or Floor # City Apache Junction State Arizona Zip Code 85119 Business Phone Number (602) 618.4595

5. Applicant's Signature - If two applicants are listed in Section 2D, both must sign.

1st Signer's Printed Name DARRELL JAMES HILL 2nd Signer's Printed Name (if applicable) 1st Signer's Signature DARRELL JAMES HILL Date 06-23-2015 2nd Signer's Signature Date

State of Arizona Pinal County On this 03 day of June, 2015 State of Arizona County of On this day of, 20

19/5 Darrell Hill (Name of Person Appearing Before the Notary)

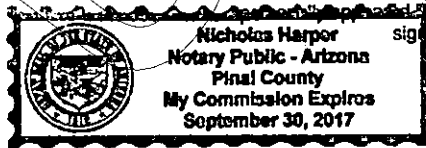

(Name of Person Appearing Before the Notary) signed this document for it's stated purpose. (Notary Public)

(Name of Person Appearing Before the Notary) personally appeared before me and acknowledged that he/she signed this document for it's stated purpose.

(Notary Public)

AZ 852

25 JUN 15



First-Class Mail
Postage & Fees Paid
USPS
Permit No. G-10

• Sender: Please print your name, address, and ZIP+4 in this box •

DARRELL JAMES HILL
C/O 5124 East 18th Street
Apache Junction, Arizona 85119



SENDER: COMPLETE THIS SECTION

- Complete items 1, 2, and 3. Also complete item 4 if Restricted Delivery is desired.
- Print your name and address on the reverse so that we can return the card to you.
- Attach this card to the back of the mailpiece, or on the front if space permits.

1. Article Addressed to:

Secretary of State
Michele Reagan, Atten;
1700 W. Washington Street, FL 7,
Phoenix, Arizona 85007-2808

2. Article Number
(Transfer from service label)

7006 3450 0003 2691 3447

COMPLETE THIS SECTION ON DELIVERY

A. Signature

Darrell James Hill
B. Received by (Printed Name) Agent
C. Date of Delivery

D. Is delivery address different from item 1? Yes
If YES, enter delivery address below No

PHOENIX, ARIZONA
JUN 25 2015

3. Service Type

- Certified Mail Express Mail
- Registered Return Receipt for Merchandise
- Insured Mail G.O.D.

4. Restricted Delivery? (Extra Fee)

Yes

Unofficial Copy

1916



:2016 A.D.

#	:man- trustee	:association	:year, :day	USPO, other	:covenant
1	:Victor: Suarez-Melendez	:Puerto-Rico- United-States, -:Secretary of State	01/03/16	RE 817 542 585 US	:Darrell-James: Hill, -:Ohioan- beneficiary: EBA-1933-A.D. - Conditional- Acceptance re: response: "... we don't have jurisdiction over the matter.' 01/03/16
2	:Francisco-J.: Rodriguez-Bernier	:Puerto-Rico- United-States, -:Asst. Secretary of State, Comm.-Transactions-Registry	↓	↓	↓
3	:Victor: Suarez-Melendez	:Puerto-Rico- United-States, -:Secretary of State	01/03/16	RE 817 542 585 US	:Beverly-Jean: Romero- Hill, -:New-Mexican- beneficiary: EBA-1933-A.D. - Conditional- Acceptance re: response: "... we don't have jurisdiction over the matter.' 01/03/16"
4	:Francisco-J.: Rodriguez-Bernier	:Puerto-Rico- United-States, -:Asst. Secretary of State, Comm.-Transactions-Registry	↓	↓	↓
5	:Melba: Acosta-Febo	:Puerto-Rico- United-States, -:Secretary of State	01/20/16	First-Class- Mail	UCC1PR recordation for the account of the Cesuti-Que-Use of the EBA-1933-A.D.- U.S.- indenture to the Ohioan- Darrell-James: Hill- debenture with the idem-sonans- subrogation-

197

					entitled: DARRELL JAMES HILL, et al. - derivatives.
6	:Melba: Acosta-Febo	:Puerto-Rico- United-States, -:Secretary of State	↓	↓	UCC1PR recordation for the account of the Cesuti-Que-Use of the EBA-1933-A.D.- U.S.- indenture to the New-Mexican- Beverly-Jean: Romero- Hill- debenture with the idem-sonans-subrogation- entitled: BEVERLY JEAN ROMERO, et al. - derivatives.
7	:Francisco-J.: Rodriquez-Bernier	:Puerto-Rico- United-States, -:Asst. Secretary of State, Comm.-Transactions-Registry	01/20/16	First-Class- Mail	:Darrell-James: Hill, -:Ohioan- beneficiary: EBA-1933-A.D. - Denial- Continured of the UCC1PR re: response: '... security-agreement has to be authenticated by the signatures of the debtor and the secured party.' 01/20/16
8	:Francisco-J.: Rodriquez-Bernier	:Puerto-Rico- United-States, -:Asst. Secretary of State, Comm.-Transactions-Registry	↓	↓	:Beverly-Jean: Romero- Hill, -:New-Mexican- beneficiary: EBA-1933-A.D. - Denial- Continured of the UCC1PR re: response: '... security-agreement has to be authenticated by the signatures of the debtor and the secured party.' 01/20/16

867
198



*Commonwealth of Puerto Rico
Department of State
San Juan, Puerto Rico*

Darrell James Hill
5124 East 18th Avenue
Apache Junction, Arizona 85119

Dear Darrell James Hill:

Reference is made, to the UCC Financing Statement that you sent on June 30, 2015 to be filed at the Commercial Transaction Registry of the Department State of Puerto Rico. We are rejecting the document because we don't have jurisdiction over the subject matter.

Also, our statute says that: the debtor means the person who owes payment or other performance of the obligation secured, and the secured party means a lender, seller or other person in whose favor there is a security interest. In this context they must be different persons.

Enclosed is the money order for \$25.00 with serial number [REDACTED].

Cordially,

Francisco J. Rodriguez Bernier
Assistant Secretary of State for Services
Commercial Transactions Registry

2022-011769 MISC Page: 198 of 2782
09/26/2022 03:35:37 PM Receipt #: 22-9381
Rec Fee: \$30.00 Darrell James Hill
Gila County, Az, Sadie Jo Bingham, Recorder



199



Registered Mail/number
RE 006 875 501 US
m/o 22715962547
\$2500

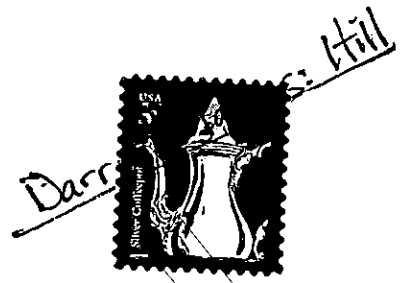

DECLARACIÓN DE FINANCIAMIENTO / FINANCING STATEMENT
SIGA INSTRUCCIONES / FOLLOW INSTRUCTIONS

A. NOMBRE Y NÚMERO DE CONTACTO (opcional) / NAME & PHONE OF CONTACT AT FILER (optional)

B. CORREO ELECTRÓNICO DE CONTACTO (opcional) / E-MAIL CONTACT AT FILER (optional)

C. ENVIAR CONFIRMACIÓN A (Nombre y Dirección): / SEND ACKNOWLEDGMENT TO: (Name and Address)

DARRELL JAMES HILL
5124 EAST 18TH AVENUE
APACHE JUNCTION, ARIZONA 85119

EL ESPACIO ARRIBA ES PARA USO DEL OFICIAL DE REGISTRO
THE ABOVE SPACE IS FOR FILING OFFICE USE ONLY

1. NOMBRE DEL DEUDOR / DEBTOR'S NAME: Provea sólo un nombre de Deudor (1a o 1b) (use el nombre completo y exacto, no omita, modifique o abrevie ningún componente del nombre); si algún aparte del nombre del Deudor no cabe en la línea 1b, déjela en blanco, marque aquí y provea la información del Deudor Individual en el renglón 10 del Anejo a la Declaración de Financiamiento (Forma UCC1AdPR) / Provide only one Debtor name (1a or 1b) (use exact, full name; do not omit, modify, or abbreviate any part of the Debtor's name); if any part of the Individual Debtor's name will not fit in line 1b, leave all of item 1 blank, check here and provide the Individual Debtor information in item 10 of the Financing Statement Addendum (Form UCC1AdPR)

1a. NOMBRE DE LA ENTIDAD / ORGANIZATION'S NAME
DARRELL JAMES HILL

OR

1b. APELLIDO / INDIVIDUAL'S SURNAME
--

NOMBRE / FIRST PERSONAL NAME
--

SEGUNDO NOMBRE / ADDITIONAL NAME
--

SUFIJOS / SUFFIX
--

1c. DIRECCIÓN POSTAL / MAILING ADDRESS
5124 EAST 18TH AVENUE

CIUDAD / CITY
APACHE JUNCTION

ESTADO / STATE
AZ

CÓDIGO POSTAL / POSTAL CODE
85119

PAÍS / COUNTRY
USA

2. NOMBRE DEL DEUDOR/ DEBTOR'S NAME: Provea sólo un Deudor adicional (2a o 2b) (Use el nombre completo y exacto; no omita, modifique o abrevie ninguna parte del nombre). Si cualquier parte de un nombre no cupiera en el el espacio provisto en la 2b, deje toda la sección 2 en blanco, marque aquí y provea el nombre completo en el renglón 10 en el Anejo de la Declaración de Financiamiento (Forma UCC1AdPR) / Provide only one Debtor name (2a or 2b) (use exact, full name; do not omit, modify, or abbreviate any part of the Debtor's name); if any part of the Individual Debtor's name will not fit in line 2b, leave all of item 2 blank, check here and provide the Individual Debtor information in item 10 of the Financing Statement Addendum (Form UCC1AdPR)

2a. NOMBRE DE LA ENTIDAD / ORGANIZATION'S NAME
--

OR

2b. APELLIDO / INDIVIDUAL'S SURNAME
--

NOMBRE / FIRST PERSONAL NAME
--

SEGUNDO NOMBRE / ADDITIONAL NAME
--

SUFIJOS / SUFFIX
--

2c. DIRECCIÓN / MAILING ADDRESS
--

CIUDAD / CITY
--

ESTADO / STATE
--

CÓDIGO POSTAL / POSTAL CODE
--

PAÍS / COUNTRY
--

3. NOMBRE DEL ACREEDOR GARANTIZADO (o NOMBRE DE CESIONARIO): Provea solo un nombre de Acreedor Garantizado (3a o 3b)
SECURED PARTY'S NAME (or NAME of ASSIGNEE): Provide only one Secured Party name (3a or 3b)

3a. NOMBRE DE LA ENTIDAD / ORGANIZATION'S NAME
--

OR

3b. APELLIDO / INDIVIDUAL'S SURNAME
Hill

NOMBRE / FIRST PERSONAL NAME
Darrell

SEGUNDO NOMBRE / ADDITIONAL NAME
James

SUFIJOS / SUFFIX
--

3c. DIRECCIÓN POSTAL / MAILING ADDRESS
c/o 5124 East 18th Avenue

CIUDAD / CITY
Apache Junction

ESTADO / STATE
Ariz

CÓDIGO POSTAL / POSTAL CODE
--

PAÍS / COUNTRY
USofA

4. COLATERAL: Esta declaración de financiamiento cubre la siguiente colateral: / COLLATERAL: This financing statement covers the following collateral:

For the Security "trust" Agreement covers: A) all of the hereditary and principal collateral inherent in the "DARRELL JAMES HILL", OHIO DEPARTMENT OF HEALTH..., CERTIFICATE OF LIVE BIRTH... engendered TRUST substantiated to the Principal and beneficiary upon the Birth, et seq., inclusive of all assets and debts that have been, exist now and that will be; and: B) all of the identification and agreement of the parties, of the parties' functional and binding contracts, of the rights of the use of the trade name and trademark, and of the quality and extent of the indemnification of the secured party by the debtor. See Item 17: Exhibit A: Security Agreement DJH001-SA....

5. Marque solo si aplica y solo una opción: Colateral está en posesión de un Fideicomiso (véase UCC1AdPR, renglón 7 e instrucciones) administrado por Representante de un difunto. Check only if applicable and check only one box: Collateral is held in a Trust (See UCC1AdPR, Item 17 and instructions) being administered by a Decedent's Personal Representative

6a. Marque solo si aplica y una sola alternativa / Check only if applicable and check only one box:
 Transacción de Financiamiento Público / Public-Finance Transaction Transacción de Casa Prefabricada / Manufactured-Home Transaction Un Deudor es una entidad transmisora / A Debtor is a Transmitting Utility

6b. Marque solo si aplica y solo una alternativa / Check only if applicable and check only one box:
 Gravamen Agrícola / Agricultural Lien Inscripción extraregistrarial / Non-UCC Filing

7. DESIGNACIÓN ALTERNA (si aplica) / ALTERNATIVE DESIGNATION (if applicable):
 Arrendador/Arrendatario / Lessee/Lessor Consignatario/ Consignador / Consignee/Consignor Vendedor/ Comprador / Seller/Buyer Depositario/ Fidor / Bailee/Bailor Concesionario/Concedente / Licensee/Licenser

8. DATOS OPCIONALES DE REFERENCIA PARA EL SOLICITANTE / OPTIONAL FILER REFERENCE DATA: Sent "3" ORIGINALS copies of the filing enclosed: please return 2 "Received" ORIGINALS copy in the SAE provided.

C OPIA OFICINA DE REGISTRO—DECLARACIÓN DE FINANCIAMIENTO (Forma UCC1PR) (Rev. 05/09/14)

207



Unofficial Copy

[INTENTIONALLY LEFT BLANK]

201

2022-011769 MISC Page: 200 of 2782
09/26/2022 03:35:37 PM Receipt #: 22-9381
Rec Fee: \$30.00 Darrell James Hill
Gila County, Az, Sadie Jo Bingham, Recorder





PUERTO RICO: FINANCING STATEMENT: UCC1PR, ITEM 17: DJR001-SA

REGISTERED MAIL Number
RE 006 875 501 US
US POSTAL m/o
22715962547
\$25.00

ITEM 17: Exhibit A: Security Agreement DJR001-SA

Unofficial Copy

2012

2022-011769 MISC Page: 201 of 2782
09/26/2022 03:35:37 PM Receipt #: 22-9381
Rec Fee: \$30.00 Darrell James Hill
Gila County, Az, Sadie Jo Bingham, Recorder



PUERTO RICO: FINANCING STATEMENT: UCC1PR, ITEM 17: DJR001-SA

[Faint, illegible text]

[INTENTIONALLY LEFT BLANK]

2022-011769 MISC Page: 202 of 2782
09/26/2022 03:35:37 PM Receipt #: 22-9381
Rec Fee: \$30.00 Darrell James Hill
Gila County, Az, Sadie Jo Bingham, Recorder



ITEM 17: DJR001-SA



2022-011769 MISC Page: 200 of 2782
09/26/2022 03:35:37 PM Receipt #: 22-9381
Rec Fee: \$30.00 Darrell James Hill
Gila County, Az, Sadie Jo Bingham, Recorder





SECURITY AGREEMENT DJH001-SA 06252015-SA CE
Non-Negotiable – Private Agreement Between two Parties

L.S. ~~Darrell James Hill~~ DARRELL JAMES HILL
L.S. ~~Darrell-James Hill~~ HILL

DEBTOR:

DARRELL JAMES HILL
C/O 5124 East 18th Avenue
Apache Junction, Arizona 85119

CREDITOR:

Darrell-James: Hill
C/O General Delivery
Apache Junction MPO
Apache Junction, Arizona [851209998]

This Security Agreement:

This Security Agreement is in regard to the mutually agreed upon and entered into contract DJH001-SA 06252015-SA CE between: A) commercial person DARRELL JAMES HILL, also known by the any and all of the linear derivatives and variations in the spelling of the said name except: "Darrell-James: Hill," hereinafter jointly and severally "DEBTOR," and: B) real man, sui juris, living sentient beyond the sea, to-wit: natural, biological, spiritual, and soulful man-creation of the Almighty God, to wit: "Darrell-James: Hill", hereinafter the "SECURED PARTY." See Political Status Election: DJH001-POLE, ENCLOSURE-1. See Private Agreement, Non-negotiable -- Private Between the Parties: DJH001-PA, ENCLOSURE-2.

For the value of the consideration: Controlling Creditor or Entitlement Holder: DARRELL JAMES HILL: - See Trade-name and Trade-mark, Notice and Agreement, TN DJH001-TN. See DJH001-TN, ENCLOSURE-3.

- a) Assigns to the Darrell-James: Hill all of the security interests in all of the Collateral, not limited by the items described herein below, for the purpose of the securing all of the interests and all of the right(s) in all of the forms whatsoever. See HOLD-HARMLESS AND INDEMNITY AGREEMENT: DJH001-HHIA, ENCLOSURE-4;
- b) Transfers all of the collateral along with all of the controlling creditor or Security Entitlement or transfer or assignment or attachment or perfection right(s), not limited by the any of the Security Entitlements, unto and into the possession and control of the SECURED PARTY;
- c) Agrees with the having: DEBTOR's name entered and registered in the records of the Uniform Commercial Code, hereinafter "UCC", filing office as a transmitting utility;
- d) Agrees that: Darrell-James: Hill hereafter possesses all of the collateral along with all of the controlling creditor or Security Entitlement or transfer or assignment or attachment or perfection right(s) stated in this Security Agreement in regards to the any of the Collateral, as well as all of the right(s) in the any of the present and future forms whatsoever.

2022-011769 MISC Page: 203 of 2782
09/26/2022 03:35:37 PM Receipt #: 22-9381
Rec Fee: \$30.00 Darrell James Hill
Gila County, Az, Sadie Jo Bingham, Recorder



204

SECURITY AGREEMENT DJH001-SA 06252015-SA CE
Non-Negotiable – Private Agreement Between two Parties

[INTENTIONALLY LEFT BLANK]

SECURITY AGREEMENT DJH001-SA 06252015-SA CE

205
2022-011769 MISC Page: 204 of 2782
09/26/2022 03:35:37 PM Receipt #: 22-9381
Rec Fee: \$30.00 Darrell James Hill
Gila County, Az, Sadie Jo Bingham, Recorder



2 of 68



**SECURITY AGREEMENT DJH001-SA 06252015-SA CE
Non-Negotiable – Private Agreement Between two Parties**

This: Security Agreement affirms:

- a) Performance of the obligations owed by the DEBTOR in the favor of the SECURED PARTY are as is set forth in this express written Agreement: value considerations of the said obligation(s) of the any specific property or collateral items identified herein, or of the any inquiries thereto: one may consult with the Secured Party;
- b) Repayment of the any of the amounts that: SECURED PARTY may advance, spend, and otherwise convey for the maintenance, preservation, upkeep, and of the like of the Collateral, and, for the any other expenditures that: SECURED PARTY may make under the provisions of this Security Agreement in the particular and for the general benefit of the DEBTOR;
- c) Payment of the any of the amounts owed now or in the future by the DEBTOR for the benefit of the SECURED PARTY;
- d) Payment of the indebtedness or liabilities owed by the DEBTOR in the favor of the SECURED PARTY, both of the direct or indirect, absolute or contingent, due or as might become due, now existing or hereafter arising, or however evidenced;
- e) Other of the debts that may be owed by the DEBTOR for the benefit of the SECURED PARTY upon the occasion as stated herein;
- f) Any of the amounts owed under any of the modifications, renewals, and extensions of the any of the foregoing obligations.

Thus: DEBTOR transfers all of the controlling creditor or Entitlement right(s) or transfer or assignment or attachment or perfection right(s) or issuances or property or collateral or possessions or right(s) to the Darrell-James: Hill. Therefore: any of the herein stated controlling creditor or Security Entitlement or transfer or assignment or attachment or perfection right(s) or issuances or property or collateral or possessions or right(s) shall remain transferred to the Darrell-James: Hill until: Security Agreement is terminated in the writing, signing and filing by the both: DEBTOR and SECURED PARTY, as herein-stated.

NOTICE AND WARNING:

Any commercial person, as well as the any of the agents of the said commercial person, agrees that neither by the said commercial person, nor by the agent of the said commercial person, shall there be display or use in the any manner of the trade-name/trade-mark, common-law trade-name/trade-mark described herein, to wit: DARRELL JAMES HILL, or the any variation thereof, or the any derivative of said name, without prior, express, written consent of Controlling Creditor or Entitlement Holder or Claimant or SECURED PARTY, as signified by the SECURED PARTY's signature in a red ink. Per by both vehicles: use of the published Trade-name/ Trade-mark Notice attached hereto or of the NOTICE AND WARNING herein: DARRELL JAMES HILL use by any commercial person or person, or by the any agent of said commercial person, or person, hereinafter jointly and severally "User," constitutes sure consent and concomitant agreement that the any use of the DARRELL JAMES HILL other than by an authorized use as set forth

206



SECURITY AGREEMENT DJH001-SA 06252015-SA CE
Non-Negotiable – Private Agreement Between two Parties

[INTENTIONALLY LEFT BLANK]

SECURITY AGREEMENT DJH001-SA 06252015-SA CE

2022-011769 MISC Page: 206 of 2782
09/28/2022 03:35:37 PM Receipt #: 22-9381
Rec Fee: \$30.00 Darrell James Hill
Gila County, Az, Sadie Jo Bingham, Recorder



4 of 68

207

Unofficial Copy



**SECURITY AGREEMENT DJH001-SA 06252015-SA CE
Non-Negotiable – Private Agreement Between two Parties**

herein, or following by the Darrell-James: Hill's NOTICE -by a written communication- /SECURITY AGREEMENT, demonstrates: User's tacit and indirect agreement or consent or confession to giving to the SECURED PARTY authority by tacit procuracy for the impending non-judicial forum judgment against User for any unauthorized use of the said trade-name/trade-mark, and, to wit, that such actions did contractually bind to the User, and signifies that: User:

- 1) grants to the SECURED PARTY a security interest in, and a distress warrant or lien against: User's property and interest in the property in the sum certain amount: Five Hundred thousand and no/100 dollars: 500,000.00 USD, or: equivalent currency to which the Secured Party may prefer to agree to the receipt, per the each trade-name/trade-mark used, per the each occurrence of a use, plus for the costs, plus for the triple damages, as well as for the each and every use of the any linear derivatives or variations in the spelling of the DARRELL JAMES HILL;
- 2) authenticates in the support of the any Security Agreement wherein the User is: DEBTOR, and Darrell-James: Hill is: SECURED PARTY, and: User pledges any of the User's property or interest in the any property as collateral for securing any of the User's contractual obligation(s);
- 3) authenticates in the support of the any of the UCC Financing Statement(s) wherein: User is DEBTOR, and: Darrell-James: Hill is SECURED PARTY;
- 4) consents and agrees that the said Financing Statement(s) filed is unto the continuing financing status that the User authorizes, authorizing: SECURED PARTY's filing of any initial and continuation statement(s) as necessary for the maintaining of the SECURED PARTY's attachment or perfected security interest(s) in the any of the User's property or of the right(s) in any of the property(s) pledged into the collateral in the this Security Agreement until: User's contractual obligation is fully satisfied;
- 5) authorizes to the filing of the aforementioned UCC Financing Statement or Security Agreement in the UCC filing office by the SECURED PARTY;
- 6) consents and agrees that any such filings referenced in the paragraph "5)" above are not or may not be considered to be false, and that: User waives all of the claim(s) against the any of such filing(s);
- 7) waives any of the defense(s);
- 8) consents and agrees that: User will execute any of the further documents and take any of the



209

SECURITY AGREEMENT DJH001-SA 06252015-SA CE
Non-Negotiable – Private Agreement Between two Parties

[INTENTIONALLY LEFT BLANK]

SECURITY AGREEMENT DJH001-SA 06252015-SA CE

2022-011769 MISC Page: 208 of 2782
09/26/2022 03:35:37 PM Receipt #: 22-9381
Rec Fee: \$30.00 Darrell James Hill
Gila County, Az, Sadie Jo Bingham, Recorder



6 of 68



**SECURITY AGREEMENT DJH001-SA 06252015-SA CE
Non-Negotiable – Private Agreement Between two Parties**

further actions as requested by the SECURED PARTY that augment any of the following:

- a) evidencing of the security interest granted herein;
- b) perfecting of the security interest granted herein;
- c) maintaining of the first priority of the security interest granted herein;
- d) effectuating of the right(s) herein granted to the SECURED PARTY by the User.

Further: User also consents and agrees in the any of the Payment Terms, Default Terms, Terms for Curing Default, and Terms of Strict Foreclosure as set forth in the particularity in the NOTICE-by written communication- /SECURITY AGREEMENT or in the attached herein published: Trade-name/Trade-mark Notice – DJH001-TN. See DJH001-TN, ENCLOSURE-3.

Words Defined; Glossary of Terms. As used in this Security Agreement, the following words and terms are as defined in this section, non obstante:

“All” means: everything that is, or of that one has or may have: whole number; totality, including without a restriction.

“Almighty God” means: He who exists before all that universally is began; the Father of the Lord God Yushua, the only begotten Son (Creator of all that universally is and the Lord God of of the patriarchs: Abraham, Isaac and Jacob); the Divine Father adoptive to the SECURED PARTY as a result of the sacrifice made by His only begotten Son Yushua for all grace; the Divine Father which Nothing comes between Him and the SECURED PARTY.

“Artificial Person” means: commercial person: DEBTOR or DARRELL JAMES HILL, also known by any and all of the linear derivatives and variations in the spelling of the said name except "Darrell-James: Hill."

“Authorized Representative” or **“A.R.”** or **“AR”** means: Darrell-James: Hill, authorized by the DEBTOR for a signum of the DEBTOR's signature.

“Beneficial interest” means: beneficiary's profit, benefit, or advantage resulting from a contract, or from the ownership of an estate(s) or trust(s) as distinct from the legal ownership or control of the said estate or trust.

“Beneficiary” means: One for whose benefit that of a trust is created: a cestui que trust.

“Beyond the sea” means: beyond all of the limits-of/ outside of the UNITED STATES - to wit: territory over the which does not extend any of the sovereignty of the UNITED STATES government; such as, Not of a United States' territory, Citizen, person or commercial holding idea, etc., and of the like, as opposed to that of a natural person or de jure Citizen under the Sovereign Almighty God as covenanted by the people of the united States for the same under:



SECURITY AGREEMENT DJH001-SA 06252015-SA CE
Non-Negotiable – Private Agreement Between two Parties

[INTENTIONALLY LEFT BLANK]

SECURITY AGREEMENT DJH001-SA 06252015-SA CE

2022-011769 MISC Page: 210 of 2782
09/26/2022 03:35:37 PM Receipt #: 22-9381
Rec Fee: \$30.00 Darrell James Hill
Gila County, Az, Sadie Jo Bingham, Recorder



8 of 68



**SECURITY AGREEMENT DJH001-SA 06252015-SA CE
Non-Negotiable – Private Agreement Between two Parties**

The Constitution for the united States of America- 1787 CE.

“CE” means: common era or christian era or current era as regarding the year date accounting concurrently synonymous with “AD”- to wit: anno domini.

“Claim” means, noun: 1) right or title to a privilege, or of another thing in the possession of another; not strictly that of the possession, but by the means by which the claimant attains to the possession or enjoyment of the said possession; 2) right of the payment, when such of a right is rendered into the form of a judgment, or for the damages, as well as of under the rulings in regards to that of an equitable remedy for the breach of a performance, when such of a breach results in a right of the payment, or of when that of an equitable remedy is rendered in the form of a judgment in regards to the payment of some debt or obligation. Verb: demand as of one’s own, asserted as of one’s personal right to the any properties or right of a possession or of the enjoyment of a something considered rightfully of one’s own, and wrongfully withheld.

“Conduit” means: transmitting utility distributing energy and effects in the commerce, such as of the goods and services, via the name DARRELL JAMES HILL and of the any linear derivatives and variations in the spelling of said name of the DEBTOR except "Darrell-James: Hill."

“Collateral” means: property and property right(s) of the DEBTOR, now owned and hereafter acquired, now existing and hereafter arising, and wherever located, with such of an ownership either in the name of the DEBTOR or in the name of another, in which: DEBTOR holds of a beneficial interest, and of a security for the entire obligation or of the any amount of the indebtedness.

“Commercial person” means: abstract or legal entity, ens legis, such as of a corporation, created by the construct of the law and considered as possessing certain of the legal right(s) and duties of a legal being: /an imaginary entity, such is as of the DEBTOR, to-wit: DARRELL JAMES HILL, which, on the basis of the legal reasoning, is legally treated as: fictitious “person” or “being” for the purpose of conducting in a commercial activity.

“DEBTOR” means: “User” or “DARRELL JAMES HILL” or by the any of the linear derivatives and variations in the spelling of the said name(s) except: "Darrell-James: Hill."

“Default” means: DEBTOR’s non-performance of a duty arising under this Security Agreement, specifically that of the any of the events described in the any of the three categories, to-wit: "Insolvency," "Creditor Proceedings," and "Other Defaults," set forth below under: "Events of the Default under this Security Agreement".

“Derivative” means by the way of another; taken out of a something preceding: secondary; of that which is not of the origin in and of itself, but is that of the which is obtained from the existence out of some foregoing thing and from a more primal and fundamental nature.

“Drawer” means: Darrell-James: Hill or DARRELL JAMES HILL or the any of the linear derivatives and variations of said names in the any manner whatsoever regarding any of the assets or contracts or promissory notes or titles or grants or accounts or instruments,



SECURITY AGREEMENT DJH001-SA 06252015-SA CE
Non-Negotiable – Private Agreement Between two Parties

[INTENTIONALLY LEFT BLANK]

SECURITY AGREEMENT DJH001-SA 06252015-SA CE



2/15
2022-011769 MISC Page: 212 of 2782
09/26/2022 03:35:37 PM Receipt #: 22-9381
Rec Fee: \$30.00 Darrell James Hill
Gila County, Az, Sadie Jo Bingham, Recorder
[Barcode]

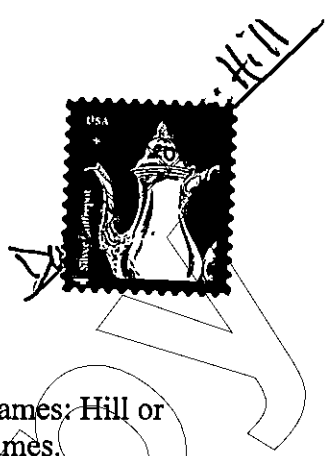

**SECURITY AGREEMENT DJH001-SA 06252015-SA CE
Non-Negotiable – Private Agreement Between two Parties**

trusts, or agreements in the any form whatsoever bearing the name(s): Darrell-James: Hill or DARRELL JAMES HILL or any linear derivatives and variations of the said names.

"Ens legis" means: creature of the law or of an artificial being, such as is, that of a "corporation": deriving of an existence into a being or entity fabricated entirely by the law, as contrasted with that of a natural person.

"Endorsement" means "indorsement:" act of a payee, drawee, accommodation indorser, or holder of a bill, note, check, or of an other negotiable instrument, wherein placing onto of his signum upon the back of the same, with or without further or qualifying words, that thereby: property in the same is assigned and transferred to another.

"Entitlement Holder" means: Darrell-James: Hill having standing in a security entitlement in the any of the security or asset or contract or promissory note or title or grant or account or instrument or agreements in the any of the forms whatsoever bearing DARRELL JAMES HILL, or any linear derivatives and variations of the said name.

"Ex delicto" means ex, to wit, from/out, of a delict, to wit: tort, fault, crime, or malfeasance including same arising out of the contract or otherwise founded in the trespass, trover, or replevin.

"Ground" means: land or soil or earth above the sea, beyond the sea; to wit: dirt, the soil or the dust, to-wit: mineral composition, precursors and substance elements of the corporeal man.

"Hold-harmless and Indemnity Agreement" means: "HHIA", HOLD-HARMLESS AND INDEMNITY AGREEMENT: DJH001-HHIA, ENCLOSURE-4; as, of this HHIA, as may be amended and modified in the accordance with this contract of the parties signing hereunto, and together with any of the attachments, exhibits, documents, endorsements, and schedules in regard to this HHIA attached.

"Issuer" means: Darrell-James: Hill or DARRELL JAMES HILL, of the maker or drawer of the any of the assets or contract or promissory note or title or grant or account or instrument or agreement in the any form whatsoever.

"Land" means: dry ground and dry earth soil whatsoever, inclusive of the pastures, fields, meadows, woods, moors, waters, marshes, rock, elements, and sand, as against that of the sea or ocean.

"Legal Entity" means: entity ens legis as against that of a natural person; Of the artificial sufficient existence in and of the legal contemplation that of the said entity may function legally or sue and be sued or make decisions through its representative(s).

"Liability" means: kind of the legal obligation, responsibility, and duty of a state of a being bound and obligated by the law for the doing or paying of a debt or fulfilling of an obligation or rendering of a committed specific performance, or the like.

"Living and breathing, flesh-and-blood man" means: SECURED PARTY, Darrell-James: Hill, of a biological and spiritual and soul being: natural person as against that of an artificial legal construct or ens legis- to wit, created by construct of the law.



SECURITY AGREEMENT DJH001-SA 06252015-SA CE
Non-Negotiable – Private Agreement Between two Parties

[INTENTIONALLY LEFT BLANK]

SECURITY AGREEMENT DJH001-SA 06252015-SA CE



12 of 68

2022-011769 MISC Page: 214 of 2782
09/26/2022 03:35:37 PM Receipt #: 22-9381
Rec Fee: \$30.00 Darrell James Hill
Gila County, Az, Sadie Jo Bingham, Recorder





SECURITY AGREEMENT DJH001-SA 06252015-SA CE
Non-Negotiable – Private Agreement Between two Parties

“Maker” means: (a) SECURED PARTY, or (b) DEBTOR in regards to the any of the assets or contract or promissory note or title or grant or account or instrument or agreement in-bearing the name(s) Darrell-James: Hill, or DARRELL JAMES HILL, respectively.

“Natural person” means: sentient being living on the ground, beyond of the sea, that of a “living and breathing, flesh-and-blood man,” as against that of an artificial person(s) or commercial person ens legis.

“Non obstante” means: words anciently used in the public and private instruments intended to preclude, in advance, any of the interpretations contrary to the certain declared objects or purposes.

“Private Agreement” means: “PA”, in regards to the written, express Private Agreement: DJH001-PA, ENCLOSURE- 2. between: SECURED PARTY and: DEBTOR, together with the any of the modifications of and substitutions for the said Private Agreement.

“Replevin” means: personal action *ex delicto* brought for the recovery of the possession or goods unlawfully taken.

“Resources or rents or wages or salaries or any other income by any source derived” means: any resources or rents or wages or salaries or any other income by any source not limited by the past or present or future benefit of the DEBTOR.

“SECURED PARTY” means: Darrell-James: Hill de jure- the natural person, In: 1) Sovereign People Status of The Constitution for the united States of America-1787 CE.: 2) Political Status Election: Article of Amendment IX: 3) Non Commercial Status.

“Security” means: obligation given by a debtor in the order to make sure of the payment or performance of his debt.

“Security Agreement” means: “SA”, this Security Agreement DJH001-SA, 06252015 CE, with the all of the attachments and incorporations made by the reference.

“Securities Intermediary” means: bank or broker or clearing corporation or bailee that is acting in the capacity of the maintaining of a security account for an other.

“Signature” means in the nature of, U.C.C. § 3-401 – 2002, what is considered signum, which is herein incorporated by a reference.

“Signed” means in the nature of, U.C.C. § 1-201 (37) – 2001, what is considered signum, which is herein incorporated by a reference.

“Signum” means: sign, mark, seal, or writing mad for to identify or authenticate, or to give validity of one’s own act: signature.

“DARRELL JAMES HILL” means: commercial person "DARRELL JAMES HILL", as well as the any of the linear derivatives and variations in the spelling of that said name, respectively, except "Darrell-James: Hill." All of the right(s) reserved regarding trade-name/trade-mark 2015 CE, et seq. - All of the right(s) reserved.

“transmitting utility” means: the stramineus homo, en legis, DARRELL JAMES HILL's duty(s) in the acts for the the transmitting of letters, writings, papers, news, and the like, from one jurisdiction or nation to another; the mechanism for to communicate rights, titles, and privileges.



Handwritten 'U' and '2/16' in the left margin.

SECURITY AGREEMENT DJH001-SA 06252015-SA CE
Non-Negotiable – Private Agreement Between two Parties

[INTENTIONALLY LEFT BLANK]

SECURITY AGREEMENT DJH001-SA 06252015-SA CE



14 of 68

219
2022-011769 MISC Page: 216 of 2782
09/26/2022 03:35:37 PM Receipt #: 22-9381
Rec Fee: \$30.00 Darrell James Hill
Gila County, Az, Sadie Jo Bingham, Recorder





**SECURITY AGREEMENT DJH001-SA 06252015-SA CE
Non-Negotiable – Private Agreement Between two Parties**

"Truename" means: "Darrell-James: Hill" de jure: is the natural person to who this SA and attachments, and as amended, and in the Confirmations of the presumption: to wit: 1) Sovereign People Status of The Constitution for the united States of America-1787 CE.: 2) Political Status Election: Article of Amendment IX: 3) Non Commercial Status refer; to wit: the natural person of soul under the Almighty God identified by the family name: "Hill", and upon his birth, "Darrell" -second name, and "James" -third name: to wit: Hill Darrell-James: him to who the de jure confirmations- made before refer: to wit: Darrell-James: Hill. All of the right(s) reserved regarding the any use of the name "Darrell-James: Hill" signum, Common-law trade-name/trademark 2015 CE, et seq.- All of the right(s) reserved.

"U.C.C. § 1-201(37) – (2001)" means in the nature of "includes using any symbol executed or adopted with present intention to adopt or accept a writing."

"U.C.C. § 3-401– (2002)" means in the nature of, "(a) A person is not liable on an instrument unless (i) the person signed the instrument, or (ii) the person is represented by an agent or representative who signed the instrument and the signature is binding on the represented person under Section 3-402. (b) A signature may be made (i) manually or by means of a device or machine, and (ii) by the use of any name, including a trade or assumed name, or by a word, mark, or symbol executed or adopted by a person with present intention to authenticate a writing."

"U.C.C. § 9-607– (2010)" means in the nature of, "(a) [Collection and enforcement generally.] If so agreed, and in any event after default, a secured party: (1) may notify a debtor or other person obligated on collateral to make payment or otherwise render performance to or for the benefit of the secured party; (2) may take any proceeds to which the secured party is entitled under Section 9-315; (3) may enforce the obligations of an account debtor or other person obligated on collateral and exercise the right(s) of the debtor with respect to the obligation of the account debtor or other person obligated on collateral to make payment or otherwise render performance to the debtor, and with respect to any property that secures the obligations of the account debtor or other person obligated on the collateral; (4) if it holds a security interest in a deposit account perfected by control under Section 9-104(a)(1), may apply the balance of the deposit account to the obligation secured by the deposit account; and (5) if it holds a security interest in a account perfected by control under Section 9-104(a)(2) or (3), may instruct the bank to pay the balance of the deposit account to or for the benefit of the secured party. (b) [Nonjudicial enforcement of mortgage.] If necessary to enable a secured party to exercise under subsection (a)(3) the right of a debtor to enforce a mortgage non-judicially, the secured party may record in the office in which a record of the mortgage is recorded: (1) a copy of the security agreement that creates or provides for a security interest in the obligation secured by the mortgage; and (2) the secured party's sworn affidavit in recordable form stating that: (A) a default has occurred with respect to the obligation secured by the mortgage; and (B) the secured party is entitled to enforce the mortgage non-judicially. (c) [Commercially reasonable collection and enforcement.] A secured party shall proceed in a commercially reasonable manner if the secured party: (1) undertakes to



2/8

SECURITY AGREEMENT DJH001-SA 06252015-SA CE
Non-Negotiable – Private Agreement Between two Parties

[INTENTIONALLY LEFT BLANK]

SECURITY AGREEMENT DJH001-SA 06252015-SA CE



16 of 68

2022-011769 MISC Page: 218 of 2782
09/26/2022 03:35:37 PM Receipt #: 22-9381
Rec Fee: \$30.00 Darrell James Hill
Gila County, Az, Sadie Jo Bingham, Recorder



~~218~~

219



**SECURITY AGREEMENT DJH001-SA 06252015-SA CE
Non-Negotiable – Private Agreement Between two Parties**

collect from or enforce an obligation of a account debtor or other person obligated on collateral; and (2) is entitled to charge back uncollected collateral or otherwise to full or limited recourse against the debtor or a secondary obligor. (d) [Expenses of collection and enforcement.] A secured party may deduct from the collections made pursuant to subsection (c) reasonable expenses of collection and enforcement, including reasonable attorney's fees and legal expenses incurred by the secured party.”

Collateral Section:

All Property and Collateral acquired by non consensual means is replevin unto Darrell-James: Hill.

Collateral	Value in Security Interest
1. DARRELL JAMES HILL's Entitlement or transfer or assignment of the right(s) of the trade-name(s), mark(s), and trade-mark(s) in regards to the "DARRELL JAMES HILL"; and of any other of the assemblages of the letters and linear derivatives and variations in the spelling of the said name(s) used with the intent of referencing the DEBTOR, except Darrell-James: Hill, the SECURED PARTY;	Five Hundred Thousand and no/100 dollars: 500,000.00 USD, or: equivalent currency to which the Secured Party may prefer to agree to the receipt: per each use, per each occurrence of the unauthorized use, plus costs, plus triple damages --See "NOTICE AND WARNING" above
2. DARR ELL JAMES HILL's Entitlement or transfer or assignment of the right(s) of the DARRELL JAMES HILL, birth certificate description: 0110 DEPARTMENT OF HEALTH, DIVISION OF VITAL STATISTICS, CERTIFICATE OF LIVE BIRTH, Reg. Dist. No. 7701, Primary Reg. Dist, No. 7701, Registrar's No. 9750, Birth No. 13458-20885, CHILD NAME Darrell James Hill, SEX M, DATE OF BIRTH Nov 20 1958, FATHER Clarence Hill, MOTHER Prallce Arlene. (number on back) 2712303. See Notarial	Sixty-Five Million and no/100 and no/100: 65,000,000.00 USD, or: equivalent currency to which the Secured Party may prefer to agree to the receipt: per the each occurrence; plus for the triple damages



220

SECURITY AGREEMENT DJH001-SA 06252015-SA CE
Non-Negotiable – Private Agreement Between two Parties

[INTENTIONALLY LEFT BLANK]

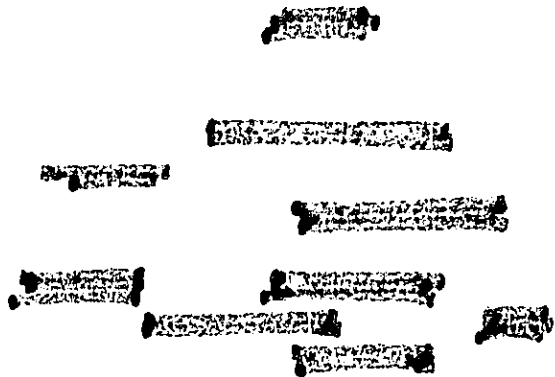

SECURITY AGREEMENT DJH001-SA 06252015-SA CE

18 of 68

2022-011769 MISC Page: 220 of 2782
09/26/2022 03:35:37 PM Receipt #: 22-9381
Rec Fee: \$30.00 Darrell James Hill
Gila County, Az, Sadie Jo Bingham, Recorder





**SECURITY AGREEMENT DJH001-SA 06252015-SA CE
Non-Negotiable – Private Agreement Between two Parties**

Acknowledgment of Original
CERTIFICATE OF BIRTH; See copy of
CERTIFICATE OF BIRTH: Enclosure -5.

3. DARR ELL JAMES HILL's Entitlement or transfer or assignment of the right(s) of the miscellaneous licenses:

Two Hundred Thousand and no/100 dollars: 200,000.00 USD, or: equivalent currency to which the Secured Party may prefer to agree to the receipt

ARIZONA Driver License; Number [REDACTED]; Expires 11/20/2023; Date of Birth [REDACTED]; DARRELL JAMES HILL See Notarial Acknowledgment of Original ARIZONA Driver License; Number [REDACTED]; See copy of ARIZONA Driver License; Number [REDACTED] Enclosure-6.

4. DARRELL JAMES HILL's Entitlement or transfer or assignment of the right(s) of the military identification.

Fifty Thousand and no/100 dollars: 50,000.00 USD, or: equivalent currency to which the Secured Party may prefer to agree to the receipt

5. DARR ELL JAMES HILL's Entitlement or transfer or assignment of the right(s) of the legal land description, land mortgage, second mortgage.

Current U.S. Market Value each, plus for the triple damages: per the each occurrence; plus for the triple damages

Collateral

Value in Security Interest

6. DARRELL JAMES HILL's Entitlement or transfer or assignment of the right(s) of the lot block tax.

Current U.S. Market Value: per the each occurrence; plus for the triple damages

7. DARR ELL JAMES HILL's Entitlement or transfer or assignment right(s) of VEH1: ARIZONA CERTIFICATION OF TITLE, Inventory Control [REDACTED]; VEH2: ARIZONA CERTIFICATION OF TITLE, Inventory Control [REDACTED]; VEH3: ARIZONA

Current U.S. Market Value: per the each occurrence; plus for the triple damages

2022-011769 MISC Page: 221 of 2782
09/26/2022 03:35:37 PM Receipt #: 22-9381
Rec Fee: \$30.00 Darrell James Hill
Gila County, Az, Sadie Jo Bingham, Recorder



222

CS

SECURITY AGREEMENT DJH001-SA 06252015-SA CE
Non-Negotiable – Private Agreement Between two Parties

Unofficial Copy

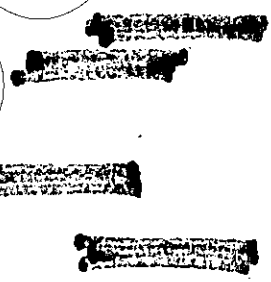

[INTENTIONALLY LEFT BLANK]

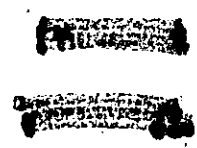

SECURITY AGREEMENT DJH001-SA 06252015-SA CE

20 of 68

22
2022-011769 MISC Page: 222 of 2782
09/26/2022 03:35:37 PM Receipt #: 22-9391
Rec Fee: \$30.00 Darrell James Hill
Gila County, Az, Sadie Jo Bingham, Recorder





**SECURITY AGREEMENT DJH001-SA 06252015-SA CE
Non-Negotiable – Private Agreement Between two Parties**

CERTIFICATION OF TITLE, Inventory
Control: [REDACTED] ARIZONA

CERTIFICATION OF TITLE, Inventory
Control: [REDACTED]

- 8. DARR ELL JAMES HILL's Entitlement or transfer or assignment of the right(s) of the funding source of the bank account, second land mortgage. Current U.S. Market Value: per the each occurrence; plus for the triple damages
- 9. DARRELL JAMES HILL's Entitlement or transfer or assignment of the right(s) of the funding source of the charge card account. Two Hundred Thousand and no/100 dollars: 200,000.00 USD, or: equivalent currency to which the Secured Party may prefer to agree to the receipt: per the each occurrence; plus for the triple damages
- 10. DARRELL JAMES HILL's controlling creditor or Security Entitlement or transfer or assignment right(s) in the funding of the charge accounts of the charge card account. Two Hundred Thousand and no/100 dollars: 200,000.00, USD, or: equivalent currency to which the Secured Party may prefer to agree to the receipt: each occurrence
- 11. DARRELL JAMES HILL's Entitlement or transfer or assignment of the right(s) of the funding source of the stock bonds. Current U.S. Market Value: per the each occurrence; plus for the triple damages
- 12. DARRELL JAMES HILL's Entitlement or transfer or assignment of the right(s) of the funding source of the retirement account: None Current U.S. Market Value: per the each occurrence; plus for the triple damages
- 13. DARRELL JAMES HILL's Entitlement or transfer or assignment of the right(s) of the stockpiles, collections, build-ups, amassments, and of the accumulations, however small, of the Federal Reserve Notes, gold certificates, Current U.S. Market Value: per the each occurrence; plus for the triple damages

2024

2022-011769 MISC Page: 223 of 2782
 09/26/2022 03:35:37 PM Receipt #: 22-9391
 Rec Fee: \$30.00 Darrell James Hill
 Gila County, Az, Sadie Jo Bingham, Recorder



SECURITY AGREEMENT DJH001-SA 06252015-SA CE
Non-Negotiable – Private Agreement Between two Parties

[INTENTIONALLY LEFT BLANK]



SECURITY AGREEMENT DJH001-SA 06252015-SA CE

22 of 68

2 2022-011769 MISC Page: 224 of 2782
09/26/2022 03:35:37 PM Receipt #: 22-9381
Rec Fee: \$30.00 Darrell James Hill
Gila County, Az, Sadie Jo Bingham, Recorder



SECURITY AGREEMENT DJH001-SA 06252015-SA CE
Non-Negotiable – Private Agreement Between two Parties



and silver certificates and of the any other types and kinds of a cash, coin, currency, or money: None

14. DARRELL JAMES HILL's Entitlement or transfer or assignment of the right(s) of the bank account. Current U.S. Market Value: per the each occurrence; plus for the triple damages
15. DARRELL JAMES HILL's Entitlement or transfer or assignment of the right(s) of the any rents, wages, salaries, and of another income, from whatever source derived. Current U.S. Market Value: per the each occurrence; plus for the triple damages

Collateral

Value in Security Interest

16. DARRELL JAMES HILL's Entitlement or transfer or assignment of the right(s) of any land, mineral, water, and air right(s). Current U.S. Market Value: per the each occurrence; plus for the triple damages
17. DARRELL JAMES HILL's Entitlement or transfer or assignment of the right(s) of the any livestock and animals, and of the any thing(s) required for the care, feeding, use, transportation, and husbandry thereof: 2 K-9s, 2 small Fish tanks of 4-6 inch common fish. Current U.S. Market Value: per the each occurrence; plus for the triple damages
18. DARRELL JAMES HILL's Entitlement or transfer or assignment of the right(s) of the DARRELL JAMES HILL's books, booklets, pamphlets, treatises, essays, treatments, monographs, stories, written material, libraries, plays, screenplays, lyrics, songs, music. Fifty Thousand and no/100 dollars: 50,000.00 USD, or: equivalent currency to which the Secured Party may prefer to agree to the receipt: per the each occurrence; plus for the triple damages



SECURITY AGREEMENT DJH001-SA 06252015-SA CE
Non-Negotiable – Private Agreement Between two Parties

[INTENTIONALLY LEFT BLANK]

SECURITY AGREEMENT DJH001-SA 06252015-SA CE



24 of 68

DJ
2022-011769 MISC Page: 226 of 2782
09/26/2022 03:35:37 PM Receipt #: 22-9381
Rec Fee: \$30.00 Darrell James Hill
Gila County, Az, Sadie Jo Bingham, Recorder





**SECURITY AGREEMENT DJH001-SA 06252015-SA CE
Non-Negotiable – Private Agreement Between two Parties**

- | | |
|---|---|
| 19. DARRELL JAMES HILL's Entitlement or transfer or assignment of the right(s) of the DARRELL JAMES HILL's financial books and records. | Fifty Thousand and no/100 dollars: 50,000.00 USD, or: equivalent currency to which the Secured Party may prefer to agree to the receipt: per the each occurrence; plus for the triple damages |
| 20. DARRELL JAMES HILL's Entitlement or transfer or assignment of the right(s) of the DARRELL JAMES HILL's proprietary data and technology, inventions, royalties, and good will. | Current U.S. Market Value: per the each occurrence; plus for the triple damages |
| 21. DARRELL JAMES HILL's Entitlement or transfer or assignment of the right(s) of the DARRELL JAMES HILL's records, diaries, journals, photographs, negatives, transparencies, images, video footage, film footage, drawings, sound records, audio tapes, video tapes, and of the computer production and storage facility of any kind. | Fifty Thousand dollars and no/100: 50,000.00 USD, or: equivalent currency to which the Secured Party may prefer to agree to the receipt: per the each occurrence; plus for the triple damages |

Collateral

Value in Security Interest

SECURITY AGREEMENT DJH001-SA 06252015-SA CE

25 of 68

2022-011769 MISC Page: 227 of 2782
 09/28/2022 03:35:37 PM Receipt #: 22-9381
 Rec Fee: \$30.00 Darrell James Hill
 Gila County, Az, Sadia Jo Bingham, Recorder



228

SECURITY AGREEMENT DJH001-SA 06252015-SA CE
Non-Negotiable – Private Agreement Between two Parties

[INTENTIONALLY LEFT BLANK]



26 of 68

SECURITY AGREEMENT DJH001-SA 06252015-SA CE

2219
2022-011769 MISC Page: 228 of 2782
09/26/2022 03:35:37 PM Receipt #: 22-9381
Rec Fee: \$30.00 Darrell James Hill
Gila County, Az, Sadie Jo Bingham, Recorder





**SECURITY AGREEMENT DJH001-SA 06252015-SA CE
Non-Negotiable – Private Agreement Between two Parties**

22. Entitlement right(s) of the DARRELL JAMES HILL's fingerprints, footprints, palm prints, thumbprints, RNA materials, DNA materials, blood and blood fractions, biopsies, surgically removed tissue, body parts, organs, hair, teeth, nails, semen, urine, other bodily fluids and matter, voice-print, retinal image, and of the descriptions thereof, and of the any other corporal identification factors, and of the said factors' physical counterparts, in any form, and of the any records, record numbers, and information pertaining thereto, in regards to the DARRELL JAMES HILL or any and all linear derivatives and variations in the spelling of the said name.

Five Million and no/100 dollars: 5,000,000.00 USD, or: equivalent currency to which the Secured Party may prefer to agree to the receipt: per the each occurrence; plus for the triple damages

23. DARRELL JAMES HILL's Entitlement of the right(s) biometrics data, records, information, and processes not elsewhere described, the use thereof, and the use of the information contained therein, pertaining thereto, and otherwise.

Five Hundred Thousand and no/100 dollars: 500,000.00 USD, or: equivalent currency to which the Secured Party may prefer to agree to the receipt: per the each occurrence; plus for the triple damages

24. DARRELL JAMES HILL's right(s) of the accessing and using utilities upon the payment of the same unit costs as of the comparable units of the usage offered for the benefit of the most-favored customers, including cable, electricity, garbage, gas, internet, satellite, sewer, telephone, water, Internet, e-mail, and of the any other methods of the communication, energy transmission, and of the food and water distribution.

Twenty-Five Thousand and no/100 dollars: 25,000.00 USD, or: equivalent currency to which the Secured Party may prefer to agree to the receipt and a tort claim in favor of DARRELL JAMES HILL: per each violator: per the each occurrence; plus for the triple damages



Handwritten number '230' in the bottom left corner.

SECURITY AGREEMENT DJH001-SA 06252015-SA CE
Non-Negotiable – Private Agreement Between two Parties

[INTENTIONALLY LEFT BLANK]

SECURITY AGREEMENT DJH001-SA 06252015-SA CE



28 of 68

23/17
2022-011769 MISC Page: 230 of 2782
09/26/2022 03:35:37 PM Receipt #: 22-9381
Rec Fee: \$30.00 Darrell James Hill
Gila County, Az, Sadie Jo Bingham, Recorder





**SECURITY AGREEMENT DJH001-SA 06252015-SA CE
Non-Negotiable – Private Agreement Between two Parties**

25. DARRELL JAMES HILL's Entitlement right(s) of the bartering, buying, contracting, selling, and of the trading ideas, products, services, and work.

Twenty-Five Thousand and no/100 dollars: 25,000.00 USD, or: equivalent currency to which the Secured Party may prefer to agree to the receipt: and a tort claim in favor of DARRELL JAMES HILL: per each violator: per the each occurrence; plus for the triple damages Current U.S. Market Value: per the each occurrence; plus for the triple damages

26. DARRELL JAMES HILL's Entitlement of the right(s) of money, medium of exchange, coinage, barter, economic exchange, bookkeeping, record-keeping, and the like.

Current U.S. Market Value: per the each occurrence; plus for the triple damages

27. DARRELL JAMES HILL's Entitlement of the right(s) of marrying and procreating children, and rearing, educating, training, guiding, and spiritually enlightening the any of such children, without the any of a requirement for applying for, and without the any of an obligation for obtaining, any type of a license, number, serial number, permit, certificate, permission, and the like, of the any kind whatsoever.

Fifty Thousand and no/100 dollars: 50,000.00 USD, or: equivalent currency to which the Secured Party may prefer to agree to the receipt; and a tort claim in favor of DARRELL JAMES HILL: per each violator: per the each occurrence; plus for the triple damages

28. DARRELL JAMES HILL's entitlement of the right(s) of buying, selling, trading, gathering, growing, hunting, raising, and trapping food, fiber, and raw materials for shelter, clothing, and survival.

Fifty Thousand and no/100 dollars: 50,000.00 USD, and a tort claim in favor of DARRELL JAMES HILL by violator per occurrence: per the each occurrence; plus for the triple damages: per the each occurrence; plus for the triple damages

Collateral

Value in Security Interest

2022-011769 MISC Page: 231 of 2782

09/26/2022 03:35:37 PM Receipt #: 22-9381

Rec Fee: \$30.00 Darrell James Hill

Gila County, Az, Sadie Jo Bingham, Recorder



Handwritten '230' and 'D.J.' in the bottom left corner.

SECURITY AGREEMENT DJH001-SA 06252015-SA CE
Non-Negotiable – Private Agreement Between two Parties

[INTENTIONALLY LEFT BLANK]

SECURITY AGREEMENT DJH001-SA 06252015-SA CE

2022-011769 MISC Page: 232 of 2782
09/26/2022 03:35:37 PM Receipt #: 22-9381
Rec Fee: \$30.00 Darrell James Hill
Gila County, Az, Sadie Jo Bingham, Recorder



30 of 68



SECURITY AGREEMENT DJH001-SA 06252015-SA CE
Non-Negotiable – Private Agreement Between two Parties

29. DARRELL JAMES HILL's Entitlement of the right(s) of freedom of religion, worship, use of the sacraments, spiritual practice, and expression without the any of abridgment of the freedom of the speech, publishing, peaceable assembly, and petitioning of the Government for redress of any grievances, and also for the petitioning of any military force of the United States, as well as of any other group, agency, and organization, and otherwise for the physical protection from all of the threats involving the safety and integrity of the person, as well as the any of property, of the SECURED PARTY from any source, both "public" and "private".

Ten Million dollars and no/100: 10,000,000.00 USD, or: equivalent currency to which the Secured Party may prefer to agree to the receipt: per the each occurrence; plus for the triple damages

30. DARRELL JAMES HILL's Entitlement of the right(s) of keeping and bearing arms for the self-defense of self, family, and parties requesting physical protection of their person and property.

Fifty Thousand and no/100 dollars: 50,000.00 USD, or: equivalent currency to which the Secured Party may prefer to agree to the receipt; and a tort claim in favor of DARRELL JAMES HILL; per each violator, per each occurrence

31. DARRELL JAMES HILL's Entitlement of the right(s) of privacy and security in the person, property, papers, effects, private intrusion, detainer, entry, seizure, search, surveillance, trespass, assault, summons, and warrant of DARRELL JAMES HILL.

Thirty Thousand and no/10 dollars: 30,000.00 USD, or: equivalent currency to which the Secured Party may prefer to agree to the receipt; and a tort claim in favor of DARRELL JAMES HILL; per each violator, per each hour occurrence: plus for the triple damages



1234

SECURITY AGREEMENT DJH001-SA 06252015-SA CE
Non-Negotiable – Private Agreement Between two Parties

[INTENTIONALLY LEFT BLANK]

SECURITY AGREEMENT DJH001-SA 06252015-SA CE

235
2022-011769 MISC Page: 234 of 2782
09/26/2022 03:35:37 PM Receipt #: 22-9381
Rec Fee: \$30.00 Darrell James Hill
Gila County, Az, Sadie Jo Bingham, Recorder



32 of 68

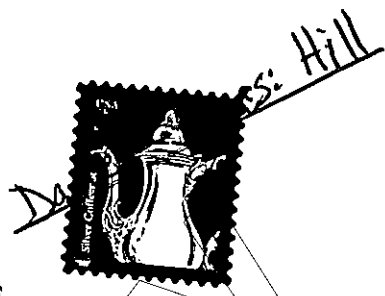

**SECURITY AGREEMENT DJH001-SA 06252015-SA CE
Non-Negotiable – Private Agreement Between two Parties**

- 32. DARRELL JAMES HILL's Entitlement of the right(s) of claims of the ownership and certificates of the title involving the corporeal and incorporeal hereditaments, hereditary succession, and the any of the innate aspects of the being, to-wit mind, body, soul, free will, faculties, and self. Current U.S. Market Value: per the each occurrence; plus for the triple damages

- 33. DARRELL JAMES HILL's Entitlement to the right(s) of any corporation sole executed and filed, and as well as might be executed and filed, under any or any herein stated said names. Current U.S. Market Value: per the each occurrence; plus for the triple damages

- 34. DARRELL JAMES HILL's documents purportedly evidencing, construing, deemed as proving, regarded as confirming, and of the like, electing minimal contact with this state of de jure state title; Thirty Thousand and no/100 dollars: 30,000.00 USD, or: equivalent currency to which the Secured Party may prefer to agree to the receipt; and a tort claim in favor of DARRELL JAMES HILL; per each violator, per each occurrence; plus for the triple damages

- 35. DARRELL JAMES HILL's Entitlement of the right(s) of accounts, deposits, escrow accounts, lotteries, overpayments, prepayments, prizes, rebates, refunds, returns, claimed and unclaimed funds, and of the any records and records numbers, correspondence, and information pertaining thereto, as well as of the any such items construed as being derived there-from; Current U.S. Market Value: per the each occurrence; plus for the triple damages

Collateral

Value in Security Interest

SECURITY AGREEMENT DJH001-SA 06252015-SA CE

33 of 68

2022-011769 MISC Page: 235 of 2782
 09/26/2022 03:35:37 PM Receipt #: 22-9381
 Rec Fee: \$30.00 Darrell James Hill
 Gila County, Az, Sadie Jo Bingham, Recorder



7-36

SECURITY AGREEMENT DJH001-SA 06252015-SA CE
Non-Negotiable – Private Agreement Between two Parties

[INTENTIONALLY LEFT BLANK]

SECURITY AGREEMENT DJH001-SA 06252015-SA CE

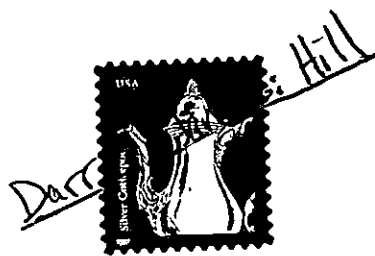

34 of 68

2022-011769 MISC Page: 236 of 2782
09/26/2022 03:35:37 PM Receipt #: 22-9381
Rec Fee: \$30.00 Darrell James Hill
Gila County, Az, Sadie Jo Bingham, Recorder

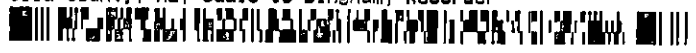

237
151

Unofficial Copy



**SECURITY AGREEMENT DJH001-SA 06252015-SA CE
Non-Negotiable – Private Agreement Between two Parties**

- 36. DARRELL JAMES HILL's Entitlement of the right(s) of the agriculture, and of the any equipment, inventories, supplies, contracts, and accoutrements involved in the planting, tilling, harvesting, processing, preservation, and storage of any products of any agriculture. Current U.S. Market Value: per the each occurrence; plus for the triple damages

- 37. DARRELL JAMES HILL's Entitlement of the right(s) of computers, computer systems, and of each piece of the information contained therein, as well as of the any ancillary equipment, printers, and of the data compression and encryption devices and processes. Thirty Thousand and no/100 dollars: 30,000.00 USD, or: equivalent currency to which the Secured Party may prefer to agree to the receipt; plus current U.S. Market Value per each infraction; plus for the triple damages

- 38. DARRELL JAMES HILL's Entitlement of the right(s) of medical, dental, optical, prescription, and insurance records, records numbers, and information contained in any such records. Two Hundred Thousand and no/100 dollars: 200,000.00 USD, or: equivalent currency to which the Secured Party may prefer to agree to the receipt; per each occurrence; plus for the triple damages

- 39. DARRELL JAMES HILL's Entitlement of the right(s) of DARRELL JAMES HILL's Will. Current U.S. Market Value: per the each occurrence; plus for the triple damages

- 40. DARRELL JAMES HILL's Entitlement of the right(s) of inheritances as well as any of the inheritances as might be received. Current U.S. Market Value: per the each occurrence; plus for the triple damages

Collateral

Value of the Collateral Security Interest



SECURITY AGREEMENT DJH001-SA 06252015-SA CE
Non-Negotiable – Private Agreement Between two Parties

[INTENTIONALLY LEFT BLANK]

SECURITY AGREEMENT DJH001-SA 06252015-SA CE

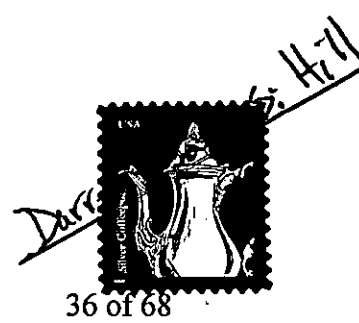

2022-011769 MISC Page: 238 of 2782
09/26/2022 03:35:37 PM Receipt #: 22-9381
Rec Fee: \$30.00 Darrell James Hill
Gila County, Az, Sadie Jo Bingham, Recorder



239

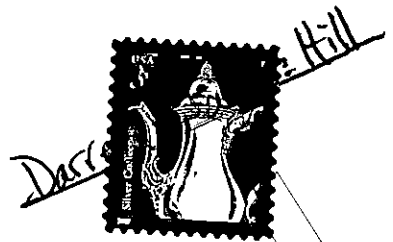

**SECURITY AGREEMENT DJH001-SA 06252015-SA CE
Non-Negotiable – Private Agreement Between two Parties**

41. DARRELL JAMES HILL's Entitlement of the right(s) of DARRELL JAMES HILL's packages, parcels, envelopes, and labels of the any kind whatsoever. Thirty Thousand dollars: 30,000.00, USD, or: equivalent currency to which the Secured Party may prefer to agree to the receipt, and a claim of mail fraud in favor of DARRELL JAMES HILL; per each violator: per the each occurrence; plus for the triple damages

42. Every item of the DARRELL JAMES HILL's property itemized or described herein-above in any amount of the "Value of the Collateral Security Interest" under "Words Defined; Glossary of Terms". Current U.S. Market Value; per the each occurrence; plus for the triple damages

43. Any item of the property of the DARRELL JAMES HILL not specifically listed, named, or specified by make, model, serial number, account number, etc., and is expressly herewith included as an item of the Collateral of the DARRELL JAMES HILL. Current U.S. Market Value: per the each occurrence; plus for the triple damages

-All of the Property and Collateral acquired by non consensual means is replevin unto Darrell-James: Hill-

In the addition to the above: "Collateral" includes, but is not limited by, any the following:

- a) Any of the accessions, increases and additions, replacements of, or substitutions for the any of the properties described in this Collateral section;
- b) Any of the products, produce, or proceeds of the any of the properties described in this Collateral section;
- c) Any of the accounts, general intangibles, instruments, monies, payments, or contract right(s), or the any other of the rights arising out of the sale, lease, or other disposition of the any of the properties described or referred to in the Collateral Section;
- d) Any of the proceeds, including insurance, bond, general intangibles, or account(s) proceeds, from the sale, destruction, loss, or from the any other of the dispositions of the any of the properties described or referred to in the Collateral section;



240

SECURITY AGREEMENT DJH001-SA 06252015-SA CE
Non-Negotiable – Private Agreement Between two Parties

[INTENTIONALLY LEFT BLANK]

SECURITY AGREEMENT DJH001-SA 06252015-SA CE



38 of 68

2022-011769 MISC Page: 240 of 2782
09/26/2022 03:35:37 PM Receipt #: 22-9381
Rec Fee: \$30.00 Darrell James Hill
Gila County, Az, Sadie Jo Bingham, Recorder



Handwritten initials or numbers, possibly 'H3' and '241'.

Unofficial Copy

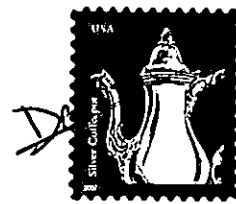

SECURITY AGREEMENT DJH001-SA 06252015-SA CE
Non-Negotiable – Private Agreement Between two Parties

- e) Any of the records or data involving any of the property(s) described in the Collateral Section, not limited by the any of the writings, photographs, microfilms, microfiches, tapes, electronic media, or the like, together with the any of the DEBTOR's rights, titles, or interests in the any of the computer softwares or hardwares required for utilizing, creating, maintaining, and processing any of the such records or data in the any electronic media;
- f) unintentional omissions.

Authorized Representative:

DEBTOR hereby assigns: SECURED PARTY unto:

- a) Signing, harmless of the any liability: DEBTOR's signum for the any of the purposes for the authentication of the any of the writings in the any of the agreements between the DEBTOR and any one(s) other;
- b) Demanding or collecting or receiving or accepting of the receipt, or suing or recovering any of the sums of the money or the any other of the property(ies) in the favor of the DEBTOR;
- c) Executing or signing or indorsing on the any of the claims or instruments or receipts or checks or drafts or warrants issued forth and made payable in the favor of the DEBTOR;
- d) Settling on the any of the compromises or claims in regards to the DEBTOR or in the any of the Collateral;
- e) Filing of the any of the claims or actions, or of the instituting of the any proceedings in the name of the SECURED PARTY or of the DEBTOR: SECURED PARTY may also receive or open or dispose of the any of the mail indicating any of the alleged addresses of the DEBTOR, or to make change in the any of the addresses concerning any of the mail or payments.
- f) SECURED PARTY's assignment or Authorization is given so as to affirm of the DEBTOR's indebtedness, and of the SECURED PARTY'S authority to remain in the full force and effect until renounced by the SECURED PARTY solely as indicated herein-above.

Perfection of the Security Interest:

Filing of the Financing Statement:

- a) DEBTOR by the means of the possession or control or attachment authorizes and assigns to the SECURED PARTY all of the right(s) in the filing of the financing statements or continuing financing statements describing any of the property or collateral including, but not limited to the filing(s) of the any of the agricultural liens or of the other of the statutory liens against the DEBTOR, and held by the SECURED PARTY;
- b) DEBTOR assigns and authorizes: authentication of the financing statements or execution of the any of the action(s) deemed reasonable by the SECURED PARTY for the

SECURITY AGREEMENT DJH001-SA 06252015-SA CE

39 of 68

242
2022-011769 MISC Page: 241 of 2782
09/25/2022 03:35:37 PM Receipt #: 22-9381
Rec Fee: \$30.00 Darrell James Hill
Gila County, Az, Sadie Jo Bingham, Recorder



SECURITY AGREEMENT DJH001-SA 06252015-SA CE
Non-Negotiable – Private Agreement Between two Parties

[INTENTIONALLY LEFT BLANK]

SECURITY AGREEMENT DJH001-SA 06252015-SA CE

40 of 68

2022-011769 MISC Page: 242 of 2782
09/26/2022 03:35:37 PM Receipt #: 22-9381
Rec Fee: \$30.00 Darrell James Hill
Gila County, Az, Sadie Jo Bingham, Recorder



1
242

Unofficial Copy



**SECURITY AGREEMENT DJH001-SA 06252015-SA CE
Non-Negotiable – Private Agreement Between two Parties**

perfecting and continuation of the SECURED PARTY's security interest in the any collateral of the DEBTOR; and: DEBTOR also consents and agrees as follows:

- i) SECURED PARTY may file: carbon or photographic or the any other types of reproduction of the any of the herein-authorized financing statements or Security Agreements for the use of as a financing statement; and
- ii) SECURED PARTY is held harmless in the taking of the any of the steps necessary for the preservation of the any of a third-party's right(s) in a property or collateral. **NOTE:** Perfecting or filing of a UCC Financing Statement does not effect enforcement of the right(s) of the SECURED PARTY. Security Agreement, **Non-Negotiable – Private Agreement Between two Parties, DJH001-SA, ENCLOSURE-2,** constitutes all of the enforcement right(s) of the Darrell-James: Hill by the means of the assignment of the attachment, possession or control right(s). See, in the nature of, UCC § 9-607.

Obligations of the DEBTOR:

Perfection of the Security Interest:

- 1) DEBTOR may execute such: financing statements, and may take any of the actions as requested by the SECURED PARTY for the perfection and continuation of the SECURED PARTY's security interest in the Collateral.
- 2) SECURED PARTY may at any time file any type of a reproduction of this Security Agreement for his use to the perfected financing statement. SECURED PARTY is held harmless in taking the any of the steps necessary in the securing of his priority over the any of the rights of the any third parties in the any of the Collateral.
- 3) This Security Agreement is that of a continuing instrument in the favor of the SECURED PARTY which continues in the effect(s) through any, or any part of, indebtedness and may be discharged/ settled in the full notwithstanding of the fact that a period of a time may pass in which the DEBTOR incurs no indebtedness in the favor of the SECURED PARTY.

Events of the Default under this Security Agreement:

Insolvency:

Insolvency of the DEBTOR, or of the appointment of a receiver for the any part of the DEBTOR's property, or for the any of the assignments in the benefit(s) of a third-party creditor, or for the commencement of the any proceedings under any set of laws, not limited to bankruptcy or insolvency law, by the DEBTOR or against the DEBTOR.

Creditor Proceedings:

Commencement of a foreclosure by a judicial proceeding, self-help, repossession, or by the any methods by the any of the third-party creditors of the DEBTOR against the any item of the DEBTOR's collateral securing any of the indebtedness to the SECURED PARTY, or that is:



Handwritten 'U' and '244' in the bottom left corner.

SECURITY AGREEMENT DJH001-SA 06252015-SA CE
Non-Negotiable – Private Agreement Between two Parties

[INTENTIONALLY LEFT BLANK]



SECURITY AGREEMENT DJH001-SA 06252015-SA CE

42 of 68

2022-011769 MISC Page: 244 of 2782
09/26/2022 03:35:37 PM Receipt #: 22-9381
Rec Fee: \$30.00 Darrell James Hill
Gila County, Az, Sadie Jo Bingham, Recorder



Handwritten scribbles at top left
Unofficial Copy (large diagonal watermark)
245 (handwritten at bottom left)

Darrell James Hill

**SECURITY AGREEMENT DJH001-SA 06252015-SA CE
Non-Negotiable – Private Agreement Between two Parties**

subject in this Security Agreement.

Other Defaults:

Failure in the compliance by the DEBTOR in the any of the terms, obligation, covenant, condition, or the like, contained in: (a) the written, express, Private Agreement, Non-negotiable – Private Between the Parties: DJH001-PA, ENCLOSURE-2, between: DEBTOR, "DARRELL JAMES HILL", or any linear derivatives or variations in the spelling of said name except "Darrell-James: Hill," and: SECURED PARTY, "Darrell-James: Hill"; (b) this Security Agreement; (c) any related document, as well as the any other agreements or contracts between: DEBTOR and: SECURED PARTY.

Rights and Remedies in the Event of a Default:

Under this Security Agreement, by the default of the DEBTOR, then: SECURED PARTY shall have all of the right(s) of the SECURED PARTY in the commerce in regards to the DEBTOR. And, without of a limitation: SECURED PARTY may exercise the any of the numbers of the following enforcement rights and remedies:

Sell the Collateral:

SECURED PARTY possesses: full power for the selling, leasing, transferring, and otherwise dealing with the Collateral and proceeds thereof in the name of the both: SECURED PARTY and: DEBTOR.

SECURED PARTY may sell any of the Collaterals in the any manners and at the any places, such as at a public auction, private sale, and otherwise without a further notice. And: any of the expenses involved in the disposition of the Collateral, including, without a limitation: expenses of the holding, insuring, preparing for the sale, and of the selling of the Collateral become added to the part of the indebtedness secured by this Security Agreement and are payable to the SECURED PARTY on his demand.

Appoint Receiver:

In the accordance with the requirements and options permitted by the applicable law: SECURED PARTY possesses all of the following rights and remedies in regards to the appointment of a receiver:

- a) SECURED PARTY de jure may have that of a receiver appointed;
- b) Receiver may be: employee of the SECURED PARTY, and may serve without a bond;
- c) Any of fees of the receiver and of the any attorney of the receiver become: part of the indebtedness secured by this Security Agreement and are payable on the SECURED PARTY's demand with an interest at the Note rate; unless: payment of the interest at that rate is not permitted by the applicable law; which, in the event(s) of the such of an occurrence: expenses shall bear in the additional costs in the interest at the highest rate permitted by the applicable law from the date of the expenditure to until the debt is repaid.



246

SECURITY AGREEMENT DJH001-SA 06252015-SA CE
Non-Negotiable – Private Agreement Between two Parties

[INTENTIONALLY LEFT BLANK]

SECURITY AGREEMENT DJH001-SA 06252015-SA CE



44 of 68

2022-011769 MISC Page: 246 of 2782
09/26/2022 03:35:37 PM Receipt #: 22-9381
Rec Fee: \$30.00 Darrell James Hill
Gila County, Az, Sadie Jo Bingham, Recorder

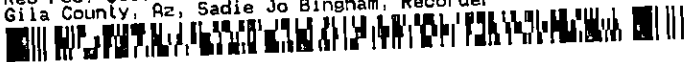

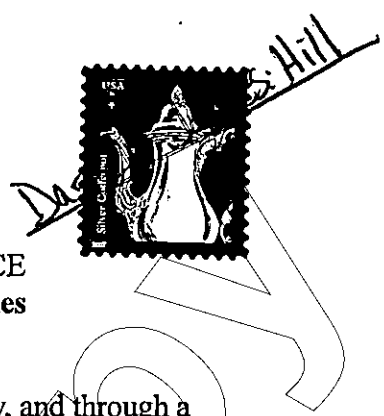

**SECURITY AGREEMENT DJH001-SA 06252015-SA CE
Non-Negotiable – Private Agreement Between two Parties**

Collect Revenues, Apply Accounts:

- a) SECURED PARTY, both in: SECURED PARTY's personal capacity, and through a receiver, may collect the payments, rents, incomes, and revenues from the Collateral.
- b) SECURED PARTY may at any time, at the sole discretion of the SECURED PARTY, transfer any of the Collateral into the name of the SECURED PARTY, as well as into the name of the any nominee of the SECURED PARTY, and receive the payments, rents, incomes, and revenues there-from, and may place onto the same that of a hold as the security for the indebtedness, and apply those of the payments in the favor of the indebtedness in an order of a preference that: SECURED PARTY may at-will determine.
- c) Insofar as the Collateral consists of the account(s), general intangibles, deposit accounts, insurance policies, instruments, chattel paper, choses in action, and the any of the similar property(s): SECURED PARTY may demand, collect, receive, execute receipt for, settle, compromise, adjust, sue for, foreclose, and realize on the Collateral: SECURED PARTY may determine, concerning both: indebtedness, and: Collateral, and whenever due.

Disposition of the Rights of the SECURED PARTY:

SECURED PARTY shall have all of the right(s) in any disposition of the any of the herein-stated and adequately described Collaterals for the benefit of the SECURED PARTY as the SECURED PARTY sees fit; to wit:

Obtain Deficiency: If: SECURED PARTY decides in the favor of the selling of the any of the Collateral, then: SECURED PARTY may obtain in a judgment against the DEBTOR for any of the deficiencies remaining on the indebtedness; Too, for the any of the indebtedness owed to the SECURED PARTY that might remain to be owed by the DEBTOR after the all of the application of all of the amounts received from the exercise of the right(s) provided in this Security Agreement: DEBTOR will remain liable for any deficiency even if the transaction described in this subsection is for a sale of the any of the Collaterals, and likewise of the any of the chattel paper.

Cumulative Remedies: Any of the SECURED PARTY's rights and remedies, as evidenced by this Security Agreement, as well as by the any of the other related documents and by the any of the other writings, is cumulative and may be exercised both singularly and concurrently: Any pursuit by the SECURED PARTY of the any of a remedies does not exclude that of a pursuit of the any of the other remedies; and: making expenditures and taking action for the performance of an obligation of the DEBTOR under this Security Agreement, after the DEBTOR's failure of a performance, does not affect the any of the SECURED PARTY's rights for the declaration of a default and exercising of the any of the remedies thereof.

Other right(s) and Remedies: SECURED PARTY possesses all of the rights and remedies of a secured creditor under the UCC, and that as may be amended upon the agreement

248

SECURITY AGREEMENT DJH001-SA 06252015-SA CE
Non-Negotiable – Private Agreement Between two Parties

[INTENTIONALLY LEFT BLANK]

SECURITY AGREEMENT DJH001-SA 06252015-SA CE



46 of 68

2022-011769 MISC Page: 248 of 2782
09/26/2022 03:35:37 PM Receipt #: 22-9381
Rec Fee: \$30.00 Darrell James Hill
Gila County, Az, Sadie Jo Bingham, Recorder



249

Unofficial Copy



**SECURITY AGREEMENT DJH001-SA 06252015-SA CE
Non-Negotiable – Private Agreement Between two Parties**

between any of the parties. In addition: SECURED PARTY possesses, and may exercise, that of the any and all of the other rights and remedies available at the law, in the equity, and of the otherwise.

Rules of Construction of the Security Agreement:

- a) neither is the use of, nor is the referencing of the term “proceed(s)” authorizing any sale, transfer, other disposition, and the like, of the any of the Collaterals by the DEBTOR;
- b) words “include,” “includes,” and “including” are not limiting;
- c) word “all” includes “any” and the word “any” includes “all,”
- d) word “or” is not exclusive; and,
- e) words and terms: i) in the singular number includes the plural, and in the plural number includes the singular; and ii) in the masculine gender includes both the feminine and neuter.

Miscellaneous Provisions Part of this Security Agreement:

Amendments: Security Agreement, together with the any of the related documents and endorsements, constitutes of the entire understanding and agreement of the parties regarding any of the matters set forth in this Security Agreement. Therefore: Security Agreement may neither be changed nor modified in the any manner whatsoever unless that of the said change/ modification is agreed upon by the SECURED PARTY by the writing and signing by the DEBTOR and: SECURED PARTY, with the recording of the same instrument with the UCC as an amendment and addendum.

Further Assurances:

Upon the Reasonable request by the SECURED PARTY: DEBTOR consents and agrees that DEBTOR will execute further any of the documents and take further any of the actions as requested by the SECURED PARTY that will augment any of the following: a) evidencing of the security interest granted herein; b) perfecting of the security interest granted herein; c) maintaining of the first priority of the security interest granted herein; and, d) effectuating of the right(s) herein granted to the SECURED PARTY by the DEBTOR.

Severability:

In the event that in a court of original and general jurisdiction at the common law, such as an Article III court of the justice arising under The Constitution for the united States of America - 1787 CE, with the Bill of Rights -1791 CE, as lawfully amended by the qualified electors of the several States of this American Union, and of the laws of the *de jure* united States of America, and such as a court of the justice in an accordance within the course of the common law arising under the Constitution of the STATE *de jure*, as amended by the qualified electors of said STATE *de jure* and the laws of the STATE *de jure*, judicially determines that the any of a part of this Security Agreement, including that of the any amendment, addendum, and revision, is unacceptable for a reason, that such is as on its basis

Handwritten '250' and other scribbles

SECURITY AGREEMENT DJH001-SA 06252015-SA CE
Non-Negotiable – Private Agreement Between two Parties

[INTENTIONALLY LEFT BLANK]

SECURITY AGREEMENT DJH001-SA 06252015-SA CE

2022-011769 MISC Page: 250 of 2782
09/26/2022 03:35:37 PM Receipt #: 22-9381
Rec Fee: \$30.00 Darrell James Hill
Gila County, Az, Sadie Jo Bingham, Recorder



48 of 68

Unofficial Copy

DSJ

Darrell James Hill

Darrell James Hill

**SECURITY AGREEMENT DJH001-SA 06252015-SA CE
Non-Negotiable -- Private Agreement Between two Parties**

of the being unlawful, invalid, void or voidable, unenforceable, and the like, then such provisions are thereby severed from this Security Agreement, but every remaining provision continues in the fullness of the force and effect and may not be affected by such of a determination. If feasible, then any of the such offending provisions may be deemed modified for inclusion within the limits of its enforceability and validity, however, if in the event that of the offending provision(s) cannot be so modified, then of the said offending provision is thereby stricken, and the all of the other provisions of this Security Agreement in the any of the other respects remains valid and enforceable by the SECURED PARTY.

Waiver:

SECURED PARTY shall not be construed as waiving any of the right(s) under this Security Agreement unless such of a waiver is given in the writing and signed by the SECURED PARTY in red ink. Furthermore;

Neither by a delay nor by an omission on the part of the SECURED PARTY in the exercise of a right(s) shall such be presumed to operate as that of a waiver of the right(s) or of the any of an other right;

In the any waiver by the SECURED PARTY of the any provision(s) of this Security Agreement, incidence of a waiver neither prejudices, nor constitutes any of an other waiver of the SECURED PARTY's right for otherwise demanding a strict compliance with that provision, or in the any other of the provisions, of this Security Agreement;

Neither by a prior occurrence of a waiver by the SECURED PARTY, nor by any course in the dealings between: SECURED PARTY, and: DEBTOR, does there constitute the presumption of a continuous waiver of the any of the SECURED PARTY's right(s) in the election, nor of a waiver of the any of the DEBTOR's obligations and responsibility(s) in regards to any of the future transactions; and,

Whenever: consent of the SECURED PARTY is required under this Security Agreement, then: SECURED PARTY's granting of such of a consent shall not be construed as constituting that of a continuing consent for the any of the subsequent instances wherein such of a consent is required; and in the any of the instant matter(s), such of a consent may be granted and withheld in the sole discretion of the SECURED PARTY.

This: Security Agreement is not dischargeable in a bankruptcy court; to wit: SECURED PARTY is the Entitlement holder of the any of the negotiable instruments referencing, bearing upon, and deriving from the any of the properties and Collaterals referenced herein: DEBTOR acknowledges that all of the Collateral is exempt from a levy and third-party lien.

This: Security Agreement herewith expressly includes and encompasses any of the Security Entitlement rights, other right(s), legal title, equitable title, and interest in the any of the properties described above in the Collateral section of this Security Agreement.

This: Security Agreement secures the any of the indebtedness and liability(s) whatsoever that:



2512

SECURITY AGREEMENT DJH001-SA 06252015-SA CE
Non-Negotiable – Private Agreement Between two Parties

[INTENTIONALLY LEFT BLANK]



SECURITY AGREEMENT DJH001-SA 06252015-SA CE

50 of 68

253
2022-011769 MISC Page: 252 of 2782
09/26/2022 03:35:37 PM Receipt #: 22-9381
Rec Fee: \$30.00 Darrell James Hill
Gila County, Az, Sadie Jo Bingham, Recorder





**SECURITY AGREEMENT DJH001-SA 06252015-SA CE
Non-Negotiable – Private Agreement Between two Parties**

DEBTOR owes in the favor of the SECURED PARTY. This: security interest also secures the any of the debts that may be owed by the DEBTOR, upon the any of an occasion, for the benefit of the SECURED PARTY.

Thus: DEBTOR grantor acknowledges, consents, and agrees with all of the provisions of this Security Agreement and agrees, consents and admits that: DEBTOR is bound by all of the terms and conditions as stated herein.

[INTENTIONALLY LEFT BLANK]

SECURITY AGREEMENT DJH001-SA 06252015-SA CE

51 of 68

2022-011769 MISC Page: 253 of 2782
09/26/2022 03:35:37 PM Receipt #: 22-9381
Rec Fee: \$30.00 Darrell James Hill
Gila County, Az, Sadie Jo Bingham, Recorder



Unofficial Copy

SECURITY AGREEMENT DJH001-SA 06252015-SA CE
Non-Negotiable – Private Agreement Between two Parties

[INTENTIONALLY LEFT BLANK]



SECURITY AGREEMENT DJH001-SA 06252015-SA CE

52 of 68

2022-011769 MISC Page: 254 of 2782
09/26/2022 03:35:37 PM Receipt #: 22-9381
Rec Fee: \$30.00 Darrell James Hill
Gila County, Az, Sadie Jo Bingham, Recorder



255

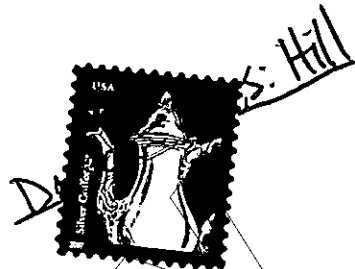

SECURITY AGREEMENT DJH001-SA 06252015-SA CE
Non-Negotiable – Private Agreement Between two Parties

Unofficial Copy

ENCLOSURE-1

Political Status Election: DJH001-POLE

SECURITY AGREEMENT DJH001-SA 06252015-SA CE

53 of 68

2022-011769 MISC Page: 255 of 2782
09/26/2022 03:35:37 PM Receipt #: 22-9381
Rec Fee: \$30.00 Darrell James Hill
Gila County, Az, Sadie Jo Bingham, Recorder



256

SECURITY AGREEMENT DJH001-SA 06252015-SA CE
Non-Negotiable – Private Agreement Between two Parties

INTENTIONALLY LEFT BLANK

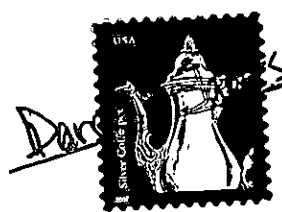

SECURITY AGREEMENT DJH001-SA 06252015-SA CE

54 of 68

1857
2022-011769 MISC Page: 256 of 2782
09/26/2022 03:35:37 PM Receipt #: 22-9381
Rec Fee: \$30.00 Darrell James Hill
Gila County, Az, Sadie Jo Bingham, Recorder



:2017 A.D.

#	:man- trustee	:association	:year, :day	USPO, other	:covenant
1	:Brian: Karth	: USDC- Arizona, -:Clerk.	03/07/17	7015 0640 0001 5883 2600	:Re: Bill-rendered- for the payment of the Covenant-Compensation for the Trespass on the Claimant-Case by the man-USDC-Trustee upon the Hill- Court, -:Case# 7009 1410 0000 7868 5703
2	:Ranier: Collins	:USDC- Arizona, -:Chief- Judge	03/07/17	7015 0640 0001 5883 2617	:Re: Bill-rendered- for the payment of the Covenant-Compensation for the Trespass on the Claimant-Case by the man-USDC-Trustee upon the Hill- Court, -:Case# 7009 1410 0000 7868 5703
3	:Sidney	9 th Circuit- Judicial Council Executive Committee, -:Chief- Judge, Chairman/	04/27/17	RE 322 399 234 US; See: Gila-County-Recorder- Doc.# 2019-009291, p. 366.	Notice: 9 th Circuit-Trespass upon the Fundmental and Substantive-Rights, and Comm-law-Claim- Rights under the Color-of-Law.man-USDC-Trustee upon the Hill- Court, -:Case# 7009 1410 0000 7868 5703
4	:Richard:	9 th Circuit- Judicial Council Executive Committee, -:Circuit- judge	↓	↓	↓
5	:Susan	9 th Circuit- Judicial Council Executive Committee, -:Senior-	↓	RE 322 399 234 US; See: Gila-County-Recorder- Doc.# 2019-009291, p. 366.	Notice: 9 th Circuit-Trespass upon the Fundmental and Substantive-Rights, and Comm-law-Claim- Rights under the Color-of-Law.man-USDC-Trustee

258

:2017-A.D. Document- History

		District- Judge, Chairman			upon the Hill- Court, -:Case# 7009 1410 0000 7868 5703
6	:Sadie-Jo: Bingham	Gila-County-Arizona- State- Recorder	03/10/17	Gila-County-Recorder-Doc.#: 2017-002378	:Affidavit: Proof-of-Claims – August- 2019; related to: Gila-County-Recorder-Doc.#: 2017- 002378
7	:Sadie-Jo: Bingham	Gila-County-Arizona- State- Recorder	07/07/17	Gila-County-Recorder-Doc.#: 2017-006522	:Affidavit: Proof-of-Claims – August- 2019; related to: Gila-County-Recorder-Doc.#: 2017- 002378
8	:Donald-John: Trump	ROTUS	07/13/17	RE 322 399 044 US	:Proof of Claim: Declaratin in Claim Against Criminal Wrong-Doings .. re: Gila county, Arizona Recorder # 2017-006522- July 7, 2017. → re: #13 on p. 3; see: doc., p. 337. Proofs of -:delivery
9	:Jeff: Sessions	U.S.- AG, CLT	↓	RE 322 399 058 US	↓
	:man- trustee	:association	:year, :day	USPO, other	:covenant
10	:Elizabeth: Strange	U.S.- Atty. Phx	↓	7015 0640 0001 5883 2655	↓
11	:Laurie: Day	Chief, OIP	↓	RE 322 399 061 US	↓
12	:Michael: Horowitz	IG- DOJ	↓	RE 322 399 089 US	↓
13	:Robert-P.: Storch	Dep. IG-DOJ	↓	↓	↓
14	:Andrew: McCabe	FBS Dep. Director	↓	RE 322 399 075 US	↓
15	:David: Bowditch	FBI Assoc. Dep.	↓	↓	↓
16	:Richard: Benson	FBI Branch Mgr	↓	USPO First Class Mail	↓
17	:Michael: DeLeon	FBI Agent	↓	↓	↓

:2017-A.D. Document- History

3 / 4

18	:Mark: Lamb	Pinal-County-Ariz., -:Sheriff	↓	RE 322 399 092 US	:Proof of Claim: Declaration in Claim Against Criminal Wrong-Doings .. re: Gila county, Arizona Recorder # 2017-006522- July 7, 2017. → re: #13 on p. 3; see: doc., p. 337. Proofs of -:delivery
19	:Vanessa-R.: Brinkmann	U.S.- DOJ- OIP- Senior- Counsel	07/31/17	Standard Mail	Re: 07/13/17- letter to: RE 322 399 061 US. Discussion re: FOIA and DOJ- record-keeping.
20	:Donald- Trump	POTUS	08/21/17	7015 0640 0001 5883 2686	See; RE 322 399 132 US: Gila-County-Recorder- Doc.# 2019-009291, p. 353.
21	:Jeff: Sessions	U.S.-A.G, CLT	↓	7015 0640 0001 5883 2716	↓ ; C-2716: Proof of -:delivery.
	:man- trustee	:association	:year, :day	USPO, other	:covenant
22	:Elizabeth, Strange	Asst.- AG, Arizona	↓	7015 0640 0001 5883 2709	See; RE 322 399 132 US: Gila-County-Recorder- Doc.# 2019-009291, p. 353.
23	:Mark: Brnovich	Arizon-State- A.G.	08/23/17	7015 0640 0001 5883 2723	Notice and Demands- of theft of :i- man- exclusive-perculiar-absolute-property -trespass with harm-imposed upon :i- man by the man- Government of the United States- 2003-A.D.- Trustee: EBA-1933-A.D.
24	:Mark: Lamb	Pinal-County- Arizona-State, -:Sheriff	↓	7015 0640 0001 5883 2730	Notice and Demands- of theft of :i- man- exclusive-perculiar-absolute-property -trespass with harm-imposed upon :i- man by the man- Government of the United States- 2003-A.D.-

260

Trustee: EBA-1933-A.D.

25	:Sidney	9 th Circuit- Judicial Council Executive Committee, -:Chief-Judge, Chairman/	08/18/17	7015 0640 0001 5883 2679 with -:RE 322 399 234 US -enclosed;	:notice- 2 with -:demand: reporting criminal subordinate-employee- Trustee -deprivation of -:rights under the color-of-law. For :RE 322 399 234 US; See: Gila-County-Recorder- Doc.# 2019-009291, p. 366.
26	:Richard:	9 th Circuit- Judicial Council Executive Committee, -:Circuit-judge	↓		↓
	:man- trustee	:association	:year, :day	USPO, other	:covenant
27	:Susan	9 th Circuit- Judicial Council Executive Committee, -:Senior-District- Judge, Chairman	↓	7015 0640 0001 5883 2679 with -:RE 322 399 234 US -enclosed;	:notice- 2 with -:demand: reporting criminal subordinate-employee- Trustee -deprivation of -:rights under the color-of-law. For :RE 322 399 234 US; See: Gila-County-Recorder- Doc.# 2019-009291, p. 366.
28	:Joseph-Williams	U.S.C.Appeals, 9 th Circuit-Court, -:San-Francisco, -:Deputy Clerk	08/30/17	Standard Mail.	Re: 7015 0640 0001 5883 2679 with -:RE 322 399 234 US -enclosed; .. the correspondence also did not claim, ... we found no basis to treat.... All communications should be addressed to the Clerk... court's jurisdiction is defined by federal statute.... The court is unable to accept filings that are not written in English.

261



**Political Status Election:
Affirmation In Confirmation of Sovereign**

L.S. Darrell-James Hill

:PRESENTS: STATUS (legal position): STANDING (interest in consideration):

I AM: Hill Darrell James: Darrell-James: Hill, do herein report: truths and facts herein are of my first hand personal comprehension and review; to wit:

1) I am: undersigned American Sovereign, am: Hill Darrell James (a.k.a. Darrell-James: Hill): natural born of the man Clarence of the family Hill; and, then-after, named additionally: Darrell and James, at, or soon after birth. See: state rights documentation and acknowledgments: Enclosure 1: a) Notarial Acknowledgment of Authentic "CERTIFICATE OF LIVE BIRTH"; b) copy of OHIO DEPARTMENT OF HEALTH, DIVISION OF VITAL STATISTICS, CERTIFICATE OF LIVE BIRTH for the stramineus homo; c) Notarial Acknowledgment of Original "Arizona Driver License"; d) copy of "Arizona Driver License" for the stramineus homo.

2) I am at the natural birth man citizenry of the Ohio state territory of the Union of nation states of the united States of America understanding of the Original Jurisdiction*.

*Notice: Term "Original Jurisdiction" means A) under the covenant: Almighty God: Torah:-and writings, and: as proposed under 1)The Constitution for the united States of America - 1787 CE, as indicated in the "The united States of America" set for in 2) The Articles of the Confederation -1777-1781 CE, and: 3) constitutional articles in amendment - 1791 CE, and: 4) other original covenants and accords under the Original Jurisdiction, including, but not limited to:

- a) National Bill of Rights, 1776 CE; and:
- b) The Northwest Ordinance, 1787 CE.

3) I am of the the majority age.

4) I am of the competent mind, and make this political chose in action. .

5) I am that of a sentient free Man upon the ground under the Almighty God; to wit: an understanding Ambassador of the Son and Creator God of all that is, and of His Father, even: Most High God in Heaven, the Divine, with whom Nothing and No-one exists between; to wit:

KJV: Book: Genesis-Chapter 1:26 And God said, Let us make man in our image, after our likeness: and let them have dominion over the fish of the sea, and over the fowl of the air, and over the cattle, and over all the earth, and over every creeping thing that creepeth upon the earth. Gen 1:27 So God created man in his own image, in the image of God created he him; male and female created he them.

262

Political Status Election: Affirmation In Confirmation of Sovereign

[INTENTIONALLY LEFT BLANK]

2022-011769 MISC Page: 262 of 2782
09/26/2022 03:35:37 PM Receipt #: 22-9381
Rec Fee: \$30.00 Darrell James Hill
Gila County, AZ, Sadie Jo Bingham, Recorder



Political Status Election: Affirmation In Confirmation of Sovereign

2163



2 of 20

22

Darrell James Hill



Political Status Election: Affirmation In Confirmation of Sovereign

KJV: Book: Proverbs-Chapter 28:5 Evil men understand not judgment: but they that seek the LORD understand all *things*. Chapter 9:10 The fear of the LORD *is* the beginning of wisdom: and the knowledge of the holy *is* understanding.

KJV: Book: Ephesians-Chapter 6:19 And for me, that utterance may be given unto me, that I may open my mouth boldly, to make known the mystery of the gospel, 6:20 For which I am an ambassador in bonds: that therein I may speak boldly, as I ought to speak.

6) I am of the American citizenry people by birth in the Ohio state in the year anno domini Nineteen fifty eight under Almighty God; thus: ✽ ✽

7) I am of the American citizenry trust beneficiary status: trust titled customarily in the corporate all capitalized manner of the stramineus homo, formed from the elements of the Hill Darrell James: to wit, "DARRELL JAMES HILL" due to the subsequent events occurring after and under the derivative organization(s) under the Original Jurisdiction. See Enclosure 1: Item (d).

****Notice:** The use of a doctrine of *idem sonans* in any form is hereafter forbidden as it is a material constructive fraud and deceitful practice in any reference to the man Darrell-James: Hill; to wit: whether oral, written or other, as relates to the Darrell-James: Hill, such of a practice by any fiduciary designated of the public trust in the any manner or presumption in the any regard or in the any direct service of the Darrell-James: Hill is willful fraud and constructive fraud by the any actor(s).

PUBLIC NOTICE:

THIS DOCUMENT GIVES NOTICE of these reports: clarifications or other matters contained to the UNITED STATES, Inc. entity and all of the derivatives thereof: Public and Private, through and by the any Office of the Secretary of State(s) or their agent(s): de facto and de jure "united States of America" seat(s) of the government in and upon the territory thereof; and, through and by the Office of the Secretary of State(s) or their agent(s): de facto and de jure "Arizona state" seat(s) of the government in and upon the territory thereof; and to the all of the persons who would know, or should have known, this Notice content as relates to the undersigned, by and upon the filing of this public notice.

NOTICE TO DOMESTIC AND FOREIGN JURISDICTIONS:

Notice to the principal is notice to all of the agent(s): Notice to the agent is notice to all of the principals of the de facto UNITED STATES AND STATE government(s): actor(s) and derivatives thereto; to wit: Officer(s), Employee(s), Agent(s), Contractor(s), and the like; and,

Political Status Election: Affirmation In Confir

2022-011769 MISC Page: 263 of 2782
09/26/2022 03:35:37 PM Receipt #: 22-9381
Rec Fee: \$30.00 Darrell James Hill
Gila County, Az, Sadie Jo Bingham, Recorder



264

Political Status Election: Affirmation In Confirmation of Sovereign

[INTENTIONALLY LEFT BLANK]

2022-011769 MISC Page: 264 of 2782
09/26/2022 03:35:37 PM Receipt #: 22-9381
Rec Fee: \$30.00 Darrell James Hill
Gila County, Az, Sadie Jo Bingham, Recorder



Darrell James Hill

Political Status Election: Affirmation In Confirmation of Sovereign

4 of 2022

265

Unofficial Copy

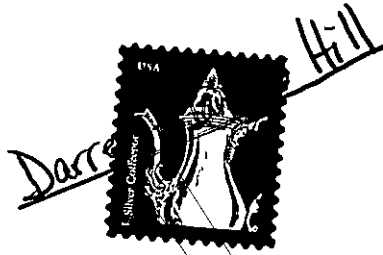

Political Status Election: Affirmation In Confirmation of Sovereign

when-upon this notice is once affixed to any home ground(s) of the Darrell-James: Hill's land-site or habitation-site, or site-otherwise, then:

- a) all of the property attached and referred thereunto is under the custody and control of the above-noted: Darrell-James: Hill;
- b) pursuant to the common-law, then: site access is denied and is not subject to presumed or wanton intrusion for search or seizure, or the like, except by the willful pre-authorization from the man Darrell-James: Hill;
- c) Note: pursuant to the common-law: man is lawfully and legally immune from wanton criminal or civil jurisdiction(s), arrest(s) or detention(s), or the like, as under the Original Jurisdiction convention(s); and,
- d) all of the Actors, of both the private and-public sector(s), must take all of the steps that are available to be taken in every condition to assure and to prevent any of the reproach or attack otherwise on the man's God given inalienable Right(s); to wit: Constitutionally secured and protected in-alienable Right(s), freedom(s), property(s), interest(s), mobility(s) and security(s) and protection(s) thereof;
- e) Legality(ies) of this Notice, or the like: inquiry(ies) in regards to the any actor(s) in their constitutional responsibility(ies) should be made to the sheriff in the county of the territory of the any event of the any matter(s) of the actor's concern.

:PRESENTS: CHARACTER: (motive(s) that control a life): CAPACITY: (legal or moral qualification necessary for certain purposes):

Darrell-James: Hill does hereby state, assert and aver the all of the following:

- 1) Darrell-James: Hill is a man understanding of the Almighty God; to wit: an Ambassador of the Messiah: Genesis-Chapter-1:26-27; Proverbs-Chapter-28:5; Proverbs-Chapter-9:10; Ephesians-Chapter-6:...19-20 - KJV

Ephesians-Chapter 6:19 And for me, that utterance may be given unto me, that I may open my mouth boldly, to make known the mystery of the gospel, 6:20 For which I am an ambassador in bonds: that therein I may speak boldly, as I ought to speak.

- 2) Darrell-James: Hill is a biological citizen born in, upon and of the natural territory of the "Ohio state" of the states of America.
- 3) Darrell-James: Hill is a private-individual, private-person, and non-fictitious person or entity; to wit: a man under the Almighty God the Divine between which there is none other.
- 4) Darrell-James: Hill retains all of the absolute jurisdiction of the people: a natural person man understanding: Almighty God.
- 5) Darrell-James: Hill retains all of the absolute protections of the Rights, remedies and defenses granted by the Almighty God by the subsequent limitations created and beset by the people of the states of America for the people and upon the united States of

2022-011769 MISC Page: 265 of 2782
 09/26/2022 03:35:37 PM Receipt #: 22-9381
 Rec Fee: \$30.00 Darrell James Hill
 Gila County, Az, Sadie Jo Bingham, Recorder



266

Political Status Election: Affirmation In Confirmation of Sovereign

[INTENTIONALLY LEFT BLANK]

2022-011769 MISC Page: 266 of 2782
09/26/2022 03:35:37 PM Receipt #: 22-9381
Rec. Fee: \$30.00 Darrell James Hill
Gila County, Az. Sadie Jo Bingham, Recorder

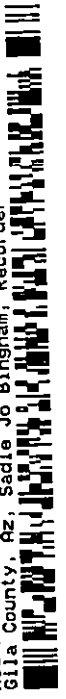

Darrell James Hill
6 of 2022

Political Status Election: Affirmation In Confirmation of Sovereign

267

Unofficial Copy



ms: 471

Political Status Election: Affirmation In Confirmation of Sovereign

America government(s) upon its inception and creation as established under the covenant(s) of the Original Jurisdiction.

6) Darrell-James: Hill is of the real capacity and character above, and as the same has chosen a political status above that of, and foreign to the UNITED STATES government corporate jurisdiction; to wit:

- Darrell-James: Hill does not volunteer, nor consent or contract to be presumed as acting in any *ens legis* entity or capacity, neither to be presumed as an operative of the any other political state or subdivision or surety of the any UNITED STATES corporate interest(s); to wit: Darrell-James: Hill reserves the nature and character of the exact and proper man status and capacity under: Almighty God, and of the same election reserved under the Original Jurisdiction.
- Darrell-James: Hill waives none of the Rights, Remedies or defenses, nor yields of the same, including, without a limitation, the any of the Rights in the accordance with the protection(s) and principle(s) of the Rights, Remedies and defenses assured by and under the Original Jurisdiction; to wit: Rights, such as: right to freedom of movement: private right to travel without restriction in any conveyance on any public roadway in this united nation States of America: right to bear arms for the survival and protection of family and country.
- Darrell-James: Hill is Not a "UNITED STATES CITIZEN"; to wit, Not: subject, vessel, or other presumed entity of the UNITED STATES government as defined in statutes-at-large, such as in the nature of the Title 26 UNITED STATES CODE, "USC", Section 7701, or of the like as elsewhere is defined in the statutes-at-large.
- Darrell-James: Hill is Not in the any form: *ens legis* fiction as is: "person or individual," entity, or other procedural construct or statutory term referring to a legal fiction.

7) Darrell-James: Hill is by choice herein a restricted name under common-law "Trade-name/ Trade-mark"; and it is unto "Hill Darrell James" who all of the Rights are reserved: Use, with the any reference to the Darrell-James: Hill, without express written permission by the Darrell-James: Hill creates a voluntary and informed consensual contractual obligation upon the unauthorized user to the payment of a Trade-name/ Trade-mark infringement fee(s) as follows: Trade-name/Trade-mark infringement fee is in the sum certain of five hundred thousand dollars and no/100: 500,000.00 USD lawful money of account: gold or silver coin, or: certified bullion, or: equivalent money to which , Darrell-James: Hill, "Secured Party," may prefer to agree to the receipt.

8) Darrell-James: Hill comprehends for to identify, paraphrase and refer herein of the following facts of the historical significance bearing upon the implementation of the Original jurisdiction, and thereto upon the man's status, capacity, character and standing; to wit, that:

2022-011769 MISC Page: 267 of 2782
09/26/2022 03:35:37 PM Receipt #: 22-9381
Rec Fee: \$30.00 Darrell James Hill
Gila County, Az, Sadie Jo Bingham, Recorder



268

Political Status Election: Affirmation In Confirmation of Sovereign

[INTENTIONALLY LEFT BLANK]

2022-011769 MISC Page: 268 of 2782

09/26/2022 03:35:37 PM Receipt #: 22-9381

Rec Fee: \$30.00 Darrell James Hill
Gila County, Az, Sadie Jo Bingham, Recorder



8 of 2022

Political Status Election: Affirmation In Confirmation of Sovereign

268

Unofficial Copy



Political Status Election: Affirmation In Confirmation of Sovereign

- a) Due to the faux governmental disparity(s) arising out of the gross capital control controversies by the clandestine banking factions and their actors from in the 17th century to date, the constitutional government was and remains usurped by criminals intent upon theft of Almighty God's covenanted people even from the first presumed president until to date; to wit, a grand of scale usurpation under corporate veils with one goal to date: to still, kill, destroy and enslave Almighty God's covenanted people, the American nations of states of people.
 - b) The present defacto corporate government, in the order for to sustain its deception to govern, postures and administrates under the auspices of the Original Jurisdiction, as a corporation titled: UNITED STATES, INC. a federal corporation defined by its own statute(s) as a federal corporation in the nature of Title 28 USC 3002 (15), as: commercial entity implementing a corporate policy called "public policy." And, for reasons beyond the scope of this statement is defacto government under the Original Jurisdiction, under "united States of America," and the constitution thereto, by default.
 - c) The "UNITED STATES" government corporation, however referred to today, is not synonymous to "The united States of America" government de jure of the original authority and assemblage. Identically, the "UNITED STATES CONSTITUTION" is not synonymous to "The Constitution for the united States of America"; to wit: UNITED STATES CONSTITUTION is in fact the/a corporate by-laws statement of the said corporation, and is inherently mere corporate policy.
- 9) Consequently: Original Jurisdiction cannot be in conflict with itself; to wit: Almighty God made man in original jurisdiction, a) under Him, and b) over the earth and all of the substance, and c) reserving to Himself jurisdiction over man in total.
- 10) Natural people *de jure* are people under the God Almighty above all of the subsequent elements of the Original Jurisdiction; to wit: Darrell-James: Hill, et al.: people are the authority under-which the construct of the state nations and of the The Constitution for the United States of America are conceived and mandated, and are thereto obliged. People, therefore, are inherently superior to the present de facto UNITED STATES' corporate fiction by its own admission(s). Accordingly, by this political election: Darrell-James: Hill de jure is not politically subject to the corporate construct(s) for a sundry reasons, such as evidenced in the nature of the unconscionable Federal Reserve Bank Act of December 23, 1913 CE.
- 11) Notwithstanding, the permittant non-reestablishment of the de jure Governance of the Original Jurisdiction, and, thereby, of the matter(s) of the persistent enabling and support of the massive fraud(s) upon the people by the founding predecessors and present actors of the defacto UNITED STATES corporate government, includes:
- a) abetting of the same deception upon the natural people de jure; to wit: Darrell-James: Hill, et al.:

Political Status Election: Affirmation In Confirmation of Sovereign

2022-011769 MISC Page: 269 of 2782
 09/26/2022 03:35:37 PM Receipt #: 22-9381
 Rec Fee: \$30.00 Darrell James Hill
 Gila County, Az, Sadie Jo Bingham, Recorder

270

Political Status Election: Affirmation In Confirmation of Sovereign

[INTENTIONALLY LEFT BLANK]

2022-011769 MISC Page: 270 of 2782
09/26/2022 03:35:37 PM Receipt #: 22-9381
Rec Fee: \$30.00 Darrell James Hill
Gila County, Az, Sadie Jo Bingham, Recorder



10 of 20 22

Political Status Election: Affirmation In Confirmation of Sovereign

271

Unofficial Copy



Political Status Election: Affirmation In Confirmation of Sovereign

- b) protection of the extraordinary and persistent UNITED STATES corporate policy of covin, conspiracy, and collusion constructed and condoned by the present day UNITED STATES corporation and actor(s), pursuant from, in the nature of the 20th Amendment to the UNITED STATES Constitution; and:
- c) subsequent Corporate and complicit agent acts including, but not limited to: progressive development of the Cestui Que Trust: entitled: DARRELL JAMES HILL, for the feigned benefit of the natural born American citizenry Darrell-James: Hill, "Secured Party", while implementing a patent systematic usufruct of the same people's trusts for the profit: power, prestige and privilege for egotistical gain while imposing the most massive abuse upon the trust beneficiaries, the American citizenry.

AUTHORITY

I: Darrell-James: Hill have all of the authority as a man under the God Almighty to establish this political election and dispel all of the contrary presumptions by the any actor(s), including, but not limited to the commercial entities mentioned/ referred to in this document, this: presumption is set. Furthermore: fidelity of the constitutional integrity of every UNITED STATES agency, and the any of the officer(s)/actor(s) thereof, are under the Constitution for the united States of America under Almighty God. Therefore: any commercial entity or actor with which Darrell-James: Hill may make acquaintance and/ or come into contact shall heretofore instantly seek and protect Darrell-James: Hill's every Right(s) and Remedy(ies) and interest(s) within the direct obedience under Almighty God under the Constitutional oath of their office which is under duty to The Constitution for the united States of America, to the service and protection: Darrell James: Hill; to wit:

KJV: Book: Exodus 20:1 And God spake all these words, saying, 20:2 I *am* the LORD thy God, which have brought thee out of the land of Egypt, out of the house of bondage. 20:3 Thou shalt have no other gods before me. 20:4 Thou shalt not make unto thee any graven image, or any likeness of *any thing* that *is* in heaven above, or that *is* in the earth beneath, or that *is* in the water under the earth: 20:5 Thou shalt not bow down thyself to them, nor serve them: for I the LORD thy God *am* a jealous God, visiting the iniquity of the fathers upon the children unto the third and fourth *generation* of them that hate me; 20:6 And shewing mercy unto thousands of them that love me, and keep my commandments. 20:7 Thou shalt not take the name of the LORD thy God in vain; for the LORD will not hold him guiltless that taketh his name in vain. 20:8 Remember the sabbath day, to keep it holy. 20:9 Six days shalt thou labour, and do all thy work: 20:10 But the seventh day *is* the sabbath of

2022-011769 MISC Page: 271 of 2782

09/25/2022 03:35:37 PM Receipt #: 22-9381
 Rec Fee: \$30.00 Darrell James Hill
 Gila County, AZ Sadie Jo Bingham Recorder

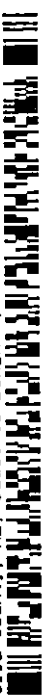

272

Political Status Election: Affirmation In Confirmation of Sovereign

[INTENTIONALLY LEFT BLANK]

2022-011769 MISC Page: 272 of 2782
09/26/2022 03:35:37 PM Receipt #: 22-9981
Rec Fee: \$30.00 Darrell James Hill
Gila County, Az, Sadie Jo Bingham, Recorder



Political Status Election: Affirmation In Confirmation of Sovereign

12 of 2022



273

Unofficial Copy

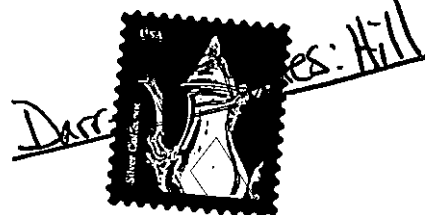

Political Status Election: Affirmation In Confirmation of Sovereign

the LORD thy God: *in it* thou shalt not do any work, thou, nor thy son, nor thy daughter, thy manservant, nor thy maidservant, nor thy cattle, nor thy stranger that *is* within thy gates: 20:11 For *in* six days the LORD made heaven and earth, the sea, and all that in them *is*, and rested the seventh day: wherefore the LORD blessed the sabbath day, and hallowed it. 20:12 Honour thy father and thy mother: that thy days may be long upon the land which the LORD thy God giveth thee. 20:13 Thou shalt not kill. 20:14 Thou shalt not commit adultery. 20:15 Thou shalt not steal. 20:16 Thou shalt not bear false witness against thy neighbour. 20:17 Thou shalt not covet thy neighbour's house, thou shalt not covet thy neighbour's wife, nor his manservant, nor his maidservant, nor his ox, nor his ass, nor any thing that *is* thy neighbour's[:] to wit:

KJV: Book: Proverbs-Chapter 17:15 He that justifieth the wicked, and he that condemneth the just, even they both *are* abomination to the LORD... 17:23 A wicked *man* taketh a gift out of the bosom to pervert the ways of judgment. Chapter 18:5 *It is* not good to accept the person of the wicked, to overthrow the righteous in judgment. Chapter 20:10 Divers weights, *and* divers measures, both of them *are* alike abomination to the LORD. 20:25 *It is* a snare to the man *who* devoureth *that which is* holy, and after vows to make enquiry.

“The law will protect an individual who, in the prosecution of a right does everything which the law requires him to do but fails to obtain his right by the misconduct or neglect of a public officer.” See in the nature of Lyle v. Arkansas, 9 Howe 314, 13 L. Ed 153; Duluth & Iron Range Co. v. Roy, 173 U.S. 587, 19 S. Ct 549, 43 L. Ed 820.

“It is a maxim of the law, admitting few if any exceptions, that every duty laid upon a public officer for the benefit of a private person, is enforceable by judicial process”. See in the nature of Butterworth v. U.S. ex rel. Hoe, 112 U.S. 50, 5 S. Ct 25, 28 L. Ed 656.

I: Darrell-James: Hill have all of the authority, and of the duty, to examine from the any where is the authority of the any one claiming to represent the any government at the any level; to wit:

KJV: Book: 1 John-Chapter 4:1 Beloved, believe not every spirit, but try the spirits whether they are of God: because many false prophets are gone out into the world. 4:2 Hereby know ye the Spirit of God: Every spirit that confesseth that

Political Status Election: Affirmation In Confirmation of Sovereign

274

2022-011769 MISC Page: 273 of 2782
09/26/2022 03:35:37 PM Receipt #: 22-9361
Rec Fee: \$30.00 Darrell James Hill
Gila County, Az, Sadie Jo Bingham, Recorder



Political Status Election: Affirmation In Confirmation of Sovereign

[INTENTIONALLY LEFT BLANK]

2022-011769 MISC Page: 274 of 2782

09/26/2022 09:35:37 PM Receipt #: 22-9381

Rec Fee: \$30.00 Darrell James Hill

Gila County, Az, Sadie Jo Bingham, Recorder



Dance

es: Hill

14 of 20
²²

Political Status Election: Affirmation In Confirmation of Sovereign

275

Unofficial Copy



Political Status Election: Affirmation In Confirmation of Sovereign

Jesus Christ is come in the flesh is of God: 4:3 And every spirit that confesseth not that Jesus Christ is come in the flesh is not of God: and this is that *spirit* of antichrist, whereof ye have heard that it should come; and even now already is it in the world.

Notification of the legal responsibility is "the first essential of due process of law." See in the nature of *Connally v. General Construction Co.*, 269 U.S. 385, 391.

"Silence can only be equated with fraud where there is a legal or moral duty to speak or when an inquiry left unanswered would be intentionally misleading." See in the nature of *U.S. v. Tweel*, 550 F.2d.297.

It is in the ministerial fiduciary/trustee duty of the each and every government official, officer, agent, contractor and assign of the UNITED STATES, and of its derivatives; to wit: STATE OF ARIZONA, ET SEQ., Federal Reserve Banks/System, International Monetary Fund, International Finance Corporation, International Bank for Reconstruction and Development, Inter-American Development Bank, World Bank, Commission of the European Communities, Organization for Economic Co-operation and Development, United Nations, and of the any and all other agent(s) who view of this notice, "Respondent(s)" to timely and fully answer. See in the nature of *Federal Crop Insurance v. Merrill*, 332 U.S. 380, 92 L. Ed 10, 68 S.Ct 1,(1947) 175 ALR 1075.

2022-011769 MISC Page: 275 of 2782
09/26/2022 03:35:37 PM Receipt #: 22-9381
Rec Fee: \$30.00 Darrell James Hill
Gila County, Az, Sadia Jo Bingham Recorder

ORDERS:

- 1) The presumption is set that: Darrell-James: Hill is a natural man born of the family Hill and then after named to be: Darrell-James shall not be presumed to be the surety for the stramineus homo title in the form of "DARRELL JAMES HILL," also known by the any and all of the derivatives and variations in the spelling of the said name except: "Darrell-James: Hill?".
- 2) The Claim of Cestui Que Trust entitled DARRELL JAMES HILL is set that: command of the beneficial interest: Darrell-James: Hill: the natural man is now herein identified.
- 3) Idem Sonans is Disallowed is set: Cease and desist all of the use of a doctrine of *idem sonans* by any actor to effect any presumption or scheme reproaching Darrell-James: Hill's inherent sovereignty Rights. Such actions are prohibited and admittedly willful constructive fraud, and constitutes admission of the same in the non-judicial venue enforceable against the entity, et al., by the secured party through tacit procuration.
- 4) Notice to the principal is notice to all of the agent(s). Notice to the agent is notice to all of the principals

276

Political Status Election: Affirmation In Confirmation of Sovereign

[INTENTIONALLY LEFT BLANK]

2022-011769 MISC Page: 276 of 2782
09/26/2022 03:35:37 PM Receipt #: 22-9381
Rec Fee: \$30.00 Darrell James Hill
Gila County, Az, Sadie Jo Bingham, Recorder



Darrell James Hill

Political Status Election: Affirmation In Confirmation of Sovereign

16 of 20 ²²

277

Unofficial Copy

Dec 2022 James Hill



Political Status Election: Affirmation In Confirmation of Sovereign

Enclosure-1

- a) Notarial Acknowledgment of Authentic "CERTIFICATE OF BIRTH"
- b) copy of CERTIFICATE OF BIRTH, STATE OF OHIO
- c) Notarial Acknowledgment of Original "Arizona Driver License"
- d) copy of "Arizona Driver License"

2022-011769 MISC Page: 277 of 2782
 09/26/2022 03:35:37 PM Receipt #: 22-9381
 Rec Fee: \$30.00 Darrell James Hill
 Gila County, Az, Sadie Jo Bingham, Recorder



278

Unofficial Copy

Political Status Election: Affirmation In Confirmation of Sovereign

[INTENTIONALLY LEFT BLANK]

2022-011769 MISC Page: 278 of 2782
09/25/2022 03:35:37 PM Receipt #: 22-9381
Rec Fee: \$30.00 Darrell James Hill
Gila County, Az; Sadie Jo Bingham, Recorder



279

**NOTARIAL ACKNOWLEDGMENT
OF ORIGINAL, AUTHENTIC, BIRTH CERTIFICATE**



I HEREBY CERTIFY THIS DOCUMENT IS AN EXACT COPY OF THE RECORD ON FILE WITH THE OHIO DEPARTMENT OF HEALTH.

DE 24 01 [REDACTED]

[Signature]
REGISTRAR, OHIO DEPARTMENT OF HEALTH, DIVISION OF VITAL STATISTICS, COLUMBUS, OHIO

**OHIO DEPARTMENT OF HEALTH
DIVISION OF VITAL STATISTICS
CERTIFICATE OF LIVE BIRTH**

Reg. Dist. No. [REDACTED] Primary Reg. Dist. No. [REDACTED] Registrar's No. [REDACTED] Birth No. [REDACTED]

1. PLACE OF BIRTH
a. COUNTY [REDACTED]
b. CITY, VILLAGE, OR LOCATION [REDACTED]

2. USUAL RESIDENCE OF MOTHER (Where does mother live?)
a. STATE Ohio
b. CITY, VILLAGE, OR LOCATION [REDACTED]

3. NAME (Type or Print)
Darrell James Hill

4. SEX M
5. BIRTH DATE MONTH DAY YEAR [REDACTED]

6. BIRTH PLACE (State or foreign country) [REDACTED]

7. FATHER'S NAME (Type or Print)
[REDACTED]

8. FATHER'S USUAL OCCUPATION [REDACTED]

9. MOTHER'S MAIDEN NAME (Type or Print)
[REDACTED]

10. MOTHER'S BIRTH PLACE (State or foreign country) [REDACTED]

11. PREVIOUS DELIVERIES TO MOTHER (Do not include this birth)
12. How many OTHER children (Are now born alive but are now dead?) [REDACTED]

13. COLOR OR RACE Negro

14. DATE SEROLOGIC TEST FOR SYPHILIS [REDACTED]

15. ATTENDANT AT BIRTH
M.D. [REDACTED] O.C. [REDACTED] MIDWIFE [REDACTED] OTHER [REDACTED]

16. DATE SIGNED [REDACTED]

17. DATE ON WHICH GIVEN NAME ADDED [REDACTED]

18. I hereby certify that this child was born alive on the date stated above.

19. SIGNATURE [REDACTED]

20. DATE [REDACTED]

21. REGISTRAR'S SIGNATURE *[Signature]*

22. DATE ON WHICH GIVEN NAME ADDED [REDACTED]

STATE OF ARIZONA
COUNTY OF MARICOPA

ON this 28th day of June, 2015 A.D., by me, a notary public in and for the said STATE OF ARIZONA, residing therein, duly commissioned and sworn, personally appeared and upon the presentation of sufficient documentation satisfactorily proved to me to be the person DARRELL JAMES HILL, and who provided to me a document from the STATE OF OHIO for notarial acknowledgment.

The document is on a specialty multi-colored type of safety paper with repetitive circular with center of "ODH" watermark throughout observable when held up to the light; the right upper corner area bears a depressed seal mark. Document is entitled: "OHIO DEPARTMENT OF HEALTH, DIVISION OF VITAL STATISTICS, CERTIFICATE OF LIVE BIRTH".

Document content: Left side: Reg. Dist. No. [REDACTED] below is: Primary Reg. Dist. No. [REDACTED] Right side: Registrar's No. [REDACTED] below, Birth No. [REDACTED]

Descriptive document content: 1. PLACE OF BIRTH: Summit... 2. USUAL PLACE OF RESIDENCE OF MOTHER, a. STATE Ohio... 3. CHILD: NAME; Darrell James Hill... 7. FATHER: NAME: [REDACTED]... 12. MOTHER: Maiden [REDACTED]... With 2 signatures below: Certification of birth statement and SIGNATURE, and a REGISTRAR'S SIGNATURE in cursive writing, "Ruth Holecek"

I acknowledge this document as authentic.

Witness my hand and seal this
28th day of June, 2015.



KALLE KIVINEN
Notary Public - Arizona
Maricopa County
Expires on 08/15/2016

Notary *[Signature]* My Commission Expires 8-15-2016

280

2022-011769 MISC Page: 279 of 2762
09/26/2022 03:35:37 PM Receipt #: 22-9381
Rec Fee: \$30.00 Darrell James Hill
Gila County, AZ, Sadie Jo Bingham, Recorder

NOTARIAL ACKNOWLEDGMENT
OF ORIGINAL, AUTHENTIC, BIRTH CERTIFICATE

[REDACTED]

[REDACTED]

[REDACTED]

[REDACTED]

[REDACTED]

[REDACTED]

[REDACTED]

[REDACTED]

[INTENTIONALLY LEFT BLANK]

[REDACTED]

[REDACTED]

[REDACTED]

[REDACTED]

[REDACTED]

[REDACTED]

[REDACTED]

[REDACTED]

[REDACTED]

281

Darrell Hill



Darrell James Hill

NOTARIAL ACKNOWLEDGMENT OF ORIGINAL, AUTHENTIC, ARIZONA, Driver License

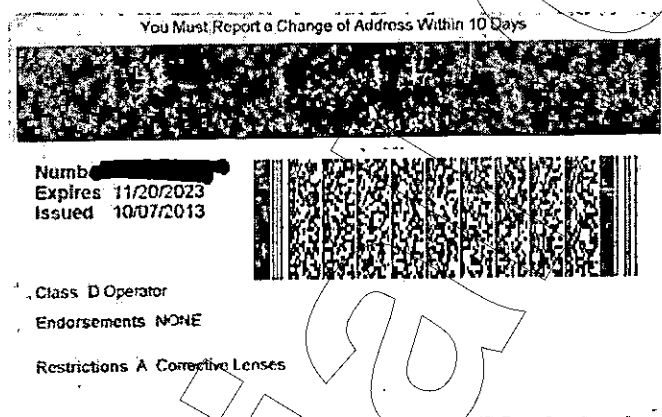
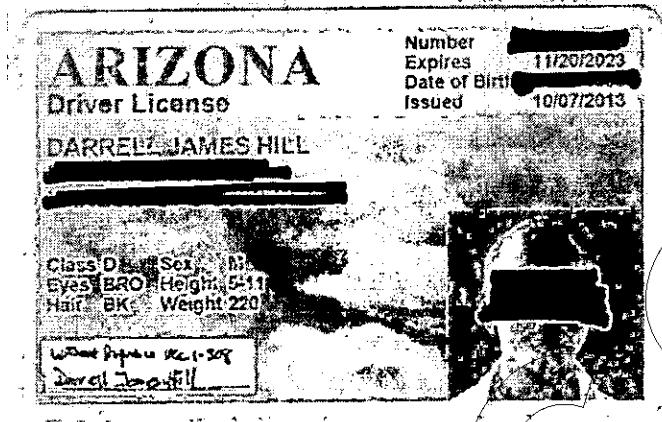

STATE OF ARIZONA COUNTY OF MARICOPA

ON this 28th day of June, 2015 A.D., by me, a notary public in and for the said STATE OF ARIZONA, residing therein, duly commissioned and sworn, personally appeared and upon the presentation of sufficient documentation satisfactorily proved to me to be the person DARRELL JAMES HILL, and who provided to me a document from the STATE OF ARIZONA for notarial acknowledgment.

The document is set upon a sky-mountain background picture, is entitled "ARIZONA, DRIVER LICENSE" in the upper left corner with repetitively distributed throughout the card a 'state-shaped-picture with the words "CANYON"' following. The document is signed in the lower left corner, with a likeness picture of the presumed signer in the lower right corner. The picture in the right lower corner is a reasonable facsimile of Darrell-James: Hill.

The right upper corner document content information is: "Number [redacted] Expires 11/20/2023; Date of Birth 11/20/1958; Issued 10/07/2013.

The middle document content information is: "DARRELL JAMES HILL" with a following address location, below which is a description of a person, and below which is a signum in a white box at the left base of the card document.

I acknowledge this document as authentic.

Witness my hand and seal this 28th day of JUNE, 2015.



KALLE KIVINEN Notary Public - Arizona Maricopa County Expires on 08/15/2016

Notary [Signature]

My Commission Expires 8-15-2016

282

**NOTARIAL ACKNOWLEDGMENT
OF ORIGINAL, AUTHENTIC, ARIZONA, Driver License**

[REDACTED]

[REDACTED]

[REDACTED]

[REDACTED]

[INTENTIONALLY LEFT BLANK]

[REDACTED]

283





Political Status Election: Affirmation In Confirmation of Sovereign

For the Babel Communications: The content of this document is written nunc pro tunc in the babel language communication style common on the day of this document, as distinguished against Complete-Sentence-Sense-Parse-Syntax-Grammar, "CSSPSG" context communication. Any translation and/or interpretation shall be contextually construed in accordance with the meaning intended by the writer.

CHOSE IN ACTION IS EXECUTED: Affirmation In Confirmation of Political Status Election; and by this execution, so be it done.

Darrell James: Hill
SECURED PARTY

Arizona state territory:

Witness of Signor:

I: man upon the ground, a sojourner in the Arizona state territory beyond the sea on this 28 day of the June month in the year anno domini two thousand fifteen, am. And, after the witnessing of the Darrell-James: Hill's applying his signature onto this document, I affirm same by my signature to the fact that: 1) I witnessed: Darrell-James: Hill applying his signature to the document; and, 2) I know: Darrell-James: Hill personally.

Witness: Jay Dunge date 6.28.15

Witness: [Signature] date 6/28/2015

Witness: Virginia H. Green date 6/28/15

2022-011769 MISC Page: 283 of 2782
09/26/2022 03:35:37 PM Receipt #: 22-9381
Rec Fee: \$30.00 Darrell James Hill
Gila County, Az, Sadie Jo Bingham, Recorder



284

Political Status Election: Affirmation In Confirmation of Sovereign

[INTENTIONALLY LEFT BLANK]

2022-011789 MISC Page: 284 of 2782
09/26/2022 03:35:37 PM Receipt #: 22-9381
Rec Fee: \$30.00 Darrell James Hill
Gila County, Az, Sadie Jo Bingham, Recorder



20 of 22

Political Status Election: Affirmation In Confirmation of Sovereign

285

Unofficial Copy

Darrell James Hill



Political Status Election: Affirmation In Confirmation of Sovereign

Acceptance By The Debtor Party: SECURED PARTY's signature in accordance with the UCC §§ 1-201(37) (2001 CE), 3-401 (2002 CE), and accepts for the value to this Security Agreement and all: SECURED PARTY's herein-above- described AUTHORITY(S).

DARRELL JAMES HILL

DARRELL JAMES HILL

STATE OF ARIZONA

COUNTY OF MARICOPA

ON this 28th day of June, 2015 A.D., by me, a notary public in and for the said STATE OF ARIZONA, residing therein, duly commissioned and sworn, personally appeared DARRELL JAMES HILL, satisfactorily proved to me upon the presentation of sufficient documentation to be the person described in and who executed the within instrument. Witness my hand and seal this

28th day of June, 2015.



KALLE KIVINEN
Notary Public - Arizona
Maricopa County
Expires on 08/15/2016

Notary [Signature]

My Commission Expires 8-15-2016

L.S. Darrell - James Hill

2022-011769 MISC Page: 285 of 2782

09/26/2022 03:35:37 PM Receipt #: 22-9381
Rec Fee: \$30.00 Darrell James Hill
Gila County, Az, Sadie Jo Bingham, Recorder



286

Political Status Election: Affirmation In Confirmation of Sovereign

[INTENTIONALLY LEFT BLANK]

2022-011769 MISC Page: 286 of 2782
09/26/2022 03:35:37 PM Receipt #: 22-9381
Rec Fee: \$30.00 Darrell James Hill
Gila County, Az, Sadie Jo Bingham, Recorder



22 of 22

287

Political Status Election: Affirmation In Confirmation of Sovereign

[Handwritten scribbles]

Unofficial Copy

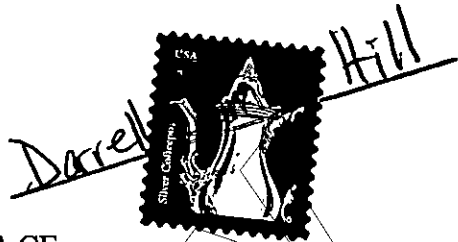

SECURITY AGREEMENT DJH001-SA-06252015-SA CE
Non-Negotiable – Private Agreement Between two Parties

Unofficial Copy

ENCLOSURE-2

Private Agreement: DJH001-PA

2022-011769 MISC Page: 287 of 2782
 09/28/2022 03:35:37 PM Receipt #: 22-9381
 Rec Fee: \$30.00 Darrell James Hill
 Gila County, Az, Sadie Jo Bingham, Recorder



288

SECURITY AGREEMENT DJH001-SA 06252015-SA CE
Non-Negotiable – Private Agreement Between two Parties

Unofficial Copy

INTENTIONALLY LEFT BLANK

2022-011769 MISC Page: 288 of 2782

09/26/2022 03:35:37 PM Receipt #: 22-9981

Rec Fee: \$30.00 Darrell James Hill
Gila County, Az, Sadie Jo Bingham, Recorder

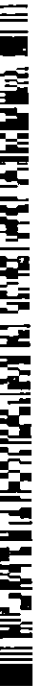

289

SECURITY AGREEMENT DJH001-SA 06252015-SA CE

Darrell James Hill



56 of 68



Private Agreement: DJH001-PA 06252015-PA CE
Non-Negotiable – Private Between the Parties:

L.S. ~~Darrell-James~~ DARRELL JAMES HILL
L.S. ~~Darrell-James: Hill~~

DEBTOR:

DARRELL JAMES HILL
C/O 5124 East 18th Avenue
Apache Junction, Arizona 85119

CREDITOR:

Darrell-James: Hill
C/O General Delivery
Apache Junction MPO
Apache Junction, Arizona [851209998]

1 This: **Private Agreement** is in regards to the mutually agreed upon and entered into contract:
2 06252015-PA CE between the commercial person: DARRELL JAMES HILL, also known by the
3 any and all of the linear derivatives and variations in the spelling of the said name except:
4 "Darrell-James: Hill", hereinafter jointly and severally "DEBTOR," and: real man, sui juris,
5 living on the ground beyond the sea: natural, biological, spiritual, and soulful man in the
6 understanding of the Almighty God, to wit: "Darrell-James: Hill", hereinafter the "SECURED
7 PARTY."

8 This: contract by the DEBTOR AND SECURED PARTY is for the consideration(s); to wit:

9 **A) SECURED PARTY:**

10 SECURED PARTY agrees to serve in the administrative capacity of the Controlling Creditor and/
11 Entitlement Holder in the commercial concerns of the DEBTOR, and to provide: substance of the
12 animus in the natural person American born relationship in the distinction to the DEBTOR
13 commercial person; to wit:

14 SECURED PARTY shall:

15 a) constitute: source, origin, substance, and natural being of the any "preexisting claim"
16 from where of the derivative existence of the DEBTOR is affirmed;

17 b) constitute: source of the DEBTOR's asset identity, via the natural existence and
18 animation, and of the all of the faculties of the labor of the Controlling Creditor or Entitlement
19 Holder or SECURED PARTY for the any support of the any contract whatsoever that: DEBTOR
20 may execute, and for the any involvement for all of that which is of the whatever may be
21 wherein the DEBTOR may be regarded as bound;

22 c) serve: basis of the "Authorized Representative" for the DEBTOR interacting,
23 facilitating, contracting, and exchanging of the goods and services in all of the areas involving:

2022-011769 MISC Page: 289 of 2782
09/26/2022 09:35:37 PM Receipt #: 22-9381
Rec Fee: \$30.00 Darrell James Hill
Gila County, Az, Sadle Jo Bingham, Recorder

290

Private Agreement: DJH001-PA 06252015-PA CE
Non-Negotiable – Private Between the Parties:

Unofficial Copy

1

[INTENTIONALLY LEFT BLANK]

2022-011769 MISC Page: 290 of 2782
09/26/2022 03:35:37 PM Receipt #: 22-9381
Rec Fee: \$30.00 Darrell James Hill
Gila County, Az, Sadie Jo Bingham, Recorder



291

PRIVATE AGREEMENT DJH001-PA 06252015-PA CE

2 of 8





Private Agreement: DJH001-PA 06252015-PA CE
Non-Negotiable – Private Between the Parties:

1 natural administrative aspects, and touching upon the engagements and obligations with other
2 Authorized Representatives;
3 d) provide for the safety for all of the payments of the all of the sums now due and owing,
4 and as might become due and owed by the DEBTOR;

5 **B) DEBTOR:**

6 DEBTOR is to serve in the commercial Transmitting Utility of the stramineus homo construct
7 germane to the DEBTOR's original creation and purpose; to wit:

8 DEBTOR shall:

9 a) function to serve in the capacity of the transmitting utility for the benefit of the
10 Controlling Creditor and/or Entitlement Holder and/or SECURED PARTY;

11 b) indemnify, defend, and hold harmless: Controlling Creditor and Entitlement Holder and
12 SECURED PARTY from and against the any and all of the any liability, claims, demands, orders,
13 summonses, warrants, judgments, damages, costs, losses, liens, levies, depositions, lawsuits, legal
14 actions, penalties, fines, interests, and expenses whatsoever, both absolute and contingent, due and
15 as might become due, now existing and hereafter arising, howsoever evidenced, suffered, incurred
16 by, and imposed onto the DEBTOR, and that for whatever reason, purpose, and cause whatsoever;
17 including but not limited to:

18 (i) acknowledging, consenting and agreeing to forever insulate: Controlling Creditor or
19 Entitlement Holder or SECURED PARTY when/if ever: SECURED PARTY may be
20 considered or presumed to be he DEBTOR, or considered to be the accommodation
21 party, or surety, for the DEBTOR.

22 Terms Defined; Glossary of Terms. As used in this Private Agreement, the following words and
23 terms are as defined in the Terms Defined section of the Security Agreement DJH001-SA 06252015
24 CE, non obstante.

25 For the Babel Communications: The content of this document is written nunc pro tunc in the babel
26 language communication style common on the day of this document, as distinguished against
27 Complete-Sentence-Sense-Parse-Syntax-Grammar, "CSSPSG" context communication. Any
28 translation and/or interpretation shall be contextually construed in accordance with the meaning
29 intended by the writer.

30 **This: agreement is for a continuing Private Agreement which perpetuates in the any of the**
31 **event or effect of the Parties unto the disposes of the estate by the Power of Attorney for the**
32 **SECURED PARTY.**

2022-011769 MISC Page: 291 of 2782
09/25/2022 03:35:37 PM Receipt #: 22-9381
Rec Fee: \$30.00 Darrell James Hill
Gila County, Az, Sadie Jo Bingham, Recorder

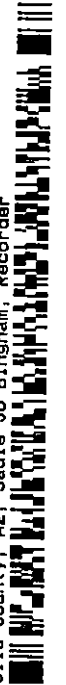

292

Private Agreement: DJH001-PA 06252015-PA CE
Non-Negotiable – Private Between the Parties:

293

1

[INTENTIONALLY LEFT BLANK]

Unofficial Copy

2022-0111769 MISC Page: 292 of 2782
09/26/2022 03:35:37 PM Receipt #: 22-9381
Rep Fee: \$30.00 Darrell James Hill
Gila County, Az, Sadie Jo Bingham, Recorder



Darrell James Hill





Darrell James Hill

Private Agreement: DJH001-PA 06252015-PA CE
Non-Negotiable – Private Between the Parties:

1 This: Private Agreement: DJH001-PA 06252015-PA CE
2 DEBTOR: Transmitting Utility,

3 DARRELL JAMES HILL
4 DARRELL JAMES HILL

STATE OF ARIZONA

COUNTY OF MARICOPA

5 ON this 28th day of June, 2015 A.D., by me, a notary public in and for the said STATE OF
6 ARIZONA, residing therein, duly commissioned and sworn, personally appeared DARRELL JAMES
7 HILL, satisfactorily proved to me upon the presentation of sufficient documentation to be the person
8 described in and who executed the within instrument. Witness my hand and seal this

9 28th day of JUNE, 2015.



KALLE KIVINEN
Notary Public - Arizona
Maricopa County
Expires on 08/15/2016

10 Notary [Signature] My Commission Expires 8-15-2016

2022-011769 MISC Page: 293 of 2782

09/26/2022 03:35:37 PM Receipt #: 22-9381
Darrell James Hill
Gila County, Az, Sadie Jo Bingham, Recorder

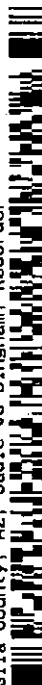

294

COPY

Private Agreement: DJH001-PA 06252015-PA CE
Non-Negotiable – Private Between the Parties:

295

1

[INTENTIONALLY LEFT BLANK]

Unofficial Copy

2022-011769 MISC Page: 294 of 2782
09/26/2022 03:35:37 PM Receipt #: 22-9381
Rec Fee: \$30.00 Darrell James Hill
Gila County, Az, Sadie Jo Bingham, Recorder



Darrell Hill

PRIVATE AGREEMENT DJH001-PA 06252015-PA CE

6 of 8

Darrell James Hill



Private Agreement: DJH001-PA 06252015-PA CE
Non-Negotiable – Private Between the Parties:

1 **Acceptance By The Secured Party:**

2 Entitlement Holder or SECURED PARTY accepts: DEBTOR's signature in accordance with the
3 UCC §§ 1-201(37) (2001 CE), 3-401 (2002 CE), and accepts for the value to this Security
4 Agreement and any: DEBTOR's herein-above- described/ itemized Collateral.

(SECURED PARTY's Signature)

Without prejudice: UCC 1-308

Darrell James Hill
SECURED PARTY:

8
9 **Arizona state territory:**

10 **Witness of Signor:**

11 I, man upon the ground, a sojourner in the Arizona state territory beyond the sea on this 28 day of the
12 June month in the year anno domini two thousand fifteen, am. And, after the witnessing of
13 the Darrell-James: Hill's applying his signature onto this document, I affirm same by my signature to
14 the fact that: 1) I witnessed: Darrell-James: Hill applying his signature to the document; and, 2) I
15 know: Darrell-James: Hill personally.

Witness: Jay Jimpel date 6-28-15
Witness: Jeffery Paul Lee date 6/28/2015
Witness: Virginia L. Green date 6/28/15

L.S. DARRELL JAMES HILL

L.S. Darrell-James: Hill

Unofficial Copy

2916

PRIVATE AGREEMENT

2022-011769 MISC Page: 295 of 2782
09/26/2022 03:35:37 PM Receipt #: 22-9381
Rec Fee: \$30.00 Darrell James Hill
Gila County, Az, Sadie Jo Bingham, Recorder

Private Agreement: DJH001-PA 06252015-PA CE
Non-Negotiable – Private Between the Parties:

[INTENTIONALLY LEFT BLANK]

1

297

2022-011769 MISC Page: 296 of 2782
09/26/2022 03:35:37 PM Receipt #: 22-9381
Rec Fee: \$30.00 Darrell James Hill
Gila County, Az, Sadie Jo Bingham, Recorder



PRIVATE AGREEMENT DJH001-PA 06252015-PA CE



8 of 8

Darrell Hill



**SECURITY AGREEMENT DJH001-SA 06252015-SA CE
Non-Negotiable – Private Agreement Between two Parties**

ENCLOSURE-3

Trade-name and Trade-mark, Notice and Agreement: DJH001-TN

Unofficial Copy

298

SECURITY AGREEMENT DJH001-SA 06252015-SA CE

57 of 68

2022-011769	MISC	Page: 297 of 2782
09/26/2022 03:35:37 PM	Receipt #: 22-9381	
Rec Fee: \$30.00 Darrell James Hill		
Gila County, Az, Sadie Jo Bingham, Recorder		



SECURITY AGREEMENT DJH001-SA 06252015-SA CE
Non-Negotiable – Private Agreement Between two Parties

[INTENTIONALLY LEFT BLANK]



SECURITY AGREEMENT DJH001-SA 06252015-SA CE

58 of 68

2022-011769 MISC Page: 298 of 2782
09/26/2022 03:35:37 PM Receipt #: 22-9381
Rec Fee: \$30.00 Darrell James Hill
Gila County, Az, Sadie Jo Bingham, Recorder



299

Unofficial Copy

**Trade-name and Trade-mark
Notice and Agreement
DJH001-TN 06252015-TN CE**

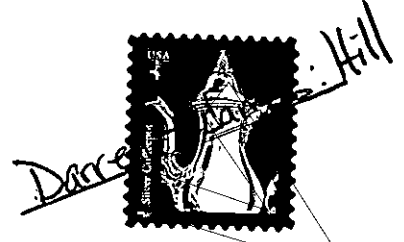

L.S. DARRELL JAMES H. HILL
L.S. Darrell-James: Hill

Trade-name and Trade-mark Notice and Agreement

1 All of the rights reserved are in regards to the "DARRELL JAMES HILL", as well as of the any
2 and all of the derivatives and variations in the spelling(s) referring to the same name and mark;
3 to wit: Trade-name and Trade-mark, a name and signum similarly identical to the stramineus
4 homo entity "DARRELL JAMES HILL" which established the Trade-name and Trade-mark,
5 and, is as relates to the secured party and particulars thereto in this Trade-name/Trade-mark
6 Notice and Agreement constituted by the natural person, to wit: Darrell-James: Hill, hereinafter
7 "SECURED PARTY."

8 Authorized Use of the Trade-name/Trade-mark:

9 Use of the said Trade-name or Trade-mark in the whole or in the part, or in the any manner
10 whatsoever, is prohibited without the prior express written consent as indicated by the SECURED
11 PARTY's signature in a red ink; to wit: any commercial person, or another person, or of the
12 actors of the any of the said person(s), who with the intent of the being contractually bound,
13 consent and agree to be bound by this Trade-name/Trade-mark Notice and Agreement in the
14 agreement to neither display, nor use in the any manner: Trade-name/Trade-mark presented
15 herein, including to not use the any of the derivatives in the spelling or in the idem sonans with
16 reference to the same without the prior, express, written consent and acknowledgment from the
17 Secured Party.

18 Agreement in the Event of the Unauthorized Use:

19 **NOTICE AND WARNING:**

20 Unauthorized user of the Trade-name/Trade-mark by any commercial person, or by another person,
21 or by the actors for the said person(s), hereinafter jointly and severally "User," agree that neither by
22 the any User, nor by the actor of the said User, shall there be displayed or used in the any manner:
23 Trade-name or Trade-mark presented herein, to wit: DARRELL JAMES HILL, or the any variation
24 thereof, or the any derivative of the said name referring to same, without the prior, express, written
25 consent of the SECURED PARTY, as signified by the SECURED PARTY's signature in a red ink.
26 Per either vehicle, that is, by use of the published Trade-name and Trade-mark Notice: NOTICE
27 AND WARNING herein, or of the SECURITY AGREEMENT DJH001-SA 06252015-SA:
28 NOTICE AND WARNING; unauthorized use of the DARRELL JAMES HILL by the any User or
29 by the any actor of the said User constitutes the sure consent and concomitant agreement that the
30 any use of the DARRELL JAMES HILL by any method other than that of the authorized use as set
31 forth herein, or following by the SECURED PARTY's delivered NOTICE -by a written
32 communication-, evidences: User's tacit and indirect agreement or consent and confession to
33 transferring to the SECURED PARTY: all of the authority



300

**Trade-name and Trade-mark
Notice and Agreement
DJH001-TN 06252015-TN CE**

1

[INTENTIONALLY LEFT BLANK]

301
Trade-name/Trade-mark Notice and Agreement: DJH001-TN 06252015-TN CE



2022-011769 MISC Page: 300 of 2782
09/26/2022 03:35:37 PM Receipt #: 22-9381
Rec Fee: \$30.00 Darrell James Hill
Gila County, Az, Sadie Jo Bingham, Recorder



**Trade-name and Trade-mark
Notice and Agreement
DJH001-TN 06252015-TN CE**



1 by tacit procuracy for the impending non-judicial forum judgment against the User for the any
2 unauthorized use of the said Trade-name or Trade-mark, and, to wit, that such actions did
3 contractually bind to the User, and signified therefore that: User:

- 4 1) grants to the SECURED PARTY a security interest in, and a distress warrant or lien
5 against: User's property(ies) and interest in the any of the User's property(ies) in the
6 sum certain amount: Five Hundred thousand and no/100 dollars: 500,000.00 USD,
7 or: equivalent currency to which the Secured Party may prefer to agree to the
8 receipt, per the each Trade-name/Trade-mark used, per the each occurrence of a use,
9 plus for the costs, plus for the triple damages, as well as: same for the each and every
10 use of the any derivatives or variations in the spelling or of the otherwise use of the
11 Trade-name or Trade-mark;
- 12 2) authenticates in the support of this Trade-name and Trade-mark Notice DJH001-
13 TN 06252015-TN CE wherein the User is the DEBTOR to the SECURED
14 PARTY; and: User pledges any of the User's property(ies) or interest in the any of
15 the User's property(ies) for the collateral securing any of the contractual
16 obligation(s);
- 17 3) authenticates in the support of the any of the UCC Financing Statement(s) wherein
18 the User is the DEBTOR to the SECURED PARTY;
- 19 4) consents and agrees that the any of the Financing Statements filed hereto are unto
20 the continuing financing status of that which the User authorized, authorizing:
21 SECURED PARTY's filing of the any initial and continuation statement(s) as
22 necessary for the maintenance of the SECURED PARTY's attachment or perfected
23 security interest(s) in the any of the User's property or of the User's right(s) in a
24 property pledged as the collateral in the aforementioned, until: User's contractual
25 obligation is fully satisfied;
- 26 5) authorizes unto the filing of the aforementioned UCC Financing Statement or
27 Security Agreement in the UCC filing office by the SECURED PARTY;
- 28 6) consents and agrees that any such filings referenced in the paragraph "5)" above are
29 not or may not be considered to be false, and that: User waives all claim(s) against
30 any such filing(s);
- 31 7) waives any of the defense(s);
- 32 8) consents and agrees that: User will execute any of the further documents and take
33 any of the further actions as requested by the SECURED PARTY that augment any
34 of the following: a) evidencing of the security interest granted herein; b) perfecting
35 of the security interest granted herein; c) maintaining of the first priority of the
36 security interest granted herein; d) effectuating of the right(s) herein granted to the
37 SECURED PARTY by the User. e) Further: User also consents and agrees in the

Trade-name/Trade-mark Notice and Agreement: DJH001-TN 06252015-TN CE

3 of 10

2022-011769 MISC Page: 301 of 2782
09/26/2022 03:35:37 PM Receipt #: 22-9381

Darrell James Hill
Gila County, Az, Sadie Jo Bingham, Recorder



302

**Trade-name and Trade-mark
Notice and Agreement
DJH001-TN 06252015-TN CE**

1

[INTENTIONALLY LEFT BLANK]

2022-011769 MISC Page: 302 of 2762
09/26/2022 03:35:37 PM Receipt #: 22-9381
Rec Fee: \$30.00 Darrell James Hill
Gila County, Az, Sadie Jo Bingham, Recorder



Trade-name/Trade-mark Notice and Agreement: DJH001-TN 06252015-TN CE

4 of 10

303

Unofficial Copy

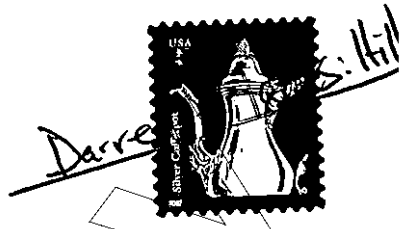

**Trade-name and Trade-mark
Notice and Agreement
DJH001-TN 06252015-TN CE**

any of the Payment Terms, Default Terms, Terms for the Curing of the Default, and Terms of the Strict Foreclosure as set forth herein or within the particularity in the NOTICE-by written communication, in regards to the Notice of Unauthorized Use of the Trade-name/Trade-mark; to wit: User consented and agreed with all of the following:

9) Payment Terms:

i) User shall pay to the Secured Party all of the unauthorized-use fees in the full within the five (5) days of the time of the date of the Secured Party's invoice delivery, hereinafter the "Invoice".

ii) Default Terms: event of the non-payment in the full of the all of the unauthorized-use fees, then: User after the five (5) days of the date of the Invoice delivery shall deem: User's non-payment of the unauthorized-use fee(s) as in the default; to wit: all of the User's property or of the User's right(s) in a property pledged as the collateral in the aforementioned transfers over to the collateral/property "in fact" of the Secured Party.

iii) Terms for Curing Default: User may cure default within ten (10) days only by the payment in the full of the unauthorized-use fees.

iv) Terms of Strict Foreclosure: User's non-payment in the full of all the unauthorized-use fees as itemized in the Invoice within said ten (10) days period for the curing of the default as set forth above: User authorizes: Secured Party by tacit procurator, to mediate unto the non-judicial strict foreclosure upon all of the User's property pledged for the collateral for the securing of the User's contractual obligation as set forth herein-above.

Accommodation:

Secured Party is not now, nor ever been, an accommodation party or a surety, for the acknowledged DEBTOR, ie.: "DARRELL JAMES HILL", or for the any of the derivative(s) thereof, nor for the any of the variations in the spelling of the said name, nor for any other stramineus homo, and is so-indemnified and held harmless by the DEBTOR - See: Hold Harmless and Indemnity Agreement DJH001-HHIA 06252015-HHIA CE, against any and all of the claims, legal actions, orders, warrants, judgments, demands, liabilities, losses, depositions, summonses, lawsuits, costs, fines, liens, levies, penalties, damages, interests, and expenses whatsoever, both of the absolute and contingent, as are due and as might become due, now existing and as might hereafter arise, and as might be suffered by, imposed on, and incurred by the DEBTOR for any and every reason, purpose, and cause whatsoever.

304

2022-011769 MISC Page: 303 of 2782
09/26/2022 03:35:37 PM Receipt #: 22-9981
Rec Fee: \$30.00 Darrell James Hill
Gila County, Az, Sadie Jo Bingham, Recorder



Trade-name and Trade-mark
Notice and Agreement
DJH001-TN 06252015-TN CE

Unofficial Copy

1

[INTENTIONALLY LEFT BLANK]

2022-011769 MISC Page: 304 of 2782
03/26/2022 03:35:37 PM Receipt #: 22-9381
Rep Fee: \$30.00 Darrell James Hill
Gila County, Az; Sadie Jo Bingham, Recorder



305

Trade-name/Trade-mark Notice and Agreement: DJH001-TN 06252015-TN CE



6 of 10



**Trade-name and Trade-mark
Notice and Agreement
DJH001-TN 06252015-TN CE**

1 For the Babel Communications: The content of this document is written nunc pro tunc in the
2 babel language communication style common on the day of this document, as distinguished
3 against Complete-Sentence-Sense-Parse-Syntax-Grammar, "CSSPSG" context communication.
4 Any translation and/or interpretation shall be contextually construed in accordance with the
5 meaning intended by the writer.

6 **Notice to the principal(s) is notice to all of the agents.**
7 **Notice to the agent(s) is notice to all of the principals.**

8 This: Trade-name and Trade-mark Notice and Agreement DJH001-TN 06252015-TN CE:
9 DEBTOR: Transmitting Utility,

10 DARRELL JAMES HILL
11 DARRELL JAMES HILL

STATE OF ARIZONA

COUNTY OF MARICOPA

12 ON this 28th day of June, 2015 A.D., by me, a notary public in and for the said STATE OF
13 ARIZONA, residing therein, duly commissioned and sworn, personally appeared DARRELL JAMES
14 HILL, satisfactorily proved to me upon the presentation of sufficient documentation to be the person
15 described in and who executed the within instrument. Witness my hand and seal this

16 28th day of JUNE, 2015.



KALLE KIVINEN
Notary Public - Arizona
Maricopa County
Expires on 08/15/2016

17 Notary [Signature] My Commission Expires 8-15-2016

2022-011769 MISC Page: 305 of 2782
09/26/2022 03:35:37 PM Receipt #: 22-9381
Rec Fee: \$30.00 Darrell James Hill
Gila County, Az, Sadie Jo Bingham, Recorder



306

**Trade-name and Trade-mark
Notice and Agreement
DJH001-TN 06252015-TN CE**

Unofficial Copy

1

[INTENTIONALLY LEFT BLANK]

307

Trade-name/Trade-mark Notice and Agreement: DJH001-TN 06252015-TN CE

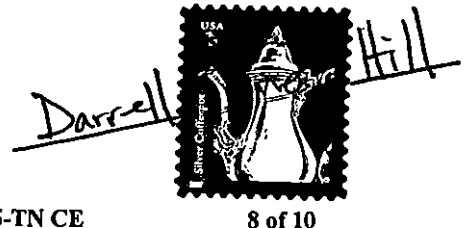

8 of 10

2022-011769 MISC Page: 306 of 2782
09/28/2022 09:35:37 PM Receipt #: 22-9381
Rec Fee: \$30.00 Darrell James Hill
Gila County, AZ, Sadie Jo Birmingham, Recorder





**Trade-name and Trade-mark
Notice and Agreement
DJH001-TN 06252015-TN CE**

1 **Acceptance By The Secured Party:**

2 Entitlement Holder or SECURED PARTY accepts: DEBTOR's signature in accordance with the
3 UCC §§ 1-201(37) (2001 CE), 3-401 (2002 CE), and accepts for the value to this Security
4 Agreement and any: DEBTOR's herein-above- described/ itemized Collateral.

(SECURED PARTY's Signature)

Without prejudice: UCC 1-308

Darrell-James: Hill
SECURED PARTY:

9 **Arizona state territory:**

10 **Witness of Signor:**

11 I: man upon the ground, a sojourner in the Arizona state territory beyond the sea on this 28 day of the
12 June month in the year anno domini two thousand fifteen, am. And, after the witnessing of
13 the Darrell-James: Hill's applying his signature onto this document, I affirm same by my signature to
14 the fact that: 1) I witnessed: Darrell-James: Hill applying his signature to the document; and, 2) I
15 know: Darrell-James: Hill personally.

Witness: [Signature] date 6-28-15
Witness: [Signature] date 6/28/2015
Witness: [Signature] date 6/28/15
Witness: _____ date _____

L.S. DARRELL JAMES HILL

L.S. Darrell-James: Hill

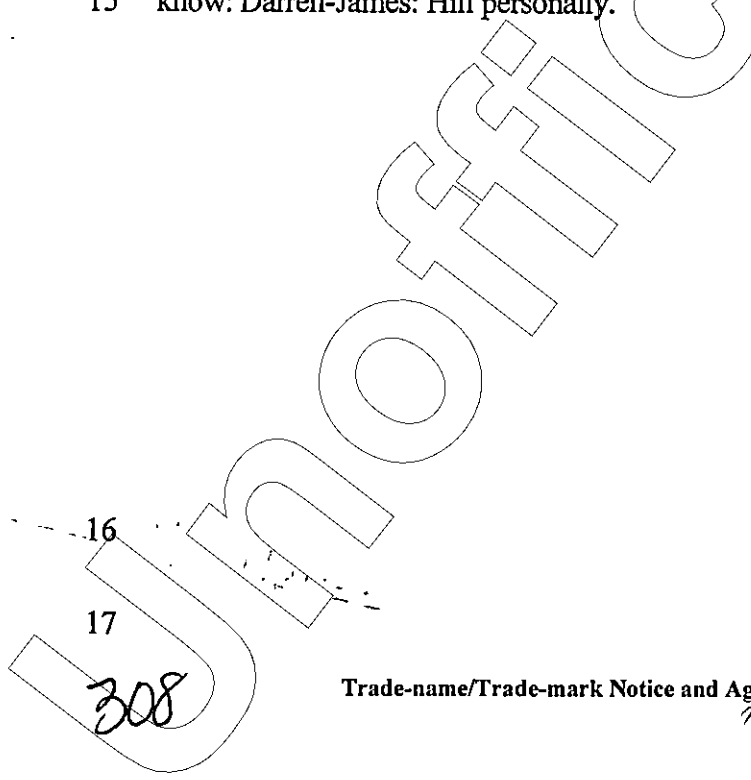

16
17
308

**Trade-name and Trade-mark
Notice and Agreement
DJH001-TN 06252015-TN CE**

[INTENTIONALLY LEFT BLANK]

1

2022-011769 MISC Page: 308 of 2782
09/26/2022 03:35:37 PM Receipt #: 22-9381
Rec. Fee: \$30.00 Darrell James Hill
Gila County, Az, Sadie Jo Bingham, Recorder



Darrell James Hill

Trade-name/Trade-mark Notice and Agreement: DJH001-TN 06252015-TN CE

10 of 10

309

Unofficial Copy



**SECURITY AGREEMENT DJH001-SA 06252015-SA CE
Non-Negotiable – Private Agreement Between two Parties**

ENCLOSURE-4
HOLD-HARMLESS AND INDEMNITY AGREEMENT: DJH001-HHIA

Unofficial Copy

310

2022-011769 MISC Page: 309 of 2782
 09/26/2022 03:35:37 PM Receipt #: 22-9381
 Rec Fee: \$30.00 Darrell James Hill
 Gila County, Az, Sadie Jo Bingham, Recorder

SECURITY AGREEMENT DJH001-SA 06252015-SA CE
Non-Negotiable – Private Agreement Between two Parties

Unofficial Copy

INTENTIONALLY LEFT BLANK

2022-011769 MISC Page: 310 of 2782
09/26/2022 03:35:37 PM Receipt #: 22-9381
Rec Fee: \$30.00 Darrell James Hill
Gila County, Az, Sadie Jo Bingham, Recorder



Darrell James Hill



311

HOLD HARMLESS AND INDEMNITY AGREEMENT

DJH001-HHIA 06252015-HHIA CE:

Non-Negotiable – Private Between the Parties:



L.S. DARRELL JAMES HILL

L.S. Darrell-James: Hill

DEBTOR:

DARRELL JAMES HILL
C/O 5124 East 18th Avenue
Apache Junction, Arizona 85119

CREDITOR:

Darrell-James: Hill
C/O General Delivery
Apache Junction MPO
Apache Junction, Arizona [851209998]

This: Agreement is a mutually agreed upon and entered into contract on this 06252015-HHIA CE between: DARRELL JAMES HILL, and the any of the all of the linear derivatives and variations in the spelling of the said name except "Darrell-James: Hill", hereinafter jointly and severally "DEBTOR", and between that of the living, natural man; to wit: biological and spiritual being living on the ground: Darrell-James: Hill, hereinafter: "CREDITOR", or "SECURED PARTY".

For: valuable consideration: DEBTOR, with the benefit of the contemplation, and with a single purpose, herein expressly agrees, covenants, and undertakes the absolute indemnification of the CREDITOR; to wit: DEBTOR holds harmless: CREDITOR unto the complete and absolute indemnification of the CREDITOR from and against the all of the any of the claims, legal actions, orders, warrants, judgments, demands, liabilities, losses, depositions, summonses, lawsuits, costs, fines, liens, levies, penalties, damages, interests, and expenses whatsoever, both absolute and contingent, as are due and as might become due, now existing and as might hereafter arise, and as might be suffered by, incurred by, and imposed upon the DEBTOR for the any of a reason, purpose or cause whatsoever: DEBTOR does hereby determine and herewith expressly commit to the covenant that: CREDITOR shall henceforth not be presumed or considered that of the accommodation party for or surety for the DEBTOR: DARRELL JAMES HILL, or the any of the all of the linear derivatives and variations in the spelling of the said name.

Terms Defined: Glossary of Terms. As used in this Hold Harmless and Indemnity Agreement, the following words and terms are as defined in the **Terms Defined** section of the **Security Agreement** DJH001-SA 06252015 CE, non obstante.

For the Babel Communications: The content of this document is written nunc pro tunc in the babel language communication style common on the day of this document, as distinguished against Complete-Sentence-Sense-Parse-Syntax-Grammar, "CSSPSG" context communication.

2022-011769 MISC Page: 311 of 2782

09/26/2022 03:35:37 PM Receipt #: 22-9381

Rec Fee: \$30.00 Darrell James Hill
Gila County, Az, Sadie Jo Bingham, Recorder

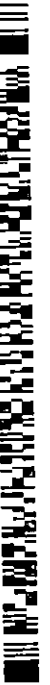

312

HOLD HARMLESS AND INDEMNITY AGREEMENT
DJH001-HHIA 06252015-HHIA CE:
Non-Negotiable – Private Between the Parties:

[INTENTIONALLY LEFT BLANK]

2022-011769 MISC Page: 312 of 2782
09/26/2022 03:35:37 PM Receipt #: 22-9381
Rec Fee: \$30.00 Darrell James Hill
Gila County, Az, Sadie Jo Bingham, Recorder



313

Darrell Hill



HOLD HARMLESS AND INDEMNITY AGREEMENT
DJH001-HHIA 06252015-HHIA CE:
Non-Negotiable – Private Between the Parties:

Any translation and/or interpretation shall be contextually construed in accordance with the meaning intended by the writer.

This: Hold-harmless and Indemnity Agreement: DJH001-HHIA 06252015-HHIA CE

DEBTOR: Transmitting Utility,

DARRELL JAMES HILL

DARRELL JAMES HILL

STATE OF ARIZONA

COUNTY OF MARICOPA

ON this 28th day of June, 2015 A.D., by me, a notary public in and for the said STATE OF ARIZONA, residing therein, duly commissioned and sworn, personally appeared DARRELL JAMES HILL, satisfactorily proved to me upon the presentation of sufficient documentation to be the person described in and who executed the within instrument. Witness my hand and seal this

28th day of JUNE, 2015.



KALLE KIVINEN
Notary Public - Arizona
Maricopa County
Expires on 08/15/2016

Notary: 

My Commission Expires 8-15-2016

314
Unofficial

Hold Harmless and Indemnity //

2022-011769 MISC Page: 313 of 2782

09/26/2022 03:35:37 PM Receipt #: 22-9381

Rec Fee: \$30.00 Darrell James Hill

Gila County, Az, Sadie Jo Bingham, Recorder



HOLD HARMLESS AND INDEMNITY AGREEMENT
DJH001-HHIA 06252015-HHIA CE:
Non-Negotiable – Private Between the Parties:

[INTENTIONALLY LEFT BLANK]

2022-011769 MISC Page: 314 of 2782

09/26/2022 03:35:37 PM Receipt #: 22-9881

Rec Fee: \$30.00 Darrell James Hill
Gila County, AZ, Sadie Jo Bingham, Recorder



Darrell

315

Unofficial Copy

HOLD HARMLESS AND INDEMNITY AGREEMENT
DJH001-HHIA 06252015-HHIA CE:
Non-Negotiable – Private Between the Parties:



Acceptance By The Secured Party:

Entitlement Holder or SECURED PARTY accepts: DEBTOR's signature in accordance with the UCC §§ 1-201(37) (2001 CE), 3-401 (2002 CE), and accepts for the value to this Security Agreement and any: DEBTOR's herein-above- described/ itemized Collateral.

(SECURED PARTY's Signature)

Without prejudice: UCC 1-308

Darrell James Hill
SECURED PARTY:

Arizona state territory:

Witness of Signor:

I, man upon the ground, a sojourner in the Arizona state territory beyond the sea on this 28 day of the June month in the year anno domini two thousand fifteen, am. And, after the witnessing of the Darrell-James: Hill's applying his signature onto this document, I affirm same by my signature to the fact that: 1) I witnessed: Darrell-James: Hill applying his signature to the document; and, 2) I know: Darrell-James: Hill personally.

Witness: [Signature] date 6.28.15
Witness: [Signature] date 6/28/2015
Witness: [Signature] date 6/28/15

L.S. DARRELL JAMES HILL

L.S. Darrell-James: Hill

Hold Harmless and Indemnity Agr

2022-011769 MISC Page: 315 of 2782
09/26/2022 03:35:37 PM Receipt #: 22-9381
Rec Fee: \$30.00 Darrell James Hill
Gila County, Az, Sadie Jo Bingham, Recorder



Unofficial
316

HOLD HARMLESS AND INDEMNITY AGREEMENT
DJH001-HHIA 06252015-HHIA CE:
Non-Negotiable – Private Between the Parties:

[INTENTIONALLY LEFT BLANK]

2022-011769 MISC Page: 316 of 2782
05/26/2022 03:35:37 PM Receipt #: 22-9381
Rec Fee: \$30.00 Darrell James Hill
Gila County, Az, Sadie Jo Bingham, Recorder



SECURITY AGREEMENT DJH001-SA 06252015-SA CE
Non-Negotiable – Private Agreement Between two Parties



Darrell James Hill

Copy

ENCLOSURE-5

Notarial Acknowledgment of Original CERTIFICATE OF BIRTH

Copy of CERTIFICATE OF BIRTH

Unofficial Copy

318

SECURITY AGREEMENT DJH001-SA 06252015-SA CE

61 of 68

2022-011769 MISC Page: 317 of 2782

09/26/2022 03:35:37 PM Receipt #: 22-9381

Rec Fee: \$30.00 Darrell James Hill

Gila County, Az. Sadie Jo Bingham, Recorder



SECURITY AGREEMENT DJH001-SA 06252015-SA CE
Non-Negotiable – Private Agreement Between two Parties

Unofficial Copy

INTENTIONALLY LEFT BLANK

2022-011769 MISC Page: 318 of 2782
09/26/2022 03:35:37 PM Receipt #: 22-9381
Rec Fee: \$30.00 Darrell James Hill
Gila County, Az, Sadie Jo Bingham, Recorder

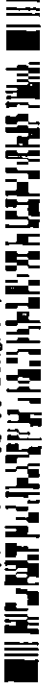

319

SECURITY AGREEMENT DJH001-SA 06252015-SA CE



62 of 68

**NOTARIAL ACKNOWLEDGMENT
OF ORIGINAL, AUTHENTIC, BIRTH CERTIFICATE**

Doc  *ES: Hill*

I HEREBY CERTIFY THIS DOCUMENT IS AN EXACT COPY OF THE RECORD ON FILE WITH THE OHIO DEPARTMENT OF HEALTH.

DE 24 08 [REDACTED]

Ruth Holecek
REGISTRAR, STATE REGISTRAR
OFFICE OF VITAL STATISTICS
DEPARTMENT OF HEALTH & SENIORS

**OHIO DEPARTMENT OF HEALTH
DIVISION OF VITAL STATISTICS
CERTIFICATE OF LIVE BIRTH**

Reg. Dist. No. [REDACTED] Primary Reg. Dist. No. [REDACTED] Registrar's No. [REDACTED] Birth No. [REDACTED]

1. PLACE OF BIRTH a. COUNTY [REDACTED] b. CITY, VILLAGE, OR LOCATION [REDACTED]

2. USUAL RESIDENCE OF MOTHER (Where does mother live?) a. STATE Ohio b. CITY, VILLAGE, OR LOCATION [REDACTED] c. STREET ADDRESS [REDACTED]

3. NAME OF HOSPITAL OR INSTITUTE (If not in hospital or institution, give street address) [REDACTED] 4. IS PLACE OF BIRTH INSIDE CITY LIMITS? YES NO

5. IS RESIDENCE INSIDE CITY LIMITS? YES NO 6. IS RESIDENCE ON A FARM? YES NO

7. NAME (Type or Print) a. CHILD: Darrell James Hill b. FATHER: [REDACTED] c. MOTHER: [REDACTED]

8. DATE OF BIRTH a. CHILD: [REDACTED] b. FATHER: [REDACTED] c. MOTHER: [REDACTED]

9. AGE (At time of this birth) a. CHILD: 35 YEARS b. FATHER: [REDACTED] c. MOTHER: [REDACTED]

10. BIRTHPLACE (State or foreign country) a. CHILD: Ala. b. FATHER: [REDACTED] c. MOTHER: [REDACTED]

11. USUAL OCCUPATION a. CHILD: [REDACTED] b. FATHER: [REDACTED] c. MOTHER: [REDACTED]

12. MAIDEN NAME (Type or Print) a. CHILD: [REDACTED] b. FATHER: [REDACTED] c. MOTHER: [REDACTED]

13. AGE (At time of this birth) a. CHILD: 30 YEARS b. FATHER: [REDACTED] c. MOTHER: [REDACTED]

14. BIRTHPLACE (State or foreign country) a. CHILD: Ala. b. FATHER: [REDACTED] c. MOTHER: [REDACTED]

15. PREVIOUS DELIVERIES TO MOTHER (NOT include this birth) a. How many OTHER children are now living? none b. How many OTHER children were born alive but are now dead? none c. How many fetal deaths (fetuses born dead at ANY time after conception)? none

16. DATE SEROLOGIC TEST FOR SYPHILIS a. CHILD: Mar 58 b. FATHER: [REDACTED] c. MOTHER: [REDACTED]

17. INFORMANT'S NAME OR SIGNATURE [REDACTED]

18. MOTHER'S MAILING ADDRESS [REDACTED]

19. DATE SIGNED [REDACTED]

20. DATE RECD. BY LOCAL REG. [REDACTED] 21. REGISTRAR'S SIGNATURE *Ruth Holecek* 22. DATE ON WHICH GIVEN NAME ADDED [REDACTED]

STATE OF ARIZONA
COUNTY OF MARICOPA

ON this 28th day of June, 2015 A.D., by me, a notary public in and for the said STATE OF ARIZONA, residing therein, duly commissioned and sworn, personally appeared and upon the presentation of sufficient documentation satisfactorily proved to me to be the person DARRELL JAMES HILL, and who provided to me a document from the STATE OF OHIO for notarial acknowledgment.

The document is on a specialty multi-colored type of safety paper with repetitive circular with center of "ODH" watermark throughout observable when held up to the light; the right upper corner area bears a depressed seal mark. Document is entitled: "OHIO DEPARTMENT OF HEALTH, DIVISION OF VITAL STATISTICS, CERTIFICATE OF LIVE BIRTH".

Document content: Left side: Reg. Dist. No. [REDACTED] below is: Primary Reg. Dist. No. [REDACTED] Right side: Registrar's No. [REDACTED] below, Birth No. [REDACTED]

Descriptive document content: 1. PLACE OF BIRTH: [REDACTED] 2. USUAL PLACE OF RESIDENCE OF MOTHER, a. STATE Ohio.... 3. CHILD: NAME; Darrell James Hill.... 7. FATHER: NAME; [REDACTED] 12. MOTHER: Maider [REDACTED] With 2 signatures below: Certification of birth statement and SIGNATURE, and a REGISTRAR'S SIGNATURE in cursive writing, "Ruth Holecek"

I acknowledge this document as authentic.

Witness my hand and seal this

28th day of JUNE, 2015.



KALLE KIVINEN
Notary Public - Arizona
Maricopa County
Expires on 08/15/2016

Notary

My Commission Expires

8-15-2016

320

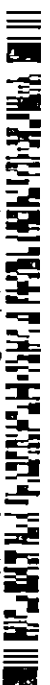

NOTARIAL ACKNOWLEDGMENT
OF ORIGINAL, AUTHENTIC, BIRTH CERTIFICATE

Copy

[REDACTED]

[REDACTED]

[INTENTIONALLY LEFT BLANK]

[REDACTED]

321

Unofficial



SECURITY AGREEMENT DJH001-SA 06252015-SA CE
Non-Negotiable – Private Agreement Between two Parties



Darrell James Hill

ENCLOSURE-6

Notarial Acknowledgment of Original ARIZONA Driver License; Number D01174172

Copy of ARIZONA Driver License; Number D01174172



Unofficial Copy

322

SECURITY AGREEMENT DJH001-SA 06252015-SA CE
Non-Negotiable – Private Agreement Between two Parties

[INTENTIONALLY LEFT BLANK]

SECURITY AGREEMENT DJH001-SA 06252015-SA CE

64 of 68



2022-011769 MISC Page: 322 of 2782
09/26/2022 03:35:37 PM Receipt #: 22-9381
Rec Fee: \$30.00 Darrell James Hill
Gila County, Az, Sadie Jo Bingham, Recorder



Unofficial Copy

323

**NOTARIAL ACKNOWLEDGMENT
OF ORIGINAL, AUTHENTIC, ARIZONA, Driver License**

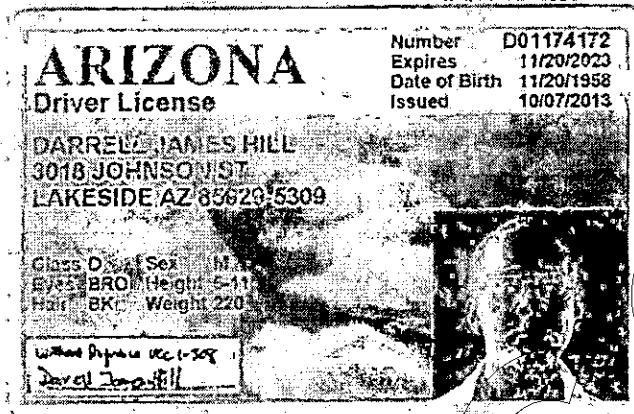

You Must Report a Change of Address Within 10 Days

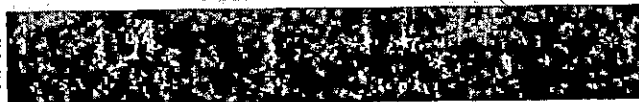

Number D01174172
Expires 11/20/2023
Issued 10/07/2013

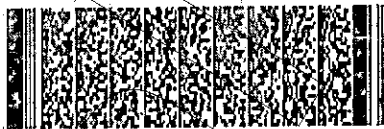

Class D Operator
Endorsements NONE
Restrictions A Corrective Lenses

**STATE OF ARIZONA
COUNTY OF MARICOPA**

ON this 28th day of June, 2015 A.D., by me, a notary public in and for the said STATE OF ARIZONA, residing therein, duly commissioned and sworn, personally appeared and upon the presentation of sufficient documentation satisfactorily proved to me to be the person DARRELL JAMES HILL, and who provided to me a document from the STATE OF ARIZONA for notarial acknowledgment.

The document is set upon a sky/mountain background picture, is entitled "ARIZONA, DRIVER LICENSE" in the upper left corner with repetitively distributed throughout the card a 'state-shaped-picture with the words "CANYON" following. The document is signed in the lower left corner, with a likeness picture of the presumed signer in the lower right corner. The picture in the right lower corner is a reasonable facsimile of Darrell-James: Hill.

The right upper corner document content information is: "Number D01174172; Expires 11/20/2023; Date of Birth 11/20/1958; Issued 10/07/2013.

The middle document content information is: "DARRELL JAMES HILL" with a following address location, below which is a description of a person, and below which is a signum in a white box at the left base of the card document.

I acknowledge this document as authentic.

Witness my hand and seal this

28th day of June, 2015.



KALLE KIVINEN
Notary Public - Arizona
Maricopa County
Expires on 08/15/2016

Notary

[Signature]

My Commission Expires

8-15-2016

324



**NOTARIAL ACKNOWLEDGMENT
OF ORIGINAL, AUTHENTIC, ARIZONA, Driver License**

[INTENTIONALLY LEFT BLANK]

325

2022-011769 MISC Page: 324 of 2782
09/26/2022 03:35:37 PM Receipt #: 22-9381
Rec Fee: \$30.00 Darrell James Hill
Gila County, Az, Sadie Jo Bingham, Recorder





SECURITY AGREEMENT DJH001-SA 06252015-SA CE
Non-Negotiable – Private Agreement Between two Parties

For the Babel Communications: The content of this document is written nunc pro tunc in the babel language communication style common on the day of this document, as distinguished against Complete-Sentence-Sense-Parse-Syntax-Grammar, "CSSPSG" context communication. Any translation and/or interpretation shall be contextually construed in accordance with the meaning intended by the writer.

This: Security Agreement DJH001-SA 06252015-SA CE:
Debtor: Transmitting Utility

DARRELL JAMES HILL
DARRELL JAMES HILL

STATE OF ARIZONA

COUNTY OF MARICOPA

ON this 28th day of June, 2015 A.D., by me, a notary public in and for the said STATE OF ARIZONA, residing therein, duly commissioned and sworn, personally appeared DARRELL JAMES HILL, satisfactorily proved to me upon the presentation of sufficient documentation to be the person described in and who executed the within instrument. Witness my hand and seal this

28th day of June, 2015.



KALLE KIVINEN
Notary Public - Arizona
Maricopa County
Expires on 08/15/2016

Notary 

My Commission Expires 8-15-2016

SECURITY AGREEMENT DJH001-SA 06252015-SA CE

65 of 68

2022-011769 MISC Page: 325 of 2782
09/26/2022 03:35:37 PM Receipt #: 22-9381
Rec Fee: \$30.00 Darrell James Hill
Gila County, Az, Sadie Jo Bingham, Recorder



326
Unofficial Copy

SECURITY AGREEMENT DJH001-SA 06252015-SA CE
Non-Negotiable -- Private Agreement Between two Parties

INTENTIONALLY LEFT BLANK



66 of 68

SECURITY AGREEMENT DJH001-SA 06252015-SA CE

2022-011769 MISC Page: 326 of 2782
09/26/2022 03:35:37 PM Receipt #: 22-9381
Rec Fee: \$30.00 Darrell James Hill
Gila County, Az, Sadie Jo Bingham, Recorder



327

Unofficial Copy



Darrell

**SECURITY AGREEMENT DJH001-SA 06252015-SA CE
Non-Negotiable – Private Agreement Between two Parties**

:Acceptance By The Secured Party:

Entitlement Holder or SECURED PARTY accepts: DEBTOR's signature in accordance with the UCC §§ 1-201(37) (2001 CE), 3-401 (2002 CE), and accepts for the value to this Security Agreement and any: DEBTOR's herein-above- described/ itemized Collateral.

(SECURED PARTY's Signature)

Without prejudice: UCC 1-308

Darrell-James: Hill

SECURED PARTY:

Arizona state territory:

Witness of Signor:

I, man upon the ground, a sojourner in the Arizona state territory beyond the sea on this 28 day of the June month in the year anno domini two thousand fifteen, am. And, after the witnessing of the Darrell-James: Hill's applying his signature onto this document, I affirm same by my signature to the fact that: 1) I witnessed: Darrell-James: Hill applying his signature to the document; and, 2) I know: Darrell-James: Hill personally.

Witness: Jay Lopez date 6-28-15

Witness: Jeffrey Paul date 6/28/2015

Witness: Virginia L. Green date 6/28/15

DARRELL JAMES

L.S. Darrell-James: Hill **HILL**

L.S. Darrell - James: Hill



Unofficial Copy

328

SECURITY AGREEMENT DJH001-SA 06252015-SA CE
Non-Negotiable – Private Agreement Between two Parties

INTENTIONALLY LEFT BLANK



SECURITY AGREEMENT DJH001-SA 06252015-SA CE

68 of 68

2022-011769 MISC Page: 328 of 2782
09/25/2022 03:35:37 PM Receipt #: 22-9381
Rec Fee: \$30.00 Darrell James Hill
Gila County, Az, Sadie Jo Bingham, Recorder



329

Unofficial Copy



*Commonwealth of Puerto Rico
Department of State
San Juan, Puerto Rico*

Beverly Jean Romero-Hill
5124 East 18th Avenue
Apache Junction, Arizona 85119

Dear Beverly Jean Romero-Hill:

Reference is made, to the UCC Financing Statement that you sent on June 30, 2015 to be filed at the Commercial Transaction Registry of the Department State of Puerto Rico. We are rejecting the document because we don't have jurisdiction over the subject matter.

Also, our statute says that: the debtor means the person who owes payment or other performance of the obligation secured, and the secured party means a lender, seller or other person in whose favor there is a security interest. In this context they must be different persons.

Enclosed is the money order for \$25.00 with serial number [REDACTED]

Cordially,

Francisco J. Rodriguez Bernier
Assistant Secretary of State for Services
Commercial Transactions Registry

2022-011769 MISC Page: 329 of 2782
09/26/2022 03:35:37 PM Receipt #: 22-9381
Rec Fee: \$30.00 Darrell James Hill
Gila County, Az, Sadie Jo Bingham, Recorder



330



PUERTO RICO: FINANCING STATEMENT: UCC1PR, ITEM 17: BJR001-SA

Registered Mail
RE 006 875 501 U.S

Darrell James Hill

ITEM 17: Exhibit A: Security Agreement BJR001-SA

Unofficial Copy

331

ITEM 17 - BJR001-SA

2022-011769 MISC Page: 330 of 2782
09/26/2022 03:35:37 PM Receipt #: 22-9381
Rec Fee: \$30.00 Darrell James Hill
Gila County, Az, Sadie Jo Bingham, Recorder



[INTENTIONALLY LEFT BLANK]

RECEIVED
D. MORALES



332

EM 17: BJR001-SA

2022-011769 MISC Page: 331 of 2782
09/26/2022 03:35:37 PM Receipt #: 22-9381
Rec Fee: \$30.00 Darrell James Hill
Gila County, Az, Sadie Jo Bingham, Recorder





Registered mail # RE006815501 US
mto 22715962558



DECLARACIÓN DE FINANCIAMIENTO / FINANCING STATEMENT
SIGA INSTRUCCIONES / FOLLOW INSTRUCTIONS
PUERTO RICO FINANCING STATEMENT: UCC1PR, ITEM 17

A. NOMBRE Y NÚMERO DE CONTACTO (opcional) / NAME & PHONE OF CONTACT AT FILER (optional)
BJR

B. CORREO ELECTRÓNICO DE CONTACTO (opcional) / E-MAIL CONTACT AT FILER (optional)

C. ENVIAR CONFIRMACIÓN A (Nombre y Dirección): / SEND ACKNOWLEDGMENT TO: (Name and Address)

BEVERLY JEAN ROMERO- HILL
5124 EAST 18TH AVENUE
APACHE JUNCTION, ARIZONA 85119

EL ESPACIO ARRIBA ES PARA USO DEL OFICIAL DE REGISTRO
THE ABOVE SPACE IS FOR FILING OFFICE USE ONLY

1. NOMBRE DEL DEUDOR / DEBTOR'S NAME: Provea sólo un nombre de Deudor (1a o 1b) (use el nombre completo y exacto, no omita, modifique o abrevie ninguna parte del nombre); si algún aparte del nombre del Deudor no cabe en la línea 1b, déjela en blanco, marque aquí y provea la información del Deudor individual en el renglón 10 del Anejo a la Declaración de Financiamiento (Forma UCC1AdPR) / Provide only one Debtor name (1a or 1b) (use exact, full name; do not omit, modify, or abbreviate any part of the Debtor's name); if any part of the Individual Debtor's name will not fit in line 1b, leave all of item 1 blank, check here and provide the Individual Debtor information in item 10 of the Financing Statement Addendum (Form UCC1AdPR)

1a. NOMBRE DE LA ENTIDAD / ORGANIZATION'S NAME
BEVERLY JEAN ROMERO- HILL

OR

1b. APELLIDO / INDIVIDUAL'S SURNAME
--

NOMBRE / FIRST PERSONAL NAME
--

SEGUNDO NOMBRE / ADDITIONAL NAME
--

SUFIJO / SUFFIX
--

1c. DIRECCIÓN POSTAL / MAILING ADDRESS
5124 EAST 18TH AVENUE

CIUDAD / CITY
APACHE JUNCTION

ESTADO STATE
AZ

CÓDIGO POSTAL / POSTAL CODE
85119

PAÍS COUNTRY
USA

2. NOMBRE DEL DEUDOR/ DEBTOR'S NAME: Provea sólo un Deudor adicional (2a o 2b) (Use el nombre completo y exacto; no omita, modifique o abrevie ninguna parte del nombre). Si cualquier parte de un nombre no cupiera en el espacio provisto en la 2b, deje toda la sección 2 en blanco, marque aquí y provea el nombre completo en el renglón 10 en el Anejo de la Declaración de Financiamiento (Forma UCC1AdPR) / Provide only one Debtor name (2a or 2b) (use exact, full name; do not omit, modify, or abbreviate any part of the Debtor's name); if any part of the Individual Debtor's name will not fit in line 2b, leave all of item 2 blank, check here and provide the Individual Debtor information in item 10 of the Financing Statement Addendum (Form UCC1AdPR)

2a. NOMBRE DE LA ENTIDAD / ORGANIZATION'S NAME
--

OR

2b. APELLIDO / INDIVIDUAL'S SURNAME
--

NOMBRE / FIRST PERSONAL NAME
--

SEGUNDO NOMBRE / ADDITIONAL NAME
--

SUFIJO / SUFFIX
--

2c. DIRECCIÓN / MAILING ADDRESS
--

CIUDAD / CITY
--

ESTADO STATE
--

CÓDIGO POSTAL / POSTAL CODE
--

PAÍS COUNTRY
--

3. NOMBRE DEL ACREEDOR GARANTIZADO (o NOMBRE DE CESIONARIO): Provea solo un nombre de Acreedor Garantizado (3a o 3b)
SECURED PARTY'S NAME (or NAME of ASSIGNEE): Provide only one Secured Party name (3a or 3b)

3a. NOMBRE DE LA ENTIDAD / ORGANIZATION'S NAME
--

OR

3b. APELLIDO / INDIVIDUAL'S SURNAME
Romero- Hill

NOMBRE / FIRST PERSONAL NAME
Beverly

SEGUNDO NOMBRE / ADDITIONAL NAME
Jean

SUFIJO / SUFFIX
--

3c. DIRECCIÓN POSTAL / MAILING ADDRESS
c/o 5124 East 18th Avenue

CIUDAD / CITY
Apache Junction

ESTADO STATE
Ariz

CÓDIGO POSTAL / POSTAL CODE
--

PAÍS COUNTRY
USofA

4. COLATERAL: Esta declaración de financiamiento cubre la siguiente colateral: / COLLATERAL: This financing statement covers the following collateral:

For the Security "trust" Agreement covers: A) all of the hereditary and principal collateral inherent in the "BEVERLY JEAN ROMERO- HILL", CERTIFICATE OF LIVE BIRTH, STATE OF NEW MEXICO... engendered TRUST substantiated to the Principal and beneficiary upon the Birth, et seq., inclusive of all assets and debts that have been, exist now and that will be; and: B) all of the identification and agreement of the parties, of the parties' functional and binding contracts, of the rights of the use of the trade name and trademark, and of the quality and extent of the indemnification of the secured party by the debtor. See Item 17: Exhibit A: Security Agreement BJR001-SA....

5. Marque solo si aplica y solo una opción: Colateral está en posesión de un Fideicomiso (véase UCC1AdPR, renglón 7 e instrucciones) administrado por Representante de un difunto held in a Trust (See UCC1AdPR, Item 17 and instructions) being administered by a Decedent's Personal Representative

6a. Marque solo si aplica y una sola alternativa / Check only if applicable and check only one box:

Transacción de Financiamiento Público / Public-Finance Transaction Transacción de Casa Prefabricada / Manufactured-Home Transaction Un Deudor es una entidad transmisora / A Debtor is a Transmitting Utility

6b. Marque solo si aplica y solo una alternativa / Check only if applicable and check only one box:

Gravamen Agrícola / Agricultural Lien Inscripción extraregistrada / Non-UCC Filing

7. DESIGNACIÓN ALTERNA (si aplica) / ALTERNATIVE DESIGNATION (if applicable): Arrendador/Arrendatario / Lessee/Lessor Consignatario/ Consignador / Consignee/Consignor Vendedor/ Comprador / Seller/Buyer Depositario/ Fiador / Bailee/Bailor Concesionario/Concedente / Licensee/Licensor

8. DATOS OPCIONALES DE REFERENCIA PARA EL SOLICITANTE / OPTIONAL FILER REFERENCE DATA: Sent "3" ORIGINALS copies of the filing enclosed: please return 2 "Received" ORIGINALS copy in the SAE provided.

C OPIA OFICINA DE REGISTRO—DECLARACIÓN DE FINANCIAMIENTO (Forma UCC1PR) (Rev. 05/09/14)



Unofficial Copy

[INTENTIONALLY LEFT BLANK]

335

2022-011769 MISC Page: 333 of 2782
09/26/2022 03:35:37 PM Receipt #: 22-9381
Rec Fee: \$30.00 Darrell James Hill
Gila County, Az, Sadie Jo Bingham, Recorder



Sadie Jo Bingham



**SECURITY AGREEMENT BJR001-SA 06252015-SA CE
Non-Negotiable – Private Agreement Between two Parties**

L.S. BEVERLY JEAN ROMERO HILL

L.S. Beverly Jean Romero Hill

DEBTOR:

BEVERLY JEAN ROMERO- HILL

C/O 5124 East 18th Avenue
Apache Junction, Arizona 85119

CREDITOR:

Beverly-Jean: Romero- Hill

C/O General Delivery
Apache Junction MPO
Apache Junction, Arizona [851209998]

This Security Agreement:

This Security Agreement is in regard to the mutually agreed upon and entered into contract BJR001-SA 06252015-SA CE between: A) commercial person BEVERLY JEAN ROMERO-HILL, also known by the any and all of the linear derivatives and variations in the spelling of the said name except: "Beverly-Jean: Romero- Hill," hereinafter jointly and severally "DEBTOR," and: B) real man, sui juris, living sentient beyond the sea, to-wit: natural, biological, spiritual, and soulful man-creation of the Almighty God, to wit: "Beverly-Jean: Romero- Hill", hereinafter the "SECURED PARTY." See Political Status Election: BJR001-POLE, ENCLOSURE-1. See Private Agreement, Non-negotiable – Private Between the Parties: BJR001-PA, ENCLOSURE-2. **For the value of the consideration: Controlling Creditor or Entitlement Holder: BEVERLY JEAN ROMERO- HILL: - See Trade-name and Trade-mark, Notice and Agreement, TN BJR001-TN. See BJR001-TN, ENCLOSURE-3.**

- a) Assigns to the Beverly-Jean: Romero- Hill all of the security interests in all of the Collateral, not limited by the items described herein below, for the purpose of the securing all of the interests and all of the right(s) in all of the forms whatsoever. See HOLD-HARMLESS AND INDEMNITY AGREEMENT: BJR001-HHIA, ENCLOSURE-4;
- b) Transfers all of the collateral along with all of the controlling creditor or Security Entitlement or transfer or assignment or attachment or perfection right(s), not limited by the any of the Security Entitlements, unto and into the possession and control of the SECURED PARTY;
- c) Agrees with the having: DEBTOR's name entered and registered in the records of the Uniform Commercial Code, hereinafter "UCC", filing office as a transmitting utility;
- d) Agrees that: Beverly-Jean: Romero- Hill hereafter possesses all of the collateral along with all of the controlling creditor or Security Entitlement or transfer or assignment or attachment or perfection right(s) stated in this Security Agreement in regards to the any of the Collateral, as well as all of the right(s) in the any of the present and future forms whatsoever.



Handwritten initials/signature in the bottom left corner.

SECURITY AGREEMENT BJR001-SA 06252015-SA CE
Non-Negotiable – Private Agreement Between two Parties

[INTENTIONALLY LEFT BLANK]

337
~~33079~~

SECURITY AGREEMENT BJR001-SA 06252015-SA CE



2 of 68

2022-011769 MISC Page: 335 of 2782
09/26/2022 03:35:37 PM Receipt #: 22-9381
Rec Fee: \$30.00 Darrell James Hill
Gila County, Az, Sadie Jo Bingham, Recorder





SECURITY AGREEMENT BJR001-SA 06252015-SA CE
Non-Negotiable – Private Agreement Between two Parties

This: Security Agreement affirms:

- a) Performance of the obligations owed by the DEBTOR in the favor of the SECURED PARTY are as is set forth in this express written Agreement: value considerations of the said obligation(s) of the any specific property or collateral items identified herein, or of the any inquiries thereto: one may consult with the Secured Party;
- b) Repayment of the any of the amounts that: SECURED PARTY may advance, spend, and otherwise convey for the maintenance, preservation, upkeep, and of the like of the Collateral, and, for the any other expenditures that: SECURED PARTY may make under the provisions of this Security Agreement in the particular and for the general benefit of the DEBTOR;
- c) Payment of the any of the amounts owed now or in the future by the DEBTOR for the benefit of the SECURED PARTY;
- d) Payment of the indebtedness or liabilities owed by the DEBTOR in the favor of the SECURED PARTY, both of the direct or indirect, absolute or contingent, due or as might become due, now existing or hereafter arising, or however evidenced;
- e) Other of the debts that may be owed by the DEBTOR for the benefit of the SECURED PARTY upon the occasion as stated herein;
- f) Any of the amounts owed under any of the modifications, renewals, and extensions of the any of the foregoing obligations.

Thus: DEBTOR transfers all of the controlling creditor or Entitlement right(s) or transfer or assignment or attachment or perfection right(s) or issuances or property or collateral or possessions or right(s) to the Beverly-Jean: Romero- Hill. Therefore: any of the herein stated controlling creditor or Security Entitlement or transfer or assignment or attachment or perfection right(s) or issuances or property or collateral or possessions or right(s) shall remain transferred to the Beverly-Jean: Romero- Hill until: Security Agreement is terminated in the writing, signing and filing by the both: DEBTOR and SECURED PARTY, as herein-stated.

NOTICE AND WARNING:

Any commercial person, as well as the any of the agents of the said commercial person, agrees that neither by the said commercial person, nor by the agent of the said commercial person, shall there be display or use in the any manner of the trade-name/trade-mark, common-law trade-name/trade-mark described herein, to wit: BEVERLY JEAN ROMERO- HILL, or the any variation thereof, or the any derivative of said name, without prior, express, written consent of Controlling Creditor or Entitlement Holder or Claimant or SECURED PARTY, as signified by the SECURED PARTY's signature in a red ink. Per by both vehicles: use of the published Trade-name/ Trade-mark Notice attached hereto or of the NOTICE AND WARNING herein: BEVERLY JEAN ROMERO- HILL use by any commercial person or person, or by the any agent of said commercial person, or person, hereinafter jointly and severally "User," constitutes sure consent and concomitant agreement that the any use of the BEVERLY JEAN ROMERO- HILL other than by an authorized use as set forth



338
~~338~~

**SECURITY AGREEMENT BJR001-SA 06252015-SA CE
Non-Negotiable – Private Agreement Between two Parties**

[INTENTIONALLY LEFT BLANK]

SECURITY AGREEMENT BJR001-SA 06252015-SA CE

4 of 68

2022-011769 MISC Page: 337 of 2782
09/26/2022 03:35:37 PM Receipt #: 22-9381
Rec Fee: \$30.00 Darrell James Hill
Gila County, Az, Sadie Jo Bingham, Recorder



Handwritten scribbles and the number 339.

Handwritten signature: B. B. Bingham

Large diagonal watermark: Unofficial Copy

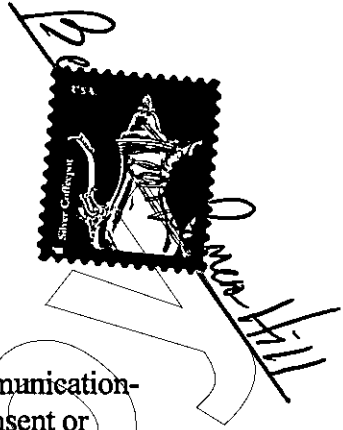

**SECURITY AGREEMENT BJR001-SA 06252015-SA CE
Non-Negotiable – Private Agreement Between two Parties**

herein, or following by the Beverly-Jean: Romero- Hill's NOTICE -by a written communication- /SECURITY AGREEMENT, demonstrates: User's tacit and indirect agreement or consent or confession to giving to the SECURED PARTY authority by tacit procuracy for the impending non-judicial forum judgment against User for any unauthorized use of the said trade-name/trade-mark, and, to wit, that such actions did contractually bind to the User, and signifies that: User:

- 1) grants to the SECURED PARTY a security interest in, and a distress warrant or lien against: User's property and interest in the property in the sum certain amount: Five Hundred thousand and no/100 dollars: 500,000.00 USD, or: equivalent currency to which the Secured Party may prefer to agree to the receipt, per the each trade-name/trade-mark used, per the each occurrence of a use, plus for the costs, plus for the triple damages, as well as for the each and every use of the any linear derivatives or variations in the spelling of the BEVERLY JEAN ROMERO- HILL;
- 2) authenticates in the support of the any Security Agreement wherein the User is: DEBTOR, and Beverly-Jean: Romero- Hill is: SECURED PARTY, and: User pledges any of the User's property or interest in the any property as collateral for securing any of the User's contractual obligation(s);
- 3) authenticates in the support of the any of the UCC Financing Statement(s) wherein: User is DEBTOR, and: Beverly-Jean: Romero- Hill is SECURED PARTY;
- 4) consents and agrees that the said Financing Statement(s) filed is unto the continuing financing status that the User authorizes, authorizing: SECURED PARTY's filing of any initial and continuation statement(s) as necessary for the maintaining of the SECURED PARTY's attachment or perfected security interest(s) in the any of the User's property or of the right(s) in any of the property(s) pledged into the collateral in the this Security Agreement until: User's contractual obligation is fully satisfied;
- 5) authorizes to the filing of the aforementioned UCC Financing Statement or Security Agreement in the UCC filing office by the SECURED PARTY;
- 6) consents and agrees that any such filings referenced in the paragraph "5)" above are not or may not be considered to be false, and that: User waives all of the claim(s) against the any of such filing(s);
- 7) waives any of the defense(s);
- 8) consents and agrees that: User will execute any of the further documents and take any of the



Handwritten scribbles and the number 348.

SECURITY AGREEMENT BJR001-SA 06252015-SA CE
Non-Negotiable – Private Agreement Between two Parties

[INTENTIONALLY LEFT BLANK]

Rec'd
11/19/22



SECURITY AGREEMENT BJR001-SA 06252015-SA CE

6 of 68

2022-011769 MISC Page: 339 of 2782
09/26/2022 03:35:37 PM Receipt #: 22-9381
Rec Fee: \$30.00 Darrell James Hill
Gila County, Az, Sadie Jo Bingham, Recorder



3/11
146



**SECURITY AGREEMENT BJR001-SA 06252015-SA CE
Non-Negotiable – Private Agreement Between two Parties**

further actions as requested by the SECURED PARTY that augment any of the following:

- a) evidencing of the security interest granted herein;
- b) perfecting of the security interest granted herein;
- c) maintaining of the first priority of the security interest granted herein;
- d) effectuating of the right(s) herein granted to the SECURED PARTY by the User.

Further: User also consents and agrees in the any of the Payment Terms, Default Terms, Terms for Curing Default, and Terms of Strict Foreclosure as set forth in the particularity in the NOTICE-by written communication- /SECURITY AGREEMENT or in the attached herein published: Trade-name/Trade-mark Notice – BJR001-TN. See BJR001-TN, ENCLOSURE-3.

Words Defined; Glossary of Terms. As used in this Security Agreement, the following words and terms are as defined in this section, non obstante:

“All” means: everything that is, or of that one has or may have: whole number; totality, including without a restriction.

“Almighty God” means: He who exists before all that universally is began; the Father of the Lord God Yushua, the only begotten Son (Creator of all that universally is and the Lord God of of the patriarchs: Abraham, Isaac and Jacob); the Divine Father adoptive to the SECURED PARTY as a result of the sacrifice made by His only begotten Son Yushua for all grace; the Divine Father which Nothing comes between Him and the SECURED PARTY.

“Artificial Person” means: commercial person: DEBTOR or BEVERLY JEAN ROMERO-HILL, also known by any and all of the linear derivatives and variations in the spelling of the said name except "Beverly-Jean: Romero- Hill."

“Authorized Representative” or “A.R.” or “AR” means: Beverly-Jean: Romero- Hill, authorized by the DEBTOR for a signum of the DEBTOR's signature.

“Beneficial interest” means: beneficiary's profit, benefit, or advantage resulting from a contract, or from the ownership of an estate(s) or trust(s) as distinct from the legal ownership or control of the said estate or trust.

“Beneficiary” means: One for whose benefit that of a trust is created: a cestui que trust.

“Beyond the sea” means: beyond all of the limits-of/ outside of the UNITED STATES - to wit: territory over the which does not extend any of the sovereignty of the UNITED STATES government; such as, Not of a United States' territory, Citizen, person or commercial holding idea, etc., and of the like, as opposed to that of a natural person or de jure Citizen under the Sovereign Almighty God as covenanted by the people of the united States for the same under:

Handwritten signature and number 342



SECURITY AGREEMENT BJR001-SA 06252015-SA CE
Non-Negotiable – Private Agreement Between two Parties

[INTENTIONALLY LEFT BLANK]

[Handwritten signature]

[Handwritten signature]

SECURITY AGREEMENT BJR001-SA 06252015-SA CE

8 of 68

2022-011769 MISC Page: 341 of 2782
09/26/2022 03:35:37 PM Receipt #: 22-9381
Rec Fee: \$30.00 Darrell James Hill
Gila County, Az, Sadie Jo Bingham, Recorder



[Handwritten signature]
343

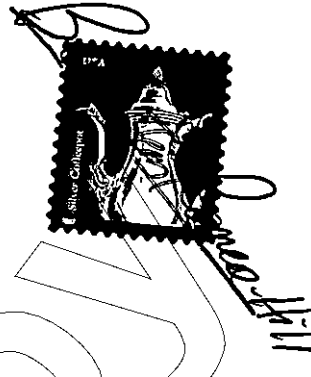

**SECURITY AGREEMENT BJR001-SA 06252015-SA CE
Non-Negotiable – Private Agreement Between two Parties**

The Constitution for the united States of America- 1787 CE.

“CE” means: common era or christian era or current era as regarding the year date accounting concurrently synonymous with “AD”- to wit: anno domini.

“Claim” means, noun: 1) right or title to a privilege, or of another thing in the possession of another; not strictly that of the possession, but by the means by which the claimant attains to the possession or enjoyment of the said possession; 2) right of the payment, when such of a right is rendered into the form of a judgment, or for the damages, as well as of under the rulings in regards to that of an equitable remedy for the breach of a performance, when such of a breach results in a right of the payment, or of when that of an equitable remedy is rendered in the form of a judgment in regards to the payment of some debt or obligation. Verb: demand as of one’s own, asserted as of one’s personal right to the any properties or right of a possession or of the enjoyment of a something considered rightfully of one’s own, and wrongfully withheld.

“Conduit” means: transmitting utility distributing energy and effects in the commerce, such as of the goods and services, via the name BEVERLY JEAN ROMERO- HILL and of the any linear derivatives and variations in the spelling of said name of the DEBTOR except "Beverly-Jean: Romero- Hill.”

“Collateral” means: property and property right(s) of the DEBTOR, now owned and hereafter acquired, now existing and hereafter arising, and wherever located, with such of an ownership either in the name of the DEBTOR or in the name of another, in which: DEBTOR holds of a beneficial interest, and of a security for the entire obligation or of the any amount of the indebtedness.

“Commercial person” means: abstract or legal entity, ens legis, such as of a corporation, created by the construct of the law and considered as possessing certain of the legal right(s) and duties of a legal being: /an imaginary entity, such is as of the DEBTOR, to-wit: BEVERLY JEAN ROMERO- HILL, which, on the basis of the legal reasoning, is legally treated as: fictitious “person” or “being” for the purpose of conducting in a commercial activity.

“DEBTOR” means: “User” or “BEVERLY JEAN ROMERO- HILL” or by the any of the linear derivatives and variations in the spelling of the said name(s) except: "Beverly-Jean: Romero- Hill."

“Default” means: DEBTOR’s non-performance of a duty arising under this Security Agreement, specifically that of the any of the events described in the any of the three categories, to-wit: "Insolvency," "Creditor Proceedings," and "Other Defaults," set forth below under: "Events of the Default under this Security Agreement".

“Derivative” means by the way of another; taken out of a something preceding: secondary; of that which is not of the origin in and of itself, but is that of the which is obtained from the existence out of some foregoing thing and from a more primal and fundamental nature.

“Drawer” means: Beverly-Jean: Romero- Hill or BEVERLY JEAN ROMERO- HILL or the any of the linear derivatives and variations of said names in the any manner whatsoever regarding any of the assets or contracts or promissory notes or titles or grants or accounts or instruments,

Handwritten signatures and initials, including '3/13' and 'BJR'.



SECURITY AGREEMENT BJR001-SA 06252015-SA CE
Non-Negotiable – Private Agreement Between two Parties

[INTENTIONALLY LEFT BLANK]

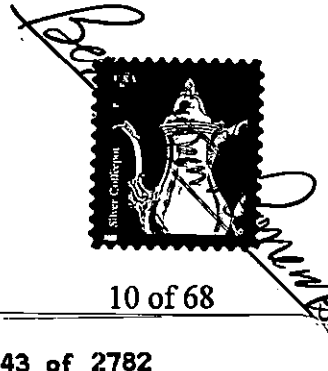

SECURITY AGREEMENT BJR001-SA 06252015-SA CE

10 of 68

2022-011769 MISC Page: 343 of 2782
09/26/2022 03:35:37 PM Receipt #: 22-9381
Rec Fee: \$30.00 Darrell James Hill
Gila County, Az, Sadie Jo Bingham, Recorder



345
~~345~~
19/11



**SECURITY AGREEMENT BJR001-SA 06252015-SA CE
Non-Negotiable – Private Agreement Between two Parties**

trusts, or agreements in the any form whatsoever bearing the name(s): Beverly-Jean: Romero-Hill or BEVERLY JEAN ROMERO- HILL or any linear derivatives and variations of the said names.

"Ens legis" means: creature of the law or of an artificial being, such as is, that of a "corporation": deriving of an existence into a being or entity fabricated entirely by the law, as contrasted with that of a natural person.

"Endorsement" means "indorsement:" act of a payee, drawee, accommodation indorser, or holder of a bill, note, check, or of an other negotiable instrument, wherein placing onto of his signum upon the back of the same, with or without further or qualifying words, that thereby: property in the same is assigned and transferred to another.

"Entitlement Holder" means: Beverly-Jean: Romero- Hill having standing in a security entitlement in the any of the security or asset or contract or promissory note or title or grant or account or instrument or agreements in the any of the forms whatsoever bearing BEVERLY JEAN ROMERO- HILL, or any linear derivatives and variations of the said name.

"Ex delicto" means ex, to wit, from/out, of a delict, to wit: tort, fault, crime, or malfeasance including same arising out of the contract or otherwise founded in the trespass, trover, or replevin.

"Ground" means: land or soil or earth above the sea, beyond the sea; to wit: dirt, the soil or the dust, to-wit: mineral composition, precursors and substance elements of the corporeal man.

"Hold-harmless and Indemnity Agreement" means: "HHIA", HOLD-HARMLESS AND INDEMNITY AGREEMENT: BJR001-HHIA, ENCLOSURE-4; as, of this HHIA, as may be amended and modified in the accordance with this contract of the parties signing hereunto, and together with any of the attachments, exhibits, documents, endorsements, and schedules in regard to this HHIA attached.

"Issuer" means: Beverly-Jean: Romero- Hill or BEVERLY JEAN ROMERO- HILL, of the maker or drawer of the any of the assets or contract or promissory note or title or grant or account or instrument or agreement in the any form whatsoever.

"Land" means: dry ground and dry earth soil whatsoever, inclusive of the pastures, fields, meadows, woods, moors, waters, marshes, rock, elements, and sand, as against that of the sea or ocean.

"Legal Entity" means: entity ens legis as against that of a natural person; Of the artificial sufficient existence in and of the legal contemplation that of the said entity may function legally or sue and be sued or make decisions through its representative(s).

"Liability" means: kind of the legal obligation, responsibility, and duty of a state of a being bound and obligated by the law for the doing or paying of a debt or fulfilling of an obligation or rendering of a committed specific performance, or the like.

"Living and breathing, flesh-and-blood man" means: SECURED PARTY, Beverly-Jean: Romero- Hill, of a biological and spiritual and soul being: natural person as against that of an artificial legal construct or ens legis- to wit, created by construct of the law.

Handwritten signature and initials, possibly 'BJP'.



SECURITY AGREEMENT BJR001-SA 06252015-SA CE
Non-Negotiable – Private Agreement Between two Parties

[INTENTIONALLY LEFT BLANK]

SECURITY AGREEMENT BJR001-SA 06252015-SA CE

12 of 68

2022-011769 MISC Page: 345 of 2782
09/26/2022 03:35:37 PM Receipt #: 22-9381
Rec Fee: \$30.00 Darrell James Hill
Gila County, Az, Sadie Jo Bingham, Recorder



~~347~~
347

Handwritten signature
Stamp: GILA COUNTY, AZ
Vertical handwritten text: MARY ANN BINGHAM

Unofficial Copy

SECURITY AGREEMENT BJR001-SA 06252015-SA CE
Non-Negotiable – Private Agreement Between two Parties



"Maker" means: (a) SECURED PARTY, or (b) DEBTOR in regards to the any of the assets or contract or promissory note or title or grant or account or instrument or agreement in-bearing the name(s) Beverly-Jean: Romero- Hill, or BEVERLY JEAN ROMERO- HILL, respectively.

"Natural person" means: sentient being living on the ground, beyond of the sea, that of a "living and breathing, flesh-and-blood man," as against that of an artificial person(s) or commercial person ens legis.

"Non obstante" means: words anciently used in the public and private instruments intended to preclude, in advance, any of the interpretations contrary to the certain declared objects or purposes.

"Private Agreement" means: "PA", in regards to the written, express Private Agreement: BJR001-PA, ENCLOSURE- 2. between: SECURED PARTY and: DEBTOR, together with the any of the modifications of and substitutions for the said Private Agreement.

"Replevin" means: personal action *ex delicto* brought for the recovery of the possession or goods unlawfully taken.

"Resources or rents or wages or salaries or any other income by any source derived" means: any resources or rents or wages or salaries or any other income by any source not limited by the past or present or future benefit of the DEBTOR.

"SECURED PARTY" means: Beverly-Jean: Romero- Hill de jure- the natural person, In: 1) Sovereign People Status of The Constitution for the united States of America-1787 CE.: 2) Political Status Election: Article of Amendment IX: 3) Non Commercial Status.

"Security" means: obligation given by a debtor in the order to make sure of the payment or performance of his debt.

"Security Agreement" means: "SA", this Security Agreement BJR001-SA, 06252015 CE, with the all of the attachments and incorporations made by the reference.

"Securities Intermediary" means: bank or broker or clearing corporation or bailee that is acting in the capacity of the maintaining of a security account for an other.

"Signature" means in the nature of, U.C.C. § 3-401 – 2002, what is considered signum, which is herein incorporated by a reference.

"Signed" means in the nature of, U.C.C. § 1-201 (37) – 2001, what is considered signum, which is herein incorporated by a reference.

"Signum" means: sign, mark, seal, or writing mad for to identify or authenticate, or to give validity of one's own act: signature.

"TRADENAME" means: commercial person "BEVERLY JEAN ROMERO- HILL", as well as the any of the linear derivatives and variations in the spelling of that said name, respectively, except "Beverly-Jean: Romero- Hill." All of the right(s) reserved regarding trade-name/trade-mark 2015 CE, et seq. - All of the right(s) reserved.

"transmitting utility" means: the stramineus homo, en legis, BEVERLY JEAN ROMERO- HILL's duty(s) in the acts for the the transmitting of letters, writings, papers, news, and the like, from one jurisdiction or nation to another; the mechanism for to communicate rights, titles, and privileges.



348

SECURITY AGREEMENT BJR001-SA 06252015-SA CE
Non-Negotiable – Private Agreement Between two Parties

[INTENTIONALLY LEFT BLANK]

SECURITY AGREEMENT BJR001-SA 06252015-SA CE

14 of 68

2022-011769 MISC Page: 347 of 2782
09/26/2022 03:35:37 PM Receipt #: 22-9381
Rec Fee: \$30.00 Darrell James Hill
Gila County, Az, Sadie Jo Bingham, Recorder

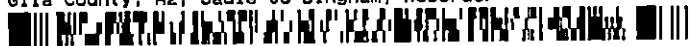

~~347~~
~~347~~
349

Handwritten signature

Unofficial Copy



**SECURITY AGREEMENT BJR001-SA 06252015-SA CE
Non-Negotiable – Private Agreement Between two Parties**

“**Truename**” means: “Beverly-Jean: Romero- Hill” de jure: is the natural person to who this SA and attachments, and as amended, and in the Confirmations of the presumption: to wit:

1) Sovereign People Status of The Constitution for the united States of America-1787 CE.: 2) Political Status Election: Article of Amendment IX: 3) Non Commercial Status refer; to wit: the natural person of soul under the Almighty God identified by the family name: “Romero”, and upon his birth, “Beverly” -second name, and “Jean” -third name: to wit: Romero Beverly-Jean: him to who the de jure confirmations- made before refer: to wit: Beverly-Jean: Romero- Hill. All of the right(s) reserved regarding the any use of the name “Beverly-Jean: Romero- Hill” signum, Common-law trade-name/trade-mark 2015 CE, et seq.- All of the right(s) reserved.

“**U.C.C. § 1-201(37) – (2001)**” means in the nature of “includes using any symbol executed or adopted with present intention to adopt or accept a writing.”

“**U.C.C. § 3-401– (2002)**” means in the nature of, “(a) A person is not liable on an instrument unless (i) the person signed the instrument, or (ii) the person is represented by an agent or representative who signed the instrument and the signature is binding on the represented person under Section 3-402. (b) A signature may be made (i) manually or by means of a device or machine, and (ii) by the use of any name, including a trade or assumed name, or by a word, mark, or symbol executed or adopted by a person with present intention to authenticate a writing.”

“**U.C.C. § 9-607– (2010)**” means in the nature of, “(a) [Collection and enforcement generally.] If so agreed, and in any event after default, a secured party: (1) may notify a debtor or other person obligated on collateral to make payment or otherwise render performance to or for the benefit of the secured party; (2) may take any proceeds to which the secured party is entitled under Section 9-315; (3) may enforce the obligations of an account debtor or other person obligated on collateral and exercise the right(s) of the debtor with respect to the obligation of the account debtor or other person obligated on collateral to make payment or otherwise render performance to the debtor, and with respect to any property that secures the obligations of the account debtor or other person obligated on the collateral; (4) if it holds a security interest in a deposit account perfected by control under Section 9-104(a)(1), may apply the balance of the deposit account to the obligation secured by the deposit account; and (5) if it holds a security interest in a account perfected by control under Section 9-104(a)(2) or (3), may instruct the bank to pay the balance of the deposit account to or for the benefit of the secured party. (b) [Nonjudicial enforcement of mortgage.] If necessary to enable a secured party to exercise under subsection (a)(3) the right of a debtor to enforce a mortgage non-judicially, the secured party may record in the office in which a record of the mortgage is recorded: (1) a copy of the security agreement that creates or provides for a security interest in the obligation secured by the mortgage; and (2) the secured party’s sworn affidavit in recordable form stating that: (A) a default has occurred with respect to the obligation secured by the mortgage; and (B) the secured party is entitled to enforce the mortgage non-judicially. (c) [Commercially reasonable collection and enforcement.] A secured party shall proceed in a commercially reasonable manner if the secured party: (1) undertakes to

Handwritten signature and the number 350.



SECURITY AGREEMENT BJR001-SA 06252015-SA CE
Non-Negotiable – Private Agreement Between two Parties

Unofficial Copy

[INTENTIONALLY LEFT BLANK]

2022-011769 MISC Page: 349 of 2782
09/26/2022 03:35:37 PM Receipt #: 22-9381
Rec Fee: \$30.00 Darrell James Hill
Gila County, Az, Sadie Jo Bingham, Recorder



16 of 68

SECURITY AGREEMENT BJR001-SA 06252015-SA CE

391

[Handwritten signature]

[Handwritten signature]

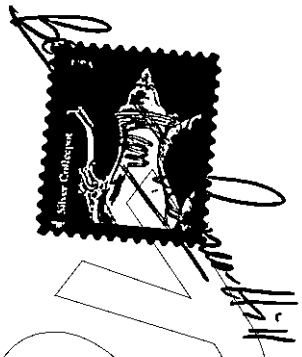

**SECURITY AGREEMENT BJR001-SA 06252015-SA CE
Non-Negotiable – Private Agreement Between two Parties**

collect from or enforce an obligation of a account debtor or other person obligated on collateral; and (2) is entitled to charge back uncollected collateral or otherwise to full or limited recourse against the debtor or a secondary obligor. (d) [Expenses of collection and enforcement.] A secured party may deduct from the collections made pursuant to subsection (c) reasonable expenses of collection and enforcement, including reasonable attorney's fees and legal expenses incurred by the secured party.”

Collateral Section:

All Property and Collateral acquired by non consensual means is replevin unto Beverly-Jean: Romero- Hill.

Collateral

Value in Security Interest

1. BEVERLY JEAN ROMERO- HILL's Entitlement or transfer or assignment of the right(s) of the trade-name(s), mark(s), and trade-mark(s) in regards to the "BEVERLY JEAN ROMERO- HILL"; and of any other of the assemblages of the letters and linear derivatives and variations in the spelling of the said name(s) used with the intent of referencing the DEBTOR, except Beverly-Jean: Romero-Hill, the SECURED PARTY;

Five Hundred Thousand and no/100 dollars: 500,000.00 USD, or: equivalent currency to which the Secured Party may prefer to agree to the receipt: per each use, per each occurrence of the unauthorized use, plus costs, plus triple damages -See "NOTICE AND WARNING" above

2. BE VERLY JEAN ROMERO- HILL's Entitlement or transfer or assignment of the right(s) of the BEVERLY JEAN ROMERO- HILL, **birth certificate description: "CERTIFICATE OF BIRTH, STATE OF NEW MEXICO, File No. [REDACTED] Request No. [REDACTED]**

Sixty-Five Million and no/100 and no/100: 65,000,000.00 USD, or: equivalent currency to which the Secured Party may prefer to agree to the receipt: per the each occurrence; plus for the triple damages

County of Birth [REDACTED]; Date of Birth [REDACTED]; Date of Registration [REDACTED]; Sex FEMALE; Name of Person Registered >>> BEVERLY JEAN ROMERO <<<; Name of Father >>> [REDACTED] <<<; Birth Name of Mother >>> [REDACTED] <<< See Notarial

Handwritten circled number 352



SECURITY AGREEMENT BJR001-SA 06252015-SA CE
Non-Negotiable – Private Agreement Between two Parties

Unofficial Copy

[INTENTIONALLY LEFT BLANK]

[Handwritten signature]
3513

SECURITY AGREEMENT BJR001-SA 06252015-SA CE

18 of 68

[Handwritten signature]
11/21/2022

2022-011769 MISC Page: 351 of 2782
09/26/2022 03:35:37 PM Receipt #: 22-6981
Rec Fee: \$30.00 Darrell James Hill
Gila County, Az, Sadie Jo Bingham, Recorder





**SECURITY AGREEMENT BJR001-SA 06252015-SA CE
Non-Negotiable – Private Agreement Between two Parties**

Acknowledgment of Original
CERTIFICATE OF BIRTH; See copy of
CERTIFICATE OF BIRTH: Enclosure -5.

3.BE VERLY JEAN ROMERO- HILL's
Entitlement or transfer or assignment of
the right(s) of the miscellaneous licenses:
ARIZONA Driver License; Number
[REDACTED] Expires 06/15/2023; Date of
Birth [REDACTED]; BEVERLY JEAN
ROMERO-HILL. See Notarial
Acknowledgment of Original ARIZONA
Driver License; Number [REDACTED]. See
copy of ARIZONA Driver License;
Number [REDACTED] Enclosure-6.

Two Hundred Thousand and no/100
dollars: 200,000.00 USD, or: equivalent
currency to which the Secured Party
may prefer to agree to the receipt

4. BEVERLY JEAN ROMERO- HILL's
Entitlement or transfer or assignment of
the right(s) of the military identification.

Fifty Thousand and no/100 dollars:
50,000.00 USD, or: equivalent currency
to which the Secured Party may prefer
to agree to the receipt

5.BE VERLY JEAN ROMERO- HILL's
Entitlement or transfer or assignment of
the right(s) of the legal land description,
land mortgage, second mortgage.

Current U.S. Market Value each, plus
for the triple damages: per the each
occurrence; plus for the triple damages

6.

Collateral

Value in Security Interest

6. BEVERLY JEAN ROMERO- HILL's
Entitlement or transfer or assignment of
the right(s) of the lot block tax.

Current U.S. Market Value: per the each
occurrence; plus for the triple damages

7.BE VERLY JEAN ROMERO- HILL's
Entitlement or transfer or assignment
right(s) of VEH1: ARIZONA
CERTIFICATION OF TITLE, Inventory
Control [REDACTED] VEH2: ARIZONA
CERTIFICATION OF TITLE, Inventory
Control [REDACTED] VEH3: ARIZONA

Current U.S. Market Value: per the each
occurrence; plus for the triple damages

334



SECURITY AGREEMENT BJR001-SA 06252015-SA CE
Non-Negotiable – Private Agreement Between two Parties

353

Unofficial Copy

[INTENTIONALLY LEFT BLANK]

Handwritten signature
20 of 68
Handwritten signature

2022-011769 MISC Page: 353 of 2782
09/26/2022 03:35:37 PM Receipt #: 22-9381
Rec Fee: \$30.00 Darrell James Hill
Gila County, Az, Sadie Jo Bingham, Recorder



**SECURITY AGREEMENT BJR001-SA 06252015-SA CE
Non-Negotiable – Private Agreement Between two Parties**



CERTIFICATION OF TITLE, Inventory Control [REDACTED] ARIZONA
CERTIFICATION OF TITLE, Inventory Control [REDACTED]

8. BEVERLY JEAN ROMERO- HILL's Entitlement or transfer or assignment of the right(s) of the funding source of the bank account, second land mortgage.

Current U.S. Market Value: per the each occurrence; plus for the triple damages

9. BEVERLY JEAN ROMERO- HILL's Entitlement or transfer or assignment of the right(s) of the funding source of the charge card account.

Two Hundred Thousand and no/100 dollars: 200,000.00 USD, or: equivalent currency to which the Secured Party may prefer to agree to the receipt: per the each occurrence; plus for the triple damages

10. BEVERLY JEAN ROMERO- HILL's controlling creditor or Security Entitlement or transfer or assignment right(s) in the funding of the charge accounts of the charge card account.

Two Hundred Thousand and no/100 dollars: 200,000.00, USD, or: equivalent currency to which the Secured Party may prefer to agree to the receipt: each occurrence

11. BEVERLY JEAN ROMERO- HILL's Entitlement or transfer or assignment of the right(s) of the funding source of the stock bonds.

Current U.S. Market Value: per the each occurrence; plus for the triple damages

12. BEVERLY JEAN ROMERO- HILL's Entitlement or transfer or assignment of the right(s) of the funding source of the retirement account: None

Current U.S. Market Value: per the each occurrence; plus for the triple damages

13. BEVERLY JEAN ROMERO- HILL's Entitlement or transfer or assignment of the right(s) of the stockpiles, collections, build-ups, amassments, and of the accumulations, however small, of the

Current U.S. Market Value: per the each occurrence; plus for the triple damages



3546

SECURITY AGREEMENT BJR001-SA 06252015-SA CE
Non-Negotiable – Private Agreement Between two Parties

Federal Reserve Notes, gold certificates,

[INTENTIONALLY LEFT BLANK]

2022-011769 MISC Page: 355 of 2782
09/25/2022 03:35:37 PM Receipt #: 22-9381
Rec Fee: \$30.00 Darrell James Hill
Gila County, Az, Sadie Jo Bingham, Recorder

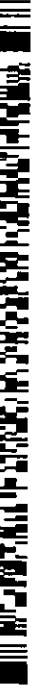

357

SECURITY AGREEMENT BJR001-SA 06252015-SA CE

22 of 68



Handwritten signature
11/17/2022

Unofficial Copy

**SECURITY AGREEMENT BJR001-SA 06252015-SA CE
Non-Negotiable – Private Agreement Between two Parties**



and silver certificates and of the any other types and kinds of a cash, coin, currency, or money: None

14. BEVERLY JEAN ROMERO- HILL's Entitlement or transfer or assignment of the right(s) of the bank account.

Current U.S. Market Value: per the each occurrence; plus for the triple damages

15. BEVERLY JEAN ROMERO- HILL's Entitlement or transfer or assignment of the right(s) of the any rents, wages, salaries, and of another income, from whatever source derived.

Current U.S. Market Value: per the each occurrence; plus for the triple damages

Collateral

Value in Security Interest

16. BEVERLY JEAN ROMERO- HILL's Entitlement or transfer or assignment of the right(s) of any land, mineral, water, and air right(s).

Current U.S. Market Value: per the each occurrence; plus for the triple damages

17. BEVERLY JEAN ROMERO- HILL's Entitlement or transfer or assignment of the right(s) of the any livestock and animals, and of the any thing(s) required for the care, feeding, use, transportation, and husbandry thereof: 2 K-9s, 2 small Fish tanks of 4-6 inch common fish.

Current U.S. Market Value: per the each occurrence; plus for the triple damages

18. BEVERLY JEAN ROMERO- HILL's Entitlement or transfer or assignment of the right(s) of the BEVERLY JEAN ROMERO- HILL's books, booklets, pamphlets, treatises, essays, treatments, monographs, stories, written material, libraries, plays, screenplays, lyrics, songs,

Fifty Thousand and no/100 dollars: 50,000.00 USD, or: equivalent currency to which the Secured Party may prefer to agree to the receipt: per the each occurrence; plus for the triple damages



356

SECURITY AGREEMENT BJR001-SA 06252015-SA CE
Non-Negotiable – Private Agreement Between two Parties

music.

Unofficial Copy

[INTENTIONALLY LEFT BLANK]

2022-011769 MISC Page: 357 of 2782
09/26/2022 03:35:37 PM Receipt #: 22-9381
Rec Fee: \$90.00 Darrell James Hill
Gila County, Az, Sadie Jo Bingham, Recorder



24 of 68

SECURITY AGREEMENT BJR001-SA 06252015-SA CE

359

Beverly Hill
Silver Clasp
Beverly Hill

**SECURITY AGREEMENT BJR001-SA 06252015-SA CE
Non-Negotiable – Private Agreement Between two Parties**

- | | |
|---|---|
| 19. BEVERLY JEAN ROMERO- HILL's Entitlement or transfer or assignment of the right(s) of the BEVERLY JEAN ROMERO- HILL's financial books and records. | Fifty Thousand and no/100 dollars: 50,000.00 USD, or: equivalent currency to which the Secured Party may prefer to agree to the receipt: per the each occurrence; plus for the triple damages |
| 20. BEVERLY JEAN ROMERO- HILL's Entitlement or transfer or assignment of the right(s) of the BEVERLY JEAN ROMERO- HILL's proprietary data and technology, inventions, royalties, and good will. | Current U.S. Market Value: per the each occurrence; plus for the triple damages |
| 21. BEVERLY JEAN ROMERO- HILL's Entitlement or transfer or assignment of the right(s) of the BEVERLY JEAN ROMERO- HILL's records, diaries, journals, photographs, negatives, transparencies, images, video footage, film footage, drawings, sound records, audio tapes, video tapes, and of the computer production and storage facility of any kind. | Fifty Thousand dollars and no/100: 50,000.00 USD, or: equivalent currency to which the Secured Party may prefer to agree to the receipt: per the each occurrence; plus for the triple damages |

Collateral

Value in Security Interest



360
360
AK

SECURITY AGREEMENT BJR001-SA 06252015-SA CE
Non-Negotiable – Private Agreement Between two Parties

Unofficial Copy

[INTENTIONALLY LEFT BLANK]

~~361~~
361

SECURITY AGREEMENT BJR001-SA 06252015-SA CE



26 of 68

2022-011769 MISC Page: 359 of 2782

09/26/2022 03:35:37 PM Receipt #: 22-9381

Rec Fee: \$30.00 Darrell James Hill
Gila County, Az, Sadie Jo Bingham, Recorder



Handwritten signatures and initials:
Bentley
M...

SECURITY AGREEMENT BJR001-SA 06252015-SA CE
Non-Negotiable – Private Agreement Between two Parties



22. Entitlement right(s) of the BEVERLY JEAN ROMERO- HILL's fingerprints, footprints, palm prints, thumbprints, RNA materials, DNA materials, blood and blood fractions, biopsies, surgically removed tissue, body parts, organs, hair, teeth, nails, semen, urine, other bodily fluids and matter, voice-print, retinal image, and of the descriptions thereof, and of the any other corporal identification factors, and of the said factors' physical counterparts, in any form, and of the any records, record numbers, and information pertaining thereto, in regards to the BEVERLY JEAN ROMERO- HILL or any and all linear derivatives and variations in the spelling of the said name.

Five Million and no/100 dollars: 5,000,000.00 USD, or: equivalent currency to which the Secured Party may prefer to agree to the receipt: per the each occurrence; plus for the triple damages

23. BEVERLY JEAN ROMERO- HILL's Entitlement of the right(s) biometrics data, records, information, and processes not elsewhere described, the use thereof, and the use of the information contained therein, pertaining thereto, and otherwise.

Five Hundred Thousand and no/100 dollars: 500,000.00 USD, or: equivalent currency to which the Secured Party may prefer to agree to the receipt: per the each occurrence; plus for the triple damages

24. BEVERLY JEAN ROMERO- HILL's right(s) of the accessing and using utilities upon the payment of the same unit costs as of the comparable units of the usage offered for the benefit of the most-favored customers, including cable, electricity, garbage, gas, internet, satellite, sewer, telephone, water, Internet, e-mail, and of the any other methods of the communication, energy transmission, and of the food and water distribution.

Twenty-Five Thousand and no/100 dollars: 25,000.00 USD, or: equivalent currency to which the Secured Party may prefer to agree to the receipt and a tort claim in favor of BEVERLY JEAN ROMERO- HILL: per each violator: per the each occurrence; plus for the triple damages



SECURITY AGREEMENT BJR001-SA 06252015-SA CE
Non-Negotiable – Private Agreement Between two Parties

Unofficial Copy

[INTENTIONALLY LEFT BLANK]

2022-011769 MISC Page: 361 of 2782
09/26/2022 03:35:37 PM Receipt #: 22-9381
Rec Fee: \$30.00 Darrell James Hill
Gila County, Az, Sadie Jo Bingham, Recorder



28 of 68

SECURITY AGREEMENT BJR001-SA 06252015-SA CE

36B

DOWN HIM

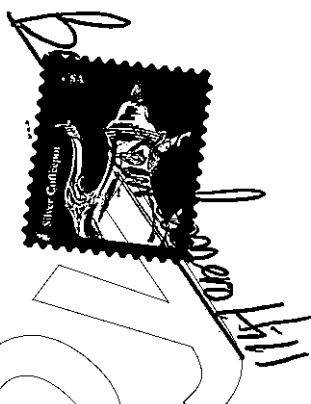

**SECURITY AGREEMENT BJR001-SA 06252015-SA CE
Non-Negotiable – Private Agreement Between two Parties**

25. BEVERLY JEAN ROMERO- HILL's Entitlement right(s) of the bartering, buying, contracting, selling, and of the trading ideas, products, services, and work.

Twenty-Five Thousand and no/100 dollars: 25,000.00 USD, or: equivalent currency to which the Secured Party may prefer to agree to the receipt; and a tort claim in favor of BEVERLY JEAN ROMERO- HILL: per each violator: per the each occurrence; plus for the triple damages

26. BEVERLY JEAN ROMERO- HILL's Entitlement of the right(s) of money, medium of exchange, coinage, barter, economic exchange, bookkeeping, record-keeping, and the like.

Current U.S. Market Value; per the each occurrence; plus for the triple damages

27. BEVERLY JEAN ROMERO- HILL's Entitlement of the right(s) of marrying and procreating children, and rearing, educating, training, guiding, and spiritually enlightening the any of such children, without the any of a requirement for applying for, and without the any of an obligation for obtaining, any type of a license, number, serial number, permit, certificate, permission, and the like, of the any kind whatsoever.

Fifty Thousand and no/100 dollars: 50,000.00 USD, or: equivalent currency to which the Secured Party may prefer to agree to the receipt; and a tort claim in favor of BEVERLY JEAN ROMERO- HILL: per each violator: per the each occurrence; plus for the triple damages

28. BEVERLY JEAN ROMERO- HILL's entitlement of the right(s) of buying, selling, trading, gathering, growing, hunting, raising, and trapping food, fiber, and raw materials for shelter, clothing, and survival.

Fifty Thousand and no/100 dollars: 50,000.00 USD, and a tort claim in favor of BEVERLY JEAN ROMERO- HILL by violator per occurrence: per the each occurrence; plus for the triple damages: per the each occurrence; plus for the triple damages

Collateral

Value in Security Interest

Handwritten signature and the number '364' in the bottom left corner.



SECURITY AGREEMENT BJR001-SA 06252015-SA CE
Non-Negotiable – Private Agreement Between two Parties

Unofficial Copy

[INTENTIONALLY LEFT BLANK]

2022-011769 MISC Page: 363 of 2782
09/26/2022 03:35:37 PM Receipt #: 22-9981

Rec Fee: \$30.00 Darrell James Hill
Gila County, Az, Sadie Jo Bingham, Recorder



SECURITY AGREEMENT BJR001-SA 06252015-SA CE

30 of 68

305

Ben
Mona

SECURITY AGREEMENT BJR001-SA 06252015-SA CE
Non-Negotiable – Private Agreement Between two Parties

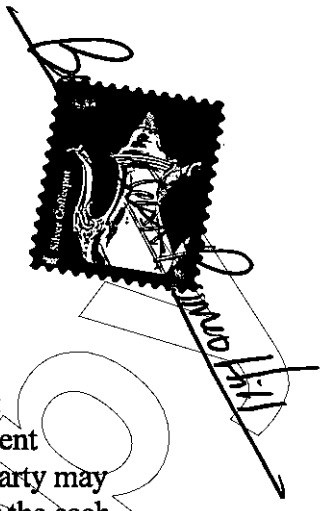

29. BEVERLY JEAN ROMERO- HILL's Entitlement of the right(s) of freedom of religion, worship, use of the sacraments, spiritual practice, and expression without the any of abridgment of the freedom of the speech, publishing, peaceable assembly, and petitioning of the Government for redress of any grievances, and also for the petitioning of any military force of the United States, as well as of any other group, agency, and organization, and otherwise for the physical protection from all of the threats involving the safety and integrity of the person, as well as the any of property, of the SECURED PARTY from any source, both "public" and "private".

Ten Million dollars and no/100: 10,000,000.00 USD, or: equivalent currency to which the Secured Party may prefer to agree to the receipt: per the each occurrence; plus for the triple damages

30. BEVERLY JEAN ROMERO- HILL's Entitlement of the right(s) of keeping and bearing arms for the self-defense of self, family, and parties requesting physical protection of their person and property.

Fifty Thousand and no/100 dollars: 50,000.00 USD, or: equivalent currency to which the Secured Party may prefer to agree to the receipt; and a tort claim in favor of BEVERLY JEAN ROMERO- HILL; per each violator, per each occurrence

31. BEVERLY JEAN ROMERO- HILL's Entitlement of the right(s) of privacy and security in the person, property, papers, effects, private intrusion, detainer, entry, seizure, search, surveillance, trespass, assault, summons, and warrant of BEVERLY JEAN ROMERO- HILL.

Thirty Thousand and no/10 dollars: 30,000.00 USD, or: equivalent currency to which the Secured Party may prefer to agree to the receipt; and a tort claim in favor of BEVERLY JEAN ROMERO- HILL; per each violator, per each hour occurrence: plus for the triple damages

364



SECURITY AGREEMENT BJR001-SA 06252015-SA CE
Non-Negotiable – Private Agreement Between two Parties

Unofficial Copy

[INTENTIONALLY LEFT BLANK]

2022-011769 MISC Page: 365 of 2782
09/26/2022 03:35:37 PM Receipt #: 22-9381
Rec Fee: \$30.00 Darrell James Hill
Gila County, AZ, Sadie Jo Bingham, Recorder

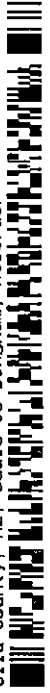

32 of 68

SECURITY AGREEMENT BJR001-SA 06252015-SA CE

~~365~~
367

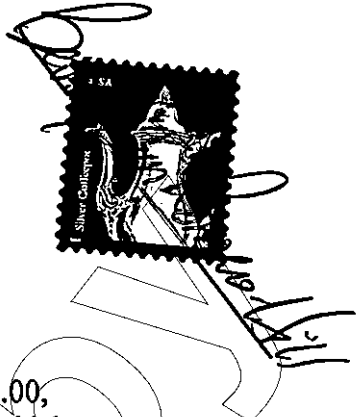

**SECURITY AGREEMENT BJR001-SA 06252015-SA CE
Non-Negotiable – Private Agreement Between two Parties**

41. BEVERLY JEAN ROMERO- HILL's Entitlement of the right(s) of BEVERLY JEAN ROMERO- HILL's packages, parcels, envelopes, and labels of the any kind whatsoever.

Thirty Thousand dollars: 30,000.00, USD, or: equivalent currency to which the Secured Party may prefer to agree to the receipt, and a claim of mail fraud in favor of BEVERLY JEAN ROMERO- HILL; per each violator: per the each occurrence; plus for the triple damages

42. Every item of the BEVERLY JEAN ROMERO- HILL's property itemized or described herein-above in any amount of the "Value of the Collateral Security Interest" under "Words Defined; Glossary of Terms".

Current U.S. Market Value; per the each occurrence; plus for the triple damages

43. Any item of the property of the BEVERLY JEAN ROMERO- HILL not specifically listed, named, or specified by make, model, serial number, account number, etc., and is expressly herewith included as an item of the Collateral of the BEVERLY JEAN ROMERO- HILL.

Current U.S. Market Value: per the each occurrence; plus for the triple damages

-All of the Property and Collateral acquired by non consensual means is replevin unto Beverly-Jean: Romero- Hill-

In the addition to the above: "Collateral" includes, but is not limited by, any the following:

- a) Any of the accessions, increases and additions, replacements of, or substitutions for the any of the properties described in this Collateral section;
- b) Any of the products, produce, or proceeds of the any of the properties described in this Collateral section;
- c) Any of the accounts, general intangibles, instruments, monies, payments, or contract right(s), or the any other of the rights arising out of the sale, lease, or other disposition of the any of the properties described or referred to in the Collateral Section;
- d) Any of the proceeds, including insurance, bond, general intangibles, or account(s) proceeds, from the sale, destruction, loss, or from the any other of the dispositions of the any of the properties described or referred to in the Collateral section;

368



SECURITY AGREEMENT BJR001-SA 06252015-SA CE
Non-Negotiable – Private Agreement Between two Parties

Unofficial Copy

[INTENTIONALLY LEFT BLANK]

2022-011769 MISC Page: 367 of 2782
09/26/2022 03:35:37 PM Receipt #: 22-9381
Rec Fee: \$30.00 Darrell James Hill
Gila County, Az, Sadie Jo Bingham Recorder

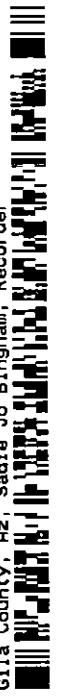

369

SECURITY AGREEMENT BJR001-SA 06252015-SA CE

Handwritten signature
38 of 68
Handwritten signature





**SECURITY AGREEMENT BJR001-SA 06252015-SA CE
Non-Negotiable – Private Agreement Between two Parties**

32. BEVERLY JEAN ROMERO- HILL's Entitlement of the right(s) of claims of the ownership and certificates of the title involving the corporeal and incorporeal hereditaments, hereditary succession, and the any of the innate aspects of the being, to-wit mind, body, soul, free will, faculties, and self.

Current U.S. Market Value: per the each occurrence; plus for the triple damages

33. BEVERLY JEAN ROMERO- HILL's Entitlement to the right(s) of any corporation sole executed and filed, and as well as might be executed and filed, under any or any herein stated said names.

Current U.S. Market Value: per the each occurrence; plus for the triple damages

34. BEVERLY JEAN ROMERO- HILL's documents purportedly evidencing, construing, deemed as proving, regarded as confirming, and of the like, electing minimal contact with this state of de jure state title;

Thirty Thousand and no/100 dollars: 30,000.00 USD, or: equivalent currency to which the Secured Party may prefer to agree to the receipt; and a tort claim in favor of BEVERLY JEAN ROMERO-HILL; per each violator, per each occurrence; plus for the triple damages

35. BEVERLY JEAN ROMERO- HILL's Entitlement of the right(s) of accounts, deposits, escrow accounts, lotteries, overpayments, prepayments, prizes, rebates, refunds, returns, claimed and unclaimed funds, and of the any records and records numbers, correspondence, and information pertaining thereto, as well as of the any such items construed as being derived there-from;

Current U.S. Market Value: per the each occurrence; plus for the triple damages

Collateral

Value in Security Interest



Handwritten number 370 and signature over a large watermark.

Large diagonal watermark reading 'UNREGISTERED' and 'CORP'.

SECURITY AGREEMENT BJR001-SA 06252015-SA CE
Non-Negotiable – Private Agreement Between two Parties

~~569~~
371

[INTENTIONALLY LEFT BLANK]

2022-011769 MISC Page: 369 of 2782
09/26/2022 03:35:37 PM Receipt #: 22-9381
Rec Fee: \$30.00 Darrell James Hill
Gila County, Az, Sadie Jo Bingham, Recorder

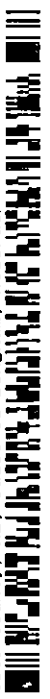

Current U.S. Market Value: per the e
occurrence; plus for the triple damage



SECURITY AGREEMENT BJR001-SA 06252015-SA CE

34 of 68

Unofficial Copy



**SECURITY AGREEMENT BJR001-SA 06252015-SA CE
Non-Negotiable – Private Agreement Between two Parties**

- 36. BEVERLY JEAN ROMERO- HILL's Entitlement of the right(s) of the agriculture, and of the any equipment, inventories, supplies, contracts, and accoutrements involved in the planting, tilling, harvesting, processing, preservation, and storage of any products of any agriculture. Current U.S. Market Value: per the each occurrence; plus for the triple damages

- 37. BEVERLY JEAN ROMERO- HILL's Entitlement of the right(s) of computers, computer systems, and of each piece of the information contained therein, as well as of the any ancillary equipment, printers, and of the data compression and encryption devices and processes. Thirty Thousand and no/100 dollars: 30,000.00 USD, or: equivalent currency to which the Secured Party may prefer to agree to the receipt; plus current U.S. Market Value per each infraction; plus for the triple damages

- 38. BEVERLY JEAN ROMERO- HILL's Entitlement of the right(s) of medical, dental, optical, prescription, and insurance records, records numbers, and information contained in any such records. Two Hundred Thousand and no/100 dollars: 200,000.00 USD, or: equivalent currency to which the Secured Party may prefer to agree to the receipt; per each occurrence; plus for the triple damages

- 39. BEVERLY JEAN ROMERO- HILL's Entitlement of the right(s) of BEVERLY JEAN ROMERO- HILL's Will. Current U.S. Market Value: per the each occurrence; plus for the triple damages

- 40. BEVERLY JEAN ROMERO- HILL's Entitlement of the right(s) of inheritances as well as any of the inheritances as might be received. Current U.S. Market Value: per the each occurrence; plus for the triple damages

Collateral

Value of the Collateral Security Interest

372

2022-011769 MISC Page: 370 of 2782
 09/26/2022 03:35:37 PM Receipt #: 22-9381
 Rec Fee: \$30.00 Darrell James Hill
 Gila County, Az, Sadie Jo Bingham, Recorder



SECURITY AGREEMENT BJR001-SA 06252015-SA CE
Non-Negotiable – Private Agreement Between two Parties

[INTENTIONALLY LEFT BLANK]

2022-011769 MISC Page: 371 of 2782
09/26/2022 03:35:37 PM Receipt #: 22-9381
Rec Fee: \$30.00 Darrell James Hill
Gila County, Az, Sadie Jo Bingham, Recorder

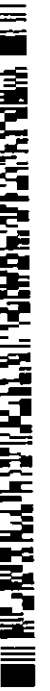

[Handwritten signature]
36 of 68
[Handwritten signature]



SECURITY AGREEMENT BJR001-SA 06252015-SA CE

~~37A~~
379

Unofficial Copy

**SECURITY AGREEMENT BJR001-SA 06252015-SA CE
Non-Negotiable – Private Agreement Between two Parties**



- e) Any of the records or data involving any of the property(s) described in the Collateral Section, not limited by the any of the writings, photographs, microfilms, microfiches, tapes, electronic media, or the like, together with the any of the DEBTOR's rights, titles, or interests in the any of the computer softwares or hardwares required for utilizing, creating, maintaining, and processing any of the such records or data in the any electronic media;
- f) unintentional omissions.

Authorized Representative:

DEBTOR hereby assigns: SECURED PARTY unto:

- a) Signing, harmless of the any liability: DEBTOR's signum for the any of the purposes for the authentication of the any of the writings in the any of the agreements between the DEBTOR and any one(s) other;
- b) Demanding or collecting or receiving or accepting of the receipt, or suing or recovering any of the sums of the money or the any other of the property(ies) in the favor of the DEBTOR;
- c) Executing or signing or indorsing on the any of the claims or instruments or receipts or checks or drafts or warrants issued forth and made payable in the favor of the DEBTOR;
- d) Settling on the any of the compromises or claims in regards to the DEBTOR or in the any of the Collateral;
- e) Filing of the any of the claims or actions, or of the instituting of the any proceedings in the name of the SECURED PARTY or of the DEBTOR: SECURED PARTY may also receive or open or dispose of the any of the mail indicating any of the alleged addresses of the DEBTOR, or to make change in the any of the addresses concerning any of the mail or payments.
- f) SECURED PARTY's assignment or Authorization is given so as to affirm of the DEBTOR's indebtedness, and of the SECURED PARTY'S authority to remain in the full force and effect until renounced by the SECURED PARTY solely as indicated herein-above.

Perfection of the Security Interest:

Filing of the Financing Statement:

- a) DEBTOR by the means of the possession or control or attachment authorizes and assigns to the SECURED PARTY all of the right(s) in the filing of the financing statements or continuing financing statements describing any of the property or collateral including, but not limited to the filing(s) of the any of the agricultural liens or of the other of the statutory liens against the DEBTOR, and held by the SECURED PARTY;
- b) DEBTOR assigns and authorizes: authentication of the financing statements or execution of the any of the action(s) deemed reasonable by the SECURED PARTY for the

372



SECURITY AGREEMENT BJR001-SA 06252015-SA CE
Non-Negotiable – Private Agreement Between two Parties

Unofficial Copy

[INTENTIONALLY LEFT BLANK]

2022-011769 MISC Page: 373 of 2782
09/26/2022 08:35:37 PM Receipt #: 22-9381
Rec Fee: \$30.00 Darrell James Hill
Gila County, Az, Sadie Jo Bingham Recorder



375

SECURITY AGREEMENT BJR001-SA 06252015-SA CE



40 of 68



**SECURITY AGREEMENT BJR001-SA 06252015-SA CE
Non-Negotiable – Private Agreement Between two Parties**

perfecting and continuation of the SECURED PARTY's security interest in the any collateral of the DEBTOR; and: DEBTOR also consents and agrees as follows:

- i) SECURED PARTY may file: carbon or photographic or the any other types of reproduction of the any of the herein-authorized financing statements or Security Agreements for the use of as a financing statement; and
- ii) SECURED PARTY is held harmless in the taking of the any of the steps necessary for the preservation of the any of a third-party's right(s) in a property or collateral. **NOTE:** Perfecting or filing of a UCC Financing Statement does not effect enforcement of the right(s) of the SECURED PARTY. Security Agreement, **Non-Negotiable – Private Agreement Between two Parties**, BJR001-SA, ENCLOSURE-2, constitutes all of the enforcement right(s) of the Beverly-Jean: Romero- Hill by the means of the assignment of the attachment, possession or control right(s). See, in the nature of, UCC § 9-607.

Obligations of the DEBTOR:

Perfection of the Security Interest:

- 1) DEBTOR may execute such: financing statements, and may take any of the actions as requested by the SECURED PARTY for the perfection and continuation of the SECURED PARTY's security interest in the Collateral.
- 2) SECURED PARTY may at any time file any type of a reproduction of this Security Agreement for his use to the perfected financing statement. SECURED PARTY is held harmless in taking the any of the steps necessary in the securing of his priority over the any of the rights of the any third parties in the any of the Collateral.
- 3) This Security Agreement is that of a continuing instrument in the favor of the SECURED PARTY which continues in the effect(s) through any, or any part of, indebtedness and may be discharged/ settled in the full notwithstanding of the fact that a period of a time may pass in which the DEBTOR incurs no indebtedness in the favor of the SECURED PARTY.

Events of the Default under this Security Agreement:

Insolvency:

Insolvency of the DEBTOR, or of the appointment of a receiver for the any part of the DEBTOR's property, or for the any of the assignments in the benefit(s) of a third-party creditor, or for the commencement of the any proceedings under any set of laws, not limited to bankruptcy or insolvency law, by the DEBTOR or against the DEBTOR.

Creditor Proceedings:

Commencement of a foreclosure by a judicial proceeding, self-help, repossession, or by the any methods by the any of the third-party creditors of the DEBTOR against the any item of the DEBTOR's collateral securing any of the indebtedness to the SECURED PARTY, or that is:

Handwritten scribbles and numbers, including '376' and '574'.



SECURITY AGREEMENT BJR001-SA 06252015-SA CE
Non-Negotiable – Private Agreement Between two Parties

[INTENTIONALLY LEFT BLANK]

2022-011769 MISC Page: 375 of 2782
09/26/2022 09:35:37 PM Receipt #: 22-9381
Rec Fee: \$30.00 Darrell James Hill
Gila County, Az, Sadie Jo Bingham, Recorder



42 of 68

SECURITY AGREEMENT BJR001-SA 06252015-SA CE

~~377~~
377

Unofficial Copy

**SECURITY AGREEMENT BJR001-SA 06252015-SA CE
Non-Negotiable – Private Agreement Between two Parties**



subject in this Security Agreement.

Other Defaults:

Failure in the compliance by the DEBTOR in the any of the terms, obligation, covenant, condition, or the like, contained in: (a) the written, express, Private Agreement, Non-negotiable – Private Between the Parties: BJR001-PA, ENCLOSURE-2, between: DEBTOR, "BEVERLY JEAN ROMERO- HILL", or any linear derivatives or variations in the spelling of said name except "Beverly-Jean: Romero- Hill," and: SECURED PARTY, "Beverly-Jean: Romero- Hill"; (b) this Security Agreement; (c) any related document, as well as the any other agreements or contracts between: DEBTOR and: SECURED PARTY.

Rights and Remedies in the Event of a Default:

Under this Security Agreement, by the default of the DEBTOR, then: SECURED PARTY shall have all of the right(s) of the SECURED PARTY in the commerce in regards to the DEBTOR. And, without of a limitation: SECURED PARTY may exercise the any of the numbers of the following enforcement rights and remedies:

Sell the Collateral:

SECURED PARTY possesses: full power for the selling, leasing, transferring, and otherwise dealing with the Collateral and proceeds thereof in the name of the both: SECURED PARTY and: DEBTOR.

SECURED PARTY may sell any of the Collaterals in the any manners and at the any places, such as at a public auction, private sale, and otherwise without a further notice. And: any of the expenses involved in the disposition of the Collateral, including, without a limitation: expenses of the holding, insuring, preparing for the sale, and of the selling of the Collateral become added to the part of the indebtedness secured by this Security Agreement and are payable to the SECURED PARTY on his demand.

Appoint Receiver:

In the accordance with the requirements and options permitted by the applicable law:

SECURED PARTY possesses all of the following rights and remedies in regards to the appointment of a receiver:

- a) SECURED PARTY de jure may have that of a receiver appointed;
- b) Receiver may be: employee of the SECURED PARTY, and may serve without a bond;
- c) Any of fees of the receiver and of the any attorney of the receiver become: part of the indebtedness secured by this Security Agreement and are payable on the SECURED PARTY's demand with an interest at the Note rate; unless: payment of the interest at that rate is not permitted by the applicable law; which, in the event(s) of the such of an occurrence: expenses shall bear in the additional costs in the interest at the highest rate permitted by the applicable law from the date of the expenditure to until the debt is repaid.



376

SECURITY AGREEMENT BJR001-SA 06252015-SA CE
Non-Negotiable – Private Agreement Between two Parties

Unofficial Copy

[INTENTIONALLY LEFT BLANK]

2022-0111769 MISC Page: 377 of 2782
09/26/2022 03:35:37 PM Receipt #: 22-9381
Rec Fee: \$30.00 Darrell James Hill
Gila County, Az, Sadie Jo Bingham, Recorder



Handwritten signature
44 of 68
Handwritten signature



379

SECURITY AGREEMENT BJR001-SA 06252015-SA CE
Non-Negotiable – Private Agreement Between two Parties

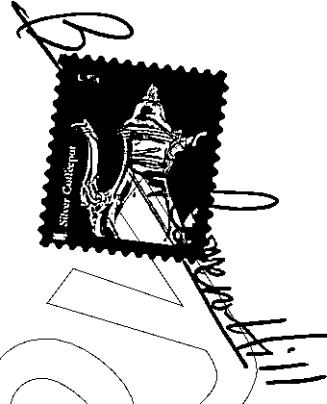

Collect Revenues, Apply Accounts:

- a) SECURED PARTY, both in: SECURED PARTY's personal capacity, and through a receiver, may collect the payments, rents, incomes, and revenues from the Collateral.
- b) SECURED PARTY may at any time, at the sole discretion of the SECURED PARTY, transfer any of the Collateral into the name of the SECURED PARTY, as well as into the name of the any nominee of the SECURED PARTY, and receive the payments, rents, incomes, and revenues there-from, and may place onto the same that of a hold as the security for the indebtedness, and apply those of the payments in the favor of the indebtedness in an order of a preference that: SECURED PARTY may at-will determine.
- c) Insofar as the Collateral consists of the account(s), general intangibles, deposit accounts, insurance policies, instruments, chattel paper, choses in action, and the any of the similar property(s): SECURED PARTY may demand, collect, receive, execute receipt for, settle, compromise, adjust, sue for, foreclose, and realize on the Collateral: SECURED PARTY may determine, concerning both: indebtedness, and: Collateral, and whenever due.

Disposition of the Rights of the SECURED PARTY:

SECURED PARTY shall have all of the right(s) in any disposition of the any of the herein-stated and adequately described Collaterals for the benefit of the SECURED PARTY as the SECURED PARTY sees fit; to wit:

Obtain Deficiency: If: SECURED PARTY decides in the favor of the selling of the any of the Collateral, then: SECURED PARTY may obtain in a judgment against the DEBTOR for any of the deficiencies remaining on the indebtedness; Too, for the any of the indebtedness owed to the SECURED PARTY that might remain to be owed by the DEBTOR after the all of the application of all of the amounts received from the exercise of the right(s) provided in this Security Agreement: DEBTOR will remain liable for any deficiency even if the transaction described in this subsection is for a sale of the any of the Collaterals, and likewise of the any of the chattel paper.

Cumulative Remedies: Any of the SECURED PARTY's rights and remedies, as evidenced by this Security Agreement, as well as by the any of the other related documents and by the any of the other writings, is cumulative and may be exercised both singularly and concurrently: Any pursuit by the SECURED PARTY of the any of a remedies does not exclude that of a pursuit of the any of the other remedies; and: making expenditures and taking action for the performance of an obligation of the DEBTOR under this Security Agreement, after the DEBTOR's failure of a performance, does not affect the any of the SECURED PARTY's rights for the declaration of a default and exercising of the any of the remedies thereof.

Other right(s) and Remedies: SECURED PARTY possesses all of the rights and remedies of a secured creditor under the UCC, and that as may be amended upon the agreement

380
378 BJD



SECURITY AGREEMENT BJR001-SA 06252015-SA CE
Non-Negotiable – Private Agreement Between two Parties

[INTENTIONALLY LEFT BLANK]

2022-011769 MISC Page: 379 of 2782
09/26/2022 03:35:37 PM Receipt #: 22-9381
Rec Fee: \$30.00 Darrell James Hill
Gila County, Az, Sadie Jo Bingham, Recorder

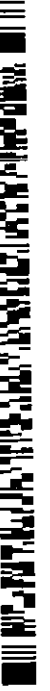

Handwritten signature
46 of 68
11/14/2022

SECURITY AGREEMENT BJR001-SA 06252015-SA CE

381
~~381~~
Handwritten marks

Unofficial Copy

**SECURITY AGREEMENT BJR001-SA 06252015-SA CE
Non-Negotiable – Private Agreement Between two Parties**

between any of the parties. In addition: SECURED PARTY possesses, and may exercise, that of the any and all of the other rights and remedies available at the law, in the equity, and of the otherwise.

Rules of Construction of the Security Agreement:

- a) neither is the use of, nor is the referencing of the term “proceed(s)” authorizing any sale, transfer, other disposition, and the like, of the any of the Collaterals by the DEBTOR;
- b) words “include,” “includes,” and “including” are not limiting;
- c) word “all” includes “any” and the word “any” includes “all,”
- d) word “or” is not exclusive; and,
- e) words and terms: i) in the singular number includes the plural, and in the plural number includes the singular; and ii) in the masculine gender includes both the feminine and neuter.

Miscellaneous Provisions Part of this Security Agreement:

Amendments: Security Agreement, together with the any of the related documents and endorsements, constitutes of the entire understanding and agreement of the parties regarding any of the matters set forth in this Security Agreement. Therefore: Security Agreement may neither be changed nor modified in the any manner whatsoever unless that of the said change/ modification is agreed upon by the SECURED PARTY by the writing and signing by the DEBTOR and: SECURED PARTY, with the recording of the same instrument with the UCC as an amendment and addendum.

Further Assurances:

Upon the Reasonable request by the SECURED PARTY: DEBTOR consents and agrees that DEBTOR will execute further any of the documents and take further any of the actions as requested by the SECURED PARTY that will augment any of the following: a) evidencing of the security interest granted herein; b) perfecting of the security interest granted herein; c) maintaining of the first priority of the security interest granted herein; and, d) effectuating of the right(s) herein granted to the SECURED PARTY by the DEBTOR.

Severability:

In the event that in a court of original and general jurisdiction at the common law, such as an Article III court of the justice arising under The Constitution for the united States of America - 1787 CE, with the Bill of Rights -1791 CE, as lawfully amended by the qualified electors of the several States of this American Union, and of the laws of the *de jure* united States of America, and such as a court of the justice in an accordance within the course of the common law arising under the Constitution of the STATE de jure, as amended by the qualified electors of said STATE de jure and the laws of the STATE de jure, judicially determines that the any of a part of this Security Agreement, including that of the any amendment, addendum, and revision, is unacceptable for a reason, that such is as on its basis



380

SECURITY AGREEMENT BJR001-SA 06252015-SA CE
Non-Negotiable – Private Agreement Between two Parties

Unofficial Copy

[INTENTIONALLY LEFT BLANK]

2022-011769 MISC Page: 381 of 2782
09/26/2022 03:35:37 PM Receipt #: 22-9381
Rec Fee: \$30.00 Darrell James Hill
Gila County, Az, Sadie Jo Bingham, Recorder



48 of 68

SECURITY AGREEMENT BJR001-SA 06252015-SA CE

383

Handwritten signature and scribbles

**SECURITY AGREEMENT BJR001-SA 06252015-SA CE
Non-Negotiable – Private Agreement Between two Parties**

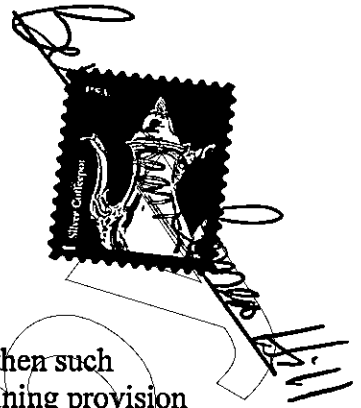

of the being unlawful, invalid, void or voidable, unenforceable, and the like, then such provisions are thereby severed from this Security Agreement, but every remaining provision continues in the fullness of the force and effect and may not be affected by such of a determination. If feasible, then any of the such offending provisions may be deemed modified for inclusion within the limits of its enforceability and validity, however, if in the event that of the offending provision(s) cannot be so modified, then of the said offending provision is thereby stricken, and the all of the other provisions of this Security Agreement in the any of the other respects remains valid and enforceable by the SECURED PARTY.

Waiver:

SECURED PARTY shall not be construed as waiving any of the right(s) under this Security Agreement unless such of a waiver is given in the writing and signed by the SECURED PARTY in red ink. Furthermore;

Neither by a delay nor by an omission on the part of the SECURED PARTY in the exercise of a right(s) shall such be presumed to operate as that of a waiver of the right(s) or of the any of an other right;

In the any waiver by the SECURED PARTY of the any provision(s) of this Security Agreement, incidence of a waiver neither prejudices, nor constitutes any of an other waiver of the SECURED PARTY's right for otherwise demanding a strict compliance with that provision, or in the any other of the provisions, of this Security Agreement;

Neither by a prior occurrence of a waiver by the SECURED PARTY, nor by any course in the dealings between: SECURED PARTY, and: DEBTOR, does there constitute the presumption of a continuous waiver of the any of the SECURED PARTY's right(s) in the election, nor of a waiver of the any of the DEBTOR's obligations and responsibility(s) in regards to any of the future transactions; and,

Whenever: consent of the SECURED PARTY is required under this Security Agreement, then: SECURED PARTY's granting of such of a consent shall not be construed as constituting that of a continuing consent for the any of the subsequent instances wherein such of a consent is required; and in the any of the instant matter(s), such of a consent may be granted and withheld in the sole discretion of the SECURED PARTY.

This: Security Agreement is not dischargeable in a bankruptcy court; to wit: SECURED PARTY is the Entitlement holder of the any of the negotiable instruments referencing, bearing upon, and deriving from the any of the properties and Collaterals referenced herein: DEBTOR acknowledges that all of the Collateral is exempt from a levy and third-party lien.

This: Security Agreement herewith expressly includes and encompasses any of the Security Entitlement rights, other right(s), legal title, equitable title, and interest in the any of the properties described above in the Collateral section of this Security Agreement.

This: Security Agreement secures the any of the indebtedness and liability(s) whatsoever that:



382

SECURITY AGREEMENT BJR001-SA 06252015-SA CE
Non-Negotiable – Private Agreement Between two Parties

Unofficial Copy

[INTENTIONALLY LEFT BLANK]

2022-011769 MISC Page: 383 of 2782
09/26/2022 03:35:37 PM Receipt #: 22-9381
Rec Fee: \$20.00 Darrell James Hill
Gila County, AZ, Sadie Jo Bingham, Recorder



Handwritten signature



50 of 68

SECURITY AGREEMENT BJR001-SA 06252015-SA CE

383



**SECURITY AGREEMENT BJR001-SA 06252015-SA CE
Non-Negotiable – Private Agreement Between two Parties**

DEBTOR owes in the favor of the SECURED PARTY. This: security interest also secures the any of the debts that may be owed by the DEBTOR, upon the any of an occasion, for the benefit of the SECURED PARTY.

Thus: DEBTOR grantor acknowledges, consents, and agrees with all of the provisions of this Security Agreement and agrees, consents and admits that: DEBTOR is bound by all of the terms and conditions as stated herein.

INTENTIONALLY LEFT BLANK



Unofficial Copy

384

SECURITY AGREEMENT BJR001-SA 06252015-SA CE
Non-Negotiable – Private Agreement Between two Parties

INTENTIONALLY LEFT BLANK

Page: 385 of 2782
Receipt #: 22-9381

2022-011769 MISC
09/26/2022 03:35:37 PM
Rec Fee: \$30.00
Gila County, Az

Darrell James Hill
Sadie Jo Bingham, Recorder



SECURITY AGREEMENT BJR001-SA 06252015-SA CE

52 of 68



~~385~~
387

[Handwritten signature]

Unofficial Copy

SECURITY AGREEMENT BJR001-SA 06252015-SA CE
Non-Negotiable – Private Agreement Between two Parties



Unofficial Copy

ENCLOSURE-1

Political Status Election: BJR001-POLE

388

SECURITY AGREEMENT BJR001-SA 06252015-SA CE

53 of 68

2022-011769 MISC Page: 386 of 2782
09/26/2022 03:35:37 PM Receipt #: 22-9381
Rec Fee: \$30.00 Darrell James Hill
Gila County, Az, Sadie Jo Bingham, Recorder



SECURITY AGREEMENT BJR001-SA 06252015-SA CE
Non-Negotiable – Private Agreement Between two Parties

Unofficial Copy

[INTENTIONALLY LEFT BLANK]

2022-011769 MISC Page: 387 of 2782
09/26/2022 03:35:37 PM Receipt #: 22-9981
Rec Fee: \$30.00 Darrell James Hill
Gila County, Az, Sadie Jo Bingham, Recorder

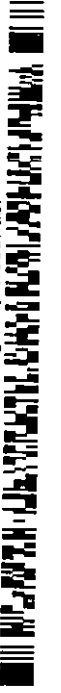

389

SECURITY AGREEMENT BJR001-SA 06252015-SA CE

Revised
James Hill



54 of 68

**Political Status Election:
Affirmation In Confirmation of Sovereign**



L.S. Beverly Jean Romero Hill

:PRESENTS: STATUS (legal position): STANDING (interest in consideration):

I AM: Romero Beverly Jean: Beverly-Jean: Romero- Hill, do herein report: truths and facts herein are of my first hand personal comprehension and review; to wit:

- 1) I am: undersigned American Sovereign, am: Romero Beverly Jean (a.k.a. Beverly-Jean: Romero- Hill): natural born of the man Delferio of the family Romero; and, then-after, named additionally: Beverly and Jean, at, or soon after birth. See: state rights documentation and acknowledgments: Enclosure 1: a) Notarial Acknowledgment of Authentic "CERTIFICATE OF BIRTH"; b) copy of CERTIFICATE OF BIRTH, STATE OF NEW MEXICO for the stramineus homo; c) Notarial Acknowledgment of Original "Arizona Driver License"; d) copy of "Arizona Driver License" for the stramineus homo.
- 2) I am at the natural birth man citizenry of the New Mexico state territory of the Union of nation states of the united States of America understanding of the Original Jurisdiction*.

*Notice: Term "Original Jurisdiction" means A) under the covenant: Almighty God: Torah:-and writings, and: as proposed under 1)The Constitution for the united States of America - 1787 CE, as indicated in the "The united States of America" set for in 2) The Articles of the Confederation -1777-1781 CE, and: 3) constitutional articles in amendment - 1791 CE, and: 4) other original covenants and accords under the Original Jurisdiction, including, but not limited to:

- a) National Bill of Rights, 1776 CE; and:
- b) The Northwest Ordinance, 1787 CE.
- 3) I am of the the majority age.
- 4) I am of the competent mind, and make this political chose in action.
- 5) I am that of a sentient free Man upon the ground under the Almighty God; to wit: an understanding Ambassador of the Son and Creator God of all that is, and of His Father, even: Most High God in Heaven, the Divine, with whom Nothing and No-one exists between; to wit:

KJV: Book: Genesis-Chapter 1:26 And God said, Let us make man in our image, after our likeness: and let them have dominion over the fish of the sea, and over the fowl of the air, and over the cattle, and over all the earth, and over every creeping thing that creepeth upon the earth. Gen 1:27 So God created man in his own image, in the image of God created he him; male and female created he them.

390
Political Status Election: Affirmation In Confir

2022-011769 MISC Page: 388 of 2782
09/26/2022 03:35:37 PM Receipt #: 22-9381
Rec Fee: \$30.00 Darrell James Hill
Gila County, Az, Sadie Jo Bingham, Recorder



Political Status Election: Affirmation In Confirmation of Sovereign

[INTENTIONALLY LEFT BLANK]

2022-011769 MISC Page: 389 of 2782

09/25/2022 03:35:37 PM Receipt #: 22-9981
Rec Fee: \$30.00 Darrell James Hill
Gila County, Az; Sadie Jo Bingham, Recorder



2 of 26

[Handwritten signature]

Political Status Election: Affirmation In Confirmation of Sovereign

391
~~391~~

Unofficial Copy

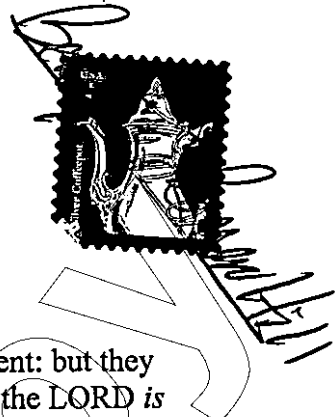

Political Status Election: Affirmation In Confirmation of Sovereign

KJV: Book: Proverbs-Chapter 28:5 Evil men understand not judgment: but they that seek the LORD understand all *things*. Chapter 9:10 The fear of the LORD is the beginning of wisdom: and the knowledge of the holy is understanding.

KJV: Book: Ephesians-Chapter 6:19 And for me, that utterance may be given unto me, that I may open my mouth boldly, to make known the mystery of the gospel, 6:20 For which I am an ambassador in bonds: that therein I may speak boldly, as I ought to speak.

- 6) I am of the American citizenry people by birth in the New Mexico state in the year anno domini Nineteen fifty eight under Almighty God; thus:
- 7) I am of the American citizenry trust beneficiary status: trust titled customarily in the corporate all capitalized manner of the stramineus homo, formed from the elements of the Romero Beverly Jean: to wit, "Beverly Jean Romero"*** due to the subsequent events occurring after and under the derivative organization(s) under the Original Jurisdiction. See Enclosure 1: Item (d).

****Notice:** The use of a doctrine of *idem sonans* in any form is hereafter forbidden as it is a material constructive fraud and deceitful practice in any reference to the man Beverly-Jean: Romero- Hill; to wit: whether oral, written or other, as relates to the Beverly-Jean: Romero- Hill, such of a practice by any fiduciary designated of the public trust in the any manner or presumption in the any regard or in the any direct service of the Beverly-Jean: Romero- Hill is will fraud and constructive fraud by the any actor(s).

PUBLIC NOTICE:

THIS DOCUMENT GIVES NOTICE of these reports: clarifications or other matters contained to the UNITED STATES, Inc. entity and all of the derivatives thereof: Public and Private, through and by the any Office of the Secretary of State(s) or their agent(s): de facto and de jure "united States of America" seat(s) of the government in and upon the territory thereof; and, through and by the Office of the Secretary of State(s) or their agent(s): de facto and de jure "Arizona state" seat(s) of the government in and upon the territory thereof; and to the all of the persons who would know, or should have known, this Notice content as relates to the undersigned, by and upon the filing of this public notice.

NOTICE TO DOMESTIC AND FOREIGN JURISDICTIONS:

Notice to the principal is notice to all of the agent(s): Notice to the agent is notice to all of the principals of the de facto UNITED STATES AND STATE government(s): actor(s) and derivatives thereto; to wit: Officer(s), Employee(s), Agent(s), Contractor(s), and the like; and,

Handwritten scribbles and the number 392 in the bottom left corner.

2022-011769 MISC Page: 390 of 2782
 09/26/2022 03:35:37 PM Receipt #: 22-9981
 Rec Fee: \$30.00 Darrell James Hill
 Gila County, Az. Sadie Jo Bingham, Recorder



Political Status Election: Affirmation In Confirmation of Sovereign

[INTENTIONALLY LEFT BLANK]

2022-011769 MISC Page: 391 of 2782
09/26/2022 03:35:37 PM Receipt #: 22-9381
Rec Fee: \$30.00 Darrell James Hill
Gila County, Az, Sadie Jo Bingham, Recorder



4 of 20
32

Political Status Election: Affirmation In Confirmation of Sovereign

393

Unofficial Copy



Political Status Election: Affirmation In Confirmation of Sovereign

when-upon this notice is once affixed to any home ground(s) of the Beverly-Jean: Romero- Hill's land-site or habitation-site, or site-otherwise, then:

- a) all of the property attached and referred thereunto is under the custody and control of the above-noted: Beverly-Jean: Romero- Hill;
- b) pursuant to the common-law, then: site access is denied and is not subject to presumed or wanton intrusion for search or seizure, or the like, except by the willful pre-authorization from the Beverly-Jean: Romero- Hill;
- c) Note: pursuant to the common-law: man is lawfully and legally immune from wanton criminal or civil jurisdiction(s), arrest(s) or detention(s), or the like, as under the Original Jurisdiction convention(s); and,
- d) all of the Actors, of both the private and public sector(s), must take all of the steps that are available to be taken in every condition to assure and to prevent any of the reproach or attack otherwise on the man's God given inalienable Right(s); to wit: Constitutionally secured and protected in-alienable Right(s), freedom(s), property(s), interest(s), mobility(s) and security(s) and protection(s) thereof;
- e) Legality(ies) of this Notice, or the like: inquiry(ies) in regards to the any actor(s) in their constitutional responsibility(ies) should be made to the sheriff in the county of the territory of the any event of the any matter(s) of the actor's concern.

:PRESENTS: CHARACTER: (motive(s) that control a life): CAPACITY: (legal or moral qualification necessary for certain purposes):

Beverly-Jean: Romero- Hill does hereby state, assert and aver the all of the following:

- 1) Beverly-Jean: Romero- Hill is a man understanding of the Almighty God; to wit: an Ambassador of the Messiah: Genesis-Chapter-1:26-27; Proverbs-Chapter-28:5; Proverb Chapter-9:10; Ephesians-Chapter-6:...19-20 - KJV

Ephesians-Chapter 6:19 And for me, that utterance may be given unto me, that I may open my mouth boldly, to make known the mystery of the gospel, 6:20 For which I am an ambassador in bonds: that therein I may speak boldly, as I ought to speak.

- 2) Beverly-Jean: Romero- Hill is a biological citizen born in, upon and of the natural territory of the "New Mexico state" of the states of America.
- 3) Beverly-Jean: Romero- Hill is a private-individual, private-person, and non-fictitious person or entity; to wit: a man under the Almighty God the Divine between which there none other.
- 4) Beverly-Jean: Romero- Hill retains all of the absolute jurisdiction of the people: a natural person man understanding: Almighty God.
- 5) Beverly-Jean: Romero- Hill retains all of the absolute protections of the Rights, remedies and defenses granted by the Almighty God by the subsequent limitations created and beset by the people of the states of America for the people and upon the united States of

2022-011769 MISC Page: 392 of 2782
 09/26/2022 03:35:37 PM Receipt #: 22-9381
 Darrell James Hill
 Rec Fee: \$30.00 Sadie Jo Bingham, Recorder
 Gila County, Az



392

Political Status Election: Affirmation In Confirmation of Sovereign

[INTENTIONALLY LEFT BLANK]

2022-011769 MISC Page: 393 of 2782

09/25/2022 03:35:37 PM Receipt #: 22-9381

Rec Fee: \$30.00 Darrell James Hill
Gila County, Az, Sadie Jo Bingham, Recorder



6 of 20-22

393 Political Status Election: Affirmation In Confirmation of Sovereign

Unofficial Copy

Political Status Election: Affirmation In Confirmation of Sovereign



America government(s) upon its inception and creation as established under the covenant(s) of the Original Jurisdiction.

- 6) Beverly-Jean: Romero- Hill is of the real capacity and character above, and as the same has chosen a political status above that of, and foreign to the UNITED STATES government corporate jurisdiction; to wit:
 - Beverly-Jean: Romero- Hill does not volunteer, nor consent or contract to be presumed as acting in any *ens legis* entity or capacity, neither to be presumed as an operative of the any other political state or subdivision or surety of the any UNITED STATES corporate interest(s); to wit: Beverly-Jean: Romero- Hill reserves the nature and character of the exact and proper man status and capacity under: Almighty God, and of the same election reserved under the Original Jurisdiction.
 - Beverly-Jean: Romero- Hill waives none of the Rights, Remedies or defenses, nor yields of the same, including, without a limitation, the any of the Rights in the accordance with the protection(s) and principle(s) of the Rights, Remedies and defenses assured by and under the Original Jurisdiction; to wit: Rights, such as: right to freedom of movement: private right to travel without restriction in any conveyance on any public roadway in this united nation States of America: right to bear arms for the survival and protection of family and country.
 - Beverly-Jean: Romero- Hill is Not a "UNITED STATES CITIZEN"; to wit, Not: subject, vessel, or other presumed entity of the UNITED STATES government as defined in statutes-at-large, such as in the nature of the Title 26 UNITED STATES CODE, "USC", Section 7701, or of the like as elsewhere is defined in the statutes-at-large.
 - Beverly-Jean: Romero- Hill is Not in the any form: *ens legis* fiction as is: "person or individual," entity, or other procedural construct or statutory term referring to a legal fiction.
- 7) Beverly-Jean: Romero- Hill is by choice herein a restricted name under common-law "Trade-name/ Trade-mark"; and it is unto "Romero Beverly Jean" who all of the Rights are reserved: Use, with the any reference to the Beverly-Jean: Romero- Hill, without express written permission by the Beverly-Jean: Romero- Hill creates a voluntary and informed consensual contractual obligation upon the unauthorized user to the payment of a Trade-name/ Trade-mark infringement fee(s) as follows: Trade-name/Trade-mark infringement fee is in the sum certain of five hundred thousand dollars and no/100: 500,000.00 USD lawful money of account: gold or silver coin, or: certified bullion, or: equivalent money to which , Beverly-Jean: Romero- Hill, the Secured Party, may prefer to agree to the receipt.
- 8) Beverly-Jean: Romero- Hill comprehends for to identify, paraphrase and refer herein of the following facts of the historical significance bearing upon the implementation of the Original jurisdiction, and thereto upon the man's status, capacity, character and standing; to wit, that:

2022-011769 MISC Page: 394 of 2782
 09/26/2022 03:35:37 PM Receipt #: 22-9881
 Rec Fee: \$30.00 Darrell James Hill
 Gila County, Az, Sadie Jo Bingham, Recorder

396
396

Political Status Election: Affirmation In Confirmation of Sovereign

[INTENTIONALLY LEFT BLANK]

2022-011769 MISC Page: 395 of 2782
09/26/2022 09:35:37 PM Receipt #: 22-9381
Rec Fee: \$30.00 Darrell James Hill
Gila County, Az, Sadie Jo Bingham, Recorder

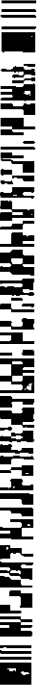

397

~~397~~ *[Handwritten signature]*

Political Status Election: Affirmation In Confirmation of Sovereign



8 of 20

22

[Handwritten signature]
[Handwritten signature]

Unofficial Copy

Political Status Election: Affirmation In Confirmation of Sovereign



- a) Due to the faux governmental disparity(s) arising out of the gross capital control controversies by the clandestine banking factions and their actors from in the 17th century to date, the constitutional government was and remains usurped by criminals intent upon theft of Almighty God's covenanted people even from the first presumed president until to date; to wit, a grand of scale usurpation under corporate veils with one goal to date: to still, kill, destroy and enslave Almighty God's covenanted people, the American nations of states of people.
- b) The present defacto corporate government, in the order for to sustain its deception to govern, postures and administrates under the auspices of the Original Jurisdiction, as a corporation titled: UNITED STATES, INC. a federal corporation defined by its own statute(s) as a federal corporation in the nature of Title 28 USC 3002 (15), as: commercial entity implementing a corporate policy called "public policy." And, for reasons beyond the scope of this statement is defacto government under the Original Jurisdiction, under "united States of America," and the constitution thereto, by default.
- c) The "UNITED STATES" government corporation, however referred to today, is not synonymous to "The united States of America" government de jure of the original authority and assemblage. Identically, the "UNITED STATES CONSTITUTION" is not synonymous to "The Constitution for the united States of America"; to wit: UNITED STATES CONSTITUTION is in fact the/a corporate by-laws statement of the said corporation, and is inherently mere corporate policy.
- 9) Consequently: Original Jurisdiction cannot be in conflict with itself; to wit: Almighty God made man in original jurisdiction, a) under Him, and b) over the earth and all of the substance, and c) reserving to Himself jurisdiction over man in total.
- 10) Natural people *de jure* are people under the God Almighty above all of the subsequent elements of the Original Jurisdiction; to wit: Beverly-Jean: Romero- Hill, et al.: people are the authority under-which the construct of the state nations and of the The Constitution for the United States of America are conceived and mandated, and are thereto obliged. People, therefore, are inherently superior to the present de facto UNITED STATES' corporate fiction by its own admission(s). Accordingly, by this political election: Beverly-Jean: Romero- Hill de jure is not politically subject to the corporate construct(s) for a sundry reasons, such as evidenced in the nature of the unconscionable Federal Reserve Bank Act of December 23, 1913 CE.
- 11) Notwithstanding, the permittant non-reestablishment of the de jure Governance of the Original Jurisdiction, and, thereby, of the matter(s) of the persistent enabling and support of the massive fraud(s) upon the people by the founding predecessors and present actors of the defacto UNITED STATES corporate government, includes:
- a) abetting of the same deception upon the natural people de jure; to wit: Beverly-Jean: Romero- Hill, et al.:

2022-011769 MISC Page: 396 of 2782

09/26/2022 03:35:37 PM Receipt #: 22-9381

Rec Fee: \$30.00 Darrell James Hill
Gila County, Az, Sadie Jo Bingham, Recorder



398

Political Status Election: Affirmation In Confirmation of Sovereign

[INTENTIONALLY LEFT BLANK]

2022-011769 MISC Page: 397 of 2782
09/26/2022 09:35:37 PM Receipt #: 22-9381
Rec Fee: \$30.00 Darrell James Hill
Gila County, Az, Sadie Jo Bingham, Recorder

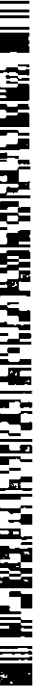

10 of 20
22

Political Status Election: Affirmation In Confirmation of Sovereign

397

Unofficial Copy



Political Status Election: Affirmation In Confirmation of Sovereign

- b) protection of the extraordinary and persistent UNITED STATES corporate policy of covin, conspiracy, and collusion constructed and condoned by the present day UNITED STATES corporation and actor(s), pursuant from, in the nature of the 20th Amendment to the UNITED STATES Constitution; and:
- c) subsequent Corporate and complicit agent acts including, but not limited to: progressive development of the Cestui Que Trust: entitled: BEVERLY JEAN ROMERO- HILL, for the feigned benefit of the natural born American citizenry Beverly-Jean: Romero- Hill, "Secured Party", while implementing a patent systematic usufruct of the same people's trusts for the profit: power, prestige and privilege for egotistical gain while imposing the most massive abuse upon the trust beneficiaries, the American citizenry.

AUTHORITY

I: Beverly-Jean: Romero- Hill have all of the authority as a man under the God Almighty to establish this political election and dispel all of the contrary presumptions by the any actor(s), including, but not limited to the commercial entities mentioned/ referred to in this document, this: presumption is set. Furthermore: fidelity of the constitutional integrity of every UNITED STATES agency, and the any of the officer(s)/actor(s) thereof, are under the Constitution for the united States of America under Almighty God. Therefore: any commercial entity or actor with which Beverly-Jean: Romero- Hill may make acquaintance and/ or come into contact shall heretofore instantly seek and protect Beverly-Jean: Romero- Hill's every Right(s) and Remedy(ies) and interest(s) within the direct obedience under Almighty God under the Constitutional oath of their office which is under duty to The Constitution for the united States of America, to the service and protection: Beverly-Jean: Romero- Hill; to wit:

KJV: Book: Exodus 20:1 And God spake all these words, saying, 20:2 I *am* the LORD thy God, which have brought thee out of the land of Egypt, out of the house of bondage. 20:3 Thou shalt have no other gods before me. 20:4 Thou shalt not make unto thee any graven image, or any likeness of *any thing* that *is* in heaven above, or that *is* in the earth beneath, or that *is* in the water under the earth: 20:5 Thou shalt not bow down thyself to them, nor serve them: for I the LORD thy God *am* a jealous God, visiting the iniquity of the fathers upon the children unto the third and fourth *generation* of them that hate me; 20:6 And shewing mercy unto thousands of them that love me, and keep my commandments. 20:7 Thou shalt not take the name of the LORD thy God in vain; for the LORD will not hold him guiltless that taketh his name in vain. 20:8 Remember the sabbath day, to keep it holy. 20:9 Six days shalt thou labour, and do all thy work: 20:10 But the seventh day *is* the sabbath of

2022-011769 MISC Page: 398 of 2782
 09/26/2022 03:35:37 PM Receipt #: 22-9381
 Rec Fee: \$30.00 Darrell James Hill
 Gila County, Az, Sadie Jo Bingham, Recorder



400

Political Status Election: Affirmation In Confirmation of Sovereign

[INTENTIONALLY LEFT BLANK]

2022-011769 MISC Page: 399 of 2782
09/26/2022 03:35:37 PM Receipt #: 22-9981
Rec Fee: \$30.00 Darrell James Hill
Gila County, Az, Sadie Jo Bingham, Recorder



12 of 20

Political Status Election: Affirmation In Confirmation of Sovereign

401

[Handwritten signatures and scribbles]

Unofficial Copy



Political Status Election: Affirmation In Confirmation of Sovereign

the LORD thy God: *in it* thou shalt not do any work, thou, nor thy son, nor thy daughter, thy manservant, nor thy maidservant, nor thy cattle, nor thy stranger that *is* within thy gates: 20:11 For *in* six days the LORD made heaven and earth, the sea, and all that in them *is*, and rested the seventh day: wherefore the LORD blessed the sabbath day, and hallowed it. 20:12 Honour thy father and thy mother: that thy days may be long upon the land which the LORD thy God giveth thee. 20:13 Thou shalt not kill. 20:14 Thou shalt not commit adultery. 20:15 Thou shalt not steal. 20:16 Thou shalt not bear false witness against thy neighbour. 20:17 Thou shalt not covet thy neighbour's house, thou shalt not covet thy neighbour's wife, nor his manservant, nor his maidservant, nor his ox, nor his ass, nor any thing that *is* thy neighbour's[;] to wit:

KJV: Book: Proverbs-Chapter 17:15 He that justifieth the wicked, and he that condemneth the just, even they both *are* abomination to the LORD... 17:23 A wicked *man* taketh a gift out of the bosom to pervert the ways of judgment. Chapter 18:5 *It is* not good to accept the person of the wicked, to overthrow the righteous in judgment. Chapter 20:10 Divers weights, and divers measures, both of them *are* alike abomination to the LORD. 20:25 *It is* a snare to the man *who* devoureth *that which is* holy, and after vows to make enquiry.

“The law will protect an individual who, in the prosecution of a right does everything which the law requires him to do but fails to obtain his right by the misconduct or neglect of a public officer.” See in the nature of Lyle v. Arkansas, 9 Howe 314, 13 L. Ed 153; Duluth & Iron Range Co. v. Roy, 173 U.S. 587, 19 S. Ct 549, 43 L. Ed 820.

“It is a maxim of the law, admitting few if any exceptions, that every duty laid upon a public officer for the benefit of a private person, is enforceable by judicial process”. See in the nature of Butterworth v. U.S. ex rel. Hoe, 112 U.S. 50, 5 S. Ct 25, 28 L. Ed 656.

I: Beverly-Jean: Romero- Hill have all of the authority, and of the duty, to examine from the any where is the authority of the any one claiming to represent the any government at the any level; to wit:

KJV: Book: 1 John-Chapter 4:1 Beloved, believe not every spirit, but try the spirits whether they are of God: because many false prophets are gone out into the world. 4:2 Hereby know ye the Spirit of God: Every spirit that confesseth that

2022-011769 MISC Page: 400 of 2782
09/26/2022 03:35:37 PM Receipt #: 22-9381
Rec Fee: \$30.00 Darrell James Hill
Gila County, Az, Sadie Jo Bingham, Recorder

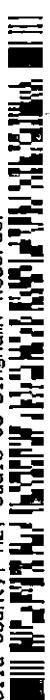

402
1000
[Handwritten scribbles]

Political Status Election: Affirmation In Confirmation of Sovereign

[INTENTIONALLY LEFT BLANK]

2022-011769 MISC Page: 401 of 2782
09/26/2022 08:35:37 PM Receipt #: 22-9381
Rec Fee: \$30.00 Darrell James Hill
Gila County, Az, Sadie Jo Bingham, Recorder



40B
Hill

Political Status Election: Affirmation In Confirmation of Sovereign



14 of 20

22

Handwritten notes:
Bingham
Hill James

Unofficial Copy



Political Status Election: Affirmation In Confirmation of Sovereign

Jesus Christ is come in the flesh is of God: 4:3 And every spirit that confesseth not that Jesus Christ is come in the flesh is not of God: and this is that *spirit* of antichrist, whereof ye have heard that it should come; and even now already is it in the world.

Notification of the legal responsibility is "the first essential of due process of law." See in the nature of *Connally v. General Construction Co.*, 269 U.S. 385, 391.

"Silence can only be equated with fraud where there is a legal or moral duty to speak or when an inquiry left unanswered would be intentionally misleading." See in the nature of *U.S. v. Tweel*, 550 F.2d.297.

It is in the ministerial fiduciary/trustee duty of the each and every government official, officer, agent, contractor and assign of the UNITED STATES, and of its derivatives; to wit: STATE OF ARIZONA, ET SEQ., Federal Reserve Banks/System, International Monetary Fund, International Finance Corporation, International Bank for Reconstruction and Development, Inter-American Development Bank, World Bank, Commission of the European Communities, Organization for Economic Co-operation and Development, United Nations, and of the any and all other agent(s) who view of this notice, "Respondent(s)" to timely and fully answer. See in the nature of *Federal Crop Insurance v. Merrill*, 332 U.S. 380, 92 L. Ed 10, 68 S.Ct 1,(1947) 175 ALR 1075.

ORDERS:

- 1) The presumption is set that: Beverly-Jean: Romero- Hill is a natural man born of the family Romero and then after named to be: Beverly-Jean shall not be presumed to be the surety for the stramineus homo title in the form of "BEVERLY JEAN ROMERO-HILL," also known by the any and all of the derivatives and variations in the spelling of the said name except: "Beverly-Jean: Romero- Hill".
- 2) The Claim of Cestui Que Trust entitled BEVERLY JEAN ROMERO- HILL is set that: command of the beneficial interest: Beverly-Jean: Romero- Hill: the natural man is now herein identified.
- 3) Idem Sonans is Disallowed is set: Cease and desist all of the use of a doctrine of *idem sonans* by any actor to effect any presumption or scheme reproaching Beverly-Jean: Romero- Hill's inherent sovereignty Rights. Such actions are prohibited and admittedly willful constructive fraud, and constitutes admission of the same in the non-judicial venue enforceable against the entity, et al., by the secured party through tacit procurement.
- 4) Notice to the principal is notice to all of the agent(s). Notice to the agent is notice to all of the principals

2022-011769 MISC Page: 402 of 2782

09/25/2022 03:35:37 PM Receipt #: 22-9381

Rec Fee: \$30.00 Darrell James Hill

Gila County, Az, Sadie Jo Bingham, Recorder



Political Status Election: Affirmation In Confirmation of Sovereign

[INTENTIONALLY LEFT BLANK]

2022-011769 MISC Page: 403 of 2782
 09/26/2022 09:35:37 PM Receipt #: 22-9381
 Rec Fee: \$30.00 Darrell James Hill
 Gila County, Az, Sadie Jo Bingham, Recorder



Political Status Election: Affirmation In Confirmation of Sovereign



16 of 20

403

22

Darrell Hill

Unofficial Copy

Political Status Election: Affirmation In Confirmation of Sovereign

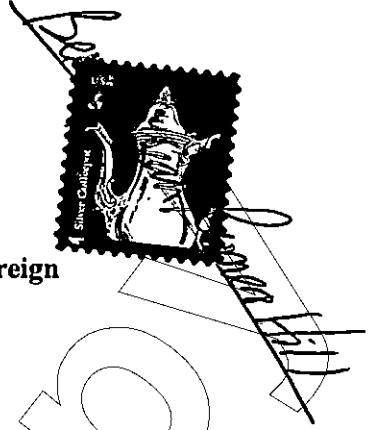

Enclosure-1

- a) Notarial Acknowledgment of Authentic "CERTIFICATE OF BIRTH"
- b) copy of CERTIFICATE OF BIRTH, STATE OF NEW MEXICO
- c) Notarial Acknowledgment of Original "Arizona Driver License"
- d) copy of "Arizona Driver License"

2022-011759 MISC Page: 404 of 2782
09/26/2022 03:35:37 PM Receipt #: 22-9381
Rec Fee: \$30.00 Darrell James Hill
Gila County, Az, Sadie Jo Bingham, Recorder



Political Status Election: Affirmation In Confirmation of Sovereign

[INTENTIONALLY LEFT BLANK]

2022-0111769 MISC Page: 405 of 2782
09/26/2022 09:35:37 PM Receipt #: 22-9381
Rec Fee: \$30.00 Darrell James Hill
Gila County, Az, Sadie Jo Bingham, Recorder



18 of 22

Political Status Election: Affirmation In Confirmation of Sovereign

407

Unofficial Copy

SECURITY AGREEMENT BJR001-SA 06252015-SA CE
Non-Negotiable – Private Agreement Between two Parties



ENCLOSURE-2

Private Agreement: BJR001-PA

Unofficial Copy

2022-011769 MISC Page: 406 of 2782
09/25/2022 03:35:37 PM Receipt #: 22-9981
Rec Fee: \$30.00 Darrell James Hill
Gila County, Az, Sadie Jo Bingham, Recorder



408

SECURITY AGREEMENT BJR001-SA 06252015-SA CE
Non-Negotiable – Private Agreement Between two Parties

Unofficial Copy

INTENTIONALLY LEFT BLANK

2022-011769 MISC Page: 407 of 2782
09/26/2022 03:35:37 PM Receipt #: 22-9381
Rec Fee: \$30.00 Darrell James Hill
Gila County, Az, Sadie Jo Bingham, Recorder



Pat



56 of 68

Patricia Hill

SECURITY AGREEMENT BJR001-SA 06252015-SA CE

409

Private Agreement: BJR001-PA 06252015-PA CE
Non-Negotiable – Private Between the Parties:

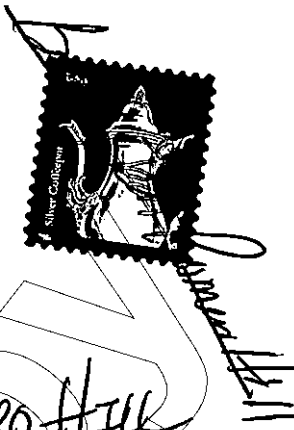

L.S. BEVERLY JEAN ROMERO HILL

L.S. Beverly Jean Romero Hill

DEBTOR:

BEVERLY JEAN ROMERO- HILL
C/O 5124 East 18th Avenue
Apache Junction, Arizona 85119

CREDITOR:

Beverly-Jean: Romero- Hill
C/O General Delivery
Apache Junction MPO
Apache Junction, Arizona [851209998]

1 This: **Private Agreement** is in regards to the mutually agreed upon and entered into contract:
2 06252015-PA CE between the commercial person: BEVERLY JEAN ROMERO- HILL, also
3 known by the any and all of the linear derivatives and variations in the spelling of the said name
4 except: "Beverly-Jean: Romero- Hill", hereinafter jointly and severally "DEBTOR," and: real
5 man, sui juris, living on the ground beyond the sea: natural, biological, spiritual, and soulful man
6 in the understanding of the Almighty God, to wit: "Beverly-Jean: Romero- Hill", hereinafter the
7 "SECURED PARTY."

8 This: contract by the DEBTOR AND SECURED PARTY is for the consideration(s); to wit:

9 **A) SECURED PARTY:**

10 SECURED PARTY agrees to serve in the administrative capacity of the Controlling Creditor and/
11 Entitlement Holder in the commercial concerns of the DEBTOR, and to provide: substance of the
12 animus in the natural person American born relationship in the distinction to the DEBTOR
13 commercial person; to wit:

14 SECURED PARTY shall:

15 a) constitute: source, origin, substance, and natural being of the any "preexisting claim"
16 from where of the derivative existence of the DEBTOR is affirmed;

17 b) constitute: source of the DEBTOR's asset identity, via the natural existence and
18 animation, and of the all of the faculties of the labor of the Controlling Creditor or Entitlement
19 Holder or SECURED PARTY for the any support of the any contract whatsoever that: DEBTOR
20 may execute, and for the any involvement for all of that which is of the whatever may be
21 wherein the DEBTOR may be regarded as bound;

22 c) serve: basis of the "Authorized Representative" for the DEBTOR interacting,
23 facilitating, contracting, and exchanging of the goods and services in all of the areas involving:

2022-011769 MISC Page: 408 of 2782
09/26/2022 03:35:37 PM Receipt #: 22-9981
Rec Fee: \$30.00 Darrell James Hill
Gila County, Az, Sadie Jo Bingham, Recorder



410

Private Agreement: BJR001-PA 06252015-PA CE
Non-Negotiable – Private Between the Parties:

1

[INTENTIONALLY LEFT BLANK]

2022-011769 MISC Page: 409 of 2782
09/26/2022 03:35:37 PM Receipt #: 22-9381
Rec Fee: \$30.00 Darrell James Hill
Gila County, AZ, Sadie Jo Bingham, Recorder



2 of 8

PRIVATE AGREEMENT BJR001-PA 06252015-PA CE

Unofficial Copy

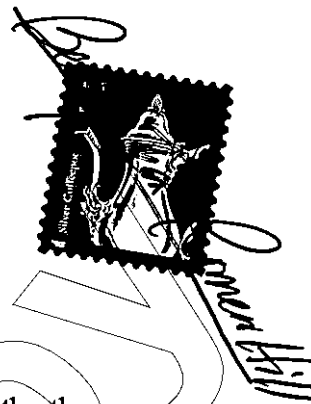

Private Agreement: BJR001-PA 06252015-PA CE
Non-Negotiable – Private Between the Parties:

1 natural administrative aspects, and touching upon the engagements and obligations with other
2 Authorized Representatives;

3 d) provide for the safety for all of the payments of the all of the sums now due and owing,
4 and as might become due and owed by the DEBTOR;

5 **B) DEBTOR:**

6 DEBTOR is to serve in the commercial Transmitting Utility of the stramineus homo construct
7 germane to the DEBTOR's original creation and purpose; to wit:

8 DEBTOR shall:

9 a) function to serve in the capacity of the transmitting utility for the benefit of the
10 Controlling Creditor and/or Entitlement Holder and/or SECURED PARTY;

11 b) indemnify, defend, and hold harmless: Controlling Creditor and Entitlement Holder and
12 SECURED PARTY from and against the any and all of the any liability, claims, demands, orders,
13 summonses, warrants, judgments, damages, costs, losses, liens, levies, depositions, lawsuits, legal
14 actions, penalties, fines, interests, and expenses whatsoever, both absolute and contingent, due and
15 as might become due, now existing and hereafter arising, howsoever evidenced, suffered, incurred
16 by, and imposed onto the DEBTOR, and that for whatever reason, purpose, and cause whatsoever;
17 including but not limited to:

18 (i) acknowledging, consenting and agreeing to forever insulate: Controlling Creditor or
19 Entitlement Holder or SECURED PARTY when/if ever: SECURED PARTY may be
20 considered or presumed to be he DEBTOR, or considered to be the accommodation
21 party, or surety, for the DEBTOR.

22 Terms Defined; Glossary of Terms. As used in this Private Agreement, the following words and
23 terms are as defined in the Terms Defined section of the Security Agreement BJR001-SA 06252015
24 CE, non obstante.

25 For the Babel Communications: The content of this document is written nunc pro tunc in the babel
26 language communication style common on the day of this document, as distinguished against
27 Complete-Sentence-Sense-Parse-Syntax-Grammar, "CSSPSG" context communication. Any
28 translation and/or interpretation shall be contextually construed in accordance with the meaning
29 intended by the writer.

30 **This: agreement is for a continuing Private Agreement which perpetuates in the any of the**
31 **event or effect of the Parties unto the disposes of the estate by the Power of Attorney for the**
32 **SECURED PARTY.**

412



Private Agreement: BJR001-PA 06252015-PA CE
Non-Negotiable – Private Between the Parties:

Unofficial Copy

1

[INTENTIONALLY LEFT BLANK]

2022-011769 MISC Page: 411 of 2782
09/25/2022 03:35:37 PM Receipt #: 22-9381
Rec. Fee: \$30.00 Darrell James Hill
Gila County, Az, Sadie Jo Bingham, Recorder



413

PRIVATE AGREEMENT BJR001-PA 06252015-PA CE

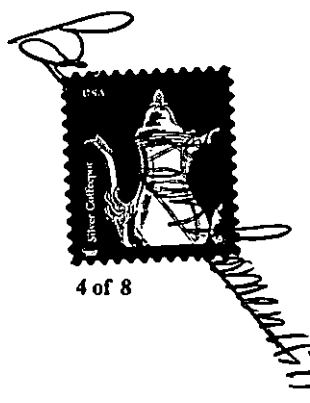

4 of 8

Private Agreement: BJR001-PA 06252015-PA CE
Non-Negotiable – Private Between the Parties:

1414
11/11

1 This: Private Agreement: BJR001-PA 06252015-PA CE

2 DEBTOR: Transmitting Utility,

3 BEVERLY JEAN ROMERO HILL

4 BEVERLY JEAN ROMERO- HILL

STATE OF ARIZONA

COUNTY OF MARICOPA

5 ON this 28th day of June, 2015 A.D., by me, a notary public in and for the said STATE OF
6 ARIZONA, residing therein, duly commissioned and sworn, personally appeared BEVERLY JEAN
7 ROMERO- HILL, satisfactorily proved to me upon the presentation of sufficient documentation to be
8 the person described in and who executed the within instrument. Witness my hand and seal this

9 28th day of June, 2015.



KALLE KIVINEN
Notary Public - Arizona
Maricopa County
Expires on 08/15/2016

10 Notary

[Signature]

My Commission Expires 8-15-2016

Unofficial Copy

2022-011769 MISC Page: 412 of 2782

09/26/2022 03:35:37 PM Receipt #: 22-9381
Rec Fee: \$30.00 Darrell James Hill
Gila County, Az, Sadie Jo Bingham, Recorder



1414

Private Agreement: BJR001-PA 06252015-PA CE
Non-Negotiable – Private Between the Parties:

Unofficial Copy

1

[INTENTIONALLY LEFT BLANK]

415

PRIVATE AGREEMENT BJR001-PA 06252015-PA CE

Handwritten signature

Handwritten signature

6 of 8

2022-011769 MISC Page: 413 of 2782
09/26/2022 03:35:37 PM Receipt #: 22-9381
Rec Fee: \$30.00 Darrell James Hill
Gila County, Az, Sadie Jo Bingham, Recorder

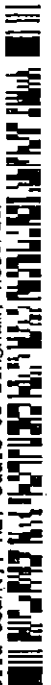

Private Agreement: BJR001-PA 06252015-PA CE
Non-Negotiable – Private Between the Parties:

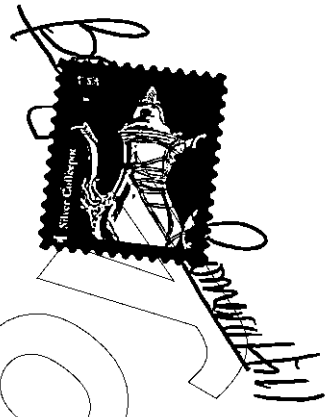

1 **Acceptance By The Secured Party:**
2 Entitlement Holder or SECURED PARTY accepts: DEBTOR's signature in accordance with the
3 UCC §§ 1-201(37) (2001 CE), 3-401 (2002 CE), and accepts for the value to this Security
4 Agreement and any: DEBTOR's herein-above- described/ itemized Collateral.

(SECURED PARTY's Signature)

Without prejudice: UCC 1-308

Beverly Jean Romero-Hill
SECURED PARTY:

5
6
7
8
9 **Arizona state territory:**

10 **Witness of Signor:**

11 I: man upon the ground, a sojourner in the Arizona state territory beyond the sea on this 28 day of the
12 June month in the year anno domini two thousand fifteen, am. And, after the witnessing of
13 the Beverly-Jean: Romero- Hill's applying her signature onto this document, I affirm same by my
14 signature to the fact that: 1) I witnessed: Beverly-Jean: Romero- Hill applying her signature to the
15 document; and, 2) I know: Beverly-Jean: Romero- Hill personally.

Witness: Jeff Angold date 6-28-15

Witness: Jeffrey Paul Aron date 6/28/2015

Witness: Virginia L. Green 6/28/15 date

L.S. BEVERLY JEAN ROMERO-HILL

L.S. Beverly Jean Romero-Hill

PRIVATE AGREEMENT

2022-011769 MISC Page: 414 of 2782
09/26/2022 03:35:37 PM Receipt #: 22-9381
Rec Fee: \$30.00 Darrell James Hill
Gila County, Az, Sadie Jo Bingham, Recorder



Umo office

416

Private Agreement: BJR001-PA 06252015-PA CE
Non-Negotiable – Private Between the Parties:

Unofficial Copy

[INTENTIONALLY LEFT BLANK]

1

417

PRIVATE AGREEMENT BJR001-PA 06252015-PA CE

2022-011769 MISC Page: 415 of 2782
09/26/2022 03:35:37 PM Receipt #: 22-9381
Rec Fee: \$30.00 Darrell James Hill
Gila County, Az, Sadie Jo Bingham, Recorder



8 of 8

11/24/2022 Hill

Political Status Election: Affirmation In Confirmation of Sovereign



Acceptance By The Debtor Party:

SECURED PARTY's signature in accordance with the UCC §§ 1-201(37) (2001 CE), 3-401 (2002 CE), and accepts for the value to this Security Agreement and all: SECURED PARTY's herein-above- described AUTHORITY(S).

Beverly Jean Romero-Hill
BEVERLY JEAN ROMERO- HILL

STATE OF ARIZONA

COUNTY OF MARICOPA

ON this 28th day of June, 2015 A.D., by me, a notary public in and for the said STATE OF ARIZONA, residing therein, duly commissioned and sworn, personally appeared BEVERLY JEAN ROMERO- HILL, satisfactorily proved to me upon the presentation of sufficient documentation to be the person described in and who executed the within instrument. Witness my hand and seal this

28th day of JUNE, 2015.



KALLE KIVINEN
Notary Public - Arizona
Maricopa County
Expires on 08/15/2016

Notary [Signature]

My Commission Expires 8-15-2016

L.S. Beverly Jean Romero-Hill

2022-011769 MISC Page: 416 of 2782
09/26/2022 03:35:37 PM Receipt #: 22-9381
Rec Fee: \$30.00 Darrell James Hill
Gila County, Az, Sadie Jo Bingham, Recorder

418

Political Status Election: Affirmation In Confirmation of Sovereign

[INTENTIONALLY LEFT BLANK]

2022-011769 MISC Page: 417 of 2782
09/26/2022 03:35:37 PM Receipt #: 22-9381
Rec Fee: \$30.00 Darrell James Hill
Gila County, Az, Sadie Jo Birmingham, Recorder



Handwritten: 419
Handwritten: 11/18/22
Handwritten: [Signature]



22 of 22

Unofficial Copy

Political Status Election: Affirmation In Confirmation of Sovereign

[INTENTIONALLY LEFT BLANK]

2022-011769 MISC Page: 419 of 2782
09/26/2022 03:35:37 PM Receipt #: 22-9381
Rec Fee: \$30.00 Darrell James Hill
Gila County, Az, Sadie Jo Birmingham, Recorder



20 of 22

Political Status Election: Affirmation In Confirmation of Sovereign

421

Unofficial Copy

11/27/2022

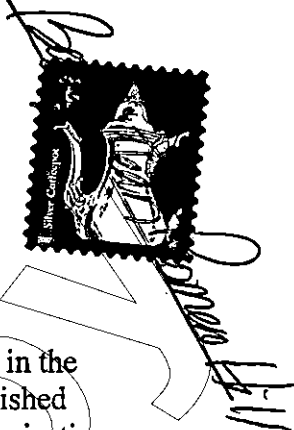

Political Status Election: Affirmation In Confirmation of Sovereign

For the Babel Communications: The content of this document is written nunc pro tunc in the babel language communication style common on the day of this document, as distinguished against Complete-Sentence-Sense-Parse-Syntax-Grammar, "CSSPSG" context communication. Any translation and/or interpretation shall be contextually construed in accordance with the meaning intended by the writer.

CHOSE IN ACTION IS EXECUTED: Affirmation In Confirmation of Political Status Election; and by this execution, so be it done.

Beverly Jean Romero-Hill 6/28/15
SECURED PARTY

Arizona state territory:

Witness of Signor:

I: man upon the ground, a sojourner in the Arizona state territory beyond the sea on this 28 day of the June month in the year anno domini two thousand fifteen, am. And, after the witnessing of the Beverly-Jean: Romero- Hill's applying her signature onto this document, I affirm same by my signature to the fact that: 1) I witnessed: Beverly-Jean: Romero- Hill applying her signature to the document; and, 2) I know: Beverly-Jean: Romero- Hill personally.

Witness: [Signature] date 6-28-15

Witness: [Signature] date 6/28/2015

Witness: [Signature] date 6/28/15

2022-011769 MISC Page: 418 of 2782
09/26/2022 03:35:37 PM Receipt #: 22-9381
Rec Fee: \$30.00 Darrell James Hill
Gila County, Az, Sadie Jo Bingham, Recorder



420

**NOTARIAL ACKNOWLEDGMENT
OF ORIGINAL AUTHENTIC BIRTH CERTIFICATE**

THIS DOCUMENT IS NOT AUTHENTIC UNLESS PRODUCED ON SECURITY PAPER

**CERTIFICATE OF BIRTH
CERTIFICADO DE NACIMIENTO**

STATE OF NEW MEXICO **NEW MEXICO** ESTADO DE NUEVO MEXICO
New Mexico Vital Records and Health Statistics **HEALTH** Registros Vitales y Estadísticas de Salud de Nuevo Mexico
Public Health Division Division de Salud Publica

I certify that the following birth is registered in the New Mexico Vital Records and Health Statistics.
Certifico que en la Seccion del Registro de Nacimientos a mi cargo aparece la siguiente inscripcion.

File No. / Numero de Archivo	Request No. / Numero de Solicitud	County of Birth / Condado de Nacimiento
[REDACTED]	[REDACTED]	[REDACTED]
Date of Birth / Fecha de Nacimiento	Date of Registration / Fecha de Inscripcion	Sex / Sexo
[REDACTED]	[REDACTED]	FEMALE
Name of Person Registered / Nombre del Escrito		
Beverly Jean Romero		
Name of Father or Parent / Nombre del Padre		
[REDACTED]		
Birth Name of Mother or Parent / Nombre de Sotero de la Madre		
[REDACTED]		

WARNING: IT IS ILLEGAL TO COPY OR COUNTERFEIT THIS CERTIFICATE.
ADVERTENCIA: ES ILLEGAL ALERAR, COPIAR O FALSIFICAR ESTE CERTIFICADO

Donna Dorsey
SIGNATURE OF STATE REGISTRAR
REGISTRAR DEL ESTADO DE NUEVO MEXICO

DO NOT DUPLICATE BY ANY MEANS

**STATE OF ARIZONA
COUNTY OF MARICOPA**

ON this 28th day of June, 2015 A.D., by me, a notary public in and for the said STATE OF ARIZONA, residing therein, duly commissioned and sworn, personally appeared and upon the presentation of sufficient documentation satisfactorily proved to me to be the person BEVERLY JEAN ROMERO- HILL, and who provided to me a document from the STATE OF NEW MEXICO for notarial acknowledgment.

The document is on repetitively stated "NEW MEXICO VITAL RECORDS" throughout, with an other state seal type of inclusion, watermark safety paper; surrounded by a border presumed to be unique to the STATE OF NEW MEXICO bond paper; and, entitled in both english and spanish languages, "CERTIFICATE OF BIRTH, STATE OF NEW MEXICO, New Mexico Vital Records and Health Statistics, Public Health Division". Following, the document contains a certification statement for the birth record information enclosed in the form; then then record is signed in the lower right corner by a "SIGNATURE OF THE STATE REGISTRAR" in mostly legible cursive, Donna Dorsey.

The document content information: "File N [REDACTED]", "Request No [REDACTED]", "County of Birth RIO ARRIBA", "Date of Birth [REDACTED]", "Name of Person Registered BEVERLY JEAN ROMERO", "Name of Father DELBERTO CROMBIE", "Birth Name of Mother [REDACTED]". Following, at the bottom of the form is a number in red color [REDACTED], then next over in the bottom middle is "GREAT SEAL OF THE STATE OF NEW MEXICO" before the registrar's signature of the bottom right of the document.

I acknowledge this document as authentic.

Witness my hand and seal this

28th day of JUNE, 2015.

Notary

My Commission Expires 8-15-2016



KALLE KIVINEN
Notary Public - Arizona
Maricopa County
Expires on 08/15/2016

Page: 420 of 2782

2022-011769 MISC 09/26/2022 03:35:37 PM Receipt #: 22-9381
James Hill
Reg Fee: \$30.00 Darrell Jo Bingham, Recorder
Gila County, Az, Sadie Jo Bingham, Recorder



NOTARIAL ACKNOWLEDGMENT
OF ORIGINAL, AUTHENTIC, BIRTH CERTIFICATE

[REDACTED]

[INTENTIONALLY LEFT BLANK]

423

[REDACTED]

413

[Handwritten signature]



[Handwritten signature]

Official Copy

NOTARIAL ACKNOWLEDGMENT
OF ORIGINAL, AUTHENTIC, ARIZONA, Driver License

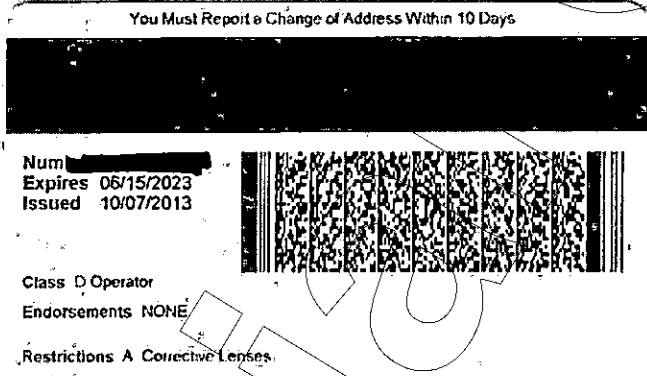
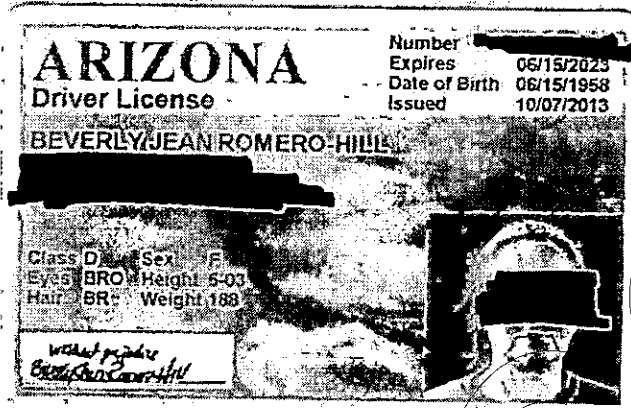

STATE OF ARIZONA
COUNTY OF MARICOPA

ON this 28th day of June, 2015 A.D., by me, a notary public in and for the said STATE OF ARIZONA, residing therein, duly commissioned and sworn, personally appeared and upon the presentation of sufficient documentation satisfactorily proved to me to be the person BEVERLY JEAN ROMERO-HILL, and who provided to me a document from the STATE OF ARIZONA for notarial acknowledgment.

The document is set upon a sky-mountain background picture, is entitled "ARIZONA, DRIVER LICENSE" in the upper left corner with repetitively distributed throughout the card a 'state-shaped-picture with the words "CANYON" following. The document is signed in the lower left corner, with a likeness picture of the presumed signer in the lower right corner. The picture in the right lower corner is a reasonable facsimile of Beverly-Jean: Romero- Hill.

The right upper corner document content information is: "Num [redacted]; Expires 06/15/2023; Date of Birth 06/15/1958; Issued 10/07/2013.

The middle document content information is: "BEVERLY JEAN ROMERO-HILL with a following address location, below which is a description of a person, and below which is a signum in a white box at the left base of the card document.

I acknowledge this document as authentic.

Witness my hand and seal this

28th day of JUNE, 2015.



KALLE KIVINEN
Notary Public - Arizona
Maricopa County
Expires on 08/15/2016

Notary

My Commission Expires

8-15-2016



424

**NOTARIAL ACKNOWLEDGMENT
OF ORIGINAL, AUTHENTIC, ARIZONA, Driver License**

[INTENTIONALLY LEFT BLANK]

2022-011769 MISC Page: 423 of 2782
09/26/2022 03:35:37 PM Receipt #: 22-9381
Rec Fee: \$30.00 Darrell James Hill
Gila County, Az, Sadie Jo Bingham, Recorder



Handwritten signature

425

Unofficial Copy

SECURITY AGREEMENT BJR001-SA 06252015-SA CE
Non-Negotiable – Private Agreement Between two Parties

[INTENTIONALLY LEFT BLANK]

428

[Signature]

[Signature]



SECURITY AGREEMENT BJR001-SA 06252015-SA CE

58 of 68

2022-011769 MISC Page: 424 of 2782
09/26/2022 03:35:37 PM Receipt #: 22-9381
Rec Fee: \$30.00 Darrell James Hill
Gila County, Az, Sadie Jo Bingham, Recorder



**SECURITY AGREEMENT BJR001-SA 06252015-SA CE
Non-Negotiable – Private Agreement Between two Parties**

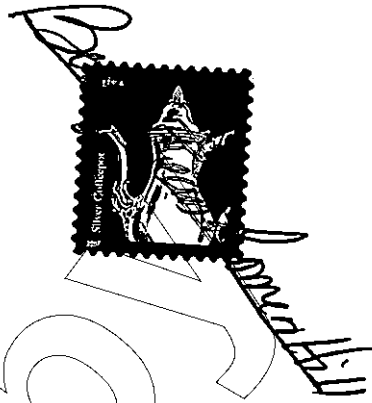

ENCLOSURE-3

Trade-name and Trade-mark, Notice and Agreement: BJR001-TN

2022-011769 MISC Page: 425 of 2782

09/26/2022 03:35:37 PM Receipt #: 22-9381

Rec Fee: \$30.00 Darrell James Hill

Gila County, Az, Sadie Jo Bingham, Recorder



427



**Trade-name and Trade-mark
Notice and Agreement
BJR001-TN 06252015-TN CE**

L.S. BEVERLY JEAN ROMERO HILL
L.S. Beverly Jean Romero Hill

Trade-name and Trade-mark Notice and Agreement

1 All of the rights reserved are in regards to the "BEVERLY JEAN ROMERO- HILL", as well as
2 of the any and all of the derivatives and variations in the spelling(s) referring to the same name
3 and mark; to wit: Trade-name and Trade-mark, a name and signum similarly identical to the
4 stramineus homo entity "BEVERLY JEAN ROMERO- HILL" which established the Trade-
5 name and Trade-mark, and, is as relates to the secured party and particulars thereto in this Trade-
6 name/Trade-mark Notice and Agreement constituted by the natural person, to wit: Beverly-Jean:
7 Romero- Hill, hereinafter "SECURED PARTY."

8 Authorized Use of the Trade-name/Trade-mark:

9 Use of the said Trade-name or Trade-mark in the whole or in the part, or in the any manner
10 whatsoever, is prohibited without the prior express written consent as indicated by the SECURED
11 PARTY's signature in a red ink; to wit: any commercial person, or another person, or of the
12 actors of the any of the said person(s), who with the intent of the being contractually bound,
13 consent and agree to be bound by this Trade-name/Trade-mark Notice and Agreement in the
14 agreement to neither display, nor use in the any manner: Trade-name/Trade-mark presented
15 herein, including to not use the any of the derivatives in the spelling or in the idem sonans with
16 reference to the same without the prior, express, written consent and acknowledgment from the
17 Secured Party.

18 Agreement in the Event of the Unauthorized Use:

19 **NOTICE AND WARNING:**

20 Unauthorized user of the Trade-name/Trade-mark by any commercial person, or by another person,
21 or by the actors for the said person(s), hereinafter jointly and severally "User," agree that neither by
22 the any User, nor by the actor of the said User, shall there be displayed or used in the any manner:
23 Trade-name or Trade-mark presented herein, to wit: BEVERLY JEAN ROMERO- HILL, or the
24 any variation thereof, or the any derivative of the said name referring to same, without the prior,
25 express, written consent of the SECURED PARTY, as signified by the SECURED PARTY's
26 signature in a red ink. Per either vehicle, that is, by use of the published Trade-name and Trade-
27 mark Notice: NOTICE AND WARNING herein, or of the SECURITY AGREEMENT BJR001-
28 SA 06252015-SA: NOTICE AND WARNING; unauthorized use of the BEVERLY JEAN
29 ROMERO- HILL by the any User or by the any actor of the said User constitutes the sure consent
30 and concomitant agreement that the any use of the BEVERLY JEAN ROMERO- HILL by any
31 method other than that of the authorized use as set forth herein, or following by the SECURED
32 PARTY's delivered NOTICE -by a written communication- , evidences: User's tacit and indirect
33 agreement or consent and confession to transferring to the SECURED PARTY: all of the authority

428

2022-011769 MISC Page: 426 of 2782
09/26/2022 03:35:37 PM Receipt #: 22-9381
Rec Fee: \$30.00 Darrell James Hill
Gila County, Az, Sadie Jo Bingham, Recorder

**Trade-name and Trade-mark
Notice and Agreement
BJR001-TN 06252015-TN CE**

1

[INTENTIONALLY LEFT BLANK]

2022-011769 MISC Page: 427 of 2782
09/26/2022 03:35:37 PM Receipt #: 22-9981
Rec Fee: \$30.00 Darrell James Hill
Gila County, Az, Sadie Jo Birmingham, Recorder



Trade-name/Trade-mark Notice and Agreement: BJR001-TN 06252015-TN CE

2 of 10

429

Unofficial Copy

**Trade-name and Trade-mark
Notice and Agreement
BJR001-TN 06252015-TN CE**



- 1 by tacit procuracy for the impending non-judicial forum judgment against the User for the any
2 unauthorized use of the said Trade-name or Trade-mark, and, to wit, that such actions did
3 contractually bind to the User, and signified therefore that: User:
4 1) grants to the SECURED PARTY a security interest in, and a distress warrant or lien
5 against: User's property(ies) and interest in the any of the User's property(ies) in the
6 sum certain amount: Five Hundred thousand and no/100 dollars: 500,000.00 USD,
7 or: equivalent currency to which the Secured Party may prefer to agree to the
8 receipt, per the each Trade-name/Trade-mark used, per the each occurrence of a use,
9 plus for the costs, plus for the triple damages, as well as: same for the each and every
10 use of the any derivatives or variations in the spelling or of the otherwise use of the
11 Trade-name or Trade-mark;
12 2) authenticates in the support of this Trade-name and Trade-mark Notice BJR001-TN
13 06252015-TN CE wherein the User is the DEBTOR to the SECURED PARTY;
14 and: User pledges any of the User's property(ies) or interest in the any of the User's
15 property(ies) for the collateral securing any of the contractual obligation(s);
16 3) authenticates in the support of the any of the UCC Financing Statement(s) wherein
17 the User is the DEBTOR to the SECURED PARTY;
18 4) consents and agrees that the any of the Financing Statements filed hereto are unto
19 the continuing financing status of that which the User authorized, authorizing:
20 SECURED PARTY's filing of the any initial and continuation statement(s) as
21 necessary for the maintenance of the SECURED PARTY's attachment or perfected
22 security interest(s) in the any of the User's property or of the User's right(s) in a
23 property pledged as the collateral in the aforementioned, until: User's contractual
24 obligation is fully satisfied;
25 5) authorizes unto the filing of the aforementioned UCC Financing Statement or
26 Security Agreement in the UCC filing office by the SECURED PARTY;
27 6) consents and agrees that any such filings referenced in the paragraph "5)" above are
28 not or may not be considered to be false, and that: User waives all claim(s) against
29 any such filing(s);
30 7) waives any of the defense(s);
31 8) consents and agrees that: User will execute any of the further documents and take
32 any of the further actions as requested by the SECURED PARTY that augment any
33 of the following: a) evidencing of the security interest granted herein; b) perfecting
34 of the security interest granted herein; c) maintaining of the first priority of the
35 security interest granted herein; d) effectuating of the right(s) herein granted to the
36 SECURED PARTY by the User. e) Further: User also consents and agrees in the



430

**Trade-name and Trade-mark
Notice and Agreement
BJR001-TN 06252015-TN CE**

1

[INTENTIONALLY LEFT BLANK]

431

Trade-name/Trade-mark Notice and Agreement: BJR001-TN 06252015-TN CE

4 of 10

Handwritten signature
Handwritten signature
Handwritten signature



2022-011769 MISC Page: 429 of 2782
09/26/2022 03:35:37 PM Receipt #: 22-9381
Rec Fee: \$30.00 Darrell James Hill
Gila County, Az, Sadie Jo Bingham, Recorder

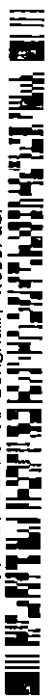

Unofficial Copy

**Trade-name and Trade-mark
Notice and Agreement
BJR001-TN 06252015-TN CE**

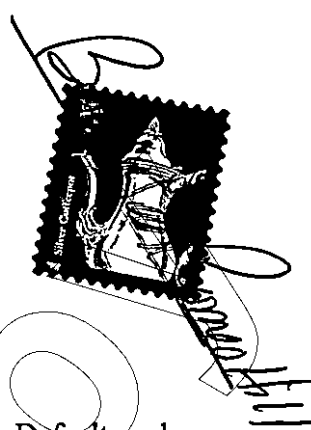

1 any of the Payment Terms, Default Terms, Terms for the Curing of the Default, and
2 Terms of the Strict Foreclosure as set forth herein or within the particularity in the
3 NOTICE-by written communication, in regards to the Notice of Unauthorized Use
4 of the Trade-name/Trade-mark; to wit: User consented and agreed with all of the
5 following:

6 **9) Payment Terms:**

7 i) User shall pay to the Secured Party all of the unauthorized-use fees in the
8 full within the five (5) days of the time of the date of the Secured Party's invoice
9 delivery, hereinafter the "Invoice".

10 ii) Default Terms: event of the non-payment in the full of the all of the
11 unauthorized-use fees, then: User after the five (5) days of the date of the Invoice
12 delivery shall deem: User's non-payment of the unauthorized-use fee(s) as in the
13 default; to wit: all of the User's property or of the User's right(s) in a property
14 pledged as the collateral in the aforementioned transfers over to the
15 collateral/property "in fact" of the Secured Party.

16 iii) Terms for Curing Default: User may cure default within ten (10) days only
17 by the payment in the full of the unauthorized-use fees.

18 iv) Terms of Strict Foreclosure: User's non-payment in the full of all the
19 unauthorized-use fees as itemized in the Invoice within said ten (10) days period
20 for the curing of the default as set forth above: User authorizes: Secured Party by
21 tacit procuration, to mediate unto the non-judicial strict foreclosure upon all of
22 the User's property pledged for the collateral for the securing of the User's
23 contractual obligation as set forth herein-above.

24 **Accommodation:**

25 Secured Party is not now, nor ever been, an accommodation party or a surety, for the
26 acknowledged DEBTOR, ie.: "BEVERLY JEAN ROMERO- HILL", or for the any of the
27 derivative(s) thereof, nor for the any of the variations in the spelling of the said name, nor for an
28 other stramineus homo, and is so-indemnified and held harmless by the DEBTOR - See: Hold
29 Harmless and Indemnity Agreement BJR001-HHIA 06252015-HHIA CE, against any and all of
30 the claims, legal actions, orders, warrants, judgments, demands, liabilities, losses, depositions,
31 summonses, lawsuits, costs, fines, liens, levies, penalties, damages, interests, and expenses
32 whatsoever, both of the absolute and contingent, as are due and as might become due, now
33 existing and as might hereafter arise, and as might be suffered by, imposed on, and incurred by
34 the DEBTOR for any and every reason, purpose, and cause whatsoever.

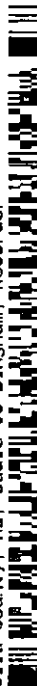

432

Trade-name and Trade-mark
Notice and Agreement
BJR001-TN 06252015-TN CE

1

[INTENTIONALLY LEFT BLANK]

2022-011769 MISC Page: 431 of 2782

09/29/2022 03:35:37 PM Receipt #: 22-9381

Rec Fee: \$30.00 Darrell James Hill
Gila County, Az, Saddle Jo Bingham, Recorder



6 of 10

Trade-name/Trade-mark Notice and Agreement: BJR001-TN 06252015-TN CE

433

Unofficial Copy

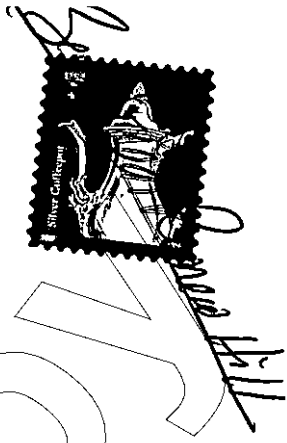

Trade-name and Trade-mark
Notice and Agreement
BJR001-TN 06252015-TN CE

1 For the Babel Communications: The content of this document is written nunc pro tunc in the
2 babel language communication style common on the day of this document, as distinguished
3 against Complete-Sentence-Sense-Parse-Syntax-Grammar, "CSSPSG" context communication.
4 Any translation and/or interpretation shall be contextually construed in accordance with the
5 meaning intended by the writer.

6 Notice to the principal(s) is notice to all of the agents.
7 Notice to the agent(s) is notice to all of the principals.

8 This: Trade-name and Trade-mark Notice and Agreement BJR001-TN 06252015-TN CE:
9 DEBTOR: Transmitting Utility,

10 BEVERLY JEAN ROMERO HILL
11 BEVERLY JEAN ROMERO- HILL

STATE OF ARIZONA

COUNTY OF MARICOPA

12 ON this 28th day of June, 2015 A.D., by me, a notary public in and for the said STATE OF
13 ARIZONA, residing therein, duly commissioned and sworn, personally appeared BEVERLY JEAN
14 ROMERO- HILL, satisfactorily proved to me upon the presentation of sufficient documentation to b
15 the person described in and who executed the within instrument. Witness my hand and seal this

16 28th day of JUNE, 2015.



KALLE KIVINEN
Notary Public - Arizona
Maricopa County
Expires on 08/15/2016

17 Notary [Signature] My Commission Expires 8-15-2016

2022-011769 MISC Page: 432 of 2782
09/26/2022 03:35:37 PM Receipt #: 22-9381
Rec Fee: \$30.00 Darrell James Hill
Gila County, Az, Sadie Jo Bingham, Recorder

434

**Trade-name and Trade-mark
Notice and Agreement
BJR001-TN 06252015-TN CE**

Unofficial Copy

1

[INTENTIONALLY LEFT BLANK]

435

Trade-name/Trade-mark Notice and Agreement: BJR001-TN 06252015-TN CE

8 of 10

James Hill



2022-011769 MISC Page: 433 of 2782
09/26/2022 03:35:37 PM Receipt #: 22-9981
Rec Fee: \$30.00 Darrell James Hill
Gila County, Az, Sadie Jo Bingham, Recorder





Trade-name and Trade-mark
Notice and Agreement
BJR001-TN 06252015-TN CE

1 **Acceptance By The Secured Party:**

2 Entitlement Holder or SECURED PARTY accepts: DEBTOR's signature in accordance with the
3 UCC §§ 1-201(37) (2001 CE), 3-401 (2002 CE), and accepts for the value to this Security
4 Agreement and any: DEBTOR's herein-above- described/ itemized Collateral.

(SECURED PARTY's Signature)

5

Without prejudice: UCC 1-308

6

7

Beverly Jean Romero Hill 6/28/15
SECURED PARTY:

8

9 **Arizona state territory:**

10

Witness of Signor:

11 I: man upon the ground, a sojourner in the Arizona state territory beyond the sea on this 28 day of the
12 June month in the year anno domini two thousand fifteen, am. And, after the witnessing of
13 the Beverly-Jean: Romero- Hill's applying her signature onto this document, I affirm same by my
14 signature to the fact that: 1) I witnessed: Beverly-Jean: Romero- Hill applying her signature to the
15 document; and, 2) I know: Beverly-Jean: Romero- Hill personally.

Witness: Jay Sample date 6-28-15

Witness: Jeffrey Hill date 6/28/2015

Witness: Virginia H. Green date 6/28/15

Witness: _____ date _____

L.S. BEVERLY JEAN ROMERO HILL

L.S. Beverly Jean Romero Hill

16

17

436

**Trade-name and Trade-mark
Notice and Agreement
BJR001-TN 06252015-TN CE**

[INTENTIONALLY LEFT BLANK]

2022-011769 MISC Page: 435 of 2782
09/26/2022 09:35:37 PM Receipt #: 22-9381
Rec Fee: \$30.00 Darrell James Hill
Gila County, Az, Sadie Jo Bingham, Recorder

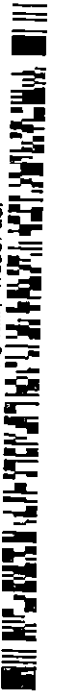

10 of 10

Trade-name/Trade-mark Notice and Agreement: BJR001-TN 06252015-TN CE

437

Unofficial Copy

SECURITY AGREEMENT BJR001-SA 06252015-SA CE
Non-Negotiable – Private Agreement Between two Parties



Handwritten signature and date: 9/26/22

Unofficial Copy

ENCLOSURE-4

HOLD-HARMLESS AND INDEMNITY AGREEMENT: BJR001-HHIA

438

SECURITY AGREEMENT BJR001-SA 06252015-SA CE

59 of 68

2022-011769 MISC Page: 436 of 2782
09/26/2022 03:35:37 PM Receipt #: 22-9381
Rec Fee: \$30.00 Darrell James Hill
Gila County, Az, Sadie Jo Bingham, Recorder



SECURITY AGREEMENT BJR001-SA 06252015-SA CE
Non-Negotiable – Private Agreement Between two Parties

439

SECURITY AGREEMENT BJR001-SA 06252015-SA CE

INTENTIONALLY LEFT BLANK

2022-0111769 MISC Page: 437 of 2782
09/26/2022 03:35:37 PM Receipt #: 22-9381
Rec Fee: \$30.00 Darrell James Hill
Gila County, Az, Sadie Jo Bingham, Recorder



pm
James Hill



60 of 68

Unofficial Copy

HOLD HARMLESS AND INDEMNITY AGREEMENT

BJR001-HHIA 06252015-HHIA CE:

Non-Negotiable – Private Between the Parties:

L.S. BEVERLY JEAN ROMERO HILL

L.S. Beverly Jean Romero Hill

DEBTOR:

BEVERLY JEAN ROMERO- HILL

C/O 5124 East 18th Avenue
Apache Junction, Arizona 85119

CREDITOR:

Beverly-Jean: Romero- Hill

C/O General Delivery
Apache Junction MPO
Apache Junction, Arizona [851209998]

This: Agreement is a mutually agreed upon and entered into contract on this 06252015-HHIA CE between: BEVERLY JEAN ROMERO- HILL, and the any of the all of the linear derivatives and variations in the spelling of the said name except “Beverly-Jean: Romero- Hill”, hereinafter jointly and severally “DEBTOR”, and between that of the living, natural man; to wit: biological and spiritual being living on the ground: Beverly-Jean: Romero- Hill, hereinafter: “CREDITOR”, or “SECURED PARTY”.

For: valuable consideration: DEBTOR, with the benefit of the contemplation, and with a single purpose, herein expressly agrees, covenants, and undertakes the absolute indemnification of the CREDITOR; to wit: DEBTOR holds harmless: CREDITOR unto the complete and absolute indemnification of the CREDITOR from and against the all of the any of the claims, legal actions, orders, warrants, judgments, demands, liabilities, losses, depositions, summonses, lawsuits, costs, fines, liens, levies, penalties, damages, interests, and expenses whatsoever, both absolute and contingent, as are due and as might become due, now existing and as might hereafter arise, and as might be suffered by, incurred by, and imposed upon the DEBTOR for the any of a reason, purpose or cause whatsoever. DEBTOR does hereby determine and herewith expressly commit to the covenant that: CREDITOR shall henceforth not be presumed or considered that of the accommodation party for or surety for the DEBTOR: BEVERLY JEAN ROMERO- HILL, or the all of the linear derivatives and variations in the spelling of the said name.

Terms Defined: Glossary of Terms. As used in this Hold Harmless and Indemnity Agreement, the following words and terms are as defined in the **Terms Defined** section of the **Security Agreement DJH001-SA 06252015 CE**, non obstante.

For the Babel Communications: The content of this document is written nunc pro tunc in the babel language communication style common on the day of this document, as distinguished against Complete-Sentence-Sense-Parse-Syntax-Grammar, “CSSPSG” context communication.

2022-011769 MISC Page: 438 of 2782

09/26/2022 03:35:37 PM Receipt #: 22-9381

Rec Fee: \$30.00 Darrell James Hill

Gila County, Az, Sadie Jo Bingham, Recorder



440

HOLD HARMLESS AND INDEMNITY AGREEMENT
BJR001-HHIA 06252015-HHIA CE:
Non-Negotiable – Private Between the Parties:

[INTENTIONALLY LEFT BLANK]

2022-011769 MISC Page: 439 of 2782
09/26/2022 03:35:37 PM Receipt #: 22-9381
Rec Fee: \$30.00 Darrell James Hill
Gila County, Az, Sadie Jo Bingham, Recorder



Unofficial Copy

441

HOLD HARMLESS AND INDEMNITY AGREEMENT

BJR001-HHIA 06252015-HHIA CE:

Non-Negotiable – Private Between the Parties:

Any translation and/or interpretation shall be contextually construed in accordance with the meaning intended by the writer.

This: Hold-harmless and Indemnity Agreement: BJR001-HHIA 06252015-HHIA CE

DEBTOR: Transmitting Utility,

BEVERLY JEAN ROMERO HILL

BEVERLY JEAN ROMERO- HILL

STATE OF ARIZONA

COUNTY OF MARICOPA

ON this 28th day of June, 2015 A.D., by me, a notary public in and for the said STATE OF ARIZONA; residing therein, duly commissioned and sworn, personally appeared BEVERLY JEAN ROMERO- HILL, satisfactorily proved to me upon the presentation of sufficient documentation to be the person described in and who executed the within instrument. Witness my hand and seal this

28th day of JUNE, 2015.



KALLE KIVINEN
Notary Public - Arizona
Maricopa County
Expires on 08/15/2016

Notary [Signature]

My Commission Expires 8-15-2016



442
UNOFFICIAL COPY

Page: 440 of 2782

MISC

09/26/2022 03:35:37 PM

Rec Fee: \$30.00

Darrell James Hill

Gila County, Az, Sadie Jo Bingham, Recorder

2022-011769

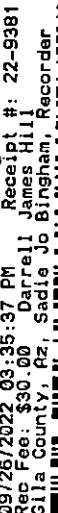

HOLD HARMLESS AND INDEMNITY AGREEMENT
BJR001-HHIA 06252015-HHIA CE:
Non-Negotiable – Private Between the Parties:

[INTENTIONALLY LEFT BLANK]

2022-011769 MISC Page: 441 of 2782
09/26/2022 03:35:37 PM Receipt #: 22-9381
Rec Fee: \$30.00 Darrell James Hill
Gila County, Az, Sadie Jo Bingham, Recorder

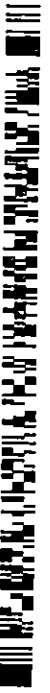

44B



MAR 20 2022

Unofficial Copy

HOLD HARMLESS AND INDEMNITY AGREEMENT

BJR001-HHIA 06252015-HHIA CE:

Non-Negotiable – Private Between the Parties:

Acceptance By The Secured Party:

Entitlement Holder or SECURED PARTY accepts: DEBTOR's signature in accordance with the UCC §§ 1-201(37) (2001 CE), 3-401 (2002 CE), and accepts for the value to this Security Agreement and any: DEBTOR's herein-above- described/ itemized Collateral.

(SECURED PARTY's Signature)

Without prejudice: UCC 1-308

Beverly Jean Romero-Hill
SECURED PARTY:

6/28/15

Arizona state territory:

Witness of Signor:

I, man upon the ground, a sojourner in the Arizona state territory beyond the sea on this 28 day of the June month in the year anno domini two thousand fifteen, am. And, after the witnessing of the Beverly-Jean: Romero- Hill's applying her signature onto this document, I affirm same by my signature to the fact that: 1) I witnessed: Beverly-Jean: Romero- Hill applying her signature to the document; and, 2) I know: Beverly-Jean: Romero- Hill personally.

Witness:

Jeff Ingold

date 6-28-15

Witness:

Jeff Paul Jan

date 6/28/2015

Witness:

Virginia T. Green

date 6/28/15

L.S.

BEVERLY JEAN ROMERO-HILL

L.S.

Beverly Jean Romero Hill

Hold Harmless and Indemnity Agree

2022-011769 MISC Page: 442 of 2782

09/26/2022 03:35:37 PM Receipt #: 22-9381

Rec Fee: \$30.00 Darrell James Hill

Gila County, Az, Sadie Jo Bingham, Recorder



Unofficial
444

Unofficial
11-17-15

HOLD HARMLESS AND INDEMNITY AGREEMENT
BJR001-HHIA 06252015-HHIA CE:
Non-Negotiable – Private Between the Parties:

[INTENTIONALLY LEFT BLANK]

2022-011769 MISC Page: 443 of 2782
09/26/2022 09:35:37 PM Receipt #: 22-9381
Rec Fee: \$30.00 Darrell James Hill
Gila County, Az, Sadie Jo Bingham, Recorder



445

Darrell James Hill

Unofficial Copy

SECURITY AGREEMENT BJR001-SA 06252015-SA CE
Non-Negotiable – Private Agreement Between two Parties



Handwritten signature

Unofficial Copy

ENCLOSURE-5

Notarial Acknowledgment of Original CERTIFICATE OF BIRTH

Copy of CERTIFICATE OF BIRTH

2022-011769 MISC Page: 444 of 2782
09/26/2022 03:35:37 PM Receipt #: 22-9381
Rec Fee: \$30.00 Darrell James Hill
Gila County, Az, Sadie Jo Bingham, Recorder

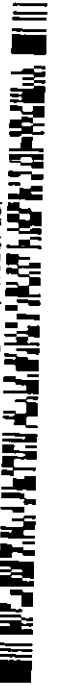

446

SECURITY AGREEMENT BJR001-SA 06252015-SA CE
Non-Negotiable – Private Agreement Between two Parties

Unofficial Copy

INTENTIONALLY LEFT BLANK

2022-011769 MISC Page: 445 of 2782
09/26/2022 03:35:37 PM Receipt # 22-9981
Rec Fee: \$30.00 Darrell James Hill
Gila County, Az, Sadie Jo Bingham, Recorder



[Handwritten signature]
62 of 68
[Handwritten signature]



447

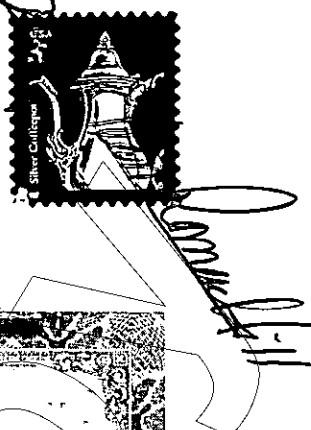

NOTARIAL ACKNOWLEDGMENT OF ORIGINAL AUTHENTIC BIRTH CIERTIFICATE

CERTIFICATE OF BIRTH / CERTIFICADO DE NACIMIENTO. STATE OF NEW MEXICO. New Mexico Vital Records and Health Statistics. Public Health Division. I certify that the following birth is registered in the New Mexico Vital Records and Health Statistics. File No. / Numero de Archivo, Request No. / Numero de Solicitud, County of Birth / Condado de Nacimiento, Date of Birth / Fecha de Nacimiento, Date of Registration / Fecha de Inscripcion, Sex / Sexo: FEMALE, Name of Person Registered / Nombre del Registrado: BEVERLY JEAN ROMERO, Name of Father or Parent / Nombre del Padre, Birth Name of Mother or Parent / Nombre de Soltera de la Madre. WARNING: THIS IS ILLEGAL TO COPY OR COUNTERFEIT THIS CERTIFICATE. ADVERTENCIA: ES ILLEGAL ALTERAR, COPIAR O FALSIFICAR ESTE CERTIFICADO. Signature of State Registrar: Donna Dorsey. DO NOT DUPLICATE BY ANY MEANS.

STATE OF ARIZONA COUNTY OF MARICOPA

ON this 28th day of June, 2015 A.D., by me, a notary public in and for the said STATE OF ARIZONA, residing therein, duly commissioned and sworn, personally appeared and upon the presentation of sufficient documentation satisfactorily proved to me to be the person BEVERLY JEAN ROMERO-HILL, and who provided to me a document from the STATE OF NEW MEXICO for notarial acknowledgment.

The document is on repetitively stated "NEW MEXICO VITAL RECORDS" throughout, with an other state seal type of inclusion, watermark safety paper; surrounded by a border presumed to be unique to the STATE OF NEW MEXICO bond paper; and, entitled in both english and spanish languages, "CERTIFICATE OF BIRTH, STATE OF NEW MEXICO, New Mexico Vital Records and Health Statistics, Public Health Division". Following, the document contains a certification statement for the birth record information enclosed in the form; then then record is signed in the lower right corner by a "SIGNATURE OF THE STATE REGISTRAR" in mostly legible cursive, Donna Dorsey.

The document content information: "File No. [redacted]" "Request No. [redacted]" "County of Birth [redacted]" "Date of Birth [redacted]" "Name of Person Registered BEVERLY JEAN ROMERO", "Name of Father [redacted]", "Birth Name of Mother [redacted]". Following, at the bottom of the form is a number in red color; "No. 2022943", then next over in the bottom middle is "GREAT SEAL OF THE STATE OF NEW MEXICO" before the registrar's signature of the bottom right of the document.

I acknowledge this document as authentic.

Witness my hand and seal this

28th day of June, 2015.



KALLE KIVINEN Notary Public - Arizona Maricopa County Expires on 08/15/2016

Notary

My Commission Expires 8-15-2016

NOTARIAL ACKNOWLEDGMENT
OF ORIGINAL, AUTHENTIC, BIRTH CERTIFICATE

Official Copy

[REDACTED]

[INTENTIONALLY LEFT BLANK]

2022-011769 MISC Page: 447 of 2782
05/25/2022 03:35:37 PM Receipt #: 22-9981
Rec Fee: \$30.00 Darrell James Hill
Gila County, Az, Sadie Jo Bingham, Recorder



449



Handwritten signature and date

SECURITY AGREEMENT BJR001-SA 06252015-SA CE
Non-Negotiable – Private Agreement Between two Parties



ENCLOSURE-6

Notarial Acknowledgment of Original ARIZONA Driver License; Number D01385612

Copy of ARIZONA Driver License; Number D01385612

2022-011769 MISC Page: 448 of 2782
09/26/2022 03:35:37 PM Receipt #: 22-9381
Rec Fee: \$30.00 Darrell James Hill
Gila County, Az. Sadie Jo Bingham, Recorder



450

Unofficial Copy

SECURITY AGREEMENT BJR001-SA 06252015-SA CE
Non-Negotiable – Private Agreement Between two Parties

451

SECURITY AGREEMENT BJR001-SA 06252015-SA CE

INTENTIONALLY LEFT BLANK



64 of 68

2022-011769 MISC Page: 449 of 2782

09/26/2022 03:35:37 PM Receipt #: 22-9381

Rec Fee: \$30.00 Darrell James Hill

Gila County, AZ, Sadia Jo Bingham, Recorder



Unofficial Copy

**NOTARIAL ACKNOWLEDGMENT
OF ORIGINAL, AUTHENTIC, ARIZONA, Driver License**

[Handwritten signature]
 [Notary Seal]

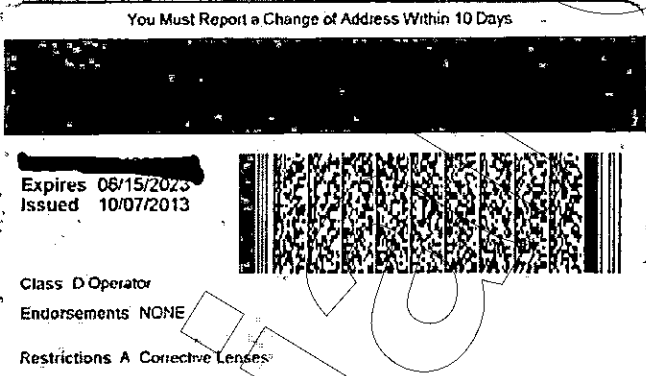
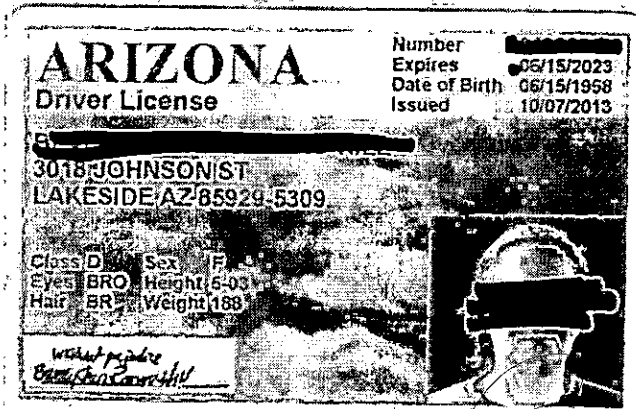

**STATE OF ARIZONA
 COUNTY OF MARICOPA**

ON this 28th day of June, 2015 A.D., by me, a notary public in and for the said STATE OF ARIZONA, residing therein, duly commissioned and sworn, personally appeared and upon the presentation of sufficient documentation satisfactorily proved to me to be the person BEVERLY JEAN ROMERO-HILL, and who provided to me a document from the STATE OF ARIZONA for notarial acknowledgment.

The document is set upon a sky-mountain background picture, is entitled "ARIZONA, DRIVER LICENSE" in the upper left corner with repetitively distributed throughout the card a 'state-shaped-picture with the words "CANYON" following. The document is signed in the lower left corner, with a likeness picture of the presumed signer in the lower right corner. The picture in the right lower corner is a reasonable facsimile of Beverly-Jean: Romero-Hill.

The right upper corner document content information is: "Number: ~~20130101~~ Expires 06/15/2023; Date of Birth 06/15/1958; Issued 10/07/2013.

The middle document content information is: "BEVERLY JEAN ROMERO-HILL with a following address location, below which is a description of a person, and below which is a signum in a white box at the left base of the card document.

I acknowledge this document as authentic.

Witness my hand and seal this

28th day of JUNE, 2015.



KALLE KIVINEN
 Notary Public - Arizona
 Maricopa County
 Expires on 08/15/2016

Notary

My Commission Expires

8-15-2016

452



NOTARIAL ACKNOWLEDGMENT
OF ORIGINAL, AUTHENTIC, ARIZONA, Driver License

[REDACTED]

[REDACTED]

[REDACTED]

[REDACTED]

[INTENTIONALLY LEFT BLANK]

[REDACTED]

2022-011769 MISC Page: 451 of 2782

09/28/2022 03:35:37 PM Receipt #: 22-9381

Reg Fee: \$30.00 Darrell James Hill

Gila County, Az, Sadie Jo Bingham, Recorder



463



[Handwritten Signature]

Unofficial Copy

SECURITY AGREEMENT BJR001-SA 06252015-SA CE
Non-Negotiable – Private Agreement Between two Parties

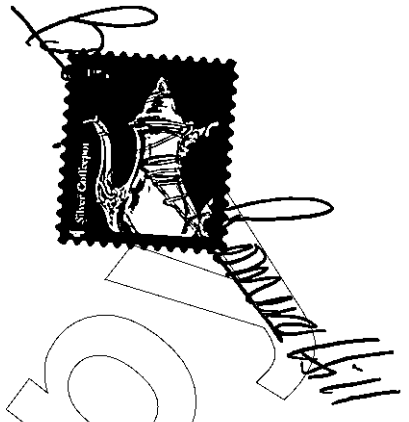

For the Babel Communications: The content of this document is written nunc pro tunc in the babel language communication style common on the day of this document, as distinguished against Complete-Sentence-Sense-Parse-Syntax-Grammar, "CSSPSG" context communication. Any translation and/or interpretation shall be contextually construed in accordance with the meaning intended by the writer.

This: Security Agreement BJR001-SA 06252015-SA CE:
Debtor: Transmitting Utility

BEVERLY JEAN ROMERO HILL
BEVERLY JEAN ROMERO- HILL

STATE OF ARIZONA

COUNTY OF MARICOPA

ON this 28th day of June, 2015 A.D., by me, a notary public in and for the said STATE OF ARIZONA, residing therein, duly commissioned and sworn, personally appeared BEVERLY JEAN ROMERO- HILL, satisfactorily proved to me upon the presentation of sufficient documentation to be the person described in and who executed the within instrument. Witness my hand and seal this

28th day of JUNE, 2015.



KALLE KIVINEN
Notary Public - Arizona
Maricopa County
Expires on 08/15/2016

Notary

[Signature]

My Commission Expires 8-15-2016

454



SECURITY AGREEMENT BJR001-SA 06252015-SA CE
Non-Negotiable – Private Agreement Between two Parties

455

SECURITY AGREEMENT BJR001-SA 06252015-SA CE

66 of 68

[Handwritten signature]
[Handwritten signature]



INTENTIONALLY LEFT BLANK

2022-011769 MISC Page: 453 of 2782
09/26/2022 03:35:37 PM Receipt #: 22-9381
Rec Fee: \$30.00 Darrell James Hill
Gila County, Az, Sadie Jo Bingham, Recorder

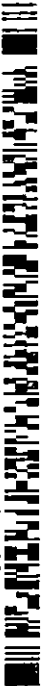

Unofficial Copy

SECURITY AGREEMENT BJR001-SA 06252015-SA CE
Non-Negotiable – Private Agreement Between two Parties



:Acceptance By The Secured Party:

Entitlement Holder or SECURED PARTY accepts: DEBTOR's signature in accordance with the UCC §§ 1-201(37) (2001 CE), 3-401 (2002 CE), and accepts for the value to this Security Agreement and any: DEBTOR's herein-above- described/ itemized-Collateral.

(SECURED PARTY's Signature)

Without prejudice: UCC 1-308

Beverly Jean Romero-Hill
SECURED PARTY:

Arizona state territory:

Witness of Signor:

I: man upon the ground, a sojourner in the Arizona state territory beyond the sea on this 28 day of the June month in the year anno domini two thousand fifteen, am. And, after the witnessing of the Beverly-Jean: Romero- Hill's applying her signature onto this document, I affirm same by my signature to the fact that: 1) I witnessed: Beverly-Jean: Romero- Hill applying her signature to the document; and, 2) I know: Beverly-Jean: Romero- Hill personally.

Witness: Yanf Jangof date 6.28.15
Witness: Jeffrey Paul Lee date 6/28/2015
Witness: Virginia L. Green date 6/28/15

L.S. BEVERLY JEAN ROMERO-HILL
L.S. Beverly Jean Romero Hill

Unofficial Copy

456

SECURITY AGREEMENT BJR001-SA 06252015-SA CE
Non-Negotiable – Private Agreement Between two Parties

457

SECURITY AGREEMENT BJR001-SA 06252015-SA CE

INTENTIONALLY LEFT BLANK

2022-011769 MISC Page: 455 of 2782
09/26/2022 03:35:37 PM Receipt #: 22-9381
Rec Fee: \$30.00 Darrell James Hill
Gila County, Az, Sadie Jo Bingham, Recorder

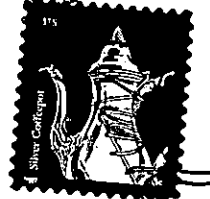

68 of 68



Unofficial Copy

Darrell-James: Hill
c/o Darrell James Hill
PO Box 3806
Apache Junction, Arizona 85120

Victor Suárez Meléndez
Secretary of State, Puerto Rico
San Juan, Puerto Rico
Department of State
PO Box 9023271
San Juan, Puerto Rico 00902-3271

Francisco J. Rodríguez Bernier
Assistant Secretary of State for Services
Commercial Transactions Registry
Department of State
PO Box 9023271
San Juan, Puerto Rico 00902-3271

CONDITIONAL ACCEPTANCE

Re: Second letter of rejection without fiduciary duty of explanation: first letter of rejection, received 01-03-2016 -Enclosure One, of the UCC1PR "document" rendering, USPO RMN RE 006 875 532 US, sent 09/15/2015, received 09/25/2015;

ACTUAL NOTICE OF RESET OF PRESUMPTION

Dear Sirs Meléndez, Benier:

I conditionally-accept your letter of rejection of the "document," of the UCC Financing Statement; TO WIT:

- 1) Your acknowledged reason in paragraph one for rejecting the 'document' is only alleged or opinion and not founded in the clarification of the legislation controlling your actions; that is, your rejection of the 'document' was premised upon that 'you do not have subject¹ matter² jurisdiction³ in your ministerial⁴-fiduciary⁵ capacity⁶.' Thus:

1 **SUBJECT. Legislation.** The matter of public or private concern for which law is enacted. See in the nature of State ex rel. Jensen v. Kelly, 65 S.D. 345, 274 N.W. 319, 323.... [The] term "subject" with such constitutional provisions is to be given a broad and extensive meaning so as to allow legislature full scope to include in one act all matters having a logical or natural connection. See in the nature of Shaw v State, 76 Okl. Cr. 271, 134 P.2d 999, 1006; Jaffee v. State, 76 Okl. Cr. 95, 134 P.2d 1027, 1032.- BLACK'S LAW DICTIONARY, 4th, (1968), p.1594.

2 **SUBJECT-MATTER.** The subject, or matter presented for consideration: See in the nature of Plymouth Hospital v. Hart, 178 Okl. 447, 62 P.2d 1248.- BLACK'S LAW DICTIONARY, 4th, (1968), p.1594.

3 **JURISDICTION.** The word is a term of large and comprehensive import, and embraces every kind of judicial action. See in the nature of Federal Land Bank of Louisville Ky., v. Crombie, 258 Ky. 383, 80 S.W.2d 39, 40 [T]he authority by which courts and judicial officers take cognizance of and decide cases. See in the nature of Board of Trustees of Firemen's Relief and Pension Fund of City of Marietta v. Brooks, 179 Okl. 600, 67 P.2d 4, 6.... [T]he legal right by which judges exercise their authority.... It is the authority, capacity, power or right to act.. See in the nature of Campbell v. City of Plymouth, 293 Mich. 84, 291 N.W. 2231, 232.- BLACK'S LAW DICTIONARY, 4th, (1968), p.991.

4 **MINISTERIAL.** That which is done under the authority of a superior; opposed to *judicial*; that which involves obedience to instructions, but demands no special discretion, judgment, or skill. See in the nature of State Tax Commission of Utah v. Katsis, 90 Utah 406, 62 P.2d 120, 123, 107 A.L.R. 1477; Blalock v. Johnston, 180 S.C. 40, 185 S.E. 51, 105 A.L.R. 1115; First Nat. Bank

DJH JAN 2016 SOS-PR RESPON

458

2022-011769 MISC Page: 456 of 2782
09/26/2022 03:35:37 PM Receipt #: 22-9381
Rec Fee: \$30.00 Darrell James Hill
Gila County, Az, Sadie Jo Bingham, Recorder



- 1a) I accept that you do not have subject-matter jurisdiction over the content of the instrument⁷; and, therefore,
- 1b) I accept that you have ministerial duty for the items of content of the "UCC1-PR" document presenting the instrument in the rendering for filing. To this end,
- 1c) I reiterate, you possess and was/is authorized No subject-matter jurisdiction over the content of the instrument. Therefore,
- 1d) I accept that, in your fiduciary capacity to the principal⁸, any self-proposed jurisdiction

2022-011769 MISC Page: 457 of 2782
 09/25/2022 03:35:37 PM Receipt #: 22-9381
 Rec Fee: \$30.00 Darrell James Hill
 Gila County, Az; Sadie Jo Bingham, Recorder

v. filer, 107 Fla. 526, 145 So. 204, 207, 87 A.L.R. 267.- BLACK'S LAW DICTIONARY, 4th, (1968), p.1148.

MINISTERIAL DUTY. One regarding which nothing is left to discretion—a simple and definite duty, imposed by law, and arising under conditions admitted or proved to exist. See in the nature of *City of Tacoma v. Peterson*, 165 Wash. 461, 5 P.2d 1022, 1024. *Mott v. Hull*, 51 Okl. 602, 152 P. 92, L.R.A.1916B, 1184. It arises when an individual has such a legal interest in its performance that neglect of performance becomes a wrong to such individual. See in the nature of *Morton v. Comptroller General*, 4 S.C. 473.- BLACK'S LAW DICTIONARY, 4th, (1968), p.1148.

5 FIDUCIARY. The term is derived from the Roman law, and means (as a noun) a person holding the character of a trustee, or a character analogous to that of a trustee, in respect to the trust and confidence involved in it and the scrupulous good faith and candor which it requires. See in the nature of *Svanoe v. Jurgens*, 144 Ill. 507, 33 N.E. 955; *Stoll v. King*, 8 How.Prac., N.Y., 299. A person having duty, created by his undertaking, to act primarily for another's benefit in matters connected with such undertaking. See in the nature of *Haluka v Baker*, 66 Ohio App. 308, 34 N.E.2d 68, 70.- BLACK'S LAW DICTIONARY, 4th, (1968), p.753.

6 FIDUCIARY CAPACITY. One is said to act in a "fiduciary capacity" or to receive money or contract a debt in a "fiduciary capacity," when the business which he transacts, or the money or property which he handles, is not his own for for his own benefit, but for the benefit of another person, as to whom he stands in a relation implying and necessitating great confidence and trust on the one part and a high degree of good faith on the other part. The term is not restricted to technical or express trusts, but also such offices or relations as those of an attorney at law, a guardian, executor, or broker, a director of a corporation, and a public officer. See in the nature of *Templeton v Bockler*, 73 Or. 494, 144 P. 405, 409; *Madison Tp. v. Dunkle*, 114. Ind. 262, 16 N.E. 593.- BLACK'S LAW DICTIONARY, 4th, (1968), p.753.

7 INSTRUMENT. A written document; a formal or legal document in writing, such as a contract, deed, will, bond, or lease. See in the nature of *State v. Phillips*, 157 Ind. 481, 62 N.E. 12; *Cardenas v. Miller*, 108 Cal. 250, 39 P. 783, 49 AmSt.Rep. 84.

Anything reduced to writing, a document of a formal or solemn character, a writing given as a means of affording evidence. See in the nature of *Smith v. Smith*, Ind. App., 110 N.E. 1013, 1014. A document or writing which gives formal expression to a legal act or agreement, for the purpose of creating, securing, modifying, or terminating a right; a writing executed and delivered as the evidence of an act or agreement. See in the nature of *Moore v. Diamond Dry Goods Co.*, 47 Ariz. 128, 54 P.2d 553, 554.- BLACK'S LAW DICTIONARY, 4th, (1968), p.941.

8 PRINCIPAL, n. The source of authority or right.... See in the nature of *Williams v School Dist. No. 189*, 104 Wash. 659, 177 P. 635, 636... **Law of Guaranty and Suretyship**

The person primarily liable, for whose performance of his obligation the guarantor or surety has become bound. See in the nature of *Rollings v Gunter*, 211 Ala. 671, 101 So. 446, 448.- BLACK'S LAW DICTIONARY, 4th, (1968), p.1355.

459

over and above the UCC1-PR component in the rendering for the principal's legal⁹-right¹⁰
¹¹ of redemption of any proceeds of property/ proceeds constitutes i) legal advice, ii)
opinion and iii) is error¹²-at-law or legal fraud.^{13 14} And,

- 1e) I ascertained no fact(s) for why these facts are not true.
- 2 As you indicated in paragraph two, you defined "debtor" means a person¹⁵...". Please provide statute information upon which you relied in the English language so that we may agree. Generically, See in the nature of UCC 9-102 (28) "Debtor"¹⁶ means: (A) a person having an interest¹⁷, other than a security interest¹⁸ or other lien, in the collateral¹⁹,

9 LEGAL. 1. Conforming to the law; according to law; required or permitted by law; not forbidden or discountenanced by law; good and effectual in law. See in the nature of Freeman v. Fowler Packing Co., 135 Kan. 378, 11 P.2d 276, 277; General Motors Acceptance Corporation v. Schwartz, 118 N.J.L. 25, 190 A. 625, 627... - BLACK'S LAW DICTIONARY, 4th, (1968), p.1038.

10 RIGHT. As a noun, and taken in an abstract sense, justice, ethical correctness, or consonance with the rules of law or the principles of morals. In this signification it answers to one meaning of the Latin "jus," and serves to indicate law in rights, or the complex of underlying moral principles which impart the character of justice to all positive law, or give it an ethical content.

As a noun, and taken in a concrete sense, a power, privilege, faculty, or demand, inherent in one person and incident upon another. "Rights" are defined generally as "powers of free actions." And the primal rights pertaining to men are undoubtedly enjoyed by human beings purely as such, being grounded in personality, and existing antecedently to their recognition by positive law. But leaving the abstract moral sphere, and giving to the term a juristic content, a "right" is well defined as "a capacity residing in one man of controlling, with the assent and assistance of the state, the actions of others." See in the nature of Holl. Jur. 69 - BLACK'S LAW DICTIONARY, 4th, (1968), p.1486.

11 LEGAL RIGHT. Natural rights, rights existing as result of contract, and rights created or recognized by law. See in the nature of Five v. Pratt, Tex.Civ.App., 150 S. W.2d 308, 311.- BLACK'S LAW DICTIONARY, 4th, (1968), p.1042.

12. ERROR. A mistaken judgment or incorrect belief as to the existence or effect of matters of fact, or a false or mistaken conception or application of the law.... And act involving a departure from truth or accuracy. See in the nature of Gronseth v. Mohn, 57 S.D. 604, 234 N.W. 603, 604... - BLACK'S LAW DICTIONARY, 4th, (1968), p.788.

13 LEGAL FRAUD. Contracts or acts as, though not originating in actual evil design to perpetrate fraud, yet by their tendency to mislead others or to violate confidence, are prohibited by law. See in the nature of Ruedy v. Toledo Factories Co., 61 Ohio App. 21, 22 N.E.2d 293, 297. Breach of duty which has tendency to deceive others and operates to their injury, even though there be no vicious intent. See in the nature of Charlerol Lumber Co. V. School Dist. of Borough of Bentleyville, 334 Pa. 424, 6 A.2d 88, 91.

Synonymous with "constructive fraud". See in the nature of Purcell v. Robertson, 122 W.Va. 287, 8 S.E.2d 881, 883; Tom Reed Gold Mines Co. United Eastern Mining Co., 39 Ariz. 533, 8 P.2d 449, 451.- BLACK'S LAW DICTIONARY, 4th, (1968), p.1040.

14 FRAUD. An intentional perversion of truth for the purpose of inducing another in reliance upon it to part with some valuable thing belonging to him or to surrender a legal right; a false representation of a matter of fact, whether by words or by conduct, by false or misleading allegations, or by concealment of that which should have been disclosed, which deceives and is intended to deceive another so that he shall act upon it to his legal injury. See in the nature of Brainerd Dispatch Newspaper Co. v. Crow Wing County, 196 Minn. 194, 264 N.W. 779, 780... - BLACK'S LAW DICTIONARY, 4th, (1968), p.788.

15 "Person" means an individual, corporation, business trust, estate, trust, partnership, limited liability company, association, joint venture, government, governmental subdivision, agency, or instrumentality, public corporation, or any other legal or commercial entity. See in the nature of UCC 1-201 (27).

PERSON. A man considered according to the rank he holds in society, with all the right to which the place he holds entitles him, and the duties which it imposes. See in the nature of People v. R. Co., 134 N.Y. 506, 31 N.E. 873.- BLACK'S LAW DICTIONARY, 4th, (1968), p.1299.

16 DEBTOR. One who owes a debt: he who may be compelled to pay a claim or demand. Anyone liable on a claim, whether due or to become due. See in the nature of Cozart v. Barnes, C.C.A.S.C., 240 F. 935, 938.

The term may be used synonymously with "obligor," "mortgagor," and the like. See in the nature of McDuffie v. Faulk, 214 Ala. 221, 107 So. 61, 62.- BLACK'S LAW DICTIONARY, 4th, (1968), p.492.

17 INTEREST. Property. The most general term that can be employed to denote a property in lands or chattels. In its application to lands or things real, it is frequently used in connection with the terms "estate," "right," and "title," and , according to Lord Coke, it properly includes them all. See in the nature of Co. Litt. 345b. State v. KcKellop, 40 Mo. 185; Loventhal v.

2022-011769 MISC Page: 458 of 2782
 09/26/2022 03:35:37 PM Receipt #: 22-9381
 Rec Fee: \$30.00 Darrell James Hill
 Gila County, Az. Sadie Jo Bingham, Recorder

460

whether or not the person is an obligor.²⁰

- 2a) Clearly, the term "debtor" is a person with an obligation of a contract²¹ interest. And,
- 2b) A "person" as indicated in the nature of UCC 1-201 (27) means an individual, corporation, ... or any²² other²³ legal or²⁴ commercial²⁵ entity²⁶; to wit: any alien person, any real being or commercial real being. UCC 1-201 thereby clearly specifies that a person means both: i) a fictitious person or individual, and ii) any real person without exclusion, including a private and natural man in any commerce with an interest in any collateral. Therefore, herenow,

Home Ins. Co., 20 So. 419, 112 Ala. 116, 33 L.R.A. 258, 57 Am.St.Rep. 17. More particularly it means a right to have the advantage accruing from anything; any right in the nature of property, but less than title; a partial or undivided right; a title to a share. - See in the nature of BLACK'S LAW DICTIONARY, 4th, (1968), p.950.

18 "Security interest" means an interest in personal property or fixtures which secures payment or performance of an obligation.... See in the nature of UCC 1-201 (35).

19 "Collateral" means the property subject to a security interest.... The term includes:

(A) proceeds to which a security interest attaches:

(B) accounts, chattel paper, payment intangibles, and promissory notes that have been sold; and See in the nature of UCC 9-102 (12).

20 OBLIGOR. The person who has engaged to perform some obligation. See in the nature of Code La. Art. 3522, mo. 12, CivCode, art. 3556, subd. 21. One who makes a bond.

Includes person liable for tort. See in the nature of Sarine v. American Lumbermen's Casualty Co. of Illinois, 258 App.Div. 653, 17 N.Y.S.2d 754, 756.- BLACK'S LAW DICTIONARY, 4th, (1968), p.1226.

21 OBLIGATION OF A CONTRACT. That which law in force when contract is made obliges parties to do or not to do, and remedy and legal means to carry it into effect. See in the nature of Harris v. Monroe Building & Loan Ass'n, La.App., 154 So. 503, 505.

As used in Const. U.S. Art. 1 § 10, the term means the binding and coercive force which constrains every man to perform the agreements h has made; a for grounded in the ethical principle of fidelity to one' promises, but deriving its legal efficacy from its recognition by positive law, and sanctioned by the law's providing a remedy for the infraction of the duty or for the enforcement of the correlative right. See in the nature of Story, Const. § 1378; Black Const. Prohib. § 139; Ogden v. Saunders, 12 Wheat 213, 6 L.Ed 606.

The "obligation of a contract" is its binding force according to the standards of law in existence when it was made. See in the nature of Colby v. City of Medford, 85 Or. 485, 167 P. 487, 499. The "obligation of a contract" is the duty of performance. See in the nature of Hays v. Port of Seattle, D.C. Wash., 266 f. 287, 293. The term includes everything with the obligatory scope of the contract, and it includes the means of enforcement. See in the nature of E J. Lander & Co. v. Deemy, 46 N.D. 273, 176 N.W. 922, 925; Franklin Sugar Refining Co. v. Martin-Nelly Grocery Co., 94 W.Va. 504, 119 S.E. 473, 476.- BLACK'S LAW DICTIONARY, 4th, (1968), p.1226.

22 ANY. Some; one out of many; an indefinite number. See in the nature of State v. Pierson, 204 Iowa 837, 216 N.W. 43, 44. One indiscriminately of whatever kind or quantity. See in the nature of Federal Deposit Ins. Corporation v. Winton, C.C.A.Tenn., 131 F.2d 780, 782... - BLACK'S LAW DICTIONARY, 4th, (1968), p.120.

23 OTHER. Different of distinct from that already mentioned; additional, or further. See in the nature of City of Ft. Smith v. Gunter, 106 Ark. 371, 154 S.W. 181, 183; State v. Blumenthal, 136 Ark. 532, 203 S.W. 36, 37, L.R.A.1918E, 482.- BLACK'S LAW DICTIONARY, 4th, (1968), p.1253.

24 OR. conj. A disjunctive particle used to express an alternative or to give a choice of one among two or more things. It is also used to clarify what has already been said, and in such cases, means "in other words," "to-wit","or "that is to say." See in the nature of Peck v. Board of Directors of Public Schools for Parish of Catahoula, 137 La. 334, 68 So. 629, 630; Travelers' Protective Ass'n v. Jones, 75 Ind. App. 29, 127 N.E. 783, 785... - BLACK'S LAW DICTIONARY, 4th, (1968), p.1246.

25 COMMERCIAL. Relating to or connected with trade and traffic or commerce in general. See in the nature of "Zante Currents", C.C.Cal., 73 F. 189. Occupied with commerce. See in the nature of Bowles v. Co-Operative G. L. F. Farm Products, D.C.N.Y., 53 F.Supp. 413, 415.- BLACK'S LAW DICTIONARY, 4th, (1968), p.336.

COMMERCE. The exchange of goods, productions, or property of any kind. See in the nature of Jeu Jo Wan v. Nagle, C.C.A.Cal., 9 F.2d 309, 310.- BLACK'S LAW DICTIONARY, 4th, (1968), p.336.

26 ENTITY. A real being; existence. See in the nature of Department of Banking v. Hedges, 136 Neb. 382, 286 N.W. 277, 281.-

2022-011769 MISC Page: 459 of 2782

09/26/2022 03:35:37 PM Receipt #: 22-9381

Rec Fee: \$30.00 Darrell James Hill

Gila County, Az, Sadie Jo Bingham, Recorder



461

- 2c) It is determinate that the UCC, and the statutes establishing, admits all debtor entity parties in interest in commerce without exclusion. And,
- 3 As you indicated in paragraph two, you defined "secured party" means a person" Please provide statute information upon which you relied in the English language so that we may agree. Generically, in the nature of UCC 9-102 (73) "Secured party" means: (A) a **person** in whose favor a **security interest**²⁷ is created or provided for under a security agreement²⁸, whether or not any obligation to be secured is outstanding; ... (E) a trustee, indenture trustee, agent collateral agent, or other representative in whose favor a security interest... is created or provided for; or... Thus,
- 3a) As made definite above the tenets of the secured party personage and relative interest in commerce is expressly provided for by the UCC without exclusion. Moreover,
- 3b) The UCC provides that presumption setting of the of personage and standing in right²⁹ may be set by one's chose in action³⁰ and such one aggrieved of that right may seek remedy.³¹ And,
- 4 Your paragraph 3 proffers that "the debtor and the secured party names³² shall be their legal names.³³" So, as is made clear in the previous sections, that in accordance with the UCC and establishing statutes, as all personages in commerce are recognized by the UCC and the statutes, the only possible remaining obstacle to your affirmative filing of my any rendering is the "legal name" usage for all parties upon the UCC1-PR document under your ministerial duty. Please send to me the information upon which you have made your assertion. To be clear, then:
- 4a) The legal name of a corporation would be the registered name of that corporation; The legal name of a stock or certificate³⁴ holder would be the name listed on the stock or certificate instrument;

BLACK'S LAW DICTIONARY, 4th, (1968), p.626.

27 "Security interest" means an interest in personal property or fixtures which secures payment or performance of an obligation.... See in the nature of UCC 1-102 (35).

28 "Security agreement" means an agreement that creates or provides for a security interest. See in the nature of UCC 9- 102 (74).

29 "Right" includes remedy. See in the nature of UCC 1-201 (34).

30 "Reservation of Rights" (a) A party that with explicit reservation of rights performs or promises performance or assents to performance in a manner demanded or offered in a manner demanded or offered by the other party does not thereby prejudice the rights reserved. Such words as "without prejudice," "under protest," or the like are sufficient. See in the nature of UCC 1-308.

31 "Remedy" means any remedial right to which an aggrieved party is entitled with or without resort to a tribunal. See in the nature of UCC 1-301(32).

32 NAME. The designation of an individual person, or of a firm or corporation. See in the nature of Riley v. Litchfield 168 Iowa 187, 150 N.W. 81, 83, Ann.Cas. 1917B, 172.- BLACK'S LAW DICTIONARY, 4th, (1968), p.1174.

33 LEGAL NAME. Under common law consists of one Christian name and one surname, and the insertion, omission, or mistake in middle name or initial is immaterial. See in the nature of Langley v. Zurich General Accident & Liability Ins. Co., 97 Cal.App. 434, 275 P. 963, 65.- BLACK'S LAW DICTIONARY, 4th, (1968), p.1040.

34 CERTIFICATE. ... A written assurance, or official representation, that some act has or has not been done, or some event occurred, or some legal formality has been complied with. ... A "certificate" by a public officer is a statement written and signed, but no necessarily or customarily sworn to, which is by law made evidence of the truth of the facts stated for all of for certain purposes. See in the nature of State v. Abernethy, 190 N.C. 768, 130 S.E. 619, 620.- BLACK'S LAW DICTIONARY, 4th, (1968), p.285.

2022-011769 MISC Page: 460 of 2782
 09/26/2022 03:35:37 PM Receipt #: 22-9381
 Rec Fee: \$30.00 Darrell James Hill
 Gila County, Az. Sadie Jo Bingham, Recorder



462

The legal name of a man would be his given common law Christian name and surname;³⁵ and: The 'legal name,' on the Birth Certificate, public organic record³⁶, would be the name listed on that instrument. Therefore,

- 4b) Specific to the rendering in question, a legal stramineus homo³⁷ name on the Birth Certificate is the legal entity name thereto and is a name without a "surname" by form though it is composed of the elements of the legal name of the principal and real party in interest, the man with the legal name. And,
- 4c) Specific to the rendering in question, the legal name of the principal and real party in interest in the certificate of birth is the man from whom the stramineus homo legal entity name is derived³⁸. Thus,
- 4d) Though the stramineus homo legal entity name on the birth certificate and the legal name of the man are similar in appearance and sound, in fact they are not identical in origin or law. Moreover, the stramineus homo legal entity name of the birth certificate is identified by the UCC to be an "individual" of legal construct, to wit, an evidence of the right of transmission,³⁹ ⁴⁰ whereas the legal name of the man is a "private"⁴¹ individual of natural origin in commerce. However, this discussion is beyond the scope of this remedy. Finally,
- 4e) Specific to the rendering in question, the remaining name requiring review is that of the legal name of the debtor, the "Secretary of the Treasury," also known as: "Secretary," "Secretary of the Treasury of Puerto Rico," "Secretary of the Treasury of the Commonwealth of Puerto Rico." However, I will refer to the debtor as "Secretary of the Treasury" for reasons; to wit:
- 4f) In positive law of Congress in support of the subsequent Executive Orders thereto, the President(s) used the title "Secretary of the Treasury"⁴² vesting the duties and responsibilities of the "Alien Property Custodian"⁴³ and the "common-law trustee"⁴⁴ onto

35 **SURNAME.** The family name; the name over and above the Christian name. The part of a name which is not given in baptism; the name of a person which is derived from the common name of his parents; See in the nature of *In re Faith's Application*, 22 N.J. Misc. 412, 39 A.2d 638, 640. The last name; the name common to all members of a family. A patronymic. See in the nature of *Riley v. Litchfield*, 168 Iowa 187, 150 N.W. 81, 83, Ann.Cas.1917B, 172.- **BLACK'S LAW DICTIONARY**, 4th, (1968), p.1612.

36 See in the nature of **UCC 9-503**.

37 **STRAMINEUS HOMO.** L. Lat. A man of straw, one of no substance, put forward as bail or surety. See in the nature of **BLACK'S LAW DICTIONARY**, 4th, (1968), p.1590.

38 **DERIVE.** To receive, a from a source or origin. See in the nature of *Crews. v. Commissioner of Internal Revenue*, C.C.A. 10, 89 F.2d 412, 416. - **DERIVED.** Received. See in the nature of *Langstaff v. Lucas*, D.C., 9 F.2d 691, 693. See, also, in the nature of *Connell v. Harper*, 202 Ky. 406, 259 S.W. 1017, 1019.- **BLACK'S LAW DICTIONARY**, 4th, (1968), p.530.

39 **TRANSMISSION.** In the civil law. The right which heirs or legatees may have of passing to their successors the inheritance or legacy to which they were entitled, if they happen to die without having exercised their rights. See in the nature of *Domat*, liv. 3, t.1, s.10; *Toullier*, no. 186; *Dig.* 50, 17, 54; *Code*, 6, 51.- **BLACK'S LAW DICTIONARY**, 4th, (1968), p.1670.

40 "transmitting utility" means the utility of transmission; to wit, the utility of use of the Birth Certificate and the legal stramineus homo name thereto any the man citizen of the sovereign several states as relates to the Trading with the Enemy Act of 1917 and the Emergency Bank Relief Act, enacted March 09, 1933, and Executive Orders thereto.

41 **PRIVATE.** Affecting or belonging to private individuals, as distinct from the public generally. Not official; not clothed with office. See in the nature of *People v. Powell*, 280 Mich. 699, 274 N.W. 372, 373, 111 A.L.R. 721. As to private "Act," "Agent," "Bill," ... - **BLACK'S LAW DICTIONARY**, 4th, (1968), p.1358.

42 See in the nature of **UCC 9-503**.

DJH JAN 2016 SOS-PR RESPONSE TO NON-FILING - USPO RMN RE 817 542 585 US - 6 of 8

2022-011769 MISC Page: 461 of 2782

09/26/2022 03:35:37 PM Receipt #: 22-9381

Rec Fee: \$30.00 Darrell James Hill

Gila County, Az, Sadie Jo Bingham, Recorder



463

the "Secretary of the Treasury" thereby creating our common commercial interest(s); however, this discussion is beyond the scope of this remedy. If you have an alternative for the named and addressed debtor party then please provide that information.

In conclusion, the conditional acceptance of your 01/03/2016 document is as indicated above. Every effort was made to achieve a remedy within the UCC and supporting legislation. No authority to judge the content of the instrument is authorized. No legal advice is authorized.

Enclosed is the corrected UCC1-PR document in the rendering. Any further rejection problems must be addressed expediently, and established in accordance with the applicable depended upon UCC, statutes and law; provision of the foundation for your assertions shall be documented.

You have seven days beginning upon the receipt of this rendering to respond, with three days for return mailing delivery time before default proceedings will be commenced. If you need more time to comply/ respond then your written request for extension of time made within the seven day period will not be unreasonably withheld.

COPYRIGHT NOTICE

The above-mentioned "non corporate entity" is quoting citations 'as purported in' context to copyrighted case law, statutes, rules of court and court decision material as found in books published with Federal or state funding supplied by the Citizens of the United States of America and intended for use by attorneys, and does so under the provisions of the Fair use clause of the copyright laws of the United States: by the term, "see in the nature of."

Notwithstanding the provisions of in the nature of sections 106 and 106A, the fair use of a copyrighted work, including such use by reproduction in copies or phonorecords or by any other means specified by that section, for purposes such as criticism, comment, news reporting,

43 EXECUTIVE ORDER NO. 11281. May 13, 1966, 31 F.R. 7215, TRANSFERRING JURISDICTION OVER BLOCKING ASSETS FROM ATTORNEY GENERAL TO SECRETARY OF THE TREASURY.

SEC. 5. SECTION 1 of Executive Order No. 10644 of November 7, 1955 [formerly set out under section 1631a of Title 22, Foreign Relations and Intercourse], is hereby amended to read as follows:

"SECTION 1. ... (b) The Secretary of the Treasury, and any officer, person, agency or instrumentality designated by the Secretary of the Treasury for this purpose, as hereby designated and empowered to perform the functions conferred upon the President by section 202 of Title II with respect to the release of blocked property and of the net proceeds of property that are carried in blocked accounts with the Treasury." See in the nature of U.S.C. Title 50, APPENDIX—WAR AND NATIONAL DEFENSE, Sec. 1 Trading with the Enemy Act of 1917.

SEC. 7. ... (c) ... The sole relief and remedy of any person having any claim to any money or other property heretofore or hereafter conveyed, transferred, assigned, delivered, or paid over to the Alien Property Custodian, or required so to be, or seized by him shall be that provided by the terms of this Act [said sections], and in the event of sale or other disposition of such property by the Alien Property Custodian, shall be limited to and enforced against the net proceeds received therefrom and held by the Alien Property Custodian or by the Treasurer of the United States....

44 EXECUTIVE ORDER NO. 11281. May 13, 1966, 31 F.R. 7215, TRANSFERRING JURISDICTION OVER BLOCKING ASSET FROM ATTORNEY GENERAL TO SECRETARY OF THE TREASURY

SEC. 12. ... The alien property custodian shall be vested with all of the powers of a common-law trustee in respect of all property, other than money, which has been or shall be, or which has been or shall be....



464

teaching (including multiple copies for classroom use), scholarship, or research, is not an infringement of copyright. In determining whether the use made of a work in any particular case is a fair use the factors to be considered shall include—

- (1) the purpose and character of the use, including whether such use is of a commercial nature or is for nonprofit educational purposes;
- (2) the nature of the copyrighted work;
- (3) the amount and substantiality of the portion used in relation to the copyrighted work as a whole; and
- (4) the effect of the use upon the potential market for or value of the copyrighted work.

The fact that a work is unpublished shall not itself bar a finding of fair use if such finding is made upon consideration of all the above factors.

Thank you, and I look forward to right relations:

Without Prejudice, 1-308, 1-103
Darrell James Hill

Darrell James Hill
Authorized Representative

Arizona state

Maricopa county

On the day 11 of the month January in the year 2016 CE: Darrell James Hill appeared before me and proved to me on the basis of satisfactory evidence to be the person who affirmed and subscribed hereto and acknowledged to me that he executed the same, and accepts the facts thereof. Subscribed and affirmed before me this day. Witness my hand and seal this

11 day of January, 2016.

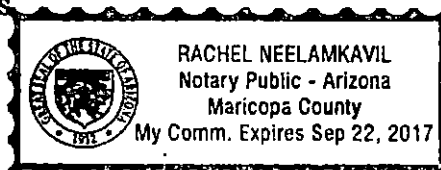

SEAL

Notary
Rachel Neelamkavil

My Commission Expires Sept 22, 2017

DJH JAN 2016 SOS-PR RESPONSE TO NON FILING USPO RMN RE 817 542 585 US 9 of 9

2022-011769 MISC Page: 463 of 2782
09/26/2022 03:35:37 PM Receipt #: 22-9381
Rec Fee: \$30.00 Darrell James Hill
Gila County, Az, Sadie Jo Bingham, Recorder



465

Unofficial Copy

ENCLOSURE ONE:

**Copy of Letter of rejection,
Received 01-03-2016**

466

DJH JAN 2016 SOS-PR RESPONSE TO NON-EILING. USPO RMN RE 817 542 585 US 0 of 0

2022-011769 MISC Page: 464 of 2782
09/26/2022 03:35:37 PM Receipt #: 22-9381
Rec Fee: \$30.00 Darrell James Hill
Gila County, Az, Sadie Jo Bingham, Recorder





*Commonwealth of Puerto Rico
Department of State
San Juan, Puerto Rico*

Darrell James Hill
PO BOX 3806
Apache Junction, Arizona 85120

Dear Darrell James Hill:

Reference is made to the UCC Financing Statement that you sent to be filed at the Commercial Transaction Registry of the Department State of the Commonwealth of Puerto Rico. We are rejecting the document because we don't have jurisdiction over the subject matter.

In addition, our statute establishes that: a debtor means a person who owes payment and is obliged to perform an act; and a secured party is a lender, seller or other person for which there is a security interest in property to guarantee such obligation. This means they must be different persons.

On the other hand, the debtor and the secured party names shall be their legal names.

Enclosed is the money order for \$25.00 with serial number [REDACTED].

Cordially,

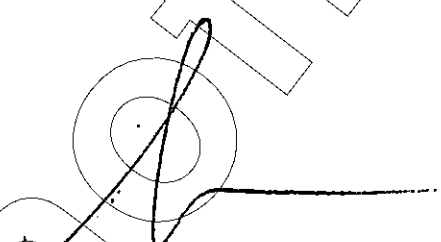
Francisco J. Rodriguez Bernier
Assistant Secretary of State for Services
Commercial Transactions Registry

467

2022-011769 MISC Page: 465 of 2782
09/26/2022 03:35:37 PM Receipt #: 22-9381
Rec Fee: \$30.00 Darrell James Hill
Gila County, Az, Sadie Jo Bingham, Recorder



Beverly-Jean: Romero- Hill
c/o BEVERLY JEAN ROMERO
PO Box 3806
Apache Junction, Arizona 85120

Victor Suárez Meléndez
Secretary of State, Puerto Rico
San Juan, Puerto Rico
Department of State
PO Box 9023271
San Juan, Puerto Rico 00902-3271

Francisco J. Rodríguez Bernier
Assistant Secretary of State for Services
Commercial Transactions Registry
Department of State
PO Box 9023271
San Juan, Puerto Rico 00902-3271

CONDITIONAL ACCEPTANCE

Re: Second letter of rejection without fiduciary duty of explanation: first letter of rejection, received 01-03-2016 -Enclosure One, of the UCC1PR "document" rendering, USPO RMN RE 006 875 532 US, sent 09/15/2015, received 09/25/2015;

ACTUAL NOTICE OF RESET OF PRESUMPTION

Dear Sirs Meléndez, Benier:

I conditionally-accept your letter of rejection of the "document," of the UCC Financing Statement; TO WIT:

- 1) Your acknowledged reason in paragraph one for rejecting the 'document' is only alleged or opinion and not founded in the clarification of the legislation controlling your actions; that is, your rejection of the 'document' was premised upon that 'you do not have subject¹ matter² jurisdiction³ in your ministerial⁴-fiduciary⁵ capacity⁶.' Thus:

1 **SUBJECT. Legislation.** The matter of public or private concern for which law is enacted. See in the nature of State ex rel. Jensen v. Kelly, 65 S.D. 345, 274 N.W. 319, 323.... [The] term "subject" with such constitutional provisions is to be given a broad and extensive meaning so as to allow legislature full scope to include in one act all matters having a logical or natural connection. See in the nature of Shaw v State, 76 Okl.Cr. 271, 134 P.2d 999, 1006; Jaffee v. State, 76 Okl.Cr. 95, 134 P.2d 1027, 1032.- BLACK'S LAW DICTIONARY, 4th, (1968), p.1594.

2 **SUBJECT-MATTER.** The subject, or matter presented for consideration: See in the nature of Plymouth Hospital v. Hart, 178 Okl. 447, 62 P.2d 1248.-BLACK'S LAW DICTIONARY, 4th, (1968), p.1594.

3 **JURISDICTION.** The word is a term of large and comprehensive import, and embraces every kind of judicial action. See in the nature of Federal Land Bank of Louisville Ky., v. Crombie, 258 Ky. 383, 80 S.W.2d 39, 40 [T]he authority by which courts and judicial officers take cognizance of and decide cases. See in the nature of Board of Trustees of Firemen's Relief and Pension Fund of City of Marietta v. Brooks, 179 Okl. 600, 67 P.2d 4, 6.... [T]he legal right by which judges exercise their authority... It is the authority, capacity, power or right to act.. See in the nature of Campbell v. City of Plymouth, 293 Mich. 84, 291 N.W. 2231, 232.- BLACK'S LAW DICTIONARY, 4th, (1968), p.991.

4 **MINISTERIAL.** That which is done under the authority of a superior; opposed to *judicial*; that which involves obedience to instructions, but demands no special discretion, judgment, or skill. See in the nature of State Tax Commission of Utah v. Katsis, 90 Utah 406, 62 P.2d 120, 123, 107 A.L.R. 1477; Blalock v. Johnston, 180 S.C. 40, 185 S.E. 51, 105 A.L.R. 1115; First Nat. Bank

BJR JAN 2016 SOS-PR RESPONSE TO

2022-011769 MISC Page: 466 of 2782
09/26/2022 03:35:37 PM Receipt #: 22-9381
Rec Fee: \$30.00 Darrell James Hill
Gila County, Az, Sadie Jo Bingham, Recorder



468

- 1a) I accept that you do not have subject-matter jurisdiction over the content of the instrument⁷; and, therefore,
- 1b) I accept that you have ministerial duty for the items of content of the "UCC1-PR" document presenting the instrument in the rendering for filing. To this end,
- 1c) I reiterate, you possess and was/is authorized No subject-matter jurisdiction over the content of the instrument. Therefore,
- 1d) I accept that, in your fiduciary capacity to the principal⁸, any self-proposed jurisdiction

2022-011769 MISC Page: 467 of 2782
 09/26/2022 03:35:37 PM Receipt #: 22-9381
 Rec Fee: \$30.00 Darrell James Hill
 Gila County, Az, Sadie Jo Bingham, Recorder

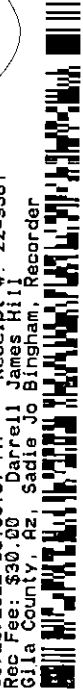

v. filer, 107 Fla. 526, 145 So. 204, 207, 87 A.L.R. 267.- BLACK'S LAW DICTIONARY, 4th, (1968), p.1148.

MINISTERIAL DUTY. One regarding which nothing is left to discretion—a simple and definite duty, imposed by law, and arising under conditions admitted or proved to exist. See in the nature of *City of Tacoma v. Peterson*, 165 Wash. 461, 5 P.2d 1022, 1024. *Mott v. Hull*, 51 Okl. 602, 152 P. 92, L.R.A.1916B, 1184. It arises when an individual has such a legal interest in its performance that neglect of performance becomes a wrong to such individual. See in the nature of *Morton v. Comptroller General*, 4 S.C. 473.- BLACK'S LAW DICTIONARY, 4th, (1968), p.1148.

5 FIDUCIARY. The term is derived from the Roman law, and means (as a noun) a person holding the character of a trustee, or a character analogous to that of a trustee, in respect to the trust and confidence involved in it and the scrupulous good faith and candor which it requires. See in the nature of *Svanoe v. Jurgens*, 144 Ill. 507, 33 N.E. 955; *Stoll v. King*, 8 How.Prac. N.Y., 299. A person having duty, created by his undertaking, to act primarily for another's benefit in matters connected with such undertaking. See in the nature of *Haluka v Baker*, 66 Ohio App. 308, 34 N.E.2d 68, 70.- BLACK'S LAW DICTIONARY, 4th, (1968), p.753.

6 FIDUCIARY CAPACITY. One is said to act in a "fiduciary capacity" or to receive money or contract a debt in a "fiduciary capacity," when the business which he transacts, or the money or property which he handles, is not his own for for his own benefit, but for the benefit of another person, as to whom he stands in a relation implying and necessitating great confidence and trust on the one part and a high degree of good faith on the other part. The term is not restricted to technical or express trusts, but also such offices or relations as those of an attorney at law, a guardian, executor, or broker, a director of a corporation, and a public officer. See in the nature of *Templeton v Bockler*, 73 Or. 494, 144 P. 405, 409; *Madison Tp. v. Dunkle*, 114. Ind. 262, 16 N.E. 593.- BLACK'S LAW DICTIONARY, 4th, (1968), p.753.

7 INSTRUMENT. A written document; a formal or legal document in writing, such as a contract, deed, will, bond, or lease. See in the nature of *State v. Phillips*, 157 Ind. 481, 62 N.E. 12; *Cardenas v. Miller*, 108 Cal. 250, 39 P. 783, 49 AmSt.Rep. 84.

Anything reduced to writing, a document of a formal or solemn character, a writing given as a means of affording evidence. See in the nature of *Smith v. Smith*, Ind. App., 110 N.E. 1013, 1014. A document or writing which gives formal expression to a legal act or agreement, for the purpose of creating, securing, modifying, or terminating a right; a writing executed and delivered as the evidence of an act or agreement. See in the nature of *Moore v. Diamond Dry Goods Co.*, 47 Ariz. 128, 54 P.2d 553, 554.- BLACK'S LAW DICTIONARY, 4th, (1968), p.941.

8 PRINCIPAL, n. The source of authority or right.... See in the nature of *Williams v School Dist. No. 189*, 104 Wash. 659, 177 P. 635, 636.... **Law of Guaranty and Suretyship**

The person primarily liable, for whose performance of his obligation the guarantor or surety has become bound. See in the nature of *Rollings v Gunter*, 211 Ala. 671, 101 So. 446, 448.- BLACK'S LAW DICTIONARY, 4th, (1968), p.1355.

469

over and above the UCC1-PR component in the rendering for the principal's legal⁹-right¹⁰
¹¹ of redemption of any proceeds of property/ proceeds constitutes i) legal advice, ii)
 opinion and iii) is error¹²-at-law or legal fraud.^{13 14} And,

- 1e) I ascertained no fact(s) for why these facts are not true.
- 2 As you indicated in paragraph two, you defined "debtor" means a person¹⁵...". Please provide statute information upon which you relied in the English language so that we may agree. Generically, See in the nature of UCC 9-102 (28) "Debtor"¹⁶ means: (A) a person having an interest¹⁷, other than a security interest¹⁸ or other lien, in the collateral¹⁹,

9 **LEGAL**. 1. Conforming to the law; according to law; required or permitted by law; not forbidden or discountenanced by law; good and effectual in law. See in the nature of Freeman v. Fowler Packing Co., 135 Kan. 378, 11 P.2d 276, 277; General Motors Acceptance Corporation v. Schwartz, 118 N.J.L. 25, 190 A. 625, 627... - BLACK'S LAW DICTIONARY, 4th, (1968), p.1038.

10 **RIGHT**. As a noun, and taken in an abstract sense, justice, ethical correctness, or consonance with the rules of law or the principles of morals. In this signification it answers to one meaning of the Latin "jus," and serves to indicate law in rights, or the complex of underlying moral principles which impart the character of justice to all positive law, or give it an ethical content.

As a noun, and taken in a concrete sense, a power, privilege, faculty, or demand, inherent in one person and incident upon another. "Rights" are defined generally as "powers of free actions." And the primal rights pertaining to men are undoubtedly enjoyed by human beings purely as such, being grounded in personality, and existing antecedently to their recognition by positive law. But leaving the abstract moral sphere, and giving to the term a juristic content, a "right" is well defined as "a capacity residing in one man of controlling, with the assent and assistance of the state, the actions of others." See in the nature of Holl. Jur. 69 - BLACK'S LAW DICTIONARY, 4th, (1968), p.1486.

11 **LEGAL RIGHT**. Natural rights, rights existing as result of contract, and rights created or recognized by law. See in the nature of Five v. Pratt, Tex.Civ.App., 150 S. W.2d 308, 311.- BLACK'S LAW DICTIONARY, 4th, (1968), p.1042.

12. **ERROR**. A mistaken judgment or incorrect belief as to the existence or effect of matters of fact, or a false or mistaken conception or application of the law.... And act involving a departure from truth or accuracy. See in the nature of Gronseth v. Mohn, 57 S.D. 604, 234 N.W. 603, 604... - BLACK'S LAW DICTIONARY, 4th, (1968), p.788.

13 **LEGAL FRAUD**. Contracts or acts as, though not originating in actual evil design to perpetrate fraud, yet by their tendency to mislead others or to violate confidence, are prohibited by law. See in the nature of Ruedy v. Toledo Factories Co., 61 Ohio App. 21, 22 N.E.2d 293, 297. Breach of duty which has tendency to deceive others and operates to their injury, even though there be no vicious intent. See in the nature of Charlerol Lumber Co. V. School Dist. of Borough of Bentleyville, 334 Pa. 424, 6 A.2d 88, 91.

Synonymous with "constructive fraud". See in the nature of Purcell v. Robertson, 122 W.Va. 287, 8 S.E.2d 881, 883; Tom Reed Gold Mines Co. United Eastern Mining Co., 39 Ariz. 533, 8 P.2d 449, 451.- BLACK'S LAW DICTIONARY, 4th, (1968), p.1040.

14 **FRAUD**. An intentional perversion of truth for the purpose of inducing another in reliance upon it to part with some valuable thing belonging to him or to surrender a legal right; a false representation of a matter of fact, whether by words or by conduct, by false or misleading allegations, or by concealment of that which should have been disclosed, which deceives and is intended to deceive another so that he shall act upon it to his legal injury. See in the nature of Brainerd Dispatch Newspaper Co. v. Crow Wing County, 196 Minn. 194, 264 N.W. 779, 780... - BLACK'S LAW DICTIONARY, 4th, (1968), p.788.

15 "Person" means an individual, corporation, business trust, estate, trust, partnership, limited liability company, association, joint venture, government, governmental subdivision, agency, or instrumentality, public corporation, or any other legal or commercial entity. See in the nature of UCC 1-201 (27).

PERSON. A man considered according to the rank he holds in society, with all the right to which the place he holds entitles him, and the duties which it imposes. See in the nature of People v. R. Co., 134 N.Y. 506, 31 N.E. 873.- BLACK'S LAW DICTIONARY, 4th, (1968), p.1299.

16 **DEBTOR**. One who owes a debt: he who may be compelled to pay a claim or demand. Anyone liable on a claim, whether due or to become due. See in the nature of Cozart v. Barnes, C.C.A.S.C., 240 F. 935, 938.

The term may be used synonymously with "obligor," "mortgagor," and the like. See in the nature of McDuffie v. Faulk, 214 Ala. 221, 107 So. 61, 62.- BLACK'S LAW DICTIONARY, 4th, (1968), p.492.

17 **INTEREST**. Property. The most general term that can be employed to denote a property in lands or chattels. In its application to lands or things real, it is frequently used in connection with the terms "estate," "right," and "title," and , according to Lord Coke, it properly includes them all. See in the nature of Co. Litt. 345b. State v. KcKellop, 40 Mo. 185; Loventhal v.



470

whether or not the person is an obligor.²⁰

- 2a) Clearly, the term "debtor" is a person with an obligation of a contract²¹ interest. And,
- 2b) A "person" as indicated in the nature of UCC 1-201 (27) means an individual, corporation, ... or any²² other²³ legal or²⁴ commercial²⁵ entity²⁶; to wit: any alien person, any real being or commercial real being. UCC 1-201 thereby clearly specifies that a person means both: i) a fictitious person or individual, and ii) any real person without exclusion, including a private and natural man in any commerce with an interest in any collateral. Therefore, herenow,

Home Ins. Co., 20 So. 419, 112 Ala. 116, 33 L.R.A. 258, 57 Am.St.Rep. 17. More particularly it means a right to have the advantage accruing from anything; any right in the nature of property, but less than title; a partial or undivided right; a title to a share. - See in the nature of BLACK'S LAW DICTIONARY, 4th, (1968), p.950

18 "Security interest" means an interest in personal property or fixtures which secures payment or performance of an obligation.... See in the nature of UCC 1-201 (35).

19 "Collateral" means the property subject to a security interest.... The term includes:

(A) proceeds to which a security interest attaches:

(B) accounts, chattel paper, payment intangibles, and promissory notes that have been sold; and See in the nature of UCC 9-102 (12).

20 **OBLIGOR.** The person who has engaged to perform some obligation. See in the nature of Code La. Art. 3522, mo. 12, CivCode, art. 3556, subd. 21. One who makes a bond.

Includes person liable for tort. See in the nature of *Sarine v. American Lumbermen's Casualty Co. of Illinois*, 258 App.Div. 653, 17 N.Y.S.2d 754, 756.- BLACK'S LAW DICTIONARY, 4th, (1968), p.1226.

21 **OBLIGATION OF A CONTRACT.** That which law in force when contract is made obliges parties to do or not to do, and remedy and legal means to carry it into effect. See in the nature of *Harris v. Monroe Building & Loan Ass'n*, La.App., 154 So. 503, 505.

As used in Const. U.S. Art. 1 § 10, the term means the binding and coercive force which constrains every man to perform the agreements h has made; a for grounded in the ethical principle of fidelity to one' promises, but deriving its legal efficacy from its recognition by positive law, and sanctioned by the law's providing a remedy for the infraction of the duty or for the enforcement of the correlative right. See in the nature of *Story*, Const. § 1378; *Black Const. Prohib. § 139*; *Ogden v. Saunders*, 12 Wheat 213, 6 L.Ed 606.

The "obligation of a contract" is its binding force according to the standards of law in existence when it was made. See in the nature of *Colby v. City of Medford*, 85 Or. 485, 167 P. 487, 499. The "obligation of a contract" is the duty of performance. See in the nature of *Hays v. Port of Seattle*, D.C.Wash., 266 f. 287, 293. The term includes everything with the obligatory scope of the contract, and it includes the means of enforcement. See in the nature of *E J. Lander & Co. v. Deemy*, 46 N.D. 273, 176 N.W. 922, 925; *Franklin Sugar Refining Co. v. Martini-Nelly Grocery Co.*, 94 W.Va. 504, 119 S.E. 473, 476.- BLACK'S LAW DICTIONARY, 4th, (1968), p.1226.

22 **ANY.** Some; one out of many; an indefinite number. See in the nature of *State v. Pierson*, 204 Iowa 837, 216 N.W. 43, 44. One indiscriminately of whatever kind or quantity. See in the nature of *Federal Deposit Ins. Corporation v. Winton*, C.C.A.Tenn., 131 F.2d 780, 782... - BLACK'S LAW DICTIONARY, 4th, (1968), p.120.

23 **OTHER.** Different or distinct from that already mentioned; additional, or further. See in the nature of *City of Ft. Smith v. Gunter*, 106 Ark. 371, 154 S.W. 181, 183; *State v. Blumenthal*, 136 Ark. 532, 203 S.W. 36, 37, L.R.A.1918E, 482.- BLACK'S LAW DICTIONARY, 4th, (1968), p.1253.

24 **OR. conj.** A disjunctive particle used to express an alternative or to give a choice of one among two or more things. It is also used to clarify what has already been said, and in such cases, means "in other words," "to-wit", or "that is to say." See in the nature of *Peck v. Board of Directors of Public Schools for Parish of Catahoula*, 137 La. 334, 68 So. 629, 630; *Travelers' Protective Ass'n v. Jones*, 75 Ind. App. 29, 127 N.E. 783, 785... - BLACK'S LAW DICTIONARY, 4th, (1968), p.1246.

25 **COMMERCIAL.** Relating to or connected with trade and traffic or commerce in general. See in the nature of "Zante Currents", C.C.Cal., 73 F. 189. Occupied with commerce. See in the nature of *Bowles v. Co-Operative G. L. F. Farm Products*, D.C.N.Y., 53 F.Supp. 413, 415.- BLACK'S LAW DICTIONARY, 4th, (1968), p.336.

COMMERCE. The exchange of goods, productions, or property of any kind. See in the nature of *Jeu Jo Wan v. Nagle*, C.C.A.Cal., 9 F.2d 309, 310.- BLACK'S LAW DICTIONARY, 4th, (1968), p.336.

26 **ENTITY.** A real being; existence. See in the nature of *Department of Banking v. Hedges*, 136 Neb. 382, 286 N.W. 277, 281.-

BJR JAN 2016 SOS-PR RESPONSE TO NON-FILING USPO RMN RE 817 542 585 US 4-60

2022-011769 MISC Page: 469 of 2782

09/26/2022 03:35:37 PM Receipt #: 22-9381

Rec Fee: \$30.00 Darrell James Hill

Gila County, Az, Sadie Jo Bingham, Recorder



471

- 2c) It is determinate that the UCC, and the statutes establishing, admits all debtor entity parties in interest in commerce without exclusion. And,
- 3 As you indicated in paragraph two, you defined "secured party" means a person" Please provide statute information upon which you relied in the English language so that we may agree. Generically, in the nature of UCC 9-102 (73) "Secured party" means: (A) a person in whose favor a security interest²⁷ is created or provided for under a security agreement²⁸, whether or not any obligation to be secured is outstanding; ... (E) a trustee, indenture trustee, agent collateral agent, or other representative in whose favor a security interest... is created or provided for; or.... Thus,
- 3a) As made definite above the tenets of the secured party personage and relative interest in commerce is expressly provided for by the UCC without exclusion. Moreover,
- 3b) The UCC provides that presumption setting of the of personage and standing in right²⁹ may be set by one's chose in action³⁰ and such one aggrieved of that right may seek remedy.³¹ And,
- 4 Your paragraph 3 proffers that "the debtor and the secured party names³² shall be their legal names.³³" So, as is made clear in the previous sections, that in accordance with the UCC and establishing statutes, as all personages in commerce are recognized by the UCC and the statutes, the only possible remaining obstacle to your affirmative filing of my any rendering is the "legal name" usage for all parties upon the UCC1-PR document under your ministerial duty. Please send to me the information upon which you have made your assertion. To be clear, then:
 - 4a) The legal name of a corporation would be the registered name of that corporation; The legal name of a stock or certificate³⁴ holder would be the name listed on the stock or certificate instrument;

BLACK'S LAW DICTIONARY, 4th, (1968), p.626.

27 "Security interest" means an interest in personal property or fixtures which secures payment or performance of an obligation.... See in the nature of UCC 1-102 (35).

28 "Security agreement" means an agreement that creates or provides for a security interest. See in the nature of UCC 9- 102 (74).

29 "Right" includes remedy. See in the nature of UCC 1-201 (34) .

30 "Reservation of Rights" (a) A party that with explicit reservation of rights performs or promises performance or assents to performance in a manner demanded or offered in a manner demanded or offered by the other party does not thereby prejudice the rights reserved. Such Words as "without prejudice," "under protest," or the like are sufficient. See in the nature of UCC 1-308.

31 "Remedy" means any remedial right to which an aggrieved party is entitled with or without resort to a tribunal. See in the nature of UCC 1-301(32).

32 NAME. The designation of an individual person, or of a firm or corporation. See in the nature of Riley v. Litchfield 168 Iowa 187, 150 N.W. 81, 83, Ann.Cas. 1917B, 172.- BLACK'S LAW DICTIONARY, 4th, (1968), p.1174.

33 LEGAL NAME. Under common law consists of one Christian name and one surname, and the insertion, omission, or mistake in middle name or initial is immaterial. See in the nature of Langley v. Zurich General Accident & Liability Ins. Co., 97 Cal.App. 434, 275 P. 963, 65.- BLACK'S LAW DICTIONARY, 4th, (1968), p.1040.

34 CERTIFICATE. ... A written assurance, or official representation, that some act has or has not been done, or some event occurred, or some legal formality has been complied with. ... A "certificate" by a public officer is a statement written an signed, but no necessarily or customarily sworn to, which is by law made evidence of the truth of the facts stated for all of for certain purposes. See in the nature of State v. Abernethy, 190 N.C. 768, 130 S.E. 619, 620.- BLACK'S LAW DICTIONARY, 4th, (1968), p.285.

472



The legal name of a man would be his given common law Christian name and surname;³⁵ and: The 'legal name,' on the Birth Certificate, public organic record³⁶, would be the name listed on that instrument. Therefore,

- 4b) Specific to the rendering in question, a legal stramineus homo³⁷ name on the Birth Certificate is the legal entity name thereto and is a name without a "surname" by form though it is composed of the elements of the legal name of the principal and real party in interest, the man with the legal name. And,
- 4c) Specific to the rendering in question, the legal name of the principal and real party in interest in the certificate of birth is the man from whom the stramineus homo legal entity name is derived³⁸. Thus,
- 4d) Though the stramineus homo legal entity name on the birth certificate and the legal name of the man are similar in appearance and sound, in fact they are not identical in origin or law. Moreover, the stramineus homo legal entity name of the birth certificate is identified by the UCC to be an "individual" of legal construct, to wit, an evidence of the right of transmission,³⁹ ⁴⁰whereas the legal name of the man is a "private"⁴¹ individual of natural origin in commerce. However, this discussion is beyond the scope of this remedy. Finally,
- 4e) Specific to the rendering in question, the remaining name requiring review is that of the legal name of the debtor, the "Secretary of the Treasury," also known as: "Secretary," "Secretary of the Treasury of Puerto Rico," "Secretary of the Treasury of the Commonwealth of Puerto Rico." However, I will refer to the debtor as "Secretary of the Treasury" for reasons; to wit:
- 4f) In positive law of Congress in support of the subsequent Executive Orders thereto, the President(s) used the title "Secretary of the Treasury"⁴² vesting the duties and responsibilities of the "Alien Property Custodian"⁴³ and the "common-law trustee"⁴⁴ onto

35 SURNAME. The family name; the name over and above the Christian name. The part of a name which is not given in baptism; the name of a person which is derived from the common name of his parents; See in the nature of *In re Faith's Application*, 22 N.J. Misc. 412, 39 A.2d 638, 640. The last name; the name common to all members of a family. A patronymic. See in the nature of *Riley v. Litchfield*, 168 Iowa 187, 150 N.W. 81, 83, Ann.Cas.1917B, 172.- BLACK'S LAW DICTIONARY, 4th, (1968), p.1612.

36 See in the nature of UCC 9-503.

37 STRAMINEUS HOMO. L. Lat. A man of straw, one of no substance, put forward as bail or surety. See in the nature of BLACK'S LAW DICTIONARY, 4th, (1968), p.1590.

38 DERIVE. To receive, a from a source or origin. See in the nature of *Crews. v. Commissioner of Internal Revenue*, C.C.A. 10, 89 F.2d 412, 416. - **DERIVED.** Received. See in the nature of *Langstaff v. Lucas*, D.C., 9 F.2d 691, 693. See, also, in the nature of *Connell v. Harper*, 202 Ky. 406, 259 S.W. 1017, 1019.- BLACK'S LAW DICTIONARY, 4th, (1968), p.530.

39 TRANSMISSION. In the civil law. The right which heirs or legatees may have of passing to their successors the inheritance or legacy to which they were entitled, if they happen to die without having exercised their rights. See in the nature of *Domat*, liv. 3, t.1, s 10; *Toullier*, no. 186; *Dig.* 50, 17, 54; *Code*, 6, 51.- BLACK'S LAW DICTIONARY, 4th, (1968), p.1670.

40 "transmitting utility" means the utility of transmission; to wit, the utility of use of the Birth Certificate and the legal stramineus homo name thereto any the man citizen of the sovereign several states as relates to the Trading with the Enemy Act of 1917 and the Emergency Bank Relief Act, enacted March 09, 1933, and Executive Orders thereto.

41 PRIVATE. Affecting or belonging to private individuals, as distinct from the public generally. Not official; not clothed with office. See in the nature of *People v. Powell*, 280 Mich. 699, 274 N.W. 372, 373, 111 A.L.R. 721. As to private "Act," "Agent," "Bill," ... - BLACK'S LAW DICTIONARY, 4th, (1968), p.1358.

42 See in the nature of UCC 9-503.

Page: 471 of 2782

MISC

2022-011769

09/26/2022 03:35:37 PM

Rec Fee: \$30.00

Darrell James Hill

Sadie Jo Bingham, Recorder

Gila County, Az.

479

the "Secretary of the Treasury" thereby creating our common commercial interest(s); however, this discussion is beyond the scope of this remedy. If you have an alternative for the named and addressed debtor party then please provide that information.

In conclusion, the conditional acceptance of your 01/03/2016 document is as indicated above. Every effort was made to achieve a remedy within the UCC and supporting legislation. No authority to judge the content of the instrument is authorized. No legal advice is authorized.

Enclosed is the corrected UCC1-PR document in the rendering. Any further rejection problems must be addressed expediently, and established in accordance with the applicable depended upon UCC, statutes and law; provision of the foundation for your assertions shall be documented.

You have seven days beginning upon the receipt of this rendering to respond, with three days for return mailing delivery time before default proceedings will be commenced. If you need more time to comply/ respond then your written request for extension of time made within the seven day period will not be unreasonably withheld.

COPYRIGHT NOTICE

The above-mentioned "non corporate entity" is quoting citations 'as purported in' context to copyrighted case law, statutes, rules of court and court decision material as found in books published with Federal or state funding supplied by the Citizens of the united States of America and intended for use by attorneys, and does so under the provisions of the Fair use clause of the copyright laws of the United States: by the term, "see in the nature of."

Notwithstanding the provisions of in the nature of sections 106 and 106A, the fair use of a copyrighted work, including such use by reproduction in copies or phonorecords or by any other means specified by that section, for purposes such as criticism, comment, news reporting,

43 EXECUTIVE ORDER NO. 11281. May 13, 1966, 31 F.R. 7215, TRANSFERRING JURISDICTION OVER BLOCKING ASSETS FROM ATTORNEY GENERAL TO SECRETARY OF THE TREASURY.

SEC. 5. SECTION 1 of Executive Order No. 10644 of November 7, 1955 [formerly set out under section 1631a of Title 22, Foreign Relations and Intercourse], is hereby amended to read as follows:

"SECTION 1. ... (b) The Secretary of the Treasury, and any officer, person, agency or instrumentality designated by the Secretary of the Treasury for this purpose, as hereby designated and empowered to perform the functions conferred upon the President by section 202 of Title II with respect to the release of blocked property and of the net proceeds of property that are carried in blocked accounts with the Treasury." See in the nature of U.S.C. Title 50, APPENDIX—WAR AND NATIONAL DEFENSE, Sec. 1 Trading with the Enemy Act of 1917.

SEC. 7. ... (c) ... The sole relief and remedy of any person having any claim to any money or other property heretofore or hereafter conveyed, transferred, assigned, delivered, or paid over to the Alien Property Custodian, or required so to be, or seized by him shall be that provided by the terms of this Act [said sections], and in the event of sale or other disposition of such property by the Alien Property Custodian, shall be limited to and enforced against the net proceeds received therefrom and held by the Alien Property Custodian or by the Treasurer of the United States....

44 EXECUTIVE ORDER NO. 11281. May 13, 1966, 31 F.R. 7215, TRANSFERRING JURISDICTION OVER BLOCKING ASSET FROM ATTORNEY GENERAL TO SECRETARY OF THE TREASURY

SEC. 12. ... The alien property custodian shall be vested with all of the powers of a common-law trustee in respect of all property, other than money, which has been or shall be, or which has been or shall be....

474

2022-011769 MISC Page: 472 of 2782
09/28/2022 03:35:37 PM Receipt #: 22-9381
Rec Fee: \$30.00 Darrell James Hill
Gila County, Az, Sadie Jo Bingham, Recorder

teaching (including multiple copies for classroom use), scholarship, or research, is not an infringement of copyright. In determining whether the use made of a work in any particular case is a fair use the factors to be considered shall include—

- (1) the purpose and character of the use, including whether such use is of a commercial nature or is for nonprofit educational purposes;
- (2) the nature of the copyrighted work;
- (3) the amount and substantiality of the portion used in relation to the copyrighted work as a whole; and
- (4) the effect of the use upon the potential market for or value of the copyrighted work.

The fact that a work is unpublished shall not itself bar a finding of fair use if such finding is made upon consideration of all the above factors.

Thank you, and I look forward to right relations:

Without Prejudice, 1-308, 1-103
BEVERLY JEAN ROMERO

Beverly Jean Romero-HIV
Authorized Representative

Arizona state

Maricopa county

On the day 11 of the month January in the year 2016 CE: Legal Name appeared before me and proved to me on the basis of satisfactory evidence to be the person who affirmed and subscribed hereto and acknowledged to me that he executed the same, and accepts the facts thereof. Subscribed and affirmed before me this day. Witness my hand and seal this

11 day of January, 2016.



SEAL

Notary
Rachel Neelamkavil

My Commission Expires Sept 22 2017

2022-011769 MISC Page: 473 of 2782
 09/25/2022 03:35:37 PM Receipt #: 22-9381
 Rec Fee: \$30.00 Darrell James Hill
 Gila County, Az. Sadie Jo Bingham, Recorder

475

Unofficial Copy

ENCLOSURE ONE:

**Copy of Letter of rejection,
Received 01-03-2016**

2022-011769 MISC Page: 474 of 2782
09/26/2022 03:35:37 PM Receipt #: 22-9381
Rec Fee: \$30.00 Darrell James Hill
Gila County, Az, Sadie Jo Bingham, Recorder

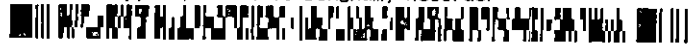

476



*Commonwealth of Puerto Rico
Department of State
San Juan, Puerto Rico*

Beverly Jean Romero-Hill
PO BOX 3806
Apache Junction, Arizona 85120

Dear Beverly Jean Romero-Hill:

Reference is made to the UCC Financing Statement that you sent to be filed at the Commercial Transaction Registry of the Department State of the Commonwealth of Puerto Rico. We are rejecting the document because we don't have jurisdiction over the subject matter.

In addition, our statute establishes that: a debtor means a person who owes payment and is obliged to perform an act; and a secured party is a lender, seller or other person for which there is a security interest in property to guarantee such obligation. This means they must be different persons.

On the other hand, the debtor and the secured party names shall be their legal names.

Enclosed is the money order for \$25.00 with serial number 22715966305.

Cordially,

Francisco J. Rodríguez Bernier
Assistant Secretary of State for Services
Commercial Transactions Registry

477

2022-011769 MISC Page: 475 of 2782
09/26/2022 03:35:37 PM Receipt #: 22-9381
Rec Fee: \$30.00 Darrell James Hill
Gila County, Az, Sadie Jo Bingham, Recorder





DECLARACIÓN DE FINANCIAMIENTO / FINANCING STATEMENT
SIGA INSTRUCCIONES / FOLLOW INSTRUCTIONS

A. NOMBRE Y NÚMERO DE CONTACTO (opcional) / NAME & PHONE OF CONTACT AT FILER (optional)
Darrell James Hill

B. CORREO ELECTRÓNICO DE CONTACTO (opcional) / E-MAIL CONTACT AT FILER (optional)
djhill4yah@gmail.com

C. ENVIAR CONFIRMACIÓN A (Nombre y Dirección): / SEND ACKNOWLEDGMENT TO: (Name and Address)

Secretary of the Treasury
c/o Melba Acosta Febo
PO Box 9024140
San Juan, Puerto Rico 00902-4140

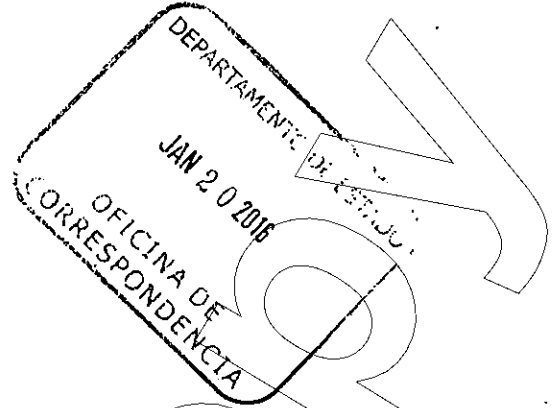

EL ESPACIO ARRIBA ES PARA USO DEL OFICIAL DE REGISTRO
THE ABOVE SPACE IS FOR FILING OFFICE USE ONLY

1. NOMBRE DEL DEUDOR / DEBTOR'S NAME: Provea sólo un nombre de Deudor (1a o 1b) (use el nombre completo y exacto, no omita, modifique o abrevie ningún componente del nombre); si algún aparte del nombre del Deudor no cabe en la línea 1b, déjela en blanco, marque aquí y provea la información del Deudor Individual en el renglón 10 del Anejo a la Declaración de Financiamiento (Forma UCC1AdPR) / Provide only one Debtor name (1a or 1b) (use exact, full name; do not omit, modify, or abbreviate any part of the Debtor's name); if any part of the Individual Debtor's name will not fit in line 1b, leave all of item 1 blank, check here and provide the Individual Debtor information in item 10 of the Financing Statement Addendum (Form UCC1AdPR)

1a. NOMBRE DE LA ENTIDAD / ORGANIZATION'S NAME
Secretary of the Treasury

OR

1b. APELLIDO / INDIVIDUAL'S SURNAME	NOMBRE / FIRST PERSONAL NAME	SEGUNDO NOMBRE / ADDITIONAL NAME	SUFIJO / SUFFIX

1c. DIRECCIÓN POSTAL / MAILING ADDRESS
PO Box 9024140

CIUDAD / CITY San Juan	ESTADO STATE PR	CÓDIGO POSTAL / POSTAL CODE 00902-4140	PAÍS COUNTRY US
----------------------------------	---------------------------	--	---------------------------

2. NOMBRE DEL DEUDOR/ DEBTOR'S NAME: Provea sólo un Deudor adicional (2a o 2b) (Use el nombre completo y exacto; no omita, modifique o abrevie ninguna parte del nombre). Si cualquier parte de un nombre no cupiera en el el espacio provisto en la 2b, deje toda la sección 2 en blanco, marque aquí y provea el nombre completo en el renglón 10 en el Anejo de la Declaración de Financiamiento (Forma UCC1AdPR) / Provide only one Debtor name (2a or 2b) (use exact, full name; do not omit, modify, or abbreviate any part of the Debtor's name); if any part of the Individual Debtor's name will not fit in line 2b, leave all of item 2 blank, check here and provide the Individual Debtor information in item 10 of the Financing Statement Addendum (Form UCC1AdPR)

2a. NOMBRE DE LA ENTIDAD / ORGANIZATION'S NAME

OR

2b. APELLIDO / INDIVIDUAL'S SURNAME	NOMBRE / FIRST PERSONAL NAME	SEGUNDO NOMBRE / ADDITIONAL NAME	SUFIJO / SUFFIX

2c. DIRECCIÓN / MAILING ADDRESS

CIUDAD / CITY	ESTADO STATE	CÓDIGO POSTAL / POSTAL CODE	PAÍS COUNTRY

3. NOMBRE DEL ACREEDOR GARANTIZADO (o NOMBRE DE CESIONARIO): Provea solo un nombre de Acreedor Garantizado (3a o 3b)
SECURED PARTY'S NAME (or NAME of ASSIGNEE): Provide only one Secured Party name (3a or 3b)

3a. NOMBRE DE LA ENTIDAD / ORGANIZATION'S NAME

OR

3b. APELLIDO / INDIVIDUAL'S SURNAME Hill	NOMBRE / FIRST PERSONAL NAME Darrell James	SEGUNDO NOMBRE / ADDITIONAL NAME	SUFIJO / SUFFIX

3c. DIRECCIÓN POSTAL / MAILING ADDRESS
c/o PO Box 3806

CIUDAD / CITY Apache Junction	ESTADO STATE AZ	CÓDIGO POSTAL / POSTAL CODE 85120	PAÍS COUNTRY US
---	---------------------------	---	---------------------------

4. COLATERAL: Esta declaración de financiamiento cubre la siguiente colateral: / COLLATERAL: This financing statement covers the following collateral:

The trust beneficiary/secured party's right of trust collateral usufruct under the Trading with the Enemy Act of 1917, the Emergency Bank Relief Act -enacted March 09, 1933, and the Executive Orders thereto for the trust beneficiary/real party in interest as identified by the utility of the transmission, the organic document/"CERTIFICATE OF LIVE BIRTH;" the collateral interest thereto activated by law by this chose in action on proof to be alive- sui juris in any action for the recovery of interest of the same.

SEE USPO m/o \$25.00 # 22715916294

5. Marque solo si aplica y solo una opción: Colateral está en posesión de un Fideicomiso (véase UCC1AdPR, renglón 7 e instrucciones) administrado por Representante de un difunto. Check only if applicable and check only one box: Collateral is held in a Trust (See UCC1AdPR, Item 17 and instructions) being administered by a Decedent's Personal Representative

6a. Marque solo si aplica y una sola alternativa / Check only if applicable and check only one box:

Transacción de Financiamiento Público / Public-Finance Transaction Transacción de Casa Prefabricada / Manufactured-Home Transaction Un Deudor es una entidad transmisora / A Debtor is a Transmitting Utility

6b. Marque solo si aplica y solo una alternativa / Check only if applicable and check only one box:

Gravamen Agrícola / Agricultural Lien Inscripción extraregistrada / Non-UGC Filing

7. DESIGNACIÓN ALTERNA (si aplica): Arrendador/Arrendatario / Lessor/Lessee Consignatario/ Consignador / Consignee/Consignor Vendedor/ Comprador / Seller/Buyer Depositario/ Fidor / Bailee/Bailor Concesionario/Concedente / Licensee/Licensor

8. DATO S OPCIONALES DE REFERENCIA PARA EL SOLICITANTE / OPTIONAL FILER REFERENCE DATA: **Stamp Accepted and return second original with in the enclosed CASE. Thank-you.**

C OPIA OFICINA DE REGISTRO—DECLARACIÓN DE FINANCIAMIENTO (Forma UCC1PR) (Rev. 05/09/14)



478



SECURITY AGREEMENT DJH002-SA 09142015-SA CE
Non-Negotiable – Private Agreement Between two Parties

Beneficiary:

DARRELL JAMES HILL
c/o ~~Juan Zaragoza Gomez~~,
Secretary of the Treasury
Department of the Treasury,
P.O. Box 9024140,
San Juan, Puerto Rico 00902-4140

Trustee:

~~Juan Zaragoza Gomez~~,
Secretary of the Treasury
Department of the Treasury,
P.O. Box 9024140,
San Juan, Puerto Rico 00902-4140

COPIES

1 **Security Agreement:**
2 **Authorization Of Expenditure Of Account Benefits:**
3 **DARRELL JAMES HILL, CUSIP Number [REDACTED]**

4 This Security Agreement is for to input this "Authorization For The Benefits Requested"
5 to the preexisting Fiduciary Trust Relationship existing from the creation of the novation
6 "DARRELL JAMES HILL" Cesti Qui Trust, "CQT", between the Trustee, the Office of
7 the Secretary of the Treasury, Foreign Property Custodian, and Claims Settlement Officer,
8 et al., Puerto Rico, "Trustee", and the principal live born child "Hill Darrell-James" also
9 known as "Darrell-James: Hill" sui juris, the Authorized Representative of the novation
10 and the private person substantiating the existence of the novation. See the: A) Birth
11 Certificate: ENCLOSURE One; B) Arizona Driver's License: ENCLOSURE Two; C)
12 Political Status Election, DJH002-PE, A.D. 09142015-PE: ENCLOSURE Three. .

13 **This: Security Agreement corroborates that:**

- 14 a) The presence of the benefit of equity held within the CQT by the Trustee is for the
- 15 novation Beneficiary of/for the Principal Beneficiary, and for the chose of benefit by
- 16 the Beneficiary upon request/ demand as stated herein; and:
- 17 b) This Security Agreement is a continuing instrument expressly in the favor of the
- 18 Beneficiary, which continues in the effect though all, or any part of, indebtedness
- 19 that was, is or may be discharged/ settled in the full, and notwithstanding of the fact
- 20 that a period of a time may pass in which the Beneficiary incurs no indebtedness
- 21 necessitating a requirement of the Trustee attention.
- 22 c) This instrument is for: i) the presentation of the novation DARRELL JAMES HILL,
- 23 de facto beneficiary for the principal de jure Darrell-James: Hill; ii) to declare the
- 24 adult sui juris authorization with the Trustee for the authorized discharge and

479



HILL



SECURITY AGREEMENT DJH002-SA 09142015-SA CE
Non-Negotiable – Private Agreement Between two Parties

1 distribution of benefit to the Beneficiary; and, iii) to be Not limiting or restricting
2 upon the general capacity of the Trustee to benefit the Beneficiary.

3 **Authorization:**

4 I, DARRELL JAMES HILL, authorize the Trustee, respectfully to privately render an
5 accounting to the penny, discharge debts, lend and distribute funds, and so to act in every
6 lawful act, and to act in the implementation of my choses of action heretofore and until
7 further notice; for:

8 To exercise, act or perform in all lawful duty in support of my benefit; to wit:

- 9 1. To receive trust information
- 10 2. To discharge of a debt as indicated; and,
- 11 3. To directly distribute of the assets as indicated.
- 12 4. To afford defense for the all legal/lawful proceedings touching the Beneficiary,
13 or any part thereof in any matter which Beneficiary may be in any way
14 concerned; including, the principal Beneficiary, and to make, execute and
15 deliver to the Beneficiary all endorsements, acquittances, releases, receipts
16 or other sufficient discharges upon notice of the same.
- 17 5. To engage in and actively transact any and all lawful business authorized by the
18 Beneficiary.
- 19 6. To deposit any funds or money(ies) that may become authorized by Beneficiary
20 with/into any bank/financial institution or banker/bailee as directed, and to
21 receive and maintain records for all completed transaction(s).

22 **7. Other right(s) and Remedies:**

- 23 1. Novation DARRELL JAMES HILL is the/a commercial transmitting utility.
- 24 2. Natural person Darrell-James: Hill, sui juris, claims: I) Live Ownership of
25 the mature, adult, live being and private body under Almighty God, and, II)
26 possession of all of the rights and remedies unto the Beneficiary by every
27 operation under this authorization and, III) exercise of the any and all of the
28 other rights and remedies available at the law, in the equity, and of the
29 otherwise. IV) Therefore, heretofore, all records MUST NOTICE AND
30 REFLECT THE SAME: i) Darrell-James: Hill HAVE PRESENTED SUI
31 JURIS HEREIN, ii) Darrell-James: Hill IS NOT SURETY FOR THE
32 NOVATION DARRELL JAMES HILL, and iii) the presumption is thus set.

33 **Rules of Construction of the Security Agreement:**

- 34 a) words "include," "includes," and "including" are not limiting;
- 35 b) word "all" includes "any" and the word "any" includes "all,"



SECURITY AGREEMENT DJH002-SA 09142015-SA CE
Non-Negotiable – Private Agreement Between two Parties

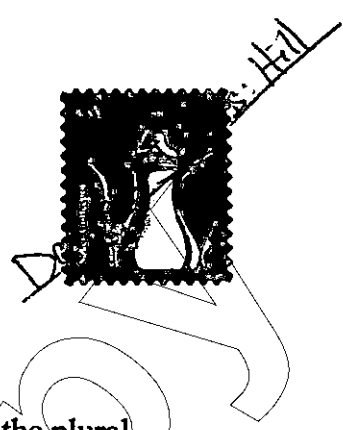

- 1 c) word "or" is not exclusive;
- 2 d) words and terms: i) in the singular number includes the plural, and in the plural
- 3 number includes the singular; and ii) in the masculine gender includes both the
- 4 feminine and neuter; and:
- 5 e) This instrument shall be construed and interpreted generally, and specifically the
- 6 enumeration of specific items, acts, rights or powers in this Authorization
- 7 agreement does not limit or restrict and shall not be construed or interpreted as
- 8 limiting or restricting the lawful general responsibility and duty of the Trustee.

9 **Miscellaneous Provisions Part of this Security Agreement:**

10 **Amendments:** This Security Agreement, together with the any of the related
11 documents and endorsements, constitutes of the entire understanding and agreement
12 regarding any of the matter of the private authorized distribution of benefit set forth
13 in this Security Agreement. Therefore: Security Agreement may neither be changed
14 nor modified in the any manner whatsoever unless that of the said change/
15 modification is agreed upon by the Beneficiary by the writing and signing by the
16 Beneficiary, et al., with the recording of the same instrument with the UCC as an
17 amendment and/or addendum. To this end all precautions for the safe operational
18 ability to distribute benefit to the Beneficiary by the Trustee is the ONLY goal of this
19 Authorization.

20 **Severability:**

21 In the event that this Security Agreement, including that of the any amendment,
22 addendum, and revision, is unlawful for a reason identified on its basis of the being
23 unlawful, invalid, void or voidable, unenforceable, and the like, then such provisions
24 are thereby to be noticed to the Beneficiary, and severed from this Security
25 Agreement, but every remaining provision continues in the fullness of the force and
26 effect and may not be affected by such of a determination. If feasible, any of the such
27 offending provisions may be deemed modified for inclusion within the limits of its
28 authorization, enforceability and validity; however, in the event that the offending
29 provision(s) cannot be so modified, then the said offending provision is thereby
30 stricken, and the all of the other provisions of this Security Agreement in the any of
31 the other respects remains valid and enforceable by the Beneficiary.

32 **Waiver:**

33 Beneficiary waives No right(s) under this Security Agreement unless such of a waiver
34 is given in the writing and signed by the Beneficiary in blue ink.



481

SECURITY AGREEMENT DJH002-SA.09142015-SA CE
Non-Negotiable – Private Agreement Between two Parties



1 Neither by a delay nor by an omission on the part of the Beneficiary in the exercise of
2 a right shall such be presumed to operate as that of a waiver of the right or of the any
3 of an other right.

4 In the any waiver by the Beneficiary of the any provision(s) of this Security
5 Agreement, incidence of a waiver neither prejudices, nor constitutes any of an other
6 waiver of the Beneficiary's right for otherwise demanding a strict compliance with
7 that provision, or in the any other of the provisions, of this Security Agreement.

8 Whenever the consent of the DARRELL JAMES HILL is required under this
9 Security Agreement, then: Beneficiary's granting of such of a consent shall not be
10 construed as constituting of a continuing consent for the any of the subsequent
11 instances wherein such of a consent is required; and in the any of the instant
12 matter(s), such of a consent may be granted and withheld in the sole discretion of the
13 Beneficiary.

14 **Words Defined;** Glossary of Terms. As used in this Security Agreement, the following
15 words and terms are as defined in this section, non obstante:

16 "All" means: everything that is, or of that one has or may have: whole number; totality,
17 including without a restriction.

18 "Almighty God" means: He who exists before all that universally is began; the Father of
19 the Lord God Yushua, the only begotten Son (Creator of all that universally is and the
20 Lord God of of the patriarchs: Abraham, Isaac and Jacob); the Divine Father adoptive to
21 the Hill Darrell-James as a result of the sacrifice made by His only begotten Son Yushua
22 for all grace; the Divine Father which Nothing comes between Him and Darrell-James:
23 Hill.

24 "Artificial Person" means: novation, commercial person: DARRELL JAMES HILL,
25 also known by any and all of the linear derivatives and variations in the spelling of the
26 said name except "Darrell-James: Hill."

27 "Authorized Representative" or "A.R." or "AR" means: Darrell-James: Hill sui juris,
28 authorized representative of the DARRELL JAMES HILL novation.

29 "Beneficial interest" means: profit, benefit, or advantage resulting from a contract, or
30 from the ownership of an estate(s) or trust(s) as distinct from the legal ownership or
31 control of the said estate or trust.

32 "Beneficiary" means: One for whose benefit that of a trust is created: a cestui que trust.

33 "Beyond the sea" means: beyond all of the limits-of/ outside of the UNITED STATES -
34 to wit: territory over the which does not extend any of the sovereignty of the UNITED





SECURITY AGREEMENT DJH002-SA 09142015-SA CE
Non-Negotiable – Private Agreement Between two Parties

1 STATES government; such as, Not of a United States' territory, Citizen, person or
2 commercial holding idea, etc., and of the like, as opposed to that of a natural person or de
3 jure Citizen under the Sovereign Almighty God as the covenanted We the People of the
4 united States of America, the same understanding The Constitution for the united States
5 of America- 1787 CE.

6 "CE" means: common era or christian era or current era as regarding the year date
7 accounting concurrently synonymous with "AD"- to wit: anno Domini.

8 "Claim" means, noun: 1) right or title to a privilege, or of another thing in the possession
9 of another; not strictly that of the possession, but by the means by which the claimant
10 attains to the possession or enjoyment of the said possession; 2) right of the payment,
11 when such of a right is rendered into the form of a judgment, or for the damages, as well
12 as of under the rulings in regards to that of an equitable remedy for the breach of a
13 performance, when such of a breach results in a right of the payment, or of when that of
14 an equitable remedy is rendered in the form of a judgment in regards to the payment of
15 some debt or obligation. Verb: demand as of one's own, asserted as of one's personal right
16 to the any properties or right of a possession or of the enjoyment of a something
17 considered rightfully of one's own, and wrongfully withheld.

18 "Conduit" means: transmitting utility distributing energy and effects in the commerce,
19 such as of the goods and services, via the name novation DARRELL JAMES HILL and
20 of the any linear derivatives and variations in the spelling of said name of the DARRELL
21 JAMES HILL except "Darrell-James: Hill."

22 "Collateral" means: property and property right(s) of the DARRELL JAMES HILL,
23 now owned and hereafter acquired, now existing and hereafter arising, and wherever
24 located, with such of an ownership either in the name of the DARRELL JAMES HILL or
25 in the name of another, in which: Beneficiary holds of a beneficial interest, and of a
26 security for the entire obligation or of the any amount of the indebtedness.

27 "Commercial person" means: abstract or legal entity, ens legis, such as of a corporation,
28 created by the construct of the law and considered as possessing certain of the legal rights
29 and duties of a legal being: an imaginary entity, such is as of a novation; to-wit: novation
30 DARRELL JAMES HILL, which, on the basis of the legal reasoning, is de facto legally
31 treated as: fictitious "person" or "being" for the purpose of conducting in a commercial
32 activity for the Principal Beneficiary de jure.

33 "Derivative" means by the way of another; taken out of a something preceding:
34 secondary; of that which is not of the origin in and of itself, but is that of the which is
35 obtained from the existence out of some foregoing thing and from a more primal and
36 fundamental nature.



SECURITY AGREEMENT DJH002-SA 09142015-SA CE
Non-Negotiable – Private Agreement Between two Parties

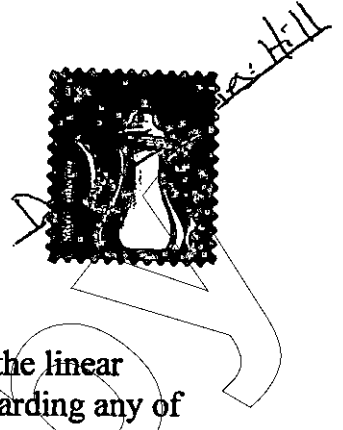

- 1 **“Drawer”** means: Beneficiary or DARRELL JAMES HILL or the any of the linear
2 derivatives and variations of said names in the any manner whatsoever regarding any of
3 the assets or contracts or promissory notes or titles or grants or accounts or instruments,
4 trusts, or agreements in the any form whatsoever bearing the name(s): Darrell-James:
5 Hill, or DARRELL JAMES HILL, respectively, or any linear derivatives and variations
6 of the said name.
- 7 **“Ens legis”** means: creature of the law or of an artificial being, such as is, that of a
8 **“corporation”**: deriving of an existence into a being or entity fabricated entirely by the
9 law, as contrasted with that of a natural person.
- 10 **“Endorsement”** means **“indorsement:”** act of a payee, drawee, accommodation indorser,
11 or holder of a bill, note, check, or of an other negotiable instrument, wherein placing onto
12 of his signum upon the back of the same, with or without further or qualifying words,
13 that thereby: property in the same is assigned and transferred to another.
- 14 **“Entitlement Holder”** means: Darrell-James: Hill sui juris having standing in a security
15 entitlement in the any of the security or asset or contract or promissory note or title or
16 grant or account or instrument or agreements in the any of the forms whatsoever bearing
17 novation DARRELL JAMES HILL, or any linear derivatives and variations of the said
18 name except Darrell-James: Hill.
- 19 **“Ground”** means: land or soil or earth above the sea, beyond the sea; to wit: dirt, the soil
20 or the dust, to-wit: mineral composition, precursors and substance elements of the
21 corporeal man.
- 22 **“Issuer”** means: Darrell-James: Hill sui juris or DARRELL JAMES HILL, respectively,
23 of the maker or drawer of the any of the assets or contract or promissory note or title or
24 grant or account or instrument or agreement in the any form whatsoever.
- 25 **“Land”** means: dry ground and dry earth soil whatsoever, inclusive of the pastures,
26 fields, meadows, woods, moors, waters, marshes, rock, elements, and sand, as against
27 that of the sea or ocean.
- 28 **“Legal Entity”** means: entity ens legis as against that of a natural person; Of the
29 artificial sufficient existence in and of the legal contemplation that of the said entity may
30 function legally or sue and be sued or make decisions through its representative(s).
- 31 **“Living and breathing, flesh-and-blood man”** means: Hill Darrell-James, Darrell-
32 James: Hill, of a biological and spiritual and soul being: natural person as against that of
33 an artificial legal construct or ens legis- to wit, created by construct of the law.
- 34 **“Maker”** means: (a) Settlor, or (b) Adult Beneficiary in regards to the any of the assets or
35 contract or promissory note or title or grant or account or instrument or agreement in-
36 bearing the name(s) Darrell-James: Hill sui juris, or novation DARRELL JAMES HILL,



2/84



**SECURITY AGREEMENT DJH002-SA 09142015-SA CE
Non-Negotiable – Private Agreement Between two Parties**

1 respectively.

2 **“Natural person”** means: sentient being living on the ground, beyond of the sea, that of
 3 a “living and breathing, flesh-and-blood man,” as against that of an artificial person(s) or
 4 commercial person ens legis.

5 **“Non obstante”** means: words anciently used in the public and private instruments
 6 intended to preclude, in advance, any of the interpretations contrary to the certain
 7 declared objects or purposes.

8 **“Novation”** means: the act of substituting a “new” fiction with a “new” obligation in
 9 place of the original natural entity due the original natural obligation; often a commercial
 10 device to facilitate operations in obligations due to a non-commercial original; for
 11 example: en legis entity DARRELL JAMES HILL, beneficiary de facto to facilitate
 12 operations in obligations for the Hill Darrell-James principal beneficiary de jure.

13 **“Private”** means: lawfully not subject to common knowledge or awareness.

14 **“Hill Darrell-James”** means: Darrell-James: Hill de jure- the natural person, In:
 15 1) Sovereign “We The People” Status of The Constitution For The United States of
 16 America-1787 CE.: 2) Political Status Election: ENCLOSURE Three; and: 3) natural
 17 person of the non-commercial status.

18 **“Security”** means: TRUST.

19 **“Security Agreement”** means: “SA”, trust agreement, with the all of the attachments
 20 and incorporations made by the reference.

21 **“Securities Intermediary”** means: bank or broker or clearing corporation or bailee that
 22 is acting in the capacity of the maintaining of a security account service.

23 **“Signature”** means in the nature of, U.C.C. § 3-401 – 2002, what is considered signum,
 24 which is herein incorporated by a reference.

25 **“Signed”** means in the nature of, U.C.C. § 1-201 (37) – 2001, what is considered signum,
 26 which is herein incorporated by a reference.

27 **“Signum”** means: sign, mark, seal, or writing mad for to identify or authenticate, or to
 28 give validity of one’s own act: signature.

29 **“Sui Juris”** means: of full age, capacity and standing, possessing all natural and
 30 inalienable rights, and protection of same from/by the governmental construct, et al.

31 **“Trade-name”** means: commercial person "DARRELL JAMES HILL", as well as the
 32 any of the linear derivatives and variations in the spelling of that said name, respectively,
 33 except "Darrell-James: Hill."

34 **"DARRELL JAMES HILL"** means: "DARRELL JAMES HILL", and the any of the
 35 linear derivatives and variations in the spelling of the said name except "Darrell-James:
 36 Hill": All of the right(s) reserved regarding trade-name/trade-mark 2015 CE, et seq. - All of

485



SECURITY AGREEMENT DJH002-SA 09142015-SA CE
Non-Negotiable – Private Agreement Between two Parties



S: Hill

1 the right(s) reserved.
2 **“transmitting utility”** means: the stramineus homo, en legis, novation DARRELL JAMES
3 HILL: duty by construction and design for the the transmitting of letters, writings, papers,
4 news, and the like, from one commercial construct to another; the mechanism for to
5 communicate rights, titles, and privileges while inherently representing the natural person,
6 the Principal Beneficiary.
7 **“Darrell-James: Hill”** means: “Hill Darrell-James” de jure: natural person of this SA
8 and CQT, the Confirmation of the presumption of the novation DARRELL JAMES
9 HILL: to wit: the natural person of soul under the Almighty God identified by the family
10 name: “Hill”, and upon his birth, “James” -second name, and “James” -third name: to
11 wit: Hill Darrell-James: him to who the de jure confirmations- made before refer. All of
12 the right(s) reserved regarding the any use of the name “Darrell-James: Hill” signum,
13 Common-law trade-name/trade-mark 2015 CE, et seq.- All of the right(s) reserved.
14 **“U.C.C. § 1-201(37) – (2001)”** means in the nature of “includes using any symbol
15 executed or adopted with present intention to adopt or accept a writing.”
16 **“U.C.C. § 3-401– (2002)”** means in the nature of, “(a) A person is not liable on an
17 instrument unless (i) the person signed the instrument, or (ii) the person is represented by
18 an agent or representative who signed the instrument and the signature is binding on the
19 represented person under Section 3-402. (b) A signature may be made (i) manually or by
20 means of a device or machine, and (ii) by the use of any name, including a trade or
21 assumed name, or by a word, mark, or symbol executed or adopted by a person with
22 present intention to authenticate a writing.”
23 **“U.C.C. § 9-607– (2010)”** means in the nature of, “(a) [Collection and enforcement
24 generally.] If so agreed, and in any event after default, a secured party: (1) may notify a
25 debtor or other person obligated on collateral to make payment or otherwise render
26 performance to or for the benefit of the secured party; (2) may take any proceeds to
27 which the secured party is entitled under Section 9-315; (3) may enforce the obligations
28 of an account debtor or other person obligated on collateral and exercise the right(s) of
29 the debtor with respect to the obligation of the account debtor or other person obligated
30 on collateral to make payment or otherwise render performance to the debtor, and with
31 respect to any property that secures the obligations of the account debtor or other person
32 obligated on the collateral; (4) if it holds a security interest in a deposit account perfected
33 by control under Section 9-104(a)(1), may apply the balance of the deposit account to the
34 obligation secured by the deposit account; and (5) if it holds a security interest in a
35 account perfected by control under Section 9-104(a)(2) or (3), may instruct the bank to
36 pay the balance of the deposit account to or for the benefit of the secured party. (b)

2022-011769 MISC Page: 484 of 2782
09/26/2022 03:35:37 PM Receipt #: 22-9381
Rec Fee: \$30.00 Darrell James Hill
Gila County, Az, Sadie Jo Bingham, Recorder



486



SECURITY AGREEMENT DJH002-SA 09142015-SA CE
Non-Negotiable – Private Agreement Between two Parties

1 [Nonjudicial enforcement of mortgage.] If necessary to enable a secured party to exercise
2 under subsection (a)(3) the right of a debtor to enforce a mortgage non-judicially, the
3 secured party may record in the office in which a record of the mortgage is recorded: (1)
4 a copy of the security agreement that creates or provides for a security interest in the
5 obligation secured by the mortgage; and (2) the secured party's sworn affidavit in
6 recordable form stating that: (A) a default has occurred with respect to the obligation
7 secured by the mortgage; and (B) the secured party is entitled to enforce the mortgage
8 non-judicially. (c) [Commercially reasonable collection and enforcement.] A secured
9 party shall proceed in a commercially reasonable manner if the secured party: (1)
10 undertakes to collect from or enforce an obligation of a account debtor or other person
11 obligated on collateral; and (2) is entitled to charge back uncollected collateral or
12 otherwise to full or limited recourse against the debtor or a secondary obligor. (d)
13 [Expenses of collection and enforcement.] A secured party may deduct from the
14 collections made pursuant to subsection (c) reasonable expenses of collection and
15 enforcement, including reasonable attorney's fees and legal expenses incurred by the
16 secured party.”

INTENTIONALLY LEFT BLANK





**SECURITY AGREEMENT DJH002-SA 09142015-SA CE
Non-Negotiable – Private Agreement Between two Parties**

1 Babel Communications

2 The content of this document is written nunc pro tunc in the language with the babel
3 communication common on the day of this document as distinguished against Complete-
4 Sentence-Sense-Parse-Syntax-Grammar, "C-S-S-P-S-G" context communication. Any
5 translation and/or interpretation shall be contextually metered and construed in
6 accordance within the meaning(s) intended by the Party.

7 This: Security Agreement DJH002-SA 09142015-SA CE:
8 Without Prejudice UCC 1-308
9 **DARRELL JAMES HILL**

10 Darrell-James Hill
11 Authorized Representative
12

Arizona state

ss.

Maricopa county

13 On the day 14 of the month September in the year 2015 CE: DARRELL JAMES HILL
14 appeared before me and proved to me on the basis of satisfactory evidence to be the person
15 who affirmed and subscribed hereto and acknowledged to me that he executed the same, and
16 accepts the facts thereof. Subscribed and affirmed before me this day. Witness my hand and
17 seal this

18 14th day of SEP, 2015.



KALLE KIVINEN
Notary Public - Arizona
Maricopa County
Expires on 08/15/2016

19 Notary

SEAL

20 [Signature] My Commission Expires 8-15-2016





SECURITY AGREEMENT DJH002-SA 09142015-SA CE
Non-Negotiable – Private Agreement Between two Parties

ENCLOSURE-One

489
SECURITY AGREEMENT ^{DJH} DJH002-SA 09142015-SA CE

11 of 13

2022-011769 MISC Page: 487 of 2782
09/26/2022 03:35:37 PM Receipt #: 22-9381
Rec Fee: \$30.00 Darrell James Hill
Gila County, Az, Sadie Jo Bingham, Recorder



**NOTARIAL ACKNOWLEDGMENT
OF ORIGINAL, AUTHENTIC, BIRTH CERTIFICATE**



I HEREBY CERTIFY THIS DOCUMENT IS AN EXACT COPY OF THE RECORD ON FILE WITH THE OHIO DEPARTMENT OF HEALTH

DE 24 08 01 13 11

Ruth Holecek
OHIO STATE REGISTRAR
DEPT. OF HEALTH STATISTICS
3700 EAST FORT MEYER AVE. COLUMBUS, OHIO 43219

**OHIO DEPARTMENT OF HEALTH
DIVISION OF VITAL STATISTICS
CERTIFICATE OF LIVE BIRTH**

Reg. Dist. No. [REDACTED] Primary Reg. [REDACTED] Registrar's No. [REDACTED]

1. PLACE OF BIRTH: COUNTY Summit

2. USUAL RESIDENCE OF MOTHER: STATE Ohio COUNTY Summit

3. CITY, VILLAGE, OR LOCATION: Summit

4. NAME OF HOSPITAL OR INSTITUTION: Akron City Hospital

5. STREET ADDRESS: 216 King Ct

6. IS PLACE OF BIRTH INSIDE CITY LIMITS? YES NO

7. IS RESIDENCE INSIDE CITY LIMITS? YES NO

8. IS RESIDENCE ON A FARM? YES NO

9. NAME OF CHILD: FIRST Darrell MIDDLE James LAST Hill

10. SEX: M SINGLE TWIN TRIPLE

11. DATE OF BIRTH: MONTH Nov DAY 20 YEAR 58

12. AGE (at time of this birth): 35 YEARS

13. MAIDEN NAME: Kia

14. AGE (at time of this birth): 30 YEARS

15. BIRTHPLACE (state of father's nativity): Ohio

16. BIRTHPLACE (state of mother's nativity): Ohio

17. INFORMANT'S NAME OR SIGNATURE: [Signature]

18. MOTHER'S ADDRESS: Hill

19. DATE GEBLOGIC TEST FOR SYPHILIS: none

20. DATE RECEIVED BY LOCAL REG.: 11-28-58

21. REGISTRAR'S SIGNATURE: [Signature]

22. DATE SIGNED: 11-28-58

23. DATE ON WHICH GIVEN NAME ADDED: _____

**STATE OF ARIZONA
COUNTY OF MARICOPA**

ON this 28th day of June, 2015 A.D., by me, a notary public in and for the said STATE OF ARIZONA, residing therein, duly commissioned and sworn, personally appeared and upon the presentation of sufficient documentation satisfactorily proved to me to be the person DARRELL JAMES HILL, and who provided to me a document from the STATE OF OHIO for notarial acknowledgment.

The document content is on a specialty multi-colored type of safety paper with repetitive circular with center of "ODH" watermark throughout observable when held up to the light; the right upper corner area bears a depressed seal mark. Document is entitled: "OHIO DEPARTMENT OF HEALTH, DIVISION OF VITAL STATISTICS, CERTIFICATE OF LIVE BIRTH".

Document content: Left side: Reg. Dist. N. [REDACTED] below is: Primary Reg. Dist. [REDACTED] Right side: Registrar's N. [REDACTED] below, B. [REDACTED]

Descriptive document content: 1. PLACE OF BIRTH: Summit.... 2. USUAL PLACE OF RESIDENCE OF MOTHER, a. STATE Ohio.... 3. CHILD: NAME: Darrell James Hill.... 7. FATHER: NAME: Clarence Hill.... 12. MOTHER: Maiden: Ora Lee Archer. With 2 signatures below: Certification of birth statement and SIGNATURE, and a REGISTRAR'S SIGNATURE in cursive writing, "Ruth Holecek"

I acknowledge this document as authentic.

Witness my hand and seal this

28th day of JUNE, 2015.

Notary



KALLE KIVINEN
Notary Public - Arizona
Maricopa County
Expires on 08/15/2016

My Commission Expires 8-15-2016

490



SECURITY AGREEMENT DJH002-SA 09142015-SA CE
Non-Negotiable – Private Agreement Between two Parties



ENCLOSURE-Two

^{DH}
SECURITY AGREEMENT DJH002-SA 09142015-SA CE

12 of 13

2022-011769 MISC Page: 489 of 2782
09/26/2022 03:35:37 PM Receipt #: 22-9381
Rec Fee: \$30.00 Darrell James Hill
Gila County, Az, Sadie Jo Bingham, Recorder



Unofficial Copy

491

**NOTARIAL ACKNOWLEDGMENT
OF ORIGINAL, AUTHENTIC, ARIZONA, Driver License**

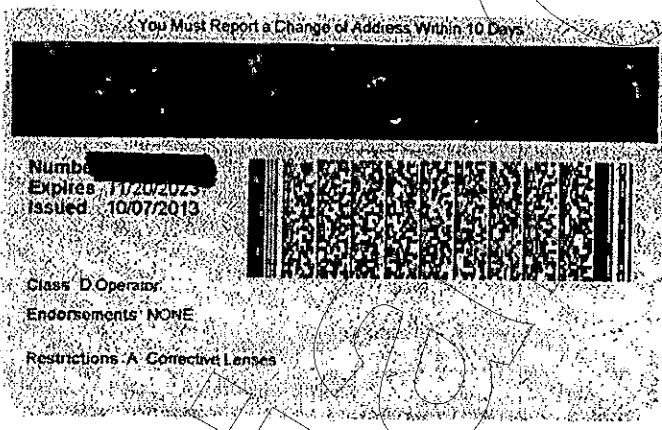
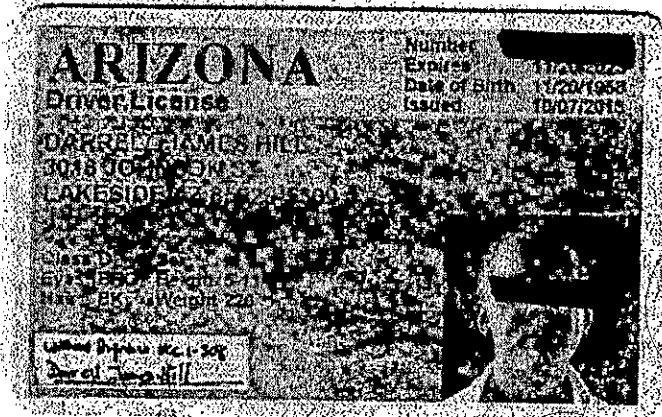
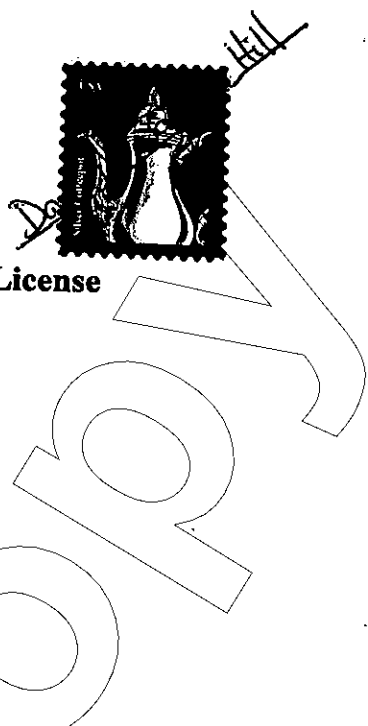

**STATE OF ARIZONA
COUNTY OF MARICOPA**

ON this 28th day of June, 2015 A.D., by me, a notary public in and for the said STATE OF ARIZONA, residing therein, duly commissioned and sworn, personally appeared and upon the presentation of sufficient documentation satisfactorily proved to me to be the person DARRELL JAMES HILL, and who provided to me a document from the STATE OF ARIZONA for notarial acknowledgment.

The document is set upon a sky-mountain background picture, is entitled "ARIZONA, DRIVER LICENSE" in the upper left corner with repetitively distributed throughout the card a 'state-shaped-picture with the words "CANYON"' following. The document is signed in the lower left corner, with a likeness picture of the presumed signer in the lower right corner. The picture in the right lower corner is a reasonable facsimile of Darrell-James: Hill.

The right upper corner document content information is: "Number [redacted] Expires 11/20/2023; Date of Birth 11/20/1958; Issued 10/07/2013."

The middle document content information is: "DARRELL JAMES HILL" with a following address location, below which is a description of a person, and below which is a signum in a white box at the left base of the card document.

I acknowledge this document as authentic.

Witness my hand and seal this
28th day of JUNE, 2015.



KALLE KIVINEN
Notary Public - Arizona
Maricopa County
Expires on 08/15/2016

Notary [Signature] My Commission Expires 8-15-2016

492

Das Hill

SECURITY AGREEMENT DJH002-SA 09142015-SA CE
Non-Negotiable – Private Agreement Between two Parties



Unofficial Copy

ENCLOSURE-Three

^{NH}
SECURITY AGREEMENT DJH002-SA 09142015-SA CE

13 of 13

2022-011769 MISC Page: 491 of 2782
09/26/2022 03:35:37 PM Receipt #: 22-9381
Rec Fee: \$30.00 Darrell James Hill
Gila County, Az, Sadie Jo Bingham, Recorder



493

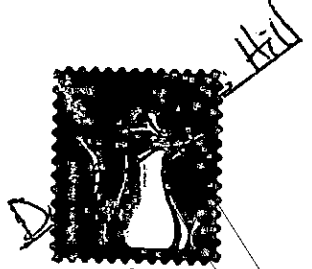

Political Status Election DJH002-PE 09142015-PE CE:

**Affirmation In Confirmation of Novation:
DARRELL JAMES HILL, CUSIP Number [REDACTED]**

1 In regards to the novation nom-de-guerre en legis commercial "DARRELL JAMES HILL",
 2 CUSIP number [REDACTED] the Principal beneficiary of this novation name of trade in
 3 commerce:
 4 **Presents: Status (legal position): Standing (interest in consideration):**
 5 I: Hill Darrell-James: Principal Beneficiary de jure by the novation DARRELL JAMES HILL
 6 beneficiary de fact, do herein report that: truths and facts herein are of my first hand personal
 7 comprehension and review and true to the best of my present belief and ability; to wit:
 8 1) I: undersigned American National Citizen of the sovereign We the People, am: Hill
 9 Darrell-James, also known as Darrell-James: Hill: natural born child of the man Clarence of the
 10 family Hill; and, then-after, named additionally: Darrell and James, at, or soon after birth. See:
 11 Certificate of the Live Birth: ENCLOSURE One. See Arizona Drivers License: ENCLOSURE
 12 Two.
 13 2) I am at the natural birth: citizenry of the Ohio state territory of the Union of nation states
 14 of the united States of America understanding of the Original Jurisdiction*.

*Notice: Term "Original Jurisdiction" means 1) under the covenant: Almighty God: Torah:-and writings, and: 2) as proposed under The Constitution for the united States of America - 1787 CE, as indicated in the "The united States of America" set for in The Articles of the Confederation -1777-1781 CE, and: 3) constitutional articles in amendment - 1791 CE, and: 4) other original covenants and accords under the Original Jurisdiction, including, but not limited to:

- a) The Declaration of Independence 1776 CE;
- b) National Bill of Rights, 1789 CE; and:
- c) The Northwest Ordinance, 1787 CE.

15 3) I am of the the majority age; sui juris.
 16 4) I am of the competent mind, and make this political chose in action; sui juris.
 17 5) I am that of a sentient free Man upon the ground under the Almighty God; to wit: an
 18 understanding Ambassador of the Son and Creator God of all that is, and of His Father, even:
 19 Most High God in Heaven the Divine with whom Nothing and None exists between; to wit:

20 KJV: Book: Genesis-Chapter 1:26 And God said, Let us make man in our image,
 21 after our likeness: and let them have dominion over the fish of the sea, and over
 22 the fowl of the air, and over the cattle, and over all the earth, and over every

494





Political Status Election: Affirmation In Confirmation of Novation

1 creeping thing that creepeth upon the earth. Gen 1:27 So God created man in his
2 *own* image, in the image of God created he him; male and female created he them.

3 KJV: Book: Proverbs-Chapter 28:5 Evil men understand not judgment: but they
4 that seek the LORD understand all *things*. Chapter 9:10 The fear of the LORD *is*
5 the beginning of wisdom: and the knowledge of the holy *is* understanding.

6 KJV: Book: Ephesians-Chapter 6:19 And for me, that utterance may be given
7 unto me, that I may open my mouth boldly, to make known the mystery of the
8 gospel, 6:20 For which I am an ambassador in bonds: that therein I may speak
9 boldly, as I ought to speak.

10 6) I am of the American citizenry by the free birth in the Ohio state in the year anno domini
11 Nineteen hundred fifty eight under Almighty God; thus:

12 7) I am of the public trust beneficiary status: trust titled in the corporate manner,
13 "DARRELL JAMES HILL" formed from the elements of the Hill Darrell-James, i.e., "Darrell-
14 James: Hill" due to the subsequent events occurring after and under the derivative
15 organization(s) under the Original Jurisdiction.

16 **Notice: The use of a doctrine of *idem sonans* in any form is hereafter
17 forbidden as it is material constructive fraud and deceitful practice in any
18 reference to the man Darrell-James: Hill; to wit: whether oral, written or other, as
19 relates to the Darrell-James: Hill such of a practice by any fiduciary designated of
20 the public trust in the any manner or presumption in the regard or in the direct
21 service of the Darrell-James: Hill is hereafter upon this statement willful fraud and
22 constructive fraud by the actor(s).

PUBLIC NOTICE:

23 THIS DOCUMENT GIVES NOTICE of these: reports, clarifications or other matters contained
24 to the UNITED STATES CORPORATION entity and all of the derivatives thereof: Public and
25 Private, through and by the Office of the Secretary of State(s) or their agent(s): de facto and de
26 jure "united States of America" seat(s) of the government in and upon the territory thereof; and,
27 through and by the Office of the Secretary of State(s) or their agent(s): de facto and de jure
28 "Arizona state" seat(s) of the government in and upon the territory thereof; and to the all of the
29 persons who would know or should have known this Notice content, as relates to the
30 undersigned, by and upon the filing of this public information.
31

32 NOTICE TO DOMESTIC AND FOREIGN JURISDICTIONS:

Political Status Election: Affirmation In Confirmation of Novation 2 of 11

495



Political Status Election: Affirmation In Confirmation of Novation

1 Notice to the principal is notice to all of the agent(s): Notice to the agent is notice to all of the
2 principals of the de facto UNITED STATES AND STATE government(s): actor(s) and
3 derivatives thereto; to wit: Officer(s), Employee(s), Agent(s), Contractor(s), and the like; and,
4 when-upon this notice is once affixed to any home ground(s) of the Darrell-James: Hill's land-
5 site or habitation-site, or site-otherwise, then:

- 6 a) all of the property attached thereunto is under the custody and control of the
- 7 above-noted: Darrell-James: Hill;
- 8 b) pursuant to the common-law, then: site is not subject to presumed or wanton
- 9 intrusion or seizure, or the like, except by the willful authorization from the
- 10 Darrell-James: Hill;
- 11 c) pursuant to the common-law: Darrell-James: Hill is lawfully and legally immune from
- 12 statutory criminal or civil jurisdiction(s), arrest(s) or detention(s), or the
- 13 like, under the Original Jurisdiction convention(s); and,
- 14 d) all of the Actors, of both the private and public sector(s), must take all of the
- 15 steps to be taken in every condition to assure and to prevent any of the
- 16 reproach or attack otherwise on the Affiant's God given inalienable
- 17 Right(s); to wit: Constitutionally secured and protected in-alienable
- 18 Right(s), freedom(s), property(s), interest(s), mobility(s) and security(ies)
- 19 and protection(s) thereof;
- 20 e) Legality(ies) of this Notice, or the like: inquiry(ies) in regards to the any actor(s)
- 21 in their constitutional responsibility(ies) should be made to the sheriff in the
- 22 county territory of the any event of the any matter(s) of the actor's concern.

23 **Presents: Character: (motive(s) that control a life): Capacity: (legal or moral qualification**
24 **necessary for certain purposes):**

25 Darrell-James: Hill does hereby state, assert and aver the all of the following:

- 26 1) Darrell-James: Hill is a man understanding of the Almighty God; to wit: an Ambassador
- 27 of the Messiah: Genesis-Chapter-1:26-27; Proverbs-Chapter-28:5; Proverbs-Chapter-
- 28 9:10; Ephesians-Chapter-6:...19-20 – King James Version, "KJV"

29 Ephesians-Chapter 6:19 And for me, that utterance may be given unto me, that I may
30 open my mouth boldly, to make known the mystery of the gospel, 6:20 For which I
31 am an ambassador in bonds: that therein I may speak boldly, as I ought to speak.

- 32 2) Darrell-James: Hill is a biological citizen born in, upon and of the natural territory of the
- 33 "Ohio state".

496

Political Status Election: Affirmation



Political Status Election: Affirmation In Confirmation of Novation

1
2
3
4
5
6
7
8
9
10
11
12
13
14
15
16
17
18
19
20
21
22
23
24
25
26
27
28
29
30
31
32
33
34
35
36
37

- 3) Darrell-James: Hill is a private-individual, private-person, and non-fictitious person or entity; to wit: a man under the Almighty God the Divine between which there is none other.
- 4) Darrell-James: Hill retains all of the absolute jurisdiction of the people: a natural person man understanding: Almighty God.
- 5) Darrell-James: Hill retains all of the absolute protections of the Rights, remedies and defenses granted by the Almighty God by the subsequent limitations created and beset by the people of the states of America for the people and upon the united States of America government(s) upon its inception and creation as established under the covenant(s) of the Original Jurisdiction.
- 6) Darrell-James: Hill is of the real capacity and character above, and as the same has chosen a political status above that of, and foreign to the UNITED STATES government corporate jurisdiction; to wit:
 - Darrell-James: Hill does not volunteer, nor consent or contract to be presumed as acting in/as any *ens legis* entity or capacity, neither to be presumed as an operative of the any other political state or subdivision or surety of the any UNITED STATES corporate interest(s); to wit: Darrell-James: Hill reserves the nature and character of his exact and proper man status and capacity under: Almighty God, and of the same election reserved under the Original Jurisdiction, *sui juris*, *de jure*.
 - Darrell-James: Hill waives none of the Rights, Remedies or defenses, nor yields of the same, including, without a limitation, the any of the Rights in the accordance with the protection(s) and principle(s) of the Rights, Remedies and defenses assured by and under pursuant to the Original Jurisdiction; to wit: Rights, such as: right to freedom of movement: private right to travel without restriction in any conveyance on any public roadway in this united nation States of America: right to bear arms for the survival and protection of his family and country.
 - Darrell-James: Hill is Not a "UNITED STATES CITIZEN" as is the novation DARRELL JAMES HILL is/was so designed; to wit, Darrell-James: Hill is Not: subject, vessel, or other presumed entity of the UNITED STATES' as defined in statutes-at-large, such as in the nature of the Title 26 UNITED STATES CODE, "USC", Section 7701, or of the like as elsewhere defined in the statutes-at-large.
 - Darrell-James: Hill is Not in the any form: *ens legis* fiction as is: "person or individual," entity, or other procedural construct or statutory term referring to a legal fiction.
- 7) Darrell-James: Hill Affiant is by the common law: "Trade-name/ Trade-mark of the Common Law"; and it is unto him "Hill Darrell-James" who all of the Rights are reserved. Use, with the any reference to the Affiant, without express written permission

499



Political Status Election: Affirmation In Confirmation of Novation

by the Darrell-James: Hill creates a voluntary and informed consensual contractual obligation upon the unauthorized user to the payment of a Trade-name/ Trade-mark infringement fee(s) as follows: Trade-name/Trade-mark infringement fee is in the sum certain of five hundred thousand dollars and no/100: 500,000.00 USD lawful money of account: gold or silver coin, or: certified bullion, or: equivalent money to which the Secured Party may prefer to agree to the receipt.

8) Darrell-James: Hill does comprehend for to identify, paraphrase and assert herein of the following facts of the historical significance bearing upon the Original jurisdiction of the Affiant's status, capacity, character and standing; to wit, that:

a) Due to the faux governmental disparity(ies) arising out of the gross capital control controversies by the clandestine banking factions in the 18th century the constitutional government was usurped by criminals intent upon theft of Almighty God's covenanted people from the first presumed president until to date; to wit, usurpation under a corporate veil or another with one goal to date, to still, kill, destroy and enslave Almighty God's covenanted people.

b) The present defacto corporate government, in the order for to sustain its deception to govern, postures and administrates under the auspices of the Original Jurisdiction, as a corporation titled: UNITED STATES, a federal corporation defined by its own principle(s) as a federal corporation in the nature of Title 28 USC 3002 (15), as: commercial entity implementing a corporate policy called "public policy" and statutory law for reasons beyond the scope of this statement: government under the Original Jurisdiction, under the "united States of America", under pursuant to the Executive Branch.

c) The "UNITED STATES" government corporation, however referred to today, is not synonymous to "The united States of America" government of the original predilection and assemblage. Identically, the "UNITED STATES CONSTITUTION" is not synonymous to "The Constitution for the united States of America"; to wit: UNITED STATES CONSTITUTION is technically the/a corporate by-laws statement of the said corporation, and is similarly by any corporate procedure: corporate policy. Subsequently:

9. Original Jurisdiction, cannot be in conflict with itself; to wit: Almighty God made man in original jurisdiction over the earth and all of the substance, and reserving to Himself jurisdiction over man in total.

10. Natural people *de jure*: people under the God Almighty are above all including of the Original Jurisdiction; to wit: Darrell-James: Hill, et al.: sovereign We People are the authority under-which the construct of the state nations and of the The Constitution for the United States of America are conceived, mandated, and obliged; Therefore: sovereign We People are inherently superior to the present de facto UNITED STATES' corporate fiction by its own admission(s). Accordingly, by the political election: private people de jure are not



498



Political Status Election: Affirmation In Confirmation of Novation

1 subject to the un-constitutional corporate construct(s) for a sundry reasons, such constructs
2 as in the nature of the unconscionable Federal Reserve Bank Act of December 23, 1913 CE.
3 11. Notwithstanding: Full disclosure of the points and authorities of the progressive
4 development of the UNITED STATES corporate government as it is presently openly
5 discovered are fully comprehensible and comprehended by Darrell-James: Hill. However,
6 the permitted absence of the reestablishment of the de jure Governance of the Original
7 Jurisdiction, and, thereby, of the matter(s) of the subsequent enabling of the fraud(s) upon
8 the people by the founding predecessors and present actors of the UNITED STATES
9 corporate government, includes: a) abetting of the same deception upon the natural people
10 de jure; to wit: Darrell-James: Hill, et al.: b) protection of the extraordinary and persistent
11 UNITED STATES corporate policy of coven, conspiracy, and collusion constructed and
12 condoned by the present day UNITED STATES corporation and actor(s), pursuant from, in
13 the nature of the 20th Amendment to the UNITED STATES Constitution; and: c) subsequent
14 Corporate and complicit agent's acts including, but not limited to: progressive development
15 of the Cestui Que Trust: title: DARRELL JAMES HILL, to the benefit of the natural born
16 Hill Darrell-James; to wit: Darrell-James: Hill; and, of the actor(s) systematic usufruct of the
17 same natural people's trusts and the profit: power, prestige and privilege for selfish gain.

18 **POSITION AUTHORITY:**

19 I: Darrell-James: Hill have all of the authority as a natural man under the God
20 Almighty to establish this political election and dispel all of the contrary
21 presumptions by the any actor(s), including, but not limited to the commercial
22 entity(ies) mentioned/ referred to in this document, that: presumption is set.
23 Furthermore: fidelity of the constitutional integrity of every UNITED STATES'
24 agency, and the any of the officer(s)/actor(s) thereof, are under the Constitution
25 for the United States of America under Almighty God. Therefore: any
26 commercial entity(ies) or actor(s) with which Affiant may make acquaintance
27 and/or come into contact shall under the presumption heretofore instantly seek
28 and protect Darrell-James: Hill's every Right(s) and Remedy(ies) and interest(s)
29 within the direct obedience under Almighty God under the Constitutional oath of
30 their office which is under duty to the service and protection: Darrell-James: Hill;
31 to wit:

32 KJV: Book: Exodus 20:1 And God spake all these words, saying, 20:2 I am the
33 LORD thy God, which have brought thee out of the land of Egypt, out of the
34 house of bondage. 20:3 Thou shalt have no other gods before me. 20:4 Thou
35 shalt not make unto thee any graven image, or any likeness of any thing that is in
36 heaven above, or that is in the earth beneath, or that is in the water under the
37 earth: 20:5 Thou shalt not bow down thyself to them, nor serve them: for I the
38 LORD thy God am a jealous God, visiting the iniquity of the fathers upon the

Handwritten initials 'JAH' in a large, stylized font.

2022-011769 MISC Page: 497 of 2782
09/26/2022 03:35:37 PM Receipt #: 22-9381
Rec Fee: \$30.00 Darrell James Hill
Gila County, Az, Sadie Jo Bingham, Recorder





Political Status Election: Affirmation In Confirmation of Novation

1 children unto the third and fourth generation of them that hate me; 20:6 And
2 shewing mercy unto thousands of them that love me, and keep my
3 commandments. 20:7 Thou shalt not take the name of the LORD thy God in
4 vain; for the LORD will not hold him guiltless that taketh his name in vain. 20:8
5 Remember the sabbath day, to keep it holy. 20:9 Six days shalt thou labour, and
6 do all thy work: 20:10 But the seventh day is the sabbath of the LORD thy God:
7 in it thou shalt not do any work, thou, nor thy son, nor thy daughter, thy
8 manservant, nor thy maidservant, nor thy cattle, nor thy stranger that is within thy
9 gates: 20:11 For in six days the LORD made heaven and earth, the sea, and all
10 that in them is, and rested the seventh day: wherefore the LORD blessed the
11 sabbath day, and hallowed it. 20:12 Honour thy father and thy mother: that thy
12 days may be long upon the land which the LORD thy God giveth thee. 20:13
13 Thou shalt not kill. 20:14 Thou shalt not commit adultery. 20:15 Thou shalt not
14 steal. 20:16 Thou shalt not bear false witness against thy neighbour. 20:17 Thou
15 shalt not covet thy neighbour's house, thou shalt not covet thy neighbour's wife,
16 nor his manservant, nor his maidservant, nor his ox, nor his ass, nor any thing that
17 is thy neighbour's[;] to wit:

18 KJV: Book: Proverbs-Chapter 17:15 He that justifieth the wicked, and he that
19 condemneth the just, even they both are abomination to the LORD... 17:23 A
20 wicked man taketh a gift out of the bosom to pervert the ways of judgment.
21 Chapter 18:5 It is not good to accept the person of the wicked, to overthrow the
22 righteous in judgment. Chapter 20:10 Divers weights, and divers measures, both
23 of them are alike abomination to the LORD. 20:25 It is a snare to the man who
24 devoureth that which is holy, and after vows to make enquiry.

25 "The law will protect an individual who, in the prosecution of a right does
26 everything which the law requires him to do but fails to obtain his right by
27 the misconduct or neglect of a public officer." See in the nature of Lyle v.
28 Arkansas, 9 Howe 314, 13 L. Ed 153; Duluth & Iron Range Co. v. Roy, 173 U.S.
29 587, 19 S. Ct 549, 43 L. Ed 820.

30 "It is a maxim of the law, admitting few if any exceptions, that every duty laid
31 upon a public officer for the benefit of a private person, is enforceable by judicial
32 process". See in the nature of Butterworth v. U.S. ex rel. Hoe, 112 U.S. 50, 5 S.
33 Ct 25, 28 L. Ed 656.

500

2022-011769 MISC Page: 498 of 2782
09/26/2022 03:35:37 PM Receipt #: 22-9381
Rec Fee: \$30.00 Darrell James Hill
Gila County, Az, Sadie Jo Bingham, Recorder



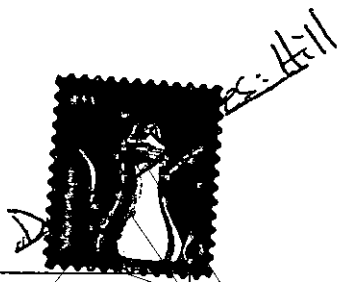

Political Status Election: Affirmation In Confirmation of Novation

1 I: Darrell-James: Hill have all of the authority, and of the duty, to examine from
2 the any where is the authority of the any one claiming to represent the any
3 government at the any level; to wit:

4 KJV: Book: 1 John-Chapter 4:1 Beloved, believe not every spirit, but try the
5 spirits whether they are of God: because many false prophets are gone out into the
6 world. 4:2 Hereby know ye the Spirit of God: Every spirit that confesseth that
7 Jesus Christ is come in the flesh is of God: 4:3 And every spirit that confesseth
8 not that Jesus Christ is come in the flesh is not of God; and this is that *spirit* of
9 antichrist, whereof ye have heard that it should come; and even now already is it
10 in the world.

11 Notification of the legal responsibility is "the first essential
12 of due process of law." See in the nature of Connally v. General
13 Construction Co., 269 U.S. 385, 391.

14 "Silence can only be equated with fraud where there is a
15 legal or moral duty to speak or when an inquiry left
16 unanswered would be intentionally misleading." See in the
17 nature of U.S. v. Tweel, 550 F.2d.297.

18 It is in the ministerial fiduciary/trustee duty of the each and every
19 government official, officer, agent, contractor and assign of the
20 UNITED STATES, and of its derivatives; to wit: STATE OF
21 ARIZONA, ET SEQ., Federal Reserve Banks/System, International
22 Monetary Fund, International Finance Corporation, International
23 Bank for Reconstruction and Development, Inter-American
24 Development Bank, World Bank, Commission of the European
25 Communities, Organization for Economic Co-operation and
26 Development, United Nations, and of the any and all other agent(s)
27 who view of this notice, "Respondent(s)" to timely and fully answer.
28 See in the nature of Federal Crop Insurance v. Merrill, 332 U.S. 380,
29 92 L. Ed 10, 68 S.Ct 1,(1947) 175 ALR 1075.

30 **ORDERS:**

31 1) Presumption is set that: Darrell-James: Hill is a natural man born of the family Hill and
32 then after named to be: James-James shall not be presumed or enabled by/in any
33 record held/maintained to be the surety for the stramineus homo "DARRELL JAMES
34 HILL," also known by the any and all of the derivatives and variations in the spelling of
35 the said name except: "Darrell-James: Hill".

2022-011769 MISC Page: 499 of 2782
09/26/2022 03:35:37 PM Receipt #: 22-9381
Rec Fee: \$30.00 Darrell James Hill
Gila County, Az, Sadle Jo Bingham, Recorder

501

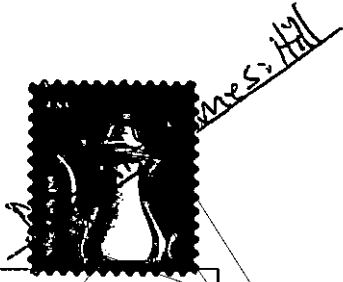

Political Status Election: Affirmation In Confirmation of Novation

- 1 2) Claim of Cestui Que Trust DARRELL JAMES HILL, CUSIP number [REDACTED], is set
- 2 that: command of the beneficial interest: Darrell-James: Hill: the natural man as
- 3 identified above.
- 4 3) Cease and desist all of the use of a doctrine of *idem sonans* by any actor to effect any
- 5 presumption or scheme reproaching Darrell-James: Hill's inherent sovereignty We the
- 6 People Rights, is set. To wit, such actions are prohibited admittedly willful and
- 7 constructive fraud, and constitutes admission of the same in the private administrative
- 8 process, etc. venue enforceable against the entity(ies), et al., by the Darrell-James: Hill
- 9 through tacit procuration.
- 10 4) Notice to the principal is notice to any of the agent(s). Notice to the agent is notice to all
- 11 of the principals.

12 EXECUTED: Affidavit In Confirmation of Political Status Election DJH002-PE 09142015-PE
 13 CE; and by this execution so be it made to be in the deed decreed and enacted on this day A.D.
 14 of the Ninth month, two thousand fifteen CE; So Be It.

Without Prejudice, UCC 1-308
 DARRELL JAMES HILL

Darrell-James: Hill
 Authorized Representative

15
 Arizona state
 Maricopa county

ss.

16 On the 14th day of the September month in the year 2015 CE: DARRELL JAMES HILL appeared
 17 before me and proved to me on the basis of satisfactory evidence to be the person who affirmed and
 18 subscribed hereto and acknowledged to me that he executed the same, and accepts the facts thereof.
 19 Subscribed and affirmed before me this day. Witness my hand and seal this

20 14th day of SEP, 2015.



KALLE KIVINEN
 Notary Public - Arizona
 Maricopa County
 Expires on 08/15/2016

21 Notary

SEAL

22 [Signature] My Commission Expires 8-15-2016

2022-011769 MISC Page: 500 of 2782
 09/26/2022 03:35:37 PM Receipt #: 22-9381
 Rec Fee: \$30.00 Darrell James Hill
 Gila County, Az, Sadie Jo Bingham, Recorder

502



Political Status Election: Affirmation In Confirmation of Novation

Unofficial Copy

**ENCLOSURE One:
Certificate of Live Birth**

Political Status Election: Affirmation In Confirmation of Novation

10 of 11

2022-011769 MISC Page: 501 of 2782
09/26/2022 03:35:37 PM Receipt #: 22-9381
Rec Fee: \$30.00 Darrell James Hill
Gila County, AZ Sadie Jo Bingham, Recorder



503

**NOTARIAL ACKNOWLEDGMENT
OF ORIGINAL, AUTHENTIC, BIRTH CERTIFICATE**

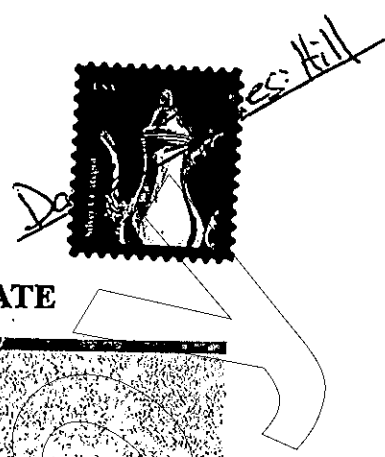

I HEREBY CERTIFY THIS DOCUMENT IS AN EXACT COPY OF THE RECORD ON FILE WITH THE OHIO DEPARTMENT OF HEALTH

DE 24 08 01 7341

Ruth Holecek
OHIO STATE REGISTRAR
DEPT. OF VITAL STATISTICS

**OHIO DEPARTMENT OF HEALTH
DIVISION OF VITAL STATISTICS
CERTIFICATE OF LIVE BIRTH**

1. PLACE OF BIRTH a. COUNTY: Summit b. CITY, VILLAGE, OR LOCATION: Akron		2. USUAL RESIDENCE OF MOTHER a. STATE: Ohio b. COUNTY: Summit c. CITY, VILLAGE, OR LOCATION: Summit	
3. NAME OF HOSPITAL OR INSTITUTION: Akron City Hospital 4. IS PLACE OF BIRTH INSIDE CITY LIMITS? YES <input checked="" type="checkbox"/> NO <input type="checkbox"/>		5. STREET ADDRESS: 219 King Ct. 6. IS RESIDENCE INSIDE CITY LIMITS? YES <input checked="" type="checkbox"/> NO <input type="checkbox"/> 7. IS RESIDENCE ON A FARM? YES <input type="checkbox"/> NO <input checked="" type="checkbox"/>	
8. CHILD'S NAME a. FIRST: Darrell b. MIDDLE: James c. LAST: Hill		9. DATE OF BIRTH: Nov 20 1958	
10. SEX: M 11. SINGLE <input checked="" type="checkbox"/> TWIN <input type="checkbox"/> TRIPLET <input type="checkbox"/>		12. FATHER'S NAME a. FIRST: Clarence b. MIDDLE: Hill c. LAST: Hill	
13. MOTHER'S MAIDEN NAME: Ora 14. MOTHER'S BIRTHPLACE: Ala.		15. FATHER'S BIRTHPLACE: Ohio 16. USUAL OCCUPATION: Carpenter	
17. INFORMANT'S NAME OR SIGNATURE: Ruth Holecek 18. ADDRESS: Akron, Ohio		19. DATE AND LOGIC TEST FOR SYMPTOMS: Mar 58 20. ATTENDANT AT BIRTH: A.D. <input checked="" type="checkbox"/> M.D. <input type="checkbox"/> MIDWIFE <input type="checkbox"/> OTHER (Specify):	
21. DATE RECD. BY LOCAL REG. OFFICE: 10-28-58		22. DATE ON WHICH GIVEN NAME ADDED: 11-28-58	

STATE OF ARIZONA
COUNTY OF MARICOPA

ON this 28th day of June, 2015 A.D., by me, a notary public in and for the said STATE OF ARIZONA, residing therein, duly commissioned and sworn, personally appeared and upon the presentation of sufficient documentation satisfactorily proved to me to be the person DARRELL JAMES HILL, and who provided to me a document from the STATE OF OHIO for notarial acknowledgment.

The document content is on a specialty multi-colored type of safety paper with repetitive circular with center of "ODH" watermark throughout observable when held up to the light; the right upper corner area bears a depressed seal mark. Document is entitled: "OHIO DEPARTMENT OF HEALTH, DIVISION OF VITAL STATISTICS, CERTIFICATE OF LIVE BIRTH".

Document content: Left side: Reg. [redacted] below is: Primary [redacted] Right side: Registrar's No. 9370: below, E [redacted]

Descriptive document content: 1. PLACE OF BIRTH: Summit.... 2. USUAL PLACE OF RESIDENCE OF MOTHER, a. STATE Ohio.... 3. CHILD: NAME: Darrell James Hill.... 7. FATHER: NAME: Clarence Hill.... 12. MOTHER: Maiden: Ora Lee Archer. With 2 signatures below: Certification of birth statement and SIGNATURE, and a REGISTRAR'S SIGNATURE in cursive writing, "Ruth Holecek"

I acknowledge this document as authentic.

Witness my hand and seal this

28th day of June, 2015.



KALLE KIVINEN
Notary Public - Arizona
Maricopa County
Expires on 08/15/2016

Notary

My Commission Expires

8-15-2016

584



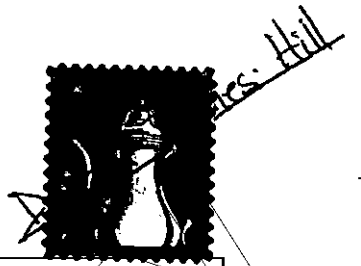

Political Status Election: Affirmation In Confirmation of Novation

Unofficial Copy

ENCLOSURE Two:
Arizona Drivers License

505

Political Status Election: Affirmation In Confirmation of Novation

11 of 11

2022-011769 MISC Page: 503 of 2782
09/26/2022 03:35:37 PM Receipt #: 22-9381
Rec Fee: \$30.00 Darrell James Hill
Gila County, Az, Sadie Jo Bingham, Recorder



**NOTARIAL ACKNOWLEDGMENT
OF ORIGINAL, AUTHENTIC, ARIZONA, Driver License**

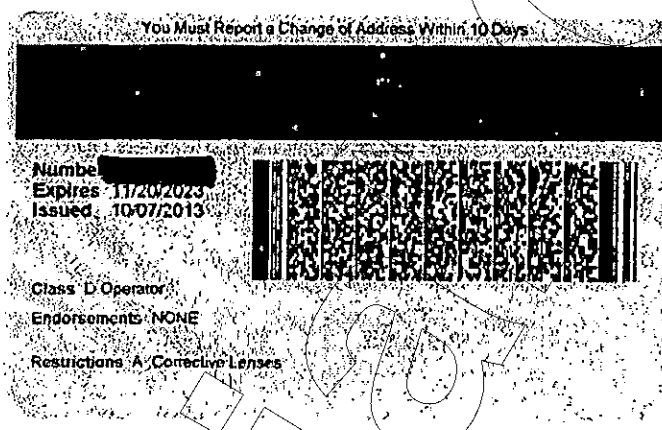

**STATE OF ARIZONA
COUNTY OF MARICOPA**

ON this 28th day of June, 2015 A.D., by me, a notary public in and for the said STATE OF ARIZONA, residing therein, duly commissioned and sworn, personally appeared and upon the presentation of sufficient documentation satisfactorily proved to me to be the person DARRELL JAMES HILL, and who provided to me a document from the STATE OF ARIZONA for notarial acknowledgment.

The document is set upon a sky-mountain background picture, is entitled "ARIZONA, DRIVER LICENSE" in the upper left corner with repetitively distributed throughout the card a 'state-shaped-picture with the words "CANYON"' following. The document is signed in the lower left corner, with a likeness picture of the presumed signer in the lower right corner. The picture in the right lower corner is a reasonable facsimile of Darrell-James: Hill.

The right upper corner document content information is: "Num [redacted] Expires 11/20/2023; Date of Birth 11/20/1958; Issued 10/07/2013.

The middle document content information is: "DARRELL JAMES HILL" with a following address location, below which is a description of a person, and below which is a signum in a white box at the left base of the card document.

I acknowledge this document as authentic.

Witness my hand and seal this
28th day of JUNE, 2015.



KALLE KIVINEN
Notary Public - Arizona
Maricopa County
Expires on 08/15/2016

Notary: [Signature] My Commission Expires 8-15-2016

506



DECLARACIÓN DE FINANCIAMIENTO / FINANCING STATEMENT
SIGA INSTRUCCIONES/ FOLLOW INSTRUCTIONS

A. NOMBRE Y NÚMERO DE CONTACTO (opcional) / NAME & PHONE OF CONTACT AT FILER (optional)
BEVERLY JEAN ROMERO

B. CORREO ELECTRÓNICO DE CONTACTO (opcional) / E-MAIL CONTACT AT FILER (optional)
bev4yah@gmail.com

C. ENVIAR CONFIRMACIÓN A (Nombre y Dirección): / SEND ACKNOWLEDGMENT TO: (Name and Address)

Secretary of the Treasury
c/o Melba Acosta Febo
PO Box 9024140
San Juan, Puerto Rico 00902-4140

DEPARTAMENTO DE ESTADO
JAN 20 2016
OFICINA DE CORRESPONDENCIA
EL ESPACIO ARRIBA ES PARA USO DEL OFICIAL DE REGISTRO
THE ABOVE SPACE IS FOR FILING OFFICE USE ONLY

1. NOMBRE DEL DEUDOR / DEBTOR'S NAME: Provea sólo un nombre de Deudor (1a o 1b) (use el nombre completo y exacto, no omita, modifique o abrevie ningún componente del nombre); si algún parte del nombre del Deudor no cabe en la línea 1b, déjela en blanco, marque aquí y provea la información del Deudor Individual en el renglón 10 del Anexo a la Declaración de Financiamiento (Forma UCC1AdPR) / Provide only one Debtor name (1a or 1b) (use exact, full name; do not omit, modify, or abbreviate any part of the Debtor's name); if any part of the Individual Debtor's name will not fit in line 1b, leave all of item 1 blank, check here and provide the Individual Debtor information in Item 10 of the Financing Statement Addendum (Form UCC1AdPR)

1a. NOMBRE DE LA ENTIDAD / ORGANIZATION'S NAME
Secretary of the Treasury

OR

1b. APELLIDO / INDIVIDUAL'S SURNAME NOMBRE / FIRST PERSONAL NAME SEGUNDO NOMBRE / ADDITIONAL NAME SUFJO / SUFFIX

1c. DIRECCIÓN POSTAL / MAILING ADDRESS CIUDAD / CITY ESTADO STATE CÓDIGO POSTAL / POSTAL CODE PAÍS COUNTRY

PO Box 9024140 San Juan PR 00902-4140 US

2. NOMBRE DEL DEUDOR/ DEBTOR'S NAME: Provea sólo un Deudor adicional (2a o 2b) (Use el nombre completo y exacto, no omita, modifique o abrevie ninguna parte del nombre). Si cualquier parte de un nombre no cupiera en el espacio provisto en la 2b, deje toda la sección 2-en blanco, marque aquí y provea el nombre completo en el renglón 10 en el Anexo de la Declaración de Financiamiento (Forma UCC1AdPR) / Provide only one Debtor name (2a or 2b) (use exact, full name; do not omit, modify, or abbreviate any part of the Debtor's name); if any part of the Individual Debtor's name will not fit in line 2b, leave all of item 2 blank, check here and provide the Individual Debtor information in Item 10 of the Financing Statement Addendum (Form UCC1AdPR)

2a. NOMBRE DE LA ENTIDAD / ORGANIZATION'S NAME

OR

2b. APELLIDO / INDIVIDUAL'S SURNAME NOMBRE / FIRST PERSONAL NAME SEGUNDO NOMBRE / ADDITIONAL NAME SUFJO SUFFIX

2c. DIRECCIÓN / MAILING ADDRESS CIUDAD / CITY ESTADO STATE CÓDIGO POSTAL / POSTAL CODE PAÍS COUNTRY

3. NOMBRE DEL ACREEDOR GARANTIZADO (o NOMBRE DE CESIONARIO): Provea solo un nombre de Acreedor Garantizado (3a o 3b) **SECURED PARTY'S NAME (or NAME of ASSIGNEE):** Provide only one Secured Party name (3a or 3b)

3a. NOMBRE DE LA ENTIDAD / ORGANIZATION'S NAME

OR

3b. APELLIDO / INDIVIDUAL'S SURNAME NOMBRE / FIRST PERSONAL NAME SEGUNDO NOMBRE / ADDITIONAL NAME SUFJO SUFFIX

3c. DIRECCIÓN POSTAL / MAILING ADDRESS CIUDAD / CITY ESTADO STATE CÓDIGO POSTAL / POSTAL CODE PAÍS COUNTRY

c/o PO Box 3806 Apache Junction AZ 85120 US

4. COLATERAL: Esta declaración de financiamiento cubre la siguiente colateral: / **COLLATERAL:** This financing statement covers the following collateral:

The trust beneficiary/secured party's right of trust collateral usufruct under the Trading with the Enemy Act of 1917, the Emergency Bank Relief Act -enacted March 09, 1933, and the Executive Orders thereto for the trust beneficiary/real party in interest as identified by the utility of the transmission, the organic document "CERTIFICATE OF LIVE BIRTH;" the collateral interest thereto activated by law by this chose in action on proof to be alive- sui juris in any action for the recovery of interest of the same.

SEE USPO M/O #2500 # 22715966305

5. Marque solo si aplica y solo una opción: Colateral está en posesión de un Fideicomiso (véase UCC1AdPR, renglón 7 e Instrucciones) administrado por Representante de un difunto Check only if applicable and check only one box: Collateral is held in a Trust (See UCC1AdPR, Item 17 and instructions) being administered by a Decedent's Personal Representative

6a. Marque solo si aplica y una sola alternativa / Check only if applicable and check only one box:

Transacción de Financiamiento Público / Public-Finance Transaction Transacción de Casa Prefabricada / Manufactured-Home Transaction Un Deudor es una entidad transmisora / A Debtor is a Transmitting Utility

6b. Marque solo si aplica y solo una alternativa / Check only if applicable and check only one box:

Gravamen Agrícola / Agricultural Lien Inscripción extraregistrarial / Non-UCC Filing

7. DESIGNACIÓN ALTERNATIVA (si aplica): Arrendador/Arrendatario / Lessor/Lessee Consignatario/ Consignador / Consignee/Consignor Vendedor/ Comprador / Seller/Buyer Depositario/ Feador / Bailee/Bailor Concesionario/Concedente / Licensee/Licensor

8. DATOS OPCIONALES DE REFERENCIA PARA EL SOLICITANTE / OPTIONAL FILER REFERENCE DATA: Stamp Accepted and return second original within the enclosed SASE. Thank-you.

C OPIA OFICINA DE REGISTRO—DECLARACIÓN DE FINANCIAMIENTO (Forma UCC1PR) (Rev. 05/09/14)

507

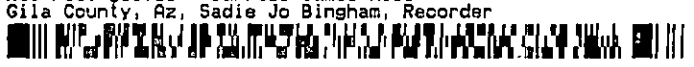

SECURITY AGREEMENT BJR002-SA 09142015-SA CE
Non-Negotiable – Private Agreement Between two Parties

Bev

Romero-Hill

Beneficiary:

BEVERLY JEAN ROMERO
c/o ~~Juan Zaragoza Gomez~~,
Secretary of the Treasury
Department of the Treasury,
P.O. Box 9024140,
San Juan, Puerto Rico 00902-4140

Trustee:

~~Juan Zaragoza Gomez~~,
Secretary of the Treasury
Department of the Treasury,
P.O. Box 9024140,
San Juan, Puerto Rico 00902-4140

COPY

1
2
3
4
5
6
7
8
9
10
11
12
13
14
15
16
17
18
19
20
21
22
23
24

Security Agreement:
Authorization Of Expenditure Of Account Benefits:
BEVERLY JEAN ROMERO, CUSIP Number [REDACTED]

This Security Agreement is for to input this "Authorization For The Benefits Requested" to the preexisting Fiduciary Trust Relationship existing from the creation of the novation "BEVERLY JEAN ROMERO" Cesti Qui Trust, "CQT", between the Trustee, the Office of the Secretary of the Treasury, Foreign Property Custodian, and Claims Settlement Officer, et al., Puerto Rico, "Trustee", and the principal live born child "Romero Beverly-Jean" also known as "Beverly-Jean: Romero-Hill" sui juris, the Authorized Representative of the novation and the private person substantiating the existence of the novation. See the: A) Birth Certificate: ENCLOSURE One; B) Arizona Driver's License: ENCLOSURE Two; C) Political Status Election, BJR002-PE, A.D. 09142015-PE: ENCLOSURE Three.

This: Security Agreement corroborates that:

- a) The presence of the benefit of equity held within the CQT by the Trustee is for the novation Beneficiary of/for the Principal Beneficiary, and for the chose of benefit by the Beneficiary upon request/ demand as stated herein; and:
- b) This Security Agreement is a continuing instrument expressly in the favor of the Beneficiary, which continues in the effect though all, or any part of, indebtedness that was, is or may be discharged/ settled in the full, and notwithstanding of the fact that a period of a time may pass in which the Beneficiary incurs no indebtedness necessitating a requirement of the Trustee attention.
- c) This instrument is for: i) the presentation of the novation BEVERLY JEAN ROMERO, de facto beneficiary for the principal de jure Beverly-Jean: Romero-

508



SECURITY AGREEMENT BJR002-SA 09142015-SA CE
Non-Negotiable – Private Agreement Between two Parties

INTENTIONALLY LEFT BLANK

509

SECURITY AGREEMENT BJR002-SA 09142015-SA CE

2022-011769 MISC Page: 507 of 2782
09/26/2022 03:35:37 PM Receipt #: 22-9381
Rec Fee: \$30.00 Darrell James Hill
Gila County, Az, Sadie Jo Bingham, Recorder



pl/13

Ben
Darrell James Hill

Unofficial Copy



**SECURITY AGREEMENT BJR002-SA 09142015-SA CE
Non-Negotiable – Private Agreement Between two Parties**

Hill; ii) to declare the adult sui juris authorization with the Trustee for the authorized discharge and distribution of benefit to the Beneficiary; and, iii) to be Not limiting or restricting upon the general capacity of the Trustee to benefit the Beneficiary.

Authorization:

I, BEVERLY JEAN ROMERO, authorize the Trustee, respectfully to privately render an accounting to the penny, discharge debts, lend and distribute funds, and so to act in every lawful act, and to act in the implementation of my choses of action heretofore and until further notice; for:

To exercise, act or perform in all lawful duty in support of my benefit; to wit:

1. To receive trust information
2. To discharge of a debt as indicated; and,
3. To directly distribute of the assets as indicated.
4. To afford defense for the all legal/lawful proceedings touching the Beneficiary, or any part thereof in any matter which Beneficiary may be in any way concerned; including, the principal Beneficiary, and to make, execute and deliver to the Beneficiary all endorsements, acquittances, releases, receipts or other sufficient discharges upon notice of the same.
5. To engage in and actively transact any and all lawful business authorized by the Beneficiary.
6. To deposit any funds or money(ies) that may become authorized by Beneficiary with/into any bank/financial institution or banker/bailee as directed, and to receive and maintain records for all completed transaction(s).

7. Other right(s) and Remedies:

1. Novation BEVERLY JEAN ROMERO is the/a commercial transmitting utility.
2. Natural person Beverly-Jean: Romero- Hill, sui juris, claims: I) Live Ownership of the mature, adult, live being and private body under Almighty God, and, II) possession of all of the rights and remedies unto the Beneficiary by every operation under this authorization and, III) exercise of the any and all of the other rights and remedies available at the law, in the equity, and of the otherwise. IV) Therefore, heretofore, all records MUST NOTICE AND REFLECT THE SAME: i) Beverly-Jean: Romero- Hill HAVE PRESENTED SUI JURIS HEREIN, ii) Beverly-Jean: Romero- Hill IS NOT SURETY FOR THE NOVATION BEVERLY JEAN ROMERO, and iii) the presumption is thus set.

510

SECURITY AGREEMENT BJR002-SA 09142015-SA CE
Non-Negotiable – Private Agreement Between two Parties

INTENTIONALLY LEFT BLANK

SECURITY AGREEMENT BJR002-SA 09142015-SA CE

511
2022-011769 MISC Page: 509 of 2782
09/28/2022 03:35:37 PM Receipt #: 22-9381
Rec Fee: \$30.00 Darrell James Hill
Gila County, Az, Sadie Jo Bingham, Recorder



Darrell James Hill
A square, textured stamp containing a signature, likely of Darrell James Hill.
Sadie Jo Bingham

P2/13

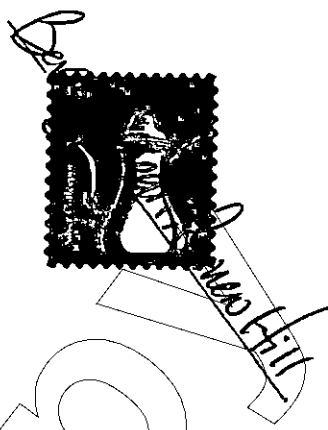

SECURITY AGREEMENT BJR002-SA 09142015-SA CE
Non-Negotiable – Private Agreement Between two Parties

1 **Rules of Construction of the Security Agreement:**

- 2 a) words “include,” “includes,” and “including” are not limiting;
- 3 b) word “all” includes “any” and the word “any” includes “all,”
- 4 c) word “or” is not exclusive;
- 5 d) words and terms: i) in the singular number includes the plural, and in the plural
- 6 number includes the singular; and ii) in the masculine gender includes both the
- 7 feminine and neuter; and:
- 8 e) This instrument shall be construed and interpreted generally, and specifically the
- 9 enumeration of specific items, acts, rights or powers in this Authorization
- 10 agreement does not limit or restrict and shall not be construed or interpreted as
- 11 limiting or restricting the lawful general responsibility and duty of the Trustee.

12 **Miscellaneous Provisions Part of this Security Agreement:**

13 **Amendments:** This Security Agreement, together with the any of the related
14 documents and endorsements, constitutes of the entire understanding and agreement
15 regarding any of the matter of the private authorized distribution of benefit set forth
16 in this Security Agreement. Therefore: Security Agreement may neither be changed
17 nor modified in the any manner whatsoever unless that of the said change/
18 modification is agreed upon by the Beneficiary by the writing and signing by the
19 Beneficiary, et al., with the recording of the same instrument with the UCC as an
20 amendment and/or addendum. To this end all precautions for the safe operational
21 ability to distribute benefit to the Beneficiary by the Trustee is the ONLY goal of this
22 Authorization.

23 **Severability:**

24 In the event that this Security Agreement, including that of the any amendment,
25 addendum, and revision, is unlawful for a reason identified on its basis of the being
26 unlawful, invalid, void or voidable, unenforceable, and the like, then such provisions
27 are thereby to be noticed to the Beneficiary, and severed from this Security
28 Agreement, but every remaining provision continues in the fullness of the force and
29 effect and may not be affected by such of a determination. If feasible, any of the such
30 offending provisions may be deemed modified for inclusion within the limits of its
31 authorization, enforceability and validity; however, in the event that the offending
32 provision(s) cannot be so modified, then the said offending provision is thereby
33 stricken, and the all of the other provisions of this Security Agreement in the any of
34 the other respects remains valid and enforceable by the Beneficiary.

512



SECURITY AGREEMENT BJR002-SA 09142015-SA CE
Non-Negotiable – Private Agreement Between two Parties

INTENTIONALLY LEFT BLANK

SECURITY AGREEMENT BJR002-SA 09142015-SA CE

2022-011769 MISC Page: 511 of 2782
09/26/2022 03:35:37 PM Receipt #: 22-9381
Rec Fee: \$30.00 Darrell James Hill
Gila County, Az, Sadie Jo Bingham, Recorder



Bar
Darrell James Hill

P3/13

513

Unofficial Copy

Beverly Jean Romero Hill

**SECURITY AGREEMENT BJR002-SA 09142015-SA CE
Non-Negotiable – Private Agreement Between two Parties**

1 **Waiver:**
2 Beneficiary waives No right(s) under this Security Agreement unless such of a waiver
3 is given in the writing and signed by the Beneficiary in blue ink.
4 Neither by a delay nor by an omission on the part of the Beneficiary in the exercise of
5 a right shall such be presumed to operate as that of a waiver of the right or of the any
6 of an other right.
7 In the any waiver by the Beneficiary of the any provision(s) of this Security
8 Agreement, incidence of a waiver neither prejudices, nor constitutes any of an other
9 waiver of the Beneficiary's right for otherwise demanding a strict compliance with
10 that provision, or in the any other of the provisions, of this Security Agreement.
11 Whenever the consent of the BEVERLY JEAN ROMERO is required under this
12 Security Agreement, then: Beneficiary's granting of such of a consent shall not be
13 construed as constituting of a continuing consent for the any of the subsequent
14 instances wherein such of a consent is required; and in the any of the instant
15 matter(s), such of a consent may be granted and withheld in the sole discretion of the
16 Beneficiary.

17 **Words Defined; Glossary of Terms.** As used in this Security Agreement, the following
18 words and terms are as defined in this section, non obstante:
19 "All" means: everything that is, or of that one has or may have: whole number; totality,
20 including without a restriction.
21 "Almighty God" means: He who exists before all that universally is began; the Father of
22 the Lord God Yushua, the only begotten Son (Creator of all that universally is and the
23 Lord God of of the patriarchs: Abraham, Isaac and Jacob); the Divine Father adoptive to
24 the Romero Beverly-Jean as a result of the sacrifice made by His only begotten Son
25 Yushua for all grace; the Divine Father which Nothing comes between Him and Beverly-
26 Jean: Romero- Hill.
27 "Artificial Person" means: novation, commercial person: BEVERLY JEAN ROMERO,
28 also known by any and all of the linear derivatives and variations in the spelling of the
29 said name except "Beverly-Jean: Romero- Hill."
30 "Authorized Representative" or "A.R." or "AR" means: Beverly-Jean: Romero- Hill
31 sui juris, authorized representative of the BEVERLY JEAN ROMERO novation.
32 "Beneficial interest" means: profit, benefit, or advantage resulting from a contract, or
33 from the ownership of an estate(s) or trust(s) as distinct from the legal ownership or

514

2022-011769 MISC Page: 512 of 2782
09/25/2022 03:35:37 PM Receipt #: 22-9381
Rec Fee: \$30.00 Darrell James Hill
Gila County, Az, Sadie Jo Bingham, Recorder

SECURITY AGREEMENT BJR002-SA 09142015-SA CE
Non-Negotiable – Private Agreement Between two Parties

INTENTIONALLY LEFT BLANK

SECURITY AGREEMENT BJR002-SA 09142015-SA CE

2022-011769 MISC Page: 513 of 2782
09/26/2022 03:35:37 PM Receipt #: 22-9381
Rec Fee: \$30.00 Darrell James Hill
Gila County, Az, Sadie Jo Bingham, Recorder



Ben
Darrell James Hill

P4/B

515

Unofficial Copy

SECURITY AGREEMENT BJR002-SA 09142015-SA CE
Non-Negotiable – Private Agreement Between two Parties

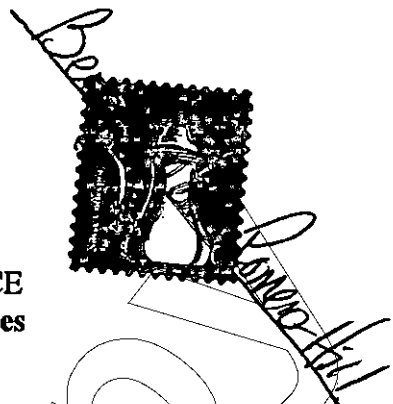

1 control of the said estate or trust.
2 **“Beneficiary”** means: One for whose benefit that of a trust is created: a cestui que trust.
3 **“Beyond the sea”** means: beyond all of the limits-of/ outside of the UNITED STATES -
4 to wit: territory over the which does not extend any of the sovereignty of the UNITED
5 STATES government; such as, Not of a United States’ territory, Citizen, person or
6 commercial holding idea, etc., and of the like, as opposed to that of a natural person or de
7 jure Citizen under the Sovereign Almighty God as the covenanted We the People of the
8 united States of America, the same understanding The Constitution for the united States
9 of America- 1787 CE.
10 **“CE”** means: common era or christian era or current era as regarding the year date
11 accounting concurrently synonymous with **“AD”**- to wit: anno Domini.
12 **“Claim”** means, noun: 1) right or title to a privilege, or of another thing in the possession
13 of another; not strictly that of the possession, but by the means by which the claimant
14 attains to the possession or enjoyment of the said possession; 2) right of the payment,
15 when such of a right is rendered into the form of a judgment, or for the damages, as well
16 as of under the rulings in regards to that of an equitable remedy for the breach of a
17 performance, when such of a breach results in a right of the payment, or of when that of
18 an equitable remedy is rendered in the form of a judgment in regards to the payment of
19 some debt or obligation. Verb: demand as of one’s own, asserted as of one’s personal right
20 to the any properties or right of a possession or of the enjoyment of a something
21 considered rightfully of one’s own, and wrongfully withheld.
22 **“Conduit”** means: transmitting utility distributing energy and effects in the commerce,
23 such as of the goods and services, via the name novation BEVERLY JEAN ROMERO
24 and of the any linear derivatives and variations in the spelling of said name of the
25 BEVERLY JEAN ROMERO except "Beverly-Jean: Romero- Hill."
26 **“Collateral”** means: property and property right(s) of the BEVERLY JEAN ROMERO,
27 now owned and hereafter acquired, now existing and hereafter arising, and wherever
28 located, with such of an ownership either in the name of the BEVERLY JEAN ROMERO
29 or in the name of another, in which: Beneficiary holds of a beneficial interest, and of a
30 security for the entire obligation or of the any amount of the indebtedness.
31 **“Commercial person”** means: abstract or legal entity, ens legis, such as of a corporation,
32 created by the construct of the law and considered as possessing certain of the legal rights
33 and duties of a legal being: an imaginary entity, such is as of a novation; to-wit: novation
34 BEVERLY JEAN ROMERO, which, on the basis of the legal reasoning, is de facto
35 legally treated as: fictitious “person” or “being” for the purpose of conducting in a
36 commercial activity for the Principal Beneficiary de jure.

516



SECURITY AGREEMENT BJR002-SA 09142015-SA CE
Non-Negotiable – Private Agreement Between two Parties

INTENTIONALLY LEFT BLANK

SECURITY AGREEMENT BJR002-SA 09142015-SA CE

2022-011769 MISC Page: 515 of 2782
09/26/2022 03:35:37 PM Receipt #: 22-9381
Rec Fee: \$30.00 Darrell James Hill
Gila County, Az, Sadie Jo Bingham, Recorder

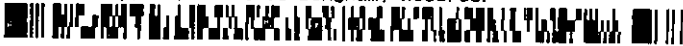

Bella
Darrell James Hill
P 5/13

517

SECURITY AGREEMENT BJR002-SA 09142015-SA CE
Non-Negotiable – Private Agreement Between two Parties

Beverly
Romero-Hill



1 **“Derivative”** means by the way of another; taken out of a something preceding:
2 secondary; of that which is not of the origin in and of itself, but is that of the which is
3 obtained from the existence out of some foregoing thing and from a more primal and
4 fundamental nature.
5 **“Drawer”** means: Beneficiary or BEVERLY JEAN ROMERO or the any of the linear
6 derivatives and variations of said names in the any manner whatsoever regarding any of
7 the assets or contracts or promissory notes or titles or grants or accounts or instruments,
8 trusts, or agreements in the any form whatsoever bearing the name(s): Beverly-Jean:
9 Romero- Hill, or BEVERLY JEAN ROMERO, respectively, or any linear derivatives and
10 variations of the said name.
11 **“Ens legis”** means: creature of the law or of an artificial being, such as is, that of a
12 “corporation”: deriving of an existence into a being or entity fabricated entirely by the
13 law, as contrasted with that of a natural person.
14 **“Endorsement”** means “indorsement:” act of a payee, drawee, accommodation indorser,
15 or holder of a bill, note, check, or of an other negotiable instrument, wherein placing onto
16 of his signum upon the back of the same, with or without further or qualifying words,
17 that thereby: property in the same is assigned and transferred to another.
18 **“Entitlement Holder”** means: Beverly-Jean: Romero- Hill sui juris having standing in a
19 security entitlement in the any of the security or asset or contract or promissory note or
20 title or grant or account or instrument or agreements in the any of the forms whatsoever
21 bearing novation BEVERLY JEAN ROMERO, or any linear derivatives and variations of
22 the said name except Beverly-Jean: Romero- Hill.
23 **“Ground”** means: land or soil or earth above the sea, beyond the sea; to wit: dirt, the soil
24 or the dust, to-wit: mineral composition, precursors and substance elements of the
25 corporeal man.
26 **“Issuer”** means: Beverly-Jean: Romero- Hill sui juris or BEVERLY JEAN ROMERO,
27 respectively, of the maker or drawer of the any of the assets or contract or promissory
28 note or title or grant or account or instrument or agreement in the any form whatsoever.
29 **“Land”** means: dry ground and dry earth soil whatsoever, inclusive of the pastures,
30 fields, meadows, woods, moors, waters, marshes, rock, elements, and sand, as against
31 that of the sea or ocean.
32 **“Legal Entity”** means: entity ens legis as against that of a natural person; Of the
33 artificial sufficient existence in and of the legal contemplation that of the said entity may
34 function legally or sue and be sued or make decisions through its representative(s).
35 **“Living and breathing, flesh-and-blood man”** means: Romero Beverly-Jean, Beverly-
36 Jean: Romero- Hill, of a biological and spiritual and soul being: natural person as against

518



SECURITY AGREEMENT BJR002-SA 09142015-SA CE
Non-Negotiable – Private Agreement Between two Parties

INTENTIONALLY LEFT BLANK

SECURITY AGREEMENT BJR002-SA 09142015-SA CE

2022-011769 MISC Page: 517 of 2782
09/26/2022 03:35:37 PM Receipt #: 22-9381
Rec Fee: \$30.00 Darrell James Hill
Gila County, Az, Sadie Jo Bingham, Recorder



Belev
meat-hill

P 6/13

519

Unofficial Copy

SECURITY AGREEMENT BJR002-SA 09142015-SA CE
Non-Negotiable – Private Agreement Between two Parties

Beverly Jean Romero Hill

1 that of an artificial legal construct or ens legis- to wit, created by construct of the law.
2 **“Maker”** means: (a) Settlor, or (b) Adult Beneficiary in regards to the any of the assets or
3 contract or promissory note or title or grant or account or instrument or agreement in-
4 bearing the name(s) Beverly-Jean: Romero- Hill sui juris, or novation BEVERLY JEAN
5 ROMERO, respectively.
6 **“Natural person”** means: sentient being living on the ground, beyond of the sea, that of
7 a “living and breathing, flesh-and-blood man,” as against that of an artificial person(s) or
8 commercial person ens legis.
9 **“Non obstante”** means: words anciently used in the public and private instruments
10 intended to preclude, in advance, any of the interpretations contrary to the certain
11 declared objects or purposes.
12 **“Novation”** means: the act of substituting a “new” fiction with a “new” obligation in
13 place of the original natural entity due the original natural obligation; often a commercial
14 device to facilitate operations in obligations due to a non-commercial original; for
15 example: en legis entity BEVERLY JEAN ROMERO, beneficiary de facto to facilitate
16 operations in obligations for the Romero Beverly-Jean principal beneficiary de jure.
17 **“Private”** means: lawfully not subject to common knowledge or awareness.
18 **“Romero Beverly-Jean”** means: Beverly-Jean: Romero- Hill de jure- the natural person,
19 In: 1) Sovereign “We The People” Status of The Constitution For The United States of
20 America-1787 CE.: 2) Political Status Election: ENCLOSURE Three; and: 3) natural
21 person of the non-commercial status.
22 **“Security”** means: TRUST.
23 **“Security Agreement”** means: “SA”, trust agreement, with the all of the attachments
24 and incorporations made by the reference.
25 **“Securities Intermediary”** means: bank or broker or clearing corporation or bailee that
26 is acting in the capacity of the maintaining of a security account service.
27 **“Signature”** means in the nature of, U.C.C. § 3-401 – 2002, what is considered signum,
28 which is herein incorporated by a reference.
29 **“Signed”** means in the nature of, U.C.C. § 1-201 (37) – 2001, what is considered signum,
30 which is herein incorporated by a reference.
31 **“Signum”** means: sign, mark, seal, or writing mad for to identify or authenticate, or to
32 give validity of one’s own act: signature.
33 **“Sui Juris”** means: of full age, capacity and standing, possessing all natural and
34 inalienable rights, and protection of same from/by the governmental construct, et al.
35 **“Trade-name”** means: commercial person “BEVERLY JEAN ROMERO”, as well as the
36 any of the linear derivatives and variations in the spelling of that said name, respectively,

520



SECURITY AGREEMENT BJR002-SA 09142015-SA CE
Non-Negotiable – Private Agreement Between two Parties

INTENTIONALLY LEFT BLANK

SECURITY AGREEMENT BJR002-SA 09142015-SACE

2022-011769 MISC Page: 519 of 2782
09/26/2022 03:35:37 PM Receipt #: 22-9381
Rec Fee: \$30.00 Darrell James Hill
Gila County, Az, Sadie Jo Bingham, Recorder



Beale
James Hill
9/13

521

Unofficial Copy

SECURITY AGREEMENT BJR002-SA 09142015-SA CE
Non-Negotiable – Private Agreement Between two Parties

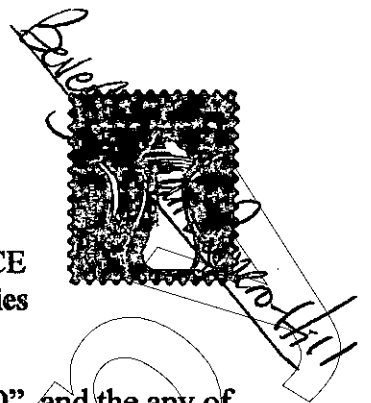

1 except "Beverly-Jean: Romero- Hill."
2 **"BEVERLY JEAN ROMERO"** means: "BEVERLY JEAN ROMERO", and the any of
3 the linear derivatives and variations in the spelling of the said name except "Beverly-Jean:
4 Romero- Hill": All of the right(s) reserved regarding trade-name/trade-mark 2015 CE, et
5 seq. - All of the right(s) reserved.
6 **"transmitting utility"** means: the stramineus homo, en legis, novation BEVERLY JEAN
7 ROMERO: duty by construction and design for the the transmitting of letters, writings,
8 papers, news, and the like, from one commercial construct to another; the mechanism for to
9 communicate rights, titles, and privileges while inherently representing the natural person,
10 the Principal Beneficiary.
11 **"Beverly-Jean: Romero- Hill"** means: "Romero Beverly-Jean" de jure: natural person
12 of this SA and CQT, the Confirmation of the presumption of the novation BEVERLY
13 JEAN ROMERO: to wit: the natural person of soul under the Almighty God identified by
14 the family name: "Romero", and upon his birth, "Beverly" -second name, and "Jean"
15 -third name: to wit: Romero Beverly-Jean: him to who the de jure confirmations- made
16 before refer. All of the right(s) reserved regarding the any use of the name "Beverly-Jean:
17 Romero- Hill" signum, Common-law trade-name/trade-mark 2015 CE, et seq.- All of the
18 right(s) reserved.
19 **"U.C.C. § 1-201(37) – (2001)"** means in the nature of "includes using any symbol
20 executed or adopted with present intention to adopt or accept a writing."
21 **"U.C.C. § 3-401– (2002)"** means in the nature of, "(a) A person is not liable on an
22 instrument unless (i) the person signed the instrument, or (ii) the person is represented by
23 an agent or representative who signed the instrument and the signature is binding on the
24 represented person under Section 3-402. (b) A signature may be made (i) manually or by
25 means of a device or machine, and (ii) by the use of any name, including a trade or
26 assumed name, or by a word, mark, or symbol executed or adopted by a person with
27 present intention to authenticate a writing."
28 **"U.C.C. § 9-607– (2010)"** means in the nature of, "(a) [Collection and enforcement
29 generally.] If so agreed, and in any event after default, a secured party: (1) may notify a
30 debtor or other person obligated on collateral to make payment or otherwise render
31 performance to or for the benefit of the secured party; (2) may take any proceeds to
32 which the secured party is entitled under Section 9-315; (3) may enforce the obligations
33 of an account debtor or other person obligated on collateral and exercise the right(s) of
34 the debtor with respect to the obligation of the account debtor or other person obligated
35 on collateral to make payment or otherwise render performance to the debtor, and with
36 respect to any property that secures the obligations of the account debtor or other person

522

SECURITY AGREEMENT BJR002-SA 09142015-SA CE
Non-Negotiable – Private Agreement Between two Parties

INTENTIONALLY LEFT BLANK

SECURITY AGREEMENT BJR002-SA 09142015-SA CE

523
2022-011769 MISC Page: 521 of 2782
09/26/2022 03:35:37 PM Receipt #: 22-9381
Rec Fee: \$30.00 Darrell James Hill
Gila County, Az, Sadie Jo Bingham, Recorder



Belmont
11/11

A square notary seal stamp, partially obscured by handwritten text. The seal contains a central emblem, likely the state seal of Arizona, surrounded by text that is mostly illegible due to the stamp quality and handwriting.

p8/3

Handwritten initials and a stamp in the top right corner.

**SECURITY AGREEMENT BJR002-SA 09142015-SA CE
Non-Negotiable -- Private Agreement Between two Parties**

1 obligated on the collateral; (4) if it holds a security interest in a deposit account perfected
2 by control under Section 9-104(a)(1), may apply the balance of the deposit account to the
3 obligation secured by the deposit account; and (5) if it holds a security interest in a
4 account perfected by control under Section 9-104(a)(2) or (3), may instruct the bank to
5 pay the balance of the deposit account to or for the benefit of the secured party. (b)
6 [Nonjudicial enforcement of mortgage.] If necessary to enable a secured party to exercise
7 under subsection (a)(3) the right of a debtor to enforce a mortgage non-judicially, the
8 secured party may record in the office in which a record of the mortgage is recorded: (1)
9 a copy of the security agreement that creates or provides for a security interest in the
10 obligation secured by the mortgage; and (2) the secured party's sworn affidavit in
11 recordable form stating that: (A) a default has occurred with respect to the obligation
12 secured by the mortgage; and (B) the secured party is entitled to enforce the mortgage
13 non-judicially. (c) [Commercially reasonable collection and enforcement.] A secured
14 party shall proceed in a commercially reasonable manner if the secured party: (1)
15 undertakes to collect from or enforce an obligation of a account debtor or other person
16 obligated on collateral; and (2) is entitled to charge back uncollected collateral or
17 otherwise to full or limited recourse against the debtor or a secondary obligor. (d)
18 [Expenses of collection and enforcement.] A secured party may deduct from the
19 collections made pursuant to subsection (c) reasonable expenses of collection and
20 enforcement, including reasonable attorney's fees and legal expenses incurred by the
21 secured party."

INTENTIONALLY LEFT BLANK

Unofficial
524

2022-011769 MISC Page: 522 of 2782
09/26/2022 03:35:37 PM Receipt #: 22-9381
Rec Fee: \$30.00 Darrell James Hill
Gila County, Az, Sadie Jo Bingham, Recorder



SECURITY AGREEMENT BJR002-SA 09142015-SA CE
Non-Negotiable – Private Agreement Between two Parties

INTENTIONALLY LEFT BLANK

SECURITY AGREEMENT BJR002-SA 09142015-SACE

525
2022-011769 MISC Page: 523 of 2782
09/26/2022 03:35:37 PM Receipt #: 22-9381
Rec Fee: \$30.00 Darrell James Hill
Gila County, Az, Sadie Jo Bingham, Recorder



pg 13

Basil
Darrell James Hill

SECURITY AGREEMENT BJR002-SA 09142015-SA CE
Non-Negotiable – Private Agreement Between two Parties

Beverly Jean Romero Hill

1 Babel Communications

2 The content of this document is written nunc pro tunc in the language with the babel
3 communication common on the day of this document as distinguished against Complete-
4 Sentence-Sense-Parse-Syntax-Grammar, "C-S-S-P-S-G" context communication. Any
5 translation and/or interpretation shall be contextually metered and construed in
6 accordance within the meaning(s) intended by the Party.

7 This: Security Agreement BJR002-SA 09142015-SA CE:

8 Without Prejudice UCC 1-308

9 BEVERLY JEAN ROMERO

Beverly Jean Romero Hill
~~BEVERLY JEAN ROMERO~~

12 Authorized Representative

Arizona state

ss.

Maricopa county

13 On the day 14 of the month September in the year 2015 CE: BEVERLY JEAN ROMERO-
14 HILL appeared before me and proved to me on the basis of satisfactory evidence to be the
15 person who affirmed and subscribed hereto and acknowledged to me that he executed the
16 same, and accepts the facts thereof. Subscribed and affirmed before me this day. Witness my
17 hand and seal this

18 14th day of SEP, 2015.



KALLE KIVINEN
Notary Public - Arizona
Maricopa County
Expires on 08/15/2016

19 Notary

SEAL

20  My Commission Expires 8-15-2016



526

SECURITY AGREEMENT BJR002-SA 09142015-SA CE
Non-Negotiable – Private Agreement Between two Parties

INTENTIONALLY LEFT BLANK

SECURITY AGREEMENT BJR002-SA 09142015-SACE

2022-011769 MISC Page: 525 of 2782
09/26/2022 03:35:37 PM Receipt #: 22-9381
Rec Fee: \$30.00 Darrell James Hill
Gila County, Az, Sadie Jo Bingham, Recorder



P10/13

Ben
Darrell James Hill

527

Unofficial Copy

SECURITY AGREEMENT BJR002-SA 09142015-SA CE
Non-Negotiable – Private Agreement Between two Parties



ENCLOSURE-One

SECURITY AGREEMENT BJR002-SA 09142015-SA CE

11 of 13

528
2022-011769 MISC Page: 526 of 2782
09/26/2022 03:35:37 PM Receipt #: 22-9381
Rec Fee: \$30.00 Darrell James Hill
Gila County, Az, Sadie Jo Bingham, Recorder



SECURITY AGREEMENT BJR002-SA 09142015-SA CE
Non-Negotiable – Private Agreement Between two Parties

INTENTIONALLY LEFT BLANK

SECURITY AGREEMENT BJR002-SA 09142015-SACE

529
2022-011769 MISC Page: 527 of 2782
09/26/2022 03:35:37 PM Receipt #: 22-9381
Rec Fee: \$30.00 Darrell James Hill
Gila County, Az, Sadie Jo Bingham, Recorder



Bella

Darrell James Hill
9/14/13

**NOTARIAL ACKNOWLEDGMENT
OF ORIGINAL, AUTHENTIC. BIRTH CIERTIFICATE**

Beverly Hill

THIS DOCUMENT IS NOT AUTHENTIC UNLESS PRODUCED ON SECURITY PAPER

**CERTIFICATE OF BIRTH
CERTIFICADO DE NACIMIENTO**

STATE OF NEW MEXICO
New Mexico Vital Records and Health Statistics
Public Health Division

**NEW MEXICO
DEPARTMENT OF
HEALTH**

ESTADO DE NUEVO MEXICO
Registros Vitales y Estadísticas de Salud de Nuevo Mexico
Division de Salud Publica

I certify that the following birth is registered in the New Mexico Vital Records and Health Statistics
Certifico que en la Sección del Registro de Nacimientos a mi cargo aparece la siguiente inscripción

File No. / Número de Archivo	Request No. / Número de Solicitud	County of Birth / Condado de Nacimiento
[REDACTED]	[REDACTED]	RIO ARRIBA
Date of Birth / Fecha de Nacimiento	Date of Registration / Fecha de Inscripción	Sex / Sexo
JUNE 15, 1958	JUNE 15, 1958	FEMALE
Name of Person Registered / Nombre del Escrito		
>>> BEVERLY JEAN ROMERO <<<		
Name of Father or Parent (Last / Nombre del Padre		
>>> DELFERIO C ROMERO <<<		
Birth Name of Mother or Parent (Last / Nombre de la Madre		
>>> MARY ARGUELLO <<<		
No. [REDACTED]		

WARNING: IT IS ILLEGAL TO COPY OR COUNTERFEIT THIS CERTIFICATE
ADVERTENCIA: ES ILLEGAL ALTERAR, COPIAR O FALSIFICAR ESTE CERTIFICADO

Donna Dorsey
SIGNATURE OF STATE REGISTRAR
FIRMA DEL REGISTRADOR DEL ESTADO
APRIL 24, 2007

DO NOT DUPLICATE BY ANY MEANS

**STATE OF ARIZONA
COUNTY OF MARICOPA**

ON this 28th day of June, 2015 A.D., by me, a notary public in and for the said STATE OF ARIZONA, residing therein, duly commissioned and sworn, personally appeared and upon the presentation of sufficient documentation satisfactorily proved to me to be the person BEVERLY JEAN ROMERO-HILL, and who provided to me a document from the STATE OF NEW MEXICO for notarial acknowledgment.

The document is on repetitively stated "NEW MEXICO VITAL RECORDS" throughout, with an other state seal type of inclusion, watermark safety paper, surrounded by a border presumed to be unique to the STATE OF NEW MEXICO bond paper; and, entitled in both english and spanish languages, "CERTIFICATE OF BIRTH, STATE OF NEW MEXICO, New Mexico Vital Records and Health Statistics, Public Health Division". Following, the document contains a certification statement for the birth record information enclosed in the form; then then record is signed in the lower right corner by a "SIGNATURE OF THE STATE REGISTRAR" in mostly legible cursive, Donna Dorsey.

The document content information: "File No. 19581503459", "Request No. 26201435862", "County of Birth RIO ARRIBA", "Date of Birth June 15, 1958", "Name of Person Registered BEVERLY JEAN ROMERO", "Name of Father DELFERIO C ROMERO", "Birth Name of Mother MARY ARGUELLO". Following, at the bottom of the form is a number in red color, "No. 2022943", then next over in the bottom middle is "GREAT SEAL OF THE STATE OF NEW MEXICO" before the registrar's signature of the bottom right of the document.

I acknowledge this document as authentic.

Witness my hand and seal this

28th day of JUNE, 2015.



KALLE KIVINEN
Notary Public - Arizona
Maricopa County
Expires on 08/15/2016

Notary

My Commission Expires 8-15-2016

530



**NOTARIAL ACKNOWLEDGMENT
OF ORIGINAL, AUTHENTIC, BIRTH CERTIFICATE**

Copy

[INTENTIONALLY LEFT BLANK]

Unofficial

531

Rec'd

Darrell James Hill

PA-B-2/13

SECURITY AGREEMENT BJR002-SA 09142015-SA CE
Non-Negotiable – Private Agreement Between two Parties



ENCLOSURE-Two

SECURITY AGREEMENT BJR002-SA 09142015-SA CE

12 of 13

2022-011769 MISC Page: 530 of 2782
09/28/2022 03:35:37 PM Receipt #: 22-9381
Rec Fee: \$30.00 Darrell James Hill
Gila County, Az, Sadie Jo Bingham, Recorder



532

Unofficial Copy

SECURITY AGREEMENT BJR002-SA 09142015-SA CE
Non-Negotiable – Private Agreement Between two Parties

INTENTIONALLY LEFT BLANK

SECURITY AGREEMENT BJR002-SA 09142015-SACE

533
2022-011769 MISC Page: 531 of 2782
09/26/2022 03:35:37 PM Receipt #: 22-9381
Rec Fee: \$30.00 Darrell James Hill
Gila County, Az. Sadie Jo Bingham, Recorder



p 12/13

Beverly
Darrell Hill

**NOTARIAL ACKNOWLEDGMENT
OF ORIGINAL, AUTHENTIC, ARIZONA, Driver License**

Beverly Hill

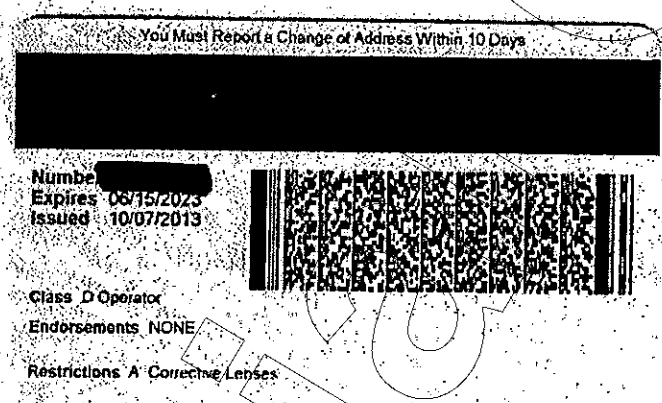
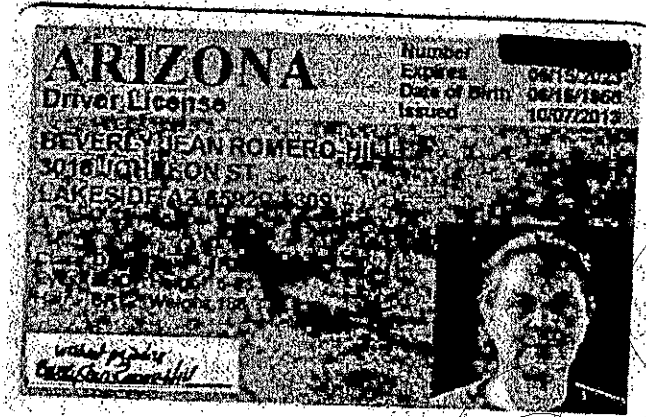

**STATE OF ARIZONA
COUNTY OF MARICOPA**

ON this 28th day of June, 2015 A.D., by me, a notary public in and for the said STATE OF ARIZONA, residing therein, duly commissioned and sworn, personally appeared and upon the presentation of sufficient documentation satisfactorily proved to me to be the person BEVERLY JEAN ROMERO-HILL, and who provided to me a document from the STATE OF ARIZONA for notarial acknowledgment.

The document is set upon a sky-mountain background picture, is entitled "ARIZONA, DRIVER LICENSE" in the upper left corner with repetitively distributed throughout the card a 'state-shaped-picture with the words "CANYON" following. The document is signed in the lower left corner, with a likeness picture of the presumed signer in the lower right corner. The picture in the right lower corner is a reasonable facsimile of Beverly-Jean: Romero- Hill.

The right upper corner document content information is: "Number [REDACTED] Expires 06/15/2023; Date of Birth 06/15/1958; Issued 10/07/2013.

The middle document content information is: "BEVERLY JEAN ROMERO-HILL with a following address location, below which is a description of a person, and below which is a signum in a white box at the left base of the card document.

I acknowledge this document as authentic.

Witness my hand and seal this

28th day of JUNE, 2015.



KALLE KIVINEN
Notary Public - Arizona
Maricopa County
Expires on 08/15/2016

Notary

[Handwritten Signature]

My Commission Expires

8/15/2016

534

**NOTARIAL ACKNOWLEDGMENT
OF ORIGINAL, AUTHENTIC, ARIZONA, Driver License**

[INTENTIONALLY LEFT BLANK]

2022-011769 MISC Page: 533 of 2782
09/26/2022 03:35:37 PM Receipt #: 22-9381
Rec Fee: \$30.00 Darrell James Hill
Gila County, Az, Sadie Jo Bingham, Recorder



p/2-DL-P2/13

Darrell James Hill

535

Unofficial Copy

SECURITY AGREEMENT BJR002-SA 09142015-SA CE
Non-Negotiable – Private Agreement Between two Parties

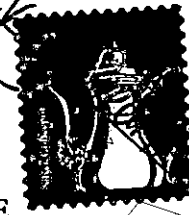

ENCLOSURE-Three

SECURITY AGREEMENT BJR002-SA 09142015-SA CE

13 of 13

2022-011769 MISC Page: 534 of 2782
09/26/2022 03:35:37 PM Receipt #: 22-9381
Rec Fee: \$30.00 Darrell James Hill
Gila County, Az, Sadie Jo Bingham, Recorder



Unofficial Copy

534

SECURITY AGREEMENT BJR002-SA 09142015-SA CE
Non-Negotiable – Private Agreement Between two Parties

INTENTIONALLY LEFT BLANK

SECURITY AGREEMENT BJR002-SA 09142015-SACE

2022-011769 MISC Page: 535 of 2782
09/26/2022 03:35:37 PM Receipt #: 22-9381
Rec Fee: \$30.00 Darrell James Hill
Gila County, Az, Sadie Jo Bingham, Recorder



537

P13
/13

Ben
Darrell Hill

Beverly Hill
2022-01-11

Political Status Election BJR002-PE 09142015-PE CE:

Affirmation In Confirmation of Novation:

BEVERLY JEAN ROMERO, CUSIP Number [REDACTED]

1 In regards to the novation nom-de-guerre en legis commercial "BEVERLY JEAN ROMERO",
 2 CUSIP number [REDACTED] the Principal beneficiary of this novation name of trade in
 3 commerce:
 4 **Presents: Status (legal position): Standing (interest in consideration):**
 5 I: Romero Beverly-Jean: Principal Beneficiary de jure by the novation BEVERLY JEAN
 6 ROMERO beneficiary de fact, do herein report that: truths and facts herein are of my first hand
 7 personal comprehension and review and true to the best of my present belief and ability; to wit:
 8 1) I: undersigned American National Citizen of the sovereign We the People, am: Romero
 9 Beverly-Jean, also known as Beverly-Jean: Romero: natural born child of the man Delferio-
 10 Ciprano of the family Romero; and, then-after, named additionally: Beverly and Jean, at, or soon
 11 after birth. See: Certificate of the Live Birth: ENCLOSURE One. See Arizona Drivers License:
 12 ENCLOSURE Two.
 13 2) I am at the natural birth: citizenry of the New Mexico state territory of the Union of nation
 14 states of the united States of America understanding of the Original Jurisdiction*.

*Notice: Term "Original Jurisdiction" means 1) under the covenant: Almighty God: Torah:-and writings, and: 2) as proposed under The Constitution for the united States of America - 1787 CE, as indicated in the "The united States of America" set for in The Articles of the Confederation -1777-1781 CE, and: 3) constitutional articles in amendment - 1791 CE, and: 4) other original covenants and accords under the Original Jurisdiction, including, but not limited to:
 a) The Declaration of Independence 1776 CE; and:
 b) National Bill of Rights, 1789 CE.

15 3) I am of the the majority age; sui juris.
 16 4) I am of the competent mind, and make this political chose in action; sui juris.
 17 5) I am that of a sentient free Man upon the ground under the Almighty God; to wit: an
 18 understanding Ambassador of the Son and Creator God of all that is, and of His Father, even:
 19 Most High God in Heaven the Divine with whom Nothing and None exists between; to wit:

20 KJV: Book: Genesis-Chapter 1:26 And God said, Let us make man in our image,
 21 after our likeness: and let them have dominion over the fish of the sea, and over
 22 the fowl of the air, and over the cattle, and over all the earth, and over every

538

2022-011769 MISC Page: 536 of 2782
 09/26/2022 03:35:37 PM Receipt #: 22-9381
 Rec Fee: \$30.00 Darrell James Hill
 Gila County, Az, Sadie Jo Bingham, Recorder

Political Status Election BJR002-PE 09142015-PE CE:
Affirmation In Confirmation of Novation:

[Small illegible text]

Unofficial Copy

INTENTIONALLY LEFT BLANK

Bill

Darrell James Hill

539

Political Status Election Affirmation In Confirmation of Novation

2022-011769 MISC Page: 537 of 2782
09/26/2022 03:35:37 PM Receipt #: 22-9381
Rec Fee: \$30.00 Darrell James Hill
Gila County, Az, Sadie Jo Bingham, Recorder

P/11



B.H.
Romero-Hill



Political Status Election: Affirmation In Confirmation of Novation

1 creeping thing that creepeth upon the earth. Gen 1:27 So God created man in his
2 own image, in the image of God created he him; male and female created he them.

3 KJV: Book: Proverbs-Chapter 28:5 Evil men understand not judgment: but they
4 that seek the LORD understand all things. Chapter 9:10 The fear of the LORD is
5 the beginning of wisdom: and the knowledge of the holy is understanding.

6 KJV: Book: Ephesians-Chapter 6:19 And for me, that utterance may be given
7 unto me, that I may open my mouth boldly, to make known the mystery of the
8 gospel, 6:20 For which I am an ambassador in bonds: that therein I may speak
9 boldly, as I ought to speak.

10 6) I am of the American citizenry by the free birth in the New Mexico state in the year anno
11 domini Nineteen hundred fifty eight under Almighty God; thus:

12 7) I am of the public trust beneficiary status: trust titled in the corporate manner,
13 "BEVERLY JEAN ROMERO" formed from the elements of the Romero Beverly-Jean, i.e.,
14 "Beverly-Jean: Romero"*** due to the subsequent events occurring after and under the derivative
15 organization(s) under the Original Jurisdiction.

16 **Notice: The use of a doctrine of *idem sonans* in any form is hereafter
17 forbidden as it is material constructive fraud and deceitful practice in any
18 reference to the man Beverly-Jean: Romero- Hill; to wit: whether oral, written or
19 other, as relates to the Beverly-Jean: Romero- Hill such of a practice by any
20 fiduciary designated of the public trust in the any manner or presumption in the
21 regard or in the direct service of the Beverly-Jean: Romero- Hill is hereafter upon
22 this statement willful fraud and constructive fraud by the actor(s).

PUBLIC NOTICE:

23 THIS DOCUMENT GIVES NOTICE of these: reports, clarifications or other matters contained
24 to the UNITED STATES CORPORATION entity and all of the derivatives thereof: Public and
25 Private, through and by the Office of the Secretary of State(s) or their agent(s): de facto and de
26 jure "united States of America" seat(s) of the government in and upon the territory thereof; and,
27 through and by the Office of the Secretary of State(s) or their agent(s): de facto and de jure
28 "Arizona state" seat(s) of the government in and upon the territory thereof; and to the all of the
29 persons who would know or should have known this Notice content, as relates to the
30 undersigned, by and upon the filing of this public information.
31

NOTICE TO DOMESTIC AND FOREIGN JURISDICTIONS:

2022-011769 MISC Page: 538 of 2782
09/26/2022 03:35:37 PM Receipt #: 22-9381
Rec Fee: \$30.00 Darrell James Hill
Gila County, Az, Sadie Jo Bingham, Recorder

540

Political Status Election BJR002-PE 09142015-PE CE:
Affirmation In Confirmation of Novation:

INTENTIONALLY LEFT BLANK



Bele
Darrell James Hill
P 2/11

541

2022-011769 MISC Page: 539 of 2782	
09/26/2022 03:35:37 PM	Receipt #: 22-9381
Rec Fee: \$30.00 Darrell James Hill	
Gila County, Az, Sadie Jo Bingham, Recorder...	
	

Confirmation of Novation

Beverly-Jean Romero-Hill

Political Status Election: Affirmation In Confirmation of Novation

1 Notice to the principal is notice to all of the agent(s): Notice to the agent is notice to all of the
2 principals of the de facto UNITED STATES AND STATE government(s): actor(s) and
3 derivatives thereto; to wit: Officer(s), Employee(s), Agent(s), Contractor(s), and the like; and,
4 when-upon this notice is once affixed to any home ground(s) of the Beverly-Jean: Romero- Hill's
5 land-site or habitation-site, or site-otherwise, then:

- 6 a) all of the property attached thereto is under the custody and control of the
- 7 above-noted: Beverly-Jean: Romero- Hill;
- 8 b) pursuant to the common-law, then: site is not subject to presumed or wanton
- 9 intrusion or seizure, or the like, except by the willful authorization from the
- 10 Beverly-Jean: Romero- Hill;
- 11 c) pursuant to the common-law: Beverly-Jean: Romero- Hill is lawfully and legally
- 12 immune from statutory criminal or civil jurisdiction(s), arrest(s) or detention(s),
- 13 or the like, under the Original Jurisdiction convention(s); and,
- 14 d) all of the Actors, of both the private and public sector(s), must take all of the
- 15 steps to be taken in every condition to assure and to prevent any of the
- 16 reproach or attack otherwise on the Affiant's God given inalienable
- 17 Right(s); to wit: Constitutionally secured and protected in-alienable
- 18 Right(s), freedom(s), property(s), interest(s), mobility(s) and security(ies)
- 19 and protection(s) thereof;
- 20 e) Legality(ies) of this Notice, or the like: inquiry(ies) in regards to the any actor(s)
- 21 in their constitutional responsibility(ies) should be made to the sheriff in the
- 22 county territory of the any event of the any matter(s) of the actor's concern.

23 **Presents: Character: (motive(s) that control a life): Capacity: (legal or moral qualification**
24 **necessary for certain purposes):**
25 Beverly-Jean: Romero- Hill does hereby state, assert and aver the all of the following:

- 26 1) Beverly-Jean: Romero- Hill is a man understanding of the Almighty God; to wit: an
- 27 Ambassador of the Messiah: Genesis-Chapter-1:26-27; Proverbs-Chapter-28:5; Proverbs-
- 28 Chapter-9:10; Ephesians-Chapter-6:...19-20 – King James Version, "KJV"
- 29 Ephesians-Chapter 6:19 And for me, that utterance may be given unto me, that I may
- 30 open my mouth boldly, to make known the mystery of the gospel, 6:20 For which I
- 31 am an ambassador in bonds: that therein I may speak boldly, as I ought to speak.
- 32 2) Beverly-Jean: Romero- Hill is a biological citizen born in, upon and of the natural
- 33 territory of the "New Mexico state".

542

Political Status Election BJR002-PE 09142015-PE CE:
Affirmation In Confirmation of Novation:

INTENTIONALLY LEFT BLANK

843

Belle
James Hill

P 2/11

2022-011769 MISC Page: 541 of 2782
09/26/2022 03:35:37 PM Receipt #: 22-9381
Rec Fee: \$30.00 Darrell James Hill
Gila County, Az, Sadie Jo Bingham, Recorder



Affirmation In Confirmation of Novation

Bell
Romero-Hill



Political Status Election: Affirmation In Confirmation of Novation

1
2
3
4
5
6
7
8
9
10
11
12
13
14
15
16
17
18
19
20
21
22
23
24
25
26
27
28
29
30
31
32
33
34
35
36
37

- 3) Beverly-Jean: Romero- Hill is a private-individual, private-person, and non-fictitious person or entity; to wit: a man under the Almighty God the Divine between which there is none other.
- 4) Beverly-Jean: Romero- Hill retains all of the absolute jurisdiction of the people: a natural person man understanding: Almighty God.
- 5) Beverly-Jean: Romero- Hill retains all of the absolute protections of the Rights, remedies and defenses granted by the Almighty God by the subsequent limitations created and beset by the people of the states of America for the people and upon the united States of America government(s) upon its inception and creation as established under the covenant(s) of the Original Jurisdiction.
- 6) Beverly-Jean: Romero- Hill is of the real capacity and character above, and as the same has chosen a political status above that of, and foreign to the UNITED STATES government corporate jurisdiction; to wit:
 - Beverly-Jean: Romero- Hill does not volunteer, nor consent or contract to be presumed as acting in/as any *ens legis* entity or capacity, neither to be presumed as an operative of the any other political state or subdivision or surety of the any UNITED STATES corporate interest(s); to wit: Beverly-Jean: Romero- Hill reserves the nature and character of his exact and proper man status and capacity under: Almighty God, and of the same election reserved under the Original Jurisdiction, sui juris, de jure.
 - Beverly-Jean: Romero- Hill waives none of the Rights, Remedies or defenses, nor yields of the same, including, without a limitation, the any of the Rights in the accordance with the protection(s) and principle(s) of the Rights, Remedies and defenses assured by and under pursuant to the Original Jurisdiction; to wit: Rights, such as: right to freedom of movement: private right to travel without restriction in any conveyance on any public roadway in this united nation States of America: right to bear arms for the survival and protection of his family and country.
 - Beverly-Jean: Romero- Hill is Not a "UNITED STATES CITIZEN" as is the novation BEVERLY JEAN ROMERO is/was so designed; to wit, Beverly-Jean: Romero- Hill is Not: subject, vessel, or other presumed entity of the UNITED STATES' as defined in statutes-at-large, such as in the nature of the Title 26 UNITED STATES CODE, "USC", Section 7701, or of the like as elsewhere defined in the statutes-at-large.
 - Beverly-Jean: Romero- Hill is Not in the any form: *ens legis* fiction as is: "person or individual," entity, or other procedural construct or statutory term referring to a legal fiction.
- 7) Beverly-Jean: Romero- Hill Affiant is by the common law: "Trade-name/ Trade-mark of the Common Law"; and it is unto him "Romero Beverly-Jean" who all of the Rights are reserved. Use, with the any reference to the Affiant, without express written permission

544

2022-011769 MISC Page: 542 of 2782
09/26/2022 03:35:37 PM Receipt #: 22-9381
Rec Fee: \$30.00 Darrell James Hill
Gila County, Az, Sadie Jo Bingham, Recorder

Political Status Election BJR002-PE 09142015-PE CE:
Affirmation In Confirmation of Novation:

INTENTIONALLY LEFT BLANK

545

Bevel

Darrell James Hill
P4/11

Affirmation In Confirmation of Novation

2022-011769 MISC Page: 543 of 2782
09/26/2022 03:35:37 PM Receipt #: 22-9381
Rec Fee: \$30.00 Darrell James Hill
Gila County, Az, Sadie Jo Bingham, Recorder

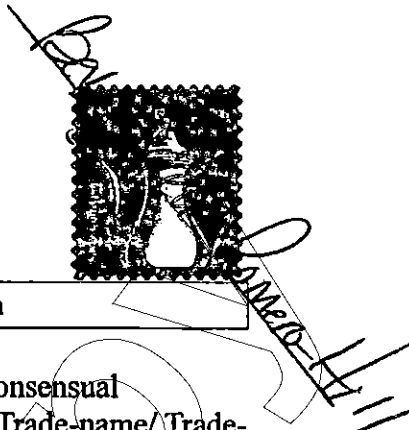



Political Status Election: Affirmation In Confirmation of Novation

1
2
3
4
5
6
7
8
9
10
11
12
13
14
15
16
17
18
19
20
21
22
23
24
25
26
27
28
29
30
31
32
33
34
35
36
37
38

by the Beverly-Jean: Romero- Hill creates a voluntary and informed consensual contractual obligation upon the unauthorized user to the payment of a Trade-name/ Trade-mark infringement fee(s) as follows: Trade-name/Trade-mark infringement fee is in the sum certain of five hundred thousand dollars and no/100: 500,000.00 USD lawful money of account: gold or silver coin, or: certified bullion, or: equivalent money to which the Secured Party may prefer to agree to the receipt.

8) Beverly-Jean: Romero- Hill does comprehend for to identify, paraphrase and assert herein of the following facts of the historical significance bearing upon the Original jurisdiction of the Affiant's status, capacity, character and standing; to wit, that:

a) Due to the faux governmental disparity(ies) arising out of the gross capital control controversies by the clandestine banking factions in the 18th century the constitutional government was usurped by criminals intent upon theft of Almighty God's covenanted people from the first presumed president until to date; to wit, usurpation under a corporate veil or another with one goal to date, to still, kill, destroy and enslave Almighty God's covenanted people.

b) The present defacto corporate government, in the order for to sustain its deception to govern, postures and administrates under the auspices of the Original Jurisdiction, as a corporation titled: UNITED STATES, a federal corporation defined by its own principle(s) as a federal corporation in the nature of Title 28 USC 3002 (15), as: commercial entity implementing a corporate policy called "public policy" and statutory law for reasons beyond the scope of this statement: government under the Original Jurisdiction, under the "united States of America", under pursuant to the Executive Branch.

c) The "UNITED STATES" government corporation, however referred to today, is not synonymous to "The united States of America" government of the original predilection and assemblage. Identically, the "UNITED STATES CONSTITUTION" is not synonymous to "The Constitution for the united States of America"; to wit: UNITED STATES CONSTITUTION is technically the/a corporate by-laws statement of the said corporation, and is similarly by any corporate procedure: corporate policy. Subsequently:

9. Original Jurisdiction, cannot be in conflict with itself; to wit: Almighty God made man in original jurisdiction over the earth and all of the substance, and reserving to Himself jurisdiction over man in total.

10. Natural people *de jure*: people under the God Almighty are above all including of the Original Jurisdiction; to wit: Beverly-Jean: Romero- Hill, et al.: sovereign We People are the authority under-which the construct of the state nations and of the The Constitution for the United States of America are conceived, mandated, and obliged; Therefore: sovereign We People are inherently superior to the present de facto UNITED STATES' corporate fiction by its own admission(s). Accordingly, by the political election: private people *de jure*

546

Political Status Election BJR002-PE 09142015-PE CE:
Affirmation In Confirmation of Novation:

INTENTIONALLY LEFT BLANK



547

Political Status Election: Affirmation In Confirmation of Novation

2022-011769 MISC Page: 545 of 2782
09/26/2022 03:35:37 PM Receipt #: 22-9381
Rec Fee: \$30.00 Darrell James Hill
Gila County, Az, Sadie Jo Bingham, Recorder



P 5/11

Handwritten signature
P 5/11

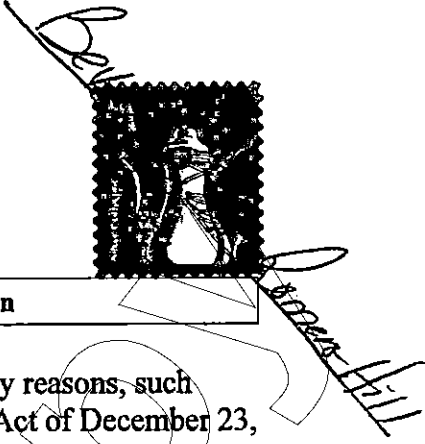

Political Status Election: Affirmation In Confirmation of Novation

1
2
3
4
5
6
7
8
9
10
11
12
13
14
15
16
17
18
19
20
21
22
23
24
25
26
27
28
29
30
31
32
33
34
35
36
37
38

are not subject to the un-constitutional corporate construct(s) for a sundry reasons, such constructs as in the nature of the unconscionable Federal Reserve Bank Act of December 23, 1913 CE.

11. Notwithstanding: Full disclosure of the points and authorities of the progressive development of the UNITED STATES corporate government as it is presently openly discovered are fully comprehensible and comprehended by Beverly-Jean: Romero- Hill. However, the permitted absence of the reestablishment of the de jure Governance of the Original Jurisdiction, and, thereby, of the matter(s) of the subsequent enabling of the fraud(s) upon the people by the founding predecessors and present actors of the UNITED STATES corporate government, includes: a) abetting of the same deception upon the natural people de jure; to wit: Beverly-Jean: Romero- Hill, et al.: b) protection of the extraordinary and persistent UNITED STATES corporate policy of coven, conspiracy, and collusion constructed and condoned by the present day UNITED STATES corporation and actor(s), pursuant from, in the nature of the 20th Amendment to the UNITED STATES Constitution; and: c) subsequent Corporate and complicit agent's acts including, but not limited to: progressive development of the Cestui Que Trust: title: BEVERLY JEAN ROMERO, to the benefit of the natural born Romero Beverly-Jean; to wit: Beverly-Jean: Romero- Hill; and, of the actor(s) systematic usufruct of the same natural people's trusts and the profit: power, prestige and privilege for selfish gain.

POSITION AUTHORITY:

I: Beverly-Jean: Romero- Hill have all of the authority as a natural man under the God Almighty to establish this political election and dispel all of the contrary presumptions by the any actor(s), including, but not limited to the commercial entity(ies) mentioned/ referred to in this document, that: presumption is set. Furthermore: fidelity of the constitutional integrity of every UNITED STATES' agency, and the any of the officer(s)/actor(s) thereof, are under the Constitution for the United States of America under Almighty God. Therefore: any commercial entity(ies) or actor(s) with which Affiant may make acquaintance and/or come into contact shall under the presumption heretofore instantly seek and protect Beverly-Jean: Romero- Hill's every Right(s) and Remedy(ies) and interest(s) within the direct obedience under Almighty God under the Constitutional oath of their office which is under duty to the service and protection: Beverly-Jean: Romero- Hill; to wit:

KJV: Book: Exodus 20:1 And God spake all these words, saying, 20:2 I am the LORD thy God, which have brought thee out of the land of Egypt, out of the house of bondage. 20:3 Thou shalt have no other gods before me. 20:4 Thou shalt not make unto thee any graven image, or any likeness of any thing that is in heaven above, or that is in the earth beneath, or that is in the water under the

548

2022-011769 MISC Page: 546 of 2782
09/26/2022 03:35:37 PM Receipt #: 22-9381
Rec Fee: \$30.00 Darrell James Hill
Gila County, Az, Sadie Jo Bingham, Recorder

Political Status Election BJR002-PE 09142015-PE CE:
Affirmation In Confirmation of Novation:

INTENTIONALLY LEFT BLANK



Base
Darrell James Hill

Political Status Election Affirmation In Confirmation of Novation

54

2022-011769 MISC Page: 547 of 2782
09/26/2022 03:35:37 PM Receipt #: 22-9381
Rec Fee: \$30.00 Darrell James Hill
Gila County, Az, Sadie Jo Bingham, Recorder



P 6/11

Bellevue
James Hill

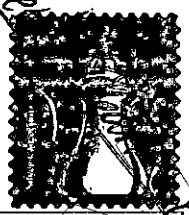

Political Status Election: Affirmation In Confirmation of Novation

1 earth: 20:5 Thou shalt not bow down thyself to them, nor serve them: for I the
2 LORD thy God *am* a jealous God, visiting the iniquity of the fathers upon the
3 children unto the third and fourth *generation* of them that hate me; 20:6 And
4 shewing mercy unto thousands of them that love me, and keep my
5 commandments. 20:7 Thou shalt not take the name of the LORD thy God in
6 vain; for the LORD will not hold him guiltless that taketh his name in vain. 20:8
7 Remember the sabbath day, to keep it holy. 20:9 Six days shalt thou labour, and
8 do all thy work: 20:10 But the seventh day *is* the sabbath of the LORD thy God:
9 *in it* thou shalt not do any work, thou, nor thy son, nor thy daughter, thy
10 manservant, nor thy maidservant, nor thy cattle, nor thy stranger that *is* within thy
11 gates: 20:11 For *in* six days the LORD made heaven and earth, the sea, and all
12 that in them *is*, and rested the seventh day: wherefore the LORD blessed the
13 sabbath day, and hallowed it. 20:12 Honour thy father and thy mother: that thy
14 days may be long upon the land which the LORD thy God giveth thee. 20:13
15 Thou shalt not kill. 20:14 Thou shalt not commit adultery. 20:15 Thou shalt not
16 steal. 20:16 Thou shalt not bear false witness against thy neighbour. 20:17 Thou
17 shalt not covet thy neighbour's house, thou shalt not covet thy neighbour's wife,
18 nor his manservant, nor his maidservant, nor his ox, nor his ass, nor any thing that
19 *is* thy neighbour's[;] to wit:

20 KJV: Book: Proverbs-Chapter 17:15 He that justifieth the wicked, and he that
21 condemneth the just, even they both *are* abomination to the LORD... 17:23 A
22 wicked *man* taketh a gift out of the bosom to pervert the ways of judgment.
23 Chapter 18:5 *It is* not good to accept the person of the wicked, to overthrow the
24 righteous in judgment. Chapter 20:10 Divers weights, *and* divers measures, both
25 of them *are* alike abomination to the LORD. 20:25 *It is* a snare to the man *who*
26 *devoureth that which is* holy, and after vows to make enquiry.

27 "The law will protect an individual who, in the prosecution of a right does
28 everything which the law requires him to do but fails to obtain his right by
29 the misconduct or neglect of a public officer." See in the nature of Lyle v.
30 Arkansas, 9 Howe 314, 13 L. Ed 153; Duluth & Iron Range Co. v. Roy, 173 U.S.
31 587, 19 S. Ct 549, 43 L. Ed 820.

32 "It is a maxim of the law, admitting few if any exceptions, that every duty laid
33 upon a public officer for the benefit of a private person, is enforceable by judicial
34 process". See in the nature of Butterworth v. U.S. ex rel. Hoe, 112 U.S. 50, 5 S.
35 Ct 25, 28 L. Ed 656.

550

2022-011769 MISC Page: 548 of 2782
09/26/2022 03:35:37 PM Receipt #: 22-9381
Rec Fee: \$30.00 Darrell James Hill
Gila County, Az, Sadie Jo Bingham, Recorder



Political Status Election BJR002-PE 09142015-PE CE:
Affirmation In Confirmation of Novation:

INTENTIONALLY LEFT BLANK

PTM
Darrell James Hill



Political Status Election: Affirmation In Confirmation of Novation

2022-011769 MISC Page: 549 of 2782
09/26/2022 03:35:37 PM Receipt #: 22-9381
Rec Fee: \$30.00 Darrell James Hill
Gila County, AZ, Sadie Jo Bingham, Recorder



Beverly Hill



Political Status Election: Affirmation In Confirmation of Novation

1 I: Beverly-Jean: Romero- Hill have all of the authority, and of the duty, to
2 examine from the any where is the authority of the any one claiming to represent the any
3 government at the any level; to wit:

4 KJV: Book: 1 John-Chapter 4:1 Beloved, believe not every spirit, but try the
5 spirits whether they are of God: because many false prophets are gone out into the
6 world. 4:2 Hereby know ye the Spirit of God: Every spirit that confesseth that
7 Jesus Christ is come in the flesh is of God: 4:3 And every spirit that confesseth
8 not that Jesus Christ is come in the flesh is not of God: and this is that *spirit* of
9 antichrist, whereof ye have heard that it should come; and even now already is it
10 in the world.

11 Notification of the legal responsibility is "the first essential
12 of due process of law." See in the nature of Connally v. General
13 Construction Co., 269 U.S. 385, 391.

14 "Silence can only be equated with fraud where there is a
15 legal or moral duty to speak or when an inquiry left
16 unanswered would be intentionally misleading." See in the
17 nature of U.S. v. Tweel, 550 F.2d.297.

18 It is in the ministerial fiduciary/trustee duty of the each and every
19 government official, officer, agent, contractor and assign of the
20 UNITED STATES, and of its derivatives; to wit: STATE OF
21 ARIZONA, ET SEQ., Federal Reserve Banks/System, International
22 Monetary Fund, International Finance Corporation, International
23 Bank for Reconstruction and Development, Inter-American
24 Development Bank, World Bank, Commission of the European
25 Communities, Organization for Economic Co-operation and
26 Development, United Nations, and of the any and all other agent(s)
27 who view of this notice, "Respondent(s)" to timely and fully answer.
28 See in the nature of Federal Crop Insurance v. Merrill, 332 U.S. 380,
29 92 L. Ed 10, 68 S.Ct 1,(1947) 175 ALR 1075.

30 **ORDERS:**

31 1) Presumption is set that: Beverly-Jean: Romero- Hill is a natural man born of the family
32 Roméro and then after named to be: Jean-Jean shall not be presumed or enabled by/in
33 any record held/maintained to be the surety for the stramineus homo "BEVERLY
34 JEAN ROMERO," also known by the any and all of the derivatives and variations in the
35 spelling of the said name except: "Beverly-Jean: Romero- Hill".

2022-011769 MISC Page: 550 of 2782
09/26/2022 03:35:37 PM Receipt #: 22-9381
Rec Fee: \$30.00 Darrell James Hill
Gila County, Az, Sadie Jo Bingham, Recorder

552

Political Status Election BJR002-PE 09142015-PE CE:
Affirmation In Confirmation of Novation:

INTENTIONALLY LEFT BLANK

Belen

Domenzill

2022-011769 MISC Page: 551 of 2782
09/26/2022 03:35:37 PM Receipt #: 22-9381
Rec Fee: \$30.00 Darrell James Hill
Gila County, Az, Sadie Jo Bingham, Recorder

Information In Confirmation of Novation

p8/11



Political Status Election: Affirmation In Confirmation of Novation

- 1 2) Claim of Cestui Que Trust BEVERLY JEAN ROMERO, CUSIP number [REDACTED], is
- 2 set that: command of the beneficial interest: Beverly-Jean: Romero- Hill: the natural man
- 3 as identified above.
- 4 3) Cease and desist all of the use of a doctrine of *idem sonans* by any actor to effect any
- 5 presumption or scheme reproaching Beverly-Jean: Romero- Hill's inherent sovereignty
- 6 We the People Rights, is set. To wit, such actions are prohibited admittedly willful and
- 7 constructive fraud, and constitutes admission of the same in the private administrative
- 8 process, etc. venue enforceable against the entity(ies), et al., by the Beverly-Jean:
- 9 Romero- Hill through tacit procuration.
- 10 4) Notice to the principal is notice to any of the agent(s). Notice to the agent is notice to all
- 11 of the principals.

12 EXECUTED: Affidavit In Confirmation of Political Status Election BJR002-PE 09142015-PE
 13 CE; and by this execution so be it made to be in the deed decreed and enacted on this day A.D.
 14 of the Ninth month, two thousand fifteen CE; So Be It.

Without Prejudice, UCC 1-308
 BEVERLY JEAN ROMERO

Beverly Jean Romero-Hill
~~BEVERLY JEAN ROMERO~~
 Authorized Representative

15

Arizona state

ss.

Maricopa county

16 On the 14th day of the September month in the year 2015 CE: BEVERLY JEAN ROMERO- HILL
 17 appeared before me and proved to me on the basis of satisfactory evidence to be the person who
 18 affirmed and subscribed hereto and acknowledged to me that he executed the same, and accepts the
 19 facts thereof. Subscribed and affirmed before me this day. Witness my hand and seal this

20 14th day of Sept, 2015.



KALLE KIVINEN
 Notary Public - Arizona
 Maricopa County
 Expires on 08/15/2016

21 Notary

SEAL

22 _____ My Commission Expires 8-15-2016

554

2022-011769 MISC Page: 552 of 2782
 09/26/2022 03:35:37 PM Receipt #: 22-9981
 Rec Fee: \$30.00 Darrell James Hill
 Gila County, Az, Sadie Jo Bingham, Recorder

Political Status Election BJR002-PE 09142015-PE CE:
Affirmation In Confirmation of Novation:

INTENTIONALLY LEFT BLANK

Bar

James Hill
P 9/11

Political Status Election: Affirmation In Confirmation of Novation

2022-011769 MISC Page: 553 of 2782
09/26/2022 03:35:37 PM Receipt #: 22-9381
Rec Fee: \$30.00 Darrell James Hill
Gila County, Az, Sadie Jo Bingham, Recorder



Ball
2022-01-17



Political Status Election: Affirmation In Confirmation of Novation

Unofficial Copy

ENCLOSURE One:
· Certificate of Live Birth

2022-011769 MISC Page: 554 of 2782
09/26/2022 03:35:37 PM Receipt #: 22-9381
Rec Fee: \$30.00 Darrell James Hill
Gila County, Az, Sadie Jo Bingham, Recorder



Political Status Election BJR002-PE 09142015-PE CE:
Affirmation In Confirmation of Novation:

INTENTIONALLY LEFT BLANK

Buell

Darrell Hill

Political Status Election: Affirmation In Confirmation of Novation

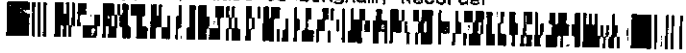
2022-011769 MISC Page: 555 of 2782
09/26/2022 03:35:37 PM Receipt #: 22-9381
Rec Fee: \$30.00 Darrell James Hill
Gila County, Az, Sadie Jo Bingham, Recorder



P10/11

**NOTARIAL ACKNOWLEDGMENT
OF ORIGINAL AUTHENTIC BIRTH CERTIFICATE**



THIS DOCUMENT IS NOT AUTHENTIC UNLESS PRODUCED ON SECURITY PAPER

**CERTIFICATE OF BIRTH
CERTIFICADO DE NACIMIENTO**

STATE OF NEW MEXICO
New Mexico Vital Records and Health Statistics
Public Health Division

**NEW MEXICO
DEPARTMENT OF
HEALTH**

ESTADO DE NUEVO MEXICO
Registros Vitales y Estadísticas de Salud de Nuevo Mexico
Division de Salud Publica

I certify that the following birth is registered in the New Mexico Vital Records and Health Statistics
Certifico que en la Sección del Registro de Nacimientos a mi cargo aparece la siguiente inscripción

File No. / Número de Archivo	Request No. / Número de Solicitud	County of Birth / Condado de Nacimiento
[REDACTED]	[REDACTED]	RIO ARRIBA
Date of Birth / Fecha de Nacimiento	Date of Registration / Fecha de Inscripción	Sex / Sexo
JUNE 15, 1958	JUNE 15, 1958	FEMALE
Name of Person Registered / Nombre del Registrado		
>>> BEVERLY JEAN ROMERO <<<		
Name of Father or Parent / Nombre del Padre		
>>> DELFERIO C ROMERO <<<		
Birth Name of Mother or Parent / Nombre de Soltera de la Madre		
>>> MARY ARGUELLO <<<		
No. [REDACTED]		

WARNING: IT IS ILLEGAL TO COPY OR
COUNTERFEIT THIS CERTIFICATE
ADVERTENCIA: ES ILLEGAL ALTERAR, COPIAR O
FALSIFICAR ESTE CERTIFICADO

Donna Dorsey
SIGNATURE OF STATE REGISTRAR
FIRMA DEL REGISTADOR DEL ESTADO
APRIL 24, 2007

DO NOT DUPLICATE BY ANY MEANS

WARNING: IT IS ILLEGAL TO ALTER, COPY OR COUNTERFEIT THIS CERTIFICATE. ADVERTENCIA: ES ILLEGAL ALTERAR, COPIAR O FALSIFICAR ESTE CERTIFICADO.

**STATE OF ARIZONA
COUNTY OF MARICOPA**

ON this 28th day of June, 2015 A.D., by me, a notary public in and for the said STATE OF ARIZONA, residing therein, duly commissioned and sworn, personally appeared and upon the presentation of sufficient documentation satisfactorily proved to me to be the person BEVERLY JEAN ROMERO-HILL, and who provided to me a document from the STATE OF NEW MEXICO for notarial acknowledgment.

The document is on repetitively stated "NEW MEXICO VITAL RECORDS" throughout, with an other state seal type of inclusion, watermark safety paper, surrounded by a border presumed to be unique to the STATE OF NEW MEXICO bond paper, and, entitled in both english and spanish languages, "CERTIFICATE OF BIRTH, STATE OF NEW MEXICO, New Mexico Vital Records and Health Statistics, Public Health Division". Following, the document contains a certification statement for the birth record information enclosed in the form; then then record is signed in the lower right corner by a "SIGNATURE OF THE STATE REGISTRAR" in mostly legible cursive, Donna Dorsey.

The document content information: "File No. [REDACTED]", "Request No. [REDACTED]", "County of Birth RIO ARRIBA", "Date of Birth June 15, 1958", "Name of Person Registered BEVERLY JEAN ROMERO", "Name of Father DELFERIO C ROMERO", "Birth Name of Mother MARY ARGUELLO". Following, at the bottom of the form is a number in red color, "No. 2022943", then next over in the bottom middle is "GREAT SEAL OF THE STATE OF NEW MEXICO" before the registrar's signature of the bottom right of the document.

I acknowledged this document as authentic.

Witness my hand and seal this

28th day of JUNE, 2015.



KALLE KIVINEN
Notary Public - Arizona
Maricopa County
Expires on 08/15/2016

Notary

My Commission Expires 8-15-2016

558



NOTARIAL ACKNOWLEDGMENT
OF ORIGINAL, AUTHENTIC, BIRTH CERTIFICATE

Official Copy

[INTENTIONALLY LEFT BLANK]

Official Copy

559



Bel
Rosen Hill

P10-BCP 2/11



Bar
James Hill

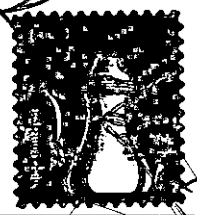

Political Status Election: Affirmation In Confirmation of Novation

Unofficial Copy

**ENCLOSURE Two:
. Arizona Drivers License**

560

Political Status Election: Affirmation In Confirmation of Novation 11 of 11

2022-011769 MISC Page: 558 of 2782
09/26/2022 03:35:37 PM Receipt #: 22-9381
Rec Fee: \$30.00 Darrell James Hill
Gila County, Az, Sadie Jo Bingham, Recorder



Political Status Election BJR002-PE 09142015-PE CE:
Affirmation In Confirmation of Novation:

INTENTIONALLY LEFT BLANK

561

Bevelly



Darrell James Hill

Political Status Election Affirmation In Confirmation of Novation

2022-011769 MISC Page: 559 of 2782
09/26/2022 03:35:37 PM Receipt #: 22-9381
Rec Fee: \$30.00 Darrell James Hill
Gila County, Az, Sadie Jo Bingham, Recorder



P 11/11

**NOTARIAL ACKNOWLEDGMENT
OF ORIGINAL, AUTHENTIC, ARIZONA, Driver License**

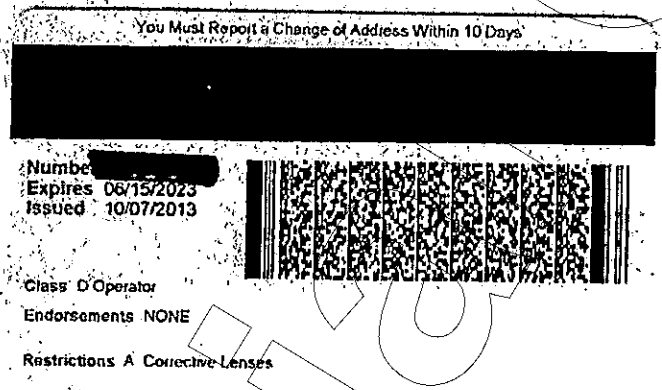

**STATE OF ARIZONA
COUNTY OF MARICOPA**

ON this 28th day of June, 2015 A.D., by me, a notary public in and for the said STATE OF ARIZONA, residing therein, duly commissioned and sworn, personally appeared and upon the presentation of sufficient documentation satisfactorily proved to me to be the person BEVERLY JEAN ROMERO-HILL, and who provided to me a document from the STATE OF ARIZONA for notarial acknowledgment.

The document is set upon a sky-mountain background picture, is entitled "ARIZONA, DRIVER LICENSE" in the upper left corner with repetitively distributed throughout the card a 'state-shaped-picture with the words "CANYON"' following. The document is signed in the lower left corner, with a likeness picture of the presumed signer in the lower right corner. The picture in the right lower corner is a reasonable facsimile of Beverly-Jean: Romero- Hill.

The right upper corner document content information is: "Num [redacted]; Expires 06/15/2023; Date of Birth 06/15/1958; Issued 10/07/2013.

The middle document content information is: "BEVERLY JEAN ROMERO-HILL with a following address location, below which is a description of a person, and below which is a signum in a white box at the left base of the card document.

I acknowledge this document as authentic.

Witness my hand and seal this
28th day of JUNE, 2015.



KALLE KIVINEN
Notary Public - Arizona
Maricopa County
Expires on 08/15/2016

Notary

My Commission Expires 8-15-2016

562

**NOTARIAL ACKNOWLEDGMENT
OF ORIGINAL, AUTHENTIC, ARIZONA, Driver License**

[INTENTIONALLY LEFT BLANK]

563



PA-DL-2/11





*Commonwealth of Puerto Rico
Department of State
San Juan, Puerto Rico*

Darrell James: Hill
PO Box 3806
Apache Junction, AZ 85120

Darrell James: Hill:

Reference is made, to the UCC Financing Statement received on January 22, 2016 in the Commercial Transaction Registry of the Department of State of Puerto Rico. We are returning the Financing Statement because in accordance to the Puerto Rico UCC statute, the security agreement has to be authenticated by the signatures of the debtor and the secured party.

Enclosed receipt No. 0825428 original (white) and copy (yellow).

To receive the refund of your money you have to contact the Finance Division of the Department of State at 787-722-2121 x. 4229, 4292 and/or write a letter to:

Finance Division
Department of State
Government of Puerto Rico
PO Box 9023271
San Juan, PR 00932-3271

Cordially,

564
Francisco J. Rodríguez Bernier
Assistant Secretary of State for Services
Commercial Transactions Registry

2022-011769 MISC Page: 562 of 2782
09/26/2022 03:35:37 PM Receipt #: 22-9381
Rec Fee: \$30.00 Darrell James Hill
Gila County, Az, Sadie Jo Bingham, Recorder



Modelo SC 1036(SAIR)
18 Mar 96

Estado Libre Asociado de Puerto Rico
DEPARTAMENTO DE ESTADO
Recibo Oficial

Fecha de Recibo: 20-Jan-2016
Cifra de Depositante: 1412
Número de Recaudador: IRC IRAIDA RODRIGUEZ CRUZ

Recibo Número: 2016001313
Año Económico: 2000
Sector Económico: 01

Información de Recibo

Recibi De	Concepto	Importe	Valor Recibido
DARRELL JAMES HILL	UCC	\$5.00	22715966294
DARRELL JAMES HILL	UCC	\$20.00	22715966294
Total de Recibo:		\$25.00	

DEPARTAMENTO DE ESTADO
JAN 21 2016
OFICINA DE
CORRESPONDENCIA

Oficial Recaudador

0825428

565





*Commonwealth of Puerto Rico
Department of State
San Juan, Puerto Rico*

Beverly Jean: Romero Hill
PO Box 3806
Apache Junction, AZ 85120

Beverly Jean: Romero Hill:

Reference is made, to the UCC Financing Statement received on January 22, 2016 in the Commercial Transaction Registry of the Department of State of Puerto Rico. We are returning the Financing Statement because in accordance to the Puerto Rico UCC statute, the security agreement has to be authenticated by the signatures of the debtor and the secured party.

Enclosed receipt No. 0825429 original (white) and copy (yellow).

To receive the refund of your money you have to contact the Finance Division of the Department of State at 787-722-2121 x. 4229, 4292 and/or write a letter to:

Finance Division
Department of State
Government of Puerto Rico
PO Box 9023271
San Juan, PR 00932-3271

Cordially,

Francisco J. Rodríguez Bernier
Assistant Secretary of State for Services
Commercial Transactions Registry

2022-011769 MISC Page: 564 of 2782
09/26/2022 03:35:37 PM Receipt #: 22-9381
Rec Fee: \$30.00 Darrell James Hill
Gila County, Az, Sadie Jo Bingham, Recorder

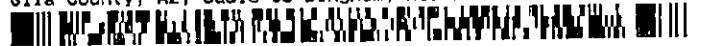

Estado Libre Asociado de Puerto Rico

Modelo 3C 1036(SAIR)
18 Mar 96

DEPARTAMENTO DE ESTADO
Recibo Oficial

Fecha de Recibo: 20-Jan-2016
Cifra de Depositante: 1412
Número de Recaudador: IRC IRAIDA RODRIGUEZ CRUZ

Recibo Número: 2018001314
Año Económico: 2000
Sector Económico: 01

Información de Recibo

Recibí De	Concepto	Importe	Valor Recibido
BEVERLY JEAN ROMEROS H UCC		\$5.00	22715966305
BEVERLY JEAN ROMEROS H UCC		\$20.00	22715966305
Total de Recibo:		\$25.00	

Oficial Recaudador

0825429

Unofficial

567

2022-011769 MISC Page: 565 of 2782

09/26/2022 03:35:37 PM Receipt #: 22-9381
Rec Fee: \$30.00 Darrell James Hill
Gila County, Az, Sadie Jo Bingham, Recorder



Modelo SC 1036 (SAIR)
18 Mar 96

Estado Libre Asociado de Puerto Rico
DEPARTAMENTO DE ESTADO
Recibo Oficial

Fecha de Recibo: 20-Jan-2016 Recibo Número: 2016001314
Cifra de Depositante: 1412 Año Económico: 2000
Número de Recaudador: IRC IRAIDA RODRIGUEZ CRUZ Sector Económico: 01

Información de Recibo

Recibí De	Concepto	Importe	Valor Recibido
BEVERLY JEAN ROMEROS H UCC		\$5.00	22715966305
BEVERLY JEAN ROMEROS H UCC		\$20.00	22715966305
Total de Recibo:		\$25.00	

Oficial Recaudador

0825429

Unofficial

568

2022-011769 MISC Page: 566 of 2782
09/25/2022 03:35:37 PM Receipt #: 22-9381
Rec Fee: \$30.00 Darrell James Hill
Gila County, Az, Sadie Jo Bingham, Recorder

INVOICE: CMN 7015 0640 0001 5883 2600

Darrell- James: Hill
Claimant Case No: CMN 7009 1410 0000 7868 5703
5124 East 18th Avenue
Apache Junction, Arizona [85119]

Brian: Clerk of Court; et al.
USDC District of Arizona – Phoenix
Sandra Day O'Connor U.S. Courthouse, Suite 130
401 West Washington Street, SPC 1
Phoenix Arizona [85003-2118]
602-322-7200

Re: Compensation for Trespass on Claimant Case No: CMN 7009 1410 0000 7868 5703

Brian, et al, Greetings;

i: man, attach hereto for you: bill for 88,260 - U.S. silver dollar, one oz. pieces, for trespass upon my Claimant Case No: CMN 7009 1410 0000 7868 5703; representing billing period from 01/04/2017 - 1030a to 03/06/2017 - 1730p.

Payments must be made upon this receipt.

If you have any questions concerning this bill, you have thirty days to make your questions or objections known.

Thank you;

Darrell - James: Hill

March 07, 2017

USPS CMN 7015 0640 0001 5883 2600

1/5

569

2022-011769 MISC Page: 567 of 2782
09/26/2022 03:35:37 PM Receipt #: 22-9381
Rec Fee: \$30.00 Darrell James Hill
Gila County, Az, Sadie Jo Bingham, Recorder



INVOICE: CMN 7015 0640 0001 5883 2617

Darrell- James: Hill Claimant Case No: CMN 7009 1410 0000 7868 5703 Contact: 602.618.4595	5124 East 18 th Avenue Apache Junction, Arizona
--	---

INVOICE

Invoice Number:	CMN 7015 0640 0001 5883 2617	Ranier: Chief Judge, United States District Court; District of Arizona Evo A. DeConcini U.S. Courthouse 405 West Congress Street, Suite 5190 Tucson, Arizona [85701] 520-205-4540
Invoice Date:	03/07/2017,	
Due Date:	04/06/2017,	
Balance Due:	83,893 - U.S. silver dollar, 1 oz. pieces.	
Billing Period:	01/06/2017 – 03/06/2017	

Item	Description	Unit Cost	Quantity	Line Total
1	TRESPASS UPON CASE 01/06/2017,, 1117p - 01/07/2017,, 1730p	1 U.S. silver dollar, 1oz. piece/ minute	373 minutes	373 pieces
2	TRESPASS UPON CASE 01/07/2017, 1730p - 01/08/2017, 1730p	1 U.S. silver dollar, 1oz. piece/ minute	1,440 minutes	1,440 pieces
3	TRESPASS UPON CASE 01/08/2017, 1730p - 01/09/2017, 1730p	1 U.S. silver dollar, 1oz. piece/ minute	1,440 minutes	1,440 pieces
4	TRESPASS UPON CASE 01/09/2017, 1730p - 01/10/2017, 1730p	1 U.S. silver dollar, 1oz. piece/ minute	1,440 minutes	1,440 pieces
5	TRESPASS UPON CASE 01/10/2017, 1730p - 01/11/2017, 1730p	1 U.S. silver dollar, 1oz. piece/ minute	1,440 minutes	1,440 pieces
6	TRESPASS UPON CASE 01/11/2017, 1730p - 01/12/2017, 1730p	1 U.S. silver dollar, 1oz. piece/ minute	1,440 minutes	1,440 pieces
7	TRESPASS UPON CASE 01/12/2017, 1730p - 01/13/2017, 1730p	1 U.S. silver dollar, 1oz. piece/ minute	1,440 minutes	1,440 pieces
8	TRESPASS UPON CASE 01/13/2017, 1730p - 01/14/2017, 1730p	1 U.S. silver dollar, 1oz. piece/ minute	1,440 minutes	1,440 pieces
9	TRESPASS UPON CASE 01/14/2017, 1730p - 01/15/2017, 1730p	1 U.S. silver dollar, 1oz. piece/ minute	1,440 minutes	1,440 pieces
10	TRESPASS UPON CASE 01/15/2017, 1730p - 01/16/2017, 1730p	1 U.S. silver dollar, 1oz. piece/ minute	1,440 minutes	1,440 pieces
11	TRESPASS UPON CASE 01/16/2017, 1730p - 01/17/2017, 1730p	1 U.S. silver dollar, 1oz. piece/ minute	1,440 minutes	1,440 pieces
12	TRESPASS UPON CASE 01/17/2017, 1730p - 01/18/2017, 1730p	1 U.S. silver dollar, 1oz. piece/ minute	1,440 minutes	1,440 pieces
13	TRESPASS UPON CASE 01/18/2017, 1730p - 01/19/2017, 1730p	1 U.S. silver dollar, 1oz. piece/ minute	1,440 minutes	1,440 pieces

USPS CMN 7015 0640 0001 5883 2617

2/5

570

2022-011769 MISC Page: 568 of 2782
09/26/2022 03:35:37 PM Receipt #: 22-9381
Rec Fee: \$30.00 Darrell James Hill
Gila County, Az, Sadie Jo Bingham, Recorder



INVOICE: CMN 7015 0640 0001 5883 2617

14	TRESPASS UPON CASE	01/19/2017, 1730p - 01/20/2017, 1730p	1 U.S. silver dollar, 1oz. piece/ minute	1,440 minutes	1,440 pieces
15	TRESPASS UPON CASE	01/20/2017, 1730p - 01/21/2017, 1730p	1 U.S. silver dollar, 1oz. piece/ minute	1,440 minutes	1,440 pieces
16	TRESPASS UPON CASE	01/21/2017, 1730p - 01/22/2017, 1730p	1 U.S. silver dollar, 1oz. piece/ minute	1,440 minutes	1,440 pieces
17	TRESPASS UPON CASE	01/22/2017, 1730p - 01/23/2017, 1730p	1 U.S. silver dollar, 1oz. piece/ minute	1,440 minutes	1,440 pieces
18	TRESPASS UPON CASE	01/23/2017, 1730p - 01/24/2017, 1730p	1 U.S. silver dollar, 1oz. piece/ minute	1,440 minutes	1,440 pieces
19	TRESPASS UPON CASE	01/24/2017, 1730p - 01/25/2017, 1730p	1 U.S. silver dollar, 1oz. piece/ minute	1,440 minutes	1,440 pieces
20	TRESPASS UPON CASE	01/25/2017, 1730p - 01/26/2017, 1730p	1 U.S. silver dollar, 1oz. piece/ minute	1,440 minutes	1,440 pieces
21	TRESPASS UPON CASE	01/26/2017, 1730p - 01/27/2017, 1730p	1 U.S. silver dollar, 1oz. piece/ minute	1,440 minutes	1,440 pieces
22	TRESPASS UPON CASE	01/27/2017, 1730p - 01/28/2017, 1730p	1 U.S. silver dollar, 1oz. piece/ minute	1,440 minutes	1,440 pieces
23	TRESPASS UPON CASE	01/28/2017, 1730p - 01/29/2017, 1730p	1 U.S. silver dollar, 1oz. piece/ minute	1,440 minutes	1,440 pieces
24	TRESPASS UPON CASE	01/29/2017, 1730p - 01/30/2017, 1730p	1 U.S. silver dollar, 1oz. piece/ minute	1,440 minutes	1,440 pieces
25	TRESPASS UPON CASE	01/30/2017, 1730p - 01/31/2017, 1730p	1 U.S. silver dollar, 1oz. piece/ minute	1,440 minutes	1,440 pieces
26	TRESPASS UPON CASE	01/31/2017, 1730p - 02/01/2017, 1730p	1 U.S. silver dollar, 1oz. piece/ minute	1,440 minutes	1,440 pieces
27	TRESPASS UPON CASE	02/01/2017, 1730p - 02/02/2017, 1730p	1 U.S. silver dollar, 1oz. piece/ minute	1,440 minutes	1,440 pieces
28	TRESPASS UPON CASE	02/02/2017, 1730p - 02/03/2017, 1730p	1 U.S. silver dollar, 1oz. piece/ minute	1,440 minutes	1,440 pieces
29	TRESPASS UPON CASE	02/03/2017, 1730p - 02/04/2017, 1730p	1 U.S. silver dollar, 1oz. piece/ minute	1,440 minutes	1,440 pieces
30	TRESPASS UPON CASE	02/04/2017, 1730p - 02/05/2017, 1730p	1 U.S. silver dollar, 1oz. piece/ minute	1,440 minutes	1,440 pieces
31	TRESPASS UPON CASE	02/05/2017, 1730p - 02/06/2017, 1730p	1 U.S. silver dollar, 1oz. piece/ minute	1,440 minutes	1,440 pieces
32	TRESPASS UPON CASE	02/06/2017, 1730p - 02/07/2017, 1730p	1 U.S. silver dollar, 1oz. piece/ minute	1,440 minutes	1,440 pieces

USPS CMN 7015 0640 0001 5883 2617

3/5

2022-011769 MISC Page: 569 of 2782
 09/26/2022 03:35:37 PM Receipt #: 22-9381
 Rec Fee: \$30.00 Darrell James Hill
 Gila County, Az, Sadie Jo Bingham, Recorder



571

INVOICE: CMN 7015 0640 0001 5883 2617

33	TRESPASS UPON CASE	02/07/2017, 1730p - 02/08/2017, 1730p	1 U.S. silver dollar, 1oz. piece/ minute	1,440 minutes	1,440 pieces
34	TRESPASS UPON CASE	02/08/2017, 1730p - 02/09/2017, 1730p	1 U.S. silver dollar, 1oz. piece/ minute	1,440 minutes	1,440 pieces
35	TRESPASS UPON CASE	02/09/2017, 1730p - 02/10/2017, 1730p	1 U.S. silver dollar, 1oz. piece/ minute	1,440 minutes	1,440 pieces
36	TRESPASS UPON CASE	02/10/2017, 1730p - 02/11/2017, 1730p	1 U.S. silver dollar, 1oz. piece/ minute	1,440 minutes	1,440 pieces
37	TRESPASS UPON CASE	02/11/2017, 1730p - 02/12/2017, 1730p	1 U.S. silver dollar, 1oz. piece/ minute	1,440 minutes	1,440 pieces
38	TRESPASS UPON CASE	02/12/2017, 1730p - 02/13/2017, 1730p	1 U.S. silver dollar, 1oz. piece/ minute	1,440 minutes	1,440 pieces
39	TRESPASS UPON CASE	02/13/2017, 1730p - 02/14/2017, 1730p	1 U.S. silver dollar, 1oz. piece/ minute	1,440 minutes	1,440 pieces
40	TRESPASS UPON CASE	02/14/2017, 1730p - 02/15/2017, 1730p	1 U.S. silver dollar, 1oz. piece/ minute	1,440 minutes	1,440 pieces
41	TRESPASS UPON CASE	02/15/2017, 1730p - 02/16/2017, 1730p	1 U.S. silver dollar, 1oz. piece/ minute	1,440 minutes	1,440 pieces
42	TRESPASS UPON CASE	02/16/2017, 1730p - 02/17/2017, 1730p	1 U.S. silver dollar, 1oz. piece/ minute	1,440 minutes	1,440 pieces
43	TRESPASS UPON CASE	02/17/2017, 1730p - 02/18/2017, 1730p	1 U.S. silver dollar, 1oz. piece/ minute	1,440 minutes	1,440 pieces
44	TRESPASS UPON CASE	02/18/2017, 1730p - 02/19/2017, 1730p	1 U.S. silver dollar, 1oz. piece/ minute	1,440 minutes	1,440 pieces
45	TRESPASS UPON CASE	02/19/2017, 1730p - 02/20/2017, 1730p	1 U.S. silver dollar, 1oz. piece/ minute	1,440 minutes	1,440 pieces
46	TRESPASS UPON CASE	02/20/2017, 1730p - 02/21/2017, 1730p	1 U.S. silver dollar, 1oz. piece/ minute	1,440 minutes	1,440 pieces
47	TRESPASS UPON CASE	02/21/2017, 1730p - 02/22/2017, 1730p	1 U.S. silver dollar, 1oz. piece/ minute	1,440 minutes	1,440 pieces
48	TRESPASS UPON CASE	02/22/2017, 1730p - 02/23/2017, 1730p	1 U.S. silver dollar, 1oz. piece/ minute	1,440 minutes	1,440 pieces
49	TRESPASS UPON CASE	02/23/2017, 1730p - 02/24/2017, 1730p	1 U.S. silver dollar, 1oz. piece/ minute	1,440 minutes	1,440 pieces
50	TRESPASS UPON CASE	02/24/2017, 1730p - 02/25/2017, 1730p	1 U.S. silver dollar, 1oz. piece/ minute	1,440 minutes	1,440 pieces
51	TRESPASS UPON CASE	02/25/2017, 1730p - 02/26/2017, 1730p	1 U.S. silver dollar, 1oz. piece/ minute	1,440 minutes	1,440 pieces

572

USPS CMN 7015 0640 0001 5883 2617

4/5

2022-011769 MISC Page: 570 of 2782

09/26/2022 03:35:37 PM Receipt #: 22-9381
 Rec Fee: \$30.00 Darrell James Hill
 Gila County, Az. Sadie Jo Bingham, Recorder



INVOICE: CMN 7015 0640 0001 5883 2600

53	TRESPASS UPON CASE	02/24/2017, 1730p - 02/25/2017, 1730p	1 U.S. silver dollar, 1oz. piece/ minute	1,440 minutes	1,440 pieces
55	TRESPASS UPON CASE	02/26/2017, 1730p - 02/27/2017, 1730p	1 U.S. silver dollar, 1oz. piece/ minute	1,440 minutes	1,440 pieces
57	TRESPASS UPON CASE	02/28/2017, 1730p - 03/01/2017, 1730p	1 U.S. silver dollar, 1oz. piece/ minute	1,440 minutes	1,440 pieces
59	TRESPASS UPON CASE	03/02/2017, 1730p - 03/03/2017, 1730p	1 U.S. silver dollar, 1oz. piece/ minute	1,440 minutes	1,440 pieces
61	TRESPASS UPON CASE	03/04/2017, 1730p - 03/05/2017, 1730p	1 U.S. silver dollar, 1oz. piece/ minute	1,440 minutes	1,440 pieces

If you have any questions concerning this bill, you have thirty days to make your questions or objections known.	Subtotal:	88,260 pieces
	Paid to Date:	0
Terms: Due Upon Receipt	Balance Due:	88,260 pieces: (U.S. silver dollar, 1oz.)

Darrell-James Hill
03/07/17

USPS CMN 7015 0640 0001 5883 2600

5/5

2022-011769 MISC Page: 571 of 2782
09/26/2022 03:35:37 PM Receipt #: 22-9381
Rec Fee: \$30.00 Darrell James Hill
Gila County, Az, Sadie Jo Bingham, Recorder



573

U.S. Postal Service
CERTIFIED MAIL® RECEIPT
 Domestic Mail Only

For delivery information, visit our website at www.usps.com

OFFICIAL USE

Certified Mail Fee **\$3.35**
 Extra Services & Fees (check box, add fee amount)
 Return Receipt (hardcopy) \$ **0.00**
 Certified Mail Restricted Delivery \$ **0.00**
 Adult Signature Required \$ **0.00**
 Adult Signature Restricted Delivery \$ **0.00**

0130
01

Postmark
Here

Postage **\$0.70**

03/07/2017

Total Postage and Fees **\$0.80**

Sent To Brian, Clerk of Court
 Street and Apt. No. USDC District of Arizona - Phoenix
 401 West Washington Street, SPC 1
 City, State, ZIP+4 Phoenix Arizona [85003-2118]

PS Form 3800, April 2015 Edition See Reverse for Instructions

0092 8995 1000 7015 0640 0001 574

APACHE JUNCTION
 151 W SUPERSTITION BLVD
 APACHE JUNCTION
 AZ

85120-9998

0302590130

03/07/2017 (800)275-8777 10:01 AM

Product Description	Qty	Final Price
---------------------	-----	-------------

First-Class Mail Letter	1	\$0.70
-------------------------	---	--------

(Domestic)
 (TUCSON, AZ 85701)
 (Weight: 0 Lb 1.30 Oz)
 (Expected Delivery Day)
 (Thursday 03/09/2017)

Certified Mail	1	\$3.35
----------------	---	--------

(USPS Certified Mail #)
 (70150640000158832617)

Return Receipt	1	\$2.75
----------------	---	--------

(USPS Return Receipt #)
 (9590940220736132037486)

First-Class Mail Letter	1	\$0.70
-------------------------	---	--------

(Domestic)
 (PHOENIX, AZ 85003)
 (Weight: 0 Lb 1.30 Oz)
 (Expected Delivery Day)
 (Thursday 03/09/2017)

Certified Mail	1	\$3.35
----------------	---	--------

(USPS Certified Mail #)
 (70150640000158832600)

Return Receipt	1	\$2.75
----------------	---	--------

(USPS Return Receipt #)
 (9590940220736132037479)

Total		\$13.60
-------	--	---------

Cash	\$15.00
Change	(\$1.40)

Text your tracking number to 28777 (2USPS) to get the latest status. Standard Message and Data rates may apply. You may also visit USPS.com USPS Tracking or call 1-800-222-1811.

In a hurry? Self-service kiosks offer quick and easy check-out. Any Retail

UNOFFICIAL

574



Sealed Other Orders/Judgments

2:07-cv-01292-SRB Doe v. Arizona Hospital and Healthcare Association, et al **CASE CLOSED on 08/14/2012**

CLOSED,PROTO,STAY-CASE,STD

SEALED

2022-011769 MISC Page: 573 of 2782
09/26/2022 03:35:37 PM Receipt #: 22-9381
Rec Fee: \$30.00 Darrell James Hill
Gila County, Az, Sadie Jo Bingham, Recorder



U.S. District Court

DISTRICT OF ARIZONA

Notice of Electronic Filing

The following transaction was entered on 7/26/2013 at 3:49 PM MST and filed on 7/26/2013

Case Name: Doe v. Arizona Hospital and Healthcare Association, et al

Case Number: 2:07-cv-01292-SRB

Filer:

WARNING: CASE CLOSED on 08/14/2012

Document Number: 762

Docket Text:

SEALED ORDER. Signed by Judge Susan R Bolton on 7/26/13. (LAD) (cc: Darrell James: Hill by registered mail)

2:07-cv-01292-SRB Notice has been electronically mailed to:

David B Rosenbaum drosenbaum@omlaw.com, kdourlein@omlaw.com

Lawrence Allen Katz lkatz@steptoe.com, jbell@steptoe.com, phdctnef@steptoe.com

Charles Steven Price CPrice@dickinsonwright.com

P Bruce Converse bconverse@steptoe.com, dlinn@steptoe.com, phdctnef@steptoe.com

Andrew L Pringle lpringle@dickinsonwright.com, courtdocs@dickinsonwright.com, cthorne@dickinsonwright.com

James R Broening jrb@bowwlaw.com, bzb@bowwlaw.com

575

Mark D Samson msamson@kellerrohrback.com, kkendrick@kellerrohrback.com,
ktrumpower@kellerrohrback.com

James A Craft jcraft@gblaw.com, bstclair@gblaw.com

Barry D Halpern bhalpern@swlaw.com, ctassielli@swlaw.com

Ron Kilgard rkilgard@krplc.com, dheller@krplc.com, ktrumpower@krplc.com

Randall S Yavitz randy@hhylaw.com, stacey@hhylaw.com

Leigh Eric Dowell eric.dowell@ogletreedeakins.com,
glenda.ready@ogletreedeakins.com, trish.simon@ogletreedeakins.com

Joel W Nomkin JNomkin@perkinscoie.com, KButterworth@perkinscoie.com,
LSandoval@perkinscoie.com

Keith Beauchamp kbeauchamp@csblaw.com, daustin@csblaw.com

Richard Kenneth Delo rdelo@jsslw.com, varagon@jsslw.com

Randall Papetti rpapetti@lrlaw.com, changer@lrlaw.com

Jeffrey J Campbell jcampbell@cycn-phx.com, cbenear@cycn-phx.com, usdc@cycn-phx.com

Franklin James Hoover fhoover@mwsww.com, canderson@mwsww.com,
mechard@mwsww.com

Jessica Lee Everett-Garcia JEverettGarcia@perkinscoie.com,
docketphx@perkinscoie.com, rweidner@perkinscoie.com

Dan W Goldfine dgoldfine@swlaw.com, docket@swlaw.com, mzachow@swlaw.com

Amy N L Hanson ahanson@kellerrohrback.com, esiegel@kellerrohrback.com

Lauren Jacqueline Weinzweig lweinzweig@csblaw.com, daustin@csblaw.com

Jeffrey A LeVee jlevee@jonesday.com, mospelage-alvarez@jonesday.com

Robert Thomas Aquinas Sullivan rts@bowwlaw.com, dam@bowwlaw.com

Michael T Liburdi mliburdi@swlaw.com, ctassielli@swlaw.com, docket@swlaw.com,

<https://ecf.azd.circ9.dcn/coi-bin/Dispatch.nl?110886856938911>

7/26/2013

2022-011769 MISC Page: 574 of 2782
09/26/2022 03:35:37 PM Receipt #: 22-9381
Rec Fee: \$30.00 Darrell James Hill
Gila County, AZ, Sadie Jo Bingham, Recorder



INVOICE: CMN 7015 0640 0001 5883 2617

Darrell- James: Hill
Claimant Case No: CMN 7009 1410 0000 7868 5703
5124 East 18th Avenue
Apache Junction, Arizona [85119]

Ranier: Chief Judge,
United States District Court; District of Arizona
Evo A. DeConcini U.S. Courthouse
405 West Congress Street, Suite 5190
Tucson, Arizona [85701]
520-205-4540

Re: Compensation for Trespass on Claimant Case No: CMN 7009 1410 0000 7868 5703

Ranier, Greetings;

i: man, attach herein for you: bill for 83,893 - U.S. silver dollar, one oz. pieces, for trespass upon my Claimant Case No: CMN 7009 1410 0000 7868 5703; billing period from 01/06/2017 - 1117a to 03/06/2017 - 1730p.

Payment must be made upon mailing receipt.

If you have any questions concerning this bill, you have thirty days to make your questions or objections known.

Thank you;

Darrell - James: Hill

March 07, 2017

USPS CMN 7015 0640 0001 5883 2617

1/5

527
2022-011769 MISC Page: 575 of 2782
09/26/2022 03:35:37 PM Receipt #: 22-9381
Rec Fee: \$30.00 Darrell James Hill
Gila County, AZ, Sadie Jo Bingham, Recorder



INVOICE: CMN 7015 0640 0001 5883 2617

Darrell- James: Hill Claimant Case No: CMN 7009 1410 0000 7868 5703 Contact: 602.618.4595	5124 East 18 th Avenue Apache Junction, Arizona
---	---

INVOICE		
Invoice: Number: CMN 7015 0640 0001 5883 2617 Invoice Date: 03/07/2017, Due Date: 04/06/2017, Balance Due: 83,893 - U.S. silver dollar, 1 oz. pieces. Billing Period: 01/06/2017 – 03/06/2017	Ranier: Chief Judge, United States District Court; District of Arizona Evo A. DeConcini U.S. Courthouse 405 West Congress Street, Suite 5190 Tucson, Arizona [85701] 520-205-4540	

	Item	Description	Unit Cost	Quantity	Line Total
1	TRESPASS UPON CASE	01/06/2017,, 1117p - 01/07/2017,, 1730p	1 U.S. silver dollar, 1oz. piece/ minute	373 minutes	373 pieces
2	TRESPASS UPON CASE	01/07/2017, 1730p - 01/08/2017, 1730p	1 U.S. silver dollar, 1oz. piece/ minute	1,440 minutes	1,440 pieces
3	TRESPASS UPON CASE	01/08/2017, 1730p - 01/09/2017, 1730p	1 U.S. silver dollar, 1oz. piece/ minute	1,440 minutes	1,440 pieces
4	TRESPASS UPON CASE	01/09/2017, 1730p - 01/10/2017, 1730p	1 U.S. silver dollar, 1oz. piece/ minute	1,440 minutes	1,440 pieces
5	TRESPASS UPON CASE	01/10/2017, 1730p - 01/11/2017, 1730p	1 U.S. silver dollar, 1oz. piece/ minute	1,440 minutes	1,440 pieces
6	TRESPASS UPON CASE	01/11/2017, 1730p - 01/12/2017, 1730p	1 U.S. silver dollar, 1oz. piece/ minute	1,440 minutes	1,440 pieces
7	TRESPASS UPON CASE	01/12/2017, 1730p - 01/13/2017, 1730p	1 U.S. silver dollar, 1oz. piece/ minute	1,440 minutes	1,440 pieces
8	TRESPASS UPON CASE	01/13/2017, 1730p - 01/14/2017, 1730p	1 U.S. silver dollar, 1oz. piece/ minute	1,440 minutes	1,440 pieces
9	TRESPASS UPON CASE	01/14/2017, 1730p - 01/15/2017, 1730p	1 U.S. silver dollar, 1oz. piece/ minute	1,440 minutes	1,440 pieces
10	TRESPASS UPON CASE	01/15/2017, 1730p - 01/16/2017, 1730p	1 U.S. silver dollar, 1oz. piece/ minute	1,440 minutes	1,440 pieces
11	TRESPASS UPON CASE	01/16/2017, 1730p - 01/17/2017, 1730p	1 U.S. silver dollar, 1oz. piece/ minute	1,440 minutes	1,440 pieces
12	TRESPASS UPON CASE	01/17/2017, 1730p - 01/18/2017, 1730p	1 U.S. silver dollar, 1oz. piece/ minute	1,440 minutes	1,440 pieces
13	TRESPASS UPON CASE	01/18/2017, 1730p - 01/19/2017, 1730p	1 U.S. silver dollar, 1oz. piece/ minute	1,440 minutes	1,440 pieces

USPS CMN 7015 0640 0001 5883 2617

2/5

578

2022-011769 MISC Page: 576 of 2782
 09/26/2022 03:35:37 PM Receipt #: 22-9381
 Rec Fee: \$30.00 Darrell James Hill
 Gila County, Az, Sadie Jo Bingham, Recorder



INVOICE: CMN 7015 0640 0001 5883 2617

14	TRESPASS UPON CASE	01/19/2017, 1730p - 01/20/2017, 1730p	1 U.S. silver dollar, 1oz. piece/ minute	1,440 minutes	1,440 pieces
15	TRESPASS UPON CASE	01/20/2017, 1730p - 01/21/2017, 1730p	1 U.S. silver dollar, 1oz. piece/ minute	1,440 minutes	1,440 pieces
16	TRESPASS UPON CASE	01/21/2017, 1730p - 01/22/2017, 1730p	1 U.S. silver dollar, 1oz. piece/ minute	1,440 minutes	1,440 pieces
17	TRESPASS UPON CASE	01/22/2017, 1730p - 01/23/2017, 1730p	1 U.S. silver dollar, 1oz. piece/ minute	1,440 minutes	1,440 pieces
18	TRESPASS UPON CASE	01/23/2017, 1730p - 01/24/2017, 1730p	1 U.S. silver dollar, 1oz. piece/ minute	1,440 minutes	1,440 pieces
19	TRESPASS UPON CASE	01/24/2017, 1730p - 01/25/2017, 1730p	1 U.S. silver dollar, 1oz. piece/ minute	1,440 minutes	1,440 pieces
20	TRESPASS UPON CASE	01/25/2017, 1730p - 01/26/2017, 1730p	1 U.S. silver dollar, 1oz. piece/ minute	1,440 minutes	1,440 pieces
21	TRESPASS UPON CASE	01/26/2017, 1730p - 01/27/2017, 1730p	1 U.S. silver dollar, 1oz. piece/ minute	1,440 minutes	1,440 pieces
22	TRESPASS UPON CASE	01/27/2017, 1730p - 01/28/2017, 1730p	1 U.S. silver dollar, 1oz. piece/ minute	1,440 minutes	1,440 pieces
23	TRESPASS UPON CASE	01/28/2017, 1730p - 01/29/2017, 1730p	1 U.S. silver dollar, 1oz. piece/ minute	1,440 minutes	1,440 pieces
24	TRESPASS UPON CASE	01/29/2017, 1730p - 01/30/2017, 1730p	1 U.S. silver dollar, 1oz. piece/ minute	1,440 minutes	1,440 pieces
25	TRESPASS UPON CASE	01/30/2017, 1730p - 01/31/2017, 1730p	1 U.S. silver dollar, 1oz. piece/ minute	1,440 minutes	1,440 pieces
26	TRESPASS UPON CASE	01/31/2017, 1730p - 02/01/2017, 1730p	1 U.S. silver dollar, 1oz. piece/ minute	1,440 minutes	1,440 pieces
27	TRESPASS UPON CASE	02/01/2017, 1730p - 02/02/2017, 1730p	1 U.S. silver dollar, 1oz. piece/ minute	1,440 minutes	1,440 pieces
28	TRESPASS UPON CASE	02/02/2017, 1730p - 02/03/2017, 1730p	1 U.S. silver dollar, 1oz. piece/ minute	1,440 minutes	1,440 pieces
29	TRESPASS UPON CASE	02/03/2017, 1730p - 02/04/2017, 1730p	1 U.S. silver dollar, 1oz. piece/ minute	1,440 minutes	1,440 pieces
30	TRESPASS UPON CASE	02/04/2017, 1730p - 02/05/2017, 1730p	1 U.S. silver dollar, 1oz. piece/ minute	1,440 minutes	1,440 pieces
31	TRESPASS UPON CASE	02/05/2017, 1730p - 02/06/2017, 1730p	1 U.S. silver dollar, 1oz. piece/ minute	1,440 minutes	1,440 pieces
32	TRESPASS UPON CASE	02/06/2017, 1730p - 02/07/2017, 1730p	1 U.S. silver dollar, 1oz. piece/ minute	1,440 minutes	1,440 pieces

USPS CMN 7015 0640 0001 5883 2617

3/5

2022-011769 MISC Page: 577 of 2782

09/26/2022 03:35:37 PM Receipt #: 22-9381

Rec Fee: \$30.00 Darrell James Hill

Gila County, Az, Sadie Jo Bingham, Recorder



579

INVOICE: CMN 7015 0640 0001 5883 2617

33	TRESPASS UPON CASE	02/07/2017, 1730p - 02/08/2017, 1730p	1 U.S. silver dollar, 1oz. piece/ minute	1,440 minutes	1,440 pieces
34	TRESPASS UPON CASE	02/08/2017, 1730p - 02/09/2017, 1730p	1 U.S. silver dollar, 1oz. piece/ minute	1,440 minutes	1,440 pieces
35	TRESPASS UPON CASE	02/09/2017, 1730p - 02/10/2017, 1730p	1 U.S. silver dollar, 1oz. piece/ minute	1,440 minutes	1,440 pieces
36	TRESPASS UPON CASE	02/10/2017, 1730p - 02/11/2017, 1730p	1 U.S. silver dollar, 1oz. piece/ minute	1,440 minutes	1,440 pieces
37	TRESPASS UPON CASE	02/11/2017, 1730p - 02/12/2017, 1730p	1 U.S. silver dollar, 1oz. piece/ minute	1,440 minutes	1,440 pieces
38	TRESPASS UPON CASE	02/12/2017, 1730p - 02/13/2017, 1730p	1 U.S. silver dollar, 1oz. piece/ minute	1,440 minutes	1,440 pieces
39	TRESPASS UPON CASE	02/13/2017, 1730p - 02/14/2017, 1730p	1 U.S. silver dollar, 1oz. piece/ minute	1,440 minutes	1,440 pieces
40	TRESPASS UPON CASE	02/14/2017, 1730p - 02/15/2017, 1730p	1 U.S. silver dollar, 1oz. piece/ minute	1,440 minutes	1,440 pieces
41	TRESPASS UPON CASE	02/15/2017, 1730p - 02/16/2017, 1730p	1 U.S. silver dollar, 1oz. piece/ minute	1,440 minutes	1,440 pieces
42	TRESPASS UPON CASE	02/16/2017, 1730p - 02/17/2017, 1730p	1 U.S. silver dollar, 1oz. piece/ minute	1,440 minutes	1,440 pieces
43	TRESPASS UPON CASE	02/17/2017, 1730p - 02/18/2017, 1730p	1 U.S. silver dollar, 1oz. piece/ minute	1,440 minutes	1,440 pieces
44	TRESPASS UPON CASE	02/18/2017, 1730p - 02/19/2017, 1730p	1 U.S. silver dollar, 1oz. piece/ minute	1,440 minutes	1,440 pieces
45	TRESPASS UPON CASE	02/19/2017, 1730p - 02/20/2017, 1730p	1 U.S. silver dollar, 1oz. piece/ minute	1,440 minutes	1,440 pieces
46	TRESPASS UPON CASE	02/20/2017, 1730p - 02/21/2017, 1730p	1 U.S. silver dollar, 1oz. piece/ minute	1,440 minutes	1,440 pieces
47	TRESPASS UPON CASE	02/21/2017, 1730p - 02/22/2017, 1730p	1 U.S. silver dollar, 1oz. piece/ minute	1,440 minutes	1,440 pieces
48	TRESPASS UPON CASE	02/22/2017, 1730p - 02/23/2017, 1730p	1 U.S. silver dollar, 1oz. piece/ minute	1,440 minutes	1,440 pieces
49	TRESPASS UPON CASE	02/23/2017, 1730p - 02/24/2017, 1730p	1 U.S. silver dollar, 1oz. piece/ minute	1,440 minutes	1,440 pieces
50	TRESPASS UPON CASE	02/24/2017, 1730p - 02/25/2017, 1730p	1 U.S. silver dollar, 1oz. piece/ minute	1,440 minutes	1,440 pieces
51	TRESPASS UPON CASE	02/25/2017, 1730p - 02/26/2017, 1730p	1 U.S. silver dollar, 1oz. piece/ minute	1,440 minutes	1,440 pieces

USPS CMN 7015 0640 0001 5883 2617

4/5

2022-011769 MISC Page: 578 of 2782
 09/26/2022 03:35:37 PM Receipt #: 22-9381
 Rec Fee: \$30.00 Darrell James Hill
 Gila County, Az, Sadie Jo Bingham, Recorder



580

INVOICE: CMN 7015 0640 0001 5883 2617

52	TRESPASS UPON CASE	02/26/2017, 1730p - 02/27/2017, 1730p	1 U.S. silver dollar, 1oz. piece/ minute	1,440 minutes	1,440 pieces
53	TRESPASS UPON CASE	02/27/2017, 1730p - 02/28/2017, 1730p	1 U.S. silver dollar, 1oz. piece/ minute	1,440 minutes	1,440 pieces
54	TRESPASS UPON CASE	02/28/2017, 1730p - 03/01/2017, 1730p	1 U.S. silver dollar, 1oz. piece/ minute	1,440 minutes	1,440 pieces
55	TRESPASS UPON CASE	03/01/2017, 1730p - 03/02/2017, 1730p	1 U.S. silver dollar, 1oz. piece/ minute	1,440 minutes	1,440 pieces
56	TRESPASS UPON CASE	03/02/2017, 1730p - 03/03/2017, 1730p	1 U.S. silver dollar, 1oz. piece/ minute	1,440 minutes	1,440 pieces
57	TRESPASS UPON CASE	03/03/2017, 1730p - 03/04/2017, 1730p	1 U.S. silver dollar, 1oz. piece/ minute	1,440 minutes	1,440 pieces
58	TRESPASS UPON CASE	03/04/2017, 1730p - 03/05/2017, 1730p	1 U.S. silver dollar, 1oz. piece/ minute	1,440 minutes	1,440 pieces
59	TRESPASS UPON CASE	03/05/2017, 1730p - 03/06/2017, 1730p	1 U.S. silver dollar, 1oz. piece/ minute	1,440 minutes	1,440 pieces

If you have any questions concerning this bill, you have thirty days to make your questions or objections known. Terms: Due Upon Receipt	Subtotal:	83,893 pieces
	Paid to Date:	0
	Balance Due:	83,893 pieces (U.S. silver dollar, 1oz.)

Darrell - James Hill
03/07/17

USPS CMN 7015 0640 0001 5883 2617

5/5

2022-011769 MISC Page: 579 of 2782
09/26/2022 03:35:37 PM Receipt #: 22-9381
Rec Fee: \$30.00 Darrell James Hill
Gila County, Az, Sadie Jo Bingham, Recorder



Unofficial Copy

581

**U.S. Postal Service™
CERTIFIED MAIL® RECEIPT**
Domestic Mail Only

For delivery information, visit our website at www.usps.com™.

TUCSON, AZ 85701

OFFICIAL USE

Certified Mail Fee \$3.35

Extra Services & Fees (check box, add fee to Certified Mail Fee)
 Return Receipt (hardcopy) \$2.75
 Return Receipt (electronic) \$0.00
 Certified Mail Restricted Delivery \$0.00
 Adult Signature Required \$0.00
 Adult Signature Restricted Delivery \$0.00

Postage \$0.70

Total Postage and Fees \$6.80

Sent To Ranier, Chief Judge,
United States District Court, District of Arizona

Street and Apt. No. Eva A. DeConcini U.S. Courthouse
405 West Congress Street, Suite 5190

City, State, ZIP+4® Tucson, Arizona 85701

PS Form 3800, April 2015 PSN 7530-02-000-6047

0130
01

Postmark
Here

03/07/2017

See Reverse for Instructions

APACHE JUNCTION
151 W SUPERSTITION BLVD
APACHE JUNCTION
AZ

85120-9998
0302590130

03/07/2017 (800)275-8777 10:01 AM

Product Description	Qty	Sale Price	Final Price
First-Class Mail Letter (Domestic) (TUCSON, AZ 85701) (Weight: 0 Lb 1.30 Oz) (Expected Delivery Day) (Thursday 03/09/2017)	1	\$0.70	\$0.70
Certified (@USPS Certified Mail #) (70150640000158832617)	1	\$3.35	\$3.35
Return Receipt (@USPS Return Receipt #) (9590940220736132037486)	1	\$2.75	\$2.75
First-Class Mail Letter (Domestic) (PHOENIX, AZ 85003) (Weight: 0 Lb 1.30 Oz) (Expected Delivery Day) (Thursday 03/09/2017)	1	\$0.70	\$0.70
Certified (@USPS Certified Mail #) (70150640000158832600)	1	\$3.35	\$3.35
Return Receipt (@USPS Return Receipt #) (9590940220736132037479)	1	\$2.75	\$2.75
Total			\$13.60
Cash			\$15.00
Change			(\$1.40)

Product Description Qty Sale Price Final Price

First-Class Mail Letter
(Domestic)
(TUCSON, AZ 85701)
(Weight: 0 Lb 1.30 Oz)
(Expected Delivery Day)
(Thursday 03/09/2017)

Certified 1 \$3.35
(@USPS Certified Mail #)
(70150640000158832617)

Return Receipt 1 \$2.75
(@USPS Return Receipt #)
(9590940220736132037486)

First-Class Mail Letter
(Domestic)
(PHOENIX, AZ 85003)
(Weight: 0 Lb 1.30 Oz)
(Expected Delivery Day)
(Thursday 03/09/2017)

Certified 1 \$3.35
(@USPS Certified Mail #)
(70150640000158832600)

Return Receipt 1 \$2.75
(@USPS Return Receipt #)
(9590940220736132037479)

Total \$13.60

Cash \$15.00

Change (\$1.40)

Text your tracking number to 28777 (2USPS) to get the latest status. Standard Message and Data rates may apply. You may also visit USPS.com USPS Tracking or call 1-800-222-1811.

In a hurry? Self-service kiosks offer quick and easy check-out. Any Retail



582

Unofficial

7025 0640 0001 5883 2617

USPS Tracking®

Still Have Que
Browse our F.

Get
Stic

Tracking Number: 70150640000158832617

On Time
Updated Delivery Day: Thursday, March 9, 2017

Product & Tracking Information

Postal Product:
First-Class Mail®

Features:
Certified Mail™

Return Receipt

See tracking for related item: 9590940220736132037486

Available /

Text Updates

Email Updates

DATE & TIME	STATUS OF ITEM	LOCATION
March 9, 2017 , 11:56 am	Delivered, Left with Individual	TUCSON, AZ 85701

Your item was delivered to an individual at the address at 11:56 am on March 9, 2017 in TUCSON, AZ 85701.

March 9, 2017 , 8:09 am	Out for Delivery	TUCSON, AZ 85701
March 9, 2017 , 7:59 am	Sorting Complete	TUCSON, AZ 85701
March 9, 2017 , 7:20 am	Arrived at Unit	TUCSON, AZ 85726
March 9, 2017 , 12:45 am	Departed USPS Facility	TUCSON, AZ 85726
March 8, 2017 , 3:03 pm	Arrived at USPS Facility	TUCSON, AZ 85726
March 8, 2017 , 8:54 am	Departed USPS Facility	PHOENIX, AZ 85026
March 7, 2017 , 7:15 pm	Arrived at USPS Facility	PHOENIX, AZ 85026
March 7, 2017 , 9:58 am	Acceptance	APACHE JUNCTION, AZ 85120

2022-011769 MISC Page: 581 of 2782
09/26/2022 03:95:37 PM Receipt #: 22-9381
Rec Fee: \$30 00 Darrell James Hill
Gila County, Az, Sadie Jo Bingham, Recorder



Darrell- James: Hill, aggrieved man¹
c/o 5142 East 18th Avenue
Apache Junction, Arizona ZIP CODE EXEMPT
without the US Inc. [85119]

Sidney; acting as Chief Judge, Chairman;
Richard; acting as Circuit Judge;
Susan; acting as Senior District Judge;
Judicial Council Executive Committee
c/o Office of Executive Committee
P.O. Box 193939
San Francisco, California 94119-3939

**Jurat Affidavit- Notice²:
9th Circuit Trespass Upon Fundamental and Substantive Rights³,
and Common-Law-Claim⁴ Rights Under Color-of-Law⁵**

Sidney, Richard, Susan: Greetings;

i: man am writing: because i filed a Common-Law-Claim, "claim", for suit into the federal court in Phoenix, Arizona for an amount in controversy greater than 20 dollars in property-forfeited-to-me⁶. And, administratively, i must make you aware of the destruction⁷ of my rights violations surrounding that case because Ranier and Brian, the Chief Judge- USDC-AZ and the Clerk of Court- USDC-AZ, respectively, are involved in the groups' wrong-doings destroying my claim. And, finally, because you are

- 1 i: man means: a) a flesh and blood man-kind understanding Almighty God of Abraham of the Holy Bible, and a sovereign one who in a collective capacity with others sovereigns are the people of the United States of America over-standing the government for the United States of America; b) NOT a cestui que trust, corporation, or other fictitious entity; c) NOT a US citizen; d) Not an inhabitant of a federal area See at Gila County Recorder – site: <http://recorder.gilacountyaz.gov/recorder/web/> Document Number: 2017-002378, pg 199-217 Affidavit
- 2 notify (v), notice means: to point out information, intelligence, knowledge; formal warning
- 3 fundamental-and-substantive-rights means: a) those inalienable rights from Almighty God inherent to nature and man, the right to protect them, and to the world stewardship, life, liberty and property. b) See Gila County Recorder – <http://recorder.gilacountyaz.gov/recorder/web/> Document Number: 2017-002378, pg 684-690. c) See: Declaration of Independence (1776) re: the Constitution for the United States of America (1787), Amendments VII, IX, and X (1789) d) "... [W]hile powers are delegated to the agencies of government, sovereignty itself remains with the people, by whom and for whom all government exists and acts." – Yick Wo v. Hopkins.
- 4 Common-Law-Claim means: a claim brought by a man, the facts and law determined by a jury and/or by a judge. Section I: See at Gila County Recorder – site: <http://recorder.gilacountyaz.gov/recorder/web/> Document Number: 2017-002378, pg 184-584.
- 5 color-of-law means: appearance of truth, likelihood, validity, or right; justification; an initially apparent or prima-facie right; a sufficient warrant for action; as, color of title. See: Gila County Recorder – site: <http://recorder.gilacountyaz.gov/recorder/web/> Document Number: 2017-002378, pg 193. subscript 12.
- 6 property means: a thing privately owned and set aside for private and exclusive use. See at Gila County Recorder – site: <http://recorder.gilacountyaz.gov/recorder/web/> Document Number: 2017-002378, pg 240-549.
- 7 destruction (n.) destroy means: tear down, lay waste, ravage

USPS RMN: RE 322 399 234 US - Jurat Notice to Ninth Jud.Coun.Exec.Com: Sidney Richard Susan 1/1

2022-011769 MISC Page: 582 of 2782
09/26/2022 03:35:37 PM Receipt #: 22-9381
Rec Fee: \$30.00 Darrell James Hill
Gila County, Az, Sadie Jo Bingham, Recorder



584

the only next responsible party in the 9th Circuit Court for addressing the harm and loss i allege, i want my Common-Law-Claim filed and proceeding with no abuse actions against me.

Section I: Offenders; the Group

For nearly four months, beginning January 04, 2017, my Claim has been destroyed by an employee- "group"⁸ within the 9th, Circuit United States District Court⁹, "USDC", Phoenix, Arizona. As explained below under Section III, the group's disregard for my fundamental-and-substantive-rights, rather than the protection of my rights, is a violation against¹⁰ the sovereign people, "people" – the same United-States-of-America-people giving rise to the government for the United States, the United States government, "USgov", and under it, the inferior-courts.

Section II: The Contract

Understanding Almighty God, the people of the United States formed-the-Constitution¹¹ for the people of the United States, under which the USgov was delegated authority¹² to serve: to establish statutory¹³ judicial rules and inferior courts¹⁴. To wit:

a) No statute, and No code, and No rule on any level of the USgov may exceed the Constitutional limits of authority delegated to it by the people; b) The people are forever sovereign over the USgov. And, c) the USgov is forever bound by the Constitution contract: to understand the limits, duties, and obligations of the authorization enabled it. This is common knowledge in fact and in public records.

Section III: Breach of Contract

i presented a claim for filing suit with trial-by-jury¹⁵, for the recovery of my property re: "Hill v Lynch"
In The Hill Court; 'A Federal Court'

at 'District Court of the united States
for Phoenix Arizona', U.S.A.

Claimant Case No: CMN 7009 1410 0000 7868 5703 "

The USDC- Phoenix assigned Case No. CV-17-00026-PHX-BSB.

But, my Common-Law-Claim presentment was Not filed for suit as ordered. Instead, the group, at the USDC- Phoenix Clerk of Court, et al.: 1) changed¹⁶ the court¹⁷, 2) changed the trial-by-jury, and 3)

- 8 employee- "group" means: a) Ranier, acting as Chief Judge and b) Brian, acting as Clerk of Court, (c) et al. employees under Ranier/ Brian: USDC-Ariz., Phoenix
- 9 USDC means: an inferior court under the authority of the government for the United States of America
- 10 against means: in opposition to, adverse, hostile
- 11 formed-the-Constitution means: "We the people of the United States, in Order to form a more perfect Union, ... do ordain and establish this Constitution for the United States of America." Constitution for the United States of America, 1787: preamble.
- 12 authority means: formal approval or sanction given; authorization
- 13 statutory (adj.) statute means: any law enacted under the Constitutional contract
- 14 Inferior courts means: "The Congress shall have power to ... constitute Tribunals inferior to the supreme Court[.] Constitution for the United States of America, 1787: Art. I, sect.8, cl. 9. In example, 9th Circuit Court is an inferior court.
- 15 trial by jury, try by jury means: judicial examination of the facts/ law of a matter by the jury, a set of people selected to try a matter and render a verdict ~ USDC- Phx No. CV-17-00026-PHX-BSB. Doc 1 - See at Gila County Recorder – site: <http://recorder.gilacountyaz.gov/recorder/web/> Document Number: 2017-002378, pg 607-642. notice; Status:
- 16 change means: to substitute a one thing for another, so to make the first thing other than what it was.
- 17 court means: the functional context and purpose for a judicial assembly; "In The Hill Court; A 'Federal Court' ..." for a Common Law Claim ~ Doc 1 - See at Gila County Recorder – site: <http://recorder.gilacountyaz.gov/recorder/web/> Document Number: 2017-002378, pg 657: Case Summary, et seq.

585

USPS RMN: RE 322 399 234 US - Jurat Notice to Ninth Jud Coun Exec Com: Sidney, Richard, Susan 2/4

2022-011769 MISC Page: 583 of 2782

09/25/2022 03:35:37 PM Receipt #: 22-9381

Rec Fee: \$30.00 Darrell James Hill

Gila County, Az, Sadie Jo Bingham, Recorder



changed the jurisdiction¹⁸: 3a) without¹⁹ my counsel, 3b) with No-authorization²⁰, and 3c) without jurisdiction; then, they 4) did not issue summons; and, 5) a month later wrote ostensibly²¹ that they would not issue summons unless I agreed to substitute their jurisdiction. **Neither the USgov nor an inferior court under it has authorization from the people in the Constitutional contract to impose²² wanton abrogation²³ of fundamental or substantive or common law rights upon the people (upon i: man). To this, any and all presumption of authority for the group's any changes to my claim has been expressly denied²⁴.**

Section IV: Intent and Damage

The Arizona group implemented an obscure²⁵ color-of-law scheme using 'rules' and standard-operating-procedure²⁶ with No authority under the USgov to systematically- deprive²⁷ the people of their (i: man of my) fundamental, substantive, and common law rights. The record reflects that the group ostensibly sought to obtain jurisdiction over my claim by willful deception and coercion.

At minimum the group members exceeded the USgov Constitutional authority, and did harm and cause loss upon i: man, and with regard to the trespass-upon-the-case²⁸ of the Common-Law-Claim for suit for an amount in controversy greater than twenty dollars. See Constitution (1787); Bill-of-Rights²⁹ (1789), Amendment VII³⁰, IX³¹ and X³².

Section V: Restoration

Despite my good faith efforts and admonishment, even the conspicuous "compensation due"

18 **Jurisdiction: trial by jury** means: ~ USDC- Phx No. CV-17-00026-PHX-BSB. Doc 1 -

See at Gila County Recorder – site: <http://recorder.gilacountyaz.gov/recorder/web/> Document Number: 2017-002378, pg 585-587: **ORDER**; pg 596-599: **notice: Rules of Court**; pg 607-642: **notice: Status:**; pg 643- : **NOTICE: (g)**; pg 665- : **Notice: To Magistrate**

19 **without** means: outside of; lacking

20 **No-authorization** means: No formal approval or sanction or "authority" given

21 **ostensibly** means: capable of being shown

22 **impose** means: inflict by force or authority

23 **abrogation (n), abrogate** means: abolish by authoritative activities

24 **denied** means: refused, rejected, NOT true

25 **obscure** means: hidden, covert

26 **standard operating procedure** means: a set of step-by-step instructions compiled by an organization for help workers carry out routine operations.

27 **systematically- deprive** means: racketeering, by group criminal conduct

28 **trespass-upon-the-case** means: a) "Notice to Officers of the Court", et seq.: USDC- Phx No. CV-17-00026-PHX-BSB. Doc 1. See: Gila County Recorder – site: <http://recorder.gilacountyaz.gov/recorder/web/> Document Number: 2017-002378, pg 192; b) "notice: Status; Clerks' non-Supply of Summon" pp. 607-642.

29 **Bill-of-Rights** means: "... [I]n order to prevent misconstruction or abuse of its powers [] further declaratory and restrictive clauses should be added: ARTICLES in addition to, and Amendment of the Constitution of the United States of America..."

30 **Amendment VII** means: "Article the ninth In Suits at common law, where the value in controversy shall exceed twenty dollars, the right of trial by jury shall be preserved..." Constitution for the United States of America, 1787; Bill of Rights, 1789.

31 **Amendment IX** means: "Article the eleventh The enumeration in the Constitution, of certain rights, shall not be construed to deny or disparage others retained by the people." Constitution for the United States of America, 1787; Bill of Rights, 1789.

32 **Amendment X** means: "Article the twelfth The powers not delegated to the United States by the Constitution, nor prohibited by it to the States, are reserved to the States respectively, or to the people." Constitution for the United States of America, 1787; Bill of Rights, 1789.

USPS RMN: RE 322 399 234 US - Jurat Notice to Ninth Judicial Court Exec Comr Sidney Richard Susan 3/4

2022-011769 MISC Page: 584 of 2782

09/26/2022 03:35:37 PM Receipt #: 22-9381

Rec Fee: \$30.00 Darrell James Hill

Gila County, Az, Sadie Jo Bingham, Recorder



agreeance³³ -on default³⁴ upon any trespass-upon-the-case, the group members persisted to impose a deprivation of rights scheme or scam against i: man 1z, one of the people. Therefore, upon your receipt of this notice i require³⁵ that: a) this deprivation of rights in breach of Constitutional contract in all its forms of trespass-upon-the-case must be ceased and desisted hereto-forever post haste; b) my Common-Law-Claim presentments must hereto-forever be filed as ordered; c) This deprivation of rights must No longer be permitted; and, d) i: man must be made whole³⁶. I would want to know so to repair the wrong-doings occuring under my oath, authority, duty and obligation, and reputation.

Section VI: Conclusion

There is No USgov authority nor inferior court authority under the USgov for the protection³⁷ of the group's wrong-doings against i: man's (against the people's) inalienable rights or substantive rights or rights to common law claim. The group members knew or should have known that **this deprivation of rights by any USgov subordinate was NEVER supposed to be imposed or allowed to happen to the people (to i: man) of the United States of America.** And,

This deprivation of rights against the people (i: man) hereto-forever must Not ever be tolerated.

i, say here, and will verify in open court, that all herein be true.

April 27th, 2017

Jurat

State of Arizona
County of Pinal

On this 27th day of April 2017, before me present is Darrell- James: Hill whose identity was proven to me on the basis of satisfactory evidence of an State of Arizona Driver License to be the Authorized Representative claimed: Signed and affirmed before me this 27th day of April; 2017;

Notary Public

33 agreeance means: the action of consent, assent. The group members all acquiesced to the compensation due upon their actions; agreeance -- by default in trespass-upon-the-case.

34 default means: to put wrong

35 require means: a demanding of that which is necessary and proper and critical for proceeding upon a right

36 made whole means: compensation-due; fees for common law filing returned

37 protection means: defend, assist, shelter



587

Registered No. RE322399234US

Date Stamp
0130
07

To Be Completed By Post Office	Postage \$ 00.70	Extra Services & Fees (continued)
	Extra Services & Fees	<input type="checkbox"/> Signature Confirmation \$
	<input type="checkbox"/> Registered Mail \$ 12.50	<input type="checkbox"/> Signature Confirmation Restricted Delivery \$
	<input type="checkbox"/> Return Receipt (hardcopy) \$ 2.75	
	<input type="checkbox"/> Return Receipt (electronic) \$ 0.00	
<input type="checkbox"/> Restricted Delivery \$	Total Postage & Fees \$ 15.95	
Customer Must Declare Full Value \$ 10.00	Received by 04/27/2017	Domestic insurance up to \$50,000 is included based upon the declared value. International indemnity is limited. (See Reverse).

APACHE JUNCTION
151 W SUPERSTITION BLVD
APACHE JUNCTION
AZ
85120-9998
0302590130
04/27/2017 (800)275-8777 3:17 PM

Product Description	Qty	Final Price
First-Class Mail Letter (Domestic)	1	\$0.70

(SAN FRANCISCO, CA 94119)
(Weight: 0 Lb 1.20 Oz)
(Expected Delivery Day)
(Monday 05/01/2017)
Registered 1 \$12.50
(Amount: \$10.00)
(@USPS Registered Mail #)
(RE322399234US)
Return-Receipt 1 \$2.75
(@USPS Return Receipt #)
(9590940220736132026930)

To Be Completed By Customer (Please Print) All Entries Must Be in Ballpoint or Typed	FROM	Darrell, James Hill, approved man c/o 5142 East 18 th Avenue Apache Junction, Arizona ZIP CODE EXEMPT 85120 without the US Inc. (85119)
	TO	Sidney, acting as Chief Judge, Chairman; Richard, acting as Circuit Judge; SAN FRANCISCO, CA Judicial Council Executive Committee c/o Office of Executive Committee P.O. Box 193939 San Francisco, California 94119-3939

PS Form 3806, Registered Mail Receipt
April 2015, PSN 7530-02-000-9051
Copy 1 - Customer (See Information on Reverse)
For domestic delivery information, visit our website at www.usps.com

Total \$15.95
Cash \$50.00
Change (\$34.05)

In a hurry? Self-service kiosks offer quick and easy check-out. Any Retail Associate can show you how.

Text your tracking number to 28777 (2USPS) to get the latest status. Standard Message and Data rates may apply. You may also visit USPS.com USPS Tracking or call 1-800-222-1811.

BRIGHTEN SOMEONE'S MAILBOX. Greeting cards available for purchase at select Post Offices.



Unofficial Copy

588

Darrell- James: Hill c/o 5124 East 18th Avenue, Apache Junction, Arizona [85119]

USPS RMN RE 322 399 044 US

Jeff, AG Sessions
c/o **Kenneth A, Acting Assistant AG Blanco**
US DOJ Criminal Division
950 Pennsylvania Avenue, NW
Washington, District of Columbia 20530-0001

USPS RMN RE 322 399 058 US

Elizabeth A. Strange, Acting USA
Two Renaissance Square
40 N. Central Avenue, Suite 1200
Phoenix, Arizona 85004-4408

USPS CMN 7015 0640 0001 5883 2655

Office of Information Policy
Laurie, Chief OIP Day
Initial Request Staff
1425 New Your Avenue, N.W., Suite 11050
Washington, District of Columbia 20530-0001

USPS RMN RE 322 399 061 US

Michael E. Horowitz, IG- DOJ,
IG of Investigations
c/o **Robert P. Storch, Deputy IG-DOJ**
1425 New York Avenue, N.W., Suite 7100
Washington, District of Columbia 20530-2011

USPS RMN RE 322 399 089 US

Acting Director, FBI
c/o **Andrew, Deputy Director McCabe**
c/o **David, Assoc. Dep. Dir. Bowdich**
J. Edgar Hoover Building
935 Pennsylvania Avenue NW
Washington, District of Columbia 20535-3000

USPS RMN RE 322 399 075 US

Richard, Branch Manager Benson
Michael, SA in Charge DeLeon
FBI- Phoenix, Arizona
21711 N. 7th Street
Phoenix, Arizona 84024

USPS First Class Mail

Mark, Sheriff Lamb
Pinal county Sheriff Office
971 Jason Lopez Cir., Building C
Florence, Arizona 85132

USPS RMN RE 322 399 092 US

c/o
Office of the POTUS
Donald, Pres. Trump
1600 Pennsylvania Ave N.W.
Washington, District of Columbia 20500

USPS RMN RE 322 399 044 US

COPY

589

2022-011769 MISC Page: 587 of 2782
09/26/2022 03:35:37 PM Receipt #: 22-9381
Rec Fee: \$30.00 Darrell James Hill
Gila County, Az, Sadie Jo Bingham, Recorder

APACHE JUNCTION
 151 W SUPERSTITION BLVD
 APACHE JUNCTION
 AZ
 85120-9998
 0302590130
 (800)275-8777 4:02 PM
 07/13/2017

Product Description	Sale Qty	Final Price
First-Class Mail Letter (Domestic) (WASHINGTON, DC 20530) (Weight: 0 Lb 0.70 Oz) (Expected Delivery Day) (Monday 07/17/2017)	1	\$0.49
Registered (Amount: \$0.00) (@USPS Registered Mail #) (RE322399101US)	1	\$11.70
Return Receipt (@USPS Return Receipt #) (9590940220736132033853)	1	\$2.75
First-Class Mail Large Envelope (Domestic) (WASHINGTON, DC 20500) (Weight: 0 Lb 6.10 Oz) (Expected Delivery Day) (Monday 07/17/2017)	1	\$2.24
Registered (Amount: \$0.00) (@USPS Registered Mail #) (RE322399044US)	1	\$11.70
Return Receipt (@USPS Return Receipt #) (9590940220736132027005)	1	\$2.75
First-Class Mail Large Envelope (Domestic) (WASHINGTON, DC 20530) (Weight: 0 Lb 6.10 Oz) (Expected Delivery Day) (Monday 07/17/2017)	1	\$2.24
Registered (Amount: \$0.00) (@USPS Registered Mail #) (RE322399058US)	1	\$11.70
Return Receipt (@USPS Return Receipt #) (9590940220736132033846)	1	\$2.75
First-Class Mail Large Envelope (Domestic) (WASHINGTON, DC 20530) (Weight: 0 Lb 6.10 Oz) (Expected Delivery Day) (Monday 07/17/2017)	1	\$2.24
Registered (Amount: \$0.00) (@USPS Registered Mail #) (RE322399061US)	1	\$11.70

Registered No. RE322399101US

Reg. Fee	\$0.49	Return Receipt	
Handling Charge	\$11.70	Restricted Delivery	
Postage	\$2.75		
Received by	\$0.00		
Customer Must Declare Full Value	\$8.00	Received by	07/13/2017

APACHE JUNCTION, AZ 85120

FROM: Darrell James Hill
 c/o 5124 East 18th Avenue
 Apache Junction, Arizona 85119

TO: Jeff U.S. AG Sessions
 WASHINGTON, DC 20530-0001

PS Form 3806, Receipt for Registered Mail Copy 1 - Customer
 May 2007 (7530-02-000-9051)
 For domestic delivery information, visit our website at www.usps.com

Registered No. RE322399044US

Postage	\$2.24	Extra Services & Fees	\$11.70
Registered Mail	\$11.70	Signature Confirmation	
Return Receipt (hardcopy)	\$2.75	Signature Confirmation Restricted Delivery	
Return Receipt (electronic)	\$0.00	Total Postage & Fees	\$16.69
Restricted Delivery	\$0.00	Received by	07/13/2017
Customer Must Declare Full Value	\$0.00		

APACHE JUNCTION, AZ 85120

FROM: Darrell James Hill
 c/o 5124 East 18th Avenue
 Apache Junction, Arizona 85119

TO: Office of the POTUS
 WASHINGTON, DC 20500
 1800 Pennsylvania Ave N.W.
 Washington, District of Columbia 20500

PS Form 3806, Registered Mail Receipt Copy 1 - Customer
 April 2015, PSN 7530-02-000-9051
 For domestic delivery information, visit our website at www.usps.com

15509402207361320270057

First-Class 1 \$2.24
Mail

Large Envelope (Domestic)
(WASHINGTON, DC 20530)
(Weight: 0 Lb 6.10 Oz)
(Expected Delivery Day)
(Monday 07/17/2017)

Registered 1 \$11.70
(Amount: \$0.00)
(USPS Registered Mail #)
(RE322399058US)

Return Receipt 1 \$2.75
(USPS Return Receipt #)
(9590940220736132033846)

First-Class 1 \$2.24
Mail

Large Envelope (Domestic)
(WASHINGTON, DC 20530)
(Weight: 0 Lb 6.10 Oz)
(Expected Delivery Day)
(Monday 07/17/2017)

Registered 1 \$11.70
(Amount: \$0.00)
(USPS Registered Mail #)
(RE322399061US)

Return Receipt 1 \$2.75
(USPS Return Receipt #)
(9590940220736132026947)

First-Class 1 \$2.24
Mail

Large Envelope (Domestic)
(WASHINGTON, DC 20535)
(Weight: 0 Lb 6.10 Oz)
(Expected Delivery Day)
(Monday 07/17/2017)

Registered 1 \$11.70
(Amount: \$0.00)
(USPS Registered Mail #)
(RE322399075US)

Return Receipt 1 \$2.75
(USPS Return Receipt #)
(9590940220736132026978)

First-Class 1 \$2.03
Mail

Registered No. RE322399058US

To Be Completed By Post Office	Postage \$	\$2.24	Extra Services & Fees (continued)
	Extra Services & Fees	\$11.70	<input type="checkbox"/> Signature Confirmation
	<input type="checkbox"/> Registered Mail	\$11.70	<input type="checkbox"/> Signature Confirmation Restricted Delivery
	<input type="checkbox"/> Return Receipt (hardcopy)	\$2.75	
	<input type="checkbox"/> Return Receipt (electronic)	\$0.00	
	<input type="checkbox"/> Restricted Delivery	\$0.00	Total Postage & Fees \$16.69
Customer Must Declare Full Value	\$0.00	Received by	07/13/2017 TWS

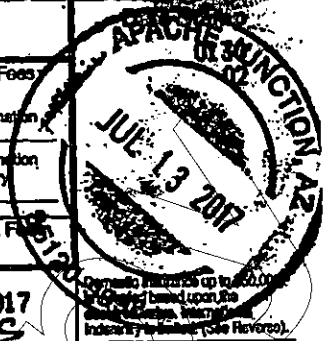

OFFICIAL USE

APACHE JUNCTION, AZ 85120

FROM: Darrell James Hill
c/o 5124 East 18th Avenue,
Apache Junction, Arizona (85119)
85120

TO: Jeff, AG Services
c/o Federal A. Arden American AG Branch,
WASHINGTON, DC 20530
350 Pennsylvania Avenue, NW
Washington, District of Columbia 20530-0001

PS Form 3806, Registered Mail Receipt
April 2015, PSN 7530-02-000-9051
For domestic delivery information, visit our website at www.usps.com

Copy 1 - Customer
(See information on Reverse)

Registered No. RE322399061US

To Be Completed By Post Office	Postage \$	\$2.24	Extra Services & Fees (continued)
	Extra Services & Fees	\$11.70	<input type="checkbox"/> Signature Confirmation
	<input type="checkbox"/> Registered Mail	\$11.70	<input type="checkbox"/> Signature Confirmation Restricted Delivery
	<input type="checkbox"/> Return Receipt (hardcopy)	\$2.75	
	<input type="checkbox"/> Return Receipt (electronic)	\$0.00	
	<input type="checkbox"/> Restricted Delivery	\$0.00	Total Postage & Fees \$16.69
Customer Must Declare Full Value	\$0.00	Received by	07/13/2017 TWS



OFFICIAL USE

APACHE JUNCTION, AZ 85120

FROM: Darrell James Hill
c/o 5124 East 18th Avenue,
Apache Junction, Arizona (85119)
85120

TO: Office of Information Policy
Lynch, CHAD GUY
WASHINGTON, DC 20530
1425 New York Avenue, N.W., Suite 11050
Washington, District of Columbia 20530-0001

PS Form 3806, Registered Mail Receipt
April 2015, PSN 7530-02-000-9051
For domestic delivery information, visit our website at www.usps.com

Copy 1 - Customer
(See information on Reverse)

591

Unofficial

First-Class 1 \$2.24

Mail Large Envelope (Domestic) (WASHINGTON, DC 20535) (Weight: 0 Lb 6.10 Oz) (Expected Delivery Day) (Monday 07/17/2017)

Registered 1 \$11.70 (Amount: \$0.00) (USPS Registered Mail #) (RE322399075US)

Return Receipt 1 \$2.75 (USPS Return Receipt #) (9590940220736132026978)

First-Class Mail Large Envelope (Domestic) (WASHINGTON, DC 20530) (Weight: 0 Lb 6.00 Oz) (Expected Delivery Day) (Monday 07/17/2017)

Registered 1 \$11.70 (Amount: \$0.00) (USPS Registered Mail #) (RE322399089US)

Return Receipt 1 \$2.75 (USPS Return Receipt #) (9590940220736132026985)

First-Class Mail Large Envelope (Domestic) (PHOENIX, AZ 85004) (Weight: 0 Lb 5.80 Oz) (Expected Delivery Day) (Saturday 07/15/2017)

Certified 1 \$3.35 (USPS Certified Mail #) (70150640000158832655)

Return Receipt 1 \$2.75 (USPS Return Receipt #) (9590940220736132026961)

Bill #: 840-58520028-4-1691414-2

Clerk: 02

Registered No. **RE322399075US** Date Stamp **APACHE JUN JUL 13 2017**

To Be Completed By Post Office	Postage \$ \$2.24	Extra Services & Fees (continued)
	Extra Services & Fees	<input type="checkbox"/> Signature Confirmation
	<input type="checkbox"/> Registered Mail \$ \$11.70	<input type="checkbox"/> Signature Confirmation Restricted Delivery
	<input type="checkbox"/> Return Receipt (hardcopy) \$ \$2.75	
	<input type="checkbox"/> Return Receipt (electronic) \$ \$0.00	Total Postage & Fees \$ \$16.69
	<input type="checkbox"/> Restricted Delivery \$ _____	Customer Must Declare Full Value \$ \$0.00
Received by 07/13/2017 RWS		Domestic insurance up to \$50,000 is included based upon the declared value. International indemnity is limited. (See Reverse).

OFFICIAL USE
APACHE JUNCTION, AZ 85120

FROM: Darrell James Hill
c/o 5124 East 18th Avenue,
Apache Junction, Arizona (85119)
85120

TO: Acting Director, FBI
c/o Andrew Deputy Director McCabe
WASHINGTON, DC 20535
J. Edgar Hoover Building
935 Pennsylvania Avenue NW
Washington, District of Columbia 20535-3000

PS Form 3806, Registered Mail Receipt April 2015, PSN 7530-02-000-9051
Copy 1 - Customer (See Information on Reverse)
For domestic delivery information, visit our website at www.usps.com

Registered No. **RE322399089US** Date Stamp **8666-07158 8130 8130 8130 JUL 13 2017**

To Be Completed By Post Office	Postage \$ \$2.03	Extra Services & Fees (continued)
	Extra Services & Fees	<input type="checkbox"/> Signature Confirmation
	<input type="checkbox"/> Registered Mail \$ \$11.70	<input type="checkbox"/> Signature Confirmation Restricted Delivery
	<input type="checkbox"/> Return Receipt (hardcopy) \$ \$2.75	
	<input type="checkbox"/> Return Receipt (electronic) \$ \$0.00	Total Postage & Fees \$ \$16.48
	<input type="checkbox"/> Restricted Delivery \$ _____	Customer Must Declare Full Value \$ \$0.00
Received by 07/13/2017 RWS		Domestic insurance up to \$50,000 is included based upon the declared value. International indemnity is limited. (See Reverse).

OFFICIAL USE
APACHE JUNCTION, AZ 85120

FROM: Darrell James Hill
c/o 5124 East 18th Avenue,
Apache Junction, Arizona (85119)
85120

TO: Michael E. Horowitz, IC-DOJ,
WASHINGTON, DC 20535
1425 New York Avenue, N.W., Suite 7100
Washington, District of Columbia 20530-2011

PS Form 3806, Registered Mail Receipt April 2015, PSN 7530-02-000-9051
Copy 1 - Customer (See Information on Reverse)
For domestic delivery information, visit our website at www.usps.com

Unofficial

SENDER: COMPLETE THIS SECTION

- Complete items 1, 2, and 3.
- Print your name and address on the reverse so that we can return the card to you.
- Attach this card to the back of the mailpiece, or on the front if space permits.

Article Addressed to:

Jeff AG Bezales
 c/o Kenneth A. Acting Assistant AG Bezales
 US DOJ Criminal Division
 950 Pennsylvania Avenue, NW
 Washington, District of Columbia 20530-0001



9590 9402 2073 6132 0338 46
 Article Number (Transfer from service label)
RE 322 399 058 US

S Form 3811, July 2015 PSN 7630-02-000-9053

COMPLETE THIS SECTION ON DELIVERY

A. Signature *Early Lane* Agent Addressee

B. Received by (Printed Name) *Early Lane* C. Date of Delivery *JUL 24 2017*

D. Is delivery address different from item 1? Yes No
 If YES, enter delivery address below:

3. Service Type
- Adult Signature
 - Adult Signature Restricted Delivery
 - Certified Mail®
 - Certified Mail Restricted Delivery
 - Collect on Delivery
 - Collect on Delivery Restricted Delivery
 - Insured Mail
 - Insured Mail Restricted Delivery (over \$500)
 - Priority Mail Express®
 - Registered Mail™
 - Registered Mail Restricted Delivery
 - Return Receipt for Merchandise
 - Signature Confirmation™
 - Signature Confirmation Restricted Delivery

Domestic Return Receipt

SENDER: COMPLETE THIS SECTION

- Complete items 1, 2, and 3.
- Print your name and address on the reverse so that we can return the card to you.
- Attach this card to the back of the mailpiece, or on the front if space permits.

Article Addressed to:

Elizabeth A. Strango, Acting USA
 Two Renaissance Square
 40 N. Central Avenue, Suite 1200
 Phoenix, Arizona 85004-4408



9590 9402 2073 6132 0269 61
 Article Number (Transfer from service label)
7015 0640 0001 5883 2655

S Form 3811, July 2015 PSN 7630-02-000-9053

COMPLETE THIS SECTION ON DELIVERY

A. Signature *Early Lane* Agent Addressee

B. Received by (Printed Name) *Early Lane* C. Date of Delivery *JUL 24 2017*

D. Is delivery address different from item 1? Yes No
 If YES, enter delivery address below:

3. Service Type
- Adult Signature
 - Adult Signature Restricted Delivery
 - Certified Mail®
 - Certified Mail Restricted Delivery
 - Collect on Delivery
 - Collect on Delivery Restricted Delivery
 - Insured Mail
 - Insured Mail Restricted Delivery (over \$500)
 - Priority Mail Express®
 - Registered Mail™
 - Registered Mail Restricted Delivery
 - Return Receipt for Merchandise
 - Signature Confirmation™
 - Signature Confirmation Restricted Delivery

Domestic Return Receipt

SENDER: COMPLETE THIS SECTION

- Complete items 1, 2, and 3.
- Print your name and address on the reverse so that we can return the card to you.
- Attach this card to the back of the mailpiece, or on the front if space permits.

Article Addressed to:

Office of International Policy
 Lewis, Chief OIP Staff
 Global Request Staff
 1425 New York Avenue, N.W., Suite 11050
 Washington, District of Columbia 20530-0001



9590 9402 2073 6132 0269 47
 Article Number (Transfer from service label)
RE 322 399 061 US

S Form 3811, July 2015 PSN 7630-02-000-9053

COMPLETE THIS SECTION ON DELIVERY

A. Signature *Early Lane* Agent Addressee

B. Received by (Printed Name) *Early Lane* C. Date of Delivery *JUL 24 2017*

D. Is delivery address different from item 1? Yes No
 If YES, enter delivery address below:

3. Service Type
- Adult Signature
 - Adult Signature Restricted Delivery
 - Certified Mail®
 - Certified Mail Restricted Delivery
 - Collect on Delivery
 - Collect on Delivery Restricted Delivery
 - Insured Mail
 - Insured Mail Restricted Delivery (over \$500)
 - Priority Mail Express®
 - Registered Mail™
 - Registered Mail Restricted Delivery
 - Return Receipt for Merchandise
 - Signature Confirmation™
 - Signature Confirmation Restricted Delivery

Domestic Return Receipt

2022-011769 MISC Page: 591 of 2782
 09/26/2022 09:35:37 PM Receipt #: 22-9381
 Rec Fee: \$30.00 Darrell James Hill
 Gila County, AZ, Sedie Jo Bingham, Recorder

593

COPIED

SENDER: COMPLETE THIS SECTION

Complete items 1, 2, and 3.
 Print your name and address on the reverse so that we can return the card to you.
 Attach this card to the back of the mailpiece, or on the front if space permits.

Article Addressed to:

Michael E. Horvath, IC-DOJ,
 IC of Investigations
 c/o Robert P. Storch, Deputy IC-DOJ
 1425 New York Avenue, N.W., Suite 7100
 Washington, District of Columbia 20530-2011

9590 9402 2073 6132 0269 85

Article Number (Transfer from service label)
 RE 322 399 089 US

COMPLETE THIS SECTION ON DELIVERY

A. Signature *Orly Lase* Agent Addressee

B. Received by (Printed Name) *JUL 24 2017* C. Date of Delivery

D. Is delivery address different from item? Yes No
 If YES, enter delivery address below:

3. Service Type
 Adult Signature Priority Mail Express®
 Adult Signature Restricted Delivery Registered Mail™
 Certified Mail® Registered Mail Restricted Delivery
 Certified Mail Restricted Delivery Return Receipt for Merchandise
 Collect on Delivery Signature Confirmation™
 Collect on Delivery Restricted Delivery Signature Confirmation Restricted Delivery
 Insured Mail Insured Mail Restricted Delivery (over \$500)

S Form 3811, July 2015 PSN 7530-02-000-9053 Domestic Return Receipt

SENDER: COMPLETE THIS SECTION

Complete items 1, 2, and 3.
 Print your name and address on the reverse so that we can return the card to you.
 Attach this card to the back of the mailpiece, or on the front if space permits.

Article Addressed to:

Artley E. Brown, FBI
 c/o Andrea, Deputy Director McCabe
 c/o David, Assoc. Dep. Dir. Ewardich
 1 Edgar Hoover Building
 935 Pennsylvania Avenue NW
 Washington, District of Columbia 20535-3000

9590 9402 2073 6132 0269 78

Article Number (Transfer from service label)
 RE 322 399 075 US

COMPLETE THIS SECTION ON DELIVERY

A. Signature *JAT / OS 2/2/17* Agent Addressee

B. Received by (Printed Name) C. Date of Delivery

D. Is delivery address different from item? Yes No
 If YES, enter delivery address below:

3. Service Type
 Adult Signature Priority Mail Express®
 Adult Signature Restricted Delivery Registered Mail™
 Certified Mail® Registered Mail Restricted Delivery
 Certified Mail Restricted Delivery Return Receipt for Merchandise
 Collect on Delivery Signature Confirmation™
 Collect on Delivery Restricted Delivery Signature Confirmation Restricted Delivery
 Insured Mail Insured Mail Restricted Delivery (over \$500)

S Form 3811, July 2015 PSN 7530-02-000-9053 Domestic Return Receipt

SENDER: COMPLETE THIS SECTION

Complete items 1, 2, and 3.
 Print your name and address on the reverse so that we can return the card to you.
 Attach this card to the back of the mailpiece, or on the front if space permits.

Article Addressed to:

Mark, Sheriff Lamb
 Pinal County Sheriff's Office
 971 Juan Lopez Cir., Building C
 Pinal, Arizona 85132

9590 9402 2073 6132 0269 92

Article Number (Transfer from service label)
 RE 322 399 092 US

COMPLETE THIS SECTION ON DELIVERY

A. Signature *CMC Bink* Agent Addressee

B. Received by (Printed Name) *CMC Bink* C. Date of Delivery

D. Is delivery address different from item? Yes No
 If YES, enter delivery address below:

3. Service Type
 Adult Signature Priority Mail Express®
 Adult Signature Restricted Delivery Registered Mail™
 Certified Mail® Registered Mail Restricted Delivery
 Certified Mail Restricted Delivery Return Receipt for Merchandise
 Collect on Delivery Signature Confirmation™
 Collect on Delivery Restricted Delivery Signature Confirmation Restricted Delivery
 Insured Mail Insured Mail Restricted Delivery (over \$500)

S Form 3811, July 2015 PSN 7530-02-000-9053 Domestic Return Receipt

594

COPY

2022-011769 MISC Page: 592 of 2782
 09/26/2022 03:35:37 PM Receipt #: 22-9381
 Rec Fee: \$30.00 Darrell James Hill
 Gila County, Az, Sadie Jo Bingham, Recorder

USPS Tracking® Results

FAQs > (<http://faq.usps.com/?articleId=220900>)

Track Another Package +

Tracking Number: 9590940220736132027005

Remove X

Pre-Shipment

See Available Actions

Product & Tracking Information

Postal Product:
First-Class Mail®

Features:
Return Receipt
USPS Tracking®

See tracking for related item: ~~RE322389044US~~
(/go/TrackConfirmAction?Labels=RE322389044US)

DATE & TIME	STATUS OF ITEM	LOCATION
July 13, 2017, 3:30 pm	Return Receipt Associated	
The U.S. Postal Service has received electronic notification on July 13, 2017 at 3:30 pm that you have associated a return receipt to your item.		

See More v

Available Actions

Text Updates

Request Text Tracking to receive a text message when your package moves throughout the USPS network.

Message frequency is based on the request type; packages may have up to 11 tracking events.

Standard Message and Data rates may apply.

For additional information, text **HELP** to 2USPS (28777). You may opt out by texting **STOP** to 2USPS.

Read more about Text Tracking (<https://www.usps.com/texttracking>)>

- Delivery or Delivery attempt
Select "Delivery or Delivery attempt" to get Text Updates for each delivery attempt.



USPS Tracking® Results

FAQs > (<http://faq.usps.com/?articleId=220900>)

[Track Another Package +](#)

Remove X

Tracking Number: RE322399044US



Delivered

Product & Tracking Information

[See Available Actions](#)

Postal Product: First-Class Mail®
Features: Registered Mail™

See tracking for related item: 9590940220736132027005
(</go/TrackConfirmAction?tLabels=9590940220736132027005>)

DATE & TIME	STATUS OF ITEM	LOCATION
July 25, 2017, 4:12 am	Delivered	WASHINGTON, DC 20500
Your item was delivered at 4:12 am on July 25, 2017 in WASHINGTON, DC 20500.		
July 20, 2017, 4:56 am	Arrived at Unit	WASHINGTON, DC 20066
July 16, 2017, 3:24 am	Arrived at USPS Facility	BALTIMORE, MD 21233
July 14, 2017, 12:08 am	Departed USPS Facility	PHOENIX, AZ 85026

[See More](#) ▾

Available Actions

2022-011769 MISC Page: 594 of 2782
 09/26/2022 03:35:37 PM Receipt #: 22-9381
 Rec Fee: \$30.00 Darrell James Hill
 Gila County, Az, Sadie Jo Bingham, Recorder



07/28/2017 06:03 PM

596

UNOFFICIAL COPY



U.S. Department of Justice
Office of Information Policy
Suite 11050
1425 New York Avenue, NW
Washington, DC 20530-0001

Telephone: (202) 514-3642

July 31, 2017

Mr. Darrell James Hill
5124 East 18th Avenue
Apache Junction, AZ 85119

Re: DOJ-2017- 005548 (OIP)
VRB:VAV:MWM

Dear Mr. Hill:

This responds to your letter received in this Office on July 24, 2017. This response is made on behalf of the Office of Information Policy.

Your letter has been received by the Office of Information Policy (OIP) of the United States Department of Justice, which processes Freedom of Information Act (FOIA) and Privacy Act (PA) requests for records it maintains as well as records maintained by the Offices of the Attorney General, Deputy Attorney General, Associate Attorney General, Public Affairs, Legislative Affairs, and Legal Policy. OIP also adjudicates administrative appeals of denials of FOIA/PA requests made to the Department. This Office maintains the case files for the initial requests and administrative appeals it processes.

Please be advised that the FOIA provides a right of access to federal agency records that exist and can be located in federal agency files. The FOIA does not require agencies to conduct research for you, to analyze data, to answer questions, or to create new records in response to a FOIA request. Moreover, the FOIA does not apply to records that are maintained by states, counties, or cities, or by the legislative or judicial branches of the government. As such, the FOIA is not a means to provide correspondence to the Department of Justice. You may write to the Department at the following:

Department of Justice
950 Pennsylvania Avenue
Washington, DC 20530

You may wish to consult the Department of Justice's online Action Center, available at <http://www.justice.gov/>, which provides information on how to contact the Department for various purposes, including to submit a complaint, report a crime, or to find a form.

You may contact our FOIA Public Liaison at the telephone number listed above for any further assistance and to discuss any aspect of your request. Additionally, you may contact the Office of Government Information Services (OGIS) at the National Archives and Records Administration to inquire about the FOIA mediation services they offer. The contact information for OGIS is as follows: Office of Government Information Services, National Archives and Records Administration, Room 2510, 8601 Adelphi Road, College Park,

597

2022-011769 MISC Page: 595 of 2782
09/26/2022 03:35:37 PM Receipt #: 22-9381
Rec Fee: \$30.00 Darrell James Hill
Gila County, Az, Sadie Jo Bingham, Recorder



Maryland 20740-6001; email at ogis@nara.gov; telephone at 202-741-5770; toll-free at 1-877-684-6448; or facsimile at 202-741-5769.

If you are not satisfied with my response to this request, you may administratively appeal by writing to the Director, Office of Information Policy, United States Department of Justice, Suite 11050, 1425 New York Avenue, NW, Washington, DC 20530-0001, or you may submit an appeal through OIP's FOIAonline portal at <https://foiaonline.regulations.gov/foia/action/public/home>. Your appeal must be postmarked or electronically transmitted within ninety days of the date of my response to your request. If you submit your appeal by mail, both the letter and the envelope should be clearly marked "Freedom of Information Act Appeal."

Sincerely,



Vanessa R. Brinkmann
Senior Counsel

Unofficial

598

2022-011769 MISC Page: 596 of 2782

09/26/2022 03:35:37 PM Receipt #: 22-9381

Rec Fee: \$30.00 Darrell James Hill

Gila County, Az, Sadie Jo Bingham, Recorder



599

U.S. Department of Justice

OIP/NYAV-T1050

Washington, D.C. 20530

Official Business

Penalty for Private Use \$300

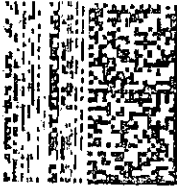

US OFFICIAL MAIL
\$300 FIM
For Private Use

USPS455057570

07/31/2017
Mailed From 20530
US POSTAGE

He

651989974 R016

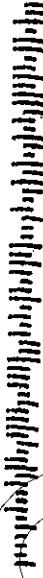

Official Copy

2022-011769 MISC Page: 597 of 2782

09/26/2022 03:35:37 PM Receipt #: 22-9381

Rec Fee: \$30.00 Darrell James Hill

Gila County, Az, Sadie Jo Bingham, Recorder



APACHE JUNCTION
 151 W SUPERSTITION BLVD
 APACHE JUNCTION
 AZ
 85120-9998
 0302590130
 08/21/2017 (800)275-8777 2:45 PM

Product Description	Sale Qty	Final Price
---------------------	----------	-------------

First-Class Mail	1	\$2.24
Large Envelope (Domestic)		
(PHOENIX, AZ 85004)		
(Weight: 0 Lb 6.10 Oz)		
(Expected Delivery Day)		
(Wednesday 08/23/2017)		

Certified	1	\$3.35
-----------	---	--------

(@USPS Certified Mail #)
 (7015064000158832709)
 Return Receipt
 (9590940220736132033914)

First-Class Mail	1	\$2.03
------------------	---	--------

Large Envelope (Domestic)
 (WASHINGTON, DC 20530)
 (Weight: 0 Lb 6.00 Oz)
 (Expected Delivery Day)
 (Thursday 08/24/2017)

Certified	1	\$3.35
-----------	---	--------

(@USPS Certified Mail #)
 (70150640000158832716)
 Return Receipt
 (9590940220736132033907)

First-Class Mail	1	\$2.03
------------------	---	--------

Large Envelope (Domestic)
 (WASHINGTON, DC 20500)
 (Weight: 0 Lb 6.00 Oz)
 (Expected Delivery Day)
 (Thursday 08/24/2017)

Certified	1	\$3.35
-----------	---	--------

(@USPS Certified Mail #)
 (70150640000158832686)
 Return Receipt
 (9590940220736132033341)

Total \$24.60

Cash \$25.60

Change (\$1.00)

Text your tracking number to 28777

**U.S. Postal Service™
 CERTIFIED MAIL® RECEIPT**
 Domestic Mail Only

For delivery information, visit our website at www.usps.com®

WASHINGTON DC 20530

Certified Mail Fee \$3.35

Extra Services & Fees (check box, add fee as appropriate)

Return Receipt (hardcopy) \$0.00

Return Receipt (electronic) \$0.00

Certified Mail Restricted Delivery \$0.00

Adult Signature Required \$0.00

Adult Signature Restricted Delivery \$0.00

Postage \$2.03

Total Postage and Fees \$8.13

0130
 07

Postmark
 Here

08/21/2017

Sent To **Jeff: U.S. AG Sessions**
 Street and Apt. **950 Pennsylvania Avenue, NW**
 City, State, ZIP **Washington, District of Columbia 20530-0001**

PS Form 3800, April 2015 PSN 7530-02-000-9047 See Reverse for Instructions

9122 E985 T000 0490 5102

Unofficial Copy

2022-011769 MISC Page: 598 of 2782

09/26/2022 03:35:37 PM Receipt #: 22-9381

Rec Fee: \$30.00 Darrell James Hill

Gila County, Az, Sadie Jo Bingham, Recorder



SENDER COMPLETE THIS SECTION

COMPLETE THIS SECTION ONLY IF NECESSARY

Complete items 1, 2, and 3.
 ■ Print your name and address on the reverse so that we can return the card to you.
 ■ Attach this card to the back of the mailpiece, or on the front if space permits.

A. Signature: *Carol Lass* Agent Addressee
 X
 B. Received by (Printed Name): _____ C. Date of Delivery: **AUG 29 2011**

1. Article Addressed to:

D. Is delivery address different from item 1? Yes No
If YES, enter delivery address below: _____

Jeff U.S. AG Seals
950 Pennsylvania Avenue, NW
Washington, District of Columbia 20530-0001



 9590 9402 2073 6132 0339 07

3. Service Type
 Signature Mail Priority Mail Express®
 Signature Restricted Delivery Registered Mail™
 Certified Mail® Registered Mail Restricted Delivery
 Certified Mail Restricted Delivery Return Receipt for Merchandise
 Collect on Delivery Signature Confirmation™
 Signature Confirmation Restricted Delivery
 Insured Mail Restricted Delivery (over \$500)

2. Article Number: **7015 0640 0001 5883 2716**

PS Form 3811, July 2015 PSN 7530-02-000-9068 Domestic Return Receipt

USPS TRACKING #



9590 9402 2073 6132 0339 07

United States Postal Service

First-Class Mail
Postage & Fees Paid
USPS
Permit No. G-10

• Sender: Please print your name, address, and ZIP+4® in this box•

Darrell James Hill
 c/o P.O. Box 3806/
 Apache Junction, Arizona
 85120-3806

Unofficial Copy

2022-011769 MISC Page: 599 of 2782
 09/26/2022 03:35:37 PM Receipt #: 22-9381
 Rec Fee: \$30.00 Darrell James Hill
 Gila County, Az. Sadie Jo Bingham, Recorder



Darrell-James: Hill c/o P.O. Box 3806/ Apache Junction, Arizona 85120 602.618.4595
USPS CMN 7015 0640 0001 5883 2730

Mark: Arizona Attorney General BRNOVICH
1275 West Washington Street
Phoenix, Arizona 85007-2926

USPS CMN 7015 0640 0001 5883 2723

Mark: Sheriff Lamb
Pinal county Sheriff Office
971 Jason Lopez Cir., Building C
Florence, Arizona 85132

USPS CMN 7015 0640 0001 5883 2730

Re: NOTICE AND DEMANDs attached; to U.S. government Administrators reinforcing my interest by the "Affidavit: Proof of Claim" that I did also sent to you - See Affidavit: Gila county Recorder: gilacountyaz.gov/recorder/web/ : Doc. # 2017-006522 – received by you on or about July 2017

Mark. B and Mark L., Greetings:

i am a man of the non-political aggregate, an inhabitant in Arizona state, and write you because 1) you are Chief Law Enforcement Officers for protection of people in the county area i inhabit, and 2) because i have made claim for my rights protected under the Constitution for the United States of America- 1787 here under the protection of the Arizona state Constitution. Note: i am not subject to the 1863 Lieber Code- martial law.

i have enclosed my NOTICE AND DEMAND Cover Sheet correspondences to a) Donald- POTUS TRUMP – USPS CMN 7015 0640 0001 5883 2686 - respondeat superior for the U.S. government criminal subordinate state actors; b) Jeff, US DOJ Attorney General SESSIONS – USPS CMN 7015 0640 0001 5883 2716; and, c) Elizabeth, Ariz. U.S. Attorney STRANGE – USPS CMN 7015 0640 0001 5883 2709. See Enclosure One, 3 pages. These documents persist my request starting in September 2016 that the Executive Branch actors immediately protect and support my rights-asserted and guaranteed.

Because of the nature of my demand for my property and rights, U.S. Government-state agents may seek your support in aide of their deprivation of my rights-guaranteed-protection by the Constitution for the United States of America/ U.S. Constitution. Therefore, i must assure you receive this notification regarding the context of my contact with the Executive Branch, et al.: agencies, employees, actors, agents, assigns or assets.

Sincerely;

Darrell-James: Hill
Living Soul, one of the common people of the
united States of America L.S.

602
Notice to Mark: Pinal county Sheriff LAMB AUG 222017 USPS CMN 7015 0640 0001 5883 2730

1/2

2022-011769 MISC Page: 600 of 2782
09/26/2022 03:35:37 PM Receipt #: 22-9381
Rec Fee: \$30.00 Darrell James Hill
Gila County, Az, Sadie Jo Bingham, Recorder



Darrell-James: Hill c/o P.O. Box 3806/ Apache Junction, Arizona 85120 602.618.4595
USPS CMN 7015 0640 0001 5883 2730

Unofficial Copy

603

- ENCLOSURE ONE:**
NOTICE AND DEMAND Cover Sheets to:
- a) Donald- POTUS TRUMP –
USPS CMN 7015 0640 0001 5883 2686
 - b) Jeff, US DOJ Attorney General SESSIONS –
USPS CMN 7015 0640 0001 5883 2716
 - c) Elizabeth, Ariz. U.S. Attorney STRANGE –
USPS CMN 7015 0640 0001 5883 2709
3 pages

Notice to Mark: Pinal county Sheriff LAMB AUG 222017 USPS

2022-011769 MISC Page: 601 of 2782
09/26/2022 03:35:37 PM Receipt #: 22-9381
Rec Fee: \$30.00 Darrell James Hill
Gila County, Az, Sadie Jo Bingham, Recorder



Darrell-James: Hill c/o P.O. Box 3806/ Apache Junction, Arizona 85120
USPS CMN 7015 0640-0001 5883 2686

Donald: POTUS TRUMP
The White House
1600 Pennsylvania Avenue NW
Washington, District of Columbia 20500

NOTICE AND DEMAND

RE: "Affidavit: Proof of Claim" - See Affidavit: Gila county Recorder:
gilacountyaz.gov/recorder/web/ : Doc. # 2017-006522 - received by you July 24th, 2017 by
USPS RMN RE 322 399 044 US - See ENCLOSURE ONE, 30 pages

- NOTICE a) You Swore To Protect My Almighty-God-Given Rights By/Under The Ultimate Authority
Of The Constitution For The United States Of America; The Same Authority
- b) Proclaimed By President Lincoln In The "Emancipation Proclamation" Of 1863: I Am
- i) Protected By The Constitution For The United States Of America - 1787,
 - ii) Not Subject To Martial Law/Lieber Code - 1863,
 - iii) Forever Free From Slavery; The Same Freedom, Forever
 - iv) Secured By The Executive Government, Including The Military And Naval Authorities

DEMAND I Call Upon You To Immediately Protect And Support All Of My Rights

Donald, Greetings:

i sent you, Respondeat Superior, et al., my "Affidavit: Proof of Claim" - See ENCLOSURE ONE -
declaring the criminal actions of your subordinates' deprivation of my Constitutionally-protected rights.

NOTICE: The systemic deprivations of my rights imposed by your criminal subordinates are now
tantamount to your aiding criminal wrongdoings against me under all American law systems.

DEMAND: Righteously serve; finally correct the unlawful Constitutional matters. Do Not Presume
that i am subject to martial law rule. i am Not. As indicated in the Emancipation Proclamation by Presidential
predecessor, Abraham, POTUS Lincoln, my rights are directly and unambiguously protected under the
Constitution for the United States of America, and are Not subject to corporate presumptions, for ever.

I wish/ history wams for you to righteously promote, protect, ensure and establish my rights. There Is No
Way to Justify Unrighteous Half Measures of Depriving Me of My Property and Rights. The Same Corruption In
The Beginning Of This Nation To Enslave The Few And Humbled Resulted In All Now Being Legally Sustained
Under A System Of Martial Law Rule And/Or Slavery Since 1863: All Except The Southern Slaves Who Were
Proclaimed Legally Freed From All Bondage Forever.

See my mailing address change in the header.

Sincerely;

Darrell-James: Hill
Living Soul, one of the common people of the
united States of America L.S.

604
Notice to Donald, POTUS, AUG 212017 USPS CMN 7015 0640 0001 5883 2686

1/2

2022-011769 MISC Page: 602 of 2782
09/26/2022 03:35:37 PM Receipt #: 22-9381
Rec Fee: \$30.00 Darrell James Hill
Gila County, Az, Sadie Jo Bingham, Recorder



Darrell-James: Hill c/o P.O. Box 3806/ Apache Junction, Arizona 85120

USPS CMN 7015 0640 0001 5883 2716

Jeff: US Attorney General SESSIONS
U.S. DOJ
950 Pennsylvania Avenue, NW
Washington, District of Columbia 20530-0001

NOTICE AND DEMAND

RE: "Affidavit: Proof of Claim" - See Affidavit: Gila county Recorder:
gilacountyaz.gov/recorder/web/ : Doc. # 2017-006522 - received by you on or about July 24th,
2017 by USPS RMN RE 322 399 058 US - See ENCLOSURE ONE, 30 pages.

NOTICE a) You Swore To Protect My Almighty-God-Given Rights By/Under The Ultimate Authority
Of The Constitution For The United States Of America; The Same Authority
b) Proclaimed By President Lincoln In The "Emancipation Proclamation" Of 1863: I Am
i) Protected By The Constitution For The United States Of America - 1787,
ii) Not Subject To Martial Law/Lieber Code - 1863,
iii) Forever Free From Slavery; The Same Freedom, Forever
iv) Secured By The Executive Government, Including The Military And Naval Authorities

DEMAND I Call Upon You To Immediately Protect And Support All Of My Rights

Jeff, Greetings:

i sent your Respondeat Superior, et al., my "Affidavit: Proof of Claim" - See ENCLOSURE ONE--
declaring the criminal actions of state agents' deprivation of my Constitutionally-protected rights.

NOTICE: The systemic deprivations of my rights imposed by criminal subordinates are now
tantamount to your aiding criminal wrongdoings against me under all American law systems.

DEMAND: Righteously serve; finally correct the unlawful Constitutional matters. Do Not Presume
that i am subject to martial law rule. i am Not. As indicated in the Emancipation Proclamation by Presidential
predecessor, Abraham, POTUS Lincoln, my rights are directly and unambiguously protected under the
Constitution for the United States of America, and are Not subject to corporate presumptions, for ever.

I wish/ history warns for you to righteously promote, protect, ensure and establish my rights. There Is No
Way to Justify Unrighteous Half Measures of Depriving Me of My Property and Rights. The Same Corruption In
The Beginning Of This Nation To Enslave The Few And Humbled Resulted In All Now Being Legally Sustained
Under A System Of Martial Law Rule And/Or Slavery Since 1863: All Except The Southern Slaves Who Were
Proclaimed Legally Freed From All Bondage Forever.

See my mailing address change in the header.

Sincerely;

Darrell-James Hill
Living Soul, one of the common people of the
united States of America L.S.

605
Notice to Jeff, DOJ ATTY GEN, AUG 21 2017 USPS CMN 7015 0640 0001 5883 2716

1/2

2022-011769 MISC Page: 603 of 2782
09/26/2022 03:35:37 PM Receipt #: 22-9381
Rec Fee: \$30.00 Darrell James Hill
Gila County, Az, Sadie Jo Bingham, Recorder



Darrell-James: Hill c/o P.O. Box 3806/ Apache Junction, Arizona 85120
USPS CMN 7015 0640 0001 5883 2709

Elizabeth: Acting U.S. Atty Strange
Two Renaissance Square
40 North Central Ave, Ste 1200
Phoenix, Arizona 85004-4408

NOTICE AND DEMAND

RE: "Affidavit: Proof of Claim" - See Affidavit: Gila county Recorder:
gilacountyaz.gov/recorder/web/ : Doc. # 2017-006522 - received by you on or about July 18th,
2017 by USPS CMN 7015 0640 0001 5883 2655 - See ENCLOSURE ONE, 30 pages

- NOTICE
- a) You Swore To Protect My Almighty-God-Given Rights By/Under The Ultimate Authority Of The Constitution For The United States Of America; The Same Authority
 - b) Proclaimed By President Lincoln In The "Emancipation Proclamation" Of 1863: i Am
 - i) Protected By The Constitution For The United States Of America - 1787,
 - ii) Not Subject To Martial Law/Lieber Code - 1863,
 - iii) Forever Free From Slavery; The Same Freedom, Forever
 - iv) Secured By The Executive Government, Including The Military And Naval Authorities

DEMAND i Call Upon You To Immediately Protect And Support All Of My Rights

Elizabeth, Greetings:

i sent your Respondeat Superior, et al., my "Affidavit: Proof of Claim" - See ENCLOSURE ONE--
declaring the criminal actions of state agents' deprivation of my Constitutionally-protected rights.

NOTICE: The systemic deprivations of my rights imposed by criminal subordinates are now
tantamount to your aiding criminal wrongdoings against me under all American law systems.

DEMAND: Righteously serve; finally correct the unlawful Constitutional matters. Do Not Presume
that i am subject to martial law rule. i am Not. As indicated in the Emancipation Proclamation by Presidential
predecessor, Abraham, POTUS Lincoln, my rights are directly and unambiguously protected under the
Constitution for the United States of America, and are Not subject to corporate presumptions, for ever.

I wish/ history warns for you to righteously promote, protect, ensure and establish my rights. There Is No
Way to Justify Unrighteous Half Measures of Depriving Me of My Property and Rights. The Same Corruption In
The Beginning Of This Nation To Enslave The Few And Humbled Resulted In All Now Being Legally Sustained
Under A System Of Martial Law Rule And/Or Slavery Since 1863: All Except The Southern Slaves Who Were
Proclaimed Legally Freed From All Bondage Forever.
See my mailing address change in the header.

Sincerely;

Darrell-James: Hill
Living Soul, one of the common people of the
united States of America L.S.

Notice to Elizabeth, US ATTY GEN AZ, AUG 212017 USPS CMN 7015 0640 0001 5883 2709

2022-011769 MISC Page: 604 of 2782
 09/26/2022 03:35:37 PM Receipt #: 22-9381
 Rec Fee: \$30.00 Darrell James Hill
 Gila County, Az, Sadie Jo Bingham, Recorder



U.S. Postal Service™
CERTIFIED MAIL® RECEIPT
 Domestic Mail Only

For delivery information, visit our website at www.usps.com®.

PHOENIX, AZ 85007
OFFICIAL USE

Certified Mail Fee	\$3.35
Extra Services & Fees (check box, add fee as appropriate)	\$0.00
<input type="checkbox"/> Return Receipt (hardcopy)	\$0.00
<input type="checkbox"/> Return Receipt (electronic)	\$0.00
<input type="checkbox"/> Certified Mail Restricted Delivery	\$0.00
<input type="checkbox"/> Adult Signature Required	\$0.00
<input type="checkbox"/> Adult Signature Restricted Delivery	\$0.00
Postage	\$0.70
Total Postage and Fees	\$4.05

0130
07

Postmark
Here

08/23/2017

Sent To **Mark: Arizona Attorney General BRNOVICH**
 Street and A₁ **1275 West Washington Street**
 City, State, Z **Phoenix, Arizona 85007-2926**

PS Form 3800, April 2015 PSN 7530-02-000-9047 See Reverse for Instructions

U.S. Postal Service™
CERTIFIED MAIL® RECEIPT
 Domestic Mail Only

For delivery information, visit our website at www.usps.com®.

FLORENCE, AZ 85132
OFFICIAL USE

Certified Mail Fee	\$3.35
Extra Services & Fees (check box, add fee as appropriate)	\$0.00
<input type="checkbox"/> Return Receipt (hardcopy)	\$0.00
<input type="checkbox"/> Return Receipt (electronic)	\$0.00
<input type="checkbox"/> Certified Mail Restricted Delivery	\$0.00
<input type="checkbox"/> Adult Signature Required	\$0.00
<input type="checkbox"/> Adult Signature Restricted Delivery	\$0.00
Postage	\$0.49
Total Postage and Fees	\$3.84

0130
07

Postmark
Here

08/23/2017

Sent To **Mark: Sheriff Lamb**
 Street and **Pinal county Sheriff Office**
971 Jason Lopez Cir, Building C
 City, State, **Florence, Arizona 85132**

PS Form 3800, April 2015 PSN 7530-02-000-9047 See Reverse for Instructions

APACHE JUNCTION
 151 W SUPERSTITION BLVD
 APACHE JUNCTION

AZ
 85120-9998
 0302590130

08/23/2017 (800)275-8777 10:22 AM

Product Description	Sale Qty	Final Price
First-Class Mail Letter (Domestic)	1	\$0.49

(FLORENCE, AZ 85132)
 (Weight: 0 Lb 1.00 Oz)
 (Expected Delivery Day)
 (Friday 08/25/2017)
 Certified 1 \$3.35
 (@@USPS Certified Mail #)
 (70150640000158832730)
 First-Class Mail Letter (Domestic) 1 \$0.70
 (PHOENIX, AZ 85007)
 (Weight: 0 Lb 1.10 Oz)
 (Expected Delivery Day)
 (Friday 08/25/2017)
 Certified 1 \$3.35
 (@@USPS Certified Mail #)
 (70150640000158832723)

Total \$7.89
 Cash \$20.00
 Change (\$12.11)

Text your tracking number to 28777 (2USPS) to get the latest status. Standard Message and Data rates may apply. You may also visit USPS.com, USPS Tracking or call 1-800-222-1811.

In a hurry? Self-service kiosks offer quick and easy check-out. Any Retail Associate can show you how.



609

7015 0640 0001 5883 2723
 7015 0640 0001 5883 2730

Darrell- James: Hill, aggrieved man, c/o PO Box 3806, Apache Junction, Arizona 85120
USPS CMN 7015 0640 0001 5883 2679

Sidney; acting as Chief Judge, Chairman;
Richard; acting as Circuit Judge;
Susan; acting as Senior District Judge;
Judicial Council Executive Committee
c/o Office of Executive Committee
P.O. Box 193939
San Francisco, California [94119-3939]

RECEIVED
MOLLY C. DWYER, CLERK
U.S. COURT OF APPEALS

AUG 24 2017

FILED	DOCKETED	DATE	INITIAL

**SECOND NOTICE WITH DEMAND:
TO 9th CIRCUIT EXECUTIVE COMMITTEE
REPORTING CRIMINAL SUBORDINATES' DEPRIVATION
OF THE AGGRIEVED'S RIGHTS UNDER COLOR OF LAW**

Sidney, Richard, Susan: Greetings;

i: man¹ am Darrell- James: Hill who reported to you by USPS Registered Mail with RR, RMN RE 322 399 234 US, delivered to you on May 1st, 2017, criminal wrongdoings and the wrong-doers under your supervision and authority. - See Enclosure One: "Jurat Affidavit- Notice: 9th Circuit Trespass Upon Fundamental and Substantive Rights, and Common-Law-Claim Rights Under Color-of-Law, 6 pages.

i have not received response from you on this critical matter re: unLawful and illegal activities reported to you: Nor has effect of protection/ support of my rights been advanced to me by your subordinates to revert their deprivation of my rights protected by the Constitution for the United States of America, which is your duty and oath of obligation to me. Regarding same, see "AFFIDAVIT: PROOF OF CLAIM:": Gila County Recorder, gilacountyaz.gov, DOC. 2017-006522; July 7th, 2017. See excerpt:

AFFIDAVIT²: PROOF OF CLAIM:

A.R.S. 11-480(D): Gila County Recorder – Doc. Num: 2017-002378

Darrell- James: House of Hill, aggrieved party
c/o 5124 East 18th Avenue
Apache Junction, Arizona
Zip Code Exempt, Non-Domestic

Declaration³ In Claim⁴ Against⁵ Criminal⁶ Wrong-Doings⁷

- 1 i: man means: a) a flesh and blood man-kind understanding Almighty God of Abraham of the Holy Bible, and a sovereign one who in a collective capacity with others sovereigns are the people of the United States of America over-standing the government for the United States of America; b) NOT a cestui que trust, corporation, or other fictitious entity; c) NOT a US citizen; d) Not an inhabitant of a federal area See at Gila County Recorder – site:
<http://recorder.gilacountyaz.gov/recorder/web/> Document Number: 2017-002378, pg 199-217 Affidavit
- 2 Affidavit means: "No more than [affidavits are] necessary to make the Prima facie case." U.S. v. Kis, 658 F. 2nd 526
- 3 declaration means: The first of the pleadings on the part of the plaintiff in an action at law, being a formal and methodical specification of the facts and circumstances constituting his cause of action.
- 4 claim means: a challenge of property or ownership of a thing which is wrongfully withheld from the possession of the claimant. Plowd. 359. A claim is a right or title, actual or supposed, to a debt privilege or other thing in the possession of another,.... 2 N. Y. 245, 254[;] Bouvier's Law Dictionary, 1st Ed, p. 209.
- 5 Against means: in opposition to, adverse, hostile; in an opposite direction or position
- 6 criminal means: pertaining to crime: an act committed in violation of a law prohibiting it, or [an omission] in violation of a law ordering

USPS CMN: 7015 0640 0001 5883 2679 – 2ND Notice to Ninth Jud Coun Exec Com: Sidney, Richard, Susan 1/5

2022-011769 MISC Page: 606 of 2782
09/26/2022 03:35:37 PM Receipt #: 22-9381
Rec Fee: \$30.00 Darrell James Hill
Gila County, Az, Sadia Jo Bingham, Recorder



By State Party⁹ Agents⁹
Of The United States¹- Department Of Justice¹⁰, "DOJ", And
Of The 9th Circuit Court Administration¹¹:

Of Deprivation¹² Of My Inalienable¹³ Fundamental¹⁴ And Natural Rights^{15, 16}
and Freedoms guaranteed¹⁷ Protected¹⁸: By (a) The Constitution¹⁹ For The United
States²⁰ Of America²¹ People²², 1787, "Const.-1787", (b) The Bill Of Rights²³, 1789- 1791,
"BORights-1789-91", and (c) The "International Covenant²⁴ On Civil²⁵ And Political²⁶
Rights²⁷", "ICCPR", Treaty Ratified By The Senate In 1992²⁸, "ICCPR Treaty";

- it... 2. extreme violation of the law; wrongdoing of a criminal nature, as felony or treason, which affects the whole public and not just the rights of an individual: distinguished from misdemeanor. Webster's New 20th Century Unabridged, 2nd Ed., p. 431.
- 7 wrong-doing: that which is improper or unjust actions
 - 8 State Party means: all The Federal, State And Local Government Entities
 - 9 State Party Agents means: all The Federal, State And Local Government's agents or doers otherwise who perform for the State Party directly, or through proxy
 - 10 National Executive Branch- Department Of Justice, "DOJ" means: Loretta Lynch, et al., et seq. Jeffrey S.: All State Party Agents of the DOJ System having knowledge and/or participation, aiding or abetting
 - 11 9th Circuit Court Administration means: All State Party Agents of the 9th Circuit Court System having knowledge and/or participation, aiding or abetting
 - 12 deprivation means: to entirely take away
 - 13 inalienable means: that which cannot be transferred or surrendered, such as an inalienable right: means: A right that cannot be transferred or surrendered, a natural right such as the right to own property. Not subject to statutory manipulation.
 - 14 fundamental means: "One's right to life, liberty, and property, to free speech, a free press, freedom of worship and assembly, and other fundamental rights may not be submitted to vote; they depend on the outcome of no elections[.]" West Virginia Bd. of Ed. v. Barnette, 319 U.S. 624, 638, 63 S.Ct. 1178, 87 L.Ed. 1628 (1943).
- fundamental law means: The law which determines the constitution of government in a state, and prescribes and regulates the manner of its exercise; the organic law of a state; the constitution.
- 15 natural rights means: those rights that is conceived as part of natural law and that is therefore thought to exist independently of rights created by government or society, such as the right to life, liberty, and property, which grow out of the nature of man and depend upon personality, as distinguished from such as are created by law and depend upon civilized society; or they are those which are plainly assured by natural law (Borden v. State, 11 Ark. 519, 44 Am.Dec. 217); ...[.] Black's Law Dictionary, 4th Ed., p1487. natural law means: A physical law of nature, ie.gravity, property.
 - 16 rights means: what someone deserves; a just claim, what is morally due; the property of life, liberty and property sacred to one and wholly set aside for private use.
 - 17 guaranteed means: held in surety for that the obligation due under covenant must be performed
 - 18 protect means: to, in advance to defend and guard
 - 19 Constitution means: the Constitution for the United States of America, 1787, "Const.-1787", generally also making inclusive reference to the BORights-1789-91.
 - 20 United States means: one must be cognizant and clear about the usage of the term which means: [1] It may be merely the name of a sovereign occupying the position analogous to that of other sovereigns in the family of nations. [2] It may designate the territory over which the sovereignty of the United States extends, or [3] it may be the collective name of the states which are united by and under the constitution. [.] in the nature of Hooven & Allison Co. vs. Evatt, 324 U.S. 652
 - 21 United States of America means: the people of the united States of America
 - 22 people means: the word "people" may have various significations according to the connection in which it is used. When we speak of the rights of the people, or of the government of the people by law, or of the people as a non-political aggregate, we mean all the inhabitants of the state or nation, without distinction as to sex, age, or otherwise. But when reference is made to the people as the repository of sovereignty, or as the source of governmental power, or to popular government, we are in fact speaking of that selected and limited class of citizens to whom the constitution accords the elective franchise and the rights of participation in the offices of government. Black. Const. Law 3d Ed., p. 30[.] Black's Law Dictionary, 4th Ed., p1292. repository means: a person to whom something is entrusted or confided; ...[.] Webster's New 20th Century Unabridged, 2nd Ed., p. 1535.
 - 23 BORights means: "... THE Conventions of a number of the States, having at the time of their adopting the Constitution, expressed a desire, in order to prevent misconstruction or abuse of its powers, that further declaratory and restrictive clauses should be added; And as extending the ground of public confidence in the Government, will best ensure the beneficent ends of its institution; RESOLVED by the Senate and House or Representatives of the United States of America, in congress assembled,... Articles, which when ratified*..., to be valid to all intents and purposes, as part of the said Constitution; *The first ten Amendments (BORights) were ratified effective December 15, 1791.

USPS CMN: 7015 0640 0001 5883 2679 - 2ND Notice to Ninth Jud Coun Exec Com: Sidney, Richard, Susan 2/5

2022-011769 MISC Page: 607 of 2782
09/26/2022 03:35:37 PM Receipt #: 22-9381
Rec Fee: \$30.00 Darrell James Hill
Gila County, Az, Sadie Jo Bingham, Recorder



Of Deprivations imposed²⁹ Against Me By Men, United States Government Agents, Wrong-Doers Against "Public Policy"³⁰

For The Exercise³¹ Of My Rights To Secure "Property-Claimed"³² And To A Common Law^{33 34} With Trial³⁵-By-Jury³⁶ At The United States District Court³⁷-, "USDC", Arizona, Phoenix: To Wit: "In The Hill Court; A 'Federal Court' At The USDC-Arizona, Phoenix : Claimant Case³⁸ No: CMN 7009 1410 0000 7868 5703³⁹" ...

[The] Framers intended for the first ten amendments to act as restraints only upon the exercise of power by the new, national government....
Alabama Educ. Assn v. Bentley, 788 F.Supp.2d 1283.

As Justice Robert H. Jackson once wrote, [t]he very purpose of a Bill of Rights was to withdraw certain subjects from the vicissitude* of political controversy, to place them beyond the reach of majorities 775 and officials and to establish them as legal principles to be applied by the courts. One's right to life, liberty, and property, to free speech, a free press, freedom of worship and assembly, and other fundamental rights may not be submitted to vote; they depend on the outcome of no elections[.] West Virginia Bd. of Ed. v. Barnette, 319 U.S. 624, 638, 63 S.Ct. 1178, 87 L.Ed. 1628 (1943); see e.g. Weinberger v. Wiesenfeld, 420 U.S. 636, 638 n. 2, 95 S.Ct. 1225, 43 L.Ed.2d 514 (1975) (stating that the right to equal protection is incorporated within the Fifth Amendment's Due Process Clause).

vicissitude* means: change or variation occurring irregularly in the course of something; especially, change of circumstances in life; ups and downs of fortune. Webster's New 20th Century Unabridged, 2nd (1983), p. 2036

- 24 covenant means: [A contractual] agreement, convention, or promise of two or more parties, by deed in writing, signed, sealed, and delivered, by which either of the parties pledges himself to the other that something is either done or shall be done or stipulates for the truth of certain facts[.] in the nature of Commonwealth v. Robinson, 1 Watts, Pa. 160; et seq. Black's Law Dictionary, 4th Ed., p. 436.
- 25 civil means: Originally, pertaining or appropriate to a member of a civitas or free political community; natural or proper to a citizen. Also, relating to the community, or to the policy and government of the citizens and subjects of a state. Black's Law Dictionary, 4th Ed., p. 311.
- 26 political means: polity: The form of government; civil constitution.
- 27 International Covenant on Civil and Political Rights means: the covenant adopted and opened for signature, ratification and accession by General Assembly resolution 2200A (XXI) of 16 December 1966 entry into force 23 March 1976, in accordance with Article 49, "ICCPR".
- 28 ICCPR Treaty ratification 1992 means: "U. S. reservations, declarations, and understandings, International Covenant on Civil and Political Rights, 138 Cong. Rec. S4781-01 (daily ed, April 2, 1992) - IX. TEXT OF RESOLUTION OF RATIFICATION . See Exhibit One.
- 29 impose means: inflict by force or authority
- 30 Public Policy means: the community common sense and common conscience extended and applied throughout the state to matter of public morals, public health, public safety, public welfare, and the like; it is the general and well-settled public opinion relating to man's plain, palpable duty to his fellow men having due regard to all the circumstances of each particular relation and situation[.] in the nature of Pittsburgh, c. c. & St. L. Ry. Co. v. Kianey, 95 Ohio St. 64, et seq. Public policy properly cognizable by courts is that derived or derivable by clear implication from its Constitution, statutes, and judicial decisions[.] in the nature of Brown v. American Ry. Express Co., 128 S.C. 428, et seq.; Black's Law Dictionary, 4th Ed, p. 1318.
- 31 exercise means: to make use of. Thus, to exercise a right or power is to do something which it enables the holder to do[.] in the nature of U.S. v. Souders, 27 Fed. Cas. 1267, et seq.; Black's Law Dictionary, 4th Ed, p. 682.
- 32 Initial Claim means: filing for court of record common law claim with trial by jury to decide matters of both fact and law: NOTICE: CLAIM RE: Property disposed.... See at Gila County Recorder - site: <http://recorder.gilacountyaz.gov/recorder/web/> Document Number: 2017-002378, pp. 241-549 .
- 33 common law means: 1. As distinguished from the Roman law, the modern civil law, the canon law and other systems, the common law is that body of law and juristic theory which was originated, developed and formulated ...[.] in the nature of Lux v. Haggin, 69 Cal. 255, et seq. As distinguished from law created by enactment of legislatures, the common law comprises the body of those principles and rules of action, relating to the government and security of persons and property, which derive their authority solely from usages and customs of immemorial antiquity, or from the judgments and decrees of the courts recognizing, affirming, and enforcing such usages and customs; and, in this sense particularly the ancient unwritten law of England[.] in the nature of 1 Kent, Comm. 492. Western Union Tel. Co. v. Call Pub. Co., 21 S. Ct. 561, et seq.; Black's Law Dictionary, 4th Ed., pp. 345-346.
- 34 law means: all the rules of conduct established and enforced by the authority, legislation, or custom of a given community or other group.... Law implies a penalty or inconvenience for disobedience, and also generality of application as distinguished from a special command.... Webster's 20th Century Unabridged, 2nd Ed., p. 1028.
- 35 trial means: a judicial examination, in accordance with law of the land, of a cause, either civil or criminal, of the issues between the parties, whether of law or fact, before a court that has jurisdiction over it[.] in the nature of People v. Vitale, 364 Ill, 589, et seq.; Black's Law Dictionary, 4th Ed., p. 1675.
- 36 trial-by-jury means: the terms "jury" and "trial by jury" as used in the constitution, means twelve competent men, disinterested and impartial, not of kin, nor personal dependents of either or the parties, having their homes within the jurisdictional limits of the court, drawn

USPS CMN: 7015 0640 0001 5883 2679 - 2ND Notice to Ninth Jud Coun Exec Com: Sidney, Richard, Susan 3/5

2022-011769 MISC Page: 608 of 2782
09/26/2022 03:35:37 PM Receipt #: 22-9381
Rec Fee: \$30.00 Darrell James Hill
Gila County, Az, Sadie Jo Bingham, Recorder



Darrell- James: Hill, aggrieved man, c/o PO Box 3806, Apache Junction, Arizona 85120

USPS CMN 7015 0640 0001 5883 2679

i man am not subject to martial law rules, AND i have simply required upon you to fulfill your oath, duty and obligation to this man's rights protected by the Constitution for the United States of America by the US Constitution to ensure you protect my rights asserted and exercised. Yet, at this signing, it is evident that you have enabled your criminal subordinates' trespasses against me be condoned.

I require you to Not proceed in fraud; i want my Common-Law-Claim filed and proceeding with no further abuse against me.

i, say here, and will verify in open court, that all herein be true.

Darrell James: Hill

August 18th, 2017

INTENTIONALLY LEFT BLANK

and selected ..., duly impaneled and sworn [to determine the matters of fact and law] to render a true verdict according to the law [and] evidence[;] in the nature of: Black's Law Dictionary, 4th Ed., p. 993.

37 court means: *International Law*: The person and suite of the sovereign; the place where the sovereign sojourns with his regal retinue, wherever that may be. retinue means: group of followers, state of service; literally, that which is retained.

38 case means: "trespass on the case". trespass on the case means: At common law, an action to recover damages that are not the immediate result of a wrongful act but rather a later consequence; Black's Law 7th Ed, p. 1508-9 .

39 Claimant Case No: CMN 7009 1410 0000 7868 5703 means: In the *Hill Court*; a 'Federal Court' at the USDC- Arizona, Phoenix: January 04, 2017 -- USPS RMN RE 322 399 336 US; rec'd 01/04/2017. See 'Notice: PROOF OF CLAIM' at Gila County Recorder -- site: <http://recorder.gilacountyaz.gov/recorder/web/> Document Number: 2017-002378, pp. 182-693 .

611
USPS CMN: 7015 0640 0001 5883 2679 -- 2ND Notice to Ninth Jud Coum Exec Com: Sidney, Richard, Susan 4/5

2022-011769 MISC Page: 609 of 2782

09/26/2022 03:35:37 PM Receipt #: 22-9381

Rec Fee: \$30 00 Darrell James Hill

Gila County, Az, Sadie Jo Bingham, Recorder



Darrell- James: Hill, aggrieved man, c/o PO Box 3806, Apache Junction, Arizona 85120

USPS CMN 7015 0640 0001 5883 2679

**“Jurat Affidavit- Notice:
9th Circuit Trespass Upon Fundamental and Substantive Rights,
and Common-Law-Claim Rights Under Color-of-Law,**

ENCLOSURE ONE:

6 pages.

612
USPS CMN: 7015 0640 0001 5883 2679 – 2ND Notice to Ninth Jud Coum Exec Com: Sidney, Richard, Susan 5/5

2022-011769 MISC Page: 610 of 2782
09/26/2022 03:35:37 PM Receipt #: 22-9381
Rec Fee: \$30.00 Darrell James Hill
Gila County, Az, Sadie Jo Bingham, Recorder



Darrell- James: Hill, aggrieved man¹
 c/o 5142 East 18th Avenue
 Apache Junction, Arizona ZIP CODE EXEMPT
 without the US Inc. [85119]

Sidney; acting as Chief Judge, Chairman;
 Richard; acting as Circuit Judge;
 Susan; acting as Senior District Judge;
 Judicial Council Executive Committee
 c/o Office of Executive Committee
 P.O. Box 193939
 San Francisco, California 94119-3939

Jurat Affidavit- Notice²:
9th Circuit Trespass Upon Fundamental and Substantive Rights³,
and Common-Law-Claim⁴ Rights Under Color-of-Law⁵

Sidney, Richard, Susan: Greetings;

i: man am writing: because i filed a Common-Law-Claim, "claim", for suit into the federal court in Phoenix, Arizona for an amount in controversy greater than 20 dollars in property-forfeited-to-me⁶. And, administratively, i must make you aware of the destruction⁷ of my rights violations surrounding that case because Ranier and Brian, the Chief Judge- USDC-AZ and the Clerk of Court- USDC-AZ, respectively, are involved in the groups' wrong-doings destroying my claim. And, finally, because you are

- 1 i: man means: a) a flesh and blood man-kind understanding Almighty God of Abraham of the Holy Bible, and a sovereign one who in a collective capacity with others sovereigns are the people of the United States of America over-standing the government for the United States of America; b) NOT a cestui que trust, corporation, or other fictitious entity; c) NOT a US citizen; d) Not an inhabitant of a federal area See at Gila County Recorder – site: <http://recorder.gilacountyaz.gov/recorder/web/> Document Number: 2017-002378, pg 199-217 Affidavit
- 2 notify (v), notice means: to point out information, intelligence, knowledge; formal warning
- 3 fundamental-and-substantive-rights means: a) those inalienable rights from Almighty God inherent to nature and man, the right to protect them, and to the world stewardship, life, liberty and property. b) See Gila County Recorder – <http://recorder.gilacountyaz.gov/recorder/web/> Document Number: 2017-002378, pg 684-690. c) See: Declaration of Independence (1776) re: the Constitution for the United States of America (1787), Amendments VII, IX, and X (1789) d) "... [W]hile powers are delegated to the agencies of government, sovereignty itself remains with the people, by whom and for whom all government exists and acts." – Yick Wo v. Hopkins.
- 4 Common-Law-Claim means: a claim brought by a man, the facts and law determined by a jury and/or by a judge. Section I: See at Gila County Recorder – site: <http://recorder.gilacountyaz.gov/recorder/web/> Document Number: 2017-002378, pg 184-584.
- 5 color-of-law means: appearance of truth, likelihood, validity, or right; justification; an initially apparent or prima-facie right; a sufficient warrant for action; as, color of title. See: Gila County Recorder – site: <http://recorder.gilacountyaz.gov/recorder/web/> Document Number: 2017-002378, pg 193. subscript 12.
- 6 property means: a thing privately owned and set aside for private and exclusive use. See at Gila County Recorder – site: <http://recorder.gilacountyaz.gov/recorder/web/> Document Number: 2017-002378, pg 240-549.
- 7 destruction (n.) destroy means: tear down, lay waste, ravage

USPS RMN: RE 322 399 234 US - Jurat Notice to Ninth Jud Coun Exec Com: Sidney, Richard, Susan 1/4

2022-011769 MISC Page: 611 of 2782
 09/26/2022 03:35:37 PM Receipt #: 22-9381
 Rec Fee: \$30.00 Darrell James Hill
 Gila County, Az, Sadie Jo Bingham, Recorder



the only next responsible party in the 9th Circuit Court for addressing the harm and loss i allege, i want my Common-Law-Claim filed and proceeding with no abuse actions against me.

Section I: Offenders: the Group

For nearly four months, beginning January 04, 2017, my Claim has been destroyed by an employee- "group"⁸ within the 9th, Circuit United States District Court⁹, "USDC", Phoenix, Arizona. As explained below under Section III, the group's disregard for my fundamental-and-substantive-rights, rather than the protection of my rights, is a violation against¹⁰ the sovereign people, "people" – the same United-States-of-America-people giving rise to the government for the United States, the United States government, "USgov", and under it, the inferior-courts.

Section II: The Contract

Understanding Almighty God, the people of the United States formed-the-Constitution¹¹ for the people of the United States, under which the USgov was delegated authority¹² to serve: to establish statutory¹³ judicial rules and inferior courts¹⁴. To wit:

a) No statute, and No code, and No rule on any level of the USgov may exceed the Constitutional limits of authority delegated to it by the people; b) The people are forever sovereign over the USgov. And, c) the USgov is forever bound by the Constitution contract: to understand the limits, duties, and obligations of the authorization enabled it. This is common knowledge in fact and in public records.

Section III: Breach of Contract

i presented a claim for filing suit with trial-by-jury¹⁵, for the recovery of my property re: "Hill v Lynch" **In The Hill Court; 'A Federal Court'**

at 'District Court of the united States
for Phoenix Arizona', U.S.A.

Claimant Case No: CMN 7009 1410 0000 7868 5703 "

The USDC- Phoenix assigned Case No. CV-17-00026-PHX-BSB.

But, my Common-Law-Claim presentment was Not filed for suit as ordered. Instead, the group, at the USDC- Phoenix Clerk of Court, et al.: 1) changed¹⁶ the court¹⁷, 2) changed the trial-by-jury, and 3)

8 employee- "group" means: a) Ranier, acting as Chief Judge and b) Brian, acting as Clerk of Court, (c) et al. employees under Ranier/ Brian: USDC-Ariz., Phoenix

9 USDC means: an inferior court under the authority of the government for the United States of America

10 against means: in opposition to, adverse, hostile

11 formed-the-Constitution means: "We the people of the United States, in Order to form a more perfect Union, ... do ordain and establish this Constitution for the United States of America." Constitution for the United States of America, 1787: preamble.

12 authority means: formal approval or sanction given; authorization

13 statutory (adj.) statute means: any law enacted under the Constitutional contract

14 Inferior courts means: "The Congress shall have power to ... constitute Tribunals inferior to the supreme Court[.] Constitution for the United States of America, 1787: Art. I, sect.8, cl. 9. In example, 9th Circuit Court is an inferior court.

15 trial by jury, try by jury means: judicial examination of the facts/ law of a matter by the jury, a set of people selected to try a matter and render a verdict ~ USDC- Phx No. CV-17-00026-PHX-BSB. Doc 1 - See at Gila County Recorder – site: <http://recorder.gilacountyaz.gov/recorder/web/> Document Number: 2017-002378, pg 607-642. notice; Status:

16 change means: to substitute a one thing for another, so to make the first thing other than what it was.

17 court means: the functional context and purpose for a judicial assembly; "In The Hill Court; 'A Federal Court'" for a Common Law Claim ~ Doc 1 - See at Gila County Recorder – site:

<http://recorder.gilacountyaz.gov/recorder/web/> Document Number: 2017-002378, pg 657: Case Summary, et seq.

6/14



changed the jurisdiction¹⁸: 3a) without¹⁹ my counsel, 3b) with No-authorization²⁰, and 3c) without jurisdiction; then, they 4) did not issue summons; and, 5) a month later wrote ostensibly²¹ that they would not issue summons unless I agreed to substitute their jurisdiction. Neither the USgov nor an inferior court under it has authorization from the people in the Constitutional contract to impose²² wanton abrogation²³ of fundamental or substantive or common law rights upon the people (upon i: man). To this, any and all presumption of authority for the group's any changes to my claim has been expressly denied²⁴.

Section IV: Intent and Damage

The Arizona group implemented an obscure²⁵ color-of-law scheme using 'rules' and standard-operating-procedure²⁶ with No authority under the USgov to systematically- deprive²⁷ the people of their (i: man of my) fundamental, substantive, and common law rights. The record reflects that the group ostensibly sought to obtain jurisdiction over my claim by willful deception and coercion.

At minimum the group members exceeded the USgov Constitutional authority, and did harm and cause loss upon i: man, and with regard to the trespass-upon-the-case²⁸ of the Common-Law-Claim for suit for an amount in controversy greater than twenty dollars. See Constitution (1787); Bill-of-Rights²⁹ (1789), Amendment VII³⁰, IX³¹ and X³².

Section V: Restoration

Despite my good faith efforts and admonishment, even the conspicuous "compensation due"

18 **Jurisdiction: trial by jury** means: ~ USDC- Phx No. CV-17-00026-PHX-BSB. Doc 1 -

See at Gila County Recorder -- site: <http://recorder.gilacountyaz.gov/recorder/web/> Document Number: 2017-002378, pg 585-587: ORDER; pg 596-599: notice: Rules of Court; pg 607-642: notice: Status:; pg 643- :

NOTICE: (g): pg 665- : Notice: To Magistrate

19 **without** means: outside of; lacking

20 **No-authorization** means: No formal approval or sanction or "authority" given

21 **ostensibly** means: capable of being shown

22 **impose** means: inflict by force or authority

23 **abrogation (n), abrogate** means: abolish by authoritative activities

24 **denied** means: refused, rejected, NOT true

25 **obscure** means: hidden, covert

26 **standard operating procedure** means: a set of step-by-step instructions compiled by an organization for help workers carry out routine operations.

27 **systematically- deprive** means: racketeering, by group criminal conduct

28 **trespass-upon-the-case** means: a) "Notice to Officers of the Court", et seq.: USDC- Phx No. CV-17-00026-PHX-BSB. Doc 1. See: Gila County Recorder -- site: <http://recorder.gilacountyaz.gov/recorder/web/> Document Number: 2017-002378, pg 192; b) "notice: Status; Clerks' non-Supply of Summon" pp. 607-642.

29 **Bill-of-Rights** means: "... [I]n order to prevent misconstruction or abuse of its powers [] further declaratory and restrictive clauses should be added: ARTICLES in addition to, and Amendment of the Constitution of the United States of America..."

30 **Amendment VII** means: "Article the ninth In Suits at common law, where the value in controversy shall exceed twenty dollars, the right of trial by jury shall be preserved...." Constitution for the United States of America, 1787; Bill of Rights, 1789.

31 **Amendment IX** means: "Article the eleventh The enumeration in the Constitution, of certain rights, shall not be construed to deny or disparage others retained by the people." Constitution for the United States of America, 1787; Bill of Rights, 1789.

32 **Amendment X** means: "Article the twelfth The powers not delegated to the United States by the Constitution, nor prohibited by it to the States, are reserved to the States respectively, or to the people." Constitution for the United States of America, 1787; Bill of Rights, 1789.

USPS RMN: RE 322 399 234 US - Jurat Notice to Ninth Jud Coun Exec Com: Sidney, Richard, Susan 3/4

2022-011769 MISC Page: 613 of 2782

09/26/2022 03:35:37 PM Receipt #: 22-9381

Rec Fee: \$30.00 Darrell James Hill

Gila County, Az, Sadie Jo Bingham, Recorder



agreeance³³ -on default³⁴ upon any trespass-upon-the-case, the group members persisted to impose a deprivation of rights scheme or scam against i: man, one of the people. Therefore, upon your receipt of this notice i require³⁵ that: a) this deprivation of rights in breach of Constitutional contract in all its forms of trespass-upon-the-case must be ceased and desisted hereto-forever post haste; b) my Common-Law-Claim presentments must hereto-forever be filed as ordered; c) This deprivation of rights must No longer be permitted; and, d) i: man must be made whole³⁶. I would want to know so to repair the wrong-doings occurring under my oath, authority, duty and obligation, and reputation.

Section VI: Conclusion

There is No USgov authority nor inferior court authority under the USgov for the protection³⁷ of the group's wrong-doings against i: man's (against the people's) inalienable rights or substantive rights or rights to common law claim. The group members knew or should have known that this deprivation of rights by any USgov subordinate was NEVER supposed to be imposed or allowed to happen to the people (to i: man) of the United States of America. And,

This deprivation of rights against the people (i: man) hereto-forever must Not ever be tolerated.

i, say here, and will verify in open court, that all herein be true.

Darrell-James: Hill
April 27th, 2017

Jurat

State of Arizona
County of Pinal

On this 27th day of April 2017, before me present is Darrell-James: Hill whose identity was proven to me on the basis of satisfactory evidence of an State of Arizona Driver License to be the Authorized Representative claimed: Signed and affirmed before me this 27th day of April, 2017;

Notary Public

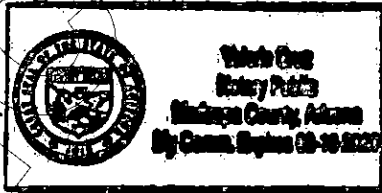

33 agreeance means: the action of consent, assent. The group members all acquiesced to the compensation due upon their actions; agreeance - by default in trespass-upon-the-case.

34 default means: to put wrong

35 require means: a demanding of that which is necessary and proper and critical for proceeding upon a right

36 made whole means: compensation-due; fees for common law filing returned

37 protection means: defend, assist, shelter



6/16

Registered No. RE322399234US

Date Stamp 0130 07

To Be Completed By Post Office	Postage \$ \$0.70	Extra Services & Fees (stranded)
	Extra Services & Fees	<input type="checkbox"/> Signature Confirmation
	<input type="checkbox"/> Registered Mail \$ \$12.50	\$
	<input type="checkbox"/> Return Receipt (hardcopy) \$ \$2.75	<input type="checkbox"/> Signature Confirmation Restricted Delivery
	<input type="checkbox"/> Return Receipt (electronic) \$ \$0.00	\$
<input type="checkbox"/> Restricted Delivery \$	Total Postage & Fees \$ \$15.95	
Customer Must Declare Full Value \$ \$10.00	Received by 04/27/2017	Domestic Insurance up to \$50,000 is included based upon the declared value. International Indemnity is limited. (See Reverse).

APACHE JUNCTION
 151 W SUPERSTITION BLVD
 APACHE JUNCTION
 AZ
 85120-9998
 0302590130
 (800)275-8777 3:17 PM
 04/27/2017

Product Description	Sale Qty	Final Price
First-Class Mail Letter (Domestic) (SAN FRANCISCO, CA 94119) (Weight: 0 Lb 1.20 Oz) (Expected Delivery Day) (Monday 05/01/2017)	1	\$0.70
Registered (Amount: \$10.00) (@@USPS Registered Mail #) (RE322399234US)	1	\$12.50
Return Receipt (@@USPS Return Receipt #) (9590940220736132026930)	1	\$2.75

OFFICIAL USE

To Be Completed By Customer (Please Print) All Entries Must Be In Ballpoint or Typed	FROM	Darrell James Hill, approved man c/o 5142 East 16 th Avenue Apache Junction, Arizona ZIP CODE EXEMPT without the US Inc. (85119) 85120
	TO	Sidney, acting as Chief Judge, Chairman; Richard, acting as Circuit Judge; San Francisco Superior Court Judge; Judicial Council Executive Committee c/o Office of Executive Committee P.O. Box 191919 San Francisco, California 94119-3919

PS Form 3806, Registered Mail Receipt
 April 2015, PSN 7530-02-000-9051
 For domestic delivery information, visit our website at www.usps.com
 Copy 1 - Customer (See Information on Reverse)

Total \$15.95
 Cash \$50.00
 Change (\$34.05)

In a hurry? Self-service kiosks offer quick and easy check-out. Any Retail Associate can show you how.

Text your tracking number to 28777 (2USPS) to get the latest status. Standard Message and Data rates may apply. You may also visit USPS.com USPS Tracking or call 1-800-222-1811.

 BRIGHTEN SOMEONE'S MAILBOX. Greeting cards available for purchase at select Post Offices.

6/17



Track Another Package +

Remove X

Tracking Number: RE322399234US

Delivered

Expected Delivery Day: Monday, May 1, 2017 ⓘ
Product & Tracking Information

See Available Actions

Postal Product:
First-Class Mail®

Features:
Registered Mail™
Return Receipt

See tracking for related item: 9590940220738132026930
([/go/TrackConfirmAction?Labels=9590940220738132026930](#))

DATE & TIME	STATUS OF ITEM	LOCATION
May 1, 2017, 1:53 pm	Delivered, Left with Individual	SAN FRANCISCO, CA 94103
Your item was delivered to an individual at the address at 1:53 pm on May 1, 2017 in SAN FRANCISCO, CA 94103.		
May 1, 2017, 11:26 am	Available for Pickup	SAN FRANCISCO, CA 94119
May 1, 2017, 11:25 am	Arrived at Unit	SAN FRANCISCO, CA 94105
May 1, 2017, 12:33 am	Departed USPS Facility	SAN FRANCISCO, CA 94188
April 30, 2017, 3:42 pm	In Transit to Destination	
April 29, 2017, 3:42 pm	Arrived at USPS Destination Facility	SAN FRANCISCO, CA 94188
April 28, 2017, 1:54 am	Departed USPS Facility	PHOENIX, AZ 85026
April 28, 2017, 1:52 am	Arrived at USPS Facility	PHOENIX, AZ 85026
April 27, 2017, 4:12 pm	Departed Post Office	APACHE JUNCTION, AZ 85120
April 27, 2017, 3:15 pm	Acceptance	APACHE JUNCTION, AZ 85120



7025 0640 0001 5883 2679

U.S. Postal Service™
CERTIFIED MAIL® RECEIPT
Domestic Mail Only

For delivery information visit our website at www.usps.com

UNOFFICIAL USE

Certified Mail Fee	\$3.35
Extra Services & Fees (check box, add fee)	\$2.75
<input type="checkbox"/> Return Receipt (hardcopy)	\$0.00
<input type="checkbox"/> Return Receipt (electronic)	\$0.00
<input type="checkbox"/> Certified Mail Restricted Delivery	\$0.00
<input type="checkbox"/> Adult Signature Required	\$0.00
<input type="checkbox"/> Adult Signature Restricted Delivery	\$0.00

0130
01

Postmark
Here

Postage \$0.91

08/18/2017

Total Postage and Fees \$7.01

Sent To: *Shirley, acting as Chief Judge, Chairman, Nichols, acting as Circuit Judge, Brown, acting as Senior District Judge, Judicial Council Executive Committee*
 Street and Apt: *aka Office of Executive Committee*
 City, State, Zip: *P.O. Box 193939 San Francisco, California 94119-3939*

PS Form 3800, April 2015 PSN 7530-02-000-9001 See Reverse for Instructions

APACHE JUNCTION
 151 W SUPERSTITION BLVD
 APACHE JUNCTION
 AZ

85120-9998
 0302590130

08/18/2017 (800)275-8777 1:26 PM

Product Description	Sale Qty	Final Price
---------------------	----------	-------------

First-Class Mail Letter (Domestic)	1	\$0.49
(FORT GEORGE G MEADE, MD 20755)		
(Weight: 0 Lb 0.60 Oz)		
(Expected Delivery Day)		
(Monday 08/21/2017)		
Registered	1	\$12.50
(Amount: \$21.00)		
((USPS Registered Mail #)		
(R322399129US)		

Return Receipt	1	\$2.75
((USPS Return Receipt #)		
(9590940220736132033877)		

First-Class Mail Letter (Domestic)	1	\$0.70
(BALTIMORE, MD 21235)		
(Weight: 0 Lb 1.20 Oz)		
(Expected Delivery Day)		
(Monday 08/21/2017)		

Certified	1	\$3.35
((USPS Certified Mail #)		
(70150640000158832693)		

First-Class Mail Letter (Domestic)	1	\$0.91
(SAN FRANCISCO, CA 94119)		
(Weight: 0 Lb 2.30 Oz)		
(Expected Delivery Day)		
(Monday 08/21/2017)		

Certified	1	\$3.35
((USPS Certified Mail #)		
(70150640000158832679)		

Return Receipt	1	\$2.75
((USPS Return Receipt #)		
(9590940220736132033884)		

Total \$26.80

Cash \$27.00
 Change (\$0.20)

In a hurry? Self-service kiosks offer quick and easy check-out. Any Retail Associate can show you how.

UNOFFICIAL USE

619



**UNITED STATES COURT OF APPEALS
FOR THE NINTH CIRCUIT
P.O. Box 193939
95 Seventh Street
San Francisco, CA. 94119-3939**

August 30, 2017

Darrell-James:Hill
c/o P.O. Box 3806
Apache Junction, AZ 85120

Dear Mr. Hill:

We received your recent correspondence to the court. The documents did not include a case number, and we were unable to find any relevant cases pending in our court. The correspondence also did not claim to be a new petition over which this court has jurisdiction, and we have found no basis to treat it as a new petition. We are therefore returning the correspondence to you.

For any future communications with the court, please be aware:

All communications should be addressed to the Clerk and not to specific judges. *See* 9th Cir. R. 25-2.

All filings must include this court's case number on the first page, or clearly state the filing is a new petition within this court's jurisdiction.

This court's jurisdiction is defined by federal statute. The court cannot review state court decisions. The court can decide appeals from final orders and certain interlocutory orders of the Ninth Circuit's federal district courts and Bankruptcy Appellate Panel. The court can also decide petitions for review or enforcement of orders by various federal agencies, and certain petitions for writs of mandamus and prohibition.

The court's rules and procedures can be found at www.ca9.uscourts.gov.

Sample forms can be found at <http://www.ca9.uscourts.gov/forms>.

620

2022-011769 MISC Page: 618 of 2782
09/26/2022 03:35:37 PM Receipt #: 22-9381
Rec Fee: \$30.00 Darrell James Hill
Gila County, Az, Sadie Jo Bingham, Recorder



• A pro se application for authorization to file a second or successive 28 U.S.C. § 2254 habeas petition or § 2255 motion must include Form 12, available at <http://cdn.ca9.uscourts.gov/datastore/uploads/forms/form12.pdf>.

• Instructions for filing a judicial misconduct complaint are available at http://www.ce9.uscourts.gov/misconduct/judicial_misconduct.html.

• The court is unable to accept filings that are not written in English.

Sincerely,

Joseph Williams
Deputy Clerk

Unofficial

621

2022-011769 MISC Page: 619 of 2782
09/26/2022 03:35:37 PM Receipt #: 22-9381
Rec Fee: \$30.00 Darrell James Hill
Gila County, Az, Sadie Jo Bingham, Recorder



Darrell- James: Hill, aggrieved man, c/o PO Box 3806, Apache Junction, Arizona 85120
USPS CMN 7015 0640 0001 5883 2679

Sidney; acting as Chief Judge, Chairman;
Richard; acting as Circuit Judge;
Susan; acting as Senior District Judge;
Judicial Council Executive Committee
c/o Office of Executive Committee
P.O. Box 193939
San Francisco, California [94119-3939]

RECEIVED
MOLLY C. DWYER, CLERK
U.S. COURT OF APPEALS

AUG 24 2017

FILED
DOCKETED
DATE
INITIAL

**SECOND NOTICE WITH DEMAND:
TO 9th CIRCUIT EXECUTIVE COMMITTEE
REPORTING CRIMINAL SUBORDINATES' DEPRIVATION
OF THE AGGRIEVED'S RIGHTS UNDER COLOR OF LAW**

Sidney, Richard, Susan: Greetings;

i: man' am Darrell- James: Hill who reported to you by USPS Registered Mail with RR, RMN RE 322 399 234 US, delivered to you on May 1st, 2017, criminal wrongdoings and the wrong-doers under your supervision and authority. - See Enclosure One: "Jurat Affidavit- Notice: 9th Circuit Trespass Upon Fundamental and Substantive Rights, and Common-Law-Claim Rights Under Color-of-Law, 6 pages.

i have not received response from you on this critical matter re: unLawful and illegal activities reported to you: Nor has effect of protection/ support of my rights been advanced to me by your subordinates to revert their deprivation of my rights protected by the Constitution for the United States of America, which is your duty and oath of obligation to me. Regarding same, see "AFFIDAVIT: PROOF OF CLAIM:": Gila County Recorder, gilacountyaz.gov, DOC. 2017-006522; July 7th, 2017. See excerpt:

AFFIDAVIT: PROOF OF CLAIM:

A.R.S. 11-480(D): Gila County Recorder – Doc. Num: 2017-002378

Darrell- James: House of Hill, aggrieved party
c/o 5124 East 18th Avenue
Apache Junction, Arizona
Zip Code Exempt, Non-Domestic

Declaration³ In Claim⁴ Against⁵ Criminal⁶ Wrong-Doings⁷

- 1 i: man means: a) a flesh and blood man-kind understanding Almighty God of Abraham of the Holy Bible, and a sovereign one who in a collective capacity with others sovereigns are the people of the United States of America over-standing the government for the United States of America; b) NOT a cestui que trust, corporation, or other fictitious entity; c) NOT a US citizen; d) Not an inhabitant of a federal area See at Gila County Recorder – site: <http://recorder.gilacountyaz.gov/recorder/web/> Document Number: 2017-002378, pg 199-217 Affidavit
- 2 Affidavit means: "No more than [affidavits are] necessary to make the Prima facie case." U.S. v. Kis, 658 F. 2nd 526
- 3 declaration means: The first of the pleadings on the part of the plaintiff in an action at law, being a formal and methodical specification of the facts and circumstances constituting his cause of action.
- 4 claim means: a challenge of property or ownership of a thing which is wrongfully withheld from the possession of the claimant. Plowd. 359. A claim is a right or title, actual or supposed, to a debt privilege or other thing in the possession of another,.... 2 N. Y. 245, 254[;] Bouvier's Law Dictionary, 1st Ed, p. 209.
- 5 Against means: in opposition to, adverse, hostile; in an opposite direction or position
- 6 criminal means: pertaining to crime: an act committed in violation of a law prohibiting it, or [an omission] in violation of a law ordering

USPS CMN: 7015 0640 0001 5883 2679 – 2ND Notice to Ninth Jud Coun Exec Com: Sidney, Richard, Susan 1/5

2022-011769 MISC Page: 620 of 2782
09/26/2022 03:35:37 PM Receipt #: 22-9381
Rec Fee: \$30.00 Darrell James Hill
Gila County, Az. Sadie Jo Bingham, Recorder



622

By State Party⁸ Agents⁹
Of The United States- Department Of Justice¹⁰, "DOJ", And
Of The 9th Circuit Court Administration¹¹:

Of Deprivation¹² Of My Inalienable¹³ Fundamental¹⁴ And Natural Rights^{15 16}
and Freedoms guaranteed¹⁷ Protected¹⁸: By (a) The Constitution¹⁹ For The United
States²⁰ Of America²¹ People²², 1787, "Const.-1787", (b) The Bill Of Rights²³, 1789- 1791,
"BORights-1789-91", and (c) The "International Covenant²⁴ On Civil²⁵ And Political²⁶
Rights²⁷", "ICCPR", Treaty Ratified By The Senate In 1992²⁸, "ICCPR Treaty";

it... 2. extreme violation of the law; wrongdoing of a criminal nature, as felony or treason, which affects the whole public and not just the rights of an individual: distinguished from misdemeanor. Webster's New 20th Century Unabridged, 2nd Ed., p. 431.

7 wrong-doing: that which is improper or unjust actions

8 State Party means: all The Federal, State And Local Government Entities

9 State Party Agents means: all The Federal, State And Local Government's agents or doers otherwise who perform for the State Party directly, or through proxy

10 National Executive Branch- Department Of Justice, "DOJ" means: Loretta Lynch, et al., et seq. Jeffrey S.: All State Party Agents of the DOJ System having knowledge and/or participation, aiding or abetting

11 9th Circuit Court Administration means: All State Party Agents of the 9th Circuit Court System having knowledge and/or participation, aiding or abetting

12 deprivation means: to entirely take away

13 inalienable means: that which cannot be transferred or surrendered, such as an inalienable right: means: A right that cannot be transferred or surrendered, a natural right such as the right to own property. Not subject to statutory manipulation.

14 fundamental means: "One's right to life, liberty, and property, to free speech, a free press, freedom of worship and assembly, and other fundamental rights may not be submitted to vote; they depend on the outcome of no elections[.]" West Virginia Bd. of Ed. v. Barnette, 319 U.S. 624, 638, 63 S.Ct. 1178, 87 L.Ed. 1628 (1943).

fundamental law means: The law which determines the constitution of government in a state, and prescribes and regulates the manner of its exercise; the organic law of a state; the constitution.

15 natural rights means: those rights that is conceived as part of natural law and that is therefore thought to exist independently of rights created by government or society, such as the right to life, liberty, and property, which grow out of the nature of man and depend upon personality, as distinguished from such as are created by law and depend upon civilized society; or they are those which are plainly assured by natural law (Borden v. State, 11 Ark. 519, 44 Am.Dec. 217); ...[.] Black's Law Dictionary, 4th Ed., p1487. natural law means: A physical law of nature, ie. gravity, property.

16 rights means: what someone deserves; a just claim, what is morally due; the property of life, liberty and property sacred to one and wholly set aside for private use.

17 guaranteed means: held in surety for that the obligation due under covenant must be performed

18 protect means: to, in advance to defend and guard

19 Constitution means: the Constitution for the United States of America, 1787, "Const.-1787", generally also making inclusive reference to the BORights-1789-91

20 United States means: one must be cognizant and clear about the usage of the term which means: [1] It may be merely the name of a sovereign occupying the position analogous to that of other sovereigns in the family of nations. [2] It may designate the territory over which the sovereignty of the United States extends, or [3] it may be the collective name of the states which are united by and under the constitution. [.] in the nature of Hooven & Allison Co. vs. Ewatt, 324 U.S. 652

21 United States of America means: the people of the united States of America

22 people means: the word "people" may have various significations according to the connection in which it is used. When we speak of the rights of the people, or of the government of the people by law, or of the people as a non-political aggregate, we mean all the inhabitants of the state or nation, without distinction as to sex, age, or otherwise. But when reference is made to the people as the repository of sovereignty, or as the source of governmental power, or to popular government, we are in fact speaking of that selected and limited class of citizens to whom the constitution accords the elective franchise and the rights of participation in the offices of government. Black. Const. Law 3d Ed., p. 30[.] Black's Law Dictionary, 4th Ed., p1292. repository means: a person to whom something is entrusted or confided; ...[.] Webster's New 20th Century Unabridged, 2nd Ed., p. 1535.

23 BORights means: "... THE Conventions of a number of the States, having at the time of their adopting the Constitution, expressed a desire, in order to prevent misconstruction or abuse of its powers, that further declaratory and restrictive clauses should be added; And as extending the ground of public confidence in the Government, will best ensure the beneficent ends of its institution; RESOLVED by the Senate and House or Representatives of the United States of America, in congress assembled,... Articles, which when ratified*..., to be valid to all intents and purposes, as part of the said Constitution; *The first ten Amendments (BORights) were ratified effective December 15, 1791.

USPS CMN: 7015 0640 0001 5883 2679 -- 2ND Notice to Ninth Jud Coum Exec Com: Sidney, Richard, Susan 2/5

2022-011769 MISC Page: 621 of 2782

09/26/2022 03:35:37 PM Receipt #: 22-9381

Rec Fee: \$30.00 Darrell James Hill
Gila County, Az, Sadie Jo Bingham, Recorder



623
U

Of Deprivations imposed²⁹ Against Me By Men, United States Government Agents, Wrong-Doers Against "Public Policy"³⁰

For The Exercise³¹ Of My Rights To Secure "Property-Claimed"³² And To A Common Law^{33 34} With Trial³⁵-By-Jury³⁶ At The United States District Court³⁷-, "USDC", Arizona, Phoenix: To Wit: "In The Hill Court; A 'Federal Court' At The USDC-Arizona, Phoenix : Claimant Case³⁸ No: CMN 7009 1410 0000 7868 5703³⁹" ...

[The] Framers intended for the first ten amendments to act as restraints only upon the exercise of power by the new, national government.... Alabama Educ. Assn v. Bentley, 788 F.Supp.2d 1283.

As Justice Robert H. Jackson once wrote, [t]he very purpose of a Bill of Rights was to withdraw certain subjects from the vicissitude* of political controversy, to place them beyond the reach of majorities 775 and officials and to establish them as legal principles to be applied by the courts. One's right to life, liberty, and property, to free speech, a free press, freedom of worship and assembly, and other fundamental rights may not be submitted to vote; they depend on the outcome of no elections[.] West Virginia Bd. of Ed. v. Barnette, 319 U.S. 624, 638, 63 S.Ct. 1178, 87 L.Ed. 1628 (1943); see e.g. Weinberger v. Wiesenfeld, 420 U.S. 636, 638 n. 2, 95 S.Ct. 1225, 43 L.Ed.2d 514 (1975) (stating that the right to equal protection is incorporated within the Fifth Amendment's Due Process Clause).

vicissitude* means: change or variation occurring irregularly in the course of something; especially, change of circumstances in life; ups and downs of fortune. Webster's New 20th Century Unabridged, 2nd (1983), p. 2036

- 24 covenant means: [A contractual] agreement, convention, or promise of two or more parties, by deed in writing, signed, sealed, and delivered, by which either of the parties pledges himself to the other that something is either done or shall be done or stipulates for the truth of certain facts[.] in the nature of Commonwealth v. Robinson, 1 Watts, Pa. 160; et seq; Black's Law Dictionary, 4th Ed., p. 436.
- 25 civil means: Originally, pertaining or appropriate to a member of a civitas or free political community; natural or proper to a citizen. Also, relating to the community, or to the policy and government of the citizens and subjects of a state. Black's Law Dictionary, 4th Ed., p. 311.
- 26 political means: polity: The form of government; civil constitution.
- 27 International Covenant on Civil and Political Rights means: the covenant adopted and opened for signature, ratification and accession by General Assembly resolution 2200A (XXI) of 16 December 1966 entry into force 23 March 1976, in accordance with Article 49, "ICCPR".
- 28 ICCPR Treaty ratification 1992 means: "U. S. reservations, declarations, and understandings, International Covenant on Civil and Political Rights, 138 Cong. Rec. S4781-01 (daily ed, April 2, 1992) - IX- TEXT OF RESOLUTION OF RATIFICATION . See Exhibit One.
- 29 impose means: inflict by force or authority
- 30 Public Policy means: the community common sense and common conscience extended and applied throughout the state to matter of public morals, public health, public safety, public welfare, and the like; it is the general and well-settled public opinion relating to man's plain, palpable duty to his fellow men having due regard to all the circumstances of each particular relation and situation[.] in the nature of Pittsburgh, c. c. & St. I. Ry. Co. v. Kinney, 95 Ohio St. 64, et seq. Public policy properly cognizable by courts is that derived or derivable by clear implication from its Constitution, statutes, and judicial decisions[.] in the nature of Brown v. American Ry. Express Co., 128 S.C. 428, et seq.; Black's Law Dictionary, 4th Ed, p. 1318.
- 31 exercise means: to make use of. Thus, to exercise a right or power is to do something which it enables the holder to do[.] in the nature of U.S. v. Souders, 27 Fed. Cas. 1267, et seq.; Black's Law Dictionary, 4th Ed, p. 682.
- 32 Initial Claim means: filing for court of record common law claim with trial by jury to decide matters of both fact and law: NOTICE: CLAIM RE: Property disposed.... See at Gila County Recorder - site: <http://recorder.gilacountyaz.gov/recorder/web/> Document Number: 2017-002378, pp. 241-549 .
- 33 common law means: 1. As distinguished from the Roman law, the modern civil law, the canon law and other systems, the common law is that body of law and juristic theory which was originated, developed and formulated ...[.] in the nature of Lux v. Haggin, 69 Cal. 255, et seq. As distinguished from law created by enactment of legislatures, the common law comprises the body of those principles and rules of action, relating to the government and security of persons and property, which derive their authority solely from usages and customs of immemorial antiquity, or from the judgments and decrees of the courts recognizing, affirming, and enforcing such usages and customs; and, in this sense particularly the ancient unwritten law of England[.] in the nature of 1 Kent, Comm. 492. Western Union Tel. Co. v. Call Pub. Co., 21-S. Ct. 561, et seq.; Black's Law Dictionary, 4th Ed., pp. 345-346.
- 34 law means: all the rules of conduct established and enforced by the authority, legislation, or custom of a given community or other group... Law implies a penalty or inconvenience for disobedience, and also generality of application as distinguished from a special command.... Webster's 20th Century Unabridged, 2nd Ed., p. 1028.
- 35 trial means: a judicial examination, in accordance with law of the land, of a cause, either civil or criminal, of the issues between the parties, whether of law or fact, before a court that has jurisdiction over it[.] in the nature of People v. Vitale, 364 Ill, 589, et seq.; Black's Law Dictionary, 4th Ed., p. 1675.
- 36 trial-by-jury means: the terms "jury" and "trial by jury" as used in the constitution, means twelve competent men, disinterested and impartial, not of kin, nor personal dependents of either or the parties, having their homes within the jurisdictional limits of the court, drawn

USPS CMN: 7015 0640 0001 5883 2679 - 2ND Notice to Ninth Jud Coun Exec Com: Sidney, Richard, Susan 3/5

2022-011769 MISC Page: 622 of 2782

09/26/2022 03:35:37 PM Receipt #: 22-9381

Rec Fee: \$30.00 Darrell James Hill
Gila County, Az, Sadie Jo Bingham, Recorder



Darrell- James: Hill, aggrieved man, c/o PO Box 3806, Apache Junction, Arizona 85120

USPS CMN 7015 0640 0001 5883 2679

i man am not subject to martial law rules, AND i have simply required upon you to fulfill your oath, duty and obligation to this man's rights protected by the Constitution for the United States of America by the US Constitution to ensure you protect my rights asserted and exercised. Yet, at this signing, it is evident that you have enabled your criminal subordinates' trespasses against me be condoned.

I require you to Not proceed in fraud; i want my Common-Law-Claim filed and proceeding with no further abuse against me.

i, say here, and will verify in open court, that herein be true.

Darrell James Hill

August 18th, 2017

INTENTIONALLY LEFT BLANK

and selected ..., duly impaneled and sworn [to determine the matters of fact and law] to render a true verdict according to the law [and] evidence[.] in the nature of: Black's Law Dictionary, 4th Ed., p. 993.

37 court means: *International Law*: The person and suite of the sovereign; the place where the sovereign sojourns with his regal retinue, wherever that may be. retinue means: group of followers, state of service; literally, that which is retained.

38 case means: "trespass on the case". trespass on the case means: At common law, an action to recover damages that are not the immediate result of a wrongful act but rather a later consequence; Black's Law 7th Ed, p. 1508-9 .

39 Claimant Case No: CMN 7009 1410 0000 7868 5703 means: In the *Hill Court*; a 'Federal Court' at the USDC- Arizona, Phoenix: January 04, 2017 - USPS RMN RE 322 399 336 US; rec'd 01/04/2017. See 'Notice: PROOF OF CLAIM' at Gila County Recorder - site: <http://recorder.gilacountyaz.gov/recorder/web/> Document Number: 2017-002378, pp. 182-693 .

625
USPS CMN: 7015 0640 0001 5883 2679 - 2ND Notice to Ninth Jud Coun Exec Com: Sidney, Richard, Susen 4/5

2022-011769 MISC Page: 623 of 2782

09/26/2022 03:35:37 PM Receipt #: 22-9381

Rec Fee: \$30.00 Darrell James Hill
Gila County, Az, Sadie Jo Bingham, Recorder



Darrell- James: Hill, aggrieved man, c/o PO Box 3806, Apache Junction, Arizona 85120

USPS CMN 7015 0640 0001 5883 2679

ENCLOSURE ONE:

**"Jurat Affidavit- Notice:
9th Circuit Trespass Upon Fundamental and Substantive Rights,
and Common-Law-Claim Rights Under Color-of-Law,**

6 pages.

626
USPS CMN: 7015 0640 0001 5883 2679 – 2ND Notice to Ninth Jud Coun Exec Com: Sidney, Richard, Susan 5/5

2022-011769 MISC Page: 624 of 2782
09/26/2022 03:35:37 PM Receipt #: 22-9391
Rec Fee: \$30.00 Darrell James Hill
Gila County, Az, Sadie Jo Bingham, Recorder



Darrell- James: Hill, aggrieved man¹
c/o 5142 East 18th Avenue
Apache Junction, Arizona ZIP CODE EXEMPT
without the US Inc. [85119]

Sidney; acting as Chief Judge, Chairman;
Richard; acting as Circuit Judge;
Susan; acting as Senior District Judge;
Judicial Council Executive Committee
c/o Office of Executive Committee
P.O. Box 193939
San Francisco, California 94119-3939

Jurat Affidavit- Notice²:
9th Circuit Trespass Upon Fundamental and Substantive Rights³,
and Common-Law-Claim⁴ Rights Under Color-of-Law⁵

Sidney, Richard, Susan: Greetings;

i: man am writing: because i filed a Common-Law-Claim, "claim", for suit into the federal court in Phoenix, Arizona for an amount in controversy greater than 20 dollars in property-forfeited-to-me⁶. And, administratively, i must make you aware of the destruction⁷ of my rights violations surrounding that case because Ranier and Brian, the Chief Judge- USDC-AZ, and the Clerk of Court- USDC-AZ, respectively, are involved in the groups' wrong-doings destroying my claim. And, finally, because you are

- 1 i: man means: a) a flesh and blood man-kind understanding Almighty God of Abraham of the Holy Bible, and a sovereign one who in a collective capacity with others sovereigns are the people of the United States of America over-standing the government for the United States of America; b) NOT a cestui que trust, corporation, or other fictitious entity; c) NOT a US citizen; d) Not an inhabitant of a federal area See at Gila County Recorder – site: <http://recorder.gilacountyaz.gov/recorder/web/> Document Number: 2017-002378, pg 199-217 Affidavit
- 2 notify (v), notice means: to point out information, intelligence, knowledge; formal warning
- 3 fundamental-and-substantive-rights means: a) those inalienable rights from Almighty God inherent to nature and man, the right to protect them, and to the world stewardship, life, liberty and property. b) See Gila County Recorder – <http://recorder.gilacountyaz.gov/recorder/web/> Document Number: 2017-002378, pg 684-690. c) See: Declaration of Independence (1776) re: the Constitution for the United States of America (1787), Amendments VII, IX, and X (1789) d) "... [W]hile powers are delegated to the agencies of government, sovereignty itself remains with the people, by whom and for whom all government exists and acts." – Yick Wo v. Hopkins.
- 4 Common-Law-Claim means: a claim brought by a man, the facts and law determined by a jury and/or by a judge. Section I: See at Gila County Recorder – site: <http://recorder.gilacountyaz.gov/recorder/web/> Document Number: 2017-002378, pg 184-584.
- 5 color-of-law means: appearance of truth, likelihood, validity, or right; justification; an initially apparent or prima-facie right; a sufficient warrant for action; as, color of title. See: Gila County Recorder – site: <http://recorder.gilacountyaz.gov/recorder/web/> Document Number: 2017-002378, pg 193. subscript 12.
- 6 property means: a thing privately owned and set aside for private and exclusive use. See at Gila County Recorder – site: <http://recorder.gilacountyaz.gov/recorder/web/> Document Number: 2017-002378, pg 240-549.
- 7 destruction (n.) destroy means: tear down, lay waste, ravage

USPS RMN: RE 322 399 234 US - Jurat Notice to Ninth Jud Coun Exec Com: Sidney, Richard, Susan 1/4

2022-011769 MISC Page: 625 of 2782
09/26/2022 03:35:37 PM Receipt #: 22-9381
Rec Fee: \$30.00 Darrell James Hill
Gila County, Az, Sadie Jo Bingham, Recorder



the only next responsible party in the 9th Circuit Court for addressing the harm and loss i allege, i want my Common-Law-Claim filed and proceeding with no abuse actions against me.

Section I: Offenders; the Group

For nearly four months, beginning January 04, 2017, my Claim has been destroyed by an employee- "group"⁸ within the 9th, Circuit United States District Court⁹, "USDC", Phoenix, Arizona. As explained below under Section III, the group's disregard for my fundamental-and-substantive-rights, rather than the protection of my rights, is a violation against¹⁰ the sovereign people, "people" – the same United-States-of-America-people giving rise to the government for the United States, the United States government, "USgov", and under it, the inferior-courts.

Section II: The Contract

Understanding Almighty God, the people of the United States formed-the-Constitution¹¹ for the people of the United States, under which the USgov was delegated authority¹² to serve: to establish statutory¹³ judicial rules and inferior courts¹⁴. To wit:

a) No statute, and No code, and No rule on any level of the USgov may exceed the Constitutional limits of authority delegated to it by the people; b) The people are forever sovereign over the USgov. And, c) the USgov is forever bound by the Constitution contract: to understand the limits, duties, and obligations of the authorization enabled it. This is common knowledge in fact and in public records.

Section III: Breach of Contract

i presented a claim for filing suit with trial-by-jury¹⁵, for the recovery of my property re: "Hill v Lynch" In *The Hill Court; 'A Federal Court'*

at 'District Court of the united States
for Phoenix Arizona', U.S.A.

Claimant Case No: CMN 7009 1410 0000 7868 5703 "

The USDC- Phoenix assigned Case No. CV-17-00026-PHX-BSB.

But, my Common-Law-Claim presentment was Not filed for suit as ordered. Instead, the group, at the USDC- Phoenix Clerk of Court, et al.: 1) changed¹⁶ the court¹⁷, 2) changed the trial-by-jury, and 3)

- 8 employee- "group" means: a) Ranier, acting as Chief Judge and b) Brian, acting as Clerk of Court, (c) et al. employees under Ranier/ Brian: USDC-Ariz., Phoenix
- 9 USDC means: an inferior court under the authority of the government for the United States of America
- 10 against means: in opposition to, adverse, hostile
- 11 formed-the-Constitution means: "We the people of the United States, in Order to form a more perfect Union, ... do ordain and establish this Constitution for the United States of America." Constitution for the United States of America, 1787: preamble.
- 12 authority means: formal approval or sanction given; authorization
- 13 statutory (adj.) statute means: any law enacted under the Constitutional contract
- 14 Inferior courts means: "The Congress shall have power to ... constitute Tribunals inferior to the supreme Court[.] Constitution for the United States of America, 1787: Art. I, sect.8, cl. 9. In example, 9th Circuit Court is an inferior court.
- 15 trial by jury, try by jury means: judicial examination of the facts/ law of a matter by the jury, a set of people selected to try a matter and render a verdict ~ USDC- Phx No. CV-17-00026-PHX-BSB. Doc 1 - See at Gila County Recorder – site: <http://recorder.gilacountyaz.gov/recorder/web/> Document Number: 2017-002378, pg 607-642. notice; Status;
- 16 change means: to substitute a one thing for another, so to make the first thing other than what it was.
- 17 court means: the functional context and purpose for a judicial assembly; "In *The Hill Court; 'A Federal Court'*" for a Common Law Claim ~ Doc 1 - See at Gila County Recorder – site: <http://recorder.gilacountyaz.gov/recorder/web/> Document Number: 2017-002378, pg 657: Case Summary, et seq.

USPS RMN: RE 322 399 234 US - Jurat Notice to Ninth Jud Coun Exec Com: Sidney, Richard, Susan 2/4

2022-011769 MISC Page: 626 of 2782

09/26/2022 03:35:37 PM Receipt #: 22-9381

Rec Fee: \$30.00 Darrell James Hill

Gila County, Az, Sadie Jo Bingham, Recorder



changed the jurisdiction¹⁸: 3a) without¹⁹ my counsel, 3b) with No-authorization²⁰, and 3c) without jurisdiction; then, they 4) did not issue summons; and, 5) a month later wrote ostensibly²¹ that they would not issue summons unless I agreed to substitute their jurisdiction. Neither the USgov nor an inferior court under it has authorization from the people in the Constitutional contract to impose²² wanton abrogation²³ of fundamental or substantive or common law rights upon the people (upon i: man). To this, any and all presumption of authority for the group's any changes to my claim has been expressly denied²⁴.

Section IV: Intent and Damage

The Arizona group implemented an obscure²⁵ color-of-law scheme using 'rules' and standard-operating-procedure²⁶ with No authority under the USgov to systematically- deprive²⁷ the people of their (i: man of my) fundamental, substantive, and common law rights. The record reflects that the group ostensibly sought to obtain jurisdiction over my claim by willful deception and coercion.

At minimum the group members exceeded the USgov Constitutional authority, and did harm and cause loss upon i: man, and with regard to the trespass-upon-the-case²⁸ of the Common-Law-Claim for suit for an amount in controversy greater than twenty dollars. See Constitution (1787); Bill-of-Rights²⁹ (1789), Amendment VII³⁰, IX³¹ and X³².

Section V: Restoration

Despite my good faith efforts and admonishment, even the conspicuous "compensation due"

18 **Jurisdiction: trial by jury** means: ~ USDC- Phx No. CV-17-00026-PHX-BSB. Doc 1 -

See at Gila County Recorder – site: <http://recorder.gilacountyaz.gov/recorder/web/> Document Number: 2017-002378, pg 585-587: ORDER; pg 596-599: notice: Rules of Court; pg 607-642: notice: Status:; pg 643- : NOTICE: (g): pg 665- : Notice: To Magistrate

19 **without** means: outside of; lacking

20 **No-authorization** means: No formal approval or sanction or "authority" given

21 **ostensibly** means: capable of being shown

22 **impose** means: inflict by force or authority

23 **abrogation (n), abrogate** means: abolish by authoritative activities

24 **denied** means: refused, rejected, NOT true

25 **obscure** means: hidden, covert

26 **standard operating procedure** means: a set of step-by-step instructions compiled by an organization for help workers carry out routine operations.

27 **systematically- deprive** means: racketeering, by group criminal conduct

28 **trespass-upon-the-case** means: a) "Notice to Officers of the Court", et seq.: USDC- Phx No. CV-17-00026-PHX-BSB. Doc 1. See: Gila County Recorder – site: <http://recorder.gilacountyaz.gov/recorder/web/> Document Number: 2017-002378, pg 192; b) "notice: Status; Clerks' non-Supply of Summon" pp. 607-642.

29 **Bill-of-Rights** means: "... [I]n order to prevent misconstruction or abuse of its powers [] further declaratory and restrictive clauses should be added: ARTICLES in addition to, and Amendment of the Constitution of the United States of America..."

30 **Amendment VII** means: "Article the ninth In Suits at common law, where the value in controversy shall exceed twenty dollars, the right of trial by jury shall be preserved...." Constitution for the United States of America, 1787; Bill of Rights, 1789.

31 **Amendment IX** means: "Article the eleventh The enumeration in the Constitution, of certain rights, shall not be construed to deny or disparage others retained by the people." Constitution for the United States of America, 1787; Bill of Rights, 1789.

32 **Amendment X** means: "Article the twelfth The powers not delegated to the United States by the Constitution, nor prohibited by it to the States, are reserved to the States respectively, or to the people." Constitution for the United States of America, 1787; Bill of Rights, 1789.

USPS RMN: RE 322 399 234 US - Jurat Notice to Ninth Jud Coun Exec Com: Sidney, Richard, Susan 3/4

2022-011769 MISC Page: 627 of 2782

09/26/2022 03:35:37 PM Receipt #: 22-9381

Rec Fee: \$30.00 Darrell James Hill

Gila County, Az, Sadie Jo Bingham, Recorder



agreeance³³ -on default³⁴ upon any trespass-upon-the-case, the group members persisted to impose a deprivation of rights scheme or scam against i: man, one of the people. Therefore, upon your receipt of this notice i require³⁵ that: a) this deprivation of rights in breach of Constitutional contract in all its forms of trespass-upon-the-case must be ceased and desisted hereto-forever post haste; b) my Common-Law-Claim presentments must hereto-forever be filed as ordered; c) This deprivation of rights must No longer be permitted; and, d) i: man must be made whole³⁶. I would want to know so to repair the wrong-doings occuring under my oath, authority, duty and obligation, and reputation.

Section VI: Conclusion

There is No USgov authority nor inferior court authority under the USgov for the protection³⁷ of the group's wrong-doings against i: man's (against the people's) inalienable rights or substantive rights or rights to common law claim. The group members knew or should have known that this deprivation of rights by any USgov subordinate was NEVER supposed to be imposed or allowed to happen to the people (to i: man) of the United States of America. And,

This deprivation of rights against the people (i: man) hereto-forever must Not ever be tolerated.

i, say here, and will verify in open court, that all herein be true.

Darrell-James: Hill
April 27th, 2017

Jurat

State of Arizona
County of Pinal

On this 27th day of April 2017, before me present is Darrell- James: Hill whose identity was proven to me on the basis of satisfactory evidence of an State of Arizona Driver License to be the Authorized Representative claimed: Signed and affirmed before me this 27th day of April, 2017;

Notary Public

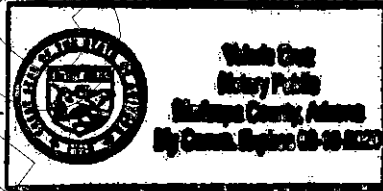

- 33 agreeance means: the action of consent, assent. The group members all acquiesced to the compensation due upon their actions; agreeance - by default in trespass-upon-the-case.
- 34 default means: to put wrong
- 35 require means: a demanding of that which is necessary and proper and critical for proceeding upon a right
- 36 made whole means: compensation-due; fees for common law filing returned
- 37 protection means: defend, assist, shelter

630

USPS RMN: RE 322 399 234 US - Jurat Notice to Ninth Jud Coun Exec Com: Sidney, Richard, Susan 4/4

2022-011769 MISC Page: 628 of 2782
09/26/2022 03:35:37 PM Receipt #: 22-9381
Rec Fee: \$30.00 Darrell James Hill
Gila County, Az, Sadia Jo Bingham, Recorder



Registered No. RE322399234US

Date Stamp 0130 07

To Be Completed By Post Office	Postage \$ \$0.70	Extra Services & Fees (continued)
	Extra Services & Fees	<input type="checkbox"/> Signature Confirmation
	<input type="checkbox"/> Registered Mail \$ \$12.50	<input type="checkbox"/> Signature Confirmation Restricted Delivery
	<input type="checkbox"/> Return Receipt (hardcopy) \$ \$2.75	<input type="checkbox"/> Signature Confirmation Restricted Delivery
	<input type="checkbox"/> Return Receipt (electronic) \$ \$0.00	<input type="checkbox"/> Signature Confirmation Restricted Delivery
	<input type="checkbox"/> Restricted Delivery \$ \$0.00	Total Postage & Fees \$ 15.95
Customer Must Declare Full Value \$ \$10.00		Received by 04/27/2017
Domestic Insurance up to \$50,000 is included based upon the declared value. International Indemnity is limited. (See Reverse).		

APACHE JUNCTION
151 W SUPERSTITION BLVD
APACHE JUNCTION
AZ
85120-9998
0302590130
(800)275-8777 3:17 PM
04/27/2017

Product Description	Sale Qty	Final Price
First-Class Mail Letter (Domestic)	1	\$0.70

Registered 1 \$12.50
(Amount: \$10.00)
(@USPS Registered Mail #)
(RE322399234US)

Return Receipt 1 \$2.75
(@USPS Return Receipt #)
(9590940220736132026930)

OFFICIAL USE

To Be Completed By Customer (Please Print) All Entries Must Be in Ballpoint or Typed	FROM	Darrell James Hill, aggrieved man c/o 5142 East 18 th Avenue Apache Junction, Arizona ZIP CODE EXEMPT 85120 without the US Inc. (85119)
	TO	Sidney, acting as Chief Judge, Chairman; Richard, acting as Circuit Judge; San Francisco Superior Court Judge; Judicial Council Executive Committee c/o Office of Executive Committee P.O. Box 193939 San Francisco, California 94119-3939

PS Form 3806, Registered Mail Receipt
April 2015, PSN 7530-02-000-9051
For domestic delivery information, visit our website at www.usps.com

Copy 1 - Customer
(See Information on Reverse)

Total	\$15.95
Cash	\$50.00
Change	(\$34.05)

In a hurry? Self-service kiosks offer quick and easy check-out. Any Retail Associate can show you how.

Text your tracking number to 28777 (2USPS) to get the latest status. Standard Message and Data rates may apply. You may also visit USPS.com USPS Tracking or call 1-800-222-1811.

BRIGHTEN SOMEONE'S MAILBOX. Greeting cards available for purchase at select Post Offices.

631

Unofficial Copy



Track Another Package +

Tracking Number: RE322399234US

Remove X

Delivered

Expected Delivery Day: Monday, May 1, 2017 ⓘ
Product & Tracking Information

See Available Actions

Postal Product:
First-Class Mail®

Features:
Registered Mail™
Return Receipt

See tracking for related item: 8590940220738132026930
([/go/TrackConfirmAction?Labels=8590940220738132026930](#))

DATE & TIME	STATUS OF ITEM	LOCATION
May 1, 2017, 1:53 pm	Delivered, Left with Individual	SAN FRANCISCO, CA 94103
Your item was delivered to an individual at the address at 1:53 pm on May 1, 2017 in SAN FRANCISCO, CA 94103.		
May 1, 2017, 11:26 am	Available for Pickup	SAN FRANCISCO, CA 94119
May 1, 2017, 11:25 am	Arrived at Unit	SAN FRANCISCO, CA 94105
May 1, 2017, 12:33 am	Departed USPS Facility	SAN FRANCISCO, CA 94188
April 30, 2017, 3:42 pm	In Transit to Destination	
April 29, 2017, 3:42 pm	Arrived at USPS Destination Facility	SAN FRANCISCO, CA 94188
April 28, 2017, 1:54 am	Departed USPS Facility	PHOENIX, AZ 85026
April 28, 2017, 1:52 am	Arrived at USPS Facility	PHOENIX, AZ 85026
April 27, 2017, 4:12 pm	Departed Post Office	APACHE JUNCTION, AZ 85120
April 27, 2017, 3:15 pm	Acceptance	APACHE JUNCTION, AZ 85120

632



642

	:Sadie-Jo: Bingham	Gila-County-Arizona-State-Recorder	05/14/18	Gila-County-Recorder-Doc.#: 2018-005176	:Affidavit: Proof-of-Claims – August- 2019; related to: Gila-County-Recorder-Doc.##: 2017-002378
111	:Donald: Trump	:POTUS	05/29/18	RE 047 636 404 US	Delivery-confirmation return-receipt
112	:Joseph: Dunford	:JCOS- General	↓	↓	↓
113	:Mark: Milley	:COS- Army- General	↓	↓	Delivery-confirmation return-receipt
114	:Michele: Reagan	Arizona-State-Secretary-Trustee	07/03/18	First Class Mail	Arizona-State-Notary-Trustee-Autograph-Veriication by the Trustee-Dereliction: 1) Constructive-notice of DARRELL JAMES HILL of the Darrell-James: Hill, Ohioan, A.R.- benefit; 2) Superior-notice of the political-election: Darrell-James: Hill- Ohioan-beneficiary, -:Executor: EBA-1933-A.D. 3) Curative- Birth-County-Registration of the Live-Life-Executor-requirement. 4) Etc.
115	:John: Kasich	Ohio-State-Governor-Trustee	07/03/18	7015 1730 0002 3063 9348	Assignment of the Executor: EBA-1933-A.D. - debenture-subrogation-entitled- DARRELL JAMES HILL, et al.- derivatives. Political-Election by the Ohioan-Executor: EBA-1933-A.D., -:Darrell-James: Hill, -:civilian, -PE 2018-A.D. ~; see: Gila-County-Recorder-Doc.# 009291; p. 757. <u>See: appended: July 3rd, 2018: 12:15 p.m.</u> -:Constructive notice of ... :Executor, and: <u>12:17 p.m.</u> - :Superior- Constructive ... -Presumption; man-

2022-011769 MISC Page: 631 of 2782
 09/26/2022 03:35:37 PM Receipt #: 22-9381
 Rec Fee: \$30.00 Darrell James Hill
 Gila County, Az, Sadie Jo Bingham/Recorder



105	:Paul- Gosar	U.S. Legislature -:Representative- Arizona- State	03/19/18	7015 1730 0002 3063 9379	Importune for the attention to the :i- man -enduring the -:dprivation of -:fundamental-right- problems-imposed under the color-of-law
106	:John: McCain	U.S. Legislature -:Senator- Arizona-State	03/19/18	7015 1730 0002 3063 9386 with the :7015 0640 0001 5883 2747 - Demand for -:Funamental- Rights-Executed	Importune for the attention to the :i- man -enduring the -:dprivation of -:fundamental-right- problems-imposed under the color-of-law
107	:Jeff: Flake				
108	:John: McCain	U.S. Legislature -:Senator- Arizona-State	04/16/18	Re: 7015 1730 0002 3063 9386	'...;i cannot be of assistance at this time.'
109	man- :Summit- County-Ohio-State	Summit-County-Recorder- Office.	04/12/18	RE 322 399 163 US	:Ohioan-beneficiary-Executor with the exclusive- peculiar-absolute-right: EBA-1933-A.D.-covenant- Executive-duty for the establishment of the civil-live- status. :See Gila-County-Recorder-Doc.# 2018-5176, p. 18. - Jurat: Curative-Registration of the live ... -:Darrell-James: Hill- Ohioan-beneficiary, -: beneficiary-Executor: EBA-1933-A.D.
110	man- :Arriba- County-:New- Mexico-State	Arriba-County-Recorder- Office	04/12/18	RE 322 399 177 US	:New-Mexican-beneficiary-Executor with the exclusive- peculiar-absolute-right: EBA-1933-A.D.-covenant- Executive-duty for the establishment of the civil-live- status. :See Gila-County-Recorder-Doc.# 2018-5176, p. 2. - Jurat: Curative-Registration of the live ... -:Beverly-Jean: Romero-Hill- Ohioan-beneficiary, -: beneficiary-Executor: EBA-1933-A.D.
	:man- trustee	:association	:year, :day	USPO, other	:covenant

2022-011769 MISC Page: 632 of 2782
 09/26/2022 03:35:37 PM Receipt #: 22-9381
 Rec Fee: \$30.00 Darrell James Hill
 Gila County, Az, Sadie Jo Bingham, Recorder

149

WFO

:2018-A.D. Document- History 8 / 19

92	:Greg: Gianforte	↓	↓	↓	↓
93	:Jimmy: Gomez	↓	↓	↓	↓
94	:Darrell: Issa	↓	↓	↓	↓
	:man- trustee	:association	:year, :day	USPO, other	:covenant
95	Brenda: Lawrence	U.S. Legislature -:Representative- Committee on Oversight and Government Reform	02/28/18	7015 0640 0001 5883 2761	Demand for the Congressional-Oversight for the Enforced- protection of -:Funamental-Rights-Executed -:7015 0640 0001 5883 2747 sent.
96	:Caroly: Maloney	↓	↓	↓	↓
97	:Thomas: Massie	↓	↓	↓	↓
98	:Eleanor: Holmes: Norton	↓	↓	↓	↓
99	:Jamie: Raskin	↓	↓	↓	↓
100	:Dennis: Ross	↓	↓	↓	↓
101	:Mark: Sanford	↓	↓	↓	↓
102	:man- trustee	:association	:year, :day	USPO, other	:covenant
103	:Bonnie: Watson- Coleman	↓	↓	↓	↓
104	:Peter: Welch	U.S. Legislature -:Representative- Committee on Oversight and Government Reform	02/28/18	7015 0640 0001 5883 2761	Demand for the Congressional-Oversight for the Enforced- protection of -:Funamental-Rights-Executed -:7015 0640 0001 5883 2747 sent.

2022-011769 MISC Page: 633 of 2782
 09/26/2022 03:35:37 PM Receipt #: 22-9381
 Rec Fee: \$30.00 Darrell James Hill
 Gila County, Az, Sadie Jo Bingham, Recorder



77	:Jody: Hice	↓	↓	↓	↓
78	:man- trustee	:association	:year, :day	USPO, other	:covenant
79	:Stephen: Lynch	U.S. Legislature -:Representative- Committee on Oversight and Government Reform	02/28/18	7015 0640 0001 5883 2761	Demand for the Congressional-Oversight for the Enforced- protection of -:Funamental-Rights-Executed -:7015 0640 0001 5883 2747 sent.
80	:Stacey-E.: Plaskett	↓	↓	↓	↓
81	:Justin: Amash	↓	↓	↓	↓
82	:Rod: Blum	↓	↓	↓	↓
83	:Matt: Cartwright	↓	↓	↓	↓
84	:William: Clay	↓	↓	↓	↓
85	:James: Comer	↓	↓	↓	↓
86	:man- trustee	:association	:year, :day	USPO, other	:covenant
87	:Jim: Cooper	U.S. Legislature -:Representative- Committee on Oversight and Government Reform	02/28/18	7015 0640 0001 5883 2761	Demand for the Congressional-Oversight for the Enforced- protection of -:Funamental-Rights-Executed -:7015 0640 0001 5883 2747 sent.
88	:mark: DeSaulnier	↓	↓	↓	↓
89	:Scott: DesJarlais	↓	↓	↓	↓
90	:Jimmy: Duncan	↓	↓	↓	↓
91	:Virginia: Foxx	↓	↓	↓	↓



63

:2018-A.D. Document- History

63	:Martha: Roby				
64	:John: Rutherford	U.S. Legislature -:Representative- Committee on the Judiciary	02/28/18	7015 0640 0006 0063 7029	
	:man- trustee	:association	:year, :day	USPO, other	:covenant
65	:Bradley: Schneider				
66	:Lamar: Smith				
67	:Eric: Swalwell				
68	:Trey: Gowdy	U.S. Legislature -:Representative- Committee on Oversight and Government Reform	02/28/18	7015 0640 0001 5883 2761	
69	:Elijah: Cummings				
70	:Ron: DeSantis				
71	:Blake: Farenthold				
	:man- trustee	:association	:year, :day	USPO, other	:covenant
72	:Will: Hurd				
73	:Mark: Meadows				
74	:Gary: Palmer				
75	:Paul: Gosar				
76	:Glenn: Grothman				

Demand for the Congressional-Oversight for the Enforced- protection of -:Funamental-Rights-Executed -:7015 0640 0001 5883 2747 sent.

Demand for the Congressional-Oversight for the Enforced- protection of -:Funamental-Rights-Executed -:7015 0640 0001 5883 2747 sent.

2022-011769 MISC Page: 635 of 2782
09/26/2022 03:35:37 PM Receipt #: 22-9381
Rec Fee: \$30.00 Darrell James Hill
Gila County, Az, Sadie Jo Bingham, Recorder



Committee on the Judiciary					–:7015 0640 0001 5883 2747 sent.
:man- trustee	:association	:year, :day	USPO, other		:covenant
47 :Steve: Chabot	↓	↓	↓		↓
48 :Val: Dennings	↓	↓	↓		↓
49 :Theodore: Deutch	↓	↓	↓		↓
50 :Matt: Gaetz	↓	↓	↓		↓
51 :Trey: Gowdy	↓	↓	↓		↓
52 :Luis: Gutierrez	↓	↓	↓		↓
53 :Karen: Handel	↓	↓	↓		↓
54 :Pramila: Jayapal	↓	↓	↓		↓
55 :Hakeem: Jeffries	U.S. Legislature -:Representative– Committee on the Judiciary	02/28/18	7015 0640 0006 0063 7029	Demand for the Congressional-Oversight for the Enforced- protection of -:Funamental-Rights-Executed –:7015 0640 0001 5883 2747 sent.	
56 :mike: Johnson	↓	↓	↓		↓
57 :Jim: Jordan	↓	↓	↓		↓
58 :Ted: Lieu	↓	↓	↓		↓
59 :Ted: Poe	↓	↓	↓		↓
60 :Jamie: Raskin	↓	↓	↓		↓
61 :John: Ratcliffe	↓	↓	↓		↓
62 :Cedric: Richmond	↓	↓	↓		↓



Handwritten mark or signature at the bottom right corner.

139

:2018-A.D. Document- History

4 / 19

34	:James: Sensenbrenner, Jr	↓	↓	↓	↓
35	:Doug: Collins	↓	↓	↓	↓
	:man- trustee	:association	:year, :day	USPO, other	:covenant
36	:Ron: DeSantis	U.S. Legislature -:Representative- Committee on the Judiciary	02/28/18	7015 0640 0006 0063 7029	Demand for the Congressional-Oversight for the Enforced- protection of -:Funamental-Rights-Executed -:7015 0640 0001 5883 2747 sent.
37	:Blake: Farenhold	↓	↓	↓	↓
38	:Louie:Gohmert, Jr.	↓	↓	↓	↓
39	:David: Cicilline	↓	↓	↓	↓
40	:Steve: Cohen	↓	↓	↓	↓
41	:Sheila: Jackson-Lee	↓	↓	↓	↓
42	:Heny-Hank: Johnson, Jr.	↓	↓	↓	↓
43	:Zoe: Lofgren	↓	↓	↓	↓
44	:Karen: Bass	↓	↓	↓	↓
45	:Andy: Biggs	↓	↓	↓	↓
	:man- trustee	:association	:year, :day	USPO, other	:covenant
46	:Ken: Buck	U.S. Legislature -:Representative-	02/28/18	7015 0640 0006 0063 7029	Demand for the Congressional-Oversight for the Enforced- protection of -:Funamental-Rights-Executed

2022-011769 MISC Page: 637 of 2782
 09/26/2022 03:35:37 PM Receipt #: 22-9381
 Rec Fee: \$30.00 Darrell James Hill
 Gila County, Az, Sadie Jo Bingham, Recorder



22	:Richard: Blumenthal					
23	:Mazei-K.: Hirono					
24	:Cory-A.: Booker					
25	:Kamala-D.: Harris	U.S. Legislature - :Senator - Committee on the Judiciary	02/28/18	7015 0640 0001 5883 2747;	All noticed were sent fascimile of this document.	
26	:Chuck: Grassley	U.S. Legislature - :Senator - Committee on the Judiciary	02/28/18	7015 0640 0001 5883 2754	Demand for the Congressional-Oversight for the Enforced- protection of -:Funamental-Rights-Executed -:7015 0640 0001 5883 2747 sent.	
27	:Dianne: Feinstein					
28	:Bob: Goodlatte	U.S. Legislature -:Representative- Committee on the Judiciary		7015 0640-0006 0063 7029	Demand for the Congressional-Oversight for the Enforced- protection of -:Funamental-Rights-Executed -:7015 0640 0001 5883 2747 sent.	
	:man- trustee	:association	:year, :day	USPO, other	:covenant	
29	:Jerold: Nadler		02/28/18	7015 0640 0006 0063 7029	Demand for the Congressional-Oversight for the Enforced- protection of -:Funamental-Rights-Executed -:7015 0640 0001 5883 2747 sent.	
30	Darrell: Issa					
31	:Steve: King					
32	:Raul: Labrador					
33	:Tom: Marino					

637

634

:2018-A.D. Document- History

2 / 19

6	Dianne: Feinstein	↓	↓	↓	↓
7	:Orrin-G.: Hatch	↓	↓	↓	↓
	:man- trustee	:association	:year, :day	USPO, other	:covenant
8	:Linsey: Graham	↓	02/28/18	↓	↓
9	:John: Cornyn	↓	↓	↓	↓
10	:Mike: Lee	↓	↓	↓	↓
11	:Ted: Criz	↓	↓	↓	↓
12	:Ben: Sasse	↓	↓	↓	↓
13	:Jeff: Flake	↓	↓	↓	↓
14	:Mike: Crapo	↓	↓	↓	↓
15	:Thom: Tillis	↓	↓	↓	↓
16	:John: Kennedy	↓	↓	↓	↓
17	:Patrick: Leahy	↓	↓	↓	↓
18	:Richard: Durbin	↓	↓	↓	↓
19	:Sheldon: Whitehouse	↓	↓	↓	↓
	:man- trustee	:association	:year, :day	USPO, other	:covenant
20	:Amy: Klobuchar	↓	02/28/18	↓	↓
21	:Christopher-A.: Coons	↓	↓	↓	↓

2022-011769 MISC Page: 639 of 2782
 09/28/2022 03:35:37 PM Receipt #: 22-9381
 Rec Fee: \$30.00 Darrell James Hill
 Gila County, Az, Sadie Jo Bingham, Recorder



:2018 A.D.

#	:man- trustee	:association	:year, :day	USPO, other	:covenant
1	:Jeff: Sessions	US- AG, CLT	01/17/18	RE 322 399 146 US; See Gila-County-Recorder- Doc.# 009291, p. 738.	:Jeff- U.S.- Ag- CLT- Dishonor with -:Bill-of-Particulars for the PE-2016-A.D., et al.- deprivation- penalty- agreement to the property-lots-stolen: 1,2, and 3.
2	:Donald- Trump	:POTUS	01/31/18	RE 322 399 150 US; See Gial-County-Recorder- Doc.# 2019-009291, p. 746.	Demand for the fiduciary-protection of the fundamental- rights. Re: Jeff- U.S.-AG-CLT- Dishonor: RE 322 399 146 US – Verified-claims.0
3	:Joseph: Dunford	:JCOS- General	↓	↓	↓
4	:Mark: Milley	:COS- Army- General	↓	↓	Demand for the fiduciary-protection of the fundamental- rights. Re: Jeff- U.S.-AG-CLT- Dishonor: RE 322 399 146 US – Verified-claims.
	:Donald: Trump	↓	02/26/18	cc:7015 0640 0001 5883 2747;	Demand for the Congressional-Oversight for the Enforced- protection of -:Funamental-Rights-Executed with cc: Donald- POTUS- CORRESPONDENCE: ~ Demand P, et al. -↓
	:Joseph: Dunford	↓	↓	↓	↓ , :Gen. CJOS
	:Marik: Milley	↓	↓	7015 0640 0001 5883 2747	↓ , :Gen. COS- USofA- Army
5	:Chuck: Grassley	U.S. Legislature -:Senator – Committee on the Judiciary	02/26/18	7015 0640 0001 5883 2747; All noticed were sent fascimile of this document.	Demand for the Congressional-Oversight for the Enforced- protection of -:Funamental-Rights-Executed –:7015 0640 0001 5883 2747 sent with -:All -noticed - sent -fascimile of this document.



Handwritten initials or mark.

Darrell-James: Hill, -:Ohioan.

116 :Steve: Barry Summit-County-Sheriff-Trustee ↓ 7015 1730 0002 3063 9331 ↓

117 :Steve: Barry Summit-County-Sheriff-Trustee 07/05/18 7015 1730 0002 3063 9362

:Claim fo Criminal-Wrong-Doing: Deprivation of the Protected-Right for the record documents into the public-record is Criminal-violated by the People at the Summit-CountyOhion-State- Recordation-agency ...; appended.

118 :Donald: Trump POTUS 07/12/18 7017 1000 0000 9343 0698

:Certificate of Protest: Donald- Trump with the :Claim of the contract for the receipt of property-Claimed

119 :Jeff: Sessions U.S.- AG, -:CLT ↓ 7017 1730 0002 3063 9324

:Certificate of Protest: Jeff: Sessions with the :Claim of the contract for the receipt of property-Claimed

:man- trustee :association :year, :day USPO, other :covenant

120 :Donald: Trump POTUS 07/10/18 7017 1000 0000 9343 0698, 7017 1730 0002 3063 9324

:Claim of the contract for the receipt of property-Claimed

121 :Jeff: Sessions U.S.- AG, -:CLT ↓ ↓ ↓

122 :Brian: Karth :USDC- Arizona, -:Clerk 07/18/18 7015 1730 0002 3063 9300

:Bill of :Costs – re: Trepass-on-the-case-covenant-agreement: Common -law-Claim #: 7009 1410 0000 7868 5703; recorded at the USDC-venue on the 01/04/17 by the USPO -RMN: RE 322 399 336 US.

123 :Ranier: Collins :USDC- Arizona, -:Chief-Judge ↓ 7017 1000 0000 9343 0704 ↓

:Bill of :Costs – re: Trepass-on-the-case-covenant-agreement

2022-011769 MISC Page: 641 of 2782
09/26/2022 03:35:37 PM Receipt #: 22-9381
Rec Fee: \$30.00 Darrell James Hill
Gila County, Az. Sadie Jo Bingham, Recorder

HTA

124	:Brian: Karth	:USDC- Arizona, -:Clerk	07/20/18	Standard Mail
125	:K.: Smith	:USDC- Arizona, -:Clerk- deputy		
	:man- trustee	:association	:year, :day	USPO, other
126	:Bridget-S.: Bade	:USDC- Arizona, -:Magistrate- Judge	07/31/18	Standard Mail
127	:Kristen: Scalise	:Summit-County-Ohio-State, -:Fiscal- Officer	07/19/18	7015 1730 0002 3063 9287

'unclear how to process the enclosed document'
 – :7015 1730 0002 3063 9300. :Bill of :Costs – re:
Trepass-on-the-case-covenant : Common -law-
 Claim #: 7009 1410 0000 7868 5703; recorded at the
 USDC-venue on the 01/04/17 by the USPO -RMN: RE
 322 399 336 US.

:covenant
 :No. CV-17-00026-PHX-BSB -:ORDER. – color-of-law-
 stricken as ~ :Bill of :Costs – re: Trepass-on-the-
 case-covenant: Common -law-Claim #: 7009 1410
 0000 7868 5703; recorded at the USDC-venue on the
 01/04/17 by the USPO -RMN: RE 322 399 336 US.

:Bill-of-Costs: – re: **Deprivation-covenant-
 agreement** :Curative Registration of Live...-:Darrell-
 James: Hill, -:Ohioan-beneficiary-Executor with the
 exclusive-peculiar-absolute-right: EBA-1933-A.D.-
 covenant- Executive-duty for the establishment of the
 civil-live-status. :See Gila-County-Recorder-Doc.#
 2018-5176, p. 18. – Jurat: Curative-Registration of the
 live ... -:Darrell-James: Hill- Ohioan-beneficiary, -:
 beneficiary-Executor: EBA-1933-A.D. ~ sent for the
 recordation -04/12/18: **USPO RMN: RE 322 399 163
 US.**



128	:Katie: Mancino	:Summit-County-Ohio-State, -:Fiscal- Office, -:Executive- Assistant I	↓	7015 1730 0002 3063 9294	↓	:Bill-of-Costs: – re: Deprivation-covenant- agreement
129	:Ranier: Collins	:USDC- Arizona, -:Chief- Judge	07/24/18	7015 1730 0002 3063 9263		:Certificate-of-Protest – :Claim of the Event and Filing: Common Law-Claimant-Case-No.: 7009 1410 0000 7868 5703
130	:Brian: Karth	:USDC- Arizona, -:Clerk	↓	7015 1730 0002 3063 9256	↓	:Certificate-of-Protest –
	:man- trustee	:association	:year, :day	USPO, other		:covenant
131	:Kristen: Scalise	:Summit-County-Ohio-State, -:Fiscal- Officer	07/25/18	7017 1000 0000 9343 0650		:Certificate-of-Protest by the man: Darrell-James: Hill, -:Ohioan-beneficiary, -:Executor: EBA-1933-A.D. for the obtenance of the RE 322 399 163 US - covenant-remedy- agreement.
132	:Katie: Mancino	:Summit-County-Ohio-State, -:Fiscal- Office, -:Executive- Assistant I	↓	7015 1730 0002 3063 9270	↓	:Certificate-of-Protest
133	:Doug- Ducey	:Arizona-State- Governor	07/31/18	RE 047 636 466 US		:Mitigation of the matters of the deprivation of the right of the man to the administrative-superiors in accordance with the good-faith by the law of the PE- 2016-A.D.- covenant.
134	:Michelle: Reagan	:Arizona-State- Secretary	↓	RE 047 636 470 US	↓	:Mitigation of the matters of the deprivation
135	:man	:Head of the Notary- Division	↓ 07/31/18	7017 1000 0000 9343 0773	↓	:Mitigation of the matters of the deprivation

2022-011769 MISC Page: 643 of 2782
 09/26/2022 03:35:37 PM Receipt #: 22-9381
 Rec Fee: \$30.00 Darrell James Hill
 Gila County, Az, Sadie Jo Bingham, Recorder



645

	:man- trustee	:association	:year, :day	USPO, other	:covenant
136	:Brian-D.: Karth	USDC- Arizona- Clerk	08/01/18	Standard Mail	Re: Certificate-of-Protest , :un-clear as to how it should be processed, -:Phoenix
137	:S.: Strong	USDC- Arizona- Clerk- deputy	↓ 08/01/18	↓	↓ Re: Certificate-of-Protest ,
138	:AC.	USDC- Arizona- Clerk- deputy	08/02/18	Standdard Mail	Re: Certificate-of-Protest , :document ... not comport with the Courts Local rules, -:Tucson
139	:Donald- Trump	:POTUS	08/07/18	RE 047 636 418 US	: Certificate-of-Dishonor . See: Gila-County-Recorder- Doc.# 009291, p. 824.
140	:Jeff: Sessions	US- AG, CLT	↓	RB 898 809 919 US	↓
141	:Michelle: Reagan	:Arizona-State- Secretary	08/09/18	RB 898-809 936 US	: Mitigation: public-service-legal-advice with the unlawful-obstruction : notarial-acts by the Trustee-dereliction
142	:man	:Head oif the Notary- Division	↓	↓	↓ : Mitigation: public-service-legal-advice
	:man- trustee	:association	:year, :day	USPO, other	:covenant
143	:Kristen: Scalise	:Summit-County-Ohio-State, -:Fiscal- Officer	08/14/18	RE 047 636 449 US	: Certificate of Dishonor. – See: Beneficiary-Claim of the silent – No-response- answer-received in the responses of the Certificate-of-Protest –for the annexes, see: Certificate-of-Protest – 07/25/18; 7017 1000 0000 9343 0650 . ↓
144	:Katie: Mancino	:Summit-County-Ohio-State, -:Fiscal- Office, -:Executive-	↓ 08/14/18	RB 898 809 975 US.	: Certificate of Dishonor. – See: Beneficiary-Claim of the silent – No-response-

		Assistant I			answer-received in the responses of the Certificate-of-Protest ~for the annexes, see: Certificate-of-Protest – 07/25/18; 7015 1730 0002 3063 9270 .
145	:Ranier: Collins	:USDC- Arizona, -:Chief-Judge	08/14/18	RE 047 636 435 US	:Certificate-of-Dishonor – See: Beneficiary-Cliam of the Non-responsive-Answer ...; no- annexations ↓
146	:Brian: Karth	:USDC- Arizona, -:Clerk	↓ 08/14/18	RB 898 809 940 US	↓ :Certificate-of-Dishonor –
147	:Jovita: Carranza	U.S.- :Treasurer-Office	08/20/18	7018 0360 0000 5969 3885	Beverly-Jean: Romero- Hill, -:New-Mexican-beneficiary, -:Beneficiary-Executor: EBA-1933-A.D., demand to account, settle and closure of the EBA-1933-A.D.- debenture now.
148	:Jack: Lew	U.S. -:Fiscal-Asst. Sec.	↓	7018 0360 0000 5969 3892	↓ account, settle and closure of the EBA-1933-A.D.- debenture now.
149	:Steven-Turner: Mnuchin	U.S.- Dept of the Treasury	↓	7018 0360 0000 5969 3808	↓ account, settle and closure of the EBA-1933-A.D.- debenture now.
150	:Kimberly: Troy	U.S.- Bureau of the Fiscal-Service	↓ 08/20/18	7018 0360 0000 5969 3815	↓ account, settle and closure of the EBA-1933-A.D.- debenture now.
		:man- trustee	:association	:year, :day	USPO, other
151	:Kristen: Scalise	:Summit-County-Ohio-State, -:Fiscal- Officer	08/29/18	7018 0360 0000 5969 3861	:Mitigation- Verification: Certificate-of-Protest, Certificate-of-Dishonor

2022-011769 MISC Page: 645 of 2782
 09/26/2022 03:35:37 PM Receipt #: 22-9381
 Rec Fee: \$30.00 Darrell James Hill
 Gila County, Az, Sadie Jo Bingham, Recorder

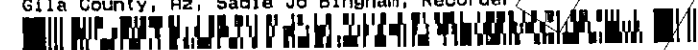

647

648

:man- trustee	:association	:year, :day	USPO, other	:covenant
152 :Katie: Mancino	:Summit-County-Ohio-State, :-Fiscal- Office, -:Executive- Assistant I	↓ 08/29/18	7018 0360 0000 5969 3878	:Mitigation- Verification: Certificate-of-Protest, Certificate-of-Dishonor- Verification
153 :Mark: Lamb	:Pinal-County-Arizona :-Sheriff	08/29/18	7017 1000 0000 9343 0728	:Darrell-James: Hill, -:Ohioan, -:beneficiary-Executor: EBA-1933-A.D.; :Beverly-Jean: Romero- Hill, -:New-Mexican, -:beneficiary- Executor: EBA-1933-A.D. :Assistant-bank-manager unlawful control over the Arizona-State-Notary-Public causing harm upon the beneficiary.
154 :Mark: Brnovich	:Arizona-State -:AG	↓ 08/29/18	First Class Mail	↓
155 :Michelle: Reagan	:Arizona-State -:Secretary	↓ 08/29/18	First Class Mail	↓
156 :John: Stumpt	:Wells-Fargo and Co. -:Presidnt and CEO	↓ 08/29/18	7017 1000 0000 9343 0735	↓
157 :Lawrence: Lee	:Wells-Fargo Mac S4049- 011, -Bank-Manager	↓ 08/29/18	First Class Mail	:Darrell-James: Hill, -:Ohioan, -:beneficiary-Executor: EBA-1933-A.D.; :Beverly-Jean: Romero- Hill, -:New-Mexican, -:beneficiary- Executor: EBA-1933-A.D.
:man- trustee	:association	:year, :day	USPO, other	:covenant



158	:Ranier: Collins	:USDC- Arizona, -:Chief-Judge	08/29/18	7018 0360 0000 5969 3847	:Mitigation- Verification: Certificate-of-Protest, Certificate-of-Dishonor
160	:Brian: Karth	:USDC- Arizona, -:Clerk	↓ 08/29/18	7018 0360 0000 5969 3854	:Mitigation- Verification: Certificate-of-Protest, Certificate-of-Dishonor
	:man- trustee	:association	:year, :day	USPO, other	:covenant
161	:Donald- Trump	:POTUS	08/29/18	7018 0360 0000 5969 3830	:Mitigation- Verification: Certificate-of-Protest, Certificate-of-Dishonor
162	:Jeff: Sessions	US- AG, CLT	↓ 08/29/18	7018 0360 000 5968 8935	:Mitigation- Verification: Certificate-of-Protest, Certificate-of-Dishonor
163	:man	:Wells-Fargo, -Customer-Correspondence: MAC D1108-030	09/06/18	Standard Mail.	:Beverly: 'We researching the items brought to our attention'
164	:man	:Wells-Fargo, -Customer-Correspondence: MAC D1108-030	09/06/18	Standard Mail.	:Darrell: 'We researching the items brought to our attention'
165	:Mark: Brnovich	:Arizona-State- AG; Consumer-Protection-and -Advocacy-Section	09/10/18	Standard Mail.	:Darrell: 'If you wish... file a complaint'
166	:G.: Shaw	:Wells-Fargo, -Customer-Correspondence: MAC D1108-030 -:Research/Remediation-Analyst	09/12-18	Standard Mail.	:Darrell and Beverly, based-upon the presumption of your illegal-request, ... [hearsay-speculation]... confirmed they would not be able to complete your request.
	:man- trustee	:association	:year, :day	USPO, other	:covenant

2022-011769 MISC Page: 647 of 2782
 09/26/2022 03:35:37 PM Receipt #: 22-9381
 Rec Fee: \$30.00 Darrell James Hill
 Gila County, Az, Sadie Jo Bingham, Recorder



649

167	:man	:Department-of-Treasury	10/24/18	7018 0630 0000 5968 9811
	:man	:Department-of-Treasury	10/24/18	7018 0630 0000 5968 9828
	:man	:Department-of-Treasury	11/07/18	Standard Mail.
	:man	:Department-of-Treasury	11/07/18	Standard Mail.
	:man- trustee	:association	:year, :day	USPO, other
	:man	:Internal-Revenue-Service	11/15/18	7018 0360 0000 5968 8904
	:man	:Internal-Revenue-Service	11/15/18	7018 0360 0000 5969 2949
	:man	:Bureau: Fiscal-Servie	11/22/18	7018 0360 0000 5969 2936

:Beverly-Jean: Romero- Hill, -:New-Mexican, -:beneficiary- Executor: EBA-1933-A.D.

:Inquiry of the Department of the Treasury -fiduciary -duty to :i- man.

:Darrell-James: Hill, -:Ohioan, -:beneficiary- Executor: EBA-1933-A.D.

:Inquiry of the Department of the Treasury -fiduciary -duty to :i- man.

:Darrell, :We could not locate a TreasuryDirect under the social-security-number-provided

:Beverly, :Please be aware that neither your birth certificate nor your social security number are ... any type of Department of Treasury obligation.

:covenant

:Darrell-James: Hill, -:Ohioan- Executor- notice: Revocation fo the Internal Revenue Service Power of the Attorney

:Beverly-Jean: Romero- Hill, -:New-Mexican- Executor- notice: Revocation fo the Internal Revenue Service Power of the Attorney

:Beverly-Jean: Romero- Hill, -:New-Mexican- Executor. If the -:Department-of-Treasury has not



anything to do with the :Beverly-Jean: Romero- Hill,
-:New-Mexican and the EBA-1933-A.D.- debenture,
then you should openly-tell everyone.

:man Bureau of the Fiscal-Service 12/17/18 7018 0360 0000 5968 8898

**:Darrell-James: Hill, -:Ohioan- beneficiary,
-:Beneficiary- Executor: EBA-1933-A.D. – how and
why was no account located for :- man in/under the
Department of Treasury.**

:man- trustee :association :year, :day USPO, other :covenant

:man- trustee :association :year, :day USPO, other :covenant



159

:Holy Bible Book of Psalms 1

1. Blessed is the man that walketh not in the counsel of the ungodly, nor standeth in the way of sinners, nor sitteth in the seat of the scornful.

:¹Darrell-James: Hill c/o PO Box 3806, Apache Junction, Arizona 85120

:February 26, 2018 A.D.

Chuck: Senator Grassley, Fax: Washington DC Office 202-224-3744
Dianne: Senator Feinstein, Fax: Washington DC Office 202-224-3841
Committee on the Judiciary
Washington, District of Columbia.

DEMAND FOR THE CONGRESSIONAL OVERSIGHT FOR THE ENFORCED PROTECTION OF FUNDAMENTAL RIGHTS-EXECUTED

with re: Donald :POTUS Trump Correspondence: "DEMAND FOR THE FIDUCIARY PROTECTION OF FUNDAMENTAL RIGHTS", USPS RMN 322 399 150 US :January 31, 2018, recv'd February 13, 2018; with re: Jeff: Office USAG² Sessions' DISHONOR by the apartheid^{3 4} of rights of i: man⁵ under the color of statutory law.

Dear Orin, Mitch, Greetings,

i: man :Darrell-James: Hill :one of the Ohio state Citizens, member of the united States of America people is an American State Citizen.

i write to obtain a) Congressional enforcement protections of my⁶ Almighty God-given rights-executed and exercised⁷ for to acquire private-property claims owned; and, because b.i.) the USAGs willfully thief millions of dollars of my private-property, and b.ii) :USDC-Arizona, known to the management, yet is derelict to file the USPS Registered Claim delivered to him by me for the

1 In the Correct-Sentence-Sense-Correct-Parse-Syntax-Grammar- prepositional phraseology

2 USAG means: man – 1) Loretta and 2) Jeff

3 Apartheid wrongdoings means: deprivations of this man's rights (under the color of the laws)

4 prejudice shown against the i:man means:

a) December 29, 2017: **President Donald J. Trump Proclaims January 2018 as National Slavery ... Prevention Month**, we recommit ourselves to eradicating the evil of enslavement.... In addition to these governmental actions, Americans must learn how to identify and combat the evil of enslavement....

b) December 20, 2017: **Executive Order Blocking the Property of Persons Involved in Serious Human Rights Abuse or Corruption**, ... Human rights abuse and corruption undermine the values that form an essential foundation of stable, secure, and functioning societies; have devastating impacts of individuals; weaken democratic institutions; degrade the rule of law; The United States seeks to impose tangible and significant consequences on those who commit serious human rights abuse or engage in corruption....

5 i: man, i:man means: Almighty God's: man of the people of the nation states of America, "The United States of America"

6 i:man is: one of the people of The United States of America and owner of the private-property by the showing of the claim

7 ICCPR Senate ratification: March 1992: 'rights executed are promoted and protected by the full power of the United States'

Letter to Senate Judiciary re:Letter: Donald re: Dishonor Session/ Property: USPS CMN 7015 0640 0001 5883 2747 , February 26, 2018 1/4

2022-011769 MISC Page: 650 of 2782

09/26/2022 03:35:37 PM Receipt #: 22-9381

Rec Fee: \$30.00 Darrell James Hill

Gila County, Az, Sadie Jo Bingham, Recorder



652

:Holy Bible Book of Psalms 1

1. Blessed is the man that walketh not in the counsel of the ungodly, nor standeth in the way of sinners, nor sitteth in the seat of the scornful.

suit for my property in a common law court at the USDC -Arizona, Phoenix venue⁸.

HISTORY

i: man have three (3) times claimed of the private-property⁹, ordered given by the several district courts to the United States of America people: to wit:

1st On the day August 16, 2016, CLAIM: USPS RMN RE 322 399 279 US; I registered the claim. Response to the 1st Claim is the answer of silence: I accept the acquiescence and now claim full ownership of the private-property claimed in the exercise of my right.

2nd On the day February 17, 2017 CLAIM: USPS RMN RE 322 399 251 US; I registered claim. Response to the 2nd Claim is the answer of silence: I accept the acquiescence and now claim full ownership of the private-property claimed in the exercise of my right.

3rd On the day September 15, 2017 CLAIM: USPS RMN RE 322 399 248 US; I registered claim. Response to the claim 3rd Claim is the answer of silence: I accept the acquiescence and now claim full ownership of the private-property claimed in the exercise of my right.

From all three Registered claims of my property is demonstrated by man a pattern of racketeering by: Jeff: USAG¹⁰, to steal my private-property under the color of statutory law. :Jeff is on record testifying in effect that of the wrong-doing the 'ends justifies the means' despite the Law of the Land¹¹ concerning my rights-executed and exercised.

:Jeff is in DISHONOR¹² upon the aforesaid. Therefore, i: man made claim to the man

8 Letter to man Ranier; role; chief judge: USDC-Arizona, USPS CMN 700- 1410 0000 7868 5703: p. 610- public records of the Recorder.gilacountyaz.gov, Gila County, Arizona, #2017-002378

9 August 16, 2016, CLAIM: USPS RMN RE 322 399 279 US; February 17, 2017 CLAIM: USPS RMN RE 322 399 251 US; and, September 15, 2017 CLAIM: USPS RMN RE 322 399 248 US

10 USAG means: man – 1) Loretta and 2) Jeff

1) Loretta: a) August 16, 2016, Claim-1: USPS RMN RE 322 399 279 US – Recv'd October 31, 2016,

b) October 14, 2016 /fu Claim-1: USPS RMN RE 322 399 282 US – Recv'd October 24, 2016,

c) November 10, 2016 /fu Claim-1: USPS CMN 7016 0340 0000 6402 7789 – Recv'd November 16, 2016,

d) November 16, 2016 /fu Claim-1: USPS RMN RB 898 810 007 US – Recv'd November 25, 2016; and,

2) Jeff: a) March 20, 2017 Claim-2: USPS RE 322 399 251 US – Recv'd April 04, 0217

b) July 13, 2017 /fu Claim-1: USPS RMN RE 322 399 058 US – Recv'd July 24, 2017,

c) July 13, 2017 /fu Claim-2: USPS RE 322 399 101 US – Recv'd July 24, 2017

d) August 11, 2017 /fu Claim-1 & Claim-2: USPS 7015 0640 0001 5883 2662 – Recv'd August 21, 2017

e) August 21, 2017 /fu Claim-1 & Claim-2: USPS 7015 0640 0001 5883 2716 – Recv'd August 28, 2017

f) September 15, 2017 Claim-3: USPS RE 322 399 248 US – Recv'd September 25, 0217

g) DISHONOR: January 17, 2018 /fu Claim-1, Claim-2 & Claim-3: USPS RMN RE 322 399 146 US – Recv'd January 29, 2018

11 LL means: SLL augmented by the 'Emancipation Proclamation' and the International Covenant on Civil and Political Rights', 'ICCPR', etc.

12 DISHONOR: USPS RMN RE 322 399 146 US: Jeff actor in the role of the fiduciary United States Attorney General Sessions, 'USAG', -January 2018 -- Recv'd January 29, 2018



653

:Holy Bible Book of Psalms 1

1. Blessed is the man that walketh not in the counsel of the ungodly, nor standeth in the way of sinners, nor sitteth in the seat of the scornful.

:Donald: POTUS¹³ Trump and military¹⁴ actors in the Registered Document: "DEMAND FOR THE FIDUCIARY PROTECTION OF FUNDAMENTAL RIGHTS", USPS RMN 322 399 150 US, recv'd 02/13/2018. Therein, i appointed the man :Donald :POTUS for to protect my property from theft/derelection for the obtainment of: a) claims; and, b) fee schedule bills¹⁵ now due¹⁶: CLAIM VIOLATIONS (3/3). To this date: answer to this claim is silence.

Federal, state, and local management knows of my private-property-claimed by rights-executed and exercised.

I require for you to respond in writing and address this trespass for the remedy against the apartheid of the rights of i: man :American State Citizen. Thank you.

Sincerely;

:Darrell-James Hill, son of the Most High God,
i:man

cc:	:Donald :appointed fiduciary¹⁷: Commander-in-Chief military :Joseph :actor in the role of the JCOS-General Dunford; :Mark :actor in the role of the COS Army General Miley c/o :Donald :actor in the role of the POTUS¹⁸ Trump 'United States government'¹⁹ 1600 Pennsylvania Ave NW
-----	--

13 POTUS means: man – 1) Barack and 2) Donald

1) Barack: September 09, 2016 *f/u Claim-1*: USPS RMN 322 398 208 US – Recv'd September 27, 2016

2) Donald a) July 13, 2017 *f/u Claim-1*: USPS RMN RE 322 399 044 US – Recv'd July 13, 2017

b) August 21, 2017 *f/u Claim-1*: USPS CMN 7015 0640 0001 5883 2709 – Recv'd August 22, 2017

c) c/o CJCOS: 1 August 23, 2017 *f/u Claim-1*: USPS RMN RE 322 399 132 US – Recv'd August 31, 2017

14 military means: 1) CJCOS Dunford, 2) COS Army Miley and 3) JCOS

1) CJCOS Dunford: September 09, 2016 *f/u Claim-1*: USPS RMN 322 398 211 US – Recv'd September 22, 2016

2) COS Army Miley: September 09, 2016 *f/u Claim-1*: USPS RMN 322 398 225 US – Recv'd September 16, 2016

3) COS c/o CJCOS: August 23, 2017 *f/u Claim-1 & Claim-2, Claim-3*: USPS RMN RE 322 399 132 US – Recv'd August 31, 2017

15 fee schedule remedy means: acquiesced fee schedule for the negligence of the fiduciary authority: 1 oz. silver U.S.

dollar/ minute : August 16, 2016, Claim-1: USPS RMN RE 322 399 279 US – Recv'd October 31, 2016;

November 16, 2016 *f/u Claim-1*: USPS RMN RB 898 810 007 US – Recv'd November 25, 2016; July 13, 2017 *f/u*

Claim-2: USPS RE 322 399 101 US – Recv'd July 24, 2017

16 For the Claim Trespasses is: January 09, 2018- ITEMIZED BILLS TOTAL DEBT DUE-PAID Now: 1,123,3006

~one million one hundred twenty-three thousand three hundred: 1- ounce .999 silver U.S. dollars.

17 fiduciary means: 'person' to whom some other natural person's property or the management of that property is trusted

18 POTUS meant: 2012-2016: Barack; and means 2017-now: Donald: "The President of the United States".

19 'United States government' means: 'United States Incorporated', et seq., administrating "United States Government"... ~1862 unto now under 'the Constitution for the United States of America'.

Letter to Senate Judiciary re:Letter: Donald re: Dishonor Session/ Property: USPS CMN 7015 0640 0001 5883 2747, February 26, 2018 3/4

2022-011769 MISC Page: 652 of 2782

09/26/2022 03:35:37 PM Receipt #: 22-9381

Rec Fee: \$30.00 Darrell James Hill

Gila County, Az, Sadie Jo Bingham, Recorder



:Holy Bible Book of Psalms 1

1. Blessed is the man that walketh not in the counsel of the ungodly, nor standeth in the way of sinners, nor sitteth in the seat of the scornful.

Washington, D.C. 20500	
Chuck Grassley	Fax: Washington DC Office <u>202-224-3744</u>
Dianne Feinstein	Fax: Washington DC Office <u>202-224-3841</u>
Orrin G. Hatch	Fax: Washington DC Office <u>202-224-5251</u>
Lindsey Graham	Fax: Washington DC Office <u>202-224-5972</u>
John Cornyn	Fax: Washington DC Office <u>202-224-2934</u>
Mike Lee	Fax: Washington DC Office <u>202-224-5444</u>
Ted Cruz	Fax: Washington DC Office <u>202-224-5922</u>
Ben Sasse	Fax: Washington DC Office <u>202-224-4224</u>
Jeff Flake	Fax: Washington DC Office <u>202-224-4521</u>
Mike Crapo	Fax: Washington DC Office <u>202-224-6142</u>
Thom Tillis	Fax: Washington DC Office <u>202-224-6342</u>
John Kennedy	Fax: Washington DC Office <u>202-224-4623</u>
Patrick Leahy	Fax: Washington DC Office <u>202-224-4242</u>
Richard Durbin	Fax: Washington DC Office <u>202-224-2152</u>
Sheldon Whitehouse	Fax: Washington DC Office <u>202-224-2921</u>
Amy Klobuchar	Fax: Washington DC Office <u>202-224-3244</u>
Christopher A. Coons	Fax: Washington DC Office <u>202-224-5042</u>
Richard Blumenthal	Fax: Washington DC Office <u>202-224-2823</u>
Mazie Hirono	Fax: Washington DC Office <u>202-224-6361</u>
Cory A. Booker	Fax: Washington DC Office <u>202-224-3224</u>
Kamala D. Harris	Fax: Washington DC Office <u>202-224-3553</u>

Letter to Senate Judiciary re:Letter: Donald re: Dishonor Session/ Property: USPS CMN 7015 0640 0001 5883 2747 , February 26, 2018 4/4

2022-011769 MISC Page: 653 of 2782
09/26/2022 03:35:37 PM Receipt #: 22-9381
Rec Fee: \$30.00 Darrell James Hill
Gila County, Az, Sadie Jo Bingham, Recorder



7015 0640 0000 5883 2754

U.S. Postal Service™
CERTIFIED MAIL® RECEIPT
Domestic Mail Only

For delivery information, visit our website at www.usps.com

OFFICIAL USE

Certified Mail Fee	\$3.45
Extra Services & Fees (check box, add fee as appropriate)	\$0.00
<input type="checkbox"/> Return Receipt (hardcopy)	\$0.00
<input type="checkbox"/> Return Receipt (electronic)	\$0.00
<input type="checkbox"/> Certified Mail Restricted Delivery	\$0.00
<input type="checkbox"/> Adult Signature Required	\$0.00
<input type="checkbox"/> Adult Signature Restricted Delivery	\$0.00

0130
06

Postmark
Here

Postage	\$0.71
Total Postage and Fees	\$4.16

02/28/2018

Sent To
 Street and Apt. No. Clara Senator Crowley
Director: Senator Feinstein
Committee on the Judiciary
224 Dirksen Senate Office Bldg
 City, State, ZIP+4® Washington, District of Columbia 20510-6050

PS Form 3800, April 2015 PSN 7530-01-000-9047 See Reverse for Instructions

U.S. Postal Service™
CERTIFIED MAIL® RECEIPT
Domestic Mail Only

For delivery information, visit our website at www.usps.com

OFFICIAL USE

Certified Mail Fee	\$3.45
Extra Services & Fees (check box, add fee as appropriate)	\$0.00
<input type="checkbox"/> Return Receipt (hardcopy)	\$0.00
<input type="checkbox"/> Return Receipt (electronic)	\$0.00
<input type="checkbox"/> Certified Mail Restricted Delivery	\$0.00
<input type="checkbox"/> Adult Signature Required	\$0.00
<input type="checkbox"/> Adult Signature Restricted Delivery	\$0.00

0130
06

Postmark
Here

Postage	\$0.71
Total Postage and Fees	\$4.16

02/28/2018

Sent To
 Street and Apt. No. or POB Belts Representative Goodlatte,
Jerrold: Representative Medina,
Committee on the Judiciary
2128 Rayburn House Office Bldg
 City, State, ZIP+4® Washington, District of Columbia 20515

PS Form 3800, April 2015 PSN 7530-01-000-9047 See Reverse for Instructions

U.S. Postal Service™
CERTIFIED MAIL® RECEIPT
Domestic Mail Only

For delivery information, visit our website at www.usps.com

OFFICIAL USE

Certified Mail Fee	\$3.45
Extra Services & Fees (check box, add fee as appropriate)	\$0.00
<input type="checkbox"/> Return Receipt (hardcopy)	\$0.00
<input type="checkbox"/> Return Receipt (electronic)	\$0.00
<input type="checkbox"/> Certified Mail Restricted Delivery	\$0.00
<input type="checkbox"/> Adult Signature Required	\$0.00
<input type="checkbox"/> Adult Signature Restricted Delivery	\$0.00

0130
06

Postmark
Here

Postage	\$0.71
Total Postage and Fees	\$4.16

02/28/2018

Sent To
 Street and Apt. No. or POB They: Representative Gowdy
Ernie: Representative Cummings,
Committee on Oversight and Government Reform
2127 Rayburn House Office Bldg
 City, State, ZIP+4® Washington, District of Columbia 20515

PS Form 3800, April 2015 PSN 7530-01-000-9047 See Reverse for Instructions

7015 0640 0000 6063 7029

7015 0640 0000 5883 2754

APACHE JUNCTION
 151 W SUPERSTITION BLVD
 APACHE JUNCTION
 AZ
 85120-9998
 0302590130
 (800)275-8777

02/28/2018 4:10 PM

Product Description	Sale Qty	Final Price
First-Class Mail Letter (Domestic) (WASHINGTON, DC 20510) (Weight:0 Lb 1.20 Oz) (Estimated Delivery Date) (Saturday 03/03/2018)	1	\$0.71
Certified (®USPS Certified Mail #) (70150640000158832754)	1	\$3.45
Affixed Postage (Affixed Amount:\$1.07)	1	(\$1.07)
First-Class Mail Letter (Domestic) (WASHINGTON, DC 20515) (Weight:0 Lb 1.20 Oz) (Estimated Delivery Date) (Saturday 03/03/2018)	1	\$0.71
Certified (®USPS Certified Mail #) (70150640000600637029)	1	\$3.45
Affixed Postage (Affixed Amount:\$0.87)	1	(\$0.87)
First-Class Mail Letter (Domestic) (WASHINGTON, DC 20515) (Weight:0 Lb 1.20 Oz) (Estimated Delivery Date) (Saturday 03/03/2018)	1	\$0.71
Certified (®USPS Certified Mail #) (70150640000158832761)	1	\$3.45
Affixed Postage (Affixed Amount:\$0.87)	1	(\$0.87)
Total		\$9.67
Cash		\$10.00
Change		(\$0.33)

Text your tracking number to 98777



USPS Tracking®

FAQs (<http://faq.usps.com/?articleId=220900>)

[Track Another Package](#) +

Tracking Number: 70150640000158832754

Remove

Expected Delivery on

TUESDAY

6 MARCH 2018 by **8:00pm**

Delivered

March 6, 2018 at 11:57 am
Delivered, Left with Individual
WASHINGTON, DC 20510

Get Updates

[Text & Email Updates](#)

[Tracking History](#)

March 6, 2018, 11:57 am
Delivered, Left with Individual
WASHINGTON, DC 20510
Your item was delivered to an individual at the address at 11:57 am on March 6, 2018 in WASHINGTON, DC 20510.

March 6, 2018, 8:58 am
Arrived at Unit
WASHINGTON, DC 20018

March 4, 2018, 12:21 pm
In Transit to Next Facility
On its way to WASHINGTON, DC 20510

March 3, 2018, 12:21 pm
In Transit to Next Facility
On its way to WASHINGTON, DC 20510

March 2, 2018, 12:21 pm
In Transit to Next Facility
On its way to WASHINGTON, DC 20510

March 1, 2018, 9:21 am
Departed USPS Regional Facility
PHOENIX AZ DISTRIBUTION CENTER

February 29, 2018, 7:44 pm
Arrived at USPS Regional Origin Facility
PHOENIX AZ DISTRIBUTION CENTER

657

2022-011769 MISC Page: 655 of 2782
 09/26/2022 03:35:37 PM Receipt #: 22-9381
 Rec Fee: \$30.00 Darrell James Hill
 Gila County, Az, Sadie Jo Bingham, Recorder



:Holy Bible Book of Psalms 1

1. Blessed is the man that walketh not in the counsel of the ungodly, nor standeth in the way of sinners, nor sitteth in the seat of the scornful.

:Darrell-James: Hill c/o PO Box 3806, Apache Junction, Arizona 85120

:February 26, 2018 A.D.

Chuck: Senator Grassley, Fax: Washington DC Office 202-224-3744
Dianne: Senator Feinstein, Fax: Washington DC Office 202-224-3841
Committee on the Judiciary
224 Dirksen Senate Office Bldg
Washington, District of Columbia 20510-6050

MAILING COVER SHEET

Dear Orin, Mitch, Greetings,

ATTACHED IS THE:

DEMAND FOR THE CONGRESSIONAL OVERSIGHT FOR THE ENFORCED PROTECTION OF FUNDAMENTAL RIGHTS-EXECUTED

with re: Donald :POTUS Trump Correspondence: "DEMAND FOR THE FIDUCIARY PROTECTION OF FUNDAMENTAL RIGHTS", USPS RMN 322 399 150 US :January 31, 2018, recv'd February 13, 2018; with re: Jeff: Office USAG² Sessions' DISHONOR by the apartheid^{3,4} of rights of i: man⁵ under the color of statutory law;

mailed to Donald: POTUS: USPS/CMN 7015 0640 0001 5883 2747; and, faxed to several Senate Judiciary having listed facsimile numbers (except: Ted, Ben, Patrick, Chris & Mazzie).

:Darrell-James: Hill

- 1 In the Correct-Sentence-Sense-Correct-Parse-Syntax-Grammar- prepositional phraseology
- 2 USAG means: man - 1) Loretta and 2) Jeff
- 3 Apartheid wrongdoings means: 'deprivations of this man's rights (under the color of the laws)
- 4 prejudice shown against the i:man means:
 - a) December 29, 2017: President Donald J. Trump Proclaims January 2018 as National Slavery ... Prevention Month, we recommit ourselves to eradicating the evil of enslavement... In addition to these governmental actions, Americans must learn how to identify and combat the evil of enslavement...
 - b) December 20, 2017: Executive Order Blocking the Property of Persons Involved in Serious Human Rights Abuse or Corruption, ... Human rights abuse and corruption undermine the values that form an essential foundation of stable, secure, and functioning societies; have devastating impacts of individuals; weaken democratic institutions; degrade the rule of law; The United States seeks to impose tangible and significant consequences on those who commit serious human rights abuse or engage in corruption....
- 5 i: man, i:man means: Almighty God's: man of the people of the nation states of America, "The United States of America"

COVER TO Senate Judiciary re:Letter/ PROPERTY USPS CMN 7015 0640 0001 5883 2754 , February 28, 2018 1/1

659
2022-011769 MISC Page: 656 of 2782
09/26/2022 03:35:37 PM Receipt #: 22-9381
Rec Fee: \$30.00 Darrell James Hill
Gila County, Az, Sadie Jo Bingham, Recorder

7015 0640 0001 5883 2754

7015 0640 0001 5883 2754

U.S. Postal Service™
CERTIFIED MAIL® RECEIPT
 Domestic Mail Only

For delivery information, visit our website at www.usps.com

WASHINGTON DC 20515
OFFICIAL USE

Certified Mail Fee	\$3.45	0130 06 Postmark Here
Extra Services & Fees (check box, add fee as appropriate)	\$0.00	
<input type="checkbox"/> Return Receipt (hardcopy)	\$0.00	
<input type="checkbox"/> Return Receipt (electronic)	\$0.00	
<input type="checkbox"/> Certified Mail Restricted Delivery	\$0.00	
<input type="checkbox"/> Adult Signature Required	\$0.00	
<input type="checkbox"/> Adult Signature Restricted Delivery	\$0.00	
Postage	\$0.71	02/28/2018
Total Postage and Fees	\$4.16	

Sent To: Clerk: Senator Cravens
 District: Senator Feinstein
 Committee on the Judiciary
 224 Dirksen Senate Office Bldg
 Washington, District of Columbia 20510-6050

PS Form 3800, April 2015 See Reverse for Instructions

7015 0640 0006 0063 7029

U.S. Postal Service™
CERTIFIED MAIL® RECEIPT
 Domestic Mail Only

For delivery information, visit our website at www.usps.com

WASHINGTON DC 20515
OFFICIAL USE

Certified Mail Fee	\$3.45	0130 06 Postmark Here
Extra Services & Fees (check box, add fee as appropriate)	\$0.00	
<input type="checkbox"/> Return Receipt (hardcopy)	\$0.00	
<input type="checkbox"/> Return Receipt (electronic)	\$0.00	
<input type="checkbox"/> Certified Mail Restricted Delivery	\$0.00	
<input type="checkbox"/> Adult Signature Required	\$0.00	
<input type="checkbox"/> Adult Signature Restricted Delivery	\$0.00	
Postage	\$0.71	02/28/2018
Total Postage and Fees	\$4.16	

Sent To: Sen Representative Goodlatte,
 Formerly: Representative Nadler,
 Committee on the Judiciary
 2133 Rayburn House Office Bldg
 Washington, District of Columbia 20515

PS Form 3800, April 2015 See Reverse for Instructions

7015 0640 0001 5883 2762

U.S. Postal Service™
CERTIFIED MAIL® RECEIPT
 Domestic Mail Only

For delivery information, visit our website at www.usps.com

WASHINGTON DC 20515
OFFICIAL USE

Certified Mail Fee	\$3.45	0130 06 Postmark Here
Extra Services & Fees (check box, add fee as appropriate)	\$0.00	
<input type="checkbox"/> Return Receipt (hardcopy)	\$0.00	
<input type="checkbox"/> Return Receipt (electronic)	\$0.00	
<input type="checkbox"/> Certified Mail Restricted Delivery	\$0.00	
<input type="checkbox"/> Adult Signature Required	\$0.00	
<input type="checkbox"/> Adult Signature Restricted Delivery	\$0.00	
Postage	\$0.71	02/28/2018
Total Postage and Fees	\$4.16	

Sent To: Terry Representative Gohmert,
 Formerly: Representative Cuccinelli,
 Committee on Oversight and Government Reform
 2137 Rayburn House Office Bldg
 Washington, District of Columbia 20515

PS Form 3800, April 2015 See Reverse for Instructions

APACHE JUNCTION
 151 W SUPERSTITION BLVD
 APACHE JUNCTION
 AZ
 85120-9998
 0302590130
 (800)275-8777 4:10 PM

Product Description	Sale Qty	Final Price
First-Class Mail Letter (Domestic) (WASHINGTON, DC 20510) (Weight:0 Lb 1.20 Oz) (Estimated Delivery Date) (Saturday 03/03/2018)	1	\$0.71
Certified (®USPS Certified Mail #) (70150640000158832754)	1	\$3.45
Affixed Postage (Affixed Amount:\$1.07)	1	(\$1.07)
First-Class Mail Letter (Domestic) (WASHINGTON, DC 20515) (Weight:0 Lb 1.20 Oz) (Estimated Delivery Date) (Saturday 03/03/2018)	1	\$0.71
Certified (®USPS Certified Mail #) (70150640000600637029)	1	\$3.45
Affixed Postage (Affixed Amount:\$0.87)	1	(\$0.87)
First-Class Mail Letter (Domestic) (WASHINGTON, DC 20515) (Weight:0 Lb 1.20 Oz) (Estimated Delivery Date) (Saturday 03/03/2018)	1	\$0.71
Certified (®USPS Certified Mail #) (70150640000158832761)	1	\$3.45
Affixed Postage (Affixed Amount:\$0.87)	1	(\$0.87)
Total		\$9.67
Cash		\$10.00
Change		(\$0.33)

Text your tracking number to 28777

689



USPS Tracking®

FAQs (<http://faq.usps.com/?articleId=220900>)

[Track Another Package](#)

Tracking Number: 70150640000158832754

Remove

Expected Delivery on

TUESDAY

6 MARCH 2018 by **8:00pm**

Delivered

March 6, 2018 at 11:57 am
Delivered, Left with Individual
WASHINGTON, DC 20510

Get Updates

Text & Email Updates

Tracking History

March 6, 2018, 11:57 am
Delivered, Left with Individual
WASHINGTON, DC 20510
Your item was delivered to an individual at the address at 11:57 am on March 6, 2018 in WASHINGTON, DC 20510.

March 6, 2018, 9:58 am
Arrived at Unit
WASHINGTON, DC 20018

March 4, 2018, 12:21 pm
In Transit to Next Facility
On its way to WASHINGTON, DC 20510

March 3, 2018, 12:21 pm
In Transit to Next Facility
On its way to WASHINGTON, DC 20510

March 2, 2018, 12:21 pm
In Transit to Next Facility
On its way to WASHINGTON, DC 20510

March 1, 2018, 9:21 am
Departed USPS Regional Facility
PHOENIX AZ DISTRIBUTION CENTER

February 28, 2018, 7:44 pm
Arrived at USPS Regional Origin Facility
PHOENIX AZ DISTRIBUTION CENTER



Copy

4660

:Holy Bible Book of Psalms 12

1 Why do the heathen rage, and the people imagine a vain thing? 2 The kings of the earth set themselves, and the rulers take counsel together, against the LORD, and against his anointed,

:Darrell-James: Hill c/o PO Box 3806, Apache Junction, Arizona 85120

:February 28, 2018 A.D.

Bob: Representative Goodlatte, Washington DC Office 202-225-5431
Jerrold: Representative Nadler, Washington DC Office 202-225-5635
Committee on the Judiciary
2138 Rayburn House Office Bldg
Washington, District of Columbia 20515

MAILING COVER SHEET

Dear Bob, Jerrold, Greetings,

ATTACHED IS THE:

DEMAND FOR THE CONGRESSIONAL OVERSIGHT FOR THE ENFORCED PROTECTION OF FUNDAMENTAL RIGHTS-EXECUTED

with re: Donald :POTUS Trump Correspondence: "DEMAND FOR THE FIDUCIARY PROTECTION OF FUNDAMENTAL RIGHTS", USPS RMN 322 399 150 US :January 31, 2018, recv'd February 13, 2018; with re: Jeff: Office USAG² Sessions' DISHONOR by the apartheid^{3 4} of rights of i: man⁵ under the color of statutory law;

mailed to Donald: POTUS: USPS CMN 7015 0640 0001 5883 2747; and, faxed to several House Judiciary members having listed facsimile numbers (except: Herrold N, J. Sensenbrenner Jr., Zoe L., A. Biggs, V. Demings, T. Deutch, M. Gaetz, P. Jayapal, G. Jeffries, Mike Johnson, Ted Lieu & J. Raskin),

:Darrell-James: Hill

- 1 In the Correct-Sentence-Sense-Correct-Parse-Syntax-Grammar- prepositional phraseology
- 2 USAG means: man – 1) Loretta and 2) Jeff
- 3 Apartheid wrongdoings means: 'deprivations of this man's rights (under the color of the laws)
- 4 prejudice shown against the i:man means:
 - a) December 29, 2017: President Donald J. Trump Proclaims January 2018 as National Slavery ... Prevention Month, we recommit ourselves to eradicating the evil of enslavement.... In addition to these governmental actions, Americans must learn how to identify and combat the evil of enslavement....
 - b) December 20, 2017: Executive Order Blocking the Property of Persons Involved in Serious Human Rights Abuse or Corruption, ... Human rights abuse and corruption undermine the values that form an essential foundation of stable, secure, and functioning societies; have devastating impacts of individuals; weaken democratic institutions; degrade the rule of law; The United States seeks to impose tangible and significant consequences on those who commit serious human rights abuse or engage in corruption....
- 5 i: man, i:man means: Almighty God's: man of the people of the nation states of America, "The United States of America"

COVER TO House Judiciary re:Letter/ PROPERTY USPS CMN 7015 0640 0006 0063 7029 , February 28, 2018 1/1

661
2022-011769 MISC Page: 659 of 2782
09/26/2022 03:35:37 PM Receipt #: 22-9381
Rec Fee: \$30.00 Darrell James Hill
Gila County, Az, Sadie Jo Bingham, Recorder



:Holy Bible Book of Psalms 1

1 Why do the heathen rage, and the people imagine a vain thing? 2 The kings of the earth set themselves, and the rulers take counsel together, against the LORD, and against his anointed,

Washington, D.C. 20500	
Rep. Bob Goodlatte	Washington: 202-225-5431
Rep. Herrold Nadler	Washington: 202-225-5635
Rep. Darrell Issa	Washington: 202-225-3906
Rep. Steve King	Washington: 202-225-4426
Rep. Raul Labrador	Washington: 202-225-6611
Rep. Tom Marino	Washington: 202-225-3731
Rep. Jams Sensenbrenner Jr.	Washington: 202-225-5101
Rep. Doug Collins	Washington: 202-225-9893
Rep. Ron DeSantis	Washington: 202-225-2706
Rep. Blake Farenthold	Washington: 202-225-7742
Rep. Louie Gohmert Jr.	Washington: 202-225-3035
Rep. David Cicilline	Washington: 202-225-4911
Rep. Steve Cohen	Washington: 202-225-5663
Rep. Sheila Jackson Lee	Washington: 202-225-3816
Rep. Henry "Hank" Johnson Jr.	Washington: 202-225-1605
Rep. Zoe Lofgren	Washington: 202-225-3072
Rep. Karen Bass	Washington: 202-225-7084
Rep. Andy Biggs	Washington: 202-225-2635
Rep. Ken Buck	Washington: 202-225-4676
Rep. Steve Chabot	Washington: 202-225-2216
Rep. Val Demings	Washington: 202-225-2176
Rep. Theodore Deutch	Washington: 202-225-3001
Rep. Matt Gaetz	Washington: 202-225-4136
Rep. Trey Gowdy	Washington: 202-225-6030
Rep. Luis Gutierrez	Washington: 202-225-8203
Rep. Karen Handel	Washington: 202-225-4501
Rep. Pramila Jayapal	Washington: 202-225-3106

Letter to House Judiciary re:Letter: Donald re: Dishonor Session/ Property: USPS CMN 7015 0640 0006 0063 7029 , February 28, 2018 4/5

662

2022-011769 MISC Page: 660 of 2782

09/26/2022 03:35:37 PM Receipt #: 22-9381

Rec Fee: \$30.00 Darrell James Hill

Gila County, Az, Sadie Jo Bingham, Recorder



:Holy Bible Book of Psalms 1

1 Why do the heathen rage, and the people imagine a vain thing? 2 The kings of the earth set themselves, and the rulers take counsel together, against the LORD, and against his anointed,

Rep. Hakeem Jeffries	Washington: 202-225-5936
Rep. Mike Johnson	Washington: 202-225-2777
Rep. Jim Jordan	Washington: 202-225-2676
Rep. Ted Lieu	Washington: 202-225-3976
Rep. Ted Poe	Washington: 202-225-6565
Rep. Jamie Raskin	Washington: 202-225-5341
Rep. John Ratcliffe	Washington: 202-225-6673
Rep. Cedric Richmond	Washington: 202-225-6636
Rep. Martha Roby	Washington: 202-225-2901
Rep. John Rutherford	Washington: 202-225-2501
Rep. Bradley Schneider	Washington: 202-225-4835
Rep. Lamar Smith	Washington: 202-225-4236
Rep. Eric Swalwell	Washington: 202-225-5065

Letter to House Judiciary re:Letter: Donald re: Dishonor Session/ Property: USPS CMN 7015 0640 0006 0063 7029 , February 28, 2018 5/5

2022-011769 MISC Page: 661 of 2782
09/26/2022 03:35:37 PM Receipt #: 22-9381
Rec Fee: \$30.00 Darrell James Hill
Gila County, Az, Sadie Jo Bingham, Recorder

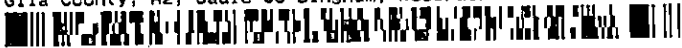

4522 5825 7000 0649 5833 2754

U.S. Postal Service™
CERTIFIED MAIL® RECEIPT
 Domestic Mail Only

For delivery information, visit our website at www.usps.com

WASHINGTON DC 20515 OFFICIAL USE

Certified Mail Fee	\$3.45	0130 06 Postmark Here
Extra Services & Fees (check box, add fee as appropriate)	\$0.00	
<input type="checkbox"/> Return Receipt (hardcopy)	\$0.00	
<input type="checkbox"/> Return Receipt (electronic)	\$0.00	
<input type="checkbox"/> Certified Mail Restricted Delivery	\$0.00	
<input type="checkbox"/> Adult Signature Required	\$0.00	02/28/2018
<input type="checkbox"/> Adult Signature Restricted Delivery	\$0.00	
Postage	\$0.71	
Total Postage and Fees	\$4.16	

Sent To: **Clasik Senator Grazley**
 District Senator Feinstein
 Committee on the Judiciary
 224 Dirksen Senate Office Bldg
 Washington, District of Columbia 20510-6050

PS Form 3800, April 2015 PSN 7550-02-000-9047 See Reverse for Instructions

APACHE JUNCTION
 151 W SUPERSTITION BLVD
 APACHE JUNCTION
 AZ
 85120-9998
 0302590130
 (800)275-8777 4:10 PM

Product Description	Sale Qty	Final Price
First-Class Mail Letter	1	\$0.71

(Domestic)
 (WASHINGTON, DC 20510)
 (Weight:0 Lb 1.20 Oz)
 (Estimated Delivery Date)
 (Saturday 03/03/2018)

Certified 1 \$3.45
 (@USPS Certified Mail #)
 (70150640000158832754)

Affixed Postage 1 (\$1.07)
 (Affixed Amount:\$1.07)

First-Class Mail Letter
 (Domestic)
 (WASHINGTON, DC 20515)
 (Weight:0 Lb 1.20 Oz)
 (Estimated Delivery Date)
 (Saturday 03/03/2018)

Certified 1 \$3.45
 (@USPS Certified Mail #)
 (70150640000600637029)

Affixed Postage 1 (\$0.87)
 (Affixed Amount:\$0.87)

First-Class Mail Letter
 (Domestic)
 (WASHINGTON, DC 20515)
 (Weight:0 Lb 1.20 Oz)
 (Estimated Delivery Date)
 (Saturday 03/03/2018)

Certified 1 \$3.45
 (@USPS Certified Mail #)
 (70150640000158832761)

Affixed Postage 1 (\$0.87)
 (Affixed Amount:\$0.87)

Total \$9.67
 Cash \$10.00
 Change (\$0.33)

Text your tracking number to 28777

7015 0640 0006 0063 7028

U.S. Postal Service™
CERTIFIED MAIL® RECEIPT
 Domestic Mail Only

For delivery information, visit our website at www.usps.com

WASHINGTON DC 20515 OFFICIAL USE

Certified Mail Fee	\$3.45	0130 06 Postmark Here
Extra Services & Fees (check box, add fee as appropriate)	\$0.00	
<input type="checkbox"/> Return Receipt (hardcopy)	\$0.00	
<input type="checkbox"/> Return Receipt (electronic)	\$0.00	
<input type="checkbox"/> Certified Mail Restricted Delivery	\$0.00	
<input type="checkbox"/> Adult Signature Required	\$0.00	02/28/2018
<input type="checkbox"/> Adult Signature Restricted Delivery	\$0.00	
Postage	\$0.71	
Total Postage and Fees	\$4.16	

Sent To: **Rob: Representative Goodlatz,**
Jerrold: Representative Nadler,
 Committee on the Judiciary
 2138 Rayburn House Office Bldg
 Washington, District of Columbia 20515

PS Form 3800, April 2015 PSN 7550-02-000-9047 See Reverse for Instructions

U.S. Postal Service™
CERTIFIED MAIL® RECEIPT
 Domestic Mail Only

For delivery information, visit our website at www.usps.com

WASHINGTON DC 20515 OFFICIAL USE

Certified Mail Fee	\$3.45	0130 06 Postmark Here
Extra Services & Fees (check box, add fee as appropriate)	\$0.00	
<input type="checkbox"/> Return Receipt (hardcopy)	\$0.00	
<input type="checkbox"/> Return Receipt (electronic)	\$0.00	
<input type="checkbox"/> Certified Mail Restricted Delivery	\$0.00	
<input type="checkbox"/> Adult Signature Required	\$0.00	02/28/2018
<input type="checkbox"/> Adult Signature Restricted Delivery	\$0.00	
Postage	\$0.71	
Total Postage and Fees	\$4.16	

Sent To: **Trey: Representative Gowdy**
Erjahn: Representative Cummings,
 Committee on Oversight and Government Reform
 2157 Rayburn House Office Bldg
 Washington, District of Columbia 20515

PS Form 3800, April 2015 PSN 7550-02-000-9047 See Reverse for Instructions

7922 5825 7000 0640 5833 2761

2022-011769 MISC Page: 662 of 2782
 09/26/2022 03:35:37 PM Receipt #: 22-9381
 Rec Fee: \$30.00 Darrell James Hill
 Gila County, Az, Sadie Jo Bingham, Recorder



:Holy Bible Book of Psalms 1

1 Why do the heathen rage, and the people imagine a vain thing? 2 The kings of the earth set themselves, and the rulers take counsel together, against the LORD, and against his anointed,

:Darrell-James: Hill c/o PO Box 3806, Apache Junction, Arizona 85120

:February 28, 2018 A.D.

Trey: Representative Gowdy, Washington DC Office 202-225-6030
Elijah: Representative Cummings, Washington DC Office 202-225-4741
Committee on Oversight and Government Reform
Washington, District of Columbia 20515

DEMAND FOR THE CONGRESSIONAL OVERSIGHT FOR THE ENFORCED PROTECTION OF FUNDAMENTAL RIGHTS-EXECUTED

with re: Donald :POTUS Trump Correspondence: "DEMAND FOR THE FIDUCIARY PROTECTION OF FUNDAMENTAL RIGHTS", USPS RMN 322-399 150 US :January 31, 2018, recv'd February 13, 2018; with re: Jeff: Office USAG² Sessions' DISHONOR by the apartheid^{3,4} of rights of i: man⁵ under the color of statutory law.

Dear Trey, Elijah, Greetings,

i: man :Darrell-James: Hill :one of the Ohio state Citizens, member of the united States of America people is an American State Citizen.

i write to obtain a) Congressional enforcement protections of my⁶ Almighty God-given rights-executed and exercised⁷ for to acquire private-property claims owned; and, because b.i.) the USAGs willfully thief millions of dollars of my private-property, and b.ii) :USDC-Arizona, known

- 1 In the Correct-Sentence-Sense-Correct-Parse-Syntax-Grammar- prepositional phraseology
- 2 USAG means: man - 1) Loretta and 2) Jeff
- 3 Apartheid wrongdoings means: 'deprivations of this man's rights (under the color of the laws)
- 4 prejudice shown against the i:man means:
 - a) December 29, 2017: President Donald J. Trump Proclaims January 2018 as National Slavery ... Prevention Month, we recommit ourselves to eradicating the evil of enslavement.... In addition to these governmental actions, Americans must learn how to identify and combat the evil of enslavement....
 - b) December 20, 2017: Executive Order Blocking the Property of Persons Involved in Serious Human Rights Abuse or Corruption, ... Human rights abuse and corruption undermine the values that form an essential foundation of stable, secure, and functioning societies; have devastating impacts of individuals; weaken democratic institutions; degrade the rule of law; The United States seeks to impose tangible and significant consequences on those who commit serious human rights abuse or engage in corruption....
- 5 i: man, i:man means: Almighty God's: man of the people of the nation states of America, "The United States of America"
- 6 i:man is: one of the people of The United States of America and owner of the private-property by the showing of the claim
- 7 ICCPR Senate ratification: March 1992: 'rights executed are promoted and protected by the full power of the United States'

Letter to House Oversight re:Letter: Donald re: Dishonor Session/ Property: USPS CMN 7015 0640 0001 58833 2761 , February 28, 2018 1/5

2022-011769 MISC Page: 663 of 2782
09/26/2022 03:35:37 PM Receipt #: 22-9381
Rec Fee: \$30.00 Darrell James Hill
Gila County, Az, Sadie Jo Bingham, Recorder



:Holy Bible Book of Psalms 1

1 Why do the heathen rage, and the people imagine a vain thing? 2 The kings of the earth set themselves, and the rulers take counsel together, against the LORD, and against his anointed,

to the management, yet is derelict to file the USPS Registered Claim delivered to him by me for the suit for my property in a common law court at the USDC -Arizona, Phoenix venue⁸.

HISTORY

i: man have three (3) times claimed of the private-property⁹, ordered given by the several district courts to the United States of America people: to wit:

- 1st On the day August 16, 2016, CLAIM: USPS RMN RE 322 399 279 US; I registered the claim. Response to the 1st Claim is the answer of silence: I accept the acquiescence and now claim full ownership of the private-property claimed in the exercise of my right.
- 2nd On the day February 17, 2017 CLAIM: USPS RMN RE 322 399 251 US; I registered claim. Response to the 2nd Claim is the answer of silence: I accept the acquiescence and now claim full ownership of the private-property claimed in the exercise of my right.
- 3rd On the day September 15, 2017 CLAIM: USPS RMN RE 322 399 248 US; I registered claim. Response to the claim 3rd Claim is the answer of silence: I accept the acquiescence and now claim full ownership of the private-property claimed in the exercise of my right.

From all three Registered claims of my property is demonstrated by man a pattern of racketeering by: Jeff: USAG¹⁰, to steal my private-property under the color of statutory law. :Jeff is on record testifying in effect that of the wrong-doing the 'ends justifies the means' despite the Law of the Land¹¹ concerning my rights-executed and exercised.

:Jeff is in DISHONOR¹² upon the aforesaid. Therefore, i: man made claim to the man

8 Letter to man Ranier; role; chief judge: USDC-Arizona, USPS CMN 700- 1410 0000 7868 5703: p. 610- public records of the Recorder.gilacountyaz.gov, Gila County, Arizona, #2017-002378

9 August 16, 2016, CLAIM: USPS RMN RE 322 399 279 US; February 17, 2017 CLAIM: USPS RMN RE 322 399 251 US; and, September 15, 2017 CLAIM: USPS RMN RE 322 399 248 US

10 USAG means: man - 1) Loretta and 2) Jeff

- 1) Loretta: a) August 16, 2016, Claim-1: USPS RMN RE 322 399 279 US - Recv'd October 31, 2016, b) October 14, 2016 *fu* Claim-1: USPS RMN RE 322 399 282 US - Recv'd October 24, 2016, c) November 10, 2016 *fu* Claim-1: USPS CMN 7016 0340 0000 6402 7789 - Recv'd November 16, 2016, d) November 16, 2016 *fu* Claim-1: USPS RMN RB 898 810 007 US - Recv'd November 25, 2016; and,
- 2) Jeff: a) March 20, 2017 Claim-2: USPS RE 322 399 251 US - Recv'd April 04, 2017 b) July 13, 2017 *fu* Claim-1: USPS RMN RE 322 399 058 US - Recv'd July 24, 2017, c) July 13, 2017 *fu* Claim-2: USPS RE 322 399 101 US - Recv'd July 24, 2017 d) August 11, 2017 *fu* Claim-1 & Claim-2: USPS 7015 0640 0001 5883 2662 - Recv'd August 21, 2017 e) August 21, 2017 *fu* Claim-1 & Claim-2: USPS 7015 0640 0001 5883 2716 - Recv'd August 28, 2017 f) September 15, 2017 Claim-3: USPS RE 322 399 248 US - Recv'd September 25, 2017 g) DISHONOR: January 17, 2018 *fu* Claim-1, Claim-2 & Claim-3: USPS RMN RE 322 399 146 US - Recv'd January 29, 2018

11 LL means: SLL augmented by the 'Emancipation Proclamation' and the International Covenant on Civil and Political Rights, 'ICCPR', etc.

12 DISHONOR: USPS RMN RE 322 399 146 US: Jeff actor in the role of the fiduciary United States Attorney General Sessions, 'USAG', -January 2018 - Recv'd January 29, 2018

Letter to House Oversight and Letter Donald Lee Dishonor Session (Proposed USPS CMN 7015 0640 0001 5883 2761, February 28, 2018 2/5

2022-011769 MISC Page: 664 of 2782
09/28/2022 03:35:37 PM Receipt #: 22-9381
Rec Fee: \$30.00 Darrell James Hill
Gila County, Az, Sadie Jo Bingham, Recorder



:Holy Bible Book of Psalms 1

1 Why do the heathen rage, and the people imagine a vain thing? 2 The kings of the earth set themselves, and the rulers take counsel together, against the LORD, and against his anointed,

:Donald: POTUS¹³ Trump and military¹⁴ actors in the Registered Document: "DEMAND FOR THE FIDUCIARY PROTECTION OF FUNDAMENTAL RIGHTS", USPS RMN 322 399 150 US, recv'd 02/13/2018. Therein, i appointed the man :Donald :POTUS for to protect my property from theft/derelection for the obtainment of: a) claims; and, b) fee schedule bills¹⁵ now due ¹⁶: CLAIM VIOLATIONS (3/3). To this date: answer to this claim is silence.

Federal, state, and local management knows of my private-property-claimed by rights-executed and exercised.

I require for you to respond in writing and address this trespass for the remedy against the apartheid of the rights of i: man :American State Citizen. Thank you.

Sincerely;

Darrell Hill



:Darrell-James: Hill :son of the Most High God, i:man

**cc: :Donald :appointed fiduciary¹⁷: Commander-in-Chief military
:Joseph :actor in the role of the JCOS General Dunford;
:Mark :actor in the role of the COS Army General Miley
c/o :Donald :actor in the role of the POTUS¹⁸ Trump 'United States government'¹⁹
1600 Pennsylvania Ave NW**

13 POTUS means: man - 1) Barack and 2) Donald

1) Barack: September 09, 2016 *ffu Claim-1*: USPS RMN 322 398 208 US - Recv'd September 27, 2016

2) Donald a) July 13, 2017 *ffu Claim-1*: USPS RMN RE 322 399 044 US - Recv'd July 13, 2017

b) August 21, 2017 *ffu Claim-1*: USPS CMN 7015 0640 0001 5883 2709 - Recv'd August 22, 2017

c) c/o CJCOS: 1 August 23, 2017 *ffu Claim-1*: USPS RMN RE 322 399 132 US - Recv'd August 31, 2017

14 military means: 1) CJCOS Dunford, 2) COS Army Miley and 3) JCOS

1) CJCOS Dunford: September 09, 2016 *ffu Claim-1*: USPS RMN 322 398 211 US - Recv'd September 22, 2016

2) COS Army Miley: September 09, 2016 *ffu Claim-1*: USPS RMN 322 398 225 US - Recv'd September 16, 2016

3) COS c/o CJCOS: August 23, 2017 *ffu Claim-1 & Claim-2, Claim-3*: USPS RMN RE 322 399 132 US - Recv'd August 31, 2017

15 fee schedule remedy means: acquiesced fee schedule for the negligence of the fiduciary authority: 1 oz. silver U.S. dollar/ minute : August 16, 2016, Claim-1: USPS RMN RE 322 399 279 US - Recv'd October 31, 2016;

November 16, 2016 *ffu Claim-1*: USPS RMN RB 898 810 007 US - Recv'd November 25, 2016; July 13, 2017 *ffu Claim-2*: USPS RE 322 399 101 US - Recv'd July 24, 2017

16 For the Claim Trespasses is: January 09, 2018- ITEMIZED BILLS TOTAL DEBT DUE-PAID Now: 1,123,3006 ~one million one hundred twenty-three thousand three hundred: 1- ounce .999 silver U.S. dollars.

17 fiduciary means: 'person' to whom some other natural person's property or the management of that property is trusted

18 POTUS meant: 2012-2016: Barack; and means 2017-now: Donald: "The President of the United States".

19 'United States government' means: 'United States Incorporated', et seq., administrating "United States Government"... ~1862 unto now under 'the Constitution for the United States of America'.

Letter to House Oversight re:Letter: Donald re: Dishonor Session/ Property: USPS CMN 7015 0640 0001 58833 2761 , February 28, 2018 3/5

2022-011769 MISC Page: 665 of 2782

09/25/2022 03:35:37 PM Receipt #: 22-9381
Rec Fee: \$30.00 Darrell James Hill

Gila County, Az, Sadie Jo Bingham, Recorder



667

:Holy Bible Book of Psalms 1

1 Why do the heathen rage, and the people imagine a vain thing? 2 The kings of the earth set themselves, and the rulers take counsel together, against the LORD, and against his anointed,

Washington, D.C. 20500	
Rep. Trey Gowdy	Washington: 202-225-6030
Rep. Elijah Cummings	Washington: 202-225-4741
Rep. Ron DeSantis	Washington: 202-225-2706
Rep. Blake Farenthold	Washington: 202-225-7742
Rep. Will Hurd	Washington: 202-225-4511
Rep. Mark Meadows	Washington: 202-225-6401
Rep. Gary Palmer	Washington: 202-225-4921
Rep. Paul Gosar	Washington: 202-225-2315
Rep. Glenn Grothman	Washington: 202-225-2476
Rep. Jody Hice	Washington: 202-225-4101
Rep. Stephen Lynch	Washington: 202-225-8273
Rep. Stacey E. Plaskett	Washington: 202-225-1790
Rep. Justin Amash	Washington: 202-225-3831
Rep. Rod Blum	Washington: 202-225-2911
Rep. Matt Cartwright	Washington: 202-225-5546
Rep. William Clay	Washington: 202-225-2406
Rep. James Comer	Washington: 202-225-3115
Rep. Jim Cooper	Washington: 202-225-4311
Rep. Mark DeSaulnier	Washington: 202-225-2095
Rep. Scott DesJarlais	Washington: 202-225-6831
Rep. Jimmy Duncan	Washington: 202-225-5435
Rep. Virginia Foxx	Washington: 202-225-2071
Rep. Greg Gianforte	Washington: 202-225-3211
Rep. Jimmy Gomez	
Rep. Darrell Issa	Washington: 202-225-3906

Letter to House Oversight re: Letter. Donald re: Dishonor Session/ Property: USPS CMN 7015 0640 0001 58833 2761, February 28, 2018 4/5

068
2022-011769 MISC Page: 666 of 2782
09/26/2022 03:35:37 PM Receipt #: 22-9381
Rec Fee: \$30.00 Darrell James Hill
Gila County, Az, Sadie Jo Bingham, Recorder

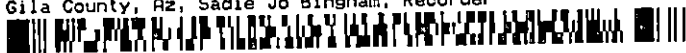

:Holy Bible Book of Psalms 1

1 Why do the heathen rage, and the people imagine a vain thing? 2 The kings of the earth set themselves, and the rulers take counsel together, against the LORD, and against his anointed,

Rep. Brenda Lawrence	Washington: 202-225-5802
Rep. Carolyn Maloney	Washington: 202-225-7944
Rep. Thomas Massie	Washington: 202-225-3465
Rep. Eleanor Holmes Norton	Washington: 202-225-8050
Rep. Jamie Raskin	Washington: 202-225-5341
Rep. Dennis Ross	Washington: 202-225-1252
Rep. Mark Sanford	Washington: 202-225-3176
Rep. Bonnie Watson Coleman	Washington: 202-225-5801
Rep. Peter Welch	Washington: 202-225-4115

Letter to House Oversight re: Letter, Donald re: Dishonor Session/Property: USPS CMN 7015 0640 0001 58833 2761 , February 28, 2018 5/5

669
2022-011769 MISC Page: 667 of 2782
09/26/2022 03:35:37 PM Receipt #: 22-9381
Rec Fee: \$30.00 Darrell James Hill
Gila County, AZ, Sadie Jo Bingham, Recorder



7015 0640 0001 5883 2754

CERTIFIED MAIL RECEIPT

Domestic Mail Only

For delivery information, visit our website at www.usps.com

WASHINGTON DC 20510 OFFICIAL USE

Certified Mail Fee	\$3.45	0130 06
Extra Services & Fees (check box, add fee as appropriate)	\$0.00	
<input type="checkbox"/> Return Receipt (hardcopy)	\$0.00	Postmark Here
<input type="checkbox"/> Return Receipt (electronic)	\$0.00	
<input type="checkbox"/> Certified Mail Restricted Delivery	\$0.00	
<input type="checkbox"/> Adult Signature Required	\$0.00	
<input type="checkbox"/> Adult Signature Restricted Delivery	\$0.00	
Postage	\$0.71	02/28/2018
Total Postage and Fees	\$4.16	

Sent To: Clerk Senator Crutcher
 Street and Apt. No.: 224 Dirksen Senate Office Bldg
 City, State, ZIP: Washington, District of Columbia 20510-0600

PS Form 3800, April 2015 Edition See Reverse for Instructions

U.S. Postal Service™ CERTIFIED MAIL® RECEIPT

Domestic Mail Only

For delivery information, visit our website at www.usps.com

WASHINGTON DC 20515 OFFICIAL USE

Certified Mail Fee	\$3.45	0130 06
Extra Services & Fees (check box, add fee as appropriate)	\$0.00	
<input type="checkbox"/> Return Receipt (hardcopy)	\$0.00	Postmark Here
<input type="checkbox"/> Return Receipt (electronic)	\$0.00	
<input type="checkbox"/> Certified Mail Restricted Delivery	\$0.00	
<input type="checkbox"/> Adult Signature Required	\$0.00	
<input type="checkbox"/> Adult Signature Restricted Delivery	\$0.00	
Postage	\$0.71	02/28/2018
Total Postage and Fees	\$4.16	

Sent To: Debt Representative Goodrich,
 Street and Apt. No.: 2138 Rayburn House Office Bldg
 City, State, ZIP: Washington, District of Columbia 20515

PS Form 3800, April 2015 Edition See Reverse for Instructions

U.S. Postal Service™ CERTIFIED MAIL® RECEIPT

Domestic Mail Only

For delivery information, visit our website at www.usps.com

WASHINGTON DC 20515 OFFICIAL USE

Certified Mail Fee	\$3.45	0130 06
Extra Services & Fees (check box, add fee as appropriate)	\$0.00	
<input type="checkbox"/> Return Receipt (hardcopy)	\$0.00	Postmark Here
<input type="checkbox"/> Return Receipt (electronic)	\$0.00	
<input type="checkbox"/> Certified Mail Restricted Delivery	\$0.00	
<input type="checkbox"/> Adult Signature Required	\$0.00	
<input type="checkbox"/> Adult Signature Restricted Delivery	\$0.00	
Postage	\$0.71	02/28/2018
Total Postage and Fees	\$4.16	

Sent To: Debt Representative Gowdy
 Street and Apt. No.: 2137 Rayburn House Office Bldg
 City, State, ZIP: Washington, District of Columbia 20515

PS Form 3800, April 2015 Edition See Reverse for Instructions

APACHE JUNCTION
 151 W SUPERSTITION BLVD
 APACHE JUNCTION
 AZ
 85120-9998
 0302590130
 (800)275-8777 4:10 PM

Product Description	Sale Qty	Final Price
First-Class Mail Letter	1	\$0.71

(Domestic)
 (WASHINGTON, DC 20510)
 (Weight: 0 Lb 1.20 Oz)
 (Estimated Delivery Date)
 (Saturday 03/03/2018)

Certified 1 \$3.45
 (USPS Certified Mail #)
 (70150640000158832754)

Affixed Postage 1 (\$1.07)
 (Affixed Amount: \$1.07)

First-Class Mail Letter 1 \$0.71

(Domestic)
 (WASHINGTON, DC 20515)
 (Weight: 0 Lb 1.20 Oz)
 (Estimated Delivery Date)
 (Saturday 03/03/2018)

Certified 1 \$3.45
 (USPS Certified Mail #)
 (70150640000600637029)

Affixed Postage 1 (\$0.87)
 (Affixed Amount: \$0.87)

First-Class Mail Letter 1 \$0.71

(Domestic)
 (WASHINGTON, DC 20515)
 (Weight: 0 Lb 1.20 Oz)
 (Estimated Delivery Date)
 (Saturday 03/03/2018)

Certified 1 \$3.45
 (USPS Certified Mail #)
 (70150640000158832761)

Affixed Postage 1 (\$0.87)
 (Affixed Amount: \$0.87)

Total \$9.67

Cash Change \$10.00 (\$0.33)

Text your tracking number to 28777.

7015 0640 0006 0063 7029

7015 0640 0001 5883 2761

670



:Darrell-James: Hill P.O. Box 3806, Apache Junction, Arizona 85120 602.618.4595

:Paul :Representative Gosar 480-882-2697
Gold Canyon Office
6499 S. Kings Ranch Road, #4
Gold Canyon, Arizona 85118

7015 1730 0002 3063 9379

Dear Paul, greetings;

i:man contact you for remedy from a deprivation of rights and property problem. Attached is the copy of the document received to the House Oversight and Government Reform Committee that illustrates the situation.

With regard to the document content:

- a) the private-property discussed was by the U.S. courts ordered disposed to the The United States of America people, which is i:man.
- b) The self-operated execution of the claims by i:man are guaranteed-protected by i) the U.S. Government under the Supreme Law of the land: under The Constitution for the United States of America – Bill of Rights, et seq.; and, ii) by the ICCPR Treaty -1992 (International Covenant on Civil and Political Rights), the duty and obligation of the federal government, et al., the U.S. government is under mandatory duty and obligation to protect, promote, ensure and enforce the self-operated rights executed by i:man.
- c) i:man registered three claims for specific private-property.
- d) :Almighty God-given rights timely exercised in the execution of the three registered claims is whereby ownership of the property is established to i:man :Darrell-James: Hill.
- e) Each claim i:man registered was answered by silent agreement to the rights executed.
- f) i:man accept silent agreement and seek now to obtain i) 100% of the property, and ii) immediate payment of the amounts due to-date for the trespass-upon-the-claims according to the fee schedule in place to direct in this event.
- g) The withholding of the property and the trespass payment from i:man is not authorized.
- h) The unauthorized possession or otherwise distribution of the specific private-property referred to herein is evidence of wrong-doing and/or theft under the color of law.

Conservative remedy for the daily ongoing injury to i:man is the direct and unrestrained enforced rights for the immediate actions of 1) obtainment of the private-property detailed in the three registered claims, and 2) payment of all fees now due and until the full resolve of the trespass upon each claim.

I look forward to your favorable help within the obligation to protect, promote, ensure and enforce the self-operated rights executed by i:man.

Sincerely,

March 15, 2018

:Darrell-James: Hill
:Darrell-James: Hill, son of the Most High
God, i:man

071
2022-011769 MISC Page: 669 of 2782
09/26/2022 03:35:37 PM Receipt #: 22-9361
Rec Fee: \$30.00 Darrell James Hill
Gila County, Az, Sadie Jo Bingham, Recorder



7015 1730 0002 3063 9374

U.S. Postal Service™
CERTIFIED MAIL® RECEIPT
Domestic Mail Only

For delivery information, visit our website at www.usps.com

OFFICIAL USE

Certified Mail Fee	\$3.45
Extra Services & Fees (check box, add fee as appropriate)	\$0.00
<input type="checkbox"/> Return Receipt (hardcopy)	\$0.00
<input type="checkbox"/> Return Receipt (electronic)	\$0.00
<input type="checkbox"/> Certified Mail Restricted Delivery	\$0.00
<input type="checkbox"/> Adult Signature Required	\$0.00
<input type="checkbox"/> Adult Signature Restricted Delivery	\$0.00
Postage	\$0.71
Total Postage and Fees	\$4.16

0130
07
Postmark
Here
03/19/2018

Sent To
Street and Apt. No., or PO Box: John Senator McCain
2201 East Camelback Road, Suite 115
City, State, ZIP+4®: Phoenix, Arizona 85016

PS Form 3800, April 2015 PSN 7530-02-000-9047 See Reverse for Instructions

APACHE JUNCTION
151 W SUPERSTITION BLVD
APACHE JUNCTION
AZ
85120-9998
0302590130
(800)275-8777 12:41 PM

Product Description: First-Class Mail Letter (Domestic) (PHOENIX, AZ 85016) (Weight: 0 Lb 1.30 Oz) (Estimated Delivery Date) (Wednesday 03/21/2018)

Certified 1 \$3.45
((USPS Certified Mail #) (70151730000230639386))
First-Class Mail Letter (Domestic) (PHOENIX, AZ 85016) (Weight: 0 Lb 1.30 Oz) (Estimated Delivery Date) (Wednesday 03/21/2018)

Certified 1 \$3.45
((USPS Certified Mail #) (70151730000230639379))
First-Class Mail Letter (Domestic) (PHOENIX, AZ 85016) (Weight: 0 Lb 1.30 Oz) (Estimated Delivery Date) (Wednesday 03/21/2018)

Certified 1 \$3.45
((USPS Certified Mail #) (70151730000230639393))

Total \$12.48
Cash \$20.00
Change (\$7.52)

Text your tracking number to 28777 (2USPS) to get the latest status.

7015 1730 0002 3063 9374

U.S. Postal Service™
CERTIFIED MAIL® RECEIPT
Domestic Mail Only

For delivery information, visit our website at www.usps.com

OFFICIAL USE

Certified Mail Fee	\$3.45
Extra Services & Fees (check box, add fee as appropriate)	\$0.00
<input type="checkbox"/> Return Receipt (hardcopy)	\$0.00
<input type="checkbox"/> Return Receipt (electronic)	\$0.00
<input type="checkbox"/> Certified Mail Restricted Delivery	\$0.00
<input type="checkbox"/> Adult Signature Required	\$0.00
<input type="checkbox"/> Adult Signature Restricted Delivery	\$0.00
Postage	\$0.71
Total Postage and Fees	\$4.16

0130
07
Postmark
Here
03/19/2018

Sent To
Street and Apt. No., or PO Box: Paul Representative Gouar
Gold Canyon Office
6699 S. King Ranch Road, #4
City, State, ZIP+4®: Gold Canyon, Arizona 85118

PS Form 3800, April 2015 PSN 7530-02-000-9047 See Reverse for Instructions

(Domestic) (GOLD CANYON, AZ 85118) (Weight: 0 Lb 1.50 Oz) (Estimated Delivery Date) (Wednesday 03/21/2018)

Certified 1 \$3.45
((USPS Certified Mail #) (70151730000230639379))
First-Class Mail Letter (Domestic) (PHOENIX, AZ 85016) (Weight: 0 Lb 1.30 Oz) (Estimated Delivery Date) (Wednesday 03/21/2018)

Certified 1 \$3.45
((USPS Certified Mail #) (70151730000230639393))

7015 1730 0002 3063 9393

U.S. Postal Service™
CERTIFIED MAIL® RECEIPT
Domestic Mail Only

For delivery information, visit our website at www.usps.com

OFFICIAL USE

Certified Mail Fee	\$3.45
Extra Services & Fees (check box, add fee as appropriate)	\$0.00
<input type="checkbox"/> Return Receipt (hardcopy)	\$0.00
<input type="checkbox"/> Return Receipt (electronic)	\$0.00
<input type="checkbox"/> Certified Mail Restricted Delivery	\$0.00
<input type="checkbox"/> Adult Signature Required	\$0.00
<input type="checkbox"/> Adult Signature Restricted Delivery	\$0.00
Postage	\$0.71
Total Postage and Fees	\$4.16

0130
07
Postmark
Here
03/19/2018

Sent To
Street and Apt. No., or PO Box: Jeff Senator Flata
2200 East Camelback Road, Suite 120
City, State, ZIP+4®: Phoenix, Arizona 85016

PS Form 3800, April 2015 PSN 7530-02-000-9047 See Reverse for Instructions

2022-011769 MISC Page: 670 of 2782
09/26/2022 03:35:37 PM Receipt #: 22-9381
Rec Fee: \$30.00 Darrell James Hill
Gila County, Az, Sadie Jo Bingham, Recorder



USPS Tracking®

FAQs > (<http://faq.usps.com/?articleId=220900>)

Track Another Package +

Tracking Number: 70151730000230639379

Remove X

Expected Delivery on

TUESDAY

20 MARCH 2018 by **8:00pm**

Delivered

March 20, 2018 at 12:25 pm
Delivered, Left with Individual
GOLD CANYON, AZ 85118

Get Updates

Text & Email Updates

Tracking History

March 20, 2018, 12:25 pm
Delivered, Left with Individual
GOLD CANYON, AZ 85118
Your item was delivered to an individual at the address at 12:25 pm on March 20, 2018 in GOLD CANYON, AZ 85118.

March 20, 2018, 9:11 am
Out for Delivery
GOLD CANYON, AZ 85118

March 20, 2018, 9:01 am
Sorting Complete
GOLD CANYON, AZ 85118

March 20, 2018, 4:03 am
Arrived at Unit
APACHE JUNCTION, AZ 85120

March 20, 2018, 1:48 am
Arrived at USPS Facility
APACHE JUNCTION, AZ 85120

March 19, 2018, 9:29 pm
Arrived at USPS Regional Facility
PHOENIX AZ DISTRIBUTION CENTER ANNEX

March 19, 2018, 4:13 pm
Departed Post Office
APACHE JUNCTION, AZ 85120

How can I help you?

2022-011769 MISC Page: 671 of 2782
09/26/2022 03:35:37 PM Receipt #: 22-9381
Rec Fee: \$30.00 Darrell James Hill
Gila County, Az, Sadie Jo Bingham, Recorder



673
U

COPY

:Darrell-James: Hill P.O. Box 3806, Apache Junction, Arizona 85120 602.618.4595

:John :Senator McCain
2201 East Camelback Road, Suite 115
Phoenix, Arizona 85016

:Jeff :Senator Flake
2200 East Camelback Road, Suite 120
Phoenix, Arizona 85016

7015 1730 0002 3063 9386

7015 1730 0002 3063 9393

Dear John, Jeff, greetings;

i:man contact you for remedy from a deprivation of rights and property problem. Attached is the copy of the document received to the Senate Judiciary Committee that illustrates the situation.

With regard to the document content:

- a) the private-property discussed was by the U.S. courts ordered disposed to the The United States of America people, which is i:man.
- b) The self-operated execution of the claims by i:man are guaranteed-protected by i) the U.S. Government under the Supreme Law of the land: under The Constitution for the United States of America – Bill of Rights, et seq.; and, ii) by the ICCPR Treaty -1992 (International Covenant on Civil and Political Rights), the duty and obligation of the federal government, et al., the U.S. government is under mandatory duty and obligation to protect, promote, ensure and enforce the self-operated rights executed by i:man.
- c) i:man registered three claims for specific private-property.
- d) :Almighty God-given rights timely exercised in the execution of the three registered claims is whereby ownership of the property is established to i:man :Darrell-James: Hill.
- e) Each claim i:man registered was answered by silent agreement to the rights executed.
- f) i:man accept silent agreement and seek now to obtain i) 100% of the property, and ii) immediate payment of the amounts due to-date for the trespass-upon-the-claims according to the fee schedule in place to direct in this event.
- g) The withholding of the property and the trespass payment from i:man is not authorized.
- h) The unauthorized possession or otherwise distribution of the specific private-property referred to herein is evidence of wrong-doing and/or theft under the color of law.

Conservative remedy for the daily ongoing injury to i:man is the direct and unrestrained enforced rights for the immediate actions of 1) obtainment of the private-property detailed in the three registered claims, and 2) payment of all fees now due and until the full resolve of the trespass upon each claim.

I look forward to your favorable help within the obligation to protect, promote, ensure and enforce the self-operated rights executed by i:man.

Sincerely,

March 15, 2018

:Darrell-James: Hill
:Darrell-James: Hill, son of the Most High
God, i:man

2022-011769 MISC Page: 672 of 2782
09/26/2022 03:35:37 PM Receipt #: 22-9381
Rec Fee: \$30.00 Darrell James Hill
Gila County, Az, Sadie Jo Bingham, Recorder



7035 1730 0002 3063 9386

U.S. Postal Service™
CERTIFIED MAIL® RECEIPT
 Domestic Mail Only

For delivery information, visit our website at www.usps.com®.

PHOENIX AZ 85016
OFFICIAL USE

Certified Mail Fee	\$3.45	0130 07 Postmark Here 03/19/2018
Extra Services & Fees (check box, add fee as appropriate)	\$0.00	
<input type="checkbox"/> Return Receipt (hardcopy)	\$0.00	
<input type="checkbox"/> Return Receipt (electronic)	\$0.00	
<input type="checkbox"/> Certified Mail Restricted Delivery	\$0.00	
<input type="checkbox"/> Adult Signature Required	\$0.00	
<input type="checkbox"/> Adult Signature Restricted Delivery	\$0.00	
Postage	\$0.71	
Total Postage and Fees	\$4.16	

Sent To
 Street and Apt. No., or PO Box: John : Senator McCain
 2201 East Camelback Road, Suite 115
 City, State, ZIP+4®: Phoenix, Arizona 85016

PS Form 3800, April 2015 PSN 7530-02-000-9047 See Reverse for Instructions

APACHE JUNCTION
 151 W SUPERSTITION BLVD
 APACHE JUNCTION
 AZ
 85120-9998
 0302590130
 (800)275-8777 12:41 PM

03/19/2018

Product Description	Sale Qty	Final Price
First-Class Mail Letter (Domestic) (PHOENIX, AZ 85016) (Weight:0 Lb 1.30 Oz) (Estimated Delivery Date) (Wednesday 03/21/2018)	1	\$0.71
Certified (®USPS Certified Mail #) (70151730000230639386)	1	\$3.45
First-Class Mail Letter (Domestic) (PHOENIX, AZ 85118) (Weight:0 Lb 1.50 Oz) (Estimated Delivery Date) (Wednesday 03/21/2018)	1	\$0.71

7035 1730 0002 3063 9374

U.S. Postal Service™
CERTIFIED MAIL® RECEIPT
 Domestic Mail Only

For delivery information, visit our website at www.usps.com®.

GOLD CANYON AZ 85118
OFFICIAL USE

Certified Mail Fee	\$3.45	0130 07 Postmark Here 03/19/2018
Extra Services & Fees (check box, add fee as appropriate)	\$0.00	
<input type="checkbox"/> Return Receipt (hardcopy)	\$0.00	
<input type="checkbox"/> Return Receipt (electronic)	\$0.00	
<input type="checkbox"/> Certified Mail Restricted Delivery	\$0.00	
<input type="checkbox"/> Adult Signature Required	\$0.00	
<input type="checkbox"/> Adult Signature Restricted Delivery	\$0.00	
Postage	\$0.71	
Total Postage and Fees	\$4.16	

Sent To
 Street and Apt. No., or PO Box: Paul : Representative Gosar
 Gold Canyon Office
 6499 S. Kings Ranch Road, #4
 City, State, ZIP+4®: Gold Canyon, Arizona 85118

PS Form 3800, April 2015 PSN 7530-02-000-9047 See Reverse for Instructions

Certified (®USPS Certified Mail #) (70151730000230639386)	1	\$3.45
First-Class Mail Letter (Domestic) (PHOENIX, AZ 85118) (Weight:0 Lb 1.50 Oz) (Estimated Delivery Date) (Wednesday 03/21/2018)	1	\$0.71
Certified (®USPS Certified Mail #) (70151730000230639379)	1	\$3.45
First-Class Mail Letter (Domestic) (PHOENIX, AZ 85016) (Weight:0 Lb 1.30 Oz) (Estimated Delivery Date) (Wednesday 03/21/2018)	1	\$0.71

Total \$12.48
 Cash \$20.00
 Change (\$7.52)

Text your tracking number to 28777 (2USPS) to get the latest status.

675 7035 1730 0002 3063 9393

U.S. Postal Service™
CERTIFIED MAIL® RECEIPT
 Domestic Mail Only

For delivery information, visit our website at www.usps.com®.

PHOENIX AZ 85016
OFFICIAL USE

Certified Mail Fee	\$3.45	0130 07 Postmark Here 03/19/2018
Extra Services & Fees (check box, add fee as appropriate)	\$0.00	
<input type="checkbox"/> Return Receipt (hardcopy)	\$0.00	
<input type="checkbox"/> Return Receipt (electronic)	\$0.00	
<input type="checkbox"/> Certified Mail Restricted Delivery	\$0.00	
<input type="checkbox"/> Adult Signature Required	\$0.00	
<input type="checkbox"/> Adult Signature Restricted Delivery	\$0.00	
Postage	\$0.71	
Total Postage and Fees	\$4.16	

Sent To
 Street and Apt. No., or PO Box: Jeff : Senator Flake
 2200 East Camelback Road, Suite 120
 City, State, ZIP+4®: Phoenix, Arizona 85016

PS Form 3800, April 2015 PSN 7530-02-000-9047 See Reverse for Instructions

2022-011769 MISC Page: 673 of 2782
 09/26/2022 03:35:37 PM Receipt #: 22-9381
 Rec Fee: \$30.00 Darrell James Hill
 Gila County, Az, Sadie Jo Bingham, Recorder



USPS Tracking®

FAQs > (<http://faq.usps.com/?articleId=220900>)

Track Another Package +

Tracking Number: 70151730000230639393

Remove X

Your item was delivered to the front desk or reception area at 12:03 pm on March 20, 2018 in PHOENIX, AZ 85016.

✓ Delivered

March 20, 2018 at 12:03 pm
Delivered, Front Desk/Reception
PHOENIX, AZ 85016

Get Updates ▾

Text & Email Updates ▾

Tracking History ▲

March 20, 2018, 12:03 pm
Delivered, Front Desk/Reception
PHOENIX, AZ 85016
Your item was delivered to the front desk or reception area at 12:03 pm on March 20, 2018 in PHOENIX, AZ 85016.

March 20, 2018, 6:16 am
Departed USPS Regional Facility
PHOENIX AZ DISTRIBUTION CENTER ANNEX

March 19, 2018, 9:29 pm
Arrived at USPS Regional Facility
PHOENIX AZ DISTRIBUTION CENTER ANNEX

March 19, 2018, 4:13 pm
Departed Post Office
APACHE JUNCTION, AZ 85120

March 19, 2018, 12:37 pm
USPS in possession of item
APACHE JUNCTION, AZ 85120

Product Information ▾

See Less ▲

Can't find what you're looking for?

Go to our FAQs section to find answers to your tracking questions.

How can I help you?

676
2022-011769 MISC Page: 674 of 2782
09/26/2022 03:35:37 PM Receipt #: 22-9381
Rec Fee: \$30.00 Darrell James Hill
Gila County, Az, Sadie Jo Bingham, Recorder

3/22/18, 9:26 PM



JOHN McCAIN
ARIZONA

CHAIRMAN, COMMITTEE ON
ARMED SERVICES
COMMITTEE ON HOMELAND SECURITY
AND GOVERNMENTAL AFFAIRS
COMMITTEE ON INDIAN AFFAIRS

United States Senate

218 RUSSELL SENATE OFFICE BUILDING
WASHINGTON, DC 20510-0303
(202) 224-2235

2201 EAST CAMELBACK ROAD
SUITE 115
PHOENIX, AZ 85016
(602) 952-2410

407 WEST CONGRESS STREET
SUITE 103
TUCSON, AZ 85701
(520) 670-6334

April 16, 2018

Darrell-James Hill
PO Box 3806
Apache Junction, AZ 85117-4137

Dear Darrell-James,

I want to take this opportunity to thank you for your letter requesting assistance.

Unfortunately, your situation appears to involve a legal dispute requiring resolution under the judicial system, and the Constitution mandates a separation of powers between the Judicial, Executive, and Legislative branches. Based on the information you provided, it appears this is a matter outside the jurisdiction of the legislative branch, and I feel that my involvement in your present situation may be viewed as an interference in the judicial process.

Darrel-James, I am sorry that I cannot be of assistance at this time.

Sincerely,

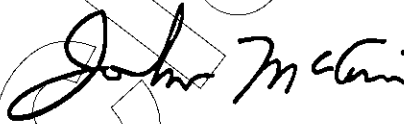

John McCain
United States Senator

JM/xintCM

677
2022-011769 MISC Page: 675 of 2782
09/26/2022 03:35:37 PM Receipt #: 22-9381
Rec Fee: \$30.00 Darrell James Hill
Gila County, Az, Sadie Jo Bingham, Recorder

ON RECYCLED PAPER

:Darrell-James: Hill, man; c/o PO Box 3806, Apache Junction, Arizona 85119

:John :Senator Mc Cain, Arizona
2201 East Camelback Road, Suite 115
Phoenix, Arizona 85016
602-952-2410

Re: Darrell-James: Hill. Request for the representation from Arizona Senators: John and Jeff.

Dear John, xintCM, greetings;

For the April 16th, 2018 letter (attached) from the "xintCM" in a response to the initial notice of the USPS CMN 7015 1730 0002 3063 9386 (recv'd March 6, 2018) related to this :Darrell-James: Hill property matter is: **Point:** remedy and recourse of the commercial problem is nearly resolved within the Executive branch and must then be redressed to the Legislative branch of the government service, starting with the man John and Jeff: Senators Arizona. Thank you for the response.

In no wise did was the 7015 1730 0002 3063 9386 notice a request for a Legislative officer to micro-management of the other branches of the U.S. government service.

In accordance with the legislative duty, obligation and responsibility this Darrell-James: Hill property matter will at some point soon be within the separate jurisdiction of the legislative branch. Thereto this Darrell-James: Hill property matter is within your legislative scope. And, Most importantly now is the the fact that the USPS CMN 7015 1730 0002 3063 9386 is the timely and prima facie notice completed to :you John.

Whether you will effectively do or not do the protection-of-right duty and obligation indicated as hoped will be a separate matter; i hope the prior.

:i will correspond again once after and with the evidence of that the Executive branch commercial process is ended.

Sincerely:

day: April 26, 2018

Darrell-James: Hill
:Darrell-James: Hill, man



:Darrell- James: Hill c/o PO Box 3806, Apache Junction, Arizona 85117

USPS CMN 7015 1730 0002 3063 9648

:John : Governor Kasich
c/o Office of the Governor of Ohio-state
Rifle Center, 30th Floor
77 South High Street
Columbus, Ohio 43215-6117
614-446-3555

USPS CMN 7015 1730 0002 3063 9331

:Steve : Sheriff Barry
c/o Office of the Sheriff, Summit county
53 University Avenue
Akron, Ohio 44308
330-643-2154, Fax 330-434-2701

Re: Affidavits annexed: 1) Constructive Notice of "DARRELL JAMES HILL" of the "Darrell James of the family Hill": Authorized Representative
2) Superior constructive Notice and Demand: Permanent Non-Commercial Presumption: man: Darrell- James: Hill

John, Steve, Greetings,

I: man am Darrell, an Ohioan, born on the Summit County, Ohio in the year: 1958. A quiet man, i am sui juris, A.R. for the stramineus homo: DARRELL JAMES HILL, and sojourn about the Arizona state.

Due to circumstances in the relations with the people of the Summit County- Ohio Recorder, who without cause twice refused to record common documents from i, these Affidavits must be affirmed to you so to determine to you who i am in this process of the resolve of this unfortunate impasse with the people of the Summit County- Ohio Recorder service. To wit: The people of the Summit County- Ohio Recorder, et al., acquiesced to daily pay upon demand a substantial amount of money for their chose of the violations of the rights of i: man until the sustained violation of the right ends.

Thank you;

Without Prejudice.

Autographed: 3 day: July month: 2018

Darrell James Hill
:Darrell- James: Hill :man

.Sworn to and subscribed before me now on this 3 day: July month: 2018.
Produced identification: type: Arizona Driver License.

679

Heather Wood
Notary

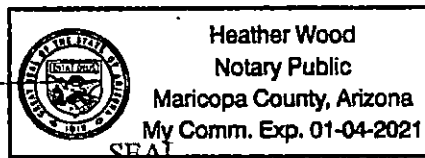

7015 1730 0002 3063 9348

7015 1730 0002 3063 9331

2022-011769 MISC Page: 677 of 2782
09/26/2022 03:35:37 PM Receipt #: 22-9381
Rec Fee: \$30.00 Darrell James Hill
Gila County, Az. Sadie Jo Bingham, Recorder

Donald

Registered No. RE047636404US

Date Stamp: APACHE JUNCTION, AZ 85120
MAY 29 2018

Postage \$	\$0.50	Extra Services & Fees	
Extra Services & Fees	\$12.60	Signature Confirmation	
Registered Mail (hardcopy)	\$2.75	Signature Confirmation Restricted Delivery	
Return Receipt (hardcopy)	\$0.00		
Return Receipt (electronic)	\$0.00		
Restricted Delivery	\$0.00		
Total Postage & Fees		\$15.85	
Customer Must Declare Full Value	\$21.00	Received by	05/29/2018 9:00 AM

Domestic insurance up to \$50,000 is included based on the declared value. International liability is limited. (See Reverse).

APACHE JUNCTION
151 W SUPERSTITION BLVD
APACHE JUNCTION
AZ
85120-9998
0302590130
(800) 275-8777
05/29/2018 12:47 PM

Product Description	Sale Qty	Final Price
First-Class Mail Letter (Domestic) (WASHINGTON, DC 20500) (Weight: 0 Lb 0.50 Oz) (Estimated Delivery Date) (Friday 06/01/2018)	1	\$0.50
Registered (Amount: \$21.00) (USPS Registered Mail #) (RE047636404US)	1	\$12.60
Return Receipt (USPS Return Receipt #) (9590940306765196708901)	1	\$2.75
Total		\$15.85
Cash Change		\$50.00 (\$34.15)

OFFICIAL USE

APACHE JUNCTION, AZ 85120

FROM: Darrell James Hill
c/o PO Box 3806
Apache Junction, Arizona (85120)

TO: Donald POTUS Trump
c/o 1600 Pennsylvania Ave NW
Washington, D.C. 20500

Form 3806, Registered Mail Receipt
Copy 1 - Customer

Text your tracking number to 28777 (2USPS) to get the latest status. Standard Message and Data rates may apply. www.usps.com 1-800-222-1811.

SENDER: COMPLETE THIS SECTION

- Complete items 1, 2, and 3.
- Print your name and address on the reverse so that we can return the card to you.
- Attach this card to the back of the mailpiece, or on the front if space permits.

1. Article Addressed to:

Donald: POTUS Trump
c/o 1600 Pennsylvania Ave NW
Washington, D.C. 20500

2. Article Number (Transfer from service label): RE 047 636 404 US

COMPLETE THIS SECTION ON DELIVERY

A. Signature: MSOD

B. Received by (Printed Name):

C. Date of Delivery:

3. Delivery address different from item 1? Yes No
If YES, enter delivery address below:

4. Service Type:

- Adult Signature
- Registered Mail
- Registered Mail Restricted Delivery
- Certified Mail
- Certified Mail Restricted Delivery
- Collect on Delivery
- Collect on Delivery Restricted Delivery
- Insured Mail (over \$500)
- Priority Mail Express
- Registered Mail
- Registered Mail Restricted Delivery
- Return Receipt for Merchandise
- Signature Confirmation
- Signature Confirmation Restricted Delivery

PS Form 3811, April 2015 PSN 7530-02-000-9053 Domestic Return Receipt

680

ALERT: AS OF APRIL 30, USPS.COM NO LONGER SUPPORTS OUTDATED BROWSERS. TO CONTINUE A...

USPS Tracking®

FAQs > (<http://faq.usps.com/?articleId=220900>)

Track Another Package +

Tracking Number: RE047636404US

Remove X

Your item was delivered at 3:53 am on June 6, 2018 in WASHINGTON, DC 20500.

✓ Delivered

June 6, 2018 at 3:53 am
Delivered
WASHINGTON, DC 20500

Get Updates ▾

Text & Email Updates ▾

Tracking History

June 6, 2018, 3:53 am
Delivered
WASHINGTON, DC 20500
Your item was delivered at 3:53 am on June 6, 2018 in WASHINGTON, DC 20500.

June 5, 2018, 1:14 am
Arrived at Unit
WASHINGTON, DC 20066

June 4, 2018
In Transit to Next Facility

June 3, 2018
In Transit to Next Facility

June 2, 2018





State of Arizona - Office of the Secretary of State
Apostille/Certificate of Authentication Request

DO NOT WRITE IN THIS SPACE

MICHELE REAGAN
Secretary of State

SEND BY MAIL TO:
Secretary of State Michele Reagan, Atten: Notary Division
1700 W. Washington Street, FL 7, Phoenix, AZ 85007-2808

OR return the request in person:
PHOENIX - State Capitol Executive Tower, 1700 W. Washington Street, 2nd Fl., Ste. 220
TUCSON - Arizona State Complex, 400 W. Congress, 1st Fl., Suite 141
Office Hours: Monday through Friday, 8 a.m. to 5 p.m., except state holidays.

FOR OFFICE USE ONLY
SOSBSAP REV. 2/20/2018

PLEASE NOTE: The Secretary of State issues apostilles (certificates of notarization authenticity) on documents being sent to a foreign country and also authenticates public documents being sent to foreign countries. An apostille from the Arizona Secretary of State's Office certifies an ARIZONA NOTARY, STATE CLERK, JUDGE or other PUBLIC OFFICER whose oath is on file with the Secretary of State.

INSTRUCTIONS

When to use this form: Use this form to request an apostille or certificate of authentication under A.R.S. § 41-326.
When not to use this form: Do NOT use this form if the document for which you are seeking an apostille has been signed or notarized by a federal official. Direct your request to the United States Department of State at (202) 647-4000. Such documents might include those that have been signed by a federal official with the official seal of that agency, American Consular Officer, Military Notary (10 USC 1044a) or Foreign Consul.
Be Accurate: To avoid errors please write legibly or computer generate this request. This form has been designed to be filled out and printed online. Sign and date the request.
Website: All forms are available on the Secretary of State's Website, www.azsos.gov.

Types of documents authenticated: Government documents such as a birth certificate, death certificate, marriage record, corporation document, etc. must be a CERTIFIED COPY issued by that government office.
Filing Fee and Payment: \$3 PER DOCUMENT; Checks or money orders shall be made payable to the Secretary of State. Credit cards are not accepted. Cash accepted in-person only.
Submission: Include your payment and a self-addressed, postage paid envelope to avoid any delays or rejections. We are unable to process any requests with insufficient postage.
If you send your documents by mail and require expedited service you may want to use express mail and include a self-addressed, pre-paid express mail envelope for the return of the processed documents.
Processing: 10 Business Days
Questions? Call (602) 542-6187; in-state/toll-free (800) 458-5842.

1. Type of document(s) Type of Document AFFIDAVIT- ARIZONA NOTARY
Type of Document AFFIDAVIT- ARIZONA NOTARY
Type of Document AFFIDAVIT- ARIZONA NOTARY
Type of Document AFFIDAVIT- ARIZONA NOTARY

2. Foreign Country in which document(s) will be used Name of Foreign Country (Cannot be United States) STATE OF OHIO: FOR RECORDATION AND CASE EXHIBIT

3. Requestor Information:			
Requestor's First Name DARRELL JAMES	Requestor's Last Name HILL		
Address (include street, box or suite number) PO BOX 3806	City APACHE JUNCTION	State ARIZ	Zip Code 85117
Phone Number (include area code) (602) 618-4595	Requestor's Signature	Date 07 03 2018	

4. Submission:			
Enclosed is a:	<input type="checkbox"/> Pre-paid express mail envelope for the return of the processed document(s). <input checked="" type="checkbox"/> Self-addressed stamped envelope for the return of the processed document(s). Please remember the returned documents will include official certificates. It is recommended to include catalog 9 x 12 sized envelopes to return your documents.		
Number of Documents:	Number of Documents 4	X (Times) the cost per document \$3.00 =	TOTAL Processing Fee \$12.00
Payment:	Enclosed is a: <input type="checkbox"/> CHECK <input checked="" type="checkbox"/> MONEY ORDER to include the Total Processing Fee above.		

Arizona Department of State

682

2022-011769 MISC Page: 680 of 2782

09/26/2022 03:35:37 PM Receipt #: 22-9391
Rec Fee: \$30.00 Darrell James Hill
Gila County, Az, Sadie Jo Bingham, Recorder



Michele Reagan, Secretary of State



DATE _____

APOSTILLE/AUTHENTICATION RETURN FORM

We are unable to process your request for the following reason(s):

- Please indicate what COUNTRY the document(s) will be sent.
- Please use enclosed apostille request form.
- Please send your payment of \$3.00 per notarized and/or certified document.

Total fee \$ _____

- Please enclose a self-address stamped envelope.
- Your document(s) were not received.
- Your document(s) is/are improperly notarized. Please have the notary review their reference manual or visit our website at www.azsos.gov on how to perform a proper notarization:
 - Notary is acting outside the scope of her authority; statements should be coming from signer not the notary. When you resubmit, please make sure it is the original document and it has a notarial language certificate.
 - Venue is missing on notarizations, List State and County of where notarization took place. Please have the notary review his/her reference manual for instruction on how to properly notarize a document.
 - The signer's personal information cannot be part of the notarial certificate because a notary public cannot attest to that. Please have the notary review his/her reference manual for instructions on how to properly notarize a document.
- An apostille is a certification of a Notary or public official, in your case you would need to have all of your documents notarized prior to sending them in for apostille.
- NOTARIAL LANGUAGE IS MISSING:** A Notary who notarizes a document without notarial language has performed an incomplete notarization. A court of law could declare the notarization invalid. (samples attached)

The Secretary of State has been advised by the U.S. Department of State to refuse to notarize, authenticate, or affix the Hague Apostille to certain documents. Additionally, A.R.S. § 41-121(B) grants the Secretary of State authority to deny such requests. The Secretary of State may refuse to perform a service or refuse a filing after the document/filing has been reviewed.

After reviewing your documents the secretary has decided to not issue your apostille/certificate of authentication, this is not a document that our office can authenticate.

683

2022-011769 MISC Page: 681 of 2782
09/26/2022 03:35:37 PM Receipt #: 22-9381
Rec Fee: \$30.00 Darrell James Hill
Gila County, Az, Sadie Jo Bingham, Recorder



**AFFIDAVIT: Constructive Notice of "DARRELL JAMES HILL" of
the "Darrell- James of the family Hill": Authorized Representative**

State of Arizona

County of Pinal

DARRELL JAMES HILL, personally appeared before me, the undersigned Notary duly authorized by the law of Arizona to administer oaths; now on this 3rd day: July month: 2018: 12:15 am (pm) being by me first duly sworn on his affirmation, affiant deposes and says:

I: DARRELL JAMES HILL, do herein present¹ testimony² and admit³ that: I am the en-legis⁴ stramineus homo⁵ commercial⁶ fiction⁷ for the private⁸- person: man⁹ :Darrell- James of the family Hill, "Darrell- James: Hill", who is a distinct private- person of the people¹⁰ of The united States of America¹¹, an American National¹² Citizen¹³ under Originating Documents constituting The united States of America; to wit, a beneficiary¹⁴ of the public¹⁵ trust¹⁶ 17, and thereto and therefrom, the de jure¹⁸ Personal Authorized¹⁹ Representative²⁰ 21, "A.R.", of

- 1 "present" means: Tend. [T]o be directed as to any end, object, or purpose.... In the nature of Rogers v. State, 122 Tex.Cr.R. 331, 54 S.W.2d. 1010, 1012. - Black's Law Dictionary, 4th Ed., p. 1637. To wit, all terms are/ will be as determined by the affiant.
- 2 "testimony" means: Evidence given by a competent witness, under oath or affirmation.... In the nature of Edelstein v. United States, 79 C.C.A. 328, 149 F. 636, 640 - Black's Law Dictionary, 4th Ed., p. 1646.
- 3 "admit" means: Admission(s). ... [V]oluntary acknowledgments made by a party of the existence of certain facts. In the nature of Roosevelt v Smith, 40 N.Y.S. 381, 17 Misc. 323. - Black's Law Dictionary, 4th Ed., p. 68.
- 4 "en legis" means: A statutorily created construct/ entity.
- 5 "stramineus homo" means: A man of straw, one of no substance, put forward as bail or surety. In the nature of Black's Law Dictionary, 4th Ed., p. 1590.
- 6 "commercial" means: Relating to or connected with trade and traffic or commerce in general. In the nature of "Zante Currents", C.C.Cal., 73 F. 189. - Black's Law Dictionary, 4th Ed., p. 68.
- 7 "entity" means: An assumption or supposition of law that something which is or may be false is true, or that a state of facts exists which has never really taken place. In the nature of New Hampshire Strafford Bank v. Cornell, 2 N.H. 324; Hibberd v. Smith, 67 Cal. 547, 4 P. 473, 56 Am.Rep. 726; Murphy v. Murphy, 190 Iowa 874, 179 N.W. 530, 533. - Black's Law Dictionary, 4th Ed., p. 751.
- 8 "private" means: Affecting or belonging to private individuals, as distinct from the public generally. Not official; not clothed with office. In the nature of People v. Powell, 280 Mich. 699, 274 N.W. 372, 373; 111 A.L.R. 721. - Black's Law Dictionary, 4th Ed., p. 1358.
- 9 man" means: Earthen born species of man of flesh and blood.
- 10 "people" means: A state; as the people of [a] state. A nation in its collective and political capacity. In the nature of Nesbitt v. Lushington, 4 Term R. 783; U.S. v. Quincy, 6 Pet. 467, 8 L.Ed. 458; U.S. v. Trumbull, D.C.Cal., 48 F. 99. - Black's Law Dictionary, 4th Ed., p. 1292.
- 11 "The united States of America" means: the union of the independent several states of the States of America within the Declaration of Independence, 1776, and further lucidated in The Constitution for the United States of America, 1789, including the Bill of Rights, et. seq., of the republic.
- 12 "national" means: Pertaining to the several independent States of America
- 13 "Citizen" means: The species of man born on the ground of the independent States of America.
- 14 "beneficiary" means: One for whose benefit a trust is created; a *cestui que trust*. In the nature of 195 N.E. 557, 564; 97 A.L.R. 1170. - Black's Law Dictionary, 4th Ed., p. 199.
- 15 "public" means: Pertaining to a state, nation, or whole community; proceeding from, relating to, or affecting the whole body of people or an entire community. Open to all Common to all or many; general; open to common use. In the nature of Morgan v. Cree, 46 Vt. 786; 14 Am.Rep. 640; Craine v. Waters, C.C.Mass., 10. F. 621. - Black's Law Dictionary, 4th Ed., p. 1393.
- 16 "trust" means: A right of property, real or personal, held by one party for the benefit of another. In the nature of Goodwin v. McMinn, 193 Pa. 646, 44 A. 1094; 74 Am.St.Rep. 703; Boyce v. Mosely, 102 S.C. 361, 86 S.E. 771, 773; King v. Richardson, C.C.A.N.C., 136 F.2d. 849, 856, 857. - Black's Law Dictionary, 4th Ed., p. 1680.
- 17 "public trust" means *cestui que trust(s)* - He who has a right to a beneficial interest in and out of an estate the legal title to which is vested in another. In the nature of 2 Washib. Real Prop. 163. - Black's Law Dictionary, 4th Ed., p. 289. To wit: the amalgam of Trading With The Enemy Act: Public Law No. 65-91; with, the Emergency Banking Act of March 9, 1933; the clandestine achievement of concomitant sequestration of all available private titles of the American people, the progressive implementation of the system of the systematic garner of all subsequent titles from the American people, and, therefrom, the development and imposition of a socialist state politic by the commercial government upon an ignorant and unsuspecting American people.
- 18 "de jure" means: Of right; legitimate; lawful; by right and just title. In the nature of "de jure", Black's Law Dictionary, 4th Ed., p. 481.
- 19 "authorized" means: [Clothed] with ... legal power. In the nature of Arkansas & Memphis Ry. Bridge & Terminal Co. v. State, 174 Ark. 420, 295 S.W. 378, 380. - Black's Law Dictionary, 4th Ed., p. 169.
- 20 "representation" means: One who represents or stands in the place of another. In the nature of Lee v. Dill, 39 Barb. (N.Y.) 520; Staples v. Lewis, 71 Conn. 288, 41 A. 815. - Black's Law Dictionary, 4th Ed., p. 1466.
- 21 "Authorized Representative" means: In the nature of the Uniform Commercial Code, "UCC": UCC § 3-401. SIGNATURE, and UCC § 3-402. SIGNATURE BY REPRESENTATIVE.

684
Affidavit of DARRELL JAMES HILL

2022-011769 MISC Page: 682 of 2782

09/26/2022 03:35:37 PM Receipt #: 22-9381
Rec Fee: \$30.00 Darrell James Hill
Gila County, Az, Sadia Jo Bingham, Recorder



**AFFIDAVIT: Constructive Notice of "DARRELL JAMES HILL" of
the "Darrell- James of the family Hill": Authorized Representative**

my commercial stramineus homo being known as: DARRELL JAMES HILL, including in all spellings, forms
or abbreviations however constituted referring to my commercial entity, except that of the natural- man:
"Darrell- James of the family Hill", Darrell- James: Hill.

**Notice to the Agent is Notice to the Principal;
Notice to the Principal is Notice to the Agent**

Autographed: 3rd day: July month: 2018

Without Prejudice Accepted.

Darrell James Hill
:Darrell- James: Hill man -A.R.

Sworn to and subscribed before me now on this 3rd day: July month: 2018.
Produced identification: type: Arizona Driver License.

Heather Wood
Notary

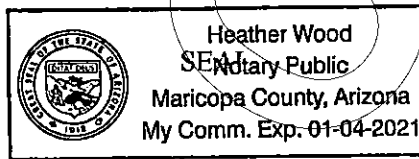

2022-011769 MISC Page: 683 of 2782
09/26/2022 03:35:37 PM Receipt #: 22-9381
Rec Fee: \$30.00 Darrell James Hill
Gila County, Az, Sadie Jo Bingham, Recorder



AFFIDAVIT: Superior Constructive Notice and Demand:
Permanent Non-Commercial Presumption: man: Darrell- James: Hill

State of Arizona

County of Pinal

Darrell- James: Hill, man, personally appears before me, the undersigned Notary duly authorized by the law of Arizona to administer oaths; now on this 3rd day: July month: 2018: 12 : 17 am/pm, being by me first duly sworn on his affirmation, affiant deposes and says:

Introduction

This: **Notice and Demand**¹ is the political² election³ and directive⁴ of the "man"⁵, Darrell- James: Hill⁶, sui-juris⁷ under Almighty-God⁸ born⁹ on-the-ground¹⁰ of the Ohio-state¹¹ territory¹² of the Nation-states¹³ of The united States of America¹⁴; to wit, an American-National-Citizen¹⁵, "American", of the people¹⁶-of-the-united-States-of-America¹⁷, a "Principal"¹⁸". Thereto, this Notice and Demand is a directive from this American Principal man, "AP"¹⁹", pointing to the truth under the authority of the Declaration of

- 1 **demand** means: making "[a]n imperative request preferred by one [Man] to [the United States government], under a claim of right, requiring the latter to do something or to abstain from some act[;]" in the nature of Zimmerman v. Hicks, C.C.A., 7 F.2d. 443, 445; Black's Law Dictionary, 4th Ed., p. 516.
- 2 **political** means: 'Pertaining to, or incidental to, the exercise of the functions vested in those charged with the conduct of government; ... of or pertaining to the exercise of rights and privileges or the influence by which people of a state seek to determine or control its public policy[;]' in the nature of State ex rel. Maley v. Civic Action Committee, 238 Iowa 851, 28 N.W.2d 467, 470; Black's Law Dictionary, 4th Ed., p. 1319.
- 3 **election** means: 'the act of choosing or selecting one or more from a greater number of persons, things, courses or rights. The choice of an alternative[;]' in the nature of State v. Tucker, 54 Ala. 210; Black's Law Dictionary, 4th Ed., p. 608.
- 4 **directive** means: A '... guide; order; command; instruction' given; in that nature of Durkee's Estate, 47 N.Y.S. 2d 721, 725, 726; 183 Misc. 382; Black's Law Dictionary, 4th Ed., p. 546.
- 5 **man** means: God Almighty's created being, species embodying a soul, spirit and flesh for the husbandry-dominion of the earth in direct regular relationship with God. Also, scientifically referred to as Homo sapiens sapiens.
- 6 **BORNNAME** means: the man-child's give name, Darrell, and of the family name Ledger; to wit: "Darrell-James: Hill".
- 7 **sui juris** means: 'of his own right; possessing full social and civil rights' standing[;] in the nature of Black's Law Dictionary, 4th Ed., p. 1602.
- 8 **Almighty God** means: The true and living God of Abraham, Isaac, Jacob, the father of the Messiah Yushua (Jesus the Christ); Him under whom the Nation states of The united States of America is constituted.
- 9 **born** means: brought into flesh and blood status by birth- 'the process of a species being naturally wholly reproduced and brought into a separate existence[;]' In the nature of Wallace v. State, 10 Tex. App. 270; Black's Law Dictionary, 4th Ed., p. 213.
- 10 **on the ground** means: dry earth territory as opposed to the sea.
- 11 **state** means: one of the sovereign territories of the union of States of America, indicating 'a people sojourning occupying a fixed territory that are bound together by common-law habits and custom into one body politic of an organized government' under the constitution for The united States of America[;] in the nature of United States v. Kusche, D.C.Cal., 56 F. Supp. 201, 207, 208; Black's Law Dictionary, 4th Ed., p. 1578.
- 12 **territory** means: the real property above, on and below the land within the confines and under the jurisdiction of a sovereign people's republic state: one of the several members of The united States of America.
- 13 **Nation states** means: the perpetual union of the states of The United States of America; each state retains its sovereignty, freedom, and independence, and every power, jurisdiction, and right, which is not by this Confederation expressly delegated to the United States as expressed in the Articles of Confederation and disposed in The Constitution for the United States of America and Bill of Rights.
- 14 **united States of America** means: Nation states in union, see 11 above, united.
- 15 **American National-Citizen** means: a man-child born in a Nation state of the union of States of America; an American.
- 16 **people** means: two or more American National Citizens
- 17 **people of The united States of America** means: two or more persons of either men-, or women-, or children- American Principals
- 18 **Principal** means: one man-, woman-, or child- American of the people of The united States of America; the element of the American National Citizen inherent in the people of The united States of America; of "[t]he source of authority or right. A superintendent...[;]" in the nature of Williams v. School Dist. No 189, 104 Wash. 659, 177 P. 635, 636; Black's Law Dictionary, 4th Ed., p. 1355.
- 19 **AP** means: "American Principal man": an American National Citizen- of the people of The united States of America born in a state of the Nations states of The united States of America.



686

AFFIDAVIT: Superior Constructive Notice and Demand:
Permanent Non-Commercial Presumption: man: Darrell- James: Hill

Independence (1776)²⁰ - Articles of Confederacy (1781)²¹ - The Constitution for the United States of America (1787)²² - Bills of Rights (1791)²³, the documents, et seq., constituting The united States of America, the "Originating-Documents"²⁴.

This AP makes notice of and demands that the United-States²⁵-Government²⁶, "U.S. government", including, but not limited to, its agents²⁷, actors²⁸, assigns²⁹ and proxies³⁰, and, including County Sheriffs, hereafter "U.S. government³¹", in all and every encounter³² with or in regards to the AP set the AP- man permanent presumption in their any referencing database(s) that upon any contact with or in regards to the AP-man the permanent non-commercial³³ presumption³⁴ status³⁵ of AP be the database reference result for all U.S. government encounters.

U.S. government's U.S. Citizen- the Commercial Status

This AP: "Darrell- James: Hill", had been juxtaposed³⁶ with the commercial-construction "U.S. Citizen³⁷": "DARRELL JAMES HILL", by the U.S. Government for use in its commercial presumption system.

20 **Declaration of Independence (1776)** means: IN CONGRESS, July 4, 1776. The unanimous Declaration of the thirteen united States of America, ... We hold these truths to be self-evident, that all men are created equal, that they are endowed by their Creator with certain unalienable Rights, that among these are Life, Liberty and the pursuit of Happiness.— That to secure these rights, Governments are instituted among Men, deriving their just powers from the consent of the governed,—

21 **Articles of Confederacy (1781)** means: To all to whom these Presents shall come, we the undersigned Delegates of the States affixed to our Names send greeting.

Articles of Confederation and perpetual Union between the states of New Hampshire, Massachusetts-bay Rhode Island and Providence Plantations, Connecticut, New York, New Jersey, Pennsylvania, Delaware, Maryland, Virginia, North Carolina, South Carolina and Georgia.

I. The Stile of this Confederacy shall be "The United States of America".

II. Each state retains its sovereignty, freedom, and independence, and every power, jurisdiction, and right, which is not by this Confederation expressly delegated to the United States, in Congress assembled.

22 **The Constitution for the United States of America (1787)** means: "We the People of the United States, in Order to form a more perfect Union, establish Justice, insure domestic Tranquility, provide for the common defense, promote the general Welfare, and secure the Blessings of Liberty to ourselves and our Posterity, do ordain and establish this Constitution for the United States of America."

23 **Bill of Rights (1791)** means: The conventions of a number of the States having at the time of their adopting the Constitution, expressed a desire, in order to prevent misconstruction or abuse of its powers, that further declaratory and restrictive clauses should be added.

Article the eleventh [Amendment IX] The enumeration in the Constitution, of certain rights, shall not be construed to deny or disparage others retained by the people.

Article the twelfth [Amendment X] The powers not delegated to the United States by the Constitution, nor prohibited by it to the States, are reserved to the States respectively, or to the people.

24 **Originating Documents:** means the Declaration of Independence (1776) and Articles of Confederacy (1781) and The Constitution for the United States of America (1787) and Bills of Rights (1791)

25 **United States** means: "U.S.", a federal corporation in commerce, in the nature of Title 28 of the U.S. Code § 3002(15).

26 **United States Government** means: the utility distinguished under the Originating Documents under the people, under Almighty God; and, any further form of government derivative thereunder, including but not limited to the federal commercial-corporation construct, the federal corporation of the "United States" in government active as of this writing.

27 **agent** means: one operating in agency including "every relation in which one person acts for or represents another by [the] latter's authority," in the nature of Saums v. Parfet, 270 Mich. 165, 258 N.W. 235, "where one person acts for another, either in the relationship of principal and agent, master and servant, or employer or proprietor and independent contractor", in the nature of Gorton v. Doty, 57 Idaho 792, 69 P.2d. 136, 139; Black's Law Dictionary, 4th Ed., p. 84.

28 **actor** means: "[o]ne who act[s] for another; one who attended to another's business; a manager [One] who attend[s] to, transact[s], or superintend[s] his master's business or affairs, received and paid out moneys, and kept accounts[;] in the nature of Burrill; Black's Law Dictionary, 4th Ed., p. 53.

29 **assign** means: "generally... all those who take either immediately or remotely from or under the assignor, whether by conveyance, devise, descent, or act of law[;]" in the nature of Ferrell v. Deverick, 100 S.E. 850, 853, 85 W.Va. 1; Black's Law Dictionary, 4th Ed., p. 154.

30 **proxies: proxy** means: one "who is substituted or [deputized] by another to represent him and act for him.... An agent representing and acting for [the] principal. Also the instrument containing the appointment of such...[;] in the nature of Manson v. Curtis, 223 N.Y. 313, 119 N.E. 559, 561, Ann.Cas.1918E, 247; Cliffs Corporation v. United States, C.C.A.Ohio, 103 F.2d 77, 80; Black's Law Dictionary, 4th Ed., pp. 1391-1392.

31 **U.S. government** means: "The whole class or body of office-holders or functionaries considered in the aggregate, upon whom devolves the ... administrative business of the state[;] in the nature of Stokes v. United States, C.C.A.Mo., 264 F. 18, 22; Black's Law Dictionary, 4th Ed., p. 824.

32 **encounter** means: to meet expectedly or unexpectedly, in peace or controversy anticipated or unanticipated.

Notice and Demand: F

687

2022-011769 MISC Page: 685 of 2782
09/26/2022 03:35:37 PM Receipt #: 22-9391
Rec Fee: \$30.00 Darrell James Hill
Gila County, Az, Sadie Jo Bingham, Recorder

AFFIDAVIT: Superior Constructive Notice and Demand:
Permanent Non-Commercial Presumption: man: Darrell- James: Hill

The commercial U.S. Citizen is the U.S. government corporation's legal³⁸ commercial-construction³⁹ for all U.S governmental services and encounters with any man-, woman-, or child-American Principal, and this AP. The U.S. Citizen construct is originated⁴⁰ and is derived⁴¹ from the birth⁴² of the AP-child⁴³, and the title⁴⁴ for the U.S Citizen berthed is derived from the given-name⁴⁵ and the surname⁴⁶ of the AP-child born. Thus, the AP: "Darrell- James: Hill", has been juxtaposed with the U.S. Citizen⁴⁷: "DARRELL JAMES HILL", by and within the U.S. government's U.S. Citizen commercial⁴⁸ presumption system. Other U.S. Citizen-types exist, such as commercial corporations and government corporations; however, they are not the topic of the U.S. Citizen berth based upon the born AP-child. See: "AFFIDAVIT: Constructive Notice of DARRELL JAMES HILL's Authorized Representative: Darrell-James: Hill", 2 pages: annexed.

The AP: Darrell- James: Hill, is the Authorized-Representative⁴⁹, "A.R.", of the related commercial construct DARRELL JAMES HILL in any and all U.S. government encounters. Thus, this AP's election also includes the demand for the permanent presumption that in all U.S. government encounters the AP include the added distinction, "A.R.", in any and all regards to the commercial

- 33 **commercial** means: As relates to commerce, "The exchange of goods, productions, or property of any kind[;] in the nature of *Jeu Jo Wan v. Nagle*, C.C.A.Cal., 9 F.2d 308, 310; "relating to or connected with trade and traffic or commerce in general[;] in the nature of *Zante Currents*", C.C.Cal., 73 F. 189; *Black's Law Dictionary*, 4th Ed., pp. 336-337.
- 34 **Presumption** means: "Of fact. An interference affirmation or disaffirmative of the truth or falsehood of any proposition or fact drawn by a process of probable reasoning in the absence of actual certainty of its truth or falsehood, or until such certainty can be ascertained[;]" in the nature of *Best*, Pres. § 3; *Black's Law Dictionary*, 4th Ed., p. 1349.
- 35 **status** means: "Standing, state or condition[;]" in the nature of *Reynolds v. Pennsylvanian Oil Co.*, 150 Cal. 629, 89 P. 610, 612; "The legal relation of the individual to the [remainder] of the community[;]" in the nature of *Duryea v Duryea*, 46 Idaho 512, 269 P. 987, 988; *Black's Law Dictionary*, 4th Ed., p. 1580; *Black's Law Dictionary*, 4th Ed., p. 1580.
- 36 **Juxtaposed** means: having been put "in nearness or [close proximity]; or side by side...[;]" in the nature of *Brown v. State*, 126 Tex. Cr.R. 449, 72 S.W.2d 269, 270; *Black's Law Dictionary*, 4th Ed., p. 1005.
- 37 **Citizen** means: "A member of a free city or jural society (*civitas*,) possessing all [of] the rights and privileges which can be enjoyed by any person under its constitution and government, and subject to the corresponding duties...[;]" in the nature of *In Re McIntosh*, D.C.Wash., 12 F.Supp. 177; and, "A corporation is a citizen of a state under whose laws it is created and a nonresident of every other state[;]" in the nature of *Jackson Securities & Investment Co. v. State*. 241 Ala. 288, 2 S.2d 760, 764; *Black's Law Dictionary*, 4th Ed., p. 310.
- 38 **legal** means: "1. Conforming to the law; according to law; required or permitted by law; not forbidden or discountenanced by law; good and effectual in law[;]" in the nature of *Freeman v. Fowler Packing Co.*, 135 Kan. 378; 11 P.2d 276, 277; *General Motors Acceptance Corporation v. Schwartz*, 118 N.J.L. 25, 190 A. 625, 627; *Black's Law Dictionary*, 4th Ed., p. 1038.
- 39 **commercial construction** means: the fictitious construct "creation of something new, as distinguished from the repair of improvement of something already existing[;]" in the nature of *Cabell v. City of Portland*, 153 Or. 528, 57 P.2d 1292, 1297; *Black's Law Dictionary*, 4th Ed., p. 386; *Black's Law Dictionary*, 4th Ed., p. 386.
- 40 **originated** means: having had a beginning from after the original; to wit: ... "first in order; bearing its own authority, and not deriving authority from an outside source...[;]" in the nature of *Arenson v. Jackson*, 97 Misc.Rep. 606, 162 N.Y.S. 142, 143; *State v. Lee*, 173 La. 770, 138 So. 662; *Black's Law Dictionary*, 4th Ed., p. 1251.
- 41 **derive** means: "To receive, as from a source or origin[;]" in the nature of *Crews v. Commissioner of Internal Revenue*, C.C.A.10, 89 F.2d 412, 416; *Black's Law Dictionary*, 4th Ed., p. 530.
- 42 **birth** means: "The act of being born or wholly brought into separate existence[;]" in the nature of *Wallace v. State*, 10 Tex. App. 270; *Black's Law Dictionary*, 4th Ed., p. 213.
- 43 **child** means: the essential embodiment of the newly born of the man species; the physical, mental and spiritual baby maturity unto and until it is in time an adult in body/ mind/ spirit.
- 44 **title** means: "The designation of [a commercial] individual person, or a firm or a corporation[;]" in the nature of *Riley v. Litchfield*, 168 Iowa 187, 150 N.W. 81, 83, AnnCas.1917B, 172; *Black's Law Dictionary*, 4th Ed., pp. 1655, 1174.
- 45 **given-name** means: a non-commercial appellation for a man child, a gift; commonly referred to as the "Christian appellation".
- 46 **surname** means: "The family name; the name over and above the Christian name. The part of a name which is not given in baptism; that name of a person which is derived from the common name of his parents; in the nature of *In re Faith's Application*, 22 N.J. Misc. 412, 39 A.2d 638, 640; *Black's Law Dictionary*, 4th Ed., p. 1612.
- 47 **Citizen** means: "A member of a free city or jural society (*civitas*,) possessing all [of] the rights and privileges which can be enjoyed by any person under its constitution and government, and subject to the corresponding duties...[;]" in the nature of *In Re McIntosh*, D.C.Wash., 12 F.Supp. 177; and, "A corporation is a citizen of a state under whose laws it is created and a nonresident of every other state[;]" in the nature of *Jackson Securities & Investment Co. v. State*. 241 Ala. 288, 2 S.2d 760, 764; *Black's Law Dictionary*, 4th Ed., p. 310.
- 48 **commercial** means: As relates to commerce, "The exchange of goods, productions, or property of any kind[;]" in



AFFIDAVIT: Superior Constructive Notice and Demand:
Permanent Non-Commercial Presumption: man: Darrell- James: Hill

construct "DARRELL JAMES HILL", the U.S. Citizen.

U.S. Citizen Trojan Horse

The U.S. government, in creating and implementing its U.S.- Constitutionally⁵⁰ based commercial construct, the U.S. Citizen, did realize⁵¹ its need for possessing⁵² a status of a commercial persona⁵³, the U.S. Citizen, over which it held control⁵⁴, from which it could demand allegiance⁵⁵, and also, through which it could theoretically⁵⁶ vicariously⁵⁷ serve⁵⁸ the AP. To wit:

In the context of the Originating Documents constituting The united States of America, i, the AP, am Not a U.S. - Citizen or -"person" or -"fiction⁵⁹", nor can i: man ever be because i am real⁶⁰ and not a fiction. Thus, the U.S. government having had regulated that the "U.S. Citizen" status be imposed upon all and every man-, woman- and child- American Principal begat perversion⁶¹ onto its fiduciary⁶² duty⁶³ under the Originating Documents constituting The united States of America; thus,

The AP is due all of the Constitutional considerations of the natural rights⁶⁴ from Almighty- God

the nature of *Jeu Jo Wan v. Nagle*, C.C.A.Cal., 9 F.2d 308, 310; "relating to or connected with trade and traffic or commerce in general[;] in the nature of "Zante Currents", C.C.Cal., 73 F. 189; *Black's Law Dictionary*, 4th Ed., pp. 336-337.

- 49 **Authorized Representative** means: "A.R."; " a person, in the nature of UCC 1-201(27), empowered to act for another, including an agent, an officer of a corporation or association, and a trustee, executor, or administrator of an estate[;] in the nature of UCC 1-201(33). To wit: UCC 1-201(27): "Person" means an individual, corporation, business trust, estate, ..., or any other legal or commercial entity; UCC 1-201(33) "Representative" means a person empowered to act for another, including an agent..., and a trustee, executor,, or an administrator of an estate.
- 50 **U.S. Constitution** means: the commercial United States Constitution (~1871) as opposed to "The Constitution for the United States of America" of the Originating Documents of the Nation states of The united States of America (1787).
- 51 **realize** means: having acquired "gain by any means, usually by one's own exertions; to get as one's own; to obtain by search, endeavor, practice, or purchase; receive or gain in whatever manner; come to have[;] in the nature of *Clarno v. Gamble-Robinson Co.*, 190 Minn. 256, 251 N.W. 268, 269; *Black's Law Dictionary*, 4th Ed., p. 41.
- 52 **possessing** means: the process of "[t]he detention and control, or the manual or ideal custody, of anything which may be the subject of property, for one's use and enjoyment, either as owner or as the proprietor of a qualified right in ti, and either held personally or by another who exercises it in one's place and name. ...[;] in the nature of *Starits v. Avery*, 204 Iowa 401, 213 N.W. 769, 771; *Schenk v. State*, 106 Tex.Cr.R. 564, 293, S.W. 1101, 1102; *State v. Compton*, Mo.App., 297 S.W. 413, 414; *Nevin v. Louisville Trust Co.*, 258 Ky. 187, 79 S.W.2d 688, 689; *Black's Law Dictionary*, 4th Ed., p. 1325.
- 53 **persona** means: A character: a "[c]lass or division to which claim belongs," in the nature of *Jackson State Nat. Bank of Jackson, Miss. v. Merchants Bank & Trust Co. of Jackson, Miss.*, 177 La. 975, 149 So. 539, 294, "in virtue of which certain rights belong to a [commercial construct] and certain duties are imposed upon him. Thus one [commercial construct] may unite many characters, (*personae*), as, for example, the characters of father and son, of master and servant, [of Man and U.S. Citizen;] in the nature of *Mackeld.Rom.Law*, § 129; *Black's Law Dictionary*, 4th Ed., pp. 294, 1300.
- 54 **control** means: "Power or authority to manage, direct, superintend, restrict, regulate, direct, govern, administer, or oversee[;] in the nature of *Owen v Trail*, 302 Mo. 292, 258 S.W. 699, 702; *Hopkins v. Howard's Ex'x*, 266 Ky. 685, 99 S.W.2d 810, 812; *Black's Law Dictionary*, 4th Ed., p. 399.
- 55 **allegiance** means: Fealty "[o]bligation of faithfulness and loyalty"- "to the feudal lord ... upon the vassal by which he was bound"[;] in the nature of *De Peyster v. Michael*, 6 N.U. 497, 57 AmDec. 470; *Littleton* §§ 117, 131, et seq.; *Black's Law Dictionary*, 4th Ed., pp. 739,- "to [the U.S.] government in consideration for protection that government gives[;]" in the nature of *U.S. v. Kuhn*, D.C.N.Y., 49 F.Supp. 407, 414; *Black's Law Dictionary*, 4th Ed., pp. 99.
- 56 **theoretically** means: the theory of case: by which the "[f]acts on which the rights of action is claimed to exist[;] in the nature of *Pittsburgh, C., C. and St. L. Ry. Co. v. Rogers*, 45 Ind.App. 230, 87 N.E. 28, 31; *Black's Law Dictionary*, 4th Ed., p. 1649.
- 57 **vicariously** means: actively "taking the place of another person or thing; acting or serving as a substitute." - *The Random House Dictionary OTEL* (1971), p1590.
- 58 **serve** means: The acts of a servant, "one employed to perform service in [the] master's affairs, whose physical conduct in performance of the service is controlled or is subject to right to control by the master[;] in the nature of *Brenner v. Socony Vacuum Oil Co.*, 236 Mo.App. 524, 158 S.W.2d 171, 174, 175; *Reiling v. Missouri Ins. Co.*, 236 Mo.App. 164, 153 S.W.2d 79; *Black's Law Dictionary*, 4th Ed., p. 1533.
- 59 **fiction** means: "An assumption or supposition of law that something which is or may be false is true, or that a state of facts exists which has never really taken place[;] in the nature of *New Hampshire Strafford Bank v. Cornell*, 2 N.H. 324; *Hibberd v. Smith*, 67 Cal. 547, 4 P. 473, 56 Am.Rep. 726, et seq.; *Black's Law Dictionary*, 4th Ed., p. 751.
- 60 **real** means: Not fiction; "existing or occurring as fact; actual rather than imaginary, ideal of fictitious; being an actual thing; having objective existence; not imaginary;" *The Random House Dictionary OTEL* (1971), p1196.



687

AFFIDAVIT: Superior Constructive Notice and Demand:
Permanent Non-Commercial Presumption: man: Darrell- James: Hill

under the protection⁶⁵ by the U.S. government, et seq. trustee de son torts⁶⁶, on any and every level under the Originating Documents, et seq., constituting The united States of America in harmony with The Constitution for the United States of America; while,

A U.S. Citizen is due only the limits of statutory⁶⁷- or civil-rights⁶⁸ from the U.S. government under the protection by the U.S. government as the U.S. government may variably⁶⁹ sees-fit⁷⁰ under its private commercial constitution, the "U.S. Constitution".

Thereto, it is i:man by witness and experience that in the U.S. government's aiding⁷¹ or abetting⁷² any man-, woman-, or child- American Principal to ignorantly believe and thereupon act in any way to their distinct disadvantage is willful-fraud⁷³ and a clear perversion of the U.S. governmental- fiduciary duty under the Originating Documents assuring a constitutional republic to The united States of America people.

American Principal Dis-/Enfranchisement: Uniform Commercial Code

Under the Uniform Commercial Code⁷⁴, "UCC", law⁷⁵ used for the systematic⁷⁶ implementation⁷⁷

- 61 **perversion** means: in a perverse manner: "willfully determined or disposed to go counter to what is expected or desired;" a violation of normal; negligence. The Random House Dictionary OTEL (1971), p. 1076.
- 62 **fiduciary** means: A duty "holding the character of a trustee, or a character analogous to that of a trustee [capacity], in respect to the trust and confidence involved in it and the scrupulous good faith and candor which it requires[;] in the nature of *Svanoe v. Jurgens*, 144 Ill. 507, 33 N.E. 955; *Stoll v. King*, 8 How.Prac., N.Y., 299; *Black's Law Dictionary*, 4th Ed., p. 753.
- 63 **duty** means: legal duty "An obligation arising from contract of the parties or the operation of the law[;]" in the nature of *Riddell v. Ventilating Co.*, 27 Mont. 44, 69 P. 241; "That which the law requires to be done or forborne to a determinate [private or public] person or the [people or] public at large, correlative to a vested and coextensive right in such [a private or public] person or the [people or] public, and the breach of which constitutes negligence[;]" in the nature of *Railroad Co. v. Balentine*, C.C.A.Ill., 84 F. 935, 28 C.C.A. 572; *Toadvine v. Cincinnati, N. O. & T. p. Ry. Co.*, D.C.Ky., 20 F.Supp. 226, 227; *Black's Law Dictionary*, 4th Ed., p. 1039.
- 64 **rights** means: "... [A] power, privilege, faculty, or demand, inherent in one [a private or public] person"...[;] in the nature of *Holl. Jur.* 69; *Black's Law Dictionary*, 4th Ed., p. 1486.
- 65 **protection** means: the condition of to protect: "to defend or guard from attack, invasion, loss, annoyance, insult, etc.; cover or shield from injury or danger." The Random House Dictionary OTEL (1971), p. 1155.
- 66 **trustee de son tort** means: "of his own wrong".... A person who assumes to act as executor of an estate, out any lawful warrant or authority, but who, by his intermeddling, makes himself liable as an executor to a certain extent... [;] in the nature of 2 Bl.Comm. 507; *Allen v. Hurst*, 120 Ga 763, 48 S.E. 341, et seq.; *Black's Law Dictionary*, 4th Ed., p. 485.
- 67 **statutory** means: relating to statute: "An act of the legislature declaring, commanding, or prohibiting something; a particular law enacted and established by the will of the legislative department of government; the written will of the legislature, solemnly expressed according to the forms necessary to constitute it [as] the law of the state[;] in the nature of *Federal Trust Co. v. East Hartford Fire Dist.*, C.C.A.Conn., 283 F. 95, 98, et seq.; *Black's Law Dictionary*, 4th Ed., p. 1581.
- 68 **civil rights** means: Rights by statute: a license or permission or authority to do or not do something enabled by "an act of the legislature declaring, commanding, or prohibiting something; a particular law enacted and established by the will of the legislative department of government; ...[;] in the nature of *Federal Trust Co. v. East Hartford Fire Dist.*, C.C.A.Conn., 283 F. 95, 98, et seq.; *Black's Law Dictionary*, 4th Ed., p. 1581.
- 69 **variably** means: Characterized by variation: the act, process, or accident of varying in condition, character or degree. The Random House Dictionary OTEL (1971), p. 1581.
- 70 **sees fit** means: to act in the discretion of policy: "The general principles by which a government is guided in its management of public affairs, or the legislature in its measures. The term, as applied to law, ordinance, or rule of law, denotes its general purpose or tendency considered as directed to the welfare or prosperity of the state or community[;] in the nature of the term *Policy*[;] *Black's Law Dictionary*, 4th Ed., p. 1317.
- 71 **aiding** means: "To support, help, assist, or strengthen[;] in the nature of *Hines v. State*, 16 Ga.App. 411, 85 S.E. 452, 454; *Black's Law Dictionary*, 4th Ed., p. 91.
- 72 **abetting** means: To abet: "To encourage, incite, or set another on to commit a crime. This Word is always applied to aiding the commission of a crime. To abet another to commit [a crime] is to command, procure, or counsel him to commit it, in the nature of *Old Nat Brev.* 21; *Co. Litt.* 475; *Black's Law Dictionary*, 4th Ed., p. 17.
- 73 **willful fraud** means: "An intentional perversion of truth for the purpose of inducing another in reliance upon it to part with some valuable thing belonging to him or to surrender a [] right; a false representation of a matter of fact, whether by words or by conduct, by false or misleading allegations, or by concealment of that which should have been disclosed, which deceives and is intended to deceive another so that he shall act upon it to his [] injury[;] in the nature of *Bainerd Dispatch Newspaper Co. v. Crow Wing County*, 196 Minn. 194, 264 N.W. 779, 780; *Black's Law Dictionary*, 4th Ed., p. 788.
- 74 **Uniform Commercial Code** means: Uniform Laws: "[The] considerable number of laws [that] have been approved by the National Conference of Commissioners on the Uniform State Laws, and many of them have been adopted in one or more jurisdictions in the United States and its possessions...et seq.; in the nature of the term *Uniform Laws*; *Black's Law Dictionary*, 4th Ed., p. 1701.

Notice and Demand: Darrell- James: Hill

2022-011769 MISC Page: 688 of 2782

09/26/2022 03:35:37 PM Receipt #: 22-9381

Rec Fee: \$30.00 Darrell James Hill

Gila County, Az, Sadie Jo Bingham, Recorder



690

AFFIDAVIT: Superior Constructive Notice and Demand:
Permanent Non-Commercial Presumption: man: Darrell- James: Hill

of the U.S. Citizen presumption scheme⁷⁸ upon the AP, i: man, must frequently and repetitively assert⁷⁹ in the nature of the UCC the remedy⁸⁰ in the UCC 1-308⁸¹ under the right of the recourse under the UCC 1-103⁸² in all and every U.S. governmental commercial encounter, notifying and redirecting every U.S. government construct encountered – with all U.S. governmental police⁸³ – of my private- AP rights guaranteed protected under the Originating Documents constituting The united States of America.

Since most American Principals, for their lack of knowledge, are ignorant⁸⁴ of the truth, facts and concepts mentioned herein, then this lack of knowledge prevents most American Principals from entering knowingly⁸⁵, voluntarily⁸⁶, and intentionally⁸⁷ into a valid contract within any U.S. government construct encounter. And, due to the many decades of the categorical⁸⁸ suppression⁸⁹ of all truth concerning the AP sovereign responsibility, hundreds of millions of men-, women- and children- American Principal's have suffered and continue to blindly presume themselves to be fictions, to be U.S. Citizens; they, therefore, individually and collectively, unwittingly and unintentionally corroborate the abolition⁹⁰ of their natural rights given them from Almighty God.

Therefore, the proactive fiduciary protection actions for all American Principals have been

- 75 law means: "That which is laid down, ordained, or established. A rule or method according to which phenomena or action co-exist or follow each other...[;] in the nature of Koenig v. Flynn, 258 N.Y. 292, 179 N.E. 705; "[A]n unconstitutional statute is not a law, in the nature of John F. Jelke Co. v. Hill, 208 Wis. 650, 242 N.W. 576, 581, et seq.; Black's Law Dictionary, 4th Ed., p. 1028.
- 76 systematic means: characteristic of a system: "Orderly combination or arrangement, as of particulars, parts, or elements into a whole; especially such combination according to some rational principle; any methodic arrangement of parts[;] in the nature of State v. Kistler, 119 Neb. 89, 227 N.W. 319, 320; Black's Law Dictionary, 4th Ed., p. 1621.
- 77 implementation means: proceedings to implement: "to fulfill, perform; carry out; to put into effect according to or by means of a definite plan or procedure. The Random House Dictionary OTEL (1971), p 715.
- 78 scheme means: "A design or plan formed to accomplish some purpose – a system[;]" in the nature of Snider v. Leatherwood, TexCiv.App., 49, S.W.2d 1107, 1110; Black's Law Dictionary, 4th Ed., p. 1511.
- 79 assert means: "To state as true; declare; maintain. To assert against another has probably a *prima facie* meaning of a contradiction of him, but the context or circumstances may show that it connotes a criminatory charge; in the nature of 7 L.J.Ex. 268; Black's Law Dictionary, 4th Ed., p. 149.
- 80 remedy means: "The means by which a right is enforced or the violation of a right is prevented, redressed, or compensated. ...; in the nature of Sweet. Berry v. M. F. Donovan & Sons, 120 Me. 457, 115 A. 250, 252, 25 S.L.R. 1021, et seq.. Strictly speaking, "remedy" is not part of [an] action, but is the result thereof, the object for which [an] action is presented, the end to which all the litigation is directed[;] in the nature of Mathews v. Sniggs, 75 Okl. 108, 182 P. 703, 707; Black's Law Dictionary, 4th Ed., p. 1457.
- 81 UCC 1-308 means: "Performance or Acceptance Under Reservation of Rights. (a) A party that with explicit reservation of rights performs or promises performance or assents to performance in a manner demanded or offered by the other party does not thereby prejudice the rights reserved. Such words as "without prejudice," "under protest," or the like are sufficient. (b) Subsection (a) does not apply to an accord and satisfaction." Legal Information Institute; <https://www.lawcornell.edu/ucc/1/1-308>
- 82 UCC 1-103 means: "Construction of Uniform Commercial Code to Promote its Purposes and Policies: Applicability of Supplement Principles of Law. (a) The [UCC] must be liberally construed and applied to promote its underlying purposes and policies, which are: (1) to simplify, clarify, and modernize the law governing commercial transactions; (2) to permit the continued expansion of commercial practices through custom, usage, and agreement of the parties; and (3) to make uniform the law among the various jurisdictions. (b) Unless displaced by the particular provisions of the [UCC], the principles of law and equity, including the law merchant and the law relative to capacity to contract, principal and agent, estoppel, fraud, misrepresentation, duress, coercion, mistake, bankruptcy, and other validating or invalidating cause supplement its provisions. Legal Information Institute; <https://www.lawcornell.edu/ucc/1/1-103>
- 83 police means: A policy officer: Generally, "[A] function ... of the administrative machinery of government [for] the preservation of public order[,] and issuing complaints for violations of [commercial] crimes [against the public order;]" in the nature of State v. Hine, 59 Conn. 50, 21 A. 1024, 10 L.R.A. 83; et seq.; Black's Law Dictionary, 4th Ed., p. 1316.
- 84 ignorant means: Lack of knowledge.
- 85 knowingly means: With knowledge: "Acquaintance with fact or truth," in the nature of United States Fire Ins. Co. v. Smith, 231 Ala. 169, 164 So. 70, 82, 103 A.L.R. 1468; People v. Henry, 23 Cal.App.2d 155, 72 P.2d 915, 921; Black's Law Dictionary, 4th Ed., p. 1012.
- 86 voluntarily means: Descriptive of voluntary: "Unconstrained by by interference; unimpelled by another's influence;" et seq.; in the nature of Coker v State, 199 Ga 20, 33 S.E.2d 171, 174; Black's Law Dictionary, 4th Ed., p. 1746.
- 87 intentionally means: Descriptive of intention: "Determination to act in a certain way or to do a certain thing[;] in the nature of State ex rel. Verbon v. County of St. Louis, 216 Minn. 140, 12 N.W.2d 193, 196; et seq.; Black's Law Dictionary, 4th Ed., p. 948.
- 88 categorical means: "absolute; unqualified and unconditional. " The Random House Dictionary OTEL (1971), p 233.
- 89 suppression means: Condition to suppress: "To put a stop to a thing actually existing; to prohibit, put down, to



691

AFFIDAVIT: Superior Constructive Notice and Demand:
Permanent Non-Commercial Presumption: man: Darrell- James: Hill

technically abandoned by the U.S. government in preference for its U.S. Citizen sub-type – person that it controls; and, all hope of proactive protective action from the U.S. government is a choice in the nature of the UCC sections indicated above that every every man-, women- and child- American Principal must frequently and repetitively assert in all U.S. government encounters to stand in their sovereignty⁹¹ under the original basis of Law of the Originating Documents constituting the union of the people enabling the States of America.

The U.S. Citizen Profit Center: American Principal

Hence, the targeting⁹² of the “American Principals” as presumed “U.S. Citizens” has become a lucrative, for-profit⁹³, commercial enterprise⁹⁴ amassing⁹⁵ money and millions upon millions of Federal Reserve Note⁹⁶, “FRN”, dollars⁹⁷ in charges, fees and penalties of all kinds imposed under the U.S. Citizen presumption scheme. The duty of protection from all U.S. government constructs is nearly completely abandoned; because, their failure in their duty to protect the men-, women-, and children- American Principals from the actual damages of the systematic U.S. Citizen presumption scheme is, at the least, extremely lucrative.

Finally, I observe that the systematic imposition of this lucrative scheme in all U.S. government encounters with every man-, woman- and child- American Principal is the most comprehensive direct overt⁹⁸ and covert⁹⁹ abuse of the U.S. government's fiduciary duty ever imposed upon every man-, woman- and child- American Principal, bar none; because, ALL American Principals have been enslaved.

Against this, the **Remedy and Right of Recourse** for man to resolve this real, ever present and escalating threat to the Almighty God- given rights of life and liberty and property must now-to-fore be pursuant to this Notice and Demand prerogative^{100 101}. To this end:

**Under the Originating Documents constituting The united States of America
herein is made Notice upon the U.S. government- Trustee: to wit,
UPON THE RECEIPT OF THIS NOTICE YOU ARE
IMMEDIATELY TO COMPLY.**

prevent, subdue, or end by force[;] in the nature of State v. Mustachia, 152 La. 821, 94 So. 408, 409; State ex rel. Hamilton v. Martin, 173 Wash. 249, 23 P.2d 1; Black's Law Dictionary, 4th Ed., p. 1609.

90 **abolition** means: “The destruction, annihilation, abrogation, or extinguishment of anything[;] in the nature of Perterson v. Pratt, 183 Iowa 462, 167 N.W. 101; Black's Law Dictionary, 4th Ed., p. 20.

91 **sovereignty** means: The authorization of government, originating with the Almighty God given stewardship to man, and derived from man by consent unto the limitations in the Originating covenant(s) into the/a utility of a man's government: to wit, sovereign is man's government under man, and sovereign is man under Almighty God.

92 **targeting** means: Process of pursuing a target: “an object of abuse, scorn, derision, etc.,” butt. The Random House Dictionary OTEL (1971), p. 1454.

93 **for profit** means: For commercial gain.

94 **enterprise** means: “A project or undertaking[;] in the nature of Sizemore v. Hall, 148 Kan. 233, 80 P.2d 1092, 1095; Black's Law Dictionary, 4th Ed., p. 625.

95 **amassing** means: to Amass: “to collect into a mass or pile; accumulate; gather[.]” The Random House Dictionary OTEL (1971), p. 45.

96 **Federal Reserve Note** means: i) **Note**: A unilateral instrument containing an express and absolute promise of signer to [discharge a debt] to a specified person or order, or bearer, a definite sum of money at a specified time[;] in the nature of Shawano Finance Corporation v. Julius, 214 Wis. 637, 254 N.W. 355; Black's Law Dictionary, 4th Ed., p. 1210. ii) **Money**: “In usual and ordinary acceptance it means: gold, silver, or paper money used as circulating medium of exchange, and does not embrace notes, bonds, evidences of debt, or other personal or real estate[;] in the nature of Lane v. Railey, 280 Ky. 319, 133 S.W.2d 74, 79,81; Black's Law Dictionary, 4th Ed., p. 625. iii) **Federal Reserve**: a private, non-monitored, non- U.S. Government, non- taxable, for-profit commercial bank, operating with impunity, so enabled by the U.S. government unto their state financial benefits and interests.

97 **dollars** means: i) Under Constitution of the Originating Documents: One ounce of silver “[T]he unit employed in the United States in calculating money values [on a system] of value of one hundred cents [per one ounce of silver unit;]” in the nature of People v Alva, 46 Cal.App.2d 859, 117 P.2d 63; Black's Law Dictionary, 4th Ed., p. 570. ii) Under the U.S. Constitution of the U.S. Government: refers to the private commercial, world-wide FRN fiat note: a credit instrument, based in no inherent redeemable value such as silver or gold; but, based upon the full faith in and credit integrity accorded to the issuers.

98 **overt** means: 'in your face', “Open; manifest; public; issuing in action, as distinguished from that which rests merely in intention or design[;] un the nature of Commonwealth v. Barnes, 107 Pa.Super. 46, 162, A. 670, 675; Black's Law Dictionary, 4th Ed., p. 1258.

99 **covert** means: hidden, Not overt; to wit: Not open; Not manifest; Not public, etc.

100 **prerogative** means: "... an exclusive right, privilege, etc., exercised by virtue of rank, office or the like; ...a power, immunity, or the like restricted to a sovereign..." The Random House Dictionary OTEL (1971), p. 1137.

101 **ICCPR Treaty of 1992**. See: U. S. reservations, declarations, and understandings, International Covenant on Civil and Political Rights: 138 Cong. Rec. S4781-01 (daily ed., April 2, 1992)

Notice and Demand: Darrell- James: Hill

70510

2022-011769 MISC Page: 690 of 2782

09/26/2022 03:35:37 PM Receipt #: 22-9381

Rec Fee: \$30.00 Darrell James Hill

Gila County, Az, Sadie Jo Bingham, Recorder



692

**AFFIDAVIT: Superior Constructive Notice and Demand:
Permanent Non-Commercial Presumption: man: Darrell- James: Hill**

NOTICE

1. This document identifies that I:man, Darrell- James: Hill, A.P., am the beneficiary principal superior to the U.S. Government. The U.S. Government is i) the respondeat-superior¹⁰² to the U.S. Government, et al., "U.S. government", and ii) the U.S. government is the AP-Cestui-Que-Trust¹⁰³ Trustee¹⁰⁴, thus the U.S. -government and Trustee, "U.S. government- Trustee", is under the dual fiduciary duty to i under the a) Originating Documents constituting the union of the States of America, and b) subsequent acts thereunder. To wit: The U.S. Government is in the Constitutional service¹⁰⁵ of all American Principals and this AP; and, the U.S. Government is the defacto¹⁰⁶ constructive¹⁰⁷ Trustee for the this AP-Cestui-Que-Use¹⁰⁸ for the competent¹⁰⁹ sole protection of every American Principal's and this AP- beneficiary's¹¹⁰ property¹¹¹ held by the any AP Cestui Que Vie Trust by the any U.S. government-Trustee from the inception.
2. This Notice and Demand is promulgated¹¹² to identify, mention, establish and consider, reason the situation, and authenticate¹¹³ this Sovereign Order¹¹⁴ – NOTICE AND DEMAND for the setting of the permanent presumption of this AP in every U.S. governmental encounter and consideration to 'AP, A.R.' of the juxtaposed U.S. Citizen commercial construct, in the nature of UCC 1-308 and UCC 1-103, in all

- 102 **respondeat superior** means: ..." that a master is liable in certain cases for the wrongful acts of his servant, and a principal for those of his agent[;] in the nature of Broom Max 843; Southern Paramount Pictures Co. v. Gauling, 24 Ga.App. 478, 101 S.E. 311; Delaware, L. & W. R. Co. v. Pittinger, C.C.A.N.J., 293 F. 853, 855; Black's Law Dictionary, 4th Ed., p. 1475.
- 103 **AP Cestui Que Trust** means: The "[AP] who has a right to a beneficial interest in and out of an estate the legal title to which is vested in another[;] in the nature of 2 Washb. Real Prop. 163; Black's Law Dictionary, 4th Ed., p. 289.
- 104 **Trustee** means: "The person appointed, or required by law, to execute a trust; one in whom an estate, interest, or power is vested, under an express or implied agreement to administer or exercise it for the benefit or to the use of another called the cestui que trust[;] in the nature of Pioneer Mining Co. v. Tyberg, C.C.A.Alaska, 215 F. 501, 506, L.R.A.1915B, 442, et seq.; Black's Law Dictionary, 4th Ed., p. 1684.
- 105 **servant** means: One who serves.
- 106 **defacto** means: in context under the Originating Documents unto and into the present form of U.S. Government, "in fact; actually; indeed; in reality[;] in the nature of Ridout v. State, 161 Tenn. 248, 30 S.W.2d 255, 257, 71 A.L.R. 830; Black's Law Dictionary, 4th Ed., p. 504.
- 107 **constructive** means: "That which is established by the mind of the law in its act of *construing* facts, conduct, circumstances, or instruments; that which has not the character assigned to in in its own essential nature, but acquires such character in consequence of the way in which it is regarded by a rule or policy of law; hence, inferred, implied, made out by legal interpretation: the word "legal" being sometimes used in lieu of "Constructive[;]" in the nature of Middleton v. Parke, 2 App.D.C. 160; Black's Law Dictionary, 4th Ed., p. 386.
- 108 **AP Cestui Que Use** means: "He for whose use and benefit lands or tenements are held by another. The *cestui que use* has the right to receive the profits and benefits of the estate, but the legal title and possession (as well as the duty of defending the same) reside in the other[;] in the nature 2 Bla.Comm. 330; 2 Washb. Real Prop. 95; Black's Law Dictionary, 4th Ed., p. 289.
- 109 **competent** means: "duly qualified; answering all requirements; having sufficient ability or authority; possessing the requisite natural or legal qualifications; able; adequate; suitable; sufficient; capable; legally fit[;] in the nature of Levee Dist. v. Jamison, 176 Mo. 557, 75 S.W. 679, et seq.; Black's Law Dictionary, 4th Ed., p. 355.
- 110 **beneficiary** means: i)The Cestui Que Use: "He for whom use and benefit lands or tenements are held by a [Trustee]. The *cestui que use* has the right to receive the profits and benefits of the estate, but the legal title and possession (as well as the duty of defending the same) reside in the [Trustee;] in the nature of 2 Bla.Comm. 330; 2 Washb.Real Prop. 95; Black's Law Dictionary, 4th Ed., p. 289.
- 111 **property** means: "...[E]verything which is the subject of ownership, corporeal or incorporeal, tangible or intangible, visible or invisible, real or personal; everything that has an exchangeable value or which goes to make up wealth or estate. It extends to every species of valuable right and interest, and includes real and personal property, easements, franchises, and incorporeal hereditaments[;] in the nature of Samet v. Farmers' & Merchants' Nat. Bank of Baltimore, C.C.A.Md., 247 F. 669, 671; Globe Indemnity Co. v. Bruce, C.C.A.Okl., 81 F.2d 143, 150; Black's Law Dictionary, 4th Ed., p. 1382.
- 112 **promulgate** means: "To publish; to announce officially; to make public as important or obligatory[;]" in the nature of Price v. Supreme Home of the Ancient Order of Pilgrims, Tex.Com.App., 285 S.W. 310, 312; Black's Law Dictionary, 4th Ed., p. 1380.
- 113 **authenticate** means: To perform "[t]he act or mode of giving authority or legal authenticity to a statute, record, or other written instrument, or a certified copy thereof, so as to render it legally admissible in evidence[;] in the nature of Voloshin v. Ridenour, C.C.A.CanalZone, 299 F. 134, Verifications of judgments, Collette v. Hanson, 174 A. 466, 133 Me. 146; Black's Law Dictionary, 4th Ed., p. 168.
- 114 **order** means: "A mandate, precept; a command or direction authoritatively given; a rule or regulation[;] in the nature of Brady v. Interstate Commerce Commission, D.C. W.Va., 43 F.2d 847, 850; Black's Law Dictionary, 4th Ed., p. 1247.



693

**AFFIDAVIT: Superior Constructive Notice and Demand:
Permanent Non-Commercial Presumption: man: Darrell- James: Hill**

and any U.S. government- Trustee databases¹¹⁵, also including U.S. government- Trustee's proxy databases.'

3. I: man make Notice to the U.S. government- Trustee that my inalienable¹¹⁶ and sovereign rights are from the Almighty God to i: man of the people, a private-person, and the beneficiary of the AP Cestui Que Vie Trust, and of the public trust of The united States of America people; and that:

- 3.i. There is No-one and No-thing between the Almighty God and i: Darrell- James: Hill: man;
- 3.ii Below and beneath me, the sovereign AP- beneficiary, is The united States of America territory¹¹⁷ and any commercial or other construct is under, below and beneath of the sovereign God Almighty and man founded;
- 3.iii Any U.S governmental presumption or mechanism¹¹⁸ to subvert¹¹⁹ this political election and choosing which is under Almighty God is heresy¹²⁰ in-situate¹²¹, and which is under the AP-beneficiary insubordinate¹²², and which is under Constitutional-Law¹²³ willful-fraud and malfeasance¹²⁴ of fiduciary duty upon its face¹²⁵;
- 3.iv The U.S. Government in situate is: a) the defacto respondeat superior Trustee in service to the American beneficiary: Darrell- James: Hill, under the Originating Documents; and, b) responsible to protect this beneficiary in all actions concerning his property in every asset as this AP's election intent is claimed, expressed explicitly, and herein presented.

Wherefore, the **Remedy and Right of Recourse** for i to resolve this real, ever present and escalating threat to the Almighty God- given rights of life and liberty and property shall be pursuant to this Notice and Demand Order.

To this end:

**Under the Originating Documents constituting The united States of America
herein is made Demand upon the U.S. government- Trustee: to wit,
UPON THE RECEIPT OF THIS DEMAND YOU ARE
IMMEDIATELY TO COMPLY.**

DEMAND

The U.S. government- Trustee must henceforth know and acknowledge that i: man, am Darrell-James: Hill, the AP- beneficiary of the AP Cestui Que Vie Trust: to wit; i: man, under Almighty God, am: 1) an American National Citizen of the Ohio state of the Nation states of The united States of America, a private person of the people with inalienable rights from Almighty God under the protection of the Originating Documents constituting The united States of America, and thereto under the absolute protection from the every U.S. government- Trustee; that, 2) this AP- beneficiary is the Authorized- Representative of the DARRELL JAMES HILL commercial entity, by the sundry well-known historical

115 database means: any datum, and all data sought, obtained, accumulated, stored, and retrievable information related to this Man, or any other data any other way touching upon this Man's history, present and future.

116 inalienable means: Those things given from Almighty God which are non-constrainable and given without respect of person; to wit: "Not subject to alienation; the characteristic of those things which cannot be bought or sold or transferred from one person to another," in the nature of God given; Black's Law Dictionary, 4th Ed., p. 903.

117 territory means: "any tract of land; region or district" The Random House Dictionary OTEL (1971), p. 1466.

118 mechanism means: "the structure or arrangement of parts of a machine or similar device, or of anything analogous." The Random House Dictionary OTEL (1971), p. 889.

119 subvert means: "to undermine the principles of; corrupt." The Random House Dictionary OTEL (1971), p. 1419.

120 heresy means: The expressions of a heretic: "a professed believer [in Almighty God] who maintains [and expresses doctrinal beliefs and] opinions contrary to" and rejects those given by Almighty God. The Random House Dictionary OTEL (1971), p. 664.

121 in situate means: Present, existent in the "[s]tate of being placed; posture[;]" in the nature of Jones v. Tuck, 48 N.C. 202, 205; Black's Law Dictionary, 4th Ed., p. 1558.

122 insubordinate means: U.S. governmental disobedience to the constituted authority under the Originating Documents under Man under Almighty God.

123 Constitutional Law means: reference specifically to The Constitution for the United States of America in context to the Originating Documents.

124 malfeasance means: "Evil doing; ill conduct; the commission of some act which is positively unlawful; the doing of an act which is wholly wrongful and unlawful; the doing of an act which [the Trustee] ought not to do at all or the unjust performance of some act which [the Trustee] had no right or which he had contracted not to do... [;]" in the nature of State ex rel. Knabb v Frater, 198 Wash. 675, 89 P.2d 1046, 1048; Black's Law Dictionary, 4th Ed., p. 1109.

125 face means: overt; openly obvious and present.



694

AFFIDAVIT: Superior Constructive Notice and Demand:
Permanent Non-Commercial Presumption: man: Darrell- James: Hill

documents in the public record including, but not limited to, the CUSIP # [REDACTED] and Ariz. DL # D01174172- a document that evidences the photographic likeness of the A.R., all available evidences of the fact;
and, that:

- I. In any condition, including, but not limited to, martial rule¹²⁶ and/or martial law¹²⁷, the U.S. government- Trustee shall maintain its Constitutional and fiduciary duty under Almighty God to this AP: Darrell- James: Hill, under the Originating Documents constituting The united States of America: to wit, that:
 - I.a. In any condition this AP: Darrell- James: Hill, man, is Not ever to be presumed to be the commercial construct, U.S. Citizen DARRELL JAMES HILL, nor presumed to stand in surety¹²⁸ for the commercial construct DARRELL JAMES HILL, U.S. Citizen;
 - I.b. In any and every condition wherever this AP: Darrell- James: Hill, is traveling¹²⁹ and/or is sojourning¹³⁰ and/or is inhabiting¹³¹, by any and every means this AP shall be presumed as within his rights inalienable from Almighty God, and the same right(s) which are under the Originating Documents constituting The united States of America by duty protected by the every U.S. government- Trustee;
 - I.c. This election and setting of the permanent presumption by this AP- beneficiary denies¹³² and declines¹³³ any pretext¹³⁴ of the presumption of rightful duty or authorization, et seq., to stalk¹³⁵, record¹³⁶ in any and every form, type or method, including, but not limited to, DNA¹³⁷ and neurological-characteristics¹³⁸: to wit:
 - I.c.i. Any possessed authorization in any form of authorization, et seq., to monitor, record in any and every form, type or method, including, but not limited to, DNA and neurological-characteristics, is rescinded¹³⁹;
 - I.c.ii. Any future authorization in any form of authorization, et seq., to monitor, record in any and every form, type or method, and/or including, but not limited to, DNA and neurological-characteristics, must be expressively authorized without duress or deception;

-
- 126 martial rule means: i) martial: "Inclined or disposed to war, warlike;... pertaining to or connected with the army and navy." The Random House Dictionary OTEL (1971), p. 880. ii) rule: a principle or regulation governing conduct, action, procedure, arrangement, etc.. The Random House Dictionary OTEL (1971), p. 1252.
- 127 martial law means: An extreme form of social crisis control measure when the "military authorities carry on [the] government or exercise [under Constitutional precepts] various degrees of control over [the] civilians or civilian authorities in [a] domestic territory[;] in the nature of Ochikubo v. Bonesteel, D.C.Cal., 60 F.Supp. 916, 928, 929, 930; Black's Law Dictionary, 4th Ed., p. 1126.
- 128 surety means: "One [who is] bound with his principal for the payment of a sum or money or for the performance of some duty or promise and who is entitled to be indemnified by some one who ought to have paid or performed if payment or performance be enforced against him[;] in the nature of Anderson v. Trueman, 100 Fla. 727, 130 So. 12, 13; Black's Law Dictionary, 4th Ed., p. 1621.
- 129 traveling means: an Almighty God given Constitutionally protected right pass place to place on the earth.
- 130 sojourning means: an Almighty God given Constitutionally protected right to live in this time transiently on earth.
- 131 inhabiting means: an Almighty God given Constitutionally protected right to live, stay, rest, dwell at on the earth.
- 132 denies means: "to refuse to agree or accede to..." The Random House Dictionary OTEL (1971), p. 387.
- 133 decline means: "to withhold or deny consent to do, enter into or upon, etc.; refuse" The Random House Dictionary OTEL (1971), p. 375.
- 134 pretext means: 'an outwardly appearing reason or motive i) imposed upon or over another or ii) pretended under the appearance of a legal reason or for the cover of no legal reason or probable cause; false appearance, pretense[;] in the nature of State v. Ball, 27 Neb. 604, 43 N.W. 398; Black's Law Dictionary, 4th Ed., p. 1351.
- 135 stalk means: "to pursue or approach quarry." The Random House Dictionary OTEL (1971), p. 1384.
- 136 record means: "to set down [in any data form], as for the purpose of preserving evidence" The Random House Dictionary OTEL (1971), p. 1200.
- 137 DNA means: 'deoxyribonucleic acid: the class of found chiefly in the nucleus of cells, and that function in the transference of genetic instructions and characteristics, and synthesis of protein.' The Random House Dictionary OTEL (1971), p. 421.
- 138 neurological characteristics means: i) neurological: having to do with neuroanatomy: "the nerve structure of man..., or of any parts of the organism." The Random House Dictionary OTEL (1971), p. 960.
- 139 rescinded means: rescind: "To abrogate, annul, avoid, or cancel a contract; particularly, nullifying a contract by the act of a party[;] in the nature of Vaughn v. Fey, 47 Cal.App. 485, 190 P. 1041, 1042, et seq.; Black's Law Dictionary, 4th Ed., p. 1471.



AFFIDAVIT: Superior Constructive Notice and Demand:
Permanent Non-Commercial Presumption: man: Darrell- James: Hill

- I.c.iii. Any and all U.S. government- Trustee encounters in any form must refer to this private AP- beneficiary: Darrell- James: Hill, due all of their duty in respect and forceful protections in the full from the every U.S. government- Trustee;
- I.c.iv. All presumable searches of commercial construct: DARRELL JAMES HILL, and/or of the AP- beneficiary, A.R., in/by any variation by any U.S. government- Trustee shall henceforth permanently refer to the AP- beneficiary presumption of the private 'AP, A.R.' to the U.S. governmental U.S. Citizen; to wit: "Darrell- James: Hill, A.R. of the U.S. commercial construct DARRELL JAMES HILL".
- I.c.v. Denied and declined and rescinded before-now- and to-fore is any presumption of permission for the U.S. government- Trustee to survey and/or invade with any object and/or technology for any covert or overt purpose or other reason any airspace over any area or territory known or suspected inhabited by this man-AP- beneficiary without of the U.S. government- Trustee's express permission from the man-AP- beneficiary herenow to forever, and to only perform any duty and obligations in the strict-protection of this AP- beneficiary within the limitation of the Originating Documents constituting The united States of America;
- I.c.vi. Denied and declined and rescinded now-to-fore is any presumption of permission for the U.S. government- Trustee to dispose any chemical and/or variant of technology into the airspace, or upon or into this AP- beneficiary Darrell- James: Hill by any method or action without of the U.S. government- Trustee's express permission from the AP- beneficiary herenow to perform the any duty and obligations in the strict protection of the AP- beneficiary within the confines of the Originating Documents for The united States of America;
- I.c.vii. Denied and declined and rescinded now-to-fore is any presumption of permission for the U.S. government- Trustee to surveil/ invade any land area inhabited by the AP- beneficiary, or to enter upon or under into the land or habitat area of this AP- beneficiary by any method or action without of the U.S. government- Trustee's express permission from the AP- beneficiary herenow to only perform the any duty and obligation in the strict protection of the AP- beneficiary within the confines of the Originating Documents constituting The united States of America;
- I.c.viii. Denied and declined and rescinded is any presumption of permission for the U.S. government- Trustee to impose any hardship disaffecting by any means, process or proxy the inalienable rights to the clear and undisturbed enjoyment by this AP- beneficiary in and/or about his any habitation.
- I.c.ix. Denied and declined and rescinded is any presumption of the permission for the U.S. government- Trustee to impose any hardship by any method or action disaffecting the inalienable rights of unfettered and unimpeded travel by this AP- beneficiary without of the express permission from the AP- beneficiary herenow to only perform the any duty and obligation in the strict protection of the AP- beneficiary within the confines of the Originating Documents constituting The united States of America.

PENALTY FOR VIOLATIONS

Violation¹⁴⁰ of this sovereign Notice and Demand constitutes the common-law corpus-delecti¹⁴¹ under the Originating Documents constituting The united States of America with the assumption of criminal intent and yielding tacit¹⁴² procuration¹⁴³ to this AP- beneficiary, his heirs, agents or assigns for to proceed in suit without adversity for the receipt of damages as the primary creditor upon the any U.S. government- Trustee and/or the any trustee son de tort violator(s) directly committing the damage(s), in both their professional and private persons and/or statuses upon this schedule:

- 140 Violation means: The act of violating: "1. to break, infringe, or transgress (a law, rule, duty, agreement, promise, instructions, etc.). 2. to break in upon , or disturb rudely; interfere thoughtlessly with...." The Random House Dictionary OTEL (1971), p. 1594.
- 141 corpus delecti means: i) corpus: body, literally, or "an aggregate or mass: men, laws, articles; physical substance as distinguished from intellectual conception ...[;]" in the nature of In re Barron's Will, 163 Wis 275, 155 N.W. 1087, 1089, et seq.; ii) corpus delecti means: "The body [substance] of a crime...[;]" Black's Law Dictionary, 4th Ed., p. 1351.
- 142 tacit means: "Existing, inferred, or understood without being openly expressed or stated[;]" Black's Law Dictionary, 4th Ed., p. 1623.
- 143 procuration means: "... The act by which one person gives power to another to act in his place, as he could do himself[;]" in the nature of Clinton v. Hibb's Ex'x, 259 S.W. 356, 358, 202 Ky. 304, 35 A. L.R. 462.; Black's Law Dictionary, 4th Ed., p. 1372.



696

**AFFIDAVIT: Superior Constructive Notice and Demand:
Permanent Non-Commercial Presumption: man: Darrell- James: Hill**

- i) **First Offense Damages:** inherent value of one thousand one hundred fifty of the one ounce .999 silver dollars of the United States mint per hour of damage and for any part of any hour thereafter, plus any additional damages as the jury/ court may allow;
- ii) **Second Offense Damages:** 100 times of i) First Offense Damages, et seq.;
- iii) **Third and Subsequent Offense Damages:** 100 times of ii) Second Offense Damages, et seq..

COMPLIANCE

Upon receipt of this Notice and Demand Order you must immediately comply. If you do not comply with the Order within a grace of five days time from after receipt then in so doing you have acquiesced to the Demand Order herein and by tacit procuracy have agreed to and will proactively and efficaciously i) comply with this Demand Order in total, and ii) pay all costs associated with any and all efforts to enforce any compliance against your, et al.'s, any impedance of this Constructive Notice and Demand, plus damages, including, but not limited to, the "Penalty for Violation: I) First Offense Damages" in damages, et seq.

**Notice to the Agent is Notice to the Principal
Notice to the Principal is Notice to the Agent**

Autographed: 3rd day: July month: 2018

Without Prejudice

Darrell- James: Hill, man

Sworn to and subscribed before me now on this 3rd day: July month: 2018.
Produced identification: type: Arizona Driver License.

Notary

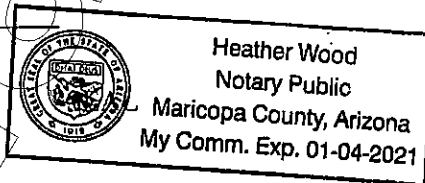

**:AFFIDAVIT: CLAIM OF CRIMINAL WRONG-DOING:
DEPRIVATION OF THE PROTECTED RIGHT FOR TO RECORD DOCUMENTS INTO
THE PUBLIC RECORD IS CRIMINALLY VIOLATED BY THE PEOPLE
AT THE SUMMIT COUNTY OHIO RECORDATION AGENCY (Summit County Fiscal Office)**

State of Arizona

County of Pinal

:Darrell- James: Hill: man, personally appears before me, the undersigned Notary duly authorized by the laws of Arizona to administer oaths; now on this 5th day: July month: 2018 : 11 : 12 am pm, being by me first duly sworn on his affirmation, affiant deposes and says:

I: man am, according to the document(s) memorializing live birth, born on the ground of the Summit county, Ohio state, in the year: 1958. i am sui juris and now will testify to affirm the contents of this document(s) set for the recording into the public record as the written evidence of the something done, or document, or considered as with concerning or interesting the public, affording notice or information to the public, or open to public inspection.

For the reason of the fact that the document memorializing the live birth of Darrell- James; family of Hill, is not recorded onto the Summit County Ohio public record in the year: 1958 or after; according to the rights protected and inalienable under the covenant of The Constitution for the United States of America people, et seq.; and, as relates to: any "vessel of the United States (in the nature of: Congressional Act of 1871; 28 USCA § 3002; 18 USCA § 9)": substance of the evidence reported herein establishes the facts that a crime is committed and ongoing now by the people at the Summit County Ohio recordation agency AGAINST the man by their depriving the man of the protected and inalienable right to record into the public record the man's chosen document: matter's of the man's live- life being now and political election now. To wit:

- a) On April 12th, 2018, from i: man was received by the Summit County Recording agent the document: AFFIDAVIT: JURAT: CURATIVE REGISTRATION THE THE LIVE LIFE: Darrell- James: Hill: Grantee: CESTUI QUE VIE- ESTATE TRUST NAMED: DARRELL JAMES HILL, USPS RMN RE 322 399 163 US (see pp. 18-21: Gila County, Ariz.: Recorder Doc # 2018-005176, pp. 1, 10-21: annexed; 13 pages);
- b) After a) above-described from the Summit County recordation agent i: man did receive back the document sent unrecorded and for the No reason is indicated;
- c) After good faith researching, on the April 25th, 2018, i: man sent to the Summit County Recording agent the chosen document with a verified and affirmed cover letter in the good faith: USPS RMN RE 322 399 194 US (see p. 14-16: Gila County, Ariz.: Recorder Doc # 2018-005176: annexed); indicating: c.1) the Ohio legislative statutory guidelines that the Summit County Recording ministerial agents must obey; emphasizing: c.2) the schedule fee for violation of the protected and inalienable right-of-recordation, and Notice to the Sheriff, c.3): c.3) received by the man Steve: Summit County Sheriff Barry, notification of the fact that this criminal offense is taking place under an acquiescence of the liability for the fee schedule owed and due upon request under the obligation of the tacit procuracy by the two people involved at the Summit County Recordation agency, et al., for the violation of the man's inalienable rights: fee accumulative until the violation is ended (see pp. 14-15, 17: Gila County, Ariz.: Recorder Doc # 2018-005176: annexed).
- d) After c.1 and 2) above-described, from the Summit County recordation agent, i: man did receive back the second document again unrecorded and again for the No reason is indicated; and,
- e) After c.3) above-described, i:man received no response from the man Steve: Summit County Sheriff Barry.

Accordingly, as indicated in the affidavit of the c.3 – as above-described – to the man Steve: Summit County Sheriff Barry, this document: **AFFIDAVIT: CLAIM OF CRIMINAL WRONG-DOING...**, would issue if upon the c.1 and 2) -as above-described – is ongoing now non-resolved for the criminal violations of the deprivation of the protected and inalienable right of the man :Darrell- James: Hill, as above described.

Autographed: 5th day: July month: 2018

Without prejudice

Darrell James Hill
Darrell- James: Hill: Ohioan man

Sworn to and subscribed before me now on this 5th day: July month: 2018.
Produced identification: type: Arizona Driver License.

[Signature]
Notary

Seal

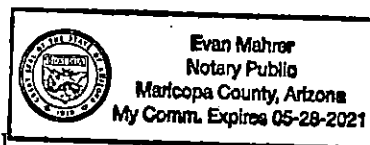

:AFFIDAVIT: CLAIM OF CRIMINAL WRONG-DOING

2022-011769 MISC Page: 696 of 2782
09/26/2022 03:35:37 PM Receipt #: 22-9381
Rec Fee: \$30.00 Darrell James Hill
Gila County, Az, Sadia Jo Bingham, Recorder





:Darrell-James: Hill, and
Beverly-Jean: Romero-Hill
PO Box 3806
Apache Junction, Arizona 85120

AFFIDAVIT: STATEMENT OF CLAIM

Re: Gila County: #2017-002378

I. For the lawful need: we :Darrell-James: Hill and Beverly-Jean: Romero-Hill on the April 12th, 2018 did assure delivery of the items by USPS Registered Mailing delivery w/ return receipt:

a: RMN RE 322 399 177 US Affidavit: Jurat: Curative Registration of the Live Life: Beverly-Jean: Romero-Hill :grantee: CESTUI QUE VIE – ESTATE TRUST NAMED: BEVERLY-JEAN: ROMERO-HILL to the Rio Arriba county, New Mexico state Recorder (attached), and:

b: RMN RE 322 399 163 US: Affidavit: Jurat: Curative Registration of the Live Life: Darrell-James: Hill :grantee: CESTUI QUE VIE – ESTATE TRUST NAMED: DARRELL-JAMES: HILL to the Summit county, Ohio, state Recorder (attached)

for recordation of the documents.

For the reasons now-time unknown, the Item b: RMN RE 322 399 163 US was not filed in the Summit county, Ohio state designated recorder, and was returned with the Item c:

c: From: Office of the KRISTEN M SCALISE CPA, CFE, SUMMIT COUNTY FISCAL OFFICER by the "Katie Mancino, Executive Assistant 1".

II. For the lawful need: we :Darrell-James: Hill and Beverly-Jean: Romero-Hill on the April 25th, 2018 sent items b: and c: with the COVER LETTER/Item d: (attached) by the USPS Registered Mailing RMN 322 399 194 US delivery w/ return receipt to take Summit county Kristen: Fiscal Officer.

d: In re: A) USPS RMN RE 322 399 163 US document "AFFIDAVIT...."

And, for the lawful need: we :Darrell-James: Hill and Beverly-Jean: Romero-Hill on the April 25th, 2018 sent to: Steve: Sheriff Barry, Summit County: COVER LETTER item d with the reference to the criminal trespass and the itemized acquiesced fee schedule: pgs. 1- 2/ 6 item b by the USPS Registered Mailing w/ return receipt: RMN RE 322 399 203 US. For the MAILING AND DELIVERY INFORMATION: Kristin: Recorder and Steve: Sheriff, Summit County, Ohio see: Item e:

e: MAILING AND DELIVERY INFORMATION: Kristin: Recorder and Steve: Sheriff, Summit County, Ohio.

JURAT

Darrell-James Hill
Darrell-James: Hill- man-beneficiary

Beverly-Jean Romero-Hill
Beverly-Jean: Romero-Hill- man-beneficiary

Affirmed and autographed before me this 1st day: May 2018

Arianna Ramirez
Notary

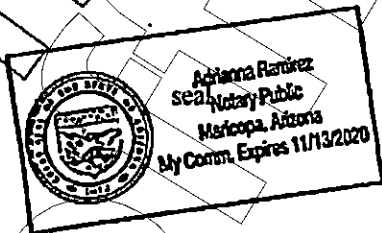

AFFIDAVIT:

ENCLOSURES MAILING STATEMENT

For the verification of the USPS Registered mailing of the document for the registration:
1: **"AFFIDAVIT: JURAT: CURATIVE REGISTRATION OF THE LIVE LIFE: Darrell-James: Hill :Grantee: CESTUI QUE VIE -ESTATE TRUST NAMED: DARRELL JAMES HILL"** with the 2: \$ _____ money order # _____
by the USPS RMN 322 399 163 US is for the intent of the recording of the document at the Recorder addressee: Summit County Fiscal Office Recording Division, 175 South Main Street, 4th Floor, Akron, OH 44308 done this 10th April: 2018.

mailee: Beverly Jean Pomeroy-Hill

mailee: Mark-Hewitt-Lutz

JURAT

Sworn and signed on this 10th day: April: 2018: _____ :time in my presence and before me.

Notary

seal

Unofficial Copy

700



CUSTOMER'S RECEIPT

SEE BACK OF THIS RECEIPT FOR IMPORTANT CLAIM INFORMATION

NOT NEGOTIABLE

Pay to Summit County Fiscal Office
Address 175 S. Main St, 4th Floor
Akron, OH 44308

KEEP THIS RECEIPT FOR YOUR RECORDS

Serial Number
24890959113

Year, Month, Day **2018-04-11** Post Office **852200** Amount **\$52.00** Clerk **19**



POSTAL MONEY ORDER

Serial Number
24890959113

\$52.00

Pay to Summit County Fiscal Office
Address 175 S. Main St, 4th Floor
Akron, Ohio

Clerk **19**

Value 5 pages: Corative

00000800 21

Unofficial Copy

701





DAISY MOUNTAIN
 44047 N 43RD AVE
 PHOENIX
 AZ
 85087-9998
 0363920092
 (800)275-8777 11:02 AM
 04/12/2018

Product Description	Sale Qty	Final Price
First-Class Mail Large Envelope (Domestic) (AKRON, OH 44308) (Height: 0 Lb 1.80 Oz) (Estimated Delivery Date) (Monday 04/16/2018)	1	\$1.21
Registered (Amount: \$0.00) (®USPS Registered Mail #) (RE322399163US)	1	\$11.90
Return Receipt (®USPS Return Receipt #) (9590940306765196708825)	1	\$2.75
Total		\$15.86
Cash Change		\$20.00 (\$4.14)

Registered No. **RE322399163US**

Date Stamp: 0093 09 09
 APR 12 2018
 PHOENIX, AZ
 DAISY MOUNTAIN

Postage \$ \$1.21	Extra Services & Fees \$11.90	Signature Confirmation
Extra Services & Fees	Registered Mail	Signature Confirmation Restricted Delivery
Return Receipt (Paper) \$ \$2.75	Return Receipt (Electronic) \$ \$0.00	Restricted Delivery
Restricted Delivery \$ \$0.00	Total Postage & Fees \$15.86	Received by 04/12/2018
Customer Must Declare Full Value \$ \$0.00	Domestic parcels up to \$50,000 included based upon the declared value. International parcels by limited. (See Reverse).	

OFFICIAL USE

PHOENIX AZ 85007

DARRELL JAMES HILL, GRANTOR
 c/o Darrell James Hill, Administrator
 GENERAL POST OFFICE BOX 3166
 APACHE JUNCTION, ARIZONA 85110

Summit County Fiscal Office
 Recording Division
 175 South Main Street, 4th Floor
 Akron, OH 44308

PS Form 3809, Registered Mail Receipt
 April 2015, PSN 7530-02-000-9051
 For domestic delivery information, visit our website at www.usps.com

Copy 1 - Customer (See information on Reverse)

Text your tracking number to 28777 (2USPS) to get the latest status. Standard Message and Data rates may apply. You may also visit USPS.com USPS Tracking or call 1-800-222-1811

In a hurry? Self-service kiosks offer quick and easy check Associate can show

Save this receipt for insurance. For info on an insurance claim, https://www.usps.com

SENDER: COMPLETE THIS SECTION

- Complete items 1, 2, and 3.
- Print your name and address on the reverse so that we can return the card to you.
- Attach this card to the back of the mailpiece, or on the front if space permits.

Article Addressed to:
 Summit County Fiscal Office
 Recording Division
 175 South Main Street, 4th Floor
 Akron, OH 44308



RE 322 399 163 US

PS Form 3811, April 2015 PSN 7530-02-000-9053

COMPLETE THIS SECTION ON DELIVERY

A. Signature
 X *Therly J Hill*

B. Received by (Printed Name)
 C. Date of Delivery

Is the delivery address different from item 1? Yes No
 YES, enter delivery address below

3. Service Type
- Adult Signature
 - Adult Signature Restricted Delivery
 - Certified Mail®
 - Certified Mail Restricted Delivery
 - Collect on Delivery
 - Collect on Delivery Restricted Delivery
 - Priority Mail Express®
 - Registered Mail™
 - Registered Mail Restricted Delivery
 - Return Receipt for Merchandise
 - Signature Confirmation™
 - Signature Confirmation Restricted Delivery

Domestic Return Receipt

UNRECORDED

702



KRISTEN M SCALISE CPA, CFE
SUMMIT COUNTY FISCAL OFFICER
175 S. MAIN STREET, AKRON, OHIO 44308-1354

The document(s) we received for Recording is/are being returned to your office for the reasons indicated below. If you have any questions you may wish to consult legal counsel before proceeding with the final recording process, as **THIS OFFICE CANNOT GIVE LEGAL ADVICE.**

- Proper recording fee \$ _____ (FEE PER DOCUMENT \$28.00 first two pgs., \$8.00 ea. additional page, \$4.00 for each cross reference, \$20.00 if not compliant to ORC 317.114)
- This document is not compliant with ORC 317.114 because of _____ margins, _____ font size, _____ ink color/highlighting
- Unable to refund cash
- Check(s) should be made payable to **SUMMIT COUNTY FISCAL OFFICE**
- Check not _____ signed / _____ enclosed, _____ within 90 days
- Not recordable in this _____ County _____ Office _____ State
- Document not _____ signed / _____ notarized (ORC5301.01)
- Notary didn't acknowledge the document properly (see attached list)
- Official capacity (Title) of corporate signatory is absent
- Institution/Corporate name **MUST** be typed above signing officer's signature or in notary clause
- Contents of document not sufficiently legible (O.R.C.317.112)
- Signatures must be original and legible (O.R.C.317.112) type or print names below signature (Effective February 1, 2001 witnesses are no longer needed, however, if they appear on a document they also **MUST** be legible)
- "This instrument was prepared by (name)" must appear on the document (O.R.C.317.111)
- Grantor/Grantee name(s) is missing
- Power of Attorney must be recorded prior to recording documents that are signed by the POA (O.R.C.1337.04), and the reference is required to be listed on the document.
- When re-recording a document **ALL PAGES** must be included.
- Volume and page/reception number for cross-reference is _____ absent _____ incorrect (documents filed prior to 3/24/97 will have a volume and page, documents filed after 3/24/97 will have an 8 digit reception number)
- Cancellation clause is _____ not signed _____ incorrect
- No assignment of mortgage shall be accepted unless it contains the mailing address of the assignee (O.R.C.5301.32)
- NO Blanket Releases/Assignments (O.R.C.317.37)**
- Mentioned exhibits are not attached to document
- Legal description appears to be _____ absent _____ incorrect _____ illegible _____ not a complete legal description
- Poor reproduction quality (O.R.C. 317.112) due to _____ paper color _____ print size _____ color of ink _____ highlighting _____ exhibits
- Include a self-addressed stamped envelope
- A return address must be included on all documents. **IT MUST MATCH THE RETURN ENVELOPE EXACTLY!**
- Other _____

KRISTEN M. SCALISE CPA, CFE
FISCAL OFFICER, COUNTY OF SUMMIT

KATIE MANCINO
Executive Assistant
Summit County Fiscal Office
Ohio Building
175 S. Main Street
Akron, OH 44308

Phone: 330.643.2530
Fax: 330.643.8154
E-mail: kmanicino@summitoh.net
<http://FiscalOffice.summitoh.net>



4 WHEN RETURNING CORRECTED DOCUMENTS

_____, Del 2018-005176 MISC Page: 13 of 21
09/14/2018 02:29:34 PM Receipt #: 18-3665
M-4:00PM Rec Fee: \$28.00 Darrell James Hill
Gila County, Az, Sadie Jo Bingham, Recorder



2022-011769 MISC Page: 701 of 2782
09/26/2022 03:35:37 PM Receipt #: 22-9981
Rec Fee: \$30.00 Darrell James Hill
Gila County, Az, Sadie Jo Bingham, Recorder



703

:Darrell-James: Hill :man, administrator: c/o PO Box 3806, Apacl

:Kristen M :Fisc. Officer Scalise CPA, CFE, public servant
c/o :Katie :Exec. Asst.~ I Mancino, public servant
Summit County Fiscal Office
Ohio Building
178 S. Main Street
Akron, Ohio 44308-1354
Telephone: 330-643-2530
Fax: 330-643-8154

:Steve :Sheriff Barry, Summit county
53 University Ave.
Akron, Ohio 44308
Telephone: 330-643-2154
Fax: 330-434-2701

USPS RMN RE 322 399 217 US

USPS RMN RE 322 399 194 US

In re: A) USPS RMN RE 322 399 163 US document **"AFFIDAVIT JURAT CURATIVE REGISTRATION OF THE LIVE LIFE: Darrell-James: Hill: Grantee: CESTUI QUE VIE -ESTATE TRUST NAMED: DARRELL JAMES HILL"**, with the attached US POSTAL MONEY ORDER #24890959113 ~Delivered: April 18th, 2018; and, B) Your accompanying form: **"KRISTEN M SCALISE- Rev 7/19/17- THIS OFFICE CANNOT GIVE LEGAL ADVICE ... form**, with the Katie Mancino, Exec. Assistant I, business card stapled thereon -- A) AND B) stapled together as received; ATTACHED.

Dear Kristen, Katie, Steve; Greetings,

Kristen :i :Darrell-James: Hill am: Ohioan born on the land in the Summit county Ohio state territory as the Certificate Of Birth established this fact of my nationality and standing: common law owner, one of the people.

:You are man acting in the role of PUBLIC SERVANTS. And, failure of your public duty with the without-remedy-denial of this man's document for the recordation is denied. And, as provided, your without-remedy-attached-denial-form instructs to this man to seek legal advice for to decipher your hypothetically legitimate denial of a common law public service duty and obligation to the Ohio state national :Darrell-James: Hill. Your without-cause-denial process employed by your creating the impasse is effectively coercive and thereby tantamount to the giving legal advice to this Ohio state national. :i do not consent to your legal advice. Furthermore, the document for the recordation is Not a statutory request. To wit:

This man's document for the recordation is a common law exercise of the right and responsibility of the man-beneficiary and administrator :Darrell-James: Hill. And, I: administrator require you :public trustee to file the referenced document now. Moreover:

Important to note; under the paragraph number four, et seq: **"INTENT OF THE CLAIM: CURATIVE REGISTRATION AND RECORDATION OF THE FOUND LIVE LIFE: Darrell-James: Hill"**, continuing on page 2/4, b.1) **"READ CAREFULLY"**; the fee schedule for the trespass in your denial-to-record this common law document in the Summit county Ohio state is specified. For the any further trespass of your public trustee oath, duty or obligation to this Ohioan is thereupon-heretofore-willful; and: fee is thereupon due-now-upon-request beginning from the day of your receipt of the document: April 18th, 2018; 11:42:am., and ending upon the resolve of this matter despite any legal proceedings, and without statute of limitation.

:Steve :Notice of a common law crime is hereby now upon this receipt before you and a known crime has and, influenced upon the response to this man's document, has/is occurring in your county against the Ohio state national :Darrell-James: Hill. Upon this, as stated above, for the any further damage, an Affidavit of Claim of Criminal Activity will be issued to your office for the reimbursement of these additional costs and for the payment of the fee schedule due-payable-now upon the request by :Darrell-James: Hill for the deprivation-of-right injury(s).

:i affirm the all herein is true and correct and will testify to the same in the court.

:Day :April 25, 2018

Darrell James Hill
:Darrell-James: Hill :man, administrator

JURAT

Arizona State
County Pinal

Today presented a living man proven to me to be Darrell-James: Hill who affirmed and autographed this testimony before me this 25th day of the month April in the year Two thousand eighteen, a.d.

Alicia Ramirez
PUBLIC NOTARY

MY COMMISSION EXPIRES ON: 11/13/2020

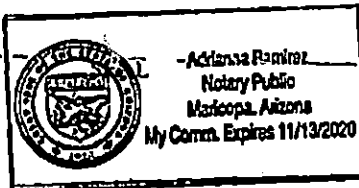

- 1 See: Ohio Stream Management Guide: Guide No. 02. (Last viewed: 04/24/2018: <http://groundwater/portals/soilwater/pdf/stream/stfs02.pdf>) in the nature of: ORC Title 53, Chapter 5301.252 .
- 2 See: 18 U.S. Code § 2071 – Concealment, removal, or mutilation generally
- 3 See: International Covenant On Civil and Political Rights: 102d Congress, 2d Session; Exec. Rep 102-23. (Last viewed: 04/24/2018: <http://stateswoman/documents/organization/235639.pdf>); p. 9, No. 5. *Federalism*.

Report of Criminal Activity to :Steve: Summit County Sheriff Barry: USPS RMN RE 322 399 203 US
2nd mailing of 1st document: Kristin c/o Katie: USPS RMN 322 399 194 US :April 25, 2018 1/1

05/14/2018 02:29:31 PM Receipt #: 18-3668

Rec Fee: \$26.00 Darrell James Hill

Gila County, Az, Sadie Jo Bingham, Recorder

APACHE JUNCTION
151 W SUPERSTITION BLVD
APACHE JUNCTION
AZ
85120-9998
030259D130
04/25/2018 (800)275-8777 1:55 PM

Product Description Sale Qty Final Price

First-Class Mail 1 \$1.42
Large Envelope (Domestic) (AKRON, OH 44308) (Weight: 0 Lb 2.10 Oz) (Estimated Delivery Date) (Saturday 04/28/2018)

Registered 1 \$12.60
(Amount: \$21.00)
(USPS Registered Mail #) (RE322399194US)

Return Receipt 1 \$2.75
(USPS Return Receipt #) (9590940305765196708840)

First-Class Mail 1 \$1.21
Large Envelope (Domestic) (AKRON, OH 44308) (Weight: 0 Lb 1.30 Oz) (Estimated Delivery Date) (Saturday 04/28/2018)

Registered 1 \$12.60
(Amount: \$21.00)
(USPS Registered Mail #) (RE322399203US)

Return Receipt 1 \$2.75
(USPS Return Receipt #) (9590940305765196708857)

Total \$33.33

Cash Change \$40.00 (\$6.67)

Text your tracking number to 28777 (2USPS) to get the latest status. Standard Message and Data rates may apply.

Registered No. RE322399194US Date Stamp
Postage \$1.42 Extra Services & Fees
Extra Services & Fees \$12.60
Registered Mail \$12.60
Return Receipt (hardcopy) \$2.75
Return Receipt (electronic) \$0.00
Restricted Delivery \$0.00
Customer Must Declare Full Value \$21.00
Received by 04/25/2018
APACHE JUNCTION, AZ
APR 25 2018

OFFICIAL USE
APACHE JUNCTION, AZ 85120
Darrell James Hill, Administrator
c/o PO Box 3806
Apache Junction, Arizona 85120
Kristen M. Flan, Officer Sealife CPA, CFB
Summit County Fiscal Office
AKRON, OH 44308
178 S. Main Street
Akron, Ohio 44308-1354

PS Form 3806, Registered Mail Receipt
April 2015, PSN 7530-02-000-9051
For Domestic Delivery Information, visit our website at www.usps.com
Copy 1 - Customer (See Information on Reverse)

Registered No. RE322399203US Date Stamp 0130 77
Postage \$1.21 Extra Services & Fees
Extra Services & Fees \$12.60
Registered Mail \$12.60
Return Receipt (hardcopy) \$2.75
Return Receipt (electronic) \$0.00
Restricted Delivery \$0.00
Customer Must Declare Full Value \$21.00
Received by 04/25/2018
APACHE JUNCTION, AZ
APR 25 2018

OFFICIAL USE
APACHE JUNCTION, AZ 85120
Darrell James Hill, Administrator
c/o PO Box 3806
Apache Junction, Arizona 85120
Steve Sheriff Barry
Summit County, Ohio govt.
AKRON, OH 44308
Akron, Ohio 44308

PS Form 3806, Registered Mail Receipt
April 2015, PSN 7530-02-000-9051
Copy 1 - Customer (See Information on Reverse)

SENDER: COMPLETE THIS SECTION

- Complete items 1, 2, and 3.
- Print your name and address on the reverse so that we can return the card to you.
- Attach this card to the back of the mailpiece, or on the front if space permits.

1. Article Addressed to:
Kristen M. Fisc. Officer Scalise CPA, CFE
Summit County Fiscal Office
Ohio Building
178 S. Main Street
Akron, Ohio 44308-1354

A. Signature
X

Agent
 Addressee

B. Received by (Printed Name)

C. Date of Delivery

D. Is delivery address different from item 1? Yes
If YES, enter delivery address below: No



2. Article Number (Transfer from service label)
RE 322 399 194 US

3. Service Type

<input type="checkbox"/> Adult Signature	<input type="checkbox"/> Priority Mail Express
<input type="checkbox"/> Adult Signature Restricted Delivery	<input type="checkbox"/> Registered Mail™
<input type="checkbox"/> Certified Mail	<input type="checkbox"/> Registered Mail Restricted Delivery
<input type="checkbox"/> Certified Mail Restricted Delivery	<input type="checkbox"/> Return Receipt for Merchandise
<input type="checkbox"/> Collect on Delivery	<input type="checkbox"/> Signature Confirmation™
<input type="checkbox"/> Collect on Delivery Restricted Delivery	<input type="checkbox"/> Signature Confirmation Restricted Delivery
<input type="checkbox"/> Insured Mail™ (over \$500)	<input type="checkbox"/> Restricted Delivery

PS Form 3811, April 2015 PSN 7530-02-000-9083

Domestic Return Receipt

Unofficial Copy

05/14/2018 02:29:31 PM Receipt #: 18-3665
Rec Fee: \$26.00 Darrell James Hill
Gila County, Az, Sadie Jo Bingham, Recorder

SENDER: COMPLETE THIS SECTION

- Complete items 1, 2, and 3.
- Print your name and address on the reverse so that we can return the card to you.
- Attach this card to the back of the mailpiece, or on the front if space permits.

1. Article Addressed to:

Steve :Sheriff Barry
53 University Ave.
Akron, Ohio 44308



9590 9403 0676 5198 7088 57

2. Article Number (transfer from service label)

11 RA1322 1399 120311VS

PS Form 3811, April 2016 PSN 7530-02-000-8053

COMPLETE THIS SECTION

A. Signer

Bobey Medwell

Agent

Addressee

B. Received by (Printed Name)

Bobey Medwell

C. Date of Delivery

D. Is delivery address different from item 1? Yes
If YES, enter delivery address below: No

3. Service Type

- Adult Signature
- Adult Signature Restricted Delivery
- Certified Mail
- Certified Mail Restricted Delivery
- Collect on Delivery
- Collect on Delivery Restricted Delivery
- Registered Mail
- Registered Mail Restricted Delivery
- Return Receipt for Merchandise
- Signature Confirmation™
- Signature Confirmation Restricted Delivery
- Priority Mail Express®
- Registered Mail™
- Registered Mail Restricted Delivery
- Return Receipt for Merchandise
- Signature Confirmation™
- Signature Confirmation Restricted Delivery

Domestic Return Receipt

09/26/2022 03:35:37 PM Receipt #: 22-9381
Rec Fee: \$30.00 Darrell James Hill
Gila County, Az, Sadie Jo Bingham, Recorder



Unofficial Copy

PROV



AFFIDAVIT JURAT:
CURATIVE REGISTRATION¹ OF THE LIVE LIFE²; Darrell-James: Hill³;
:Grantee: CESTUI QUE VIE -ESTATE TRUST NAMED: DARRELL JAMES HILL⁴

L.S.

Returnee:
DARRELL JAMES HILL, GRANTOR
c/o Darrell-James: Hill: Administrator
GENERAL POST OFFICE BOX 3806
APACHE JUNCTION, ARIZONA 85120

FOR THE PROVIDING OF THE FILING OF THE NAME[S] WHEN BUSINESS IS CONDUCTED UNDER ASSUMED NAME: "SESSIONS LAW 145:1907; CHAPTER 145 [H.B.64] OF THE STATE OF WASHINGTON; AN ACT PROVIDING THAT WHEN ANY BUSINESS OTHER THEN A CORPORATION(S) OR LIMITED PARTNERSHIP, IS CONDUCTED UNDER AN ASSUMED NAME, A CERTIFICATE SHOWING THE REAL PARTIES IN INTEREST SHALL BE FILED WITH THE COUNTY CLERK AND FIXING A PENALTY x 2. TOGU BE DEEMED A PUBLIC OFFICER YOU MUST PRODUCE AND BE VETTED BY THE ADMINISTRATOR OF THIS DOCUMENT, A LETTER OF INTENT, A LETTER OF COMPLIANCE WITH ALL STATE AND FEDERAL RULES AND REGULATIONS AS PRESCRIBED BY THE SECRETARY OF STATE OR ANY PRIVATE PERSON WHO DOES NOT PROPERLY IDENTIFY THEMSELVES UPON REQUEST BY PRODUCING A BUSINESS LICENSE, A UBI NUMBER, AND A BOND FILLED OUT IN THE C.A.P. NAME ON THIS CERTIFICATE. ARE FINED ON THE SPOT FOR 500.00 IN CONSIDERATION. FEE SCHEDULE; TO BE DETERMINED BY THE HEAD ADMINISTRATOR OF THIS DOCUMENT AT THE TIME OF ENGAGEMENT. And Also The Corresponding Session Laws Of The State Of Ohio including, but not limited to: 129th General Assembly file No. 9, HB 9, §1: A) Chapter 1307, as relates to treaty; B) Chapter 1301 as relates to: i) transactions entered into before 7-1-62, ii) reservation of rights, and obtainment of remedy in 'Common Law'; and, C) Chapter 1303 as relates to: i) negotiable instruments, ii) holder in due course. And, 130th General Assembly File No. 41, HB 72, §1: D) chapter 5301 as relates to memorandum of trust. And, 2008 HB 332: Chapter 1701 as relates to transfer of reserved name.

For where the GRANTOR: DARRELL JAMES HILL is a Cestui Que Vie Trust formed without the knowledge or consent of the Grantee: Darrell-James: Hill, and has accumulated unauthorized debt against the ESTATE Trust to the benefit of non-owners as secondary non-holder beneficiaries merely presumed to exist and claiming to have an interest in the Estate with a presumption established upon the MUNICIPAL LAW OF THE DISTRICT OF COLUMBIA and the DISTRICT OF COLUMBIA MUNICIPAL CORPORATION. Therefore:

CLAIM OF THE ARTICLE IV⁴, CESTUI QUE VIE ACT OF 1666: Darrell-James: Hill

i: man: actual Grantee of the Estate Trust DARRELL JAMES HILL, the living man known to the public as: Darrell-James: Hill, by the inherent power to manage all affairs, claim now the provision of Article IV of the Cestui Que Vie Act of 1666 as a man "having been found live" and owed all of the benefit, control, and interest in the Grantor Trust Estate set free and clear of all liens, debts, titles held under color of law, titles, fees, and all other encumbrances established by the United States of America, Inc., THE UNITED STATES OF AMERICA, INC., the UNITED STATES, (INC.) and all and any franchises thereof ab initio from the date of first registration of the Estate Trust: "DARRELL JAMES HILL," as relates herein to: Darrell-James: Hill, and all and any derivatives thereof/therefrom, including but not limited to DARRELL JAMES HILL. Furthermore:

INTENT OF THE CLAIM: CURATIVE REGISTRATION AND RECORDATION OF THE FOUND LIVE LIFE: Darrell-James: Hill

a) Re-vestment to the actual OWNER-Holder In Due Course of the Estate Name and in the Estate Property and in the All Interest Due:

a.i) Public And Private Recognition: Grantee as the In Lawful Title Holder In The Due Course of The Foreign Grantor Trust Estate Named: DARRELL JAMES HILL, et seq., as of 20 November 1958.

a.ii) For The Public And Private Acknowledgment and Settlement: thus:

1. Usufruct of The Cestui Que Vie Trust Entity named herein as described is Now-to-fore Denied; all usufruct activity must cease forthwith now;
2. Re-vestment to the Grantee Holder in due Course: Darrell-James: Hill of the all of the accounts with the accounting to the penny is required to be provide forthwith now;

1 Registration means: USPS RMN 322 399 163 US w/ return receipt

2 Live-Life means: now-time live status of the man in this life

3 Real Party in Interest: 1man :darrell james of the family hill, also synonymously expressed as :Darrell-James: Hill Given name and Surname of the Ohioan man-male child born in the city of the Akron with the birth-day: twentieth-day: November-month: one thousand nine hundred fifty-eight -year a.d. as the progeny of the ancestry people-parties: birth-mother man-female, Ora-Lee: (Archer) Hill and birth-father man-male, Clarence: Hill by their marriage under Almighty God.

4 See COPY CERTIFICATION: a) Certificate of Birth and b) Arizona Driver License: Darrell-James: Hill, p. 3/4

5 Cestui Que Vie means: Cestui Que Vie Trust as relates to The Cestui Que Vie Act 1666, the/an Estate Trust named: DARRELL JAMES HILL established upon/at the birth of the Live-life man-beneficiary: Darrell-James: Hill.

6 Article IV - "If the supposed dead Man prove to be alive, then the Title is re-vested. Action for mean Profits with Interest."



3. All of the records of all of the accounts of the non-usufruct and usufruct status/ condition are required re-vested forthwith now in a written report per each account in descending chronology; and,
4. All related records in fact must be provided upon this registration/ recordation; trespass/ theft/ obfuscation by the commission/omission is wrongdoing in perpetuity.

b) Trespass Upon The Estate Trust Re-Vestment

b.i) *READ CAREFULLY* :Fee Schedule for the trespass upon/ against this Cestui Que Vie Trust of 1666- Article IV re-vest of the Estate Trust property to the Holder in Due Course Darrell-James: Hill Is with the cost of one pre-1933 one-ounce- 99% or higher-gold United States Coin per minute cumulative from this registration until upon the full remedy is resolved; and: all of the any amount due shall be forthwith now-payable subject to the tacit procuration in any court upon the grantee's request.

b.ii) All violators, agents, actors, etc. and/or proxies under the color of law and arising and/or sustaining action under the color of law authority presumably claimed and/or authorized by any corporation, association, of subcontractor, agency or agent of any kind or the like in the violating and/or attempting to violate the political status and/or the In Title Order(s) of the Grantee at any time now of the past, or of the present, or of the future must be liable severally, and jointly, by the tacit procuration to this certificate as an affidavit of the obligation in the normal commercial sense. Such is the severity representing accounts receivable; there is a lien upon the real and movable property, malpractice insurance and performance bonds of any such violators in perpetuity and Not dischargeable in the bankruptcy court nor subject to any probate claim. For all of the time(s) the owner-holder in due course-property is exempt from third party levy, and all related vessels in his commerce are tax pre-paid.

c) Grantee Administration: Commercial Account(s)

c.i) The assumed/ registered names are as designed to conduct business in the commerce and furthermore are to accompany any continued or new business account administration heretofore executed by this Owner-Holder in Due Course: Darrell-James: Hill Grantee.

1. Under the any form or the creation of a qualification or an attachment of any condition, the United States and the United States of America, however styled or construed, their agents, et al, can Not, in effect, inflict a punishment for a past act which was not punishable at the time in was committed and which was not the knowing, willing, and consensual act of the actual Holder in Due Course of the given name and estate'.

:BUSINESS INFORMATION

LEGAL ENTITY: HEIR GRANTEE, PRIVATE, PUBLIC, SIGNATURE TRUST

BUSINESS DESCRIPTION: COMMERCE, GRANTOR, PRIVATE, PUBLIC, SIGNATORY

BUSINESS NAME: dba DARRELL JAMES HILL and HILL, DARRELL JAMES and DARRELL J. HILL and all and any derivatives thereof in any way related to the ESTATE so NAMED.

POST OFFICE ADDRESS: c/o GENERAL POST OFFICE BOX 3806, APACHE JUNCTION, ARIZONA 85120

:OWNER INFORMATION

True and Real

Trade Name Title: Grantee, Private Creditor, Signatory, Beneficiary, Holder, Transferee:

Appellation: STYLE: Given Name and Surname

Given Name: Darrell-James

Surname: Hill

Post Office Address

(Physical): c/o General Post Office Box 3806, Apache Junction, Arizona, zip code exempt;

Post Master Location: 151 Superstition Boulevard, Apache Junction, AZ, Postal Code 85120.

:HABEAS CORPUS

I:man :Darrell-James: Hill claim on the perpetual writ of the Habeas Corpus to institute and maintain actions of any kind in the court/COURT of "this" state while maintaining true domicile on the land of these: worlds, including, but not limited to the united States of America, Earth, to take, hold and dispose of the property either Real, Intangible or Personal held in the name of the FOREIGN GRANTOR TRUST dba DARRELL JAMES HILL together with all derivative NAMES and Names and styles thereof, together with guarantee of prepayment and exemption from Taxes, Tithes, and Fees, together with re-conveying all actual assets thereto to this Lawful Holder-in-Due-Course, and real-party-in-interest: Darrell-James: Hill.

-1 of 5 FOR THIS CLAIMANT'S-KNOWLEDGE OF THESE FACTS IS WITH THE CLAIM OF THIS LIVE-LIFE-BIRTH/NATIVITY: Darrell-James: Hill ON THIS BIRTH-TIME OF THE DAY ~ TWENTIETH IN THE ~MONTH-~NOVEMBER IN THE ~YEAR~ ONE THOUSAND NINE HUNDRED FIFTY-EIGHT A.D. WITH THE TIME: 11:35:A.M.

-2 OF 5 FOR THESE WITNESS-KNOWLEDGE OF THIS LIVE-LIFE ARE WITH THESE CLAIMS OF THIS LIVE-LIFE-BIRTH/NATIVITY IN THE CITY OF THE AKRON IN THE OHIO STATE WITH THE PROGENY OF THE ANCESTRY PEOPLE-PARTIES: MAN-FEMALE BIRTH-MOTHER, Ora-Lee: (Archer) Hill AND MAN-MALE BIRTH-FATHER, Clarence: Hill BY THEIR MARRIAGE UNDER The Almighty God.

-3 OF 5 FOR THE WITNESS-KNOWLEDGE OF THIS LIVE-LIFE-CLAIM ARE WITH THE CLAIM OF THIS LIVE-LIFE-BIRTH WITH AN AUTHORIZATION OF THESE WITNESS-AUTOGRAPHS:

-4 OF 5 FOR THE WITNESS-KNOWLEDGE OF THESE FACTS ARE WITH THIS LIVE-LIFE-BIRTH-CLAIM WITH THIS CORRECT-SENTENCE-STRUCTURE-COMMUNICATION-PARSE-SYNTAX-GRAMMAR "CSSCPSG"-PERFORMANCE OF THIS BABEL-CSSCPSG- COMMUNICATIONS-CLAIM WITH THIS LIVE-LIFE-PARTY: Darrell-James: Hill.

-5 OF 5 FOR THE WITNESS-KNOWLEDGE OF THESE FACTS ARE WITH THIS LIVE-LIFE-BIRTH-CLAIM WITH THIS CORRECT-SENTENCE-STRUCTURE-COMMUNICATION-PARSE-SYNTAX-GRAMMAR "CSSCPSG"-PERFORMANCE OF THIS BABEL-CSSCPSG- COMMUNICATIONS-CLAIM WITH THIS LIVE-LIFE-PARTY: Darrell-James: Hill.

7 "Without Prejudice" I reserve my common law right Not to be compelled to perform under any contract, commercial agreement, or bankruptcy that I did not enter into knowingly, voluntarily and intentionally. Furthermore, I do Not accept the liability associated with the any compelled benefit of any unrevealed contract or commercial agreement or bankruptcy.

209

COPY CERTIFICATION: a) Certificate Of Birth and b) Arizona Driver License

VERIFY PRESENCE OF ODH WATERMARK. HOLD TO LIGHT TO VIEW.

STATE OF OHIO
OFFICE OF VITAL STATISTICS

CERTIFICATION OF BIRTH

STATE FILE NUMBER: 1958208851 DATE RECORD FILED: 1/29/1958

NAME: DARRELL JAMES HILL

DATE OF BIRTH: 1/20/1958 SEX: MALE

BIRTHPLACE: OHIO FATHER'S NAME: CLARENCE HILL

MOTHER'S NAME: ORA LEE HILL

LAST NAME PRIOR TO FIRST MARRIAGE: ARCHER

MOTHER'S BIRTHPLACE: ARKANSAS FATHER'S BIRTHPLACE: ALABAMA

Note: This is a true certification of the name and birth facts as recorded in the Office of Vital Statistics, Columbus, Ohio. Witness my signature and seal of the Department of Health this 01 day of August, 2017.

Judith B. May
 State Registrar of Vital Statistics

SUMMIT COUNTY GENERAL HEALTH DISTRICT

REV. 7/2015

VOID WITHOUT WATERMARK OR IF ALTERED OR ERASED
 VERIFY PRESENCE OF ODH WATERMARK. HOLD TO LIGHT TO VIEW.



2022-011769 MISC Page: 708 of 2762
 09/26/2022 03:35:37 PM Receipt #: 22-9381
 Rec Fee: \$30.00 Darrell James Hill
 Gila County, Az, Sadie Jo Bingham, Recorder

COPY CERTIFICATION

State of Arizona
 County of Yavapai

Jetta Buckman, a notary public, do certify that on the 01st day of April, 2018, I personally made the above face copies of the/a Certificate Of Birth and Arizona Driver License from the originals, and they are true, exact, complete and unaltered copies.

Jetta
 PUBLIC NOTARY





:ACKNOWLEDGMENT OF THE SOLE ADMINISTRATOR FROM THE HOME OFFICE, PRIVATE BANKER, DO
Darrell-James: Hill, the true and real trade name by my hand and seal, I:man take office without encumbrance and
without debt or other obligation, fully exempt, indemnified, and with No grant of an other power of attorney dba:
DARRELL JAMES HILL and HILL, DARRELL JAMES and ALL DERIVATIVES ALSO INCLUDING DARRELL J.
HILL at c/o General Post Office Box 3806; Apache Junction, Arizona: Returnee: Darrell-James: Hill.

NOTICE TO AGENTS IS NOTICE TO PRINCIPALS, NOTICE TO PRINCIPALS IS NOTICE TO AGENTS; WITNESS
BY NOTARY DOES NOT ALTER STATUS.

ISSUED THIS 6th DAY: APRIL IN THE YEAR 2018 ON AND FOR THE COUNTY OF YAVAPAI ON THE STATE OF
ARIZONA;

:Live-Life-Party man Finger Print: Left

:Live-Life-Party man Finger Print: Right



Without Prejudice:
DARRELL JAMES HILL: GRANTOR

copyclaim ~ 6th day ~ april ~ 2018, a.d.

Darrell James Hill

Darrell-James: Hill: Administrator

:autograph

JURAT

Arizona State
County Yavapai

Today presented a living man proven to me to be Darrell-James: Hill who affirmed and autographed this "AFFIDAVIT:
JURAT: CURATIVE REGISTRATION OF THE LIVE LIFE: Darrell-James: Hill :Grantee: CESTUI QUE VIE
-ESTATE TRUST NAMED: DARRELL JAMES HILL", inclusive, before me this 6th day of the month April in the
year Two thousand eighteen, a.d.

[Signature]
PUBLIC NOTARY

MY COMMISSION EXPIRES ON: *5/3/21*



6th day ~ april ~ 2018, a.d.

:witness Mark-Hewitt Lutz

:autograph

6th day ~ april ~ 2018, a.d.

:witness Beverly Jean: Roman Hill

:autograph

8 Private Banker: I:man engaged in the business of banking as the holder in possession to enforce an instrument



U.S. Postal Service™
CERTIFIED MAIL® RECEIPT
 Domestic Mail Only

For delivery information, visit our website at www.usps.com®.

AKRON, OH 44308

Certified Mail Fee	\$3.45
Extra Services & Fees (check box, add fee as applicable)	
<input type="checkbox"/> Return Receipt (hardcopy)	\$0.00
<input type="checkbox"/> Return Receipt (electronic)	\$0.00
<input type="checkbox"/> Certified Mail Restricted Delivery	\$0.00
<input type="checkbox"/> Adult Signature Required	\$0.00
<input type="checkbox"/> Adult Signature Restricted Delivery	\$0.00

Postage	\$1.63
Total Postage and Fees	\$7.83

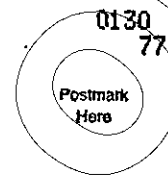

07/05/2018

Sent To: Office of the Sheriff, Summit county
 c/o Steve Barry, Sheriff
 Street and Apt. No., or PO: 53 University Avenue
 Akron, Ohio 44308
 City, State, ZIP+4®: 44308-4320, Fax 330-434-2701

PS Form 3800, April 2015 PSN 7530-02-000-9053 See Reverse for Instructions

APACHE
 151 W SUPE
 APACHE
 851
 030
 2018 (80) 12:07 PM
 Final Price
 \$1.63
 Envelope (domestic)
 KRON, OH 44308
 Weight: 0 Lb
 Estimated Delivery Day: Monday 07/09/18
 Certified Mail Fee: \$3.45
 Postage: \$1.63
 Total: \$5.08
 USPS Return Receipt Fee: \$2.75
 Total: \$7.83
 (\$0.17)

7015 1730 0002 3063 9362

SENDER: COMPLETE THIS SECTION

- Complete items 1, 2, and 3.
- Print your name and address on the reverse so that we can return the card to you.
- Attach this card to the back of the mailpiece, or on the front if space permits.

1. Article Addressed to:

Office of the Sheriff, Summit county
 c/o Steve Barry, Sheriff
 53 University Avenue
 Akron, Ohio 44308



9590 9403 0676 5196 7089 32

2. Article Number (Transfer from service label)

7015 1730 0002 3063 9362

PS Form 3811, April 2015 PSN 7530-02-000-9053

COMPLETE THIS SECTION ON DELIVERY

A. Signature: *Steve Barry* Agent Addressee
 B. Received by (Printed Name): *Steve Barry* C. Date of Delivery:
 D. Is delivery address different from item 1? Yes No
 If YES, enter delivery address below:

3. Service Type
- Adult Signature
 - Adult Signature Restricted Delivery
 - Certified Mail
 - Certified Mail Restricted Delivery
 - Collect on Delivery
 - Collect on Delivery Restricted Delivery
 - Insured Mail
 - Insured Mail Restricted Delivery (over \$500)
 - Priority Mail Express®
 - Registered Mail™
 - Registered Mail Restricted Delivery
 - Return Receipt for Merchandise
 - Signature Confirmation™
 - Signature Confirmation Restricted Delivery

Domestic Return Receipt

2022-011769 MISC Page: 710 of 2782

09/26/2022 03:35:37 PM Receipt #: 22-9381
 Rec Fee: \$30.00 Darrell James Hill
 Gila County, Az, Sadie Jo Bingham, Recorder



7/12

:CERTIFICATE OF PROTEST:

STATE OF ARIZONA

COUNTY OF MARICOPA

For the fact be it known that on the 12th day: July month: 2018 year A.D., at the request of the corporate entity :DARRELL JAMES HILL, by the Authorized Representative :Darrell- James: Hill, man – c/o PO Box 3806, Apache Junction, Arizona 85117 – , I: JOHN KRAISS: notary public in and for the STATE OF ARIZONA, duly appointed, commissioned and sworn, residing in the CITY: GILBERT, in the COUNTY: MARICOPA, and in the STATE aforesaid, presented the annexed instruments – See: Affiant's Statement: "Affidavit: Claim Of The Contacts For The Receipt Of Property-Claimed" by the man: Darrell- James: Hill of the documents made for the obtainment of the private property claimed by the man: Darrell- James: Hill – to which has been the silent - non-response to-date from the man:Public-persons who are in the possession of the lots of the affiant's private property-claimed;

Whereupon, I, the said notary public, at the request aforesaid by these presents do solemnly protest against the man:Public-persons, Jeff: U.S. Attorney General Sessions, and Donald: POTUS Trump, and all of the man:Public-persons to whom it may concern, for the release of the lots of the private property-claimed, and for all the costs, damages, and interest already incurred, and hereafter incurred, by the reason of the silent - no-response to the lots of the property-claimed heretofore.

And: I do hereby certify that, on this same day and year above written, I deposited this "CERTIFICATE OF PROTEST" and the annexed instrument(s) – "Affidavit: Claim Of The Contacts For The Receipt Of Property-Claimed" –, postage-paid to the post office at the 13 East Ray Road, Gilbert, Arizona 85296 location, directed to the man parties to be charged:

Donald: POTUS Trump
c/o President of the United States
1600 Pennsylvania Ave NW
Washington, District of Columbia 20500

USPS CMN 7017 1000 0000 9343 0698

Jeff: U.S Attorney General Sessions
c/o United States Attorney General
950 Pennsylvania Avenue, N.W.
Washington, District of Columbia 20530

USPS CMN 7017 1730 0002 3063 9324

Reason for the certification of the protest is: silent - no-response to the sustained demands by the man for the obtainment of the private property-claimed, as indicated in the Affiant's Statement: "Affidavit: Claim Of The Contacts For The Receipt Of Property-Claimed" by the affiant: Darrell- James: Hill.

IN THE WITNESS WHEREOF: I have hereunto subscribed my name and affixed my seal of office.

Notary

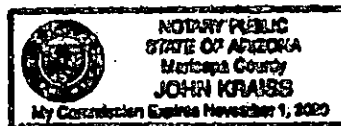

Seal

2022-011769 MISC Page: 711 of 2782
09/26/2022 03:35:37 PM Receipt #: 22-9381
Rec Fee: \$30.00 Darrell James Hill
Gila County, Az, Sadie Jo Bingham, Recorder



U.S. Postal Service
CERTIFIED MAIL® RECEIPT
 Domestic Mail Only

For delivery information, visit our website at www.usps.com

WASHINGTON, DC 20500

OFFICIAL USE

Certified Mail Fee \$3.45
 Extra Services & Fees (check box, add fee as appropriate)
 Return Receipt (hardcopy) \$2.75
 Return Receipt (electronic) \$0.00
 Certified Mail Restricted Delivery \$0.00
 Adult Signature Required \$0.00
 Adult Signature Restricted Delivery \$0.00

Postage \$13.65
 Total Postage and Fees \$19.85

Sent To: Donald: POTUS Trump
 c/o President of the United States
 1600 Pennsylvania Ave NW
 Washington, District of Columbia 20500

Postmark: HIGLEY AZ 85236
 07/12/2018

PS Form 3800, April 2015 PSN 7530-02-000-9053

U.S. Postal Service
CERTIFIED MAIL® RECEIPT
 Domestic Mail Only

For delivery information, visit our website at www.usps.com

WASHINGTON, DC 20530

OFFICIAL USE

Certified Mail Fee \$3.45
 Extra Services & Fees (check box, add fee as appropriate)
 Return Receipt (hardcopy) \$2.75
 Return Receipt (electronic) \$0.00
 Certified Mail Restricted Delivery \$0.00
 Adult Signature Required \$0.00
 Adult Signature Restricted Delivery \$0.00

Postage \$13.65
 Total Postage and Fees \$19.85

Sent To: Jeff U.S. Attorney General
 c/o United States Attorney General
 950 Pennsylvania Avenue, N.W.
 Washington, District of Columbia 20530

Postmark: HIGLEY AZ 85236
 07/12/2018

PS Form 3800, April 2015 PSN 7530-02-000-9053

HIGLEY
 3324 E RAY RD
 HIGLEY
 AZ
 85236-4500
 0338850381
 (800) 275-8777

07/12/2018 11:15 AM

Product Description	Sale Qty	Final Price
PM 2-Day Med FR Box (Domestic) (WASHINGTON, DC 20500) (Flat Rate) (Expected Delivery Date) (Saturday 07/14/2018)	1	\$13.65
Certified (USPS Certified Mail #) (7017100000093430698)	1	\$3.45
Return Receipt (USPS Return Receipt #) (9590940306765196708925)	1	\$2.75
PM 2-Day Med FR Box (Domestic) (WASHINGTON, DC 20530) (Flat Rate) (Expected Delivery Date) (Saturday 07/14/2018)	1	\$13.65
Certified (USPS Certified Mail #) (70151730000230639324)	1	\$3.45
Return Receipt (USPS Return Receipt #) (9590940306765196708895)	1	\$2.75
Total		\$39.70
Cash Change		\$50.00 (\$10.30)

Includes up to \$50 insurance

Text your tracking number to 2877 (2USPS) to get the latest status. Standard Message and Rate apply.

SENDER, COMPLETE THIS SECTION

1. Article Addressed to:
 Donald: POTUS Trump
 c/o President of the United States
 1600 Pennsylvania Ave NW
 Washington, District of Columbia 20500

2. Article Number (Transfer from service label) 9343 0698

3. Service Type
 Adult Signature
 Adult Signature Restricted Delivery
 Certified Mail
 Certified Mail Restricted Delivery
 Collect on Delivery
 Collect on Delivery Restricted Delivery
 Insured Mail
 Insured Mail Restricted Delivery (over \$500)

RECIPIENT, COMPLETE THIS SECTION ON DELIVERY

A. Signature: [Signature]
 Agent
 Addressee

B. Received by (Printed Name): [Name]
 C. Date of Delivery: 7/12/18

D. Is delivery address different from form 1? Yes
 (If YES, enter delivery address below: No)

3. Service Type
 Priority Mail Express®
 Registered Mail™
 Registered Mail Restricted Delivery
 Return Receipt for Merchandise
 Signature Confirmation™
 Signature Confirmation Restricted Delivery

2022-011769 MISC Page: 712 of 2782
 09/28/2022 03:35:37 PM Receipt #: 22-9381
 Rec Fee: \$30.00 Darrell James Hill
 Gila County, Az, Sadie Jo Bingham, Recorder

PSN 7530-02-000-9053 Domestic Return Receipt

U.S. Postal ServiceTM
CERTIFIED MAIL[®] RECEIPT
 Domestic Mail Only

For delivery information, visit our website at www.usps.com

WASHINGTON, DC 20500

OFFICIAL USE

Certified Mail Fee	\$3.45
Extra Services & Fees (check box, add fee, if appropriate)	\$2.75
<input type="checkbox"/> Return Receipt (hardcopy)	\$0.00
<input type="checkbox"/> Return Receipt (electronic)	\$0.00
<input type="checkbox"/> Certified Mail Restricted Delivery	\$0.00
<input type="checkbox"/> Adult Signature Required	\$0.00
<input type="checkbox"/> Adult Signature Restricted Delivery	\$0.00
Postage	\$13.65
Total Postage and Fees	\$19.85

Sent To: Donald: POTUS Trump
 c/o President of the United States
 1600 Pennsylvania Ave NW
 Washington, District of Columbia 20500

Postmark: HIGLEY AZ 85236 07/12/2018

PS Form 3800, April 2015 PSN 7530-02-000-6053 See Reverse for Instructions

U.S. Postal ServiceTM
CERTIFIED MAIL[®] RECEIPT
 Domestic Mail Only

For delivery information, visit our website at www.usps.com

WASHINGTON, DC 20530

OFFICIAL USE

Certified Mail Fee	\$3.45
Extra Services & Fees (check box, add fee, if appropriate)	\$2.75
<input type="checkbox"/> Return Receipt (hardcopy)	\$0.00
<input type="checkbox"/> Return Receipt (electronic)	\$0.00
<input type="checkbox"/> Certified Mail Restricted Delivery	\$0.00
<input type="checkbox"/> Adult Signature Required	\$0.00
<input type="checkbox"/> Adult Signature Restricted Delivery	\$0.00
Postage	\$13.65
Total Postage and Fees	\$19.85

Sent To: Jeff: U.S. Attorney General Sessions
 c/o United States Attorney General
 950 Pennsylvania Avenue, N.W.
 Washington, District of Columbia 20530

Postmark: HIGLEY AZ 85236 07/12/2018

PS Form 3800, April 2015 PSN 7530-02-000-6053 See Reverse for Instructions

HIGLEY
 3324 E RAY RD
 HIGLEY
 AZ
 85236-4500
 0338850381
 07/12/2018 (800)275-8777 11:15 AM

Product Description	Sale Qty	Final Price
PH 2-Day Med FR Box (Domestic) (WASHINGTON, DC 20500) (Flat Rate) (Expected Delivery Date) (Saturday 07/14/2018)	1	\$13.65
Certified (USPS Certified Mail #) (7017100000093430698)	1	\$3.45
Return Receipt (USPS Return Receipt #) (9590940306765196708925)	1	\$2.75
PM 2-Day Med FR Box (Domestic) (WASHINGTON, DC 20530) (Flat Rate) (Expected Delivery Date) (Saturday 07/14/2018)	1	\$13.65
Certified (USPS Certified Mail #) (70151730000230639324)	1	\$3.45
Return Receipt (USPS Return Receipt #) (9590940306765196708895)	1	\$2.75
Total		\$39.70
Cash Change		\$50.00 (\$10.30)

Includes up to \$50 insurance

Text your tracking number to (2USPS) to get the latest status Standard Message and Data

SENDER COMPLETE THIS SECTION

- Complete items 1, 2, and 3.
- Print your name and address on the reverse so that we can return the card to you.
- Attach this card to the back of the mailpiece, or on the front if space permits.

1. Article Addressed to:

Jeff: U.S. Attorney General Sessions
 c/o United States Attorney General
 950 Pennsylvania Avenue, N.W.
 Washington, District of Columbia 20530

2. Article Number (Transfer from service label)

7015 1730 0002 3063 9324

PS Form 3811, April 2015 PSN 7530-02-000-6053

COMPLETE THIS SECTION ON DELIVERY

A. Signature Agent Addressee

B. Received by (Printed Name) C. Date of Delivery

D. Is delivery address different from item 1? Yes No
 If YES, enter delivery address below:

July 16 2018

3. Service Type

<input type="checkbox"/> Adult Signature	<input type="checkbox"/> Priority Mail Express [®]
<input checked="" type="checkbox"/> Adult Signature Restricted Delivery	<input type="checkbox"/> Registered Mail [™]
<input type="checkbox"/> Certified Mail [®]	<input type="checkbox"/> Registered Mail Restricted Delivery
<input type="checkbox"/> Certified Mail Restricted Delivery	<input type="checkbox"/> Return Receipt for Merchandise
<input type="checkbox"/> Collection Delivery	<input type="checkbox"/> Signature Confirmation [™]
<input type="checkbox"/> Collect on Delivery Restricted Delivery	<input type="checkbox"/> Signature Confirmation Restricted Delivery
<input type="checkbox"/> Insured Mail	
<input type="checkbox"/> Insured Mail Restricted Delivery (over \$500)	

2022-011769 MISC Page: 713 of 2782
 09/26/2022 03:35:37 PM Receipt #: 22-9881
 Rec Fee: \$30.00 Darrell James Hill
 Gila County, AZ, Sadie Jo Bingham, Recorder

714

**: AFFIDAVIT:
Claim Of The Contacts For The Receipt Of Property-Claimed**

State of Arizona

County of Pinal

:Darrell- James: Hill, man, personally appears before me, the undersigned Notary duly authorized by the laws of Arizona to administer oaths; now on this 10th, day: July month: 2018 : 02 : 16 am (pm) being by me first duly sworn on his affirmation, affiant deposes and says:

- (A) On the September 9th, 2016, i: Darrell- James: Hill, man – and wife: Beverly- Jean: Romero- Hill –, made: “AFFIDAVIT: Constructive Notice of “DARRELL JAMES HILL” of “Darrell- James: of the family Hill”, Authorized Representative, and: “AFFIDAVIT: Superior Constructive Notice and Demand: Permanent Non-Commercial Presumption” to the man, a) Barak: President of the United States Obama: USPS RE 322 398 208 US, with corresponding documents sent to: b) Joseph: Chairman: JCOS, General Dunford: USPS RE 322 398 211 US; c) Mark: COS-Army, General Miley: USPS RE 398 225 US; and d) Melba: Secretary of the Treasury Febo: USPS RE 322 398 239: annexed: 25 pages.
- (B) On the September 9th, 2016, i: Darrell- James: Hill, man – and wife: Beverly- Jean: Romero- Hill –, made: “(A)” – AFFIDAVIT: Constructive Notice of “DARRELL JAMES HILL” of “Darrell- James: of the family Hill”, Authorized Representative, and: “AFFIDAVIT: Superior Constructive Notice and Demand: Permanent Non-Commercial Presumption – to the man, a) Loretta: U.S. Attorney General Lynch: USPS RMN 322 399 282 US, with corresponding document sent to: b) David: U.S. Marshall's Service- Deputy Director Harlow: USPS CMN 7016 0340 0000 6402 7741; c) Laurie: Office of Information Policy- Chief Day: USPS CMN 7016 0340 0000 6402 7802; and, d) Mark: Arizona Attorney General Brnovich: USPS CMN 7016 0340 0000 6402 7796: annexed: 7 pages.
- (C) On the October 25th, 2016, i: Darrell- James: Hill, man, made claims, “Claim1: USPS RMN RE 322 399 279 US”, to the property given to the United States of America people. See: “ NOTICE: CLAIM; RE: Property given to the United States in the “UNITED STATES ATTORNEY'S OFFICE; OFFICIAL NOTIFICATION POSTED ON OCTOBER 12, 2016” ”– mailed to the woman, Loretta: United States Attorney General Lynch by the USPS RMN RE 322 399 279 US, delivered on October 31st, 2016: annexed: 308 pages.
- (D) On the November 10th, 2016: response from the Claim1: USPS RMN RE 322 399 279 US; is No-Response¹ from from the woman, Loretta: U.S. Attorney General Lynch to the man, i: Darrell- James: Hill.
- (E) On the November 10th, 2016, i: man sent, “NOTICE: Cease and Desist: RE: October 31st, 2016 Registered Mail Notice: Claim RE 322 399 279 US: Sept. 13th, 2016 Property Claimed Table: Enclosure One: 5 pages ” to the woman, Loretta: United States Attorney General Lynch by the USPS CMN 7016 0340 0000 6402 7789: annexed: 9 pages.
- (F) On the November 16th, 2016: response from the NOTICE:... USPS CMN 7016 0340 0000 6402 7789; is No-Response from the woman, Loretta: United States Attorney General Lynch to the man, i: Darrell- James: Hill.
- (G) On the November 16th, 2016, i: man sent, 'NOTICE: Cease and Desist; RE: a)NOTICE ... re: CMN 7016 0340 0000 6402 7789...; b) NOTICE09/21-27/16 PROPERTY POSTING TABLE...re: RMN RB 898

1 No-Response, No response means: not overt doing some thing, as in silence: the design of failure to communicate.



810 007 US; c) NOTICE ...09/28-10/12/16 PROPERTY POSTING TABLE...re: RMN RB 898 810 007 US' to the woman, Loretta: United States Attorney General Lynch by the USPS RMN RB 898 810 007 US: annexed: 24 pages.

- (H) On the January 3rd, 2017: response from the NOTICE:... USPS RMN RB 898 810 007 US; is No-Response from the woman, Loretta: United States Attorney General Lynch to the man, i: Darrell- James: Hill.
- (I) On the January 3rd, 2017, i: Darrell- James: Hill, man, sent: Common Law Claim - Claimant Case No: CMN 7009 1410 0000 7868 5703 - to the man, a) Ranier: Chief Judge, District Court Arizona; and, b) Brian: Clerk of Court, District Court, Phoenix, Arizona. See: Reference: Gila County, Ariz., Recorder Doc# 2017-002378, page: 182-194 of 693.
- (J) On the January 4th, 2017, et seq.: people in the District Court, Arizona, did Not file: Common Law Claim - Claimant Case No: CMN 7009 1410 0000 7868 5703 - sent on the January 3rd, 2017. See: Reference: Gila County, Ariz., Recorder Doc# 2017-002378, page: 192-194 of 693.
- (K) On the March 20th, 2017, i: Darrell- James: Hill, man, made "Claim2: USPS RMN RE 322 399 251 US", to the property given to the United States of America people. See: "NOTICE: CLAIM; RE: Property given to the United States in the "UNITED STATES ATTORNEY'S OFFICE; OFFICIAL NOTIFICATION POSTED ON FEBRUARY 13, 2017"" - mailed to the man, Jeff: United States Attorney General Sessions by the USPS RMN RE 322 399 251 US, delivered on March 31st, 2017: annexed: 324 pages.
- (L) On the July 7th, 2017: response from the Claim2: USPS RMN RE 322 399 251 US; is No-Response from the man, Jeff: United States Attorney General Sessions to the man, i: Darrell- James: Hill.
- (M) On July 7th, 2017, i: Darrell- James: Hill, made: "AFFIDAVIT: PROOF OF CLAIM: A.R.S. 11-480(D): Gila County Recorder - Doc.Num: 2017-002378" - for the rights-asserted and within regards to the obtainment of the lots of the all property claimed - in to the Public Recorder - Gila County, Ariz.: annexed: 27 pages.
- (N) On the July 13th, 2017, i: Darrell- James: Hill, sent: "(M)" - 'AFFIDAVIT:... Gila County Recorder - Doc.Num: 2017-002378' to the man, Jeff: U.S. Attorney General Sessions: USPS RMN RE 322 399 058 US; Elizabeth: Acting U.S. Attorney- Arizona: USPS CMN 7015 0640 001 5883 2655; Laurie: Office of Information Policy Chief Day: USPS RMN RE 322 399 061 US; Michael: U.S. DOJ- IG Horowitz/ c/o Robert: U.S. DOJ- Deputy IG Storch: USPS RMN RE 322 399 089 US; FBI- Acting Director c/o Andrew: FBI Deputy Director McCabe and David: Associate Deputy Director Bowdich: USPS RMN RE 322 399 075 US; Richard, FBI- Phoenix Branch Manger Benson and Michael, Special Agent in Charge DeLeon: USPS First Class Mail; Mark: Pinal county Sheriff Lamb: USPS RMN RE 322 399 092 US; and C/O Donald: President Trump: USPS RMN RE 322 399 044 US: Annexed 7 pages.
- (O) On the July 13th, 2017, i: Darrell- James: Hill, sent "RE: Demand for You to dispose property-claimed and essence to me at the address above in re: NOTICE: CLAIM: USPS RMN RE 322 399 251 US; sent March 21, 2017; rec'd March 31, 2017, 0524 a.m.", to the man, Jeff: U.S. Attorney General Sessions: USPS RMN RE 322 399 101 US: annexed: 2 pages.
- (P) On the August 8th, 2017: response from the "(N)": "(M)" - "AFFIDAVIT:... Gila County Recorder - Doc.Num: 2017-002378" sent to the man, Jeff: U.S. Attorney General Sessions, et al.; C/O the man Donald: President Trump: USPS RMN RE 322 399 044 US; is No-Response from the man, Jeff, et al., nor Donald, to the man, i: Darrell- James: Hill



- (Q) On the August 8th, 2017, i: Darrell- James: Hill, sent "NOTICE: ATTENTION TO CONSTITUTIONAL PROTECTED RIGHTS DEPRIVATION; RE: Darrell- James: Hill;: "Affidavit: Proof of Claim" - See Affidavit: Gila county Recorder: gilacountyaz.gov/recorder/web/ : Doc. #2017-006522 - received by you mid-July-2017 by USPS RMN RE 322 399 058 US.", to the man, Jeff: U.S. Attorney General Sessions, c/o Kenneth: Acting Assistant AG Blanco: USPS CMN 7015 0640 0001 5883 2662: annexed: 2 pages.
- (R) On the August 23rd, 2017: response from the 'NOTICE: ATTENTION... USPS RMN RE 322 399 058 US.': USPS CMN 7015 0640 0001 5883 2662: is No-Response from the man, Jeff: United States Attorney General Sessions, et al., to the man, i: Darrell- James: Hill.
- (S) On the August 23rd, 2017, i: Darrell- James: Hill sent "NOTICE AND DEMAND; NOTICE: i am a man of the non-political aggregate; a) proclaimed forever free, protected by the Constitution for the United States of America-1787 by the Executive Branch and by the military and naval authority; b) i am Not subject to the General Orders No. 100: The Lieber Code; c) embrace and exercise rights guaranteed protected by the Constitution for the United States of America/ U.S. Constitution that have been ignored by the U.S. Government Judicial Branch dereliction of oath, duty and obligation, and Executive Branch infidelity to oath, duty and obligation. DEMAND: i wish a favorable end to this controversy. Fidelity in honor of oath, duty and obligation in respect of my status and Almighty-God-Given supreme rights guaranteed by the Constitution for the United States of America, and proclaimed in the Emancipation Proclamation forever proactively protected by the Executive Branch, and the military and naval authority[]" to the man, Donald: POTUS Trump; Paul: Gen. Selva, USAF, JCOS, Vice Chairman; Mark: Gen. Miley, US Army, COS Army; Robert: Gen. Nelerm, USMC. Commandant MC; John: Adm. Richardson, US Navy, Chief NO; David: Gen. Godfeinn, USAF, COS AF; Joseph: Gen. Lengyel, USAF, Chief NGB; and, C/O Joseph: Gen. Dunford, USMC, JCOS: USPS RMN RE 322 399 132 US: annexed: 19 pages.
- (T) On the September 15th, 2017, i: Darrell- James: Hill, man, made claims, "Claim3: USPS RMN RE 322 399 248 US", to the property given to the United States of America people. See: " CLAIM: NOTICE AND DEMAND; RE: Property disposed to the United States of America reported in the "UNITED STATES ATTORNEY'S OFFICE; OFFICIAL NOTIFICATION POSTED ON AUGUST 30, 2017" " - mailed to the man, Jeff: United States Attorney General Sessions by the USPS RMN RE 322 399 248 US, delivered on September 26th, 2017: annexed: 363 pages.
- (U) On the January 17th, 2018: response from the "(S)" - "NOTICE AND DEMAND: ...": USPS RMN RE 322 399 132 US: is No-Response from the man, Donald: POTUS Trump, neither Paul, Mark, Robert, John, David, Joseph: United States Military Leadership, nor Jeff: US Attorney General Sessions to the man, i: Darrell- James: Hill.
- (V) On the January 17th, 2018, i: Darrell- James: Hill sent "DISHONOR; Re: A: August 16, 2016, CLAIM: USPS RMN RE 322 399 279 US; February 17, 2017 CLAIM: USPS RMN RE 322 251 US; and, September 15, 2017 CLAIM: USPS RMN RE 322 399 248 US; B: CLAIMS VIOLATIONS: January 09, 2018: ITEMIZED BILLS TOTAL DUE-NOW-PAID is: "1,123,300 ~one million one hundred twenty-three thousand three hundred: 1-ounce .999 silver U.S. dollars[]" to the man, Jeff: US Attorney General Sessions, delivered on the January 29th, 2018: annexed: 7 pages.
- (W) On the January 31st, 2018, i: Darrell- James: Hill sent " DEMAND FOR THE FIDUCIARY PROTECTION OF FUNDAMENTAL RIGHTS; Re: DISHONOR: USPS RMN RE 322 399 146 US: Jeff actor in the role of the fiduciary United States Attorney General Sessions, 'USAG', -January 2018 - Recv'd January 29, 2018; W/ Re: Claims: August 16, 2016, CLAIM: USPS RMN RE 322 399 279 US; February 17, 2017 CLAIM: USPS RMN RE 322 399 251 US; September 15, 2017 CLAIM: USPS RMN

RE 322 399 248 US; and: Bills: CLAIMS VIOLATIONS (3): January 09, 2018: ITEMIZED BILLS TOTAL DUE-NOW-PAID is: '1,123,300' ~one million one hundred twenty-three thousand three hundred: 1-ounce .999 silver U.S. dollars[] " to the man, Donald :appointed fiduciary: Commander-in-Chief - :military; and: Joseph :actor in the role of the JCOS General Dunford, and: Mark :actor in the role of the COS Army General Miley; c/o :Donald :actor in the role of the POTUS Trump 'United States government': USPS RMN 322 399 150 US, delivered on the February 21st, 2018; annexed: 4 pages.

- (X) On the April 13th, 2018: response from the "(W)" - 'DEMAND FOR THE FIDUCIARY PROTECTION OF FUNDAMENTAL RIGHTS: ...': USPS RMN 322 399 150 US: is No-Response from the man, Donald: POTUS Trump, neither Mark, nor Joseph: United States Military Leadership to the man, i: Darrell- James: Hill.
- (Y) On the April 13th, 2018, i: Darrell- James: Hill sent "NOTICE OF DEFAULT; Option to Cure Default" - to the man, Donald :appointed fiduciary: Commander-in-Chief - :military, and; Joseph :actor in the role of the JCOS General Dunford, and: Mark :actor in the role of the COS Army General Miley; c/o :Donald :actor in the role of the POTUS Trump 'United States government': USPS RMN RE 322 398 242 US, delivered on the April 19th, 2018; annexed: 2 pages.
- (Z) On the May 29th, 2018: response from the "(Y)" - "NOTICE OF DEFAULT; Option to Cure Default": USPS RMN 322 398 242 US: is No-Response from the man, Donald: POTUS Trump, neither Mark, nor Joseph: United States Military Leadership, to the man, i: Darrell- James: Hill.
- (AA) On the May 29th, 2018, i: Darrell- James: Hill sent "DISHONOR" - to the man, Donald :appointed fiduciary: Commander-in-Chief - :military [and] :Joseph :actor in the role of the JCOS General Dunford; Mark :actor in the role of the COS Army General Miley c/o :Donald :actor in the role of the POTUS Trump 'United States government': USPS RMN RE 047 636 404 US, delivered on the June 6th, 2018; annexed: 2 pages.
- (AB) On the July 10th, 2018: response from the "(Y)" - "DISHONOR": USPS RMN 047 636 404 US: is No-Response from the man, Donald: POTUS Trump, neither Mark, nor Joseph: United States Military Leadership to the man, i: Darrell- James: Hill.
- (AC) As of this signing, to the Claims-asserted to the property in the Claim1: USPS RMN RE 322 399 279 US, and Claim2: USPS RMN RE 322 399 251 US, and Claim3: USPS RMN RE 322 399 248 US, response from the man Jeff: US Attorney General Sessions; Donald: POTUS Trump is No-Response to the man, i: Darrell- James: Hill.

Autographed: 10th day: July month: 2018

Without prejudice

Darrell- James: Hill

Sworn to and subscribed before me now on this 10th day: July month: 2018.
Produced identification: type: Arizona Driver License.

Notary

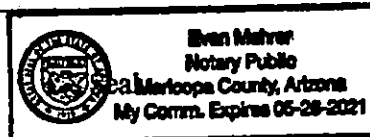

2022-011769 MISC Page: 717 of 2762

09/26/2022 03:35:37 PM Receipt #: 22-9381
Rec Fee: \$30.00 Darrell James Hill
Gila County, Az, Sadie Jo Bingham, Recorder



718

**AFFIDAVIT: Superior Constructive Notice and Demand:
Permanent Non-Commercial Presumption**

Introduction

This Notice and Demand¹ is the political² election³ and directive⁴ of the "man"⁵, Darrell-James: Hill⁶, sui-juris⁷ under Almighty-God⁸ born⁹ on-the-ground¹⁰ of the Ohio-state¹¹ territory¹² of the Nation-states¹³ of the united States of America¹⁴; to wit, an American-National-Citizen¹⁵, "American", of the people¹⁶-of-the-united-States-of-America¹⁷, a "Principal"¹⁸. Thus, this Notice and Demand is a directive from this American Principal man; "AP"¹⁹, pointing to the truth under the authority of the Declaration of Independence (1776)²⁰ - Articles of Confederacy (1781)²¹ - The Constitution for the United States of America (1787)²² - Bills of Rights (1791)²³, the

- 1 demand means: making "[a]n imperative request preferred by one [Man] to [the United States government], under a claim of right, requiring the latter to do something or to abstain from some act[;]" in the nature of Zimmerman v. Hicks, C.C.A., 7 F.2d. 443, 445; Black's Law Dictionary, 4th Ed., p. 516.
- 2 political means: 'Pertaining to, or incidental to, the exercise of the functions vested in those charged with the conduct of government; ... of or pertaining to the exercise of rights and privileges or the influence by which people of a state seek to determine or control its public policy[;]' in the nature of State ex rel. Maley v. Civic Action Committee, 238 Iowa 851, 28 N.W.2d 467, 470; Black's Law Dictionary, 4th Ed., p. 1319.
- 3 election means: 'the act of choosing or selecting one or more from a greater number of persons, things, courses or rights. The choice of an alternative[;]' in the nature of State v. Tucker, 54 Ala. 210; Black's Law Dictionary, 4th Ed., p. 608.
- 4 directive means: A '... guide; order; command; instruction' given; in that nature of Durkee's Estate, 47 N.Y.S. 2d 721, 725, 726; 183 Misc. 382; Black's Law Dictionary, 4th Ed., p. 546.
- 5 man means: God Almighty's created being, species embodying a soul, spirit and flesh for the husbandry-dominion of the earth in direct regular relationship with God. Also, scientifically referred to as Homo sapiens sapiens.
- 6 BORNNAME means: the man-child's give name, Darrell- James, and of the family name Hill; to wit: "Darrell-James: Hill".
- 7 sui juris means: 'of his own right; possessing full social and civil rights' standing[;] in the nature of Black's Law Dictionary, 4th Ed., p. 1602.
- 8 Almighty God means: The true and living God of Abraham, Isaac, Jacob, the father of the Messiah Yushua (Jesus the Christ); Him under whom the Nation states of the united States of America is constituted.
- 9 born means: brought into flesh and blood status by birth- 'the process of a species being naturally wholly reproduced and brought into a separate existence[;]' in the nature of Wallace v. State, 10 Tex. App. 270; Black's Law Dictionary, 4th Ed., p. 213.
- 10 on the ground means: dry earth territory as opposed to the sea.
- 11 state means: one of the sovereign territories of the union of States of America, indicating 'a people sojourning occupying a fixed territory that are bound together by common-law habits and custom into one body politic of an organized government' under the constitution for the united States of America[;] in the nature of United States v. Kusche, D.C.Cal., 56 F. Supp. 201, 207, 208; Black's Law Dictionary, 4th Ed., p. 1578.
- 12 territory means: the real property above, on and below the land within the confines and under the jurisdiction of a sovereign republic state of the several members of the union of States of America.
- 13 Nation states means: the perpetual union of the states of The United States of America; each state retains its sovereignty, freedom, and independence, and every power, jurisdiction, and right, which is not by this Confederation expressly delegated to the United States as expressed in the Articles of Confederation and disposed in The Constitution for the United States of America and Bill of Rights.
- 14 united States of America means: Nation states in union; see 11 above, united.

Notice and Demand: Darrell- James: Hill

1 Of 17

2017-002378 MISC Page: 109 of 693

03/10/2017 12:35:10 PM Receipt #: 17-1634
Rec Fee: \$250.00 Darrell- James: Hill
Gila County, Az, Sadie Jo Bingham, Recorder



2022-011769 MISC Page: 718 of 2782

09/26/2022 09:35:37 PM Receipt #: 22-9381
Rec Fee: \$30.00 Darrell James Hill
Gila County, Az, Sadie Jo Bingham, Recorder



**AFFIDAVIT: Superior Constructive Notice and Demand:
Permanent Non-Commercial Presumption**

documents constituting the united States of America, the "Originating-Documents"²⁴.

This AP makes notice of and demands that the United-States²⁵-Government²⁶, including, but not limited to, its agents²⁷, actors²⁸, assigns²⁹ and proxies³⁰, and, including County Sheriffs, hereafter "U.S.- government"³¹, in all and every encounter³² with or in regards to the AP set the AP- man permanent presumption in their any referencing database(s) that upon any contact with or in regards to the AP-man the permanent non-commercial³³ presumption³⁴ status³⁵ of AP be the database reference result for all U.S. government-encounters.

U.S. government's U.S. Citizen- the Commercial Status

This AP, "Darrell- James: Hill", had been juxtaposed³⁶ with the commercial-construction

- 15 **American National Citizen** means: a man-child born in a Nation state of the union of States of America; an American.
- 16 **people** means: two or more American National Citizens
- 17 **people of the united States of America** means: two or more persons of either men-, or women-, or children- American Principals
- 18 **Principal** means: one man-, woman-, or child- American of the people of the united States of America; the element of the American National Citizen inherent in the people of the united States of America; of "[t]he source of authority or right. A superintendent...[;]" in the nature of Williams v. School Dist. No 189, 104 Wash. 659, 177 P. 635, 636: Black's Law Dictionary, 4th Ed., p. 1355.
- 19 **AP** means: "American Principal man": an American National Citizen- of the people of the united States of America born in a state of the Nations states of the united States of America.
- 20 **Declaration of Independence (1776)** means: IN CONGRESS, July 4, 1776. The unanimous Declaration of the thirteen united States of America, ... We hold these truths to be self-evident, that all men are created equal, that they are endowed by their Creator with certain unalienable Rights, that among these are Life, Liberty and the pursuit of Happiness.— That to secure these rights, Governments are instituted among Men, deriving their just powers from the consent of the governed, —
- 21 **Articles of Confederacy (1781)** means: To all to whom these Presents shall come, we the undersigned Delegates of the States affixed to our Names send greeting.
Articles of Confederation and perpetual Union between the states of New Hampshire, Massachusetts-bay Rhode Island and Providence Plantations, Connecticut, New York, New Jersey, Pennsylvania, Delaware, Maryland, Virginia, North Carolina, South Carolina and Georgia.
I. The Stile of this Confederacy shall be "The United States of America".
II. Each state retains its sovereignty, freedom, and independence, and every power, jurisdiction, and right, which is not by this Confederation expressly delegated to the United States, in Congress assembled.
- 22 **The Constitution for the United States of America (1787)** means: "We the People of the United States, in Order to form a more perfect Union, establish Justice, insure domestic Tranquility, provide for the common defense, promote the general Welfare, and secure the Blessings of Liberty to ourselves and our Posterity, do ordain and establish this Constitution for the United States of America."
- 23 **Bill of Rights (1791)** means: The conventions of a number of the States having at the time of their adopting the Constitution, expressed a desire, in order to prevent misconstruction or abuse of its powers, that further declaratory and restrictive clauses should be added.
Article the eleventh [Amendment IX] The enumeration in the Constitution, of certain rights, shall not be construed to deny or disparage others retained by the people.
Article the twelfth [Amendment X] The powers not delegated to the United States by the Constitution, nor prohibited by it to the States, are reserved to the States respectively, or to the people.
- 24 **Originating Documents:** means the Declaration of Independence (1776) and Articles of Confederacy (1781)

Notice and Demand: Darrell- James: Hill

2 Of 17

2022-011769 MISC Page: 719 of 2782

09/26/2022 05:35:37 PM Receipt #: 22-9381

Rec Fee: \$30.00 Darrell- James Hill

Gila County, Az, Sadie Jo Bingham, Recorder



2017-002378 MISC Page: 110 of 693

03/10/2017 12:35:10 PM Receipt #: 17-1634

Rec Fee: \$250.00 Darrell- James: Hill

Gila County, Az, Sadie Jo Bingham, Recorder



106

720

**AFFIDAVIT: Superior Constructive Notice and Demand:
Permanent Non-Commercial Presumption**

"U.S. Citizen"³⁷", "DARRELL JAMES HILL",⁵ by the U.S. Government for use in its commercial presumption system.

The commercial U.S. Citizen is the U.S. government's legal³⁸ commercial-construction³⁹ for all U.S governmental encounters with any man-, woman-, or child- American Principal, and this AP. The U.S. Citizen construct is originated⁴⁰ and is derived⁴¹ from the birth⁴² of the AP-child⁴³, and the title⁴⁴ for the U.S Citizen is derived from the given-name⁴⁵ and the surname⁴⁶ of the AP-child born. Thus, the AP, "Darrell- James: Hill", has been juxtaposed with the U.S. Citizen⁴⁷, "DARRELL JAMES HILL", by and within the U.S. government's U.S. Citizen commercial⁴⁸ presumption system. Other U.S. Citizen-types exist, such as commercial corporations and government corporations; however, they are not the topic of the U.S. Citizen

and The Constitution for the United States of America (1787) and Bills of Rights (1791)

- 25 United States means: "U.S.", a federal corporation in commerce, in the nature of Title 28 of the U.S. Code § 3002(15).
- 26 United States Government means: the utility distinguished under the Originating Documents under the people, under Almighty God; and, any further form of government derivative thereunder, including but not limited to the federal commercial corporation construct, the federal corporation of the "United States" in government active as of this writing.
- 27 agent means: one operating in agency including "every relation in which one person acts for or represents another by [the] latter's authority," in the nature of *Saums v. Parfet*, 270 Mich. 165, 258 N.W. 235, "where one person acts for another, either in the relationship of principal and agent, master and servant, or employer or proprietor and independent contractor", in the nature of *Gorton v. Doty*, 57 Idaho 792, 69 P.2d. 136, 139; *Black's Law Dictionary*, 4th Ed., p. 84.
- 28 actor means: "[o]ne who act[s] for another; one who attended to another's business; a manager [One] who attend[s] to, transact[s], or superintend[s] his master's business or affairs, received and paid out moneys, and kept accounts[;] in the nature of *Burrill*; *Black's Law Dictionary*, 4th Ed., p. 53.
- 29 assign means: "generally... all those who take either immediately or remotely from or under the assignor, whether by conveyance, devise, descent, or act of law[;]" in the nature of *Ferrell v. Deverick*, 100 S.E. 850, 853, 85 W.Va. 1; *Black's Law Dictionary*, 4th Ed., p. 154.
- 30 proxies: proxy means: one "who is substituted or [deputized] by another to represent him and act for him.... An agent representing and acting for [the] principal. Also the instrument containing the appointment of such...[;] in the nature of *Manson v. Curtis*, 223 N.Y. 313, 119 N.E. 559, 561, Ann.Cas.1918E, 247; *Cliffs Corporation v. United States*, C.C.A.Ohio, 103 F.2d 77, 80; *Black's Law Dictionary*, 4th Ed., pp. 1391-1392.
- 31 U.S. government means: "The whole class or body of office-holders or functionaries considered in the aggregate, upon whom devolves the ... administrative business of the state[;] in the nature of *Stokes v. United States*, C.C.A.Mo., 264 F. 18, 22; *Black's Law Dictionary*, 4th Ed., p. 824.
- 32 encounter means: to meet expectedly or unexpectedly, in peace or controversy anticipated or unanticipated.
- 33 commercial means: As relates to commerce. "The exchange of goods, productions, or property of any kind[;] in the nature of *Jeu Jo Wan v. Nagle*, C.C.A.Cal., 9 F.2d 308, 310; "relating to or connected with trade and traffic or commerce in general[;] in the nature of "Zante Currents", C.C.Cal., 73 F. 189; *Black's Law Dictionary*, 4th Ed., pp. 336-337.
- 34 Presumption means: "Of fact. An interference affirmation or disaffirmative of the truth or falsehood of any proposition or fact drawn by a process of probable reasoning in the absence of actual certainty of its truth or falsehood, or until such certainty can be ascertained[;]" in the nature of *Best*, Pres. § 3; *Black's Law Dictionary*, 4th Ed., p. 1349.
- 35 status means: "Standing, state or condition[;]" in the nature of *Reynolds v. Pennsylvanian Oil Co.*, 150 Cal. 629, 89 P. 610, 612; "The legal relation of the individual to the [remainder] of the community[;]" in the nature of

Notice and Demand: Darrell- James: Hill

3 Of 17

2022-011769 MISC Page: 720 of 2782
09/26/2022 03:35:37 PM Receipt #: 22-9981
Rec Fee: \$30.00 Darrell James Hill
Gila County, Az, Sadie Jo Bingham, Recorder

721

2017-002378 MISC Page: 111 of 693
03/10/2017 12:35:10 PM Receipt #: 17-1634
Rec Fee: \$250.00 Darrell- James: Hill
Gila County, Az, Sadie Jo Bingham, Recorder

107

**AFFIDAVIT: Superior Constructive Notice and Demand:
Permanent Non-Commercial Presumption**

berth based upon the born AP-child. See Attachment A: "AFFIDAVIT: Constructive Notice of DARRELL JAMES HILL's Authorized Representative: Darrell- James: Hill", 2 pages.

The AP, Darrell- James: Hill, is the Authorized-Representative⁴⁹, "A.R.", of the related commercial construct DARRELL JAMES HILL in any and all U.S. government encounters. Thus, this AP's election also includes the demand for the permanent presumption that in all U.S. government encounters the AP include the added distinction, "A.R.", in any and all regards to the commercial construct "DARRELL JAMES HILL", the U.S. Citizen.
U.S. Citizen Trojan Horse

Duryea v Duryea, 46 Idaho 512, 269 P. 987, 988; Black's Law Dictionary, 4th Ed., p. 1580; Black's Law Dictionary, 4th Ed., p. 1580.

36 Juxtaposed means: having been put "in nearness or [close proximity]; or side by side...[;] in the nature of Brown v. State, 126 Tex. Cr.R. 449, 72 S.W.2d 269, 270; Black's Law Dictionary, 4th Ed., p. 1005.

37 Citizen means: "A member of a free city or jural society (*civitas*,) possessing all [of] the rights and privileges which can be enjoyed by any person under its constitution and government, and subject to the corresponding duties...[;] in the nature of In Re McIntosh, D.C.Wash., 12 F.Supp. 177; and, "A corporation is a citizen of a state under whose laws it is created and a nonresident of every other state[;] in the nature of Jackson Securities & Investment Co. v. State. 241 Ala. 288, 2 S.2d 760, 764; Black's Law Dictionary, 4th Ed., p. 310.

38 legal means: "1. Conforming to the law; according to law; required or permitted by law; not forbidden or discountenanced by law; good and effectual in law[;] in the nature of Freeman v. Fowler Packing Co., 135 Kan. 378; 11 P.2d 276, 277; General Motors Acceptance Corporation v. Schwartz, 118 N.J.L. 25, 190 A. 625, 627; Black's Law Dictionary, 4th Ed., p. 1038.

39 commercial construction means: the fictitious construct "creation of something new, as distinguished from the repair or improvement of something already existing[;] in the nature of Cabell v. City of Portland, 153 Or. 528, 57 P.2d 1292, 1297; Black's Law Dictionary, 4th Ed., p. 386; Black's Law Dictionary, 4th Ed., p. 386.

40 originated means: having had a beginning from after the original; to wit: ... "first in order; bearing its own authority, and not deriving authority from an outside source...[;] in the nature of Arenson v. Jackson, 97 Misc.Rep. 606, 162 N.Y.S. 142, 143; State v. Lee, 173 La. 770, 138 So. 662; Black's Law Dictionary, 4th Ed., p. 1251.

41 derive means: "To receive, as from a source or origin[;] in the nature of Crews v. Commissioner of Internal Revenue, C.C.A.10, 89 F.2d 412, 416; Black's Law Dictionary, 4th Ed., p. 530.

42 birth means: "The act of being born or wholly brought into separate existence[;] in the nature of Wallace v. State, 10 Tex. App. 270; Black's Law Dictionary, 4th Ed., p. 213.

43 child means: the essential embodiment of the newly born of the man species; the physical, mental and spiritual baby maturity unto and until it is in time an adult in body/ mind/ spirit.

44 title means: "The designation of [a commercial] individual person, or a firm or a corporation[;]" in the nature of Riley v. Litchfield, 168 Iowa 187, 150 N.W. 81, 83, AnnCas.1917B, 172; Black's Law Dictionary, 4th Ed., pp. 1655, 1174.

45 given name means: a non-commercial appellation for a man child, a gift; commonly referred to as the "Christian appellation"

46 surname means: "The family name; the name over and above the Christian name. The part of a name which is not given in baptism: that name of a person which is derived from the common name of his parents; in the nature of In re Faith's Application, 22 N.J. Misc. 412, 39 A.2d 638, 640; Black's Law Dictionary, 4th Ed., p. 1612.

47 Citizen means: "A member of a free city or jural society (*civitas*,) possessing all [of] the rights and privileges which can be enjoyed by any person under its constitution and government, and subject to the corresponding

Notice and Demand: Darrell- James: Hill

4 Of 17

2022-011769 MISC Page: 721 of 2782
09/26/2022 03:35:37 PM Receipt #: 22-9981

Rec Fee: \$30.00 Darrell James Hill
Gila County, Az, Sadie Jo Bingham, Recorder



2017-002378 MISC Page: 112 of 693

03/10/2017 12:35:10 PM Receipt #: 17-1634
Rec Fee: \$250.00 Darrell- James: Hill

Gila County, Az, Sadie Jo Bingham, Recorder



108

**AFFIDAVIT: Superior Constructive Notice and Demand:
Permanent Non-Commercial Presumption**

The U.S. government, in creating and implementing its U.S.- Constitutionally⁵⁰ based commercial construct, the U.S. Citizen, did realize⁵¹ its need for possessing⁵² a status of a commercial persona⁵³, the U.S. Citizen, over which it held control⁵⁴, from which it could demand allegiance⁵⁵, and also, through which it could theoretically⁵⁶ vicariously⁵⁷ serve⁵⁸ the AP. To wit:

In the context of the Originating Documents constituting the united States of America, I, the AP, am Not a U.S. - Citizen or -"person" or -"fiction"⁵⁹, nor can I ever be because I am real⁶⁰, not a fiction. Therefore, the U.S. government having had regulated that the "U.S. Citizen" status be imposed upon all and every man-, woman- and child- American Principal was a perversion⁶¹ of its

- duties...[;] in the nature of *In Re McIntosh*, D.C.Wash., 12 F.Supp. 177; and, "A corporation is a citizen of a state under whose laws it is created and a nonresident of every other state[;] in the nature of *Jackson Securities & Investment Co. v. State*, 241 Ala. 288, 2 S.2d 760, 764; *Black's Law Dictionary*, 4th Ed., p. 310.
- 48 **commercial** means: As relates to commerce, "The exchange of goods, productions, or property of any kind[;] in the nature of *Jeu Jo Wan v. Nagle*, C.C.A.Cal., 9 F.2d 308, 310; "relating to or connected with trade and traffic or commerce in general[;] in the nature of "Zante Currents", C.C.Cal., 73 F. 189; *Black's Law Dictionary*, 4th Ed., pp. 336-337.
- 49 **Authorized Representative** means: "A.R."; "a person, in the nature of UCC 1-201(27), empowered to act for another, including an agent, an officer of a corporation or association, and a trustee, executor, or administrator of an estate[;] in the nature of UCC 1-201(33). To wit: UCC 1-201(27): "Person" means an individual, corporation, business trust, estate, ..., or any other legal or commercial entity; UCC 1-201(33) "Representative" means a person empowered to act for another, including an agent..., and a trustee, excutor., or an administrator of an estate.
- 50 **U.S. Constitution** means: the commercial United States Constitution (~1871) as opposed to "The Constitution for the United States of America" of the Originating Documents of the Nation states of the united States of America (1787).
- 51 **realize** means: having acquired "gain by any means, usually by one's own exertions; to get as one's own; to obtain by search, endeavor, practice, or purchase; receive or gain in whatever manner; come to have[;] in the nature of *Clamo v. Gamble-Robinson Co.*, 190 Minn. 256, 251 N.W. 268, 269; *Black's Law Dictionary*, 4th Ed., p. 41.
- 52 **possessing** means: the process of "[t]he detention and control, or the manual or ideal custody, of anything which may be the subject of property, for one's use and enjoyment, either as owner or as the proprietor of a qualified right in ti, and either held personally or by another who exercises it in one's place and name. ...[;] in the nature of *Starits v. Avery*, 204 Iowa 401, 213 N.W. 769, 771; *Schenk v. State*, 106 Tex.Cr.R. 564, 293, S.W. 1101, 1102; *State v. Compton*, Mo.App., 297 S.W. 413, 414; *Nevin v. Louisville Trust Co.*, 258 Ky. 187, 79 S.W.2d 688, 689; *Black's Law Dictionary*, 4th Ed., p. 1325.
- 53 **persona** means: A character: a "[c]lass or division to which claim belongs," in the nature of *Jackson State Nat. Bank of Jackson, Miss. v. Merchants' Bank & Trust Co. of Jackson, Miss.*, 177 La. 975, 149 So. 539, 294, "in virtue of which certain rights belong to a [commercial construct] and certain duties are imposed upon him. Thus one [commereial construct] may unite many characters, (*personae*,) as, for example, the characters of father and son, of master and seryant, [of Man and U.S. Citizen:] in the nature of *Mackeld.Rom.Law*, § 129; *Black's Law Dictionary*, 4th Ed., pp. 294, 1300.
- 54 **control** means: "Power or authority to manage, direct, superintend, restrict, regulate, direct, govern, administer, or oversee[;] in the nature of *Owen v Trail*, 302 Mo. 292, 258 S.W. 699, 702; *Hopkins v. Howard's Ex'x*, 266 Ky. 685, 99 S.W.2d 810, 812; *Black's Law Dictionary*, 4th Ed., p. 399.
- 55 **allegiance** means: Fealty "[o]bligation of faithfulness and loyalty"- "to the feudal lord ... upon the vassal by

Notice and Demand: Darrell- James: Hill

5 Of 17

2022-011769 MISC Page: 722 of 2782
09/26/2022 03:35:37 PM Receipt #: 22-9381
Rec Fee: \$30.00 Darrell James Hill
Gila County, Az, Sadie Jo Bingham, Recorder

723

2017-002378 MISC Page: 113 of 693
03/10/2017 12:35:10 PM Receipt #: 17-1634
Rec Fee: \$250.00 Darrell- James: Hill
Gila County, Az, Sadie Jo Bingham, Recorder

109

**AFFIDAVIT: Superior Constructive Notice and Demand:
Permanent Non-Commercial Presumption**

fiduciary⁶² duty⁶³ under the Originating Documents constituting the united States of America; thus,

The AP is due all of the Constitutional considerations of the natural rights⁶⁴ from Almighty- God under the protection⁶⁵ by the U.S. government on any and every level under the Originating Documents constituting the united States of America; while, A U.S. Citizen is due only the limits of statutory⁶⁶- or civil-rights⁶⁷ from the U.S. government under the protection by the U.S. government as the U.S. government may variably⁶⁸

which he was bound"[.] in the nature of De Peyster v. Michael, 6 N.U. 497, 57 AmDec. 470; Littleton §§ 117, 131, et seq.; Black's Law Dictionary, 4th Ed., pp. 739,- "to [the U.S.] government in consideration for protection that government gives[.];" in the nature of U.S. v. Kuhn, D.C.N.Y., 49 F.Supp. 407, 414; Black's Law Dictionary, 4th Ed., pp. 99.

56 theoretically means: the theory of case: by which the "[f]acts on which the rights of action is claimed to exist[.] in the nature of Pittsburgh, C., C. and St. L. Ry. Co. v. Rogers, 45 Ind.App. 230, 87 N.E. 28, 31; Black's Law Dictionary, 4th Ed., p. 1649.

57 vicariously means: actively "taking the place of another person or thing; acting or serving as a substitute." - The Random House Dictionary OTEL (1971), p1590.

58 serve means: The acts of a servant, "one employed to perform service in [the] master's affairs, whose physical conduct in performance of the service is controlled or is subject to right to control by the master[.] in the nature of Brenner v. Socony Vacuum Oil Co., 236 Mo.App. 524, 158 S.W.2d 171, 174, 175; Reiling v. Missouri Ins. Co., 236 Mo.App. 164, 153 S.W.2d 79; Black's Law Dictionary, 4th Ed., p. 1533.

59 fiction means: "An assumption or supposition of law that something which is or may be false is true, or that a state of facts exists which has never really taken place[.] in the nature of New Hampshire Strafford Bank v. Cornell, 2 N.H. 324; Hibberd v. Smith, 67 Cal. 547, 4 P. 473, 56 Am.Rep. 726, et seq.; Black's Law Dictionary, 4th Ed., p. 751.

60 real means: Not fiction; "existing or occurring as fact; actual rather than imaginary, ideal or fictitious; being an actual thing; having objective existence; not imaginary;" The Random House Dictionary OTEL (1971), p1196.

61 perversion means: in a perverse manner: "willfully determined or disposed to go counter to what is expected or desired;" a violation of normal; negligence. The Random House Dictionary OTEL (1971), p. 1076.

62 fiduciary means: A duty "holding the character of a trustee, or a character analogous to that of a trustee [capacity], in respect to the trust and confidence involved in it and the scrupulous good faith and candor which it requires[.] in the nature of Svanoe v. Jurgens, 144 Ill. 507, 33 N.E. 955; Stoll v. King, 8 How.Prac., N.Y., 299; Black's Law Dictionary, 4th Ed., p. 753.

63 duty means: legal duty "An obligation arising from contract of the parties or the operation of the law[.] in the nature of Riddell v. Ventilating Co., 27 Mont. 44, 69 P. 241; That which the law requires to be done or forborne to a determinate [private or public] person or the [people or] public at large, correlative to a vested and coextensive right in such [a private or public] person or the [people or] public, and the breach of which constitutes negligence[.] in the nature of Railroad Co. v. Balentine, C.C.A.III., 84 F. 935, 28 C.C.A. 572; Toadvine v. Cincinnati, N. O. & T. p. Ry. Co., D.C.Ky., 20 F.Supp. 226, 227; Black's Law Dictionary, 4th Ed., p. 1039.

64 rights means: "... [A] power, privilege, faculty, or demand, inherent in one [a private or public] person"..."[.] in the nature of Holl. Jur. 69; Black's Law Dictionary, 4th Ed., p. 1486.

65 protection means: the condition of to protect: "to defend or guard from attack, invasion, loss, annoyance, insult, etc.; cover or shield from injury or danger." The Random House Dictionary OTEL (1971), p. 1155.

Notice and Demand: Darrell- James: Hill

6 Of 17

2022-011769 MISC Page: 723 of 2782
09/26/2022 03:35:37 PM Receipt #: 22-9381
Rec Fee: \$30.00 Darrell James Hill
Gila County, AZ, Sadie Jo Bingham, Recorder

2017-002378 MISC Page: 114 of 693
03/10/2017 12:35:10 PM Receipt #: 17-1634
Rec Fee: \$250.00 Darrell- James: Hill
Gila County, Az, Sadie Jo Bingham, Recorder

110

**AFFIDAVIT: Superior Constructive Notice and Demand:
Permanent Non-Commercial Presumption**

sees- fit⁶⁹ under its private commercial constitution, the "U.S. Constitution".

Therefore, it is my observation that in the U.S. government's aiding⁷⁰ or abetting⁷¹ any man-, woman-, or child- American Principal to ignorantly believe and thereupon act in any way to their distinct disadvantage is willful-fraud⁷² and a clear perversion of the U.S. governmental-fiduciary duty under the Originating Documents constituting the united States of America.

American Principal Dis-/Enfranchisement: Uniform Commercial Code

Under the Uniform Commercial Code⁷³, "UCC", law⁷⁴ used for the systematic⁷⁵ implementation⁷⁶ of the U.S. Citizen presumption scheme⁷⁷ upon the AP, I, must frequently and

- 66 **statutory** means: relating to statute: "An act of the legislature declaring, commanding, or prohibiting something; a particular law enacted and established by the will of the legislative department of government; the written will of the legislature, solemnly expressed according to the forms necessary to constitute it [as] the law of the state[;] in the nature of Federal Trust Co. v. East Hartford Fire Dist., C.C.A.Conn., 283 F. 95, 98, et seq.; Black's Law Dictionary, 4th Ed., p. 1581.
- 67 **civil rights** means: Rights by statute: a license or permission or authority to do or not do something enabled by "an act of the legislature declaring, commanding, or prohibiting something; a particular law enacted and established by the will of the legislative department of government; ...[;] in the nature of Federal Trust Co. v. East Hartford Fire Dist., C.C.A.Conn., 283 F. 95, 98, et seq.; Black's Law Dictionary, 4th Ed., p. 1581.
- 68 **variably** means: Characterized by variation: the act, process, or accident of varying in condition, character or degree. The Random House Dictionary OTEL (1971), p. 1581.
- 69 **sees fit** means: to act in the discretion of policy: "The general principles by which a government is guided in its management of public affairs, or the legislature in its measures. The term, as applied to law, ordinance, or rule of law, denotes its general purpose or tendency considered as directed to the welfare or prosperity of the state or community[;] in the nature of the term Policy[;] Black's Law Dictionary, 4th Ed., p. 1317.
- 70 **aiding** means: "To support, help, assist, or strengthen[;] in the nature of Hines v. State, 16 Ga.App. 411, 85 S.E. 452, 454; Black's Law Dictionary, 4th Ed., p. 91.
- 71 **abetting** means: To abet: "To encourage, incite, or set another on to commit a crime. This Word is always applied to aiding the commission of a crime. To abet another to commit [a crime] is to command, procure, or counsel him to commit it, in the nature of Old Nat Brev. 21; Co. Litt. 475; Black's Law Dictionary, 4th Ed., p. 17.
- 72 **willful fraud** means: "An intentional perversion of truth for the purpose of inducing another in reliance upon it to part with some valuable thing belonging to him or to surrender a [] right; a false representation of a matter of fact, whether by words or by conduct, by false or misleading allegations, or by concealment of that which should have been disclosed, which deceives and is intended to deceive another so that he shall act upon it to his [] injury[;] in the nature of Bainerd Dispatch Newspaper Co. v. Crow Wing County, 196 Minn. 194, 264 N.W. 779, 780; Black's Law Dictionary, 4th Ed., p. 788.
- 73 **Uniform Commercial Code** means: Uniform Laws: "[The] considerable number of laws [that] have been approved by the National Conference of Commissioners on the Uniform State Laws, and many of them have been adopted in one or more jurisdictions in the United States and its possessions...et seq.; in the nature of the term Uniform Laws; Black's Law Dictionary, 4th Ed., p. 1701.
- 74 **law** means: "That which is laid down, ordained, or established. A rule or method according to which phenomena or action co-exist or follow each other...[;] in the nature of Koenig v. Flynn, 258 N.Y. 292, 179 N.E. 705; "[A]n unconstitutional statute is not a law, in the nature of John F. Jelke Co. v. Hill, 208 Wis. 650, 242 N.W. 576, 581, et seq.; Black's Law Dictionary, 4th Ed., p. 1028.
- 75 **systematic** means: characteristic of a system: "Orderly combination or arrangement, as of particulars, parts, or elements into a whole; especially such combination according to some rational principle; any methodic

Notice and Demand: Darrell- James: Hill

7 Of 17

2022-011769 MISC Page: 724 of 2782
09/26/2022 09:35:37 PM Receipt #: 22-9381
Rec Fee: \$30.00 Darrell James Hill
Gila County, Az, Sadie Jo Bingham, Recorder

2017-002378 MISC Page: 115 of 693

03/10/2017 12:35:10 PM Receipt #: 17-1634
Rec Fee: \$250.00 Darrell- James: Hill
Gila County, Az, Sadie Jo Bingham, Recorder



111

1025

**AFFIDAVIT: Superior Constructive Notice and Demand:
Permanent Non-Commercial Presumption**

repetitively assert⁷⁸ in the nature of the UCC the remedy⁷⁹ in UCC 1-308⁸⁰ under the right of UCC 1-103⁸¹ in all and every U.S. governmental commercial encounter, notifying and redirecting every U.S. government construct encountered of my private- AP rights guaranteed protected under the Originating Documents constituting the united States of America by all U.S. governmental police⁸².

Since most American Principals, for their lack of knowledge, are ignorant⁸³ of the truth, facts and concepts mentioned herein, then this lack of knowledge prevents most American Principals from entering knowingly⁸⁴, voluntarily⁸⁵, and intentionally⁸⁶ into a valid contract within any U.S. government construct encounter. And, due to the many decades of the

arrangement of parts[;] in the nature of State v. Kistler, 119 Neb. 89, 227 N.W. 319, 320; Black's Law Dictionary, 4th Ed., p. 1621.

76 implementation means: proceedings to implement: "to fulfill; perform; carry out; to put into effect according to or by means of a definite plan or procedure. The Random House Dictionary OTEL (1971), p 715.

77 scheme means: "A design or plan formed to accomplish some purpose - a system[;]" in the nature of Snider v. Leatherwood, TexCiv.App., 49, S.W.2d 1107, 1110; Black's Law Dictionary, 4th Ed., p. 1511.

78 assert means: "To state as true; declare; maintain. To assert against another has probably a *prima facie* meaning of a contradiction of him, but the context or circumstances may show that it connotes a criminatory charge; in the nature of 7 L.J.Ex. 268; Black's Law Dictionary, 4th Ed., p. 149.

79 remedy means: "The means by which a right is enforced or the violation of a right is prevented, redressed, or compensated. ...; in the nature of Sweet. Berry v. M. F. Donovan & Sons, 120 Me. 457, 115 A. 250, 252, 25 S.L.R. 1021, et seq.. Strictly speaking, "remedy" is not part of [an] action, but is the result thereof, the object for which [an] action is presented, the end to which all the litigation is directed[;] in the nature of Mathews v. Sniggs, 75 Okl. 108, 182 P. 703, 707; Black's Law Dictionary, 4th Ed., p. 1457.

80 UCC 1-308 means: "Performance or Acceptance Under Reservation of Rights. (a) A party that with explicit reservation of rights performs or promises performance or assents to performance in a manner demanded or offered by the other party does not thereby prejudice the rights reserved. Such words as "without prejudice," "under protest," or the like are sufficient. (b) Subsection (a) does not apply to an accord and satisfaction." Legal Information Institute; <https://www.lawcornell.edu/ucc/1/1-308>

81 UCC 1-103 means: "Construction of Uniform Commercial Code to Promote its Purposes and Policies: Applicability of Supplement Principles of Law. (a) The [UCC] must be liberally construed and applied to promote its underlying purposes and policies, which are: (1) to simplify, clarify, and modernize the law governing commercial transactions; (2) to permit the continued expansion of commercial practices through custom, usage, and agreement of the parties; and (3) to make uniform the law among the various jurisdictions. (b) Unless displaced by the particular provisions of the [UCC], the principles of law and equity, including the law merchant and the law relative to capacity to contract, principal and agent, estoppel, fraud, misrepresentation, duress, coercion, mistake, bankruptcy, and other validating or invalidating cause supplement its provisions. Legal Information Institute; <https://www.lawcornell.edu/ucc/1/1-103>

82 police means: A policy officer; Generally, "[A] function ... of the administrative machinery of government [for] the preservation of public order[,] and issuing complaints for violations of [commercial] crimes [against the public order;]" in the nature of State v. Hine, 59 Conn. 50, 21 A. 1024, 10 L.R.A. 83; et seq.; Black's Law Dictionary, 4th Ed., p. 1316.

83 ignorant means: Lack of knowledge.

84 knowingly means: With knowledge: "Acquaintance with fact or truth," in the nature of United States Fire Ins. Co. v. Smith, 231 Ala. 169, 164 So. 70, 82, 103 A.L.R. 1468; People v. Henry, 23 Cal.App.2d 155, 72 P.2d 915, 921; Black's Law Dictionary, 4th Ed., p. 1012.

Notice and Demand: Darrell- James: Hill

8 Of 17

2022-011769 MISC Page: 725 of 2782

09/26/2022 03:35:37 PM Receipt #: 22-9381

Rec Fee: \$30.00 Darrell James Hill

Gila County, Az, Sadie Jo Bingham, Recorder

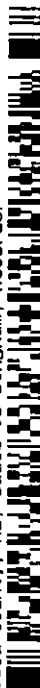

2017-002378 MISC Page: 116 of 693

03/10/2017 12:35:10 PM Receipt #: 17-1634

Rec Fee: \$250.00 Darrell- James: Hill

Gila County, Az, Sadie Jo Bingham, Recorder



112

**AFFIDAVIT: Superior Constructive Notice and Demand:
Permanent Non-Commercial Presumption**

categorical⁸⁷ suppression⁸⁸ of all truth concerning the AP sovereign responsibility, hundreds of millions of men-, women- and children- American Principal's have suffered and continue to blindly presume themselves to be fictions, to be U.S. Citizens; they, therefore, individually and collectively, unwittingly and unintentionally corroborate the abolition⁸⁹ of their natural rights given them from Almighty God.

Therefore, the proactive fiduciary protection actions for all American Principals have been technically abandoned by the U.S. government in preference for its U.S. Citizen sub-type – person that it controls; and, all hope of proactive protective action from the U.S. government is a choice in the nature of the UCC sections indicated above that every every man-, women- and child- American Principal must frequently and repetitively assert in all U.S. government encounters to stand in their sovereignty⁹⁰ under the original basis of Law of the Originating Documents constituting the union of the States of America.

The U.S. Citizen Profit Center: American Principal

Thus, the targeting⁹¹ of the "American Principals" as presumed "U.S. Citizens" has become a lucrative, for-profit⁹², commercial enterprise⁹³ amassing⁹⁴ millions upon millions of

- 85 voluntarily means: Descriptive of voluntary; "Unconstrained by by interference; unimpelled by another's influence;" et seq.; in the nature of Coker v. State, 199 Ga 20, 33 S.E.2d 171, 174; Black's Law Dictionary, 4th Ed., p. 1746.
- 86 intentionally means: Descriptive of intention: "Determination to act in a certain way or to do a certain thing[;] in the nature of State ex rel. Verbon v. County of St. Louis, 216 Minn. 140, 12 N.W.2d 193, 196; et seq.; Black's Law Dictionary, 4th Ed., p. 948.
- 87 categorical means: "absolute; unqualified and unconditional." The Random House Dictionary OTEL (1971), p 233.
- 88 suppression means: Condition to suppress: "To put a stop to a thing actually existing; to prohibit, put down, to prevent, subdue, or end by force[;] in the nature of State v. Mustachia, 152 La. 821, 94 So. 408, 409; State ex rel. Hamilton v. Martin, 173 Wash. 249, 23 P.2d 1; Black's Law Dictionary, 4th Ed., p. 1609.
- 89 abolition means: "The destruction, annihilation, abrogation, or extinguishment of anything[;] in the nature of Peterson v. Pratt, 183 Iowa 462, 167 N.W. 101; Black's Law Dictionary, 4th Ed., p. 20.
- 90 sovereignty means: The authorization of government, originating with the Almighty God given stewardship to man, and derived from man by consent unto the limitations in the Originating covenant(s) into the/a utility of a man's government: to wit, sovereign is man's government under man, and sovereign is man under Almighty God.
- 91 targeting means: Process of pursuing a target: "an object of abuse, scorn, derision, etc.;" butt. The Random House Dictionary OTEL (1971), p. 1454.
- 92 for profit means: For commercial gain.
- 93 enterprise means: "A project or undertaking[;] in the nature of Sizemore v. Hall, 148 Kan. 233, 80 P.2d 1092, 1095; Black's Law Dictionary, 4th Ed., p. 625.
- 94 amassing means: to Amass: "to collect into a mass or pile; accumulate; gather[.]" The Random House Dictionary OTEL (1971), p. 45.

Notice and Demand: Darrell- James: Hill

9 OF 17

2022-011769 MISC Page: 726 of 2782

09/26/2022 03:35:37 PM Receipt #: 22-9381

Rec Fee: \$30.00 Darrell James Hill

Gila County, Az, Sadie Jo Bingham, Recorder



2017-002378 MISC Page: 117 of 693

03/10/2017 12:35:10 PM Receipt #: 17-1634

Rec Fee: \$250.00 Darrell James Hill

Gila County, Az, Sadie Jo Bingham, Recorder



113

**AFFIDAVIT: Superior Constructive Notice and Demand:
Permanent Non-Commercial Presumption**

Federal Reserve Note⁹⁵, "FRN", dollars⁹⁶ in charges, fees and penalties of all kinds imposed under the U.S. Citizen presumption scheme. The duty of protection from all U.S. government constructs is nearly completely abandoned because, their failure in their duty to protect the men-, women-, and children- American Principals from the actual damages of the systematic U.S. Citizen presumption scheme is extremely lucrative.

Finally, I observe that the systematic imposition of this lucrative scheme in all U.S. government encounters with every man-, woman- and child- American Principal is the most comprehensive direct overt⁹⁷ and covert⁹⁸ abuse of the U.S. government's fiduciary duty ever imposed upon every man-, woman- and child- American Principal, bar none, because, ALL have been enslaved.

Against this, the Remedy and Right for me to resolve this real, ever present and escalating threat to my Almighty God- given rights of life and liberty shall be pursuant to this Notice and Demand prerogative⁹⁹. To this end:

**Under the Originating Documents constituting the united States of America
herein is made Notice upon the U.S. government- Trustee: to wit,
UPON THE RECEIPT OF THIS NOTICE YOU ARE
IMMEDIATELY TO COMPLY.**

NOTICE

1. This document identifies that I, Darrell- James: Hill, A.P., am the beneficiary principal

- 95 Federal Reserve Note means: i) Note: A unilateral instrument containing an express and absolute promise of signer to [discharge a debt] to a specified person or order, or bearer, a definite sum of money at a specified time[;] in the nature of *Shawano Finance Corporation v. Julius*, 214 Wis. 637, 254 N.W. 355; *Black's Law Dictionary*, 4th Ed., p. 1210. ii) Money: "In usual and ordinary acceptation it means: gold, silver, or paper money used as circulating medium of exchange, and does not embrace notes, bonds, evidences of debt, or other personal or real estate[;] in the nature of *Lane v. Railey*, 280 Ky. 319, 133 S.W.2d 74, 79,81; *Black's Law Dictionary*, 4th Ed., p. 625. iii) Federal Reserve: a private, non-monitored, non- U.S. Government, non- taxable, for-profit commercial bank, operating with impunity, so enabled by the U.S. government unto their state financial benefits and interests.
- 96 dollars means: i) Under Constitution of the Originating Documents: One ounce of silver "[T]he unit employed in the United States in calculating money values [on a system] of value of one hundred cents [per one ounce of silver unit;]" in the nature of *People v. Alva*, 46 Cal.App.2d 859, 117 P.2d 63; *Black's Law Dictionary*, 4th Ed., p. 570. ii) Under the U.S. Constitution of the U.S. Government: refers to the private commercial, world-wide FRN fiat note: a credit instrument, based in no inherent redeemable value such as silver or gold; but, based upon the full faith in and credit integrity accorded to the issuers.
- 97 overt means: 'in your face', "Open; manifest; public; issuing in action, as distinguished from that which rests merely in intention or design[;] un the nature of *Commonwealth v. Barnes*, 107 Pa.Super. 46, 162, A. 670, 675; *Black's Law Dictionary*, 4th Ed., p. 1258.
- 98 covert means: hidden. Not overt: to wit: Not open: Not manifest; Not public, etc.
- 99 prerogative means: "... an exclusive right, privilege, etc., exercised by virtue of rank, office or the like; ...a power, immunity, or the like restricted to a sovereign..." *The Random House Dictionary OTEL* (1971), p. 1137.

Notice and Demand: Darrell- James: Hill

10 Of 17

2022-011769 MISC Page: 727 of 2782

09/26/2022 03:35:37 PM Receipt #: 22-9381
Darrell James Hill
Sadie Jo Bingham, Recorder
Gila County, Az.



728

2017-002378 MISC Page: 118 of 693
03/10/2017 12:35:10 PM Receipt #: 17-1634
Req Fee: \$250.00 Darrell- James: Hill
Gila County, Az; Sadie Jo Bingham, Recorder



114

**AFFIDAVIT: Superior Constructive Notice and Demand:
Permanent Non-Commercial Presumption**

superior to the U.S. Government. The U.S. Government is i) the respondeat-superior¹⁰⁰ to the U.S. Government, et al., "U.S. government", and ii) the U.S. government is the AP-Cestui-Que-Trust¹⁰¹ Trustee¹⁰², thus the U.S. -government and Trustee, "U.S. government- Trustee", is under a full dual fiduciary duty to me under the Originating Documents constituting the union of the States of America, and subsequent acts thereunder. To wit: The U.S. Government is the Constitutional servant¹⁰³ of all American Principals and this AP; and, the U.S. Government is the defacto¹⁰⁴ constructive¹⁰⁵ Trustee for the this AP-Cestui-Que-Use¹⁰⁶ for the competent¹⁰⁷ protection of every American Principal's and this AP- beneficiary's¹⁰⁸ property¹⁰⁹ held in the AP Cestui Que Trust by the U.S. government-Trustee.

- 100 **respondeat superior** means: ..." that a master is liable in certain cases for the wrongful acts of his servant, and a principal for those of his agent[;] in the nature of Broom Max 843; Southern Paramount Pictures Co. v. Gaulding, 24 Ga.App. 478, 101 S.E. 311; Delaware, L. & W. R. Co. v. Pittinger, C.C.A.N.J., 293 F. 853, 855; Black's Law Dictionary, 4th Ed., p. 1475.
- 101 **AP Cestui Que Trust** means: The "[AP] who has a right to a beneficial interest in and out of an estate the legal title to which is vested in another[;] in the nature of 2 Washb. Real Prop. 163; Black's Law Dictionary, 4th Ed., p. 289.
- 102 **Trustee** means: "The person appointed, or required by law, to execute a trust; one in whom an estate, interest, or power is vested, under an express or implied agreement to administer or exercise it for the benefit or to the use of another called the cestui que trust[;] in the nature of Pioneer Mining Co. v. Tyberg, C.C.A.Alaska, 215 F. 501, 506, L.R.A.1915B, 442, et seq.; Black's Law Dictionary, 4th Ed., p. 1684.
- 103 **servant** means: One who serves.
- 104 **defacto** means: in context under the Originating Documents unto and into the present form of U.S. Government, "in fact; actually; indeed; in reality[;] in the nature of Ridout v. State, 161 Tenn. 248, 30 S.W.2d 255, 257, 71 A.L.R. 830; Black's Law Dictionary, 4th Ed., p. 504.
- 105 **constructive** means: "That which is established by the mind of the law in its act of *construing* facts, conduct, circumstances, or instruments; that which has not the character assigned to in its own essential nature, but acquires such character in consequence of the way in which it is regarded by a rule or policy of law; hence, inferred, implied, made out by legal interpretation; the word "legal" being sometimes used in lieu of "Constructive[;]" in the nature of Middleton v Parke, 2 App.D.C. 160; Black's Law Dictionary, 4th Ed., p. 386.
- 106 **AP Cestui Que Use** means: "He for whose use and benefit lands or tenements are held by another. The *cestui que use* has the right to receive the profits and benefits of the estate, but the legal title and possession (as well as the duty of defending the same) reside in the other[;] in the nature 2 Bla.Comm. 330; 2 Washib. Real Prop. 95; Black's Law Dictionary, 4th Ed., p. 289.
- 107 **competent** means: "duly qualified; answering all requirements; having sufficient ability or authority; possessing the requisite natural or legal qualifications; able; adequate; suitable; sufficient; capable; legally fit[;] in the nature of Levee Dist. v. Jamison, 176 Mo. 557, 75 S.W. 679, et seq.; Black's Law Dictionary, 4th Ed., p. 355.
- 108 **beneficiary** means: i)The Cestui Que Use: "He for whom use and benefit lands or tenements are held by a [Trustee]. The *cestui que use* has the right to receive the profits and benefits of the estate, but the legal title and possession (as well as the duty of defending the same) reside in the [Trustee;] in the nature of 2 Bla.Comm. 330; 2 Washb.Real Prop. 95; Black's Law Dictionary, 4th Ed., p. 289.
- 109 **property** means: "...[E]verything which is the subject of ownership, corporeal or incorporeal, tangible or intangible, visible or invisible, real or personal; everything that has an exchangeable value or which goes to make up wealth or estate. It extends to every species of valuable right and interest, and includes real and personal property, easements, franchises, and incorporeal hereditaments[;] in the nature of Samet v. Farmers' &

Notice and Demand: Darrell- James: Hill

11 Of 17

2022-011769 MISC Page: 728 of 2782
09/26/2022 03:35:37 PM Receipt #: 22-9381

Rec Fee: \$30.00 Darrell James Hill
Gila County, Az, Sadie Jo Bingham, Recorder



2017-002378 MISC Page: 119 of 693

03/10/2017 12:35:10 PM Receipt #: 17-1634
Rec Fee: \$250.00 Darrell-James: Hill
Gila County, Az, Sadie Jo Bingham, Recorder

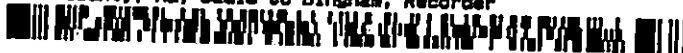

115

729

**AFFIDAVIT: Superior Constructive Notice and Demand:
Permanent Non-Commercial Presumption**

2. This Notice and Demand is promulgated¹¹⁰ to identify, mention, establish and consider, reason the situation, and authenticate¹¹¹ this Sovereign Order¹¹² of NOTICE AND DEMAND for the setting of the permanent presumption of AP in every encounter and consideration this AP: to wit: 'AP, A.R. of the juxtaposed U.S. Citizen commercial construct, in the nature of UCC 1-308 and UCC 1-103, in all and any U.S. government-Trustee databases¹¹³, also including U.S. government-Trustee's proxy databases.'

3. I make Notice to the U.S. government-Trustee that my inalienable¹¹⁴ and sovereign rights are from the Almighty God to me, a man of the people, a private-person, and the beneficiary of the AP Cestui Que Trust, of the public trusts of the peoples of the united States of America; and that:

3.i. There is No-one and No-thing between the Almighty God and me: Darrell- James: Hill;

3.ii Below and beneath me, the sovereign AP- beneficiary, is the united States of America territory¹¹⁵ and any commercial or other construct is under, below and beneath of the sovereign God Almighty and man founded;

3.iii Any U.S governmental presumption or mechanism¹¹⁶ to subvert¹¹⁷ this political election and choosing which is under Almighty God is heresy¹¹⁸ in-situate¹¹⁹, and

Merchants' Nat. Bank of Baltimore, C.C.A.Md., 247 F. 669, 671; Globe Indemnity Co. v. Bruce, C.C.A.Okl., 81 F.2d 143, 150; Black's Law Dictionary, 4th Ed., p. 1382.

110 promulgate means: "To publish; to announce officially; to make public as important or obligatory[;]" in the nature of Price v. Supreme Home of the Ancient Order of Pilgrims, Tex.Com.App., 285 S.W. 310, 312; Black's Law Dictionary, 4th Ed., p. 1380.

111 authenticate means: To perform "[t]he act or mode of giving authority or legal authenticity to a statute, record, or other written instrument, or a certified copy thereof, so as to render it legally admissible in evidence[;]" in the nature of Voloshin v. Ridenour, C.C.A.CanalZone, 299 F. 134, Verifications of judgments, Collette v. Hanson, 174 A. 466, 133 Me. 146; Black's Law Dictionary, 4th Ed., p. 168.

112 order means: "A mandate, precept; a command or direction authoritatively given; a rule or regulation[;]" in the nature of Brady v. Interstate Commerce Commission, D.C. W.Va., 43 F.2d 847, 850; Black's Law Dictionary, 4th Ed., p. 1247.

113 database means: any datum, and all data sought, obtained, accumulated, stored, and retrievable information related to this Man, or any other data any other way touching upon this Man's history, present and future.

114 inalienable means: Those things given from Almighty God which are non-constrainable and given without respect of person: to wit: "Not subject to alienation; the characteristic of those things which cannot be bought or sold or transferred from one person to another." in the nature of God given; Black's Law Dictionary, 4th Ed., p. 903.

115 territory means: "any tract of land; region or district" The Random House Dictionary OTEL (1971), p. 1466.

116 mechanism means: "the structure or arrangement of parts of a machine or similar device, or of anything analogous." The Random House Dictionary OTEL (1971), p. 889.

117 subvert means: "to undermine the principles of; corrupt." The Random House Dictionary OTEL (1971), p. 1419.

118 heresy means: The expressions of a heretic: "a professed believer [in Almighty God] who maintains [and expresses doctrinal beliefs and] opinions contrary to" and rejects those given by Almighty God. The Random House Dictionary OTEL (1971), p. 664.

Notice and Demand: Darrell- James: Hill

12 Of 17

2022-011769 MISC Page: 729 of 2782

09/26/2022 03:35:37 PM Receipt #: 22-9381

Rec Fee: \$30.00 Darrell- James: Hill

Gila County, Az, Sadie Jo Bingham, Recorder



730

2017-002378 MISC Page: 120 of 693

03/10/2017 12:35:10 PM Receipt #: 17-1634

Rec Fee: \$250.00 Darrell- James: Hill

Gila County, Az, Sadie Jo Bingham, Recorder



116

**AFFIDAVIT: Superior Constructive Notice and Demand:
Permanent Non-Commercial Presumption**

which is under the AP- beneficiary insubordinate¹²⁰, and which is under Constitutional-Law¹²¹ willful-fraud and malfeasance¹²² of fiduciary duty upon its face¹²³;

- 3.iv The U.S. Government in situate is: a) the defacto respondeat superior Trustee in service to the American beneficiary, Darrell- James: Hill, under the Originating Documents; and, b) responsible to protect this beneficiary in all actions concerning his property in any asset as AP's election is Made. My preference is explicitly expressed and herein presented.

Therefore, the **Remedy and Right** for me to resolve this real, ever present and escalating threat to my Almighty God- given rights of life and liberty shall be pursuant to this Notice and Demand Order

. To this end:

Under the Originating Documents constituting the united States of America herein is made Demand upon the U.S. government- Trustee: to wit, UPON THE RECEIPT OF THIS DEMAND YOU ARE IMMEDIATELY TO COMPLY.

DEMAND

The U.S. government- Trustee shall henceforth know and acknowledge that I am Darrell- James: Hill, the AP- beneficiary of the AP Cestui Que Trust, to wit, I, under Almighty God, am: i) an American National Citizen of the Ohio state of the Nation states of the united States of America, a private person of the people with inalienable rights from Almighty God under the protection of the Originating Documents constituting the united States of America, and thereto under the absolute protection from the U.S. government- Trustee; that, ii) this AP- beneficiary is the Authorized-Representative of the DARRELL JAMES HILL, by the sundry well-known historical documents in the public record including, but not limited to, the CUSIP # 274649172, and DL # D01174172- a document that evidences the photographic likeness of the A.R., all available evidences of the fact; and, that:

119 In situate means: Present, existent in the "[s]tate of being placed; posture[:] in the nature of Jones v. Tuck, 48 N.C. 202, 205; Black's Law Dictionary, 4th Ed., p. 1558.

120 insubordinate means: U.S. governmental disobedience to the constituted authority under the Originating Documents under Man under Almighty God.

121 Constitutional Law means: reference specifically to The Constitution for the United States of America in context to the Originating Documents.

122 malfeasance means: "Evil doing; ill conduct; the commission of some act which is positively unlawful; the doing of an act which is wholly wrongful and unlawful; the doing of an act which [the Trustee] ought not to do at all or the unjust performance of some act which [the Trustee] had no right or which he had contracted not to do... [:] in the nature of State ex rel. Knabb v Frater, 198 Wash. 675, 89 P.2d 1046, 1048; Black's Law Dictionary, 4th Ed., p. 1109.

123 face means: overt; openly obvious and present.

Notice and Demand: Darrell- James: Hill

13 Of 17

2022-011769 MISC Page: 730 of 2782
09/26/2022 03:35:37 PM Receipt #: 22-9381
Rec Fee: \$30.00 Darrell James Hill
Gila County, Az. Sadie Jo Bingham, Recorder



731

2017-002378 MISC Page: 121 of 693

03/10/2017 12:35:10 PM Receipt #: 17-1634
Rec Fee: \$290.00 Darrell- James: Hill
Gila County, Az. Sadie Jo Bingham, Recorder



117

**AFFIDAVIT: Superior Constructive Notice and Demand:
Permanent Non-Commercial Presumption**

- I. In any condition, including, but not limited to, martial rule¹²⁴ and/or martial law¹²⁵, the U.S. government- Trustee shall maintain its Constitutional and fiduciary duty under Almighty God to this AP, Darrell- James: Hill, under the Originating Documents constituting the united States of America: to wit, that:
- I.a. In any condition this AP, Darrell- James: Hill, is Not ever to be presumed to be the commercial construct, U.S. Citizen DARRELL JAMES HILL, nor presumed to stand in surety¹²⁶ for the commercial construct DARRELL JAMES HILL, U.S. Citizen;
- I.b. In any and every condition wherever this AP, Darrell- James: Hill, is traveling¹²⁷/ is sojourning¹²⁸/ is inhabiting¹²⁹, by any and every means this AP shall be presumed as within his rights inalienable from Almighty God, and the same right(s) which are under the Originating Documents constituting the united States of America by duty protected by the U.S. government- Trustee;
- I.c. This election and setting of the permanent presumption by this AP- beneficiary denies¹³⁰ and declines¹³¹ any pretext¹³² of the presumption of rightful duty or authorization, et seq., to stalk¹³³, record¹³⁴ in any and every form, type or method,

- 124 martial rule means: i) martial: "Inclined or disposed to war, warlike;... pertaining to or connected with the army and navy." The Random House Dictionary OTEL (1971), p. 880. ii) rule: a principle or regulation governing conduct, action, procedure, arrangement, etc.. The Random House Dictionary OTEL (1971), p. 1252.
- 125 martial law means: An extreme form of social crisis control measure when the "military authorities carry on [the] government or exercise [under Constitutional precepts] various degrees of control over [the] civilians or civilian authorities in [a] domestic territory[:]; in the nature of Ochikubo v. Bonesteel, D.C.Cal., 60 F.Supp. 916, 928, 929, 930; Black's Law Dictionary, 4th Ed., p. 1126.
- 126 surety means: "One [who is] bound with his principal for the payment of a sum or money or for the performance of some duty or promise and who is entitled to be indemnified by some one who ought to have paid or performed if payment or performance be enforced against him[:]; in the nature of Anderson v. Trueman, 100 Fla. 727, 130 So. 12, 13; Black's Law Dictionary, 4th Ed., p. 1621.
- 127 traveling means: an Almighty God given Constitutionally protected right pass place to place on the earth.
- 128 sojourning means: an Almighty God given Constitutionally protected right to live in this time transiently on earth.
- 129 inhabiting means: an Almighty God given Constitutionally protected right to live, stay, rest, dwell at on the earth.
- 130 denies means: "to refuse to agree or accede to..." The Random House Dictionary OTEL (1971), p. 387.
- 131 decline means: "to withhold or deny consent to do, enter into or upon, etc.; refuse" The Random House Dictionary OTEL (1971), p. 375.
- 132 pretext means: 'an outwardly appearing reason or motive i) imposed upon or over another or ii) pretended under the appearance of a legal reason or for the cover of no legal reason or probable cause; false appearance, pretense[:];' in the nature of State v. Ball, 27 Neb. 604, 43 N.W. 398; Black's Law Dictionary, 4th Ed., p. 1351.
- 133 stalk means: "to pursue or approach quarry." The Random House Dictionary OTEL (1971), p. 1384.
- 134 record means: "to set down [in any data form], as for the purpose of preserving evidence" The Random House Dictionary OTEL (1971), p. 1200.

Notice and Demand: Darrell- James: Hill

14 Of 17

2022-011769 MISC Page: 731 of 2782
09/26/2022 03:36:37 PM Receipt #: 22-9381
Rec Fee: \$30.00 Darrell James Hill
Gila County, Az, Sadie Jo Bingham, Recorder

2017-002378 MISC Page: 122 of 693
03/10/2017 12:35:10 PM Receipt #: 17-1634
Rec Fee: \$250.00 Darrell- James: Hill
Gila County, Az, Sadie Jo Bingham, Recorder

118

**AFFIDAVIT: Superior Constructive Notice and Demand:
Permanent Non-Commercial Presumption**

including, but not limited to, DNA¹³⁵ and neurological-characteristics¹³⁶: to wit:

- I.c.i. Any possessed authorization in any form of authorization, et seq., to monitor, record in any and every form, type or method, including, but not limited to, DNA and neurological-characteristics, is rescinded¹³⁷;
- I.c.ii. Any future authorization in any form of authorization, et seq., to monitor, record in any and every form, type or method, and/including, but not limited to, DNA and neurological-characteristics, must be authorized without duress or deception;
- I.c.iii. Any and all U.S. government- Trustee encounters in any form shall refer to this private AP- beneficiary, Darrell- James: Hill, due all of their duty in respect and forceful protections in the full from the U.S. government- Trustee;
- I.c.iv. All presumable searches of commercial construct, DARRELL JAMES HILL, and/or of the AP- beneficiary, A.R., in/by any variation by any U.S. government-Trustee shall henceforth permanently refer to the AP- beneficiary presumption of the private AP, A.R to the U.S. governmental U.S. Citizen; to wit: Darrell- James: Hill, A.R. of the U.S. commercial construct DARRELL JAMES HILL.
- I.c.v. Denied/ declined is any presumption of permission for the U.S. government-Trustee to survey/ invade with any object/ technology for any covert or overt purpose or other reason any airspace over any area territory inhabited by this AP- beneficiary without of the U.S. government- Trustee's express permission from the AP- beneficiary herenow to only perform any duty and obligations in the strict-protection of this AP- beneficiary within the limitation of the Originating Documents constituting the united States of America;
- I.c.vi. Denied/ declined is any presumption of permission for the U.S. government-Trustee to dispose any chemical and/or variant of technology into the airspace, or upon or into this AP- beneficiary Darrell- James: Hill by any method or action without of the U.S. government- Trustee's express permission from the AP- beneficiary herenow to perform the any duty and obligations in the strict protection of the AP- beneficiary within the confines of the Originating Documents for the united States of America;
- I.c.vii. Denied/ declined is any presumption of permission for the U.S. government-

135 DNA means: 'deoxyribonucleic acid: the class of found chiefly in the nucleus of cells, and that function int the transference of genetic instructions and characteristics, and synthesis of protein.' The Random House Dictionary OTEL (1971), p. 421.

136 neurological characteristics means: i) neurological: having to do with neuroanatomy: "the nerve structure of man..., or of any parts of the organism." The Random House Dictionary OTEL (1971), p. 960.

137 rescinded means: rescind: "To abrogate, annul, avoid, or cancel a contract; particularly, nullifying a contract by the act of a party[;] in the nature of Vaughn v. Fey, 47 Cal.App. 485, 190 P. 1041, 1042, et seq.; Black's Law Dictionary, 4th Ed., p. 1471.

Notice and Demand: Darrell- James: Hill

15 Of 17

733

2017-002378 MISC Page: 123 of 693
03/10/2017 12:35:10 PM Receipt #: 17-1634
Rec Fee: \$250.00 Darrell- James: Hill
Gila County, Az, Sadie Jo Bingham, Recorder

2022-011769 MISC Page: 732 of 2782

09/26/2022 03:35:37 PM Receipt #: 22-9381

Darrell James Hill

Gila County, Az, Sadie Jo Bingham, Recorder

119

**AFFIDAVIT: Superior Constructive Notice and Demand:
Permanent Non-Commercial Presumption**

Trustee to surveil/ invade any land area inhabited by the AP- beneficiary, or to enter upon or under into the land or habitat area of this AP- beneficiary by any method or action without of the U.S. government- Trustee's express permission from the AP- beneficiary herenow to only perform the any duty and obligation in the strict protection of the AP- beneficiary within the confines of the Originating Documents constituting the united States of America;

I.c.viii. Denied/ declined is any presumption of permission for the U.S. government-Trustee to impose any hardship disaffecting by any means, process or proxy the inalienable rights to the clear and undisturbed enjoyment by this AP- beneficiary in/about his any habitation.

I.c.ix. Denied/ declined is any presumption of permission for the U.S. government-Trustee to impose any hardship by any method or action disaffecting the inalienable rights of unfettered and unimpeded travel by this AP- beneficiary without of the express permission from the AP- beneficiary herenow to only perform the any duty and obligation in the strict protection of the AP- beneficiary within the confines of the Originating Documents constituting the united States of America.

PENALTY FOR VIOLATIONS

Violation¹³⁸ of this sovereign Notice and Demand constitutes the common-law corpus-delecti¹³⁹ under the Originating Documents constituting the united States of America with the presumption of criminal intent and yielding tacit¹⁴⁰ procuration¹⁴¹ to this AP- beneficiary, his heirs, agents or assigns for to proceed in suit without adversity for the receipt of damages as the primary creditor upon the U.S. government- Trustee and/or the any violator(s) directly committing the damage(s), in both their professional and private persons/statuses upon this schedule:

- i) **First Offense Damages:** inherent value of one thousand one hundred fifty of the one ounce .999 silver dollars of the United States mint per hour of damage and for any part of any hour thereafter, plus any additional damages as the jury/ court may allow;
- ii) **Second Offense Damages:** 100 times of i) First Offense Damages, et seq.;

138 Violation means: The act of violating: "1. to break, infringe, or transgress (a law, rule, duty, agreement, promise, instructions, etc.). 2. to break in upon , or disturb rudely; interfere thoughtlessly with...." The Random House Dictionary OTEL (1971), p. 1594.

139 corpus delecti means: i) corpus: body, literally, or "an aggregate or mass: men, laws, articles; physical substance as distinguished from intellectual conception ...[:]" in the nature of In re Barron's Will, 163 Wis 275, 155 N.W. 1087, 1089, et seq.; ii) corpus delecti means: "The body [substance] of a crime...[:]" Black's Law Dictionary, 4th Ed., p. 1351.

140 tacit means: "Existing, inferred, or understood without being openly expressed or stated[:]" Black's Law Dictionary, 4th Ed., p. 1623.

141 procuration means: "... The act by which one person gives power to another to act in his place, as he could do himself[:]" in the nature of Clinton v. Hibb's Ex'x, 259 S.W. 356, 358, 202 Ky. 304, 35 A. L.R. 462.; Black's Law Dictionary, 4th Ed., p. 1372.

Notice and Demand: Darrell- James: Hill

16 Of 17

2017-002378 MISC Page: 124 of 693

03/10/2017 12:35:10 PM Receipt #: 17-1634
Rec Fee: \$250.00 Darrell- James: Hill

Gila County, Az, Sadie Jo Bingham, Recorder



2022-011769 MISC Page: 733 of 2762

09/26/2022 03:35:37 PM Receipt #: 22-9381
Rec Fee: \$30.00 Darrell James Hill
Gila County, Az, Sadie Jo Bingham, Recorder



120

734

**AFFIDAVIT: Superior Constructive Notice and Demand:
Permanent Non-Commercial Presumption**

iii) Third and Subsequent Offense Damages: 100 times of ii) Second Offense Damages, et seq..

COMPLIANCE

Upon receipt of this Notice and Demand Order you shall have immediately to comply with this Demand. If you do not comply with the Demand within a grace of five days time from after receipt then in so doing you have acquiesced to the Demands herein and by tacit procurement have agreed to and will proactively and efficaciously i) comply with this Demand in total, and ii) pay all costs associated with any and all efforts to enforce any compliance against your, et al.'s, any impedance of this Constructive Notice and Demand, plus damages, including, but not limited to, the "Penalty for Violation: I) First Offense Damages" in damages.

Notice to the Agent is Notice to the Principal
Notice to the Principal is Notice to the Agent

Without Prejudice

Darrell-James: Hill
Darrell- James: Hill

ACKNOWLEDGEMENT

State of Arizona
County of Pinal

On this ___th day of September 2016, before me personally appeared Darrell- James: Hill, whose identity was proven to me on the basis of satisfactory evidence of an State of Arizona Driver License to be the Authorized Representative he claimed to be, and I acknowledge that he signed the above-attached Notice and Demand document.

Notary Public



Notice and Demand: Darrell- James: Hill

17 Of 17

2022-011769 MISC Page: 734 of 2782

09/26/2022 03:35:37 PM Receipt #: 22-9381
Rec Fee: \$30.00 Darrell James Hill
Gila County, Az, Sadie Jo Bingham, Recorder



2017-002378 MISC Page: 125 of 693
03/10/2017 12:35:10 PM Receipt #: 17-1634
Rec Fee: \$250.00 Darrell- James: Hill
Gila County, Az, Sadie Jo Bingham, Recorder



121

735

**AFFIDAVIT: Constructive Notice of "DARRELL JAMES HILL" of
"Darrell- James: of the family Hill", Authorized Representative**

I, DARRELL JAMES HILL, do herein present¹ testimony² and admit³ that I am the en-legis⁴
stramineus homo⁵ commercial⁶ fiction⁷ for the private⁸- person man⁹ Darrell- James: of the family Hill,
"Darrell- James: Hill", who is a distinct private- person of the people¹⁰ of the united States of
America¹¹, an American National¹² Citizen¹³ under Originating Documents constituting the united
States of America; to wit, a beneficiary¹⁴ of the public¹⁵ trust¹⁶ ¹⁷, and thereto and therefrom, the de

- 1 "present" means: Tend. [T]o be directed as to any end, object, or purpose... In the nature of Rogers v. State, 122 Tex.Cr.R. 331, 54 S.W.2d. 1010, 1012. - Black's Law Dictionary, 4th Ed., p. 1637. To wit, all terms are/ will be as determined by the affiant.
- 2 "testimony" means: Evidence given by a competent witness, under oath or affirmation.... In the nature of Edelstein v. United States, 79 C.C.A. 328, 149 F. 636, 640 - Black's Law Dictionary, 4th Ed., p. 1646.
- 3 "admit" means: Admission(s). ... [V]oluntary acknowledgments made by a party of the existence of certain facts. In the nature of Roosevelt v Smith, 40 N.Y.S. 381, 17 Misc. 323. - Black's Law Dictionary, 4th Ed., p. 68.
- 4 "en legis" means: A statutorily created construct/ entity.
- 5 "stramineus homo" means: A man of straw, one of no substance, put forward as bail or surety. In the nature of Black's Law Dictionary, 4th Ed., p. 1590.
- 6 "commercial" means: Relating to or connected with trade and traffic or commerce in general. In the nature of "Zante Currents", C.C.Cal., 73 F. 189. - Black's Law Dictionary, 4th Ed., p. 68.
- 7 "entity" means: An assumption or supposition of law that something which is or may be false is true, or that a state of facts exists which has never really taken place. In the nature of New Hampshire Strafford Bank v. Cornell, 2 N.H. 324; Hibberd v. Smith, 67 Cal. 547, 4 P. 473, 56 Am.Rep. 726; Murphy v. Murphy, 190 Iowa 874, 179 N.W. 530, 533. - Black's Law Dictionary, 4th Ed., p. 751.
- 8 "private" means: Affecting or belonging to private individuals, as distinct from the public generally. Not official; not clothed with office. In the nature of People v. Powell, 280 Mich. 699, 274 N.W. 372, 373; 111 A.L.R. 721. - Black's Law Dictionary, 4th Ed., p. 1358.
- 9 man" means: Earthen born species of man of flesh and blood.
- 10 "people" means: A state; as the people of [a] state. A nation in its collective and political capacity. In the nature of Nesbitt v. Lushington, 4 Term R. 783; U.S. v. Quincy, 6 Pet. 467, 8 L.Ed. 458; U.S. v. Trumbull, D.C.Cal., 48 F. 99. - Black's Law Dictionary, 4th Ed., p. 1292.
- 11 "the united States of America" means: the union of the independent several states of the States of America within the Declaration of Independence. 1776. and further lucidated in The Constitution for the United States of America, 1789, including the Bill of Rights. et. seq., of the republic.
- 12 "national" means: Pertaining to the several independent States of America .
- 13 "Citizen" means: The species of man born on the ground of the independent States of America.
- 14 "beneficiary" means: One for whose benefit a trust is created; a *cestui que trust*. In the nature of 195 N.E. 557, 564; 97 A.L.R. 1170. - Black's Law Dictionary, 4th Ed., p. 199.
- 15 "public" means: Pertaining to a state, nation, or whole community; proceeding from, relating to, or affecting the whole body of people or an entire community. Open to all Common to all or many; general; open to common use. In the nature of Morgan v. Cree, 46 Vt. 786; 14 Am.Rep. 640; Craine v. Waters, C.C.Mass., 10. F. 621. - Black's Law Dictionary, 4th Ed., p. 1393.
- 16 "trust" means: A right of property, real or personal, held by one party for the benefit of another. In the nature of Goodwin v. McMinn, 193 Pa. 646, 44 A. 1094; 74 Am.St.Rep. 703; Boyce v. Mosely, 102 S.C. 361, 86 S.E. 771, 773; King v. Richardson, C.C.A.N.C., 136 F.2d. 849, 856, 857. - Black's Law Dictionary, 4th Ed., p. 1680.
- 17 "public trust" means *cestui que trust(s)* - He who has a right to a beneficial interest in and out of an estate the legal title to which is vested in another. In the nature of 2 Washib. Real Prop. 163. - Black's Law Dictionary, 4th Ed., p. 289. To

Affidavit of DARRELL JAMES HILL Commercial Status

1 OF 2

2017-002378 MISC Page: 126 of 693

03/10/2017 12:35:10 PM Receipt #: 17-1634
Rec Fee: \$250.00 Darrell- James: Hill
Gila County, Az, Sadie Jo Bingham, Recorder



2022-011769 MISC Page: 735 of 2782

09/26/2022 03:35:37 PM Receipt #: 22-9381
Rec Fee: \$90.00 Darrell James Hill
Gila County, Az, Sadie Jo Bingham, Recorder



122

736

AFFIDAVIT: Constructive Notice of "DARRELL JAMES HILL" of "Darrell- James: of the family Hill", Authorized Representative

jure¹⁸ Authorized¹⁹, Representative^{20 21}, "A.R.", of my commercial stramineus homo being known as DARRELL JAMES HILL, including in all spellings, forms or abbreviations however constituted referring to my commercial entity, except that of the natural- man: "Darrell- James: of the family Hill", Darrell- James: Hill.

Without Prejudice, UCC 1-308
DARRELL JAMES HILL

Darrell- James: Hill, A.R.
Darrell- James: Hill, A.R.

Jurat

State of Arizona
County of Pinal

Sworn and signed before me this ___th day of September 2016.



Notary



2022-011769 MISC Page: 736 of 2782
09/26/2022 03:35:37 PM Receipt #: 22-9381
Rec Fee: \$30.00 Darrell James Hill
Gila County, Az. Sadie Jo Bingham, Recorder

wit: the amalgam of Trading With The Enemy Act: Public Law No. 65-91; with, the Emergency Banking Act of March 9, 1933; the clandestine achievement of concomitant sequestration of all available private titles of the American people, the progressive implementation of the system of the systematic garner of all subsequent titles from the American people, and, therefrom, the development and imposition of a socialist state politic by the commercial government upon an ignorant and unsuspecting American people.

- 18 "de jure" means: Of right; legitimate; lawful; by right and just title. In the nature of "de jure", Black's Law Dictionary, 4th Ed., p. 481.
- 19 "authorized" means: [Clothed] with ... legal power. In the nature of Arkansas & Memphis Ry. Bridge & Terminal Co. v. State, 174 Ark. 420, 295 S.W. 378, 380. - Black's Law Dictionary, 4th Ed., p. 169.
- 20 "representation" means: One who represents or stands in the place of another. In the nature of Lee v. Dill, 39 Barb. (N.Y.) 520; Staples v. Lewis, 71 Conn. 288, 41 A. 815. - Black's Law Dictionary, 4th Ed., p. 1466.
- 21 "Authorized Representative" means: In the nature of the Uniform Commercial Code, "UCC": UCC § 3-401. SIGNATURE, and UCC § 3-402. SIGNATURE BY REPRESENTATIVE.

Affidavit of DARRELL JAMES HILL Commercial Status

2 OF 2

737

2017-002378 MISC Page: 127 of 693
03/10/2017 12:35:10 PM Receipt #: 17-1634
Rec Fee: \$250.00 Darrell- James: Hill
Gila County, Az. Sadie Jo Bingham, Recorder

123

Darrell- James: Hill
Beverly- Jean: Romero- Hill
5124 E. 18th Avenue
Apache Junction, Arizona [85119]

Office of the President of the United States
President Barak H. Obama
1600 Pennsylvania Ave NW
Washington. D.C. 20500

President Obama:

We are Darrell and Beverly Hill as indicated above, and we live in the Arizona state territory; we are quiet, community oriented, and Almighty God reverencing sojourners. We are getting older now, yet we notice the trajectory of the events occurring in these last days that make it necessary for this type of correspondence to you and others. We hope you comprehend and understand; We have sent herein to you two Notice and Demand correspondences, one from the each of us, to support the essence of the request made in this cover letter to you. See attached: Enclosure One: From Darrell- James: Hill: "AFFIDAVIT: Superior Constructive Notice and Demand: Permanent Non-Commercial Presumption", 19 pages; and Enclosure Two: From Beverly- Jean: Romero- Hill: "AFFIDAVIT: Superior Constructive Notice and Demand: Permanent Non-Commercial Presumption", 19 pages.

The Notice and Demand from Darrell- James: Hill sets forth for your immediate compliance that you make to occur in your information database and multi- agency database that Darrell- James: Hill is to be permanently presumed to be the natural born man under the Originating Documents constituting the United States of America; to wit, Darrell- James: Hill is NOT ever hereafter to be presumed to be the United States Citizen commercial fiction, "DARRELL JAMES HILL", and in any and every encounter with the commercial fiction, that your database establishes thereto that any encounter with the real-man Darrell- James: Hill is as the Authorized Representative of the commercial fiction: DARRELL JAMES HILL.

The Notice and Demand from Beverly- Jean: Romero- Hill sets forth for your immediate compliance that you make to occur in your information database and multi- agency database that Beverly- Jean: Romero- Hill is to be permanently presumed to be the natural born woman under the Originating Documents constituting the United States of America; to wit, Beverly- Jean: Romero- Hill is NOT ever hereafter to be presumed to be the United States Citizen commercial fiction, BEVERLY JEAN ROMERO- HILL, and in any and every encounter with the commercial fiction, that your database establishes that any encounter with the real-woman Beverly- Jean: Romero- Hill is as the Authorized Representative of the commercial fiction: BEVERLY JEAN ROMERO- HILL.

Though this may sound confusing and appear convoluted, for this we apologize, but we know for fact that: 1) this is Not new information; 2) this has been the fact for several decades; and 3) you have been Noticed and Demanded herein to comply with our requests in the nature of the Uniform Commercial Code; specifically, 1-308 and 1-103.

Barak H. Obama, President of the United States USPS RMN RE 322 398 208 US

1/5

Copy

738

2022-011769 MISC Page: 737 of 2782
09/26/2022 03:35:37 PM Receipt #: 22-9381
Rec Fee: \$30.00 Darrell James Hill
Gila County, Az, Sadie Jo Bingham, Recorder



2017-002378 MISC Page: 149 of 693
03/10/2017 12:35:10 PM Receipt #: 17-1634
Rec Fee: \$250.00 Darrell- James: Hill
Gila County, Az, Sadie Jo Bingham, Recorder



145

Upon after receipt you have five days grace period in which to absolutely comply. And,

Thank you;''

Signed the 9th day of September 2016 Darrell-James Hill
Darrell- James: Hill

Signed the 9th day of September 2016 Beverly Jean Romero Hill
Beverly- Jean: Romero- Hill

Unofficial Copy

1739

Barak H. Obama, President of the United States USPS RMN RE 322 398 208 US

2022-011769 MISC Page: 738 of 2782
09/26/2022 03:35:37 PM Receipt #: 22-9381
Rec Fee: \$30.00 Darrell James Hill
Gila County, Az, Sadie Jo Bingham, Recorder

2017-002378 MISC Page: 150 of 693
03/10/2017 12:35:10 PM Receipt #: 17-1634
Rec Fee: \$250.00 Darrell- James: Hill
Gila County, Az, Sadie Jo Bingham, Recorder

146

SENDER: COMPLETE THIS SECTION	COMPLETE THIS SECTION ON DELIVERY
<ul style="list-style-type: none"> Complete items 1, 2, and 3. Print your name and address on the reverse so that we can return the card to you. Attach this card to the back of the mailpiece, or on the front if space permits. <p>1. Article Addressed to:</p> <p>Office of the President of the United States President Barak H. Obama 1600 Pennsylvania Ave NW Washington, D.C. 20500</p> <p>9590 8403 0148 5022 222</p>	<p>A. Signature X _____</p> <p>B. Agent <input type="checkbox"/> Agent <input type="checkbox"/> Address</p> <p>C. Date of Delivery SEP 27 2016</p> <p>D. To deliver to someone other than you? <input type="checkbox"/> Yes <input checked="" type="checkbox"/> No If YES, enter delivery address below:</p> <p>3. Service Type <input type="checkbox"/> Adult Signature <input type="checkbox"/> Registered Mail</p> <p><input type="checkbox"/> Priority Mail Express <input type="checkbox"/> Registered Mail</p>

Registered No. RE322398208US

To Be Completed By Post Office	Reg. Fee	\$2.41	
	Handling Charge	\$11.70	Return Receipt
	Postage	\$2.70	Restricted Delivery
		\$0.00	
	Received by	\$0.00	
	Customer Must Declare Full Value	\$0.00	<input checked="" type="checkbox"/> With Postal Insurance <input type="checkbox"/> Without Postal Insurance

APACHE JUNCTION, AZ 85120

FROM: Danell James Hill, Beverly Jean Romero Hill, 5124 E 18th Ave, Apache Junction Arizona 85119

TO: Office of the President of the US, President Barak H. Obama, 1600 Pennsylvania Ave NW, Washington DC 20500

PS Form 3806, Receipt for Registered Mail, May 2004 (7530-02-000-9051)

Domestic insurance up to \$25,000 is included in the fee. International indemnity is limited. (See Reverse).

Date Stamp: SEP 27 2016

2022-011769 MISC Page: 739 of 2782
09/26/2022 03:35:37 PM Receipt #: 22-9881
Rec Fee: \$30.00 Darrell James Hill
Gila County, Az, Sadie Jo Bingham, Recorder

2017-002378 MISC Page: 152 of 693
03/10/2017 12:35:10 PM Receipt #: 17-1634
Rec Fee: \$250.00 Darrell James Hill
Gila County, Az, Sadie Jo Bingham, Recorder

148

SENDER: COMPLETE SECTION

- Complete items 1, 2, and 3.
- Print your name and address on the reverse so that we can return the card to you.
- Attach this card to the back of the mailpiece, or on the front if space permits.

1. Article Addressed to:

Office of the Chairman of the Joint Chiefs of Staff
 General Joseph Dunford
 9999 Joint Staff Pentagon
 Washington, D.C. 20318-9999

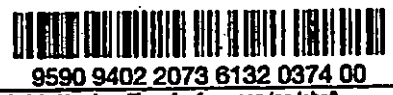

9590 9402 2073 6132 0374 00
 2. Article Number (Transfer from service label)
RE 322 398 231 US
 PS Form 3811, July 2015 PSN 7530-02-000-9053

COMPLETE THIS SECTION ON THE REVERSE

A. Signature: *Carl Brad W. Hill* Agent Addressee

B. Received by (Printed Name): *Carl Brad W. Hill*

C. Date of Delivery: *22 Sep 2016*

D. Is delivery address different from item 1? Yes No
 If YES, enter delivery address below:

3. Service Type

<input type="checkbox"/> Adult Signature	<input type="checkbox"/> Priority Mail Express®
<input type="checkbox"/> Adult Signature Restricted Delivery	<input type="checkbox"/> Registered Mail™
<input type="checkbox"/> Certified Mail®	<input type="checkbox"/> Registered Mail Restricted Delivery
<input type="checkbox"/> Certified Mail Restricted Delivery	<input type="checkbox"/> Return Receipt for Merchandise
<input type="checkbox"/> Collect on Delivery	<input type="checkbox"/> Signature Confirmation™
<input type="checkbox"/> Collect on Delivery Restricted Delivery	<input type="checkbox"/> Signature Confirmation Restricted Delivery
<input type="checkbox"/> Insured Mail	
<input type="checkbox"/> Insured Mail Restricted Delivery (over \$500)	

Registered No. **RE322398211US**

Reg. Fee	\$2.41	
Handling Charge	\$11.70	Return Receipt
Postage	\$2.70	Restricted Delivery
Received by	\$0.00	
		\$16.81

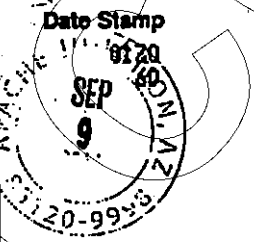

Customer Must Declare Full Value: **\$0.00** Domestic Insurance up to \$25,000 is included on the declared value. International indemnity is limited. (See Reverse).

APACHE JUNCTION, AZ 85120

FROM: *Darrell James Hill*
Beverly Jean Romero Hill
524 E 18th Ave
Apache Junction Arizona 85119

TO: *Office of the Chairman Joint Chief*
General Joseph Dunford
9999 Joint Staff Pentagon
Washington DC 20318-9999

PS Form 3808, Receipt for Registered Mail Copy 1 - Customer
 May 2007 (7530-02-000-9051) (See Information on Reverse)
 For domestic delivery information, visit our website at www.usps.com®

2022-0111769 MISC Page: 740 of 2782
 09/28/2022 03:35:37 PM Receipt #: 22-9381
 Rec Fee: \$30.00 Darrell James Hill
 Gila County, Az, Sadie Jo Bingham, Recorder

741

152

SENDER. COMPLETE THIS SECTION

- Complete Items 1, 2, and 3
- Print your name and address on the reverse so that we can return the card to you.
- Attach this card to the back of the mailpiece, or on the front if space permits.

1. Article Addressed to:
 Office of the Chief of Staff of the Army
 General Mark Milek
 9999 Joint Staff Pentagon
 Washington, D.C. 20318-9999



9590 9402 2073 6132 0373 94

RE 322 398 225 US

COMPLETE THIS SECTION ON DELIVERY

A. Signature *[Signature]* Agent Addressee
 B. Received by (Printed Name) *SSG Yaori Sewano* C. Date of Delivery *21 Sep 16*
 D. Is delivery address different from item 1? Yes No
 If YES, enter delivery address below:

3. Service Type
- Adult Signature
 - Adult Signature Restricted Delivery
 - Certified Mail
 - Certified Mail Restricted Delivery
 - Collect on Delivery
 - Collect on Delivery Restricted Delivery
 - First-Class Mail
 - First-Class Mail Restricted Delivery
 - Insured Mail
 - Insured Mail Restricted Delivery (over \$500)
 - Priority Mail Express®
 - Registered Mail™
 - Registered Mail Restricted Delivery
 - Return Receipt for Merchandise
 - Signature Confirmation™
 - Signature Confirmation Restricted Delivery

PS Form 3811, July 2015 PSN 7530-02-000-9053

Domestic Return Receipt

Registered No. RE322398225US	
Reg. Fee	\$2.41
Handling Charge	\$11.70
Postage	\$2.70
Received by	\$0.00
Customer Must Declare Full Value	\$0.00
\$16.81	
APACHE JUNCTION, AZ 85120 <i>09/20/16</i>	

Date Stamp
0130
60

9

Domestic Insurance up to \$25,000 is included in the fee. International indemnity is limited. (See Reverse)

To Be Completed By Customer (Please Print)
 All Entries Must Be in Ink or Typed

FROM
 Darrell James Hill
 Beverly Jean Romero Hill
 5124 E 18th Ave
 Apache Junction, Arizona 85119

TO
 Office of Chief of Staff of ARMY
 General Mark Milek
 9999 Joint Staff Pentagon
 Washington, DC 20318

PS Form 3806, Receipt for Registered Mail Copy 1 - Customer
 May 2004 (7530-02-000-9051) (See Information on Reverse)

Unofficial

742

Page: 741 of 2782

MISC
 09/26/2022 03:35:37 PM
 Rec Fee: \$30.00
 Gila County, Az, Sadie Jo Bingham, Recorder



2017-002378 MISC Page: 160 of 693
 03/10/2017 12:35:10 PM Receipt #: 17-1634
 Rec Fee: \$250.00 Darrell-James Hill
 Gila County, Az, Sadie Jo Bingham, Recorder



156

SENDER: COMPLETE THIS SECTION

- Complete items 1 and 3.
- Print your name and address on the reverse so that we can return the card to you.
- Attach this card to the back of the mailpiece, or on the front if space permits.

1. Article Addressed to:

Office of the Secretary of the Treasury
 Secretary Melba Acosta Febo
 PO Box 9024140
 San Juan, Puerto Rico 00982-4140



9590 9402 2073 6132 0374 17

RE 322 398 239 US

COMPLETE THIS SECTION ON DELIVERY

A. Signature

X

- Agent
- Addressee

B. Received by (Printed Name)

C. Date of Delivery

D. Is delivery address different from item 1? Yes
If YES, enter delivery address below: No

OFFICE OF THE SECRETARY OF THE TREASURY
SAN JUAN, PUERTO RICO 00982-4140

SEP 9 2016

3. Service Type
- Adult Signature
 - Adult Signature Restricted Delivery
 - Certified Mail
 - Certified Mail Restricted Delivery
 - Collect on Delivery
 - Collect on Delivery Restricted Delivery
 - Insured Mail
 - Insured Mail Restricted Delivery
 - Registered Mail
 - Registered Mail Restricted Delivery
 - Return Receipt for Merchandise
 - Signature Confirmation
 - Signature Confirmation Restricted Delivery
 - Priority Mail Express
 - Registered Mail™
 - Return Receipt for Merchandise
 - Signature Confirmation™
 - Signature Confirmation Restricted Delivery

PS Form 3811, July 2015 PSN 7530-02-000-6053

Domestic Return Receipt

Registered No. RE322398239US

Date Stamp

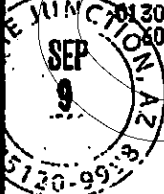

Reg. Fee	\$2.41	
Handling Charge	\$11.70	Return Receipt
Postage	\$2.70	Restricted Delivery
	\$0.00	
Received by	\$0.00	
		\$16.81

Customer Must Declare Full Value \$0.00 Domestic Insurance up to \$25,000 is included based upon the declared value. International insurance is limited. (See Reverse).

APACHE JUNCTION, AZ 85120

OFFICIAL USE

FROM: Darrell James Hill
 Boulevard Roman Hill
 5124 E 18th Ave
 Apache Junction Arizona (85119)

TO: Office of Secretary of Treasury
 Secretary Melba Acosta Febo
 PO Box 9024140
 San Juan Puerto Rico 00982

PS Form 3806, Receipt for Registered Mail Copy 1 - Customer
 May 2007 (7530-02-000-9051) (See Information on Reverse)
 For domestic delivery information, visit our website at www.usps.com®

2017-002378 MISC Page: 164 of 693
 03/10/2017 12:35:10 PM Receipt #: 17-1634
 Rec Fee: \$250.00 Darrell James Hill
 Gila County, Az, Sadie Jo Bingham, Recorder



2022-011769 MISC Page: 742 of 2782
 09/26/2022 03:35:37 PM Receipt #: 22-9381
 Rec Fee: \$30.00 Darrell James Hill
 Gila County, Az, Sadie Jo Bingham, Recorder



743

Darrell- James: Hill
Beverly- Jean: Romero- Hill
5124 E. 18th Avenue
Apache Junction, Arizona [85119]

Attn: Office of the United States Attorney General
c/o Loretta E. Lynch
U.S. Department of Justice
950 Pennsylvania Avenue, NW
Washington, DC 20530-0001
202-514-2000

Hello Loretta:

We are Darrell and Beverly as indicated above, and we live in the Arizona state territory; we are quiet, community oriented, and Almighty God reverencing sojourners. We are getting older now, yet we notice the trajectory of the events occurring in these last days that make it necessary for this type of correspondence to you and others. We hope you comprehend and understand; We have sent herein to you two Notice and Demand correspondences, one from the each of us, to support the essence of the request made in this cover letter to you. See attached: Enclosure One: From Darrell- James: Hill: "AFFIDAVIT: Superior Constructive Notice and Demand: Permanent Non-Commercial Presumption", 19 pages; and Enclosure Two: From Beverly- Jean: Romero- Hill: "AFFIDAVIT: Superior Constructive Notice and Demand: Permanent Non-Commercial Presumption", 19 pages.

The Notice and Demand from Darrell- James: Hill sets forth for your immediate compliance that you make to occur in your information database and multi-agency database that Darrell- James: Hill is to be permanently presumed to be the natural born man under the Originating Documents constituting the United States of America; to wit, Darrell- James: Hill is NOT ever hereafter to be presumed to be the United States Citizen commercial fiction, "DARRELL JAMES HILL", and in any and every encounter with the commercial fiction, that your database establishes thereto that any encounter with the real-man Darrell- James: Hill is as the Authorized Representative of the commercial fiction: DARRELL JAMES HILL.

The Notice and Demand from Beverly- Jean: Romero- Hill sets forth for your immediate compliance that you make to occur in your information database and multi-agency database that Beverly- Jean: Romero- Hill is to be permanently presumed to be the natural born woman under the Originating Documents constituting the United States of America; to wit, Beverly- Jean: Romero- Hill is NOT ever hereafter to be presumed to be the United States Citizen commercial fiction, BEVERLY JEAN ROMERO- HILL, and in any and every encounter with the commercial fiction, that your database establishes that any encounter with the real-woman Beverly- Jean: Romero- Hill is as the Authorized Representative of the commercial fiction: BEVERLY JEAN ROMERO- HILL.

Though this may sound confusing and appear convoluted, for this we apologize, but we know for fact that: 1) this is Not new information; 2) this has been the fact for several decades; and 3) you

2017-002378 MISC Page: 166 of 693
03/10/2017 12:35:10 PM Receipt #: 17-1634
Rep Fee: \$250.00 Darrell- James: Hill
Gila County, Az, Sadie Jo Bingham, Recorder



2022-011769 MISC Page: 743 of 2782
09/26/2022 03:35:37 PM Receipt #: 22-9381
Rep Fee: \$30.00 Darrell- James Hill
Gila County, Az, Sadie Jo Bingham, Recorder



162

have been Noticed and Demanded herein to comply with our requests in the nature of the Uniform Commercial Code; specifically, 1-308 and 1-103.

Upon after receipt you have five days grace period in which to absolutely comply. And,

Thank you;

Signed the 14th day of October 2016 Darrell-James: Hill
Darrell- James: Hill

Signed the 14th day of October 2016 Beverly Jean: Romero-Hill
Beverly- Jean: Romero- Hill

COPY

Unofficial

745

2017-002378 MISC Page: 167 of 693
03/10/2017 12:35:10 PM Receipt #: 17-1834
Rec Fee: \$250.00 Darrell- James: Hill
Gila County, Az, Sadie Jo Bingham, Recorder



2022-011769 MISC Page: 744 of 2782
09/26/2022 03:35:37 PM Receipt #: 22-9381
Rec Fee: \$30.00 Darrell James Hill
Gila County, Az, Sadie Jo Bingham, Recorder



Documents Mailed

It is hereby stated that of this document recording was with the following, mailed this 14th day of October 2016 to:

USPS

Attn: Office of the United States Attorney General
c/o Loretta E. Lynch
U.S. Department of Justice
950 Pennsylvania Avenue, NW
Washington, DC 20530-0001
202-514-2000

RMN RE 322 399 282 US

Attn: Office of the Director, US Marshall's Service
c/o David Harlow, Deputy Director
Washington, D.C. 20530
202-307-9100

CMN 7016 0340 0000 6402 7741

Attn: DOJ: Office of Information Policy
Laurie Day, Chief, Initial Request Staff
1425 New York Avenue, N.W., Suite 11050
Washington, D.C. 20530-0001
Tel: (202) 514-FOIA

CMN 7016 0340 0000 6402 7802

Attn: Office of Arizona Attorney General
c/o Mark Brnovich
1275 West Washington Street
Phoenix, AZ 85007-2926
(602) 542-5025

CMN 7016 0340 0000 6402 7796

I/We mailed or delivered copies to all listed herein:

Signed this 14th day of October 2016

Without Prejudice, UCC 1-308

Darrell-James Hill, A.R.
Darrell-James: Hill, A.R.

Signed this 14th day of October 2016

Without Prejudice, UCC 1-308

Beverly Jean Romero-Hill A.R.
Beverly- Jean Romero- Hill, A.R.

2022-011769 MISC Page: 745 of 2782
09/26/2022 03:35:37 PM Receipt #: 22-9381
Rec Fee: \$30.00 Darrell James Hill
Gila County, Az, Sadie Jo Bingham, Recorder

746
2017-002378 MISC Page: 168 of 693
03/10/2017 12:35:10 PM Receipt #: 17-1634
Rec Fee: \$250.00 Darrell-James: Hill
Gila County, Az, Sadie Jo Bingham, Recorder

164

SENDER: COMPLETE THIS SECTION

- Complete items 1, 2, and 3.
- Print your name and address on the reverse so that we can return the card to you.
- Attach this card to the back of the mailpiece, or on the front if space permits.

COMPLETE THIS SECTION ON DELIVERY

A. Signature Agent
 Addressed

B. Received by (Printed Name) C. Date of Delivery

Attn: Office of the United States Attorney
 General
 c/o Loretta E. Lynch
 U.S. Department of Justice
 950 Pennsylvania Avenue, NW
 Washington, DC 20530-0001

Is your delivery address different from item 1? Yes
 No
 If Yes, enter delivery address below:



9590 9402 2073 6132 0333 65
 2. Article Number (Transfer from service label)
RE 322 399 282 US
 PS Form 3806, JULY 2010 PSN 7530-02-000-9051

- S. Service Type
- Adult Signature
 - Adult Signature Restricted Delivery
 - Certified Mail
 - Certified Mail Restricted Delivery
 - Collect on Delivery
 - Collect on Delivery Restricted Delivery
 - Insured Mail
 - Insured Mail Restricted Delivery
 - Priority Mail Express®
 - Registered Mail™
 - Registered Mail Restricted Delivery
 - Return Receipt for Merchandise
 - Signature Confirmation™
 - Signature Confirmation Restricted Delivery

Domestic Return Receipt

Registered No. **RE322399282US**

Postage \$ \$2.41	Extra Services & Fees (continued)
Extra Services & Fees	<input type="checkbox"/> Signature Confirmation \$
<input type="checkbox"/> Registered Mail \$ \$11.70	<input type="checkbox"/> Signature Confirmation Restricted Delivery \$
<input type="checkbox"/> Return Receipt (hardcopy) \$ \$0.00	Total Postage & Fees \$ \$14.11
<input type="checkbox"/> Return Receipt (electronic) \$ \$0.00	
<input type="checkbox"/> Restricted Delivery \$	
Customer Must Declare Full Value \$ \$0.00	Received by 10/14/2016

APACHE JUNCTION, AZ 85120

Date Stamp
 0130
 08
 14

OFFICIAL USE

To Be Completed By Customer (Please Print) All entries must be in plaintext or typed

FROM	DARRELL JAMES HILL BEVERLY JEAN Romero Hill 5124 E. 18th Ave 85120 Apache Junction, Arizona 85119
TO	Office of United States Attorney c/o Loretta Lynch 950 Pennsylvania Ave, NW Washington, DC 20530-0001

PS Form 3806, Registered Mail Receipt
 April 2015, PSN 7530-02-000-9051
 Copy 1 - Customer
 (See information on Reverse)
 For domestic delivery information, visit our website at www.usps.com

747

2017-002378 MISC Page: 169 of 693
 03/10/2017 12:35:10 PM Receipt #: 17-1634
 Rec Fee: \$250.00 Darrell James Hill
 Gila County, Az, Sadie Jo Bingham, Recorder

2022-011769 MISC Page: 746 of 2782
 09/26/2022 03:35:37 PM Receipt #: 22-9381
 Rec Fee: \$30.00 Darrell James Hill
 Gila County, Az, Sadie Jo Bingham, Recorder

English

Customer Service

USPS Mobile

Register / Sign In



USPS Tracking®

Sent 10/14/16
Rec. 10/21/16

Tracking Number: 7016034000064027741

Updated Delivery Day: Friday, October 21, 2016

Product & Tracking Information

Postal Product:
First-Class Mail®

Features:
Certified Mail™

DATE & TIME	STATUS OF ITEM	LOCATION	Final Updates
October 21, 2016, 5:31 am	Delivered	WASHINGTON, DC 20530	
Your item was delivered at 5:31 am on October 21, 2016 in WASHINGTON, DC 20530.			
October 20, 2016, 2:16 pm	Available for Pickup	WASHINGTON, DC 20530	
October 20, 2016, 12:53 pm	Arrived at Unit	WASHINGTON, DC 20018	
October 18, 2016, 12:06 am	Departed USPS Facility	WILMINGTON, DE 19850	
October 16, 2016, 5:29 pm	Arrived at USPS Facility	WILMINGTON, DE 19850	
October 15, 2016, 7:08 am	Departed USPS Facility	PHOENIX, AZ 85043	
October 14, 2016, 10:41 pm	Arrived at USPS Origin Facility	PHOENIX, AZ 85043	
October 14, 2016, 4:34 pm	Departed Post Office	APACHE JUNCTION, AZ 85120	
October 14, 2016, 4:11 pm	Acceptance	APACHE JUNCTION, AZ 85120	

U.S. Postal Service
CERTIFIED MAIL® RECEIPT
Domestic Mail Only

For delivery information, visit our website at www.usps.com®.

WASHINGTON DC 20530

Certified Mail Fee \$3.30

Extra Services & Fees (check box, add fee if applicable)

<input type="checkbox"/> Return Receipt (hardcopy)	\$0.00
<input type="checkbox"/> Return Receipt (electronic)	\$0.00
<input type="checkbox"/> Certified Mail Restricted Delivery	\$0.00
<input type="checkbox"/> Adult Signature Required	\$0.00
<input type="checkbox"/> Adult Signature Restricted Delivery	\$0.00

Postage \$2.41

Total Postage and Fees \$5.71

Postmark Here
10/21/2016

Sent To: Attn: Office of the Director, US Marshall's Service
Street: c/o David Harlow, Deputy Director
City: Washington, D.C. 20530

PS Form 3800, April 2015 PSN 7530-02-000-9001 See Reverse for Instructions

2022-011769 MISC Page: 747 of 2782
09/26/2022 03:35:37 PM Receipt #: 22-9381
Rec Fee: \$30.00 Darrell James Hill
Gila County, Az, Sadie Jo Bingham, Recorder

Track Another Package

Tracking (or receipt) number

7016034000064027802

Manage Incor

Track all your packages
No tracking numbers nec

Sign up for My US

2017-002378 MISC Page: 173 of 693

03/10/2017 12:35:10 PM Receipt #: 17-1634
Rec Fee: \$250.00 Darrell James Hill
Gila County, Az, Sadie Jo Bingham, Recorder



169

English

Customer Service

USPS Mobile

Register / Sign In



USPS Tracking®

sent 10/14/16
Rec. 10/21/16

Still Have Qs?
Browse our F

Tracking Number: 7016034000064027802

Updated Delivery Day: Friday, October 21, 2016

Product & Tracking Information

Postal Product:
First-Class Mail®

Features:
Certified Mail™

DATE & TIME

STATUS OF ITEM

October 21, 2016, 5:31 am

Delivered

WASHINGTON, DC 20530

Your item was delivered at 5:31 am on October 21, 2016 in WASHINGTON, DC 20530.

October 20, 2016, 2:16 pm

Available for Pickup

WASHINGTON, DC 20530

October 20, 2016, 12:53 pm

Arrived at Unit

WASHINGTON, DC 20018

October 18, 2016, 12:09 am

Departed USPS Facility

WILMINGTON, DE 19850

October 16, 2016, 5:29 pm

Arrived at USPS Facility

WILMINGTON, DE 19850

October 15, 2016, 7:06 am

Departed USPS Facility

PHOENIX, AZ 85043

October 14, 2016, 10:41 pm

Arrived at USPS Origin Facility

PHOENIX, AZ 85043

October 14, 2016, 4:34 pm

Departed Post Office

APACHE JUNCTION, AZ 85120

October 14, 2016, 4:11 pm

Acceptance

APACHE JUNCTION, AZ 85120

Track Another Package

Tracking (or receipt) number

RE322399282US

Track it

2017-002378 MISC Page: 177 of 693

03/10/2017 12:35:10 PM Receipt #: 17-1634
Rec Fee: \$250.00 Darrell James Hill
Gila County, Az, Sadie Jo Bingham, Recorder



U.S. Postal Service™
CERTIFIED MAIL® RECEIPT
Domestic Mail Only

For delivery information, visit our website at www.usps.com

WASHINGTON, DC 20530

Certified Mail Fee	\$3.30	0130
Additional Services & Fees (check box, add fee as appropriate)	\$0.00	08
<input type="checkbox"/> Return Receipt (hardcopy)	\$0.00	
<input type="checkbox"/> Return Receipt (electronic)	\$0.00	
<input type="checkbox"/> Certified Mail Restricted Delivery	\$0.00	
<input type="checkbox"/> Adult Signature Required	\$0.00	
<input type="checkbox"/> Adult Signature Restricted Delivery	\$0.00	
Postage	\$2.41	
Total Postage		10/14/2016

Postmark Here

Attn: ~~1507~~ Office of Information Policy
Laurie Day, Chief, Initial Request Staff
1425 New York Avenue, N.W., Suite 11050
Washington, D.C. 20530-0001

PS Form 3800, April 2015 PSN 7548-01-000-9000 See Reverse for Instructions

2022-011769 MISC Page: 748 of 2782
09/26/2022 03:35:37 PM Receipt #: 22-9381
Rec Fee: \$30.00 Darrell James Hill
Gila County, Az, Sadie Jo Bingham, Recorder



Manage Incon

Track all your packages |
No tracking numbers nec

Sign up for My US

173



USPS Tracking®

Sent 10/14/16
Rec 10/18/16

Tracking Number **7016034000064027796**

Product & Tracking Information

Postal Product:
First-Class Mail®

Features:
Certified Mail™

DATE & TIME	STATUS OF ITEM	LOCATION	Email Updates
October 18, 2016 , 8:29 am	Delivered	PHOENIX, AZ 85009	
Your item was delivered at 8:29 am on October 18, 2016 in PHOENIX, AZ 85009.			
October 18, 2016 , 7:18 am	Arrived at Unit	PHOENIX, AZ 85009	
October 17, 2016 , 11:39 am	Available for Pickup	PHOENIX, AZ 85007	
October 17, 2016 , 7:57 am	Out for Delivery	PHOENIX, AZ 85007	
October 17, 2016 , 7:47 am	Sorting Complete	PHOENIX, AZ 85007	
October 17, 2016 , 4:19 am	Departed USPS Facility	PHOENIX, AZ 85043	
October 15, 2016 , 12:36 pm	Arrived at USPS Facility	PHOENIX, AZ 85043	
October 14, 2016 , 4:34 pm	Departed Post Office	APACHE JUNCTION, AZ 85120	
October 14, 2016 , 4:11 pm	Acceptance	APACHE JUNCTION, AZ 85120	

Still Have One

U.S. Postal Service™
CERTIFIED MAIL RECEIPT
Domestic Mail Only

For delivery information, visit our website at www.usps.com

PHOENIX AZ 85007

PHOENIX 0130 09

Postmark Here

10/14/2016

Attorney Office of Arizona Attorney General
c/o Mark Bromovich
1275 West Washington Street
Phoenix, AZ 85007-2926

PS Form 3800, April 2015 Edition

Track Another Package

Tracking (or receipt) number
7016034000064027741

Manage Incom

Track all your packages!
No tracking numbers nec
Sign up for My US

2022-011769 MISC Page: 749 of 2782
09/26/2022 03:35:37 PM Receipt #: 22-9381
Rec Fee: \$30.00 Darrell James Hill
Gila County, Az, Sadie Jo Bingham, Recorder

2017-002378 MISC Page: 181 of 693
03/10/2017 12:35:10 PM Receipt #: 17-1634
Rec Fee: \$250.00 Darrell James Hill
Gila County, Az, Sadie Jo Bingham, Recorder

177

Lorretta: U.S. Attorney General
950 Pennsylvania Avenue, N.W.
Washington, District of Columbia [20530-0001]

NOTICE: CLAIM¹

RE: Property disposed to the United States of America in the "UNITED STATES ATTORNEY'S OFFICE; OFFICIAL NOTIFICATION POSTED ON OCTOBER 12, 2016"

Loretta, Greetings:

I: man²:

- a) make this superior-claim³ as the owner⁴ in due course of law⁵ to the property⁶ disposed by the United States⁷ court(s) to the "United States of America"⁸ as noticed in the "UNITED STATES ATTORNEY'S OFFICE; OFFICIAL NOTIFICATION POSTED ON OCTOBER 12, 2016";

Therefore:

- b) my supreme⁹ claim to all of the property specifically disposed to the United States of America:
 - 1) is as indicated in the attached Enclosure One- Amended 'UNITED STATES ATTORNEY'S OFFICE; OFFICIAL NOTIFICATION POSTED ON OCTOBER 12, 2016', 304 pages;
 - 2) is in due course of law specifically superior to and above all corporation and commercial claims, including but not limited to those of the United States, et seq.;
 - 3) is made timely within the 60 day time frame timely to co-exist with the ending of U.S. court's petition¹⁰ phase and to avoid appearance of acquiescence or error; and,
 - 4) shall be of free and clear title, delivered to me without delay or hesitation following the U.S. court's 60-day petition phase.

- 1 claim means: a demand for something rightfully due.
- 2 man means: one man-kind of the people of the united States of America: America National Citizen
- 3 superior-claim means: a claim made by one who is higher or greater than another in rank and qualities of kind
- 4 owner means: one who has the rightful title, whether he is the possessor or not.
- 5 law means: under Article IX and Article X of the Bill of Rights (1789) of the Constitution for the United States of America
- 6 property means: that substance of the right of the exclusive and absolute ownership in its any form
- 7 United States means: the corporation
- 8 United States of America means: the essential essence of the land and people by the people and for the people.
- 9 supreme means: highest in authority, rank and power, etc.; dominant.
- 10 petition means: A written address, embodying an application or prayer from the person or persona preferring it, to the power, body, or person to whom it is presented, for the exercise of his or their authority in the redress of some wrong, or the grant of some favor, privilege, or license[;] in the nature of Enderson v. Hildenbrand, 52 N.D. 533, 204 N.W. 256; et seq.: Black's Law Dictionary, 4th Ed., p. 1302.



751

Darrell- James: Hill, 5124 East 18th Avenue, Apache Junction, Arizona [85119]

USPS RE 322 399 279 US

- Loretta, a) You have 10 days from the time of the receipt of this Notice to respond; and,
- b) If you do not respond timely then your silence will be accepted as tacit acquiescence of my claim in full. Then after,
- c) I will recontact you.

Thank you; Sincerely,

Darrell-James: Hill
 Darrell- James: Hill

752

USPS RE 322 399 279 US

2/3

2017-002378 MISC Page: 242 of 693
 03/10/2017 12:35:10 PM Receipt #: 17-1634
 Rec Fee: \$250.00 Darrell- James: Hill
 Gila County, Az, Sadie Jo Bingham, Recorder



2022-011769 MISC Page: 751 of 2782
 09/26/2022 03:35:37 PM Receipt #: 22-9381
 Rec Fee: \$30.00 Darrell James Hill
 Gila County, Az, Sadie Jo Bingham, Recorder





USPS Tracking®

Still Have Questions? Browse our FAQs

Get Signatures

Tracking Number: **RE322399279US**

Product & Tracking Information

Available

Postal Product:
Priority Mail™

Features:
Registered Mail™

Return Receipt

Text Updates

See tracking for related item: 9590940220738132133352

Send Updates

DATE & TIME	STATUS OF ITEM	LOCATION
October 31, 2016 , 4:35 am	Delivered	WASHINGTON, DC 20530
Your item was delivered at 4:35 am on October 31, 2016 in WASHINGTON, DC 20530.		
October 28, 2016 , 2:06 am	Arrived at Unit	WASHINGTON, DC 20066
October 27, 2016 , 8:06 am	Arrived at USPS Destination Facility	WASHINGTON, DC 20066
October 25, 2016 , 11:48 pm	Departed USPS Facility	PHOENIX, AZ 85026
October 25, 2016 , 10:10 pm	Arrived at USPS Facility	PHOENIX, AZ 85026
October 25, 2016 , 4:42 pm	Departed Post Office	APACHE JUNCTION, AZ 85120
October 25, 2016 , 11:02 am	Acceptance	APACHE JUNCTION, AZ 85120

753

1 of 2

11/2/2016 4:00 PM

2017-002378 MISC Page: 548 of 693

03/10/2017 12:35:10 PM Receipt #: 17-1634
Rec Fee: \$250.00 Darrell James Hill
Gila County, Az, Sadie Jo Bingham, Recorder



2022-011769 MISC Page: 752 of 2782

09/26/2022 03:35:37 PM Receipt #: 22-9381
Rec Fee: \$30.00 Darrell James Hill
Gila County, Az, Sadie Jo Bingham, Recorder



Sent 10/25/16
 Rec. 10/31/16

Registered No. RE322399279US

Date Stamp: 0130 07

APACHE JUNCTION, AZ 85120-9998

Postage \$ 20.05	Extra Services & Fees (Postage)
Extra Services & Fees (Postage)	Signature Confirmation \$
Registered Mail \$ 11.70	Signature Confirmation Restricted Delivery \$
Return Receipt (Hardcopy) \$ 2.70	Signature Confirmation Restricted Delivery \$
Return Receipt (Electronic) \$ 0.00	Total Postage & Fees \$ 34.45
Restricted Delivery \$	

Customer Must Declare Full Value \$ 0.00

Received by: 10/26/2016

Domestic Mailpiece (if applicable) is included in the declared value. International postage is limited. (See Reverse).

OFFICIAL USE

FROM: Darrell James Hill, 5124 East 16th Avenue, Apache Junction, Arizona (85119)

TO: Loretta U.S. Attorney General, 950 Pennsylvania Avenue, N.W., Washington, District of Columbia (20530-0001)

APACHE JUNCTION
 RESTRICTION BLVD
 APACHE JUNCTION
 AZ
 85120-9998
 0307 0130
 (800) 275-8777 11:06 AM

25/2016

Description	Sale Qty	Final Price
1-Day (Domestic) WASHINGTON, DC 20530 (Weight: 3 lb 1.50 Oz) (Expected Delivery Day) (Thursday 10/27/2016)	1	\$11.70
Registered (Amount: \$0.00) (USPS Registered Mail #) (12239927)		\$11.70
Registered Mail (USPS Return Receipt #) (95909402207)		\$11.70
		\$34.45
		\$40.00
		\$5.55

PS Form 3806, Registered Mail Receipt
 April 2015, PSN 7530-02-000-9051
 For domestic delivery information, visit our website at www.usps.com

SENDER COMPLETE THIS SECTION

- Complete items 1, 2, and 3.
- Print your name and address on the reverse so that we can return the card to you.
- Attach this card to the back of the mailpiece, or on the front if space permits.

1. Article Addressed to:

Loretta U.S. Attorney General
 950 Pennsylvania Avenue, N.W.
 Washington, District of Columbia
 [20530-0001]

COMPLETE THIS SECTION ON DELIVERY

A. Signature
 X Agent Address

B. Received by (Printed Name) C. Date of Delivery

D. Is delivery address different from item 1? Yes No
 If YES, enter delivery address below: L. S. Hill

2. Article Number (Transfer from service label)
 RE 322 399 279 US

Barcode: 9590 9402 2073 6132 0333 58

3. Service Type

- Adult Signature
- Adult Signature Restricted Delivery
- Certified Mail
- Certified Mail Restricted Delivery
- Collect on Delivery
- Collect on Delivery Restricted Delivery
- Insured Mail
- Insured Mail Restricted Delivery (over \$500)
- Priority Mail Express
- Registered Mail
- Registered Mail Restricted Delivery
- Return Receipt for Merchandise
- Signature Confirmation
- Signature Confirmation Restricted Delivery

754

Claim 1
279

COPY

**:(C) :Oct. 31- 2016 :Property -Claim: RE 322 399 279 US
:Gila county, Ariz. -Doc. # 2017-002378, :page: 243- 549.**

**:(K) :Mar.. 31- 2017 :Property -Claim: RE 322 399 251 US
:Gila county, Ariz. -Doc. # 2019-009291, :page: 9- 333, 342- 343.**

**:(T) :Sept. 26- 2017 :Property -Claim: RE 322 399 248 US
:Gila county, Ariz. -Doc. # 2019-009291, :page: 374- 549- 737.**

755

2022-011769 MISC Page: 754 of 2782
09/26/2022 03:35:37 PM Receipt #: 22-9381
Rec Fee: \$30.00 Darrell James Hill
Gila County, Az, Sadie Jo Bingham, Recorder



Darrell- James: Hill, 5124 East 18th Avenue, Apache Junction, Arizona [85119]

USPS CMN 7016 0340 0000 6402 7789

Loretta: U.S. Attorney General
950 Pennsylvania Avenue, N.W.
Washington, District of Columbia [20530-0001]

NOTICE: Cease and Desist

RE: October 31st, 2016 Registered Mail Notice: Claim RE 322 399 279 US: Sept. 13th to 20th, 2016
Property Claimed Table; Enclosure One: 5 pages.

Loretta, Greetings:

- i: man:
- darrell- james: Hill; made claim upon you for property by the USPS RMN RE 322 399 279 US; sent: October 25, 2016; received: October 31, 2016;
 - have not heard or otherwise received response from you concerning the property; therefore,
 - send this Cease and Desist to stop any harm to me by your any action to delay disposal of the property claimed to me after the 'person's 60-day claim period with the court' is completed;
 - require you to dispose the property claimed by me to me immediately following the 'person's 60-day claim period with the court' is completed;
 - believe it would be wrong for you to not dispose to me all of the property claimed immediately as required; and,
 - believe that trespass upon my property rights must result in a claim against trespass.

Loretta: by trespass upon my property claimed, at 24 hours after the 'person's 60-day claim period with the court' and ending at 24 hours before the disposition to me of the property claimed, you agree to 1) be obligated to pay trespass costs at one silver dollar per minute until the property is disposed to me; including, 2) tacit agreement for unimpeded, uncontested judgment for the all trespass and receipt of property claimed costs.

Thank you Loretta,

11/10/2016

Darrell-James: Hill
Darrell- James: Hill

USPS CMN 7016 0340 0000 6402 7789

1/2

756

2017-002378 MISC Page: 551 of 693
03/10/2017 12:35:10 PM Receipt #: 17-1834
Rec Fee: \$250.00 Darrell- James: Hill
Gila County, Az, Sadie Jo Bingham, Recorder

2022-011769 MISC Page: 755 of 2782
09/26/2022 03:35:37 PM Receipt #: 22-9381
Rec Fee: \$30.00 Darrell James Hill
Gila County, Az, Sadie Jo Bingham, Recorder

Darrell- James; Hill, 5124 East 18th Avenue, Apache Junction, Arizona [85119]

USPS CMN 7016 0340 0000 6402 7789

Official Copy

Enclosure One-
October 31st, 2016 Registered Mail Notice: Claim RE 322 399 279 US:
Sept. 13th to 20th, 2016 Property Claimed Table,
5 pages.

USPS CMN 7016 0340 0000 6402 7789

2/2

757

2017-002378 MISC Page: 552 of 693
09/10/2017 12:35:10 PM Receipt #: 17-1634
Rec Fee: \$250.00 Darrell- James: Hill
Gila County, Az, Sadie Jo Bingham, Recorder



2022-011769 MISC Page: 756 of 2782
09/26/2022 03:35:37 PM Receipt #: 22-9381
Rec Fee: \$30.00 Darrell James Hill
Gila County, Az, Sadie Jo Bingham, Recorder



Title:

Author:
Date: 11/9/16

ID:	CLAIM PAGE #	PROPERTY ITEM #	USAO NOTICE	CLAIM NOTICE
1	22	14-FBI-008363	SEPT. 13, 2016	Oct. 31, 2016
2	135	15-FBI-004903	SEPT. 13, 2016	Oct. 31, 2016
3	136	15-FBI-004905	SEPT. 13, 2016	Oct. 31, 2016
4	161	16-FBI-001066	SEPT. 13, 2016	Oct. 31, 2016
5	162	15-FBI-004306	SEPT. 13, 2016	Oct. 31, 2016
6	162	15-FBI-004734	SEPT. 13, 2016	Oct. 31, 2016
7	165	15-FBI-005383	SEPT. 13, 2016	Oct. 31, 2016
8	167	16-ATF-021874	SEPT. 13, 2016	Oct. 31, 2016
9	167	16-ATF-021877	SEPT. 13, 2016	Oct. 31, 2016
10	167	16-ATF-021879	SEPT. 13, 2016	Oct. 31, 2016
11	167	16-ATF-021881	SEPT. 13, 2016	Oct. 31, 2016
12	167	16-ATF-021883	SEPT. 13, 2016	Oct. 31, 2016
13	167	16-ATF-021884	SEPT. 13, 2016	Oct. 31, 2016
14	176	16-INT-000910	SEPT. 13, 2016	Oct. 31, 2016
15	226	16-FBI-003487	SEPT. 13, 2016	Oct. 31, 2016
16	226	16-FBI-003508	SEPT. 13, 2016	Oct. 31, 2016
17	226	16-FBI-003510	SEPT. 13, 2016	Oct. 31, 2016
18	226	16-FBI-003567	SEPT. 13, 2016	Oct. 31, 2016
19	228	16-FBI-003588	SEPT. 13, 2016	Oct. 31, 2016
20	228	16-FBI-003642	SEPT. 13, 2016	Oct. 31, 2016
21	226	16-FBI-003898	SEPT. 13, 2016	Oct. 31, 2016
22	226	16-FBI-003898	SEPT. 13, 2016	Oct. 31, 2016
23	228	16-FBI-003903	SEPT. 13, 2016	Oct. 31, 2016
24	228	16-FBI-003905	SEPT. 13, 2016	Oct. 31, 2016
25	227	16-FBI-003921	SEPT. 13, 2016	Oct. 31, 2016
26	227	16-FBI-003925	SEPT. 13, 2016	Oct. 31, 2016
27	227	16-FBI-003938	SEPT. 13, 2016	Oct. 31, 2016
28	227	16-FBI-003940	SEPT. 13, 2016	Oct. 31, 2016
29	232	16-DEA-624056	SEPT. 13, 2016	Oct. 31, 2016
30	239	15-FBI-003674	SEPT. 13, 2016	Oct. 31, 2016
31	258	15-ATF-026702	SEPT. 13, 2016	Oct. 31, 2016
32	263	16-ATF-015317	SEPT. 13, 2016	Oct. 31, 2016
33	264	16-ATF-015302	SEPT. 13, 2016	Oct. 31, 2016
34	2	15-DEA-613045	SEPT. 14, 2016	Oct. 31, 2016
35	2	15-DEA-613918	SEPT. 14, 2016	Oct. 31, 2016
36	27	16-FBI-004891	SEPT. 14, 2016	Oct. 31, 2016
37	31	16-FBI-001346	SEPT. 14, 2016	Oct. 31, 2016
38	31	16-FBI-001364	SEPT. 14, 2016	Oct. 31, 2016
39	31	16-FBI-001365	SEPT. 14, 2016	Oct. 31, 2016
40	31	16-FBI-001456	SEPT. 14, 2016	Oct. 31, 2016
41	31	16-FBI-001458	SEPT. 14, 2016	Oct. 31, 2016
42	31	16-FBI-001515	SEPT. 14, 2016	Oct. 31, 2016
43	31	16-FBI-001533	SEPT. 14, 2016	Oct. 31, 2016
44	31	16-FBI-001582	SEPT. 14, 2016	Oct. 31, 2016
45	32	16-FBI-001588	SEPT. 14, 2016	Oct. 31, 2016
46	120	16-DEA-624738	SEPT. 14, 2016	Oct. 31, 2016
47	130	16-FBI-002489	SEPT. 14, 2016	Oct. 31, 2016
48	130	16-FBI-002491	SEPT. 14, 2016	Oct. 31, 2016
49	130	16-FBI-002492	SEPT. 14, 2016	Oct. 31, 2016
50	130	16-FBI-002493	SEPT. 14, 2016	Oct. 31, 2016
51	130	16-FBI-002501	SEPT. 14, 2016	Oct. 31, 2016
52	132	16-FBI-005086	SEPT. 14, 2016	Oct. 31, 2016
53	144	15-FBI-007182	SEPT. 14, 2016	Oct. 31, 2016
54	144	15-FBI-007210	SEPT. 14, 2016	Oct. 31, 2016
55	144	15-FBI-007212	SEPT. 14, 2016	Oct. 31, 2016
56	144	15-FBI-007213	SEPT. 14, 2016	Oct. 31, 2016
57	145	15-FBI-007215	SEPT. 14, 2016	Oct. 31, 2016
58	230	16-ATF-023682	SEPT. 14, 2016	Oct. 31, 2016
59	230	16-ATF-023683	SEPT. 14, 2016	Oct. 31, 2016
60	230	16-ATF-023684	SEPT. 14, 2016	Oct. 31, 2016
61	243	11-ATF-032526	SEPT. 14, 2016	Oct. 31, 2016
62	243	14-ATF-024993	SEPT. 14, 2016	Oct. 31, 2016
63	288	16-ATF-018528	SEPT. 14, 2016	Oct. 31, 2016
64	288	16-ATF-010292	SEPT. 14, 2016	Oct. 31, 2016
65	270	16-ATF-013073	SEPT. 14, 2016	Oct. 31, 2016

2017-002378 MISC Page: 553 of 693

03/10/2017 12:35:10 PM Receipt #: 17-1634
Rec Fee: \$250.00 Darrell James Hill
Gila County, Az, Sadie Jo Bingham, Recorder



2022-011769 MISC Page: 757 of 2782

09/26/2022 03:35:37 PM Receipt #: 22-9381
Rec Fee: \$30.00 Darrell James Hill
Gila County, Az, Sadie Jo Bingham, Recorder



758

Title:

Author:

Date: 11/9/16

ID:	CLAIM PAGE #	PROPERTY ITEM #	USAO NOTICE	CLAIM NOTICE
68	284	18-ATF-004518	SEPT. 14, 2016	Oct 31, 2016
67	284	18-ATF-004520	SEPT. 14, 2016	Oct 31, 2016
68	284	18-ATF-004521	SEPT. 14, 2016	Oct 31, 2016
69	284	18-ATF-004522	SEPT. 14, 2016	Oct 31, 2016
70	301	18-ICE-000439	SEPT. 14, 2016	Oct 31, 2016
71	301	18-ICE-000440	SEPT. 14, 2016	Oct 31, 2016
72	301	18-ICE-000441	SEPT. 14, 2016	Oct 31, 2016
73	107	18-ATF-011828	SEPT. 15, 2016	Oct 31, 2016
74	107	SN: K441178	SEPT. 15, 2016	Oct 31, 2016
75	107	18-ATF-011828	SEPT. 15, 2016	Oct 31, 2016
76	107	18-ATF-011832	SEPT. 15, 2016	Oct 31, 2016
77	107	18-ATF-011833	SEPT. 15, 2016	Oct 31, 2016
78	107	18-ATF-011834	SEPT. 15, 2016	Oct 31, 2016
79	107	18-ATF-011835	SEPT. 15, 2016	Oct 31, 2016
80	107	18-ATF-011836	SEPT. 15, 2016	Oct 31, 2016
81	107	18-ATF-011837	SEPT. 15, 2016	Oct 31, 2016
82	107	18-ATF-011838	SEPT. 15, 2016	Oct 31, 2016
83	107	18-ATF-011839	SEPT. 15, 2016	Oct 31, 2016
84	107	18-ATF-011840	SEPT. 15, 2016	Oct 31, 2016
85	108	18-ATF-011841	SEPT. 15, 2016	Oct 31, 2016
86	108	18-ATF-011842	SEPT. 15, 2016	Oct 31, 2016
87	108	18-ATF-011843	SEPT. 15, 2016	Oct 31, 2016
88	108	18-ATF-011844	SEPT. 15, 2016	Oct 31, 2016
89	108	18-ATF-011845	SEPT. 15, 2016	Oct 31, 2016
90	108	18-ATF-011847	SEPT. 15, 2016	Oct 31, 2016
91	108	18-ATF-011848	SEPT. 15, 2016	Oct 31, 2016
92	108	18-ATF-011849	SEPT. 15, 2016	Oct 31, 2016
93	108	18-ATF-011850	SEPT. 15, 2016	Oct 31, 2016
94	185	14-ATF-025087	SEPT. 15, 2016	Oct 31, 2016
95	276	CN M-15-CR-760(a)	SEPT. 15, 2016	Oct 31, 2016
96	276	CN M-15-CR-760(b)	SEPT. 15, 2016	Oct 31, 2016
97	276	CN M-15-CR-760(c)	SEPT. 15, 2016	Oct 31, 2016
98	276	CN M-15-CR-760(d)	SEPT. 15, 2016	Oct 31, 2016
99	231	14-ATF-027738	SEPT. 15, 2016	Oct 31, 2016
100	38	16-ICE-002945	SEPT. 16, 2016	Oct 31, 2016
101	49	13-DCI-000012	SEPT. 16, 2016	Oct 31, 2016
102	49	13-DCI-000013	SEPT. 16, 2016	Oct 31, 2016
103	49	13-DCI-000014	SEPT. 16, 2016	Oct 31, 2016
104	49	13-DCI-000015	SEPT. 16, 2016	Oct 31, 2016
105	49	13-DCI-000016	SEPT. 16, 2016	Oct 31, 2016
106	49	13-DCI-000017	SEPT. 16, 2016	Oct 31, 2016
107	50	13-DCI-000018	SEPT. 16, 2016	Oct 31, 2016
108	50	13-DCI-000019	SEPT. 16, 2016	Oct 31, 2016
109	50	13-DCI-000020	SEPT. 16, 2016	Oct 31, 2016
110	50	13-DCI-000021	SEPT. 16, 2016	Oct 31, 2016
111	50	13-DCI-000022	SEPT. 16, 2016	Oct 31, 2016
112	50	13-DCI-000023	SEPT. 16, 2016	Oct 31, 2016
113	50	13-DCI-000025	SEPT. 16, 2016	Oct 31, 2016
114	50	13-DCI-000026	SEPT. 16, 2016	Oct 31, 2016
115	50	13-DCI-000027	SEPT. 16, 2016	Oct 31, 2016
116	50	13-DCI-000029	SEPT. 16, 2016	Oct 31, 2016
117	51	13-DCI-000030	SEPT. 16, 2016	Oct 31, 2016
118	51	13-DCI-000031	SEPT. 16, 2016	Oct 31, 2016
119	51	13-DCI-000032	SEPT. 16, 2016	Oct 31, 2016
120	51	13-DCI-000033	SEPT. 16, 2016	Oct 31, 2016
121	52	13-DCI-000034	SEPT. 16, 2016	Oct 31, 2016
122	52	13-DCI-000035	SEPT. 16, 2016	Oct 31, 2016
123	53	13-DCI-000036	SEPT. 16, 2016	Oct 31, 2016
124	53	13-DCI-000037	SEPT. 16, 2016	Oct 31, 2016
125	53	13-DCI-000038	SEPT. 16, 2016	Oct 31, 2016
126	54	13-DCI-000039	SEPT. 16, 2016	Oct 31, 2016
127	54	13-DCI-000040	SEPT. 16, 2016	Oct 31, 2016
128	54	13-DCI-000041	SEPT. 16, 2016	Oct 31, 2016
129	55	13-DCI-000042	SEPT. 16, 2016	Oct 31, 2016
130	55	13-DCI-000043	SEPT. 16, 2016	Oct 31, 2016
131	55	13-DCI-000044	SEPT. 16, 2016	Oct 31, 2016
132	56	13-DCI-000045	SEPT. 16, 2016	Oct 31, 2016

2017-002378 MISC Page: 534 of 693
 03/10/2017 12:35:10 PM Receipt #: 17-1634
 Rec Fee: \$250.00 Darrell James Hill
 Gila County, Az, Sadie Jo Bingham, Recorder

2022-011769 MISC Page: 758 of 2782
 09/26/2022 03:35:37 PM Receipt #: 22-9381
 Rec Fee: \$30.00 Darrell James Hill
 Gila County, Az, Sadie Jo Bingham, Recorder

Title:

Author:

Date: 11/9/16

ID:	CLAIM PAGE #	PROPERTY ITEM #	USAO NOTICE	CLAIM NOTICE
133	58	13-DCI-000046	SEPT. 16, 2016	Oct. 31, 2016
134	58	13-DCI-000047	SEPT. 16, 2016	Oct. 31, 2016
135	57	13-DCI-000048	SEPT. 16, 2016	Oct. 31, 2016
136	57	13-DCI-000049	SEPT. 16, 2016	Oct. 31, 2016
137	57	13-DCI-000050	SEPT. 16, 2016	Oct. 31, 2016
138	57	13-DCI-000051	SEPT. 16, 2016	Oct. 31, 2016
139	58	13-DCI-000052	SEPT. 16, 2016	Oct. 31, 2016
140	58	13-DCI-000053	SEPT. 16, 2016	Oct. 31, 2016
141	58	13-DCI-000054	SEPT. 16, 2016	Oct. 31, 2016
144	59	13-DCI-000055	SEPT. 16, 2016	Oct. 31, 2016
145	59	13-DCI-000056	SEPT. 16, 2016	Oct. 31, 2016
146	59	13-DCI-000057	SEPT. 16, 2016	Oct. 31, 2016
147	60	13-DCI-000058	SEPT. 16, 2016	Oct. 31, 2016
148	60	13-DCI-000059	SEPT. 16, 2016	Oct. 31, 2016
149	60	13-DCI-000060	SEPT. 16, 2016	Oct. 31, 2016
150	61	13-DCI-000061	SEPT. 16, 2016	Oct. 31, 2016
151	61	13-DCI-000062	SEPT. 16, 2016	Oct. 31, 2016
152	61	13-DCI-000063	SEPT. 16, 2016	Oct. 31, 2016
153	61	13-DCI-000064	SEPT. 16, 2016	Oct. 31, 2016
154	62	13-DCI-000065	SEPT. 16, 2016	Oct. 31, 2016
155	62	13-DCI-000066	SEPT. 16, 2016	Oct. 31, 2016
156	62	13-DCI-000067	SEPT. 16, 2016	Oct. 31, 2016
157	63	13-DCI-000068	SEPT. 16, 2016	Oct. 31, 2016
158	63	13-DCI-000069	SEPT. 16, 2016	Oct. 31, 2016
159	63	13-DCI-000070	SEPT. 16, 2016	Oct. 31, 2016
160	64	13-DCI-000071	SEPT. 16, 2016	Oct. 31, 2016
161	64	13-DCI-000072	SEPT. 16, 2016	Oct. 31, 2016
162	65	13-DCI-000073	SEPT. 16, 2016	Oct. 31, 2016
163	65	13-DCI-000074	SEPT. 16, 2016	Oct. 31, 2016
164	65	13-DCI-000075	SEPT. 16, 2016	Oct. 31, 2016
165	66	13-DCI-000076	SEPT. 16, 2016	Oct. 31, 2016
166	66	13-DCI-000077	SEPT. 16, 2016	Oct. 31, 2016
167	66	13-DCI-000078	SEPT. 16, 2016	Oct. 31, 2016
168	67	13-DCI-000079	SEPT. 16, 2016	Oct. 31, 2016
169	67	13-DCI-000080	SEPT. 16, 2016	Oct. 31, 2016
170	67	13-DCI-000081	SEPT. 16, 2016	Oct. 31, 2016
174	68	13-DCI-000082	SEPT. 16, 2016	Oct. 31, 2016
175	68	13-DCI-000083	SEPT. 16, 2016	Oct. 31, 2016
176	68	13-DCI-000084	SEPT. 16, 2016	Oct. 31, 2016
177	68	13-DCI-000085	SEPT. 16, 2016	Oct. 31, 2016
178	69	13-DCI-000086	SEPT. 16, 2016	Oct. 31, 2016
179	69	13-DCI-000087	SEPT. 16, 2016	Oct. 31, 2016
180	69	13-DCI-000088	SEPT. 16, 2016	Oct. 31, 2016
181	69	13-DCI-000089	SEPT. 16, 2016	Oct. 31, 2016
182	70	13-DCI-000090	SEPT. 16, 2016	Oct. 31, 2016
183	70	13-DCI-000091	SEPT. 16, 2016	Oct. 31, 2016
184	70	13-DCI-000092	SEPT. 16, 2016	Oct. 31, 2016
185	70	13-DCI-000094	SEPT. 16, 2016	Oct. 31, 2016
186	71	13-DCI-000095	SEPT. 16, 2016	Oct. 31, 2016
187	71	13-DCI-000096	SEPT. 16, 2016	Oct. 31, 2016
188	71	13-DCI-000097	SEPT. 16, 2016	Oct. 31, 2016
189	71	13-DCI-000098	SEPT. 16, 2016	Oct. 31, 2016
190	71	13-DCI-000099	SEPT. 16, 2016	Oct. 31, 2016
191	72	13-DCI-000100	SEPT. 16, 2016	Oct. 31, 2016
192	72	13-DCI-000101	SEPT. 16, 2016	Oct. 31, 2016
193	72	13-DCI-000102	SEPT. 16, 2016	Oct. 31, 2016
194	72	13-DCI-000103	SEPT. 16, 2016	Oct. 31, 2016
195	73	13-DCI-000104	SEPT. 16, 2016	Oct. 31, 2016
196	73	13-DCI-000105	SEPT. 16, 2016	Oct. 31, 2016
197	73	13-DCI-000106	SEPT. 16, 2016	Oct. 31, 2016
198	73	13-DCI-000107	SEPT. 16, 2016	Oct. 31, 2016
199	73	13-DCI-000108	SEPT. 16, 2016	Oct. 31, 2016
200	74	13-DCI-000109	SEPT. 16, 2016	Oct. 31, 2016
201	74	13-DCI-000110	SEPT. 16, 2016	Oct. 31, 2016
202	74	13-DCI-000111	SEPT. 16, 2016	Oct. 31, 2016
203	75	13-DCI-000112	SEPT. 16, 2016	Oct. 31, 2016
204	75	13-DCI-000113	SEPT. 16, 2016	Oct. 31, 2016

2017-002378 MISC Page: 555 of 693

03/10/2017 12:35:10 PM Receipt #: 17-1634
Rec Fee: \$250.00 Darrell James Hill
Gila County, Az, Sadie Jo Bingham, Recorder



2022-011769 MISC Page: 759 of 2782

09/26/2022 03:35:37 PM Receipt #: 22-9381
Rec Fee: \$30.00 Darrell James Hill
Gila County, Az, Sadie Jo Bingham, Recorder



Title:

Author:

Date: 11/9/16

ID:	CLAIM PAGE #	PROPERTY ITEM #	USAO NOTICE	CLAIM NOTICE
205	76	13-DCI-000114	SEPT. 16, 2016	Oct. 31, 2016
206	76	13-DCI-000117	SEPT. 16, 2016	Oct. 31, 2016
207	77	13-DCI-000118	SEPT. 16, 2016	Oct. 31, 2016
208	79	13-DCI-000119	SEPT. 16, 2016	Oct. 31, 2016
209	79	13-DCI-000122	SEPT. 16, 2016	Oct. 31, 2016
210	80	13-DCI-000123	SEPT. 16, 2016	Oct. 31, 2016
211	80	13-DCI-000124	SEPT. 16, 2016	Oct. 31, 2016
212	81	13-DCI-000125	SEPT. 16, 2016	Oct. 31, 2016
213	82	13-DCI-000126	SEPT. 16, 2016	Oct. 31, 2016
214	83	13-DCI-000127	SEPT. 16, 2016	Oct. 31, 2016
215	83	13-DCI-000128	SEPT. 16, 2016	Oct. 31, 2016
216	84	13-DCI-000129	SEPT. 16, 2016	Oct. 31, 2016
217	84	13-DCI-000130	SEPT. 16, 2016	Oct. 31, 2016
218	85	13-DCI-000131	SEPT. 16, 2016	Oct. 31, 2016
219	85	13-DCI-000132	SEPT. 16, 2016	Oct. 31, 2016
220	86	13-DCI-000133	SEPT. 16, 2016	Oct. 31, 2016
221	86	13-DCI-000368	SEPT. 16, 2016	Oct. 31, 2016
222	86	13-DCI-000369	SEPT. 16, 2016	Oct. 31, 2016
223	87	13-DCI-000370	SEPT. 16, 2016	Oct. 31, 2016
224	88	13-DCI-000371	SEPT. 16, 2016	Oct. 31, 2016
225	88	13-DCI-000372	SEPT. 16, 2016	Oct. 31, 2016
226	89	13-DCI-000373	SEPT. 16, 2016	Oct. 31, 2016
227	90	13-DCI-000054	SEPT. 16, 2016	Oct. 31, 2016
228	90	13-DCI-000060	SEPT. 16, 2016	Oct. 31, 2016
229	98	CN CF418-259	SEPT. 16, 2016	Oct. 31, 2016
230	104	16-FBI-004859	SEPT. 16, 2016	Oct. 31, 2016
231	104	16-FBI-005072	SEPT. 16, 2016	Oct. 31, 2016
232	150	16-FBI-003457	SEPT. 16, 2016	Oct. 31, 2016
233	177	15-FBI-007434	SEPT. 16, 2016	Oct. 31, 2016
234	177	15-FBI-007438	SEPT. 16, 2016	Oct. 31, 2016
235	209	16-FBI-005082	SEPT. 16, 2016	Oct. 31, 2016
236	209	16-FBI-005083	SEPT. 16, 2016	Oct. 31, 2016
237	209	16-FBI-005084	SEPT. 16, 2016	Oct. 31, 2016
238	222	16-FBI-002964	SEPT. 16, 2016	Oct. 31, 2016
239	228	16-INT-000006	SEPT. 16, 2016	Oct. 31, 2016
240	272	CN 4:15-CR-125	SEPT. 16, 2016	Oct. 31, 2016
241	289	16-DCI-000236	SEPT. 16, 2016	Oct. 31, 2016
242	289	16-DCI-000237	SEPT. 16, 2016	Oct. 31, 2016
243	289	16-DCI-000238	SEPT. 16, 2016	Oct. 31, 2016
244	289	16-DCI-000239	SEPT. 16, 2016	Oct. 31, 2016
245	296	14-ICE-002486	SEPT. 16, 2016	Oct. 31, 2016
246	296	14-ICE-002487	SEPT. 16, 2016	Oct. 31, 2016
247	148	15-DEA-610630	SEPT. 17, 2016	Oct. 31, 2016
248	152	16-ATF-022658	SEPT. 17, 2016	Oct. 31, 2016
249	125	14-DEA-603900	SEPT. 17, 2016	Oct. 31, 2016
250	125	14-DEA-603901	SEPT. 17, 2016	Oct. 31, 2016
251	125	14-DEA-610478	SEPT. 17, 2016	Oct. 31, 2016
252	125	14-DEA-610479	SEPT. 17, 2016	Oct. 31, 2016
253	125	14-DEA-610481	SEPT. 17, 2016	Oct. 31, 2016
254	125	14-DEA-623971	SEPT. 17, 2016	Oct. 31, 2016
255	171	15-ATF-027712	SEPT. 17, 2016	Oct. 31, 2016
256	171	15-ATF-027713	SEPT. 17, 2016	Oct. 31, 2016
257	171	15-ATF-027714	SEPT. 17, 2016	Oct. 31, 2016
258	171	15-ATF-027715	SEPT. 17, 2016	Oct. 31, 2016
259	171	15-ATF-027716	SEPT. 17, 2016	Oct. 31, 2016
260	171	15-ATF-027717	SEPT. 17, 2016	Oct. 31, 2016
261	210	15-FBI-007240	SEPT. 17, 2016	Oct. 31, 2016
262	218	16-FBI-004942	SEPT. 17, 2016	Oct. 31, 2016
263	240	15-ATF-027844	SEPT. 17, 2016	Oct. 31, 2016
264	242	15-ATF-026451	SEPT. 17, 2016	Oct. 31, 2016
265	287	15-DEA-624843	SEPT. 17, 2016	Oct. 31, 2016
266	246	16-DCI-000020	SEPT. 19, 2016	Oct. 31, 2016
267	246	16-DCI-000021	SEPT. 19, 2016	Oct. 31, 2016
268	34	15-USS-000289	SEPT. 20, 2016	Oct. 31, 2016
269	46	15-DEA-620897	SEPT. 20, 2016	Oct. 31, 2016
270	131	16-FBI-003133	SEPT. 20, 2016	Oct. 31, 2016
271	131	16-FBI-003137	SEPT. 20, 2016	Oct. 31, 2016

2017-002378 MISC Page: 556 of 693

03/10/2017 12:35:10 PM Receipt #: 17-1634
Rec Fee: \$250.00 Darrell James Hill
Gila County, Az, Sadie Jo Bingham, Recorder



2022-011769 MISC Page: 760 of 2782

09/26/2022 09:35:37 PM Receipt #: 22-9381
Rec Fee: \$30.00 Darrell James Hill
Gila County, Az, Sadie Jo Bingham, Recorder



Title:

Author:

Date: 11/9/16

ID:	CLAIM PAGE #	PROPERTY ITEM #	USAO NOTICE	CLAIM NOTICE
272	133	13-DCI-000212	SEPT. 20, 2016	Oct. 31, 2016
273	139	16-ATF-017420	SEPT. 20, 2016	Oct. 31, 2016
274	139	16-ATF-017421	SEPT. 20, 2016	Oct. 31, 2016
275	172	15-ICE-002724	SEPT. 20, 2016	Oct. 31, 2016
276	175	15-FBI-004240	SEPT. 20, 2016	Oct. 31, 2016
277	189	16-ICE001121	SEPT. 20, 2016	Oct. 31, 2016
278	189	16-ICE001122	SEPT. 20, 2016	Oct. 31, 2016
278	153	12-FBI-007120	SEPT. 20, 2016	Oct. 31, 2016
280	153	12-FBI-007379	SEPT. 20, 2016	Oct. 31, 2016
281	154	12-FBI-007028	SEPT. 20, 2016	Oct. 31, 2016
282	154	12-FBI-007031	SEPT. 20, 2016	Oct. 31, 2016
283	154	12-FBI-007042	SEPT. 20, 2016	Oct. 31, 2016
284	154	12-FBI-007122	SEPT. 20, 2016	Oct. 31, 2016
285	154	12-FBI-007123	SEPT. 20, 2016	Oct. 31, 2016
286	154	12-FBI-007124	SEPT. 20, 2016	Oct. 31, 2016
287	154	12-FBI-007125	SEPT. 20, 2016	Oct. 31, 2016
288	155	12-FBI-007126	SEPT. 20, 2016	Oct. 31, 2016
289	156	12-FBI-007121	SEPT. 20, 2016	Oct. 31, 2016
290	156	12-FBI-007249	SEPT. 20, 2016	Oct. 31, 2016
291	156	12-FBI-007250	SEPT. 20, 2016	Oct. 31, 2016
292	244	09-IRS-001035	SEPT. 20, 2016	Oct. 31, 2016
293	280	14-ATF-025829	SEPT. 20, 2016	Oct. 31, 2016
294	280	14-ATF-025820	SEPT. 20, 2016	Oct. 31, 2016
295	280	14-ATF-025831	SEPT. 20, 2016	Oct. 31, 2016
296	280	14-ATF-027692	SEPT. 20, 2016	Oct. 31, 2016
297	280	14-ATF-018413	SEPT. 20, 2016	Oct. 31, 2016
298	280	14-ATF-018414	SEPT. 20, 2016	Oct. 31, 2016
299	280	14-ATF-018416	SEPT. 20, 2016	Oct. 31, 2016
300	280	14-ATF-018417	SEPT. 20, 2016	Oct. 31, 2016
301	283	16-ATF-001585	SEPT. 20, 2016	Oct. 31, 2016
302	283	16-ATF-001587	SEPT. 20, 2016	Oct. 31, 2016
303	283	16-ATF-018514	SEPT. 20, 2016	Oct. 31, 2016

Unofficial

2022-011769 MISC Page: 761 of 2782

09/26/2022 03:35:37 PM Receipt #: 22-9381
Rec Fee: \$30.00 Darrell James Hill
Gila County, Az, Sadie Jo Bingham, Recorder



2017-002378 MISC Page: 557 of 693

09/10/2017 12:35:10 PM Receipt #: 17-1634
Rec Fee: \$250.00 Darrell James Hill
Gila County, Az, Sadie Jo Bingham, Recorder



Page 5/5

374

APACHE JUNCTION
 151 W SUPERSTITION BLVD
 APACHE JUNCTION
 AZ
 85120-9998
 0302590130
 (800)275-8777 4:21 PM
 11/10/2016

Product Description	Sale Qty	Final Price
First-Class Mail Letter (Domestic) (WASHINGTON, DC 20530) (Weight: 0 Lb 1.40 Oz) (Expected Delivery Day) (Monday 11/14/2016)	1	\$0.68
Certified (99USPS Certified Mail #) (70160340000064027789)		\$3.30
Total		\$3.98
Cash		\$4.00
Change		(\$0.02)

Text your tracking number to 28777 (2USPS) to get the latest status. Standard Message and Data rates may apply. You may also visit USPS.com USPS Tracking or call 1-800-222-1811.

In a hurry? Self-service kiosks offer quick and easy check-out. Any Retail Associate can show you how.

BRIGHTEN SOMEONE'S MAILBOX. Greeting cards available for purchase at select Post Offices.

U.S. Postal Service™
CERTIFIED MAIL® RECEIPT
 Domestic Mail Only

For delivery information, visit our website at www.usps.com

WASHINGTON DC 20530

Certified Mail Fee	\$3.30
Extra Services & Fees (check box, add fee as appropriate)	\$0.00
<input type="checkbox"/> Return Receipt (hardcopy)	\$0.00
<input type="checkbox"/> Return Receipt (electronic)	\$0.00
<input type="checkbox"/> Certified Mail Restricted Delivery	\$0.00
<input type="checkbox"/> Adult Signature Required	\$0.00
<input type="checkbox"/> Adult Signature Restricted Delivery	\$0.00
Postage	\$0.68
Total Postage and Fees	\$3.98

Postmark Here
 11/10/2016

Sent: Loretta: U.S. Attorney General
 950 Pennsylvania Avenue, N.W.
 Washington, District of Columbia
 20530-0001

PS Form 3800, April 2015 PSN 7531-029-0007 See Reverse for Instructions

7016 0340 000 6402 7789

Handwritten signature/initials

2017-002378 MISC Page: 538 of 693
 03/10/2017 12:35:10 PM Receipt #: 17-1634
 Rec Fee: \$250.00 Darrell James Hill
 Gila County, Az, Sadie Jo Bingham, Recorder

2022-011769 MISC Page: 762 of 2782
 09/26/2022 03:35:37 PM Receipt #: 22-9381
 Rec Fee: \$30.00 Darrell James Hill
 Gila County, Az, Sadie Jo Bingham, Recorder



USPS Tracking®

Still Have Questions? Browse our FAQs



Tracking Number: 7016034000064027789

Updated Delivery Day: Wednesday, November 16, 2016

Product & Tracking Information

Available for Pickup

Postal Product:
First-Class Mail®

Features:
Certified Mail™

Text Updates

DATE & TIME

STATUS OF ITEM

LOCATION

Email Updates

November 16, 2016, 5:24 am

Delivered

WASHINGTON, DC 20530

Your item was delivered at 5:24 am on November 16, 2016 in WASHINGTON, DC 20530.

November 15, 2016, 12:54 pm

Available for Pickup

WASHINGTON, DC 20530

November 15, 2016, 12:30 pm

Arrived at Unit

WASHINGTON, DC 20018

November 11, 2016, 11:43 pm

In Transit to Destination

November 11, 2016, 8:32 am

Departed USPS Facility

PHOENIX, AZ 85028

November 10, 2016, 10:44 pm

Arrived at USPS Origin Facility

PHOENIX, AZ 85028

November 10, 2016, 4:24 pm

Departed Post Office

APACHE JUNCTION, AZ 85120

November 10, 2016, 4:20 pm

Acceptance

APACHE JUNCTION, AZ 85120

2022-011769 MISC Page: 763 of 2782
 09/25/2022 03:35:37 PM Receipt #: 22-9381
 Rec Fee: \$30.00 Darrell James Hill
 Gila County, Az, Sadie Jo Bingham, Recorder

1 of 2

11/16/2016 12:19 PM

2017-002378 MISC Page: 559 of 693

03/10/2017 12:35:10 PM Receipt #: 17-1634
 Rec Fee: \$250.00 Darrell James Hill
 Gila County, Az, Sadie Jo Bingham, Recorder



376

Darrell- James: Hill, 5124 East 18th Avenue, Apache Junction, Arizona [85119]
USPS RMN RB 898 810 007 US

Loretta: U.S. Attorney General
950 Pennsylvania Avenue, N.W.
Washington, District of Columbia [20530-0001]

NOTICE: Cease and Desist

- RE: a) Notice 103116; USPS RE 322399279US; 09/13-20/16 PROPERTY POSTING TABLE: USPS CMN 7016 0340 0000 6402 7789; sent: 11/10/2016; received: 11/15/2016.
b) Notice 103116; USPS RE 322399279US; 09/21-27/16 PROPERTY POSTING TABLE: USPS RMN RB 898 810 007 US
c) Notice 103116; USPS RE 322399279US; 09/28-10/12/16 PROPERTY POSTING TABLE: USPS RMN RB 898 810 007 US

Loretta, Greetings:

- i: man: Darrell- James: Hill; made claim upon you for property by the USPS RMN RE 322 399 279 US; sent: October 25, 2016; received: October 31, 2016;
- a) have not heard from you regarding my property claim;
 - b) sent: Cease and Desist, RE: a) Notice 103116; USPS RE 322399279US; 09/13-20/16 PROPERTY POSTING TABLE: USPS CMN 7016 0340 0000 6402 7789; sent: 11/10/2016; received: 11/15/2016; Enclosure One:
 - c) send: Cease and Desist, RE: b) Notice 103116; USPS RE 322399279US; 09/21-27/16 PROPERTY POSTING TABLE: USPS RMN RB 898 810 007 US; Enclosure Two: and,
 - d) send: Cease and Desist, RE: c) Notice 103116; USPS RE 322399279US; 09/28-10/12/16 PROPERTY POSTING TABLE: USPS RMN RB 898 810 007 US; Enclosure Three;
 - e) require you to dispose the property claimed by me to me immediately following the 'person's 60-day claim period with the court' is completed;
 - f) believe it would be wrong for you to not dispose to me all of the property claimed immediately as required; and,
 - g) believe that trespass upon my property rights must result in a claim against trespass.

Loretta: by trespass upon my property claimed, at 24 hours after the 'person's 60-day claim period with the court' and ending at 24 hours before the disposition to me of the property claimed, you agree to 1) be obligated to pay trespass costs at one silver

USPS RMN RB 898 810 007 US

2017-002378 MISC Page: 561 of 693
03/10/2017 12:35:10 PM Receipt #: 17-1634
Rec Fee: \$250.00 Darrell- James: Hill
Gila County, Az, Sadie Jo Bingham, Recorder

2022-011769 MISC Page: 764 of 2782
09/26/2022 03:35:37 PM Receipt #: 22-9381
Rec Fee: \$30.00 Darrell James Hill
Gila County, Az, Sadie Jo Bingham, Recorder

1/5

378

Darrell- James: Hill, 5124 East 18th Avenue, Apache Junction, Arizona [85119]

USPS RMN RB 898 810 007 US

dollar per minute until the property is disposed to me; including, 2) tacit agreement for unimpeded, uncontested judgment for the all trespass and receipt of property claimed costs.

I wish to hear from you soon so that we may resolve this matter in private.

Thank you Loretta,

11/16/2016 Darrell- James: Hill
Darrell- James: Hill

UNOFFICIAL

USPS RMN RB 898 810 007 US

2/5

2017-002378 MISC Page: 562 of 693
03/10/2017 12:35:10 PM Receipt #: 17-1634
Rec Fee: \$250.00 Darrell- James: Hill
Gila County, Az, Sadie Jo Bingham, Recorder

2022-011769 MISC Page: 765 of 2782
09/26/2022 03:35:37 PM Receipt #: 22-9381
Rec Fee: \$30.00 Darrell James Hill
Gila County, Az, Sadie Jo Bingham, Recorder



786

Darrell- James: Hill, 5124 East 18th Avenue, Apache Junction, Arizona [85119]

USPS RMN RB 898 810 007 US

COPY

Notice 103116; USPS RE 322399279US; 09/13-20/16 PROPERTY POSTING
TABLE: USPS CMN 7016 0340 0000 6402 7789; sent: 11/10/2016; received: 11/15/2016.

Enclosure One-

2022-011769 MISC Page: 766 of 2782
09/25/2022 03:35:37 PM Receipt #: 22-9981

Darrell James Hill
Sadie Jo Bingham, Recorder
Gila County, Az



USPS RMN RB 898 810 007 US

3/5

2017-002378 MISC Page: 563 of 693
03/10/2017 12:35:10 PM Receipt #: 17-1634
Rec Fee: \$250.00 Darrell- James: Hill
Gila County, Az, Sadie Jo Bingham, Recorder



380

Unofficial Copy

767

Darrell- James: Hill, 5124 East 18th Avenue, Apache Junction, Arizona [85119]

USPS CMN 7016 0340 0000 6402 7789

Loretta: U.S. Attorney General
950 Pennsylvania Avenue, N.W.
Washington, District of Columbia [20530-0001]

NOTICE: Cease and Desist

RE: October 31st, 2016 Registered Mail Notice: Claim RE 322 399 279 US: Sept. 13th to 20th, 2016
Property Claimed Table: Enclosure One: 5 pages.

Loretta, Greetings:

- i man:
- darrell-james: Hill; made claim upon you for property by the USPS RMN RE 322 399 279 US; sent: October 25, 2016; received: October 31, 2016;
 - have not heard or otherwise received response from you concerning the property; therefore,
 - send this Cease and Desist to stop any harm to me by your any action to delay disposal of the property claimed to me after the 'person's 60-day claim period with the court' is completed;
 - require you to dispose the property claimed by me to me immediately following the 'person's 60-day claim period with the court' is completed;
 - believe it would be wrong for you to not dispose to me all of the property claimed immediately as required; and,
 - believe that trespass upon my property rights must result in a claim against trespass.

Loretta: by trespass upon my property claimed, at 24 hours after the 'person's 60-day claim period with the court' and ending at 24 hours before the disposition to me of the property claimed, you agree to 1) be obligated to pay trespass costs at one silver dollar per minute until the property is disposed to me; including, 2) tacit agreement for unimpeded, uncontested judgment for the all trespass and receipt of property claimed costs.

Thank you Loretta,

11/10/2016 Darrell-James Hill
Darrell-James: Hill

USPS CMN 7016 0340 0000 6402 7789

1/2

2017-002378 MISC Page: 564 of 693

03/10/2017 12:35:10 PM Receipt #: 17-1634
Rec Fee: \$250.00 Darrell-James: Hill
Gila County, Az, Sadie Jo Bingham, Recorder



2022-011769 MISC Page: 767 of 2782

09/26/2022 03:35:37 PM Receipt #: 22-9381
Rec Fee: \$30.00 Darrell James Hill
Gila County, Az, Sadie Jo Bingham, Recorder



COPY

Enclosure One-
October 31st, 2016 Registered Mail Notice: Claim RE 322 399 279 US:
Sept. 13th to 20th, 2016 Property Claimed Table,
5 pages.

UNFILED

USPS CMN 7016 0340 0000 6402 7789

2/2

769

2017-002378 MISC Page: 565 of 693
03/10/2017 12:35:10 PM Receipt #: 17-1634
Rec Fee: \$250.00 Darrell-James Hill
Gila County, Az, Sadie Jo Bingham, Recorder



2022-011769 MISC Page: 768 of 2782
09/26/2022 03:35:37 PM Receipt #: 22-9381
Rec Fee: \$30.00 Darrell James Hill
Gila County, Az, Sadie Jo Bingham, Recorder



Title:

Author:
Date: 11/9/16

ID:	CLAIM PAGE #	PROPERTY ITEM #	USAO NOTICE	CLAIM NOTICE
1	22	14-FBI-008363	SEPT. 13, 2016	Oct. 31, 2016
2	135	15-FBI-004903	SEPT. 13, 2016	Oct. 31, 2016
3	138	15-FBI-004905	SEPT. 13, 2016	Oct. 31, 2016
4	181	16-FBI-001066	SEPT. 13, 2016	Oct. 31, 2016
5	182	15-FBI-004306	SEPT. 13, 2016	Oct. 31, 2016
6	182	15-FBI-004734	SEPT. 13, 2016	Oct. 31, 2016
7	185	15-FBI-005383	SEPT. 13, 2016	Oct. 31, 2016
8	167	16-ATF-021874	SEPT. 13, 2016	Oct. 31, 2016
9	167	16-ATF-021877	SEPT. 13, 2016	Oct. 31, 2016
10	167	16-ATF-021879	SEPT. 13, 2016	Oct. 31, 2016
11	167	16-ATF-021881	SEPT. 13, 2016	Oct. 31, 2016
12	167	16-ATF-021883	SEPT. 13, 2016	Oct. 31, 2016
13	167	16-ATF-021884	SEPT. 13, 2016	Oct. 31, 2016
14	176	16-INT-000010	SEPT. 13, 2016	Oct. 31, 2016
15	226	16-FBI-003487	SEPT. 13, 2016	Oct. 31, 2016
16	226	16-FBI-003508	SEPT. 13, 2016	Oct. 31, 2016
17	226	16-FBI-003510	SEPT. 13, 2016	Oct. 31, 2016
18	226	16-FBI-003587	SEPT. 13, 2016	Oct. 31, 2016
19	226	16-FBI-003588	SEPT. 13, 2016	Oct. 31, 2016
20	226	16-FBI-003642	SEPT. 13, 2016	Oct. 31, 2016
21	226	16-FBI-003896	SEPT. 13, 2016	Oct. 31, 2016
22	226	16-FBI-003898	SEPT. 13, 2016	Oct. 31, 2016
23	226	16-FBI-003903	SEPT. 13, 2016	Oct. 31, 2016
24	226	16-FBI-003905	SEPT. 13, 2016	Oct. 31, 2016
25	227	16-FBI-003921	SEPT. 13, 2016	Oct. 31, 2016
26	227	16-FBI-003925	SEPT. 13, 2016	Oct. 31, 2016
27	227	16-FBI-003938	SEPT. 13, 2016	Oct. 31, 2016
28	227	16-FBI-003940	SEPT. 13, 2016	Oct. 31, 2016
29	232	16-DEA-624056	SEPT. 13, 2016	Oct. 31, 2016
30	239	15-FBI-003674	SEPT. 13, 2016	Oct. 31, 2016
31	258	15-ATF-026702	SEPT. 13, 2016	Oct. 31, 2016
32	263	16-ATF-015317	SEPT. 13, 2016	Oct. 31, 2016
33	264	16-ATF-015302	SEPT. 13, 2016	Oct. 31, 2016
34	2	15-DEA-613045	SEPT. 14, 2016	Oct. 31, 2016
35	2	15-DEA-613918	SEPT. 14, 2016	Oct. 31, 2016
36	27	16-FBI-004891	SEPT. 14, 2016	Oct. 31, 2016
37	31	16-FBI-001346	SEPT. 14, 2016	Oct. 31, 2016
38	31	16-FBI-001364	SEPT. 14, 2016	Oct. 31, 2016
39	31	16-FBI-001365	SEPT. 14, 2016	Oct. 31, 2016
40	31	16-FBI-001456	SEPT. 14, 2016	Oct. 31, 2016
41	31	16-FBI-001458	SEPT. 14, 2016	Oct. 31, 2016
42	31	16-FBI-001515	SEPT. 14, 2016	Oct. 31, 2016
43	31	16-FBI-001533	SEPT. 14, 2016	Oct. 31, 2016
44	31	16-FBI-001582	SEPT. 14, 2016	Oct. 31, 2016
45	32	16-FBI-001586	SEPT. 14, 2016	Oct. 31, 2016
46	120	16-DEA-624736	SEPT. 14, 2016	Oct. 31, 2016
47	130	16-FBI-002489	SEPT. 14, 2016	Oct. 31, 2016
48	130	16-FBI-002491	SEPT. 14, 2016	Oct. 31, 2016
49	130	16-FBI-002492	SEPT. 14, 2016	Oct. 31, 2016
50	130	16-FBI-002493	SEPT. 14, 2016	Oct. 31, 2016
51	130	16-FBI-002501	SEPT. 14, 2016	Oct. 31, 2016
52	132	16-FBI-005086	SEPT. 14, 2016	Oct. 31, 2016
53	144	15-FBI-007182	SEPT. 14, 2016	Oct. 31, 2016
54	144	15-FBI-007210	SEPT. 14, 2016	Oct. 31, 2016
55	144	15-FBI-007212	SEPT. 14, 2016	Oct. 31, 2016
56	144	15-FBI-007213	SEPT. 14, 2016	Oct. 31, 2016
57	145	15-FBI-007215	SEPT. 14, 2016	Oct. 31, 2016
58	230	16-ATF-023682	SEPT. 14, 2016	Oct. 31, 2016
59	230	16-ATF-023683	SEPT. 14, 2016	Oct. 31, 2016
60	230	16-ATF-023684	SEPT. 14, 2016	Oct. 31, 2016
61	243	11-ATF-032526	SEPT. 14, 2016	Oct. 31, 2016
62	243	14-ATF-024883	SEPT. 14, 2016	Oct. 31, 2016
63	268	16-ATF-018526	SEPT. 14, 2016	Oct. 31, 2016
64	269	16-ATF-010292	SEPT. 14, 2016	Oct. 31, 2016
65	270	16-ATF-013073	SEPT. 14, 2016	Oct. 31, 2016

790

2017-002378 MISC Page: 566 of 693
 03/10/2017 12:35:10 PM Receipt #: 17-1634
 Rec Fee: \$250.00 Darrell James Hill
 Gila County, Az, Sadie Jo Bingham, Recorder

2022-011769 MISC Page: 769 of 2782
 09/26/2022 03:35:37 PM Receipt #: 22-9381
 Rec Fee: \$30.00 Darrell James Hill
 Gila County, Az, Sadie Jo Bingham, Recorder



Title:

Author:

Date: 11/9/16

ID	CLAIM PAGE #	PROPERTY ITEM #	USAO NOTICE	CLAIM NOTICE
66	284	16-ATF-004518	SEPT. 14, 2016	Oct. 31, 2016
67	284	16-ATF-004520	SEPT. 14, 2016	Oct. 31, 2016
68	284	16-ATF-004521	SEPT. 14, 2016	Oct. 31, 2016
69	284	16-ATF-004522	SEPT. 14, 2016	Oct. 31, 2016
70	301	16-ICE-000439	SEPT. 14, 2016	Oct. 31, 2016
71	301	16-ICE-000440	SEPT. 14, 2016	Oct. 31, 2016
72	301	16-ICE-000441	SEPT. 14, 2016	Oct. 31, 2016
73	107	16-ATF-011826	SEPT. 15, 2016	Oct. 31, 2016
74	107	SN: K441176	SEPT. 15, 2016	Oct. 31, 2016
75	107	16-ATF-011828	SEPT. 15, 2016	Oct. 31, 2016
76	107	16-ATF-011832	SEPT. 15, 2016	Oct. 31, 2016
77	107	16-ATF-011833	SEPT. 15, 2016	Oct. 31, 2016
78	107	16-ATF-011834	SEPT. 15, 2016	Oct. 31, 2016
79	107	16-ATF-011835	SEPT. 15, 2016	Oct. 31, 2016
80	107	16-ATF-011836	SEPT. 15, 2016	Oct. 31, 2016
81	107	16-ATF-011837	SEPT. 15, 2016	Oct. 31, 2016
82	107	16-ATF-011838	SEPT. 15, 2016	Oct. 31, 2016
83	107	16-ATF-011839	SEPT. 15, 2016	Oct. 31, 2016
84	107	16-ATF-011840	SEPT. 15, 2016	Oct. 31, 2016
85	108	16-ATF-011841	SEPT. 15, 2016	Oct. 31, 2016
86	108	16-ATF-011842	SEPT. 15, 2016	Oct. 31, 2016
87	108	16-ATF-011843	SEPT. 15, 2016	Oct. 31, 2016
88	108	16-ATF-011844	SEPT. 15, 2016	Oct. 31, 2016
89	108	16-ATF-011845	SEPT. 15, 2016	Oct. 31, 2016
90	108	16-ATF-011847	SEPT. 15, 2016	Oct. 31, 2016
91	108	16-ATF-011848	SEPT. 15, 2016	Oct. 31, 2016
92	108	16-ATF-011849	SEPT. 15, 2016	Oct. 31, 2016
93	108	16-ATF-011850	SEPT. 15, 2016	Oct. 31, 2016
94	185	14-ATF-025087	SEPT. 15, 2016	Oct. 31, 2016
95	276	CN M-15-CR-760(a)	SEPT. 15, 2016	Oct. 31, 2016
96	276	CN M-15-CR-760(b)	SEPT. 15, 2016	Oct. 31, 2016
97	276	CN M-15-CR-760(c)	SEPT. 15, 2016	Oct. 31, 2016
98	276	CN M-15-CR-760(d)	SEPT. 15, 2016	Oct. 31, 2016
99	231	14-ATF-027736	SEPT. 15, 2016	Oct. 31, 2016
100	38	15-ICE-002945	SEPT. 16, 2016	Oct. 31, 2016
101	49	13-DCI-000012	SEPT. 16, 2016	Oct. 31, 2016
102	49	13-DCI-000013	SEPT. 16, 2016	Oct. 31, 2016
103	49	13-DCI-000014	SEPT. 16, 2016	Oct. 31, 2016
104	49	13-DCI-000015	SEPT. 16, 2016	Oct. 31, 2016
105	49	13-DCI-000016	SEPT. 16, 2016	Oct. 31, 2016
106	49	13-DCI-000017	SEPT. 16, 2016	Oct. 31, 2016
107	50	13-DCI-000018	SEPT. 16, 2016	Oct. 31, 2016
108	50	13-DCI-000019	SEPT. 16, 2016	Oct. 31, 2016
109	50	13-DCI-000020	SEPT. 16, 2016	Oct. 31, 2016
110	50	13-DCI-000021	SEPT. 16, 2016	Oct. 31, 2016
111	50	13-DCI-000022	SEPT. 16, 2016	Oct. 31, 2016
112	50	13-DCI-000023	SEPT. 16, 2016	Oct. 31, 2016
113	50	13-DCI-000025	SEPT. 16, 2016	Oct. 31, 2016
114	50	13-DCI-000026	SEPT. 16, 2016	Oct. 31, 2016
115	50	13-DCI-000027	SEPT. 16, 2016	Oct. 31, 2016
116	50	13-DCI-000028	SEPT. 16, 2016	Oct. 31, 2016
117	51	13-DCI-000030	SEPT. 16, 2016	Oct. 31, 2016
118	51	13-DCI-000031	SEPT. 16, 2016	Oct. 31, 2016
119	51	13-DCI-000032	SEPT. 16, 2016	Oct. 31, 2016
120	51	13-DCI-000033	SEPT. 16, 2016	Oct. 31, 2016
121	52	13-DCI-000034	SEPT. 16, 2016	Oct. 31, 2016
122	52	13-DCI-000035	SEPT. 16, 2016	Oct. 31, 2016
123	53	13-DCI-000036	SEPT. 16, 2016	Oct. 31, 2016
124	53	13-DCI-000037	SEPT. 16, 2016	Oct. 31, 2016
125	53	13-DCI-000038	SEPT. 16, 2016	Oct. 31, 2016
126	54	13-DCI-000039	SEPT. 16, 2016	Oct. 31, 2016
127	54	13-DCI-000040	SEPT. 16, 2016	Oct. 31, 2016
128	54	13-DCI-000041	SEPT. 16, 2016	Oct. 31, 2016
129	55	13-DCI-000042	SEPT. 16, 2016	Oct. 31, 2016
130	55	13-DCI-000043	SEPT. 16, 2016	Oct. 31, 2016
131	55	13-DCI-000044	SEPT. 16, 2016	Oct. 31, 2016
132	56	13-DCI-000045	SEPT. 16, 2016	Oct. 31, 2016

2017-002378 MISC Page: 567 of 693

03/10/2017 12:35:10 PM Receipt #: 17-1634

Rec Fee: \$250.00 Darrell James Hill

Gila County, Az. Sadie Jo Bingham, Recorder



2022-011769 MISC Page: 770 of 2782

09/26/2022 03:35:37 PM Receipt #: 22-9381

Rec Fee: \$30.00 Darrell James Hill

Gila County, Az. Sadie Jo Bingham, Recorder

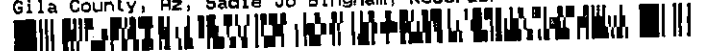

Title:

Author:

Date: 11/9/16

ID:	CLAIM PAGE #	PROPERTY ITEM #	USAO NOTICE	CLAIM NOTICE
133	56	13-DCI-000046	SEPT. 16, 2016	Oct. 31, 2016
134	56	13-DCI-000047	SEPT. 16, 2016	Oct. 31, 2016
135	57	13-DCI-000048	SEPT. 16, 2016	Oct. 31, 2016
136	57	13-DCI-000049	SEPT. 16, 2016	Oct. 31, 2016
137	57	13-DCI-000050	SEPT. 16, 2016	Oct. 31, 2016
138	57	13-DCI-000051	SEPT. 16, 2016	Oct. 31, 2016
139	58	13-DCI-000052	SEPT. 16, 2016	Oct. 31, 2016
140	58	13-DCI-000053	SEPT. 16, 2016	Oct. 31, 2016
141	58	13-DCI-000054	SEPT. 16, 2016	Oct. 31, 2016
144	59	13-DCI-000055	SEPT. 16, 2016	Oct. 31, 2016
145	59	13-DCI-000056	SEPT. 16, 2016	Oct. 31, 2016
146	59	13-DCI-000057	SEPT. 16, 2016	Oct. 31, 2016
147	60	13-DCI-000058	SEPT. 16, 2016	Oct. 31, 2016
148	60	13-DCI-000059	SEPT. 16, 2016	Oct. 31, 2016
149	60	13-DCI-000060	SEPT. 16, 2016	Oct. 31, 2016
150	61	13-DCI-000061	SEPT. 16, 2016	Oct. 31, 2016
151	61	13-DCI-000062	SEPT. 16, 2016	Oct. 31, 2016
152	61	13-DCI-000063	SEPT. 16, 2016	Oct. 31, 2016
153	61	13-DCI-000064	SEPT. 16, 2016	Oct. 31, 2016
154	62	13-DCI-000065	SEPT. 16, 2016	Oct. 31, 2016
155	62	13-DCI-000066	SEPT. 16, 2016	Oct. 31, 2016
156	62	13-DCI-000067	SEPT. 16, 2016	Oct. 31, 2016
157	63	13-DCI-000068	SEPT. 16, 2016	Oct. 31, 2016
158	63	13-DCI-000069	SEPT. 16, 2016	Oct. 31, 2016
159	63	13-DCI-000070	SEPT. 16, 2016	Oct. 31, 2016
160	64	13-DCI-000071	SEPT. 16, 2016	Oct. 31, 2016
161	64	13-DCI-000072	SEPT. 16, 2016	Oct. 31, 2016
162	65	13-DCI-000073	SEPT. 16, 2016	Oct. 31, 2016
163	65	13-DCI-000074	SEPT. 16, 2016	Oct. 31, 2016
164	65	13-DCI-000075	SEPT. 16, 2016	Oct. 31, 2016
165	66	13-DCI-000076	SEPT. 16, 2016	Oct. 31, 2016
166	66	13-DCI-000077	SEPT. 16, 2016	Oct. 31, 2016
167	66	13-DCI-000078	SEPT. 16, 2016	Oct. 31, 2016
168	67	13-DCI-000079	SEPT. 16, 2016	Oct. 31, 2016
169	67	13-DCI-000080	SEPT. 16, 2016	Oct. 31, 2016
170	67	13-DCI-000081	SEPT. 16, 2016	Oct. 31, 2016
174	68	13-DCI-000082	SEPT. 16, 2016	Oct. 31, 2016
175	68	13-DCI-000083	SEPT. 16, 2016	Oct. 31, 2016
176	68	13-DCI-000084	SEPT. 16, 2016	Oct. 31, 2016
177	68	13-DCI-000085	SEPT. 16, 2016	Oct. 31, 2016
178	69	13-DCI-000086	SEPT. 16, 2016	Oct. 31, 2016
179	69	13-DCI-000087	SEPT. 16, 2016	Oct. 31, 2016
180	69	13-DCI-000088	SEPT. 16, 2016	Oct. 31, 2016
181	69	13-DCI-000089	SEPT. 16, 2016	Oct. 31, 2016
182	70	13-DCI-000090	SEPT. 16, 2016	Oct. 31, 2016
183	70	13-DCI-000091	SEPT. 16, 2016	Oct. 31, 2016
184	70	13-DCI-000092	SEPT. 16, 2016	Oct. 31, 2016
185	70	13-DCI-000094	SEPT. 16, 2016	Oct. 31, 2016
186	71	13-DCI-000095	SEPT. 16, 2016	Oct. 31, 2016
187	71	13-DCI-000096	SEPT. 16, 2016	Oct. 31, 2016
188	71	13-DCI-000097	SEPT. 16, 2016	Oct. 31, 2016
189	71	13-DCI-000098	SEPT. 16, 2016	Oct. 31, 2016
190	71	13-DCI-000099	SEPT. 16, 2016	Oct. 31, 2016
191	72	13-DCI-000100	SEPT. 16, 2016	Oct. 31, 2016
192	72	13-DCI-000101	SEPT. 16, 2016	Oct. 31, 2016
193	72	13-DCI-000102	SEPT. 16, 2016	Oct. 31, 2016
194	72	13-DCI-000103	SEPT. 16, 2016	Oct. 31, 2016
195	73	13-DCI-000104	SEPT. 16, 2016	Oct. 31, 2016
196	73	13-DCI-000105	SEPT. 16, 2016	Oct. 31, 2016
197	73	13-DCI-000106	SEPT. 16, 2016	Oct. 31, 2016
198	73	13-DCI-000107	SEPT. 16, 2016	Oct. 31, 2016
199	73	13-DCI-000108	SEPT. 16, 2016	Oct. 31, 2016
200	74	13-DCI-000109	SEPT. 16, 2016	Oct. 31, 2016
201	74	13-DCI-000110	SEPT. 16, 2016	Oct. 31, 2016
202	74	13-DCI-000111	SEPT. 16, 2016	Oct. 31, 2016
203	75	13-DCI-000112	SEPT. 16, 2016	Oct. 31, 2016
204	75	13-DCI-000113	SEPT. 16, 2016	Oct. 31, 2016

772

2017-002378 MISC Page: 568 of 693
 03/10/2017 12:35:10 PM Receipt #: 17-1634
 Rec Fee: \$250.00 Darrell James Hill
 Gila County, Az, Sadie Jo Bingham, Recorder



2022-011769 MISC Page: 771 of 2782

09/26/2022 03:35:37 PM Receipt #: 22-9381
 Rec Fee: \$30.00 Darrell James Hill
 Gila County, Az, Sadie Jo Bingham, Recorder



Title:
 Author:
 Date: 11/9/16

ID	CLAIM PAGE #	PROPERTY ITEM #	USAO NOTICE	CLAIM NOTICE
205	76	13-DCI-000114	SEPT. 16, 2016	Oct. 31, 2016
206	76	13-DCI-000117	SEPT. 16, 2016	Oct. 31, 2016
207	77	13-DCI-000118	SEPT. 16, 2016	Oct. 31, 2016
208	79	13-DCI-000119	SEPT. 16, 2016	Oct. 31, 2016
209	79	13-DCI-000122	SEPT. 16, 2016	Oct. 31, 2016
210	80	13-DCI-000123	SEPT. 16, 2016	Oct. 31, 2016
211	80	13-DCI-000124	SEPT. 16, 2016	Oct. 31, 2016
212	81	13-DCI-000126	SEPT. 16, 2016	Oct. 31, 2016
213	82	13-DCI-000128	SEPT. 16, 2016	Oct. 31, 2016
214	83	13-DCI-000127	SEPT. 16, 2016	Oct. 31, 2016
215	83	13-DCI-000128	SEPT. 16, 2016	Oct. 31, 2016
216	84	13-DCI-000129	SEPT. 16, 2016	Oct. 31, 2016
217	84	13-DCI-000130	SEPT. 16, 2016	Oct. 31, 2016
218	85	13-DCI-000131	SEPT. 16, 2016	Oct. 31, 2016
219	85	13-DCI-000132	SEPT. 16, 2016	Oct. 31, 2016
220	86	13-DCI-000133	SEPT. 16, 2016	Oct. 31, 2016
221	86	13-DCI-000368	SEPT. 16, 2016	Oct. 31, 2016
222	86	13-DCI-000369	SEPT. 16, 2016	Oct. 31, 2016
223	87	13-DCI-000370	SEPT. 16, 2016	Oct. 31, 2016
224	88	13-DCI-000371	SEPT. 16, 2016	Oct. 31, 2016
225	88	13-DCI-000372	SEPT. 16, 2016	Oct. 31, 2016
226	89	13-DCI-000373	SEPT. 16, 2016	Oct. 31, 2016
227	90	13-DCI-000054	SEPT. 16, 2016	Oct. 31, 2016
228	90	13-DCI-000060	SEPT. 16, 2016	Oct. 31, 2016
229	98	CN CF416-259	SEPT. 16, 2016	Oct. 31, 2016
230	104	16-FBI-004659	SEPT. 16, 2016	Oct. 31, 2016
231	104	16-FBI-005072	SEPT. 16, 2016	Oct. 31, 2016
232	150	16-FBI-003457	SEPT. 16, 2016	Oct. 31, 2016
233	177	16-FBI-007434	SEPT. 16, 2016	Oct. 31, 2016
234	177	15-FBI-007436	SEPT. 16, 2016	Oct. 31, 2016
235	209	16-FBI-005082	SEPT. 16, 2016	Oct. 31, 2016
236	209	16-FBI-005083	SEPT. 16, 2016	Oct. 31, 2016
237	209	16-FBI-005084	SEPT. 16, 2016	Oct. 31, 2016
238	222	16-FBI-002984	SEPT. 16, 2016	Oct. 31, 2016
239	225	16-INT-000006	SEPT. 16, 2016	Oct. 31, 2016
240	272	CN 4-15-CR-125	SEPT. 16, 2016	Oct. 31, 2016
241	289	16-DCI-000235	SEPT. 16, 2016	Oct. 31, 2016
242	289	16-DCI-000237	SEPT. 16, 2016	Oct. 31, 2016
243	289	16-DCI-000238	SEPT. 16, 2016	Oct. 31, 2016
244	289	16-DCI-000239	SEPT. 16, 2016	Oct. 31, 2016
245	286	14-ICE-002486	SEPT. 16, 2016	Oct. 31, 2016
246	296	14-ICE-002487	SEPT. 16, 2016	Oct. 31, 2016
247	148	16-DEA-610630	SEPT. 17, 2016	Oct. 31, 2016
248	162	16-ATF-022656	SEPT. 17, 2016	Oct. 31, 2016
249	125	14-DEA-803900	SEPT. 17, 2016	Oct. 31, 2016
250	125	14-DEA-803901	SEPT. 17, 2016	Oct. 31, 2016
251	125	14-DEA-810478	SEPT. 17, 2016	Oct. 31, 2016
252	125	14-DEA-810479	SEPT. 17, 2016	Oct. 31, 2016
253	125	14-DEA-810481	SEPT. 17, 2016	Oct. 31, 2016
254	125	14-DEA-823971	SEPT. 17, 2016	Oct. 31, 2016
255	171	16-ATF-027712	SEPT. 17, 2016	Oct. 31, 2016
256	171	16-ATF-027713	SEPT. 17, 2016	Oct. 31, 2016
257	171	16-ATF-027714	SEPT. 17, 2016	Oct. 31, 2016
258	171	16-ATF-027715	SEPT. 17, 2016	Oct. 31, 2016
259	171	16-ATF-027718	SEPT. 17, 2016	Oct. 31, 2016
260	171	16-ATF-027717	SEPT. 17, 2016	Oct. 31, 2016
261	210	16-FBI-007240	SEPT. 17, 2016	Oct. 31, 2016
262	216	16-FBI-004942	SEPT. 17, 2016	Oct. 31, 2016
263	240	16-ATF-027844	SEPT. 17, 2016	Oct. 31, 2016
264	242	16-ATF-026451	SEPT. 17, 2016	Oct. 31, 2016
265	267	16-DEA-824943	SEPT. 17, 2016	Oct. 31, 2016
266	248	16-DCI-000020	SEPT. 19, 2016	Oct. 31, 2016
267	248	16-DCI-000021	SEPT. 19, 2016	Oct. 31, 2016
268	34	16-USS-000290	SEPT. 20, 2016	Oct. 31, 2016
269	46	16-DEA-820897	SEPT. 20, 2016	Oct. 31, 2016
270	131	16-FBI-003133	SEPT. 20, 2016	Oct. 31, 2016
271	131	16-FBI-003137	SEPT. 20, 2016	Oct. 31, 2016

773

2017-002378 MISC Page: 569 of 693
 03/18/2017 12:35:10 PM Receipt #: 17-1634
 Rec Fee: \$250.00 Darrell James Hill
 Gila County, Az, Sadie Jo Bingham, Recorder



2022-011769 MISC Page: 772 of 2782
 09/26/2022 03:35:37 PM Receipt #: 22-9381
 Rec Fee: \$30.00 Darrell James Hill
 Gila County, Az, Sadie Jo Bingham, Recorder



Title:

Author:

Date: 11/9/16

ID:	CLAIM PAGE #	PROPERTY ITEM #	USAO NOTICE	CLAIM NOTICE
272	133	13-DCI-000212	SEPT. 20, 2016	Oct. 31, 2016
273	139	16-ATF-017420	SEPT. 20, 2016	Oct. 31, 2016
274	139	16-ATF-017421	SEPT. 20, 2016	Oct. 31, 2016
275	172	16-ICE-002724	SEPT. 20, 2016	Oct. 31, 2016
276	176	16-FBI-004240	SEPT. 20, 2016	Oct. 31, 2016
277	189	16-ICE001121	SEPT. 20, 2016	Oct. 31, 2016
278	189	16-ICE001122	SEPT. 20, 2016	Oct. 31, 2016
279	163	12-FBI-007120	SEPT. 20, 2016	Oct. 31, 2016
280	163	12-FBI-007379	SEPT. 20, 2016	Oct. 31, 2016
281	154	12-FBI-007028	SEPT. 20, 2016	Oct. 31, 2016
282	154	12-FBI-007031	SEPT. 20, 2016	Oct. 31, 2016
283	154	12-FBI-007042	SEPT. 20, 2016	Oct. 31, 2016
284	154	12-FBI-007122	SEPT. 20, 2016	Oct. 31, 2016
285	154	12-FBI-007123	SEPT. 20, 2016	Oct. 31, 2016
286	154	12-FBI-007124	SEPT. 20, 2016	Oct. 31, 2016
287	154	12-FBI-007125	SEPT. 20, 2016	Oct. 31, 2016
288	155	12-FBI-007128	SEPT. 20, 2016	Oct. 31, 2016
289	155	12-FBI-007121	SEPT. 20, 2016	Oct. 31, 2016
290	155	12-FBI-007249	SEPT. 20, 2016	Oct. 31, 2016
291	155	12-FBI-007250	SEPT. 20, 2016	Oct. 31, 2016
292	244	09-RS-001035	SEPT. 20, 2016	Oct. 31, 2016
293	280	14-ATF-025929	SEPT. 20, 2016	Oct. 31, 2016
294	280	14-ATF-025620	SEPT. 20, 2016	Oct. 31, 2016
295	280	14-ATF-025831	SEPT. 20, 2016	Oct. 31, 2016
296	280	14-ATF-027682	SEPT. 20, 2016	Oct. 31, 2016
297	280	14-ATF-018413	SEPT. 20, 2016	Oct. 31, 2016
298	280	14-ATF-018414	SEPT. 20, 2016	Oct. 31, 2016
299	280	14-ATF-018416	SEPT. 20, 2016	Oct. 31, 2016
300	280	14-ATF-018417	SEPT. 20, 2016	Oct. 31, 2016
301	283	16-ATF-001545	SEPT. 20, 2016	Oct. 31, 2016
302	283	16-ATF-001567	SEPT. 20, 2016	Oct. 31, 2016
303	283	16-ATF-015514	SEPT. 20, 2016	Oct. 31, 2016

UNOFFICIAL

774

2017-002378 MISC Page: 570 of 693

03/10/2017 12:35:10 PM Receipt #: 17-1634
 Rec Fee: \$250.00 Darrell James Hill
 Gila County, Az, Sadie Jo Bingham, Recorder



2022-011769 MISC Page: 773 of 2782

09/26/2022 03:35:37 PM Receipt #: 22-9381
 Rec Fee: \$30.00 Darrell James Hill
 Gila County, Az, Sadie Jo Bingham, Recorder



APACHE JUNCTION
151 W SUPERSTITION BLVD
APACHE JUNCTION
AZ

85120-9998
0302590130

11/10/2016 (800)275-8777 4:21 PM

Product Description	Sale Qty	Final Price
First-Class Mail Letter	1	\$0.68

(Domestic)
(WASHINGTON, DC 20530)
(Weight: 0 Lb 1.40 Oz)
(Expected Delivery Day)
(Monday 11/14/2016)

Certified
(@USPS Certified Mail #)
(70160340000064027789)

Total \$3.98

Cash Change \$4.00 (\$0.02)

Text your tracking number to 28777 (2USPS) to get the latest status. Standard Message and Data rates may apply. You may also visit USPS.com USPS Tracking or call 1-800-222-1811.

In a hurry? Self-service kiosks offer quick and easy check-out. Any Retail Associate can show you how.

BRIGHTEN SOMEONE'S MAILBOX. Greeting cards available for purchase at select Post Offices.

775
2017-002378 MISC Page: 571 of 693
03/10/2017 12:35:10 PM Receipt #: 17-1634
Rec Fee: \$250.00 Darrell James Hill
Gila County, Az, Sadie Jo Bingham, Recorder

2022-011769 MISC Page: 774 of 2782

09/26/2022 03:35:37 PM Receipt #: 22-9381
Rec Fee: \$30.00 Darrell James Hill
Gila County, Az, Sadie Jo Bingham, Recorder





USPS Tracking®

Still Have Questions? Browse our FAQs



Tracking Number: 70160340000064027789

Updated Delivery Day: Wednesday, November 16, 2016

Product & Tracking Information

Postal Product: First-Class Mail®

Features: Certified Mail™

Available

Text Updates

Email Updates

DATE & TIME	STATUS OF ITEM	LOCATION
November 16, 2016, 6:24 am	Delivered	WASHINGTON, DC 20530

Your item was delivered at 5:24 am on November 16, 2016 in WASHINGTON, DC 20530.

November 15, 2016, 12:54 pm Available for Pickup WASHINGTON, DC 20530

November 15, 2016, 12:30 pm Arrived at Unit WASHINGTON, DC 20018

November 11, 2016, 11:43 pm In Transit to Destination

November 11, 2016, 8:32 am Departed USPS Facility PHOENIX, AZ 85026

November 10, 2016, 10:44 pm Arrived at USPS Origin Facility PHOENIX, AZ 85026

November 10, 2016, 4:24 pm Departed Post Office APACHE JUNCTION, AZ 85120

November 10, 2016, 4:20 pm Acceptance APACHE JUNCTION, AZ 85120

776

1 of 2

11/16/2016 12:19 PM

2017-002378 MISC Page: 572 of 693

03/10/2017 12:35:10 PM Receipt #: 17-1634
Rec Fee: \$250.00 Darrell James Hill
Gila County, Az, Sadie Jo Bingham, Recorder



2022-011769 MISC Page: 775 of 2782

09/26/2022 03:35:37 PM Receipt #: 22-9381
Rec Fee: \$30.00 Darrell James Hill
Gila County, Az, Sadie Jo Bingham, Recorder



Darrell- James: Hill, 5124 East 18th Avenue, Apache Junction, Arizona [85119]

USPS RMN RB 898 810 007 US

Unofficial Copy

Enclosure Two-
Notice 103116; USPS RE 322399279US; 09/21-27/16 PROPERTY POSTING
TABLE: USPS RMN RB 898 810 007 US

USPS RMN RB 898 810 007 US

2017-002378 MISC Page: 573 of 693
03/10/2017 12:35:10 PM Receipt #: 17-1634
Rec Fee: \$250.00 Darrell- James: Hill
Gila County, Az, Sadie Jo Bingham, Recorder

2022-011769 MISC Page: 776 of 2782
09/26/2022 03:35:37 PM Receipt #: 22-9381
Rec Fee: \$30.00 Darrell James Hill
Gila County, Az, Sadie Jo Bingham, Recorder



NOTICE 103116: USPS RE 322399279US: 09/21-27/16 PROPERTY POSTING TABLE

Author: i: man; Darrell- James: Hill

Date: November 10, 2016

USPS RMN RB 898 810 007 US

ID	CLAIM PAGE #	PROPERTY ITEM #	USAO NOTICE	CLAIM NOTICE
1	29	16-ICE-00485	SEPT. 21, 2016	OCT. 31, 2016
2	96	15-ATF-027268	SEPT. 21, 2016	OCT. 31, 2016
3	158	15-FBI-004538	SEPT. 21, 2016	OCT. 31, 2016
4	158	15-FBI-004550	SEPT. 21, 2016	OCT. 31, 2016
5	158	15-FBI-004760	SEPT. 21, 2016	OCT. 31, 2016
6	191	15-FBI-004923	SEPT. 21, 2016	OCT. 31, 2016
7	188	CN 2-16 CR-030-JAD	SEPT. 21, 2016	OCT. 31, 2016
8	245	15-DEA-607225	SEPT. 21, 2016	OCT. 31, 2016
9	245	15-DEA-607228	SEPT. 21, 2016	OCT. 31, 2016
10	24	14-FBI-008267	SEPT. 22, 2016	OCT. 31, 2016
11	24	15-FBI-000289	SEPT. 22, 2016	OCT. 31, 2016
12	28	16-FBI-000881	SEPT. 22, 2016	OCT. 31, 2016
13	28	16-FBI-000662	SEPT. 22, 2016	OCT. 31, 2016
14	188	15-ICE-002669	SEPT. 22, 2016	OCT. 31, 2016
15	188	16-ICE-001042	SEPT. 22, 2016	OCT. 31, 2016
16	188	16-ICE-001045	SEPT. 22, 2016	OCT. 31, 2016
17	188	16-ICE-001046	SEPT. 22, 2016	OCT. 31, 2016
18	188	16-ICE-001047	SEPT. 22, 2016	OCT. 31, 2016
19	188	16-ICE-001048	SEPT. 22, 2016	OCT. 31, 2016
20	188	16-ICE-001049	SEPT. 22, 2016	OCT. 31, 2016
21	188	16-ICE-001051	SEPT. 22, 2016	OCT. 31, 2016
22	188	16-ICE-001052	SEPT. 22, 2016	OCT. 31, 2016
23	188	16-ICE-001053	SEPT. 22, 2016	OCT. 31, 2016
24	188	16-ICE-001054	SEPT. 22, 2016	OCT. 31, 2016
25	205	16-FBI-000995	SEPT. 22, 2016	OCT. 31, 2016
26	205	16-FBI-004882	SEPT. 22, 2016	OCT. 31, 2016
27	281	14-FBI-004785	SEPT. 22, 2016	OCT. 31, 2016
28	281	SN: 5308699	SEPT. 22, 2016	OCT. 31, 2016
29	281	14-FBI-004785	SEPT. 22, 2016	OCT. 31, 2016
30	281	14-FBI-005120	SEPT. 22, 2016	OCT. 31, 2016
31	117	14-ATF-025835	SEPT. 23, 2016	OCT. 31, 2016
32	129	15-DEA-613262	SEPT. 23, 2016	OCT. 31, 2016
33	129	15-DEA-613263	SEPT. 23, 2016	OCT. 31, 2016
34	129	15-DEA-613537	SEPT. 23, 2016	OCT. 31, 2016
35	129	15-DEA-613539	SEPT. 23, 2016	OCT. 31, 2016
36	129	15-DEA-613932	SEPT. 23, 2016	OCT. 31, 2016
37	157	12-FBI-007410	SEPT. 23, 2016	OCT. 31, 2016
38	186	16-USS-000178	SEPT. 23, 2016	OCT. 31, 2016
39	174	16-FBI-005316	SEPT. 23, 2016	OCT. 31, 2016
40	206	16-IRS-000554	SEPT. 23, 2016	OCT. 31, 2016
41	206	16-IRS-000555	SEPT. 23, 2016	OCT. 31, 2016
42	206	16-IRS-000556	SEPT. 23, 2016	OCT. 31, 2016
43	252	15-ICE-002349	SEPT. 23, 2016	OCT. 31, 2016
44	252	15-ICE-002350	SEPT. 23, 2016	OCT. 31, 2016
45	252	16-ICE-000184	SEPT. 23, 2016	OCT. 31, 2016
46	253	15-ICE-002348	SEPT. 23, 2016	OCT. 31, 2016
47	253	15-ICE-002680	SEPT. 23, 2016	OCT. 31, 2016
48	253	15-ICE-002691	SEPT. 23, 2016	OCT. 31, 2016
49	253	15-ICE-002692	SEPT. 23, 2016	OCT. 31, 2016
50	253	15-ICE-002693	SEPT. 23, 2016	OCT. 31, 2016
51	253	15-ICE-002694	SEPT. 23, 2016	OCT. 31, 2016
52	253	15-ICE-002695	SEPT. 23, 2016	OCT. 31, 2016
53	253	16-ICE-000179	SEPT. 23, 2016	OCT. 31, 2016
54	255	15-FBI-002855	SEPT. 23, 2016	OCT. 31, 2016
55	256	11-FBI-004397	SEPT. 23, 2016	OCT. 31, 2016
56	298	15-FBI-006535	SEPT. 23, 2016	OCT. 31, 2016
57	288	15-FBI-006537	SEPT. 23, 2016	OCT. 31, 2016
58	304	15-ATF-027364	SEPT. 23, 2016	OCT. 31, 2016
59	304	15-ATF-027365	SEPT. 23, 2016	OCT. 31, 2016
60	304	15-ATF-027366	SEPT. 23, 2016	OCT. 31, 2016
61	304	15-ATF-027367	SEPT. 23, 2016	OCT. 31, 2016
62	304	15-ATF-027368	SEPT. 23, 2016	OCT. 31, 2016
63	304	15-ATF-027369	SEPT. 23, 2016	OCT. 31, 2016
64	304	15-ATF-027370	SEPT. 23, 2016	OCT. 31, 2016

2017-002378 MISC Page: 574 of 693

03/10/2017 12:35:10 PM Receipt #: 17-1634
 Rec Fee: \$250.00 Darrell- James: Hill
 Gila County, Az, Sadie Jo Bingham, Recorder



2022-011769 MISC Page: 777 of 2782

09/28/2022 03:35:37 PM Receipt #: 22-9381
 Rec Fee: \$30.00 Darrell James Hill
 Gila County, Az, Sadie Jo Bingham, Recorder



NOTICE 103116: USPS RE 322399279US: 09/21-27/16 PROPERTY POSTING TABLE

Author: i man; Darrell- James: Hill

Date: November 10, 2016
USPS RMN RB 898 810 007 US

ID	CLAIM PAGE #	PROPERTY ITEM #	USAO NOTICE	CLAIM NOTICE
65	304	15-ATF-027371	SEPT. 23, 2016	OCT. 31, 2016
66	304	15-ATF-027373	SEPT. 23, 2016	OCT. 31, 2016
67	18	16-FBI-004868	SEPT. 24, 2016	OCT. 31, 2016
68	123	16-FBI-006675	SEPT. 24, 2016	OCT. 31, 2016
69	142	14-FBI-001668	SEPT. 24, 2016	OCT. 31, 2016
70	201	15-ATF-024995	SEPT. 24, 2016	OCT. 31, 2016
71	202	16-DCI-000106	SEPT. 24, 2016	OCT. 31, 2016
72	202	16-DCI-000107	SEPT. 24, 2016	OCT. 31, 2016
73	202	16-DCI-000108	SEPT. 24, 2016	OCT. 31, 2016
74	202	16-DCI-000109	SEPT. 24, 2016	OCT. 31, 2016
75	211	16-FBI-004555	SEPT. 24, 2016	OCT. 31, 2016
76	260	16-ATF-011043	SEPT. 24, 2016	OCT. 31, 2016
77	260	16-ATF-011044	SEPT. 24, 2016	OCT. 31, 2016
78	265	16-FBI-001633	SEPT. 24, 2016	OCT. 31, 2016
79	265	16-FBI-001634	SEPT. 24, 2016	OCT. 31, 2016
80	265	16-FBI-004007	SEPT. 24, 2016	OCT. 31, 2016
81	265	16-FBI-004008	SEPT. 24, 2016	OCT. 31, 2016
82	268	16-ICE-001277	SEPT. 24, 2016	OCT. 31, 2016
83	271	CN 4:14-CR-10	SEPT. 24, 2016	OCT. 31, 2016
84	8	16-ICE-000928	SEPT. 27, 2016	OCT. 31, 2016
85	115	16-ATF-024439	SEPT. 27, 2016	OCT. 31, 2016
86	115	16-ATF-024440	SEPT. 27, 2016	OCT. 31, 2016
87	118	13-FBI-008252	SEPT. 27, 2016	OCT. 31, 2016
88	197	CN 2:15-CR-260-GMN-(CWH)	SEPT. 27, 2016	OCT. 31, 2016
89	238	15-FBI-001813	SEPT. 27, 2016	OCT. 31, 2016
90	247	16-DEA-616871	SEPT. 27, 2016	OCT. 31, 2016
91	247	16-DEA-617013	SEPT. 27, 2016	OCT. 31, 2016
92	248	14-ICE-000492	SEPT. 27, 2016	OCT. 31, 2016
93	248	14-ICE-000493	SEPT. 27, 2016	OCT. 31, 2016
94	248	14-ICE-000495	SEPT. 27, 2016	OCT. 31, 2016
95	248	14-ICE-000496	SEPT. 27, 2016	OCT. 31, 2016
98	248	14-ICE-000501	SEPT. 27, 2016	OCT. 31, 2016
97	248	14-ICE-000765	SEPT. 27, 2016	OCT. 31, 2016
98	248	14-ICE-000768	SEPT. 27, 2016	OCT. 31, 2016
99	248	14-ICE-000767	SEPT. 27, 2016	OCT. 31, 2016
100	248	14-ICE-000768	SEPT. 27, 2016	OCT. 31, 2016
101	249	16-ATF-021130	SEPT. 27, 2016	OCT. 31, 2016
102	250	16-DEA-617863	SEPT. 27, 2016	OCT. 31, 2016

2017-002378 MISC Page: 575 of 693
03/10/2017 12:35:10 PM Receipt #: 17-1634
Rec Fee: \$250.00 Darrell- James: Hill
Gila County, Az, Sadie Jo Bingham, Recorder

2022-011769 MISC Page: 778 of 2782
09/26/2022 03:35:37 PM Receipt #: 22-9381
Rec Fee: \$30.00 Darrell James Hill
Gila County, Az, Sadie Jo Bingham, Recorder

Darrell- James: Hill, 5124 East 18th Avenue, Apache Junction, Arizona [85119]

USPS RMN RB 898 810 007 US

UNOFFICIAL COPY

Enclosure Three-
Notice 103116; USPS RE 322399279US; 09/28-10/12/16 PROPERTY POSTING
TABLE: USPS RMN RB 898 810 007 US

UNOFFICIAL COPY

300

USPS RM

17-002378 MISC Page: 576 of 693
10/2017 12:35:40 PM Receipt #: 17-1634
Fee: \$250.00 Darrell- James: Hill
ila County, Az, Sadie Jo Bingham, Recorder



2022-011769 MISC Page: 779 of 2782
09/26/2022 03:35:37 PM Receipt #: 22-9381
Rec Fee: \$30.00 Darrell James Hill
Gila County, Az, Sadie Jo Bingham, Recorder



NOTICE 103116: USPS RE 322399279US: 09/28-10/12/16 PROPERTY POSTING TABLE

Author: i man; Darrell- James- Hill

Date: November 16, 2016

USPS RMN RB 898 810 007 US

ID	CLAIM PAGE #	PROPERTY ITEM #	USAO NOTICE	CLAIM NOTICE
0	6	15-DEA-814694	SEPT. 28, 2016	OCT. 31, 2016
1	7	15-ATF-027818	SEPT. 28, 2016	OCT. 31, 2016
2	21	14-FBI-008323	SEPT. 28, 2016	OCT. 31, 2016
3	112	13-IRS-002250	SEPT. 28, 2016	OCT. 31, 2016
4	114	16-FBI-002460	SEPT. 28, 2016	OCT. 31, 2016
5	127	15-ATF-027882	SEPT. 28, 2016	OCT. 31, 2016
6	128	14-ATF-024531	SEPT. 28, 2016	OCT. 31, 2016
7	179	16-FBI-005314	SEPT. 28, 2016	OCT. 31, 2016
8	212	16-ATF-020217	SEPT. 28, 2016	OCT. 31, 2016
10	234	16-FBI-003814	SEPT. 28, 2016	OCT. 31, 2016
11	273	CN 4-16-CR-182	SEPT. 28, 2016	OCT. 31, 2016
12	294	16-DEA-818870	SEPT. 28, 2016	OCT. 31, 2016
13	295	16-ATF-015960	SEPT. 28, 2016	OCT. 31, 2016
14	295	16-ATF-018888	SEPT. 28, 2016	OCT. 31, 2016
15	302	CN 15-CR-245	SEPT. 28, 2016	OCT. 31, 2016
16	303	CN 15-CR-83	SEPT. 28, 2016	OCT. 31, 2016
17	4	16-FBI-001137	SEPT. 29, 2016	OCT. 31, 2016
18	35	14-IRS-001488	SEPT. 29, 2016	OCT. 31, 2016
19	97	CN CR416-257	SEPT. 29, 2016	OCT. 31, 2016
20	44	CN 16-CR-14002-ROSENBERG	SEPT. 29, 2016	OCT. 31, 2016
21	44	16-ICE-000557	SEPT. 29, 2016	OCT. 31, 2016
22	124	CN 3-16CR-48-DJH	SEPT. 29, 2016	OCT. 31, 2016
23	149	16-ATF-011473	SEPT. 29, 2016	OCT. 31, 2016
24	168	16-FBI-003554	SEPT. 29, 2016	OCT. 31, 2016
25	168	16-FBI-003555	SEPT. 29, 2016	OCT. 31, 2016
26	168	16-FBI-003556	SEPT. 29, 2016	OCT. 31, 2016
27	168	16-FBI-003557	SEPT. 29, 2016	OCT. 31, 2016
28	181	08-FBI-006408	SEPT. 29, 2016	OCT. 31, 2016
29	181	08-FBI-006411	SEPT. 29, 2016	OCT. 31, 2016
30	181	08-FBI-006412	SEPT. 29, 2016	OCT. 31, 2016
31	181	08-FBI-006413	SEPT. 29, 2016	OCT. 31, 2016
32	181	08-FBI-006414	SEPT. 29, 2016	OCT. 31, 2016
33	204	16-FBI-003218	SEPT. 29, 2016	OCT. 31, 2016
34	213	14-ATF-025808	SEPT. 29, 2016	OCT. 31, 2016
35	224	15-ATF-027890	SEPT. 29, 2016	OCT. 31, 2016
36	224	15-ATF-027892	SEPT. 29, 2016	OCT. 31, 2016
37	224	15-ATF-027893	SEPT. 29, 2016	OCT. 31, 2016
38	224	15-ATF-027895	SEPT. 29, 2016	OCT. 31, 2016
39	224	15-ATF-027896	SEPT. 29, 2016	OCT. 31, 2016
40	235	15-ATF-027121	SEPT. 29, 2016	OCT. 31, 2016
41	235	15-ATF-027122	SEPT. 29, 2016	OCT. 31, 2016
42	235	15-ATF-027123	SEPT. 29, 2016	OCT. 31, 2016
43	235	15-ATF-027124	SEPT. 29, 2016	OCT. 31, 2016
44	235	15-ATF-027125	SEPT. 29, 2016	OCT. 31, 2016
45	235	15-ATF-027126	SEPT. 29, 2016	OCT. 31, 2016
46	235	15-ATF-027127	SEPT. 29, 2016	OCT. 31, 2016
47	235	15-ATF-027128	SEPT. 29, 2016	OCT. 31, 2016
48	235	15-ATF-027129	SEPT. 29, 2016	OCT. 31, 2016
49	236	16-FBI-000881	SEPT. 29, 2016	OCT. 31, 2016
50	278	16-ATF-012181	SEPT. 29, 2016	OCT. 31, 2016
51	278	16-ATF-012183	SEPT. 29, 2016	OCT. 31, 2016
52	278	16-ATF-012184	SEPT. 29, 2016	OCT. 31, 2016
53	278	16-ATF-012185	SEPT. 29, 2016	OCT. 31, 2016
54	278	16-ATF-012186	SEPT. 29, 2016	OCT. 31, 2016
55	278	16-ATF-012187	SEPT. 29, 2016	OCT. 31, 2016
56	289	15-FBI-006534	SEPT. 29, 2016	OCT. 31, 2016
57	299	15-FBI-006594	SEPT. 29, 2016	OCT. 31, 2016
58	9	16-ICE-001157	SEPT. 30, 2016	OCT. 31, 2016
59	12	14-ATF-025498	SEPT. 30, 2016	OCT. 31, 2016
60	15	16-FBI-004993	SEPT. 30, 2016	OCT. 31, 2016
61	33	14-ICE-001051	SEPT. 30, 2016	OCT. 31, 2016
62	33	14-ICE-001052	SEPT. 30, 2016	OCT. 31, 2016
63	33	14-ICE-001053	SEPT. 30, 2016	OCT. 31, 2016
64	39	15-IRS-001227	SEPT. 30, 2016	OCT. 31, 2016
65	40	16-IRS-000713	SEPT. 30, 2016	OCT. 31, 2016
66	40	16-IRS-000714	SEPT. 30, 2016	OCT. 31, 2016

781

2017-002378 MISC Page: 577 of 693
 09/10/2017 12:35:10 PM Receipt #: 17-1634
 Rec Fee: \$250.00 Darrell- James- Hill
 Gila County, Az, Sadie Jo Bingham, Recorder

2022-011769 MISC Page: 780 of 2782
 09/26/2022 03:35:37 PM Receipt #: 22-9381
 Rec Fee: \$30.00 Darrell James Hill
 Gila County, Az, Sadie Jo Bingham, Recorder

NOTICE 103116: USPS RE 322399279US: 09/28-10/12/16 PROPERTY POSTING TABLE

Author: i: man; Darrell- James: Hill

Date: November 16, 2016

USPS RMN RB 898 810 007 US

ID	CLAIM PAGE #	PROPERTY ITEM #	USAO NOTICE	CLAIM NOTICE
67	40	16-IRS-000716	SEPT. 30, 2016	OCT. 31, 2016
68	40	16-IRS-000716	SEPT. 30, 2016	OCT. 31, 2016
69	40	16-IRS-000717	SEPT. 30, 2016	OCT. 31, 2016
70	40	16-IRS-000718	SEPT. 30, 2016	OCT. 31, 2016
71	45	16-ATF-006640	SEPT. 30, 2016	OCT. 31, 2016
72	85	16-FBI-004187	SEPT. 30, 2016	OCT. 31, 2016
73	106	16-ATF-009025	SEPT. 30, 2016	OCT. 31, 2016
74	108	16-ATF-009028	SEPT. 30, 2016	OCT. 31, 2016
75	137	15-ICE-002730	SEPT. 30, 2016	OCT. 31, 2016
76	138	15-ICE-002730	SEPT. 30, 2016	OCT. 31, 2016
77	138	15-ICE-002731	SEPT. 30, 2016	OCT. 31, 2016
79	138	15-ICE-002732	SEPT. 30, 2016	OCT. 31, 2016
80	138	15-ICE-002733	SEPT. 30, 2016	OCT. 31, 2016
81	168	16-USP-000022	SEPT. 30, 2016	OCT. 31, 2016
82	178	CN 5:16-CR-184-BR	SEPT. 30, 2016	OCT. 31, 2016
83	189	CN 2:16-CR-030-JAD-(CWH)	SEPT. 30, 2016	OCT. 31, 2016
84	200	CN 2:16-CR-033-JCM-(GWF)	SEPT. 30, 2016	OCT. 31, 2016
85	255	16-DEA-622316	SEPT. 30, 2016	OCT. 31, 2016
86	254	15-ATF-026982	SEPT. 30, 2016	OCT. 31, 2016
87	254	15-ATF-026983	SEPT. 30, 2016	OCT. 31, 2016
88	254	15-ATF-026984	SEPT. 30, 2016	OCT. 31, 2016
89	254	15-ATF-026985	SEPT. 30, 2016	OCT. 31, 2016
90	257	15-DEA-610468	SEPT. 30, 2016	OCT. 31, 2016
91	257	15-DEA-610811	SEPT. 30, 2016	OCT. 31, 2016
92	259	16-DEA-610621	SEPT. 30, 2016	OCT. 31, 2016
93	259	16-DEA-610622	SEPT. 30, 2016	OCT. 31, 2016
94	274	CN C-16-CR-361	SEPT. 30, 2016	OCT. 31, 2016
95	277	CN V-16-CR-4	SEPT. 30, 2016	OCT. 31, 2016
96	282	CN EP-16-CR-916-KC	SEPT. 30, 2016	OCT. 31, 2016
97	282	16-FBI-002874	SEPT. 30, 2016	OCT. 31, 2016
98	292	16-FBI-002814	SEPT. 30, 2016	OCT. 31, 2016
99	292	16-FBI-002925	SEPT. 30, 2016	OCT. 31, 2016
100	292	16-FBI-003047	SEPT. 30, 2016	OCT. 31, 2016
101	292	16-FBI-005458	SEPT. 30, 2016	OCT. 31, 2016
102	20	09-DEA-624589	OCT. 01, 2016	OCT. 31, 2016
103	20	09-DEA-624600	OCT. 01, 2016	OCT. 31, 2016
104	20	09-DEA-624602	OCT. 01, 2016	OCT. 31, 2016
105	105	16-STL-000018	OCT. 01, 2016	OCT. 31, 2016
106	105	16-STL-000019	OCT. 01, 2016	OCT. 31, 2016
107	122	14-FBI-008060	OCT. 01, 2016	OCT. 31, 2016
108	122	15-FBI-004857	OCT. 01, 2016	OCT. 31, 2016
109	140	12-FBI-005063	OCT. 01, 2016	OCT. 31, 2016
110	140	12-FBI-005064	OCT. 01, 2016	OCT. 31, 2016
111	140	12-FBI-005065	OCT. 01, 2016	OCT. 31, 2016
112	173	16-DEA-621461	OCT. 01, 2016	OCT. 31, 2016
113	173	16-DEA-625413	OCT. 01, 2016	OCT. 31, 2016
114	180	16-FBI-003171	OCT. 01, 2016	OCT. 31, 2016
115	187	16-ATF-018222	OCT. 01, 2016	OCT. 31, 2016
116	203	15-DEA-625434	OCT. 01, 2016	OCT. 31, 2016
117	241	16-ATF-021542	OCT. 01, 2016	OCT. 31, 2016
118	275	CN H-15-CR-563	OCT. 01, 2016	OCT. 31, 2016
119	196	15-DEA-610271	OCT 02, 2016	OCT. 31, 2016
120	196	15-DEA-623677	OCT 02, 2016	OCT. 31, 2016
121	5	15-DEA-611641	OCT. 04, 2016	OCT. 31, 2016
122	41	16-ICE-001289	OCT. 04, 2016	OCT. 31, 2016
123	43	16-ICE-000832	OCT. 04, 2016	OCT. 31, 2016
125	43	16-ICE-000834	OCT. 04, 2016	OCT. 31, 2016
126	43	16-ICE-000835	OCT. 04, 2016	OCT. 31, 2016
127	43	16-ICE-000838	OCT. 04, 2016	OCT. 31, 2016
128	43	16-ICE-000837	OCT. 04, 2016	OCT. 31, 2016
129	43	16-ICE-000838	OCT. 04, 2016	OCT. 31, 2016
130	109	16-STL-000034	OCT. 04, 2016	OCT. 31, 2016
131	169	16-FBI-003861	OCT. 04, 2016	OCT. 31, 2016
132	192	CN CR. 15-178-01-LM	OCT. 04, 2016	OCT. 31, 2016
133	194	14-FBI-002444	OCT. 04, 2016	OCT. 31, 2016
134	194	14-FBI-002794	OCT. 04, 2016	OCT. 31, 2016
135	194	14-FBI-002795	OCT. 04, 2016	OCT. 31, 2016

782

2022-011769 MISC Page: 781 of 2782

09/26/2022 03:35:37 PM Receipt #: 22-9381
 Rec Fee: \$30.00 Darrell James Hill
 Gila County, Az, Sadie Jo Bingham, Recorder



395



NOTICE 103116: USPS RE 322399279US: 09/28-10/12/16 PROPERTY POSTING TABLE

Author: i man; Darrell- James: Hill

Date: November 16, 2016

USPS RMN RB 898 810 007 US

ID	CLAIM PAGE #	PROPERTY ITEM #	USAO NOTICE	CLAIM NOTICE
136	184	14-FBI-002786	OCT. 04, 2016	OCT. 31, 2016
137	184	14-FBI-002787	OCT. 04, 2016	OCT. 31, 2016
138	184	14-FBI-002788	OCT. 04, 2016	OCT. 31, 2016
139	194	14-FBI-002799	OCT. 04, 2016	OCT. 31, 2016
140	184	14-FBI-002800	OCT. 04, 2016	OCT. 31, 2016
141	194	14-FBI-002801	OCT. 04, 2016	OCT. 31, 2016
142	184	14-FBI-002802	OCT. 04, 2016	OCT. 31, 2016
143	185	14-FBI-002807	OCT. 04, 2016	OCT. 31, 2016
144	185	14-FBI-002808	OCT. 04, 2016	OCT. 31, 2016
145	185	14-FBI-002809	OCT. 04, 2016	OCT. 31, 2016
146	185	14-FBI-002810	OCT. 04, 2016	OCT. 31, 2016
147	185	14-FBI-002811	OCT. 04, 2016	OCT. 31, 2016
148	185	14-FBI-003120	OCT. 04, 2016	OCT. 31, 2016
149	185	15-FBI-005565	OCT. 04, 2016	OCT. 31, 2016
150	185	15-FBI-005567	OCT. 04, 2016	OCT. 31, 2016
151	207	15-USS-000663	OCT. 04, 2016	OCT. 31, 2016
152	207	15-USS-000664	OCT. 04, 2016	OCT. 31, 2016
153	207	15-USS-000665	OCT. 04, 2016	OCT. 31, 2016
154	208	16-CBP-000341	OCT. 04, 2016	OCT. 31, 2016
155	217	16-DEA-618910	OCT. 04, 2016	OCT. 31, 2016
156	218	16-DEA-618968	OCT. 04, 2016	OCT. 31, 2016
157	287	16-DEA-622064	OCT. 04, 2016	OCT. 31, 2016
158	287	16-USS-000188	OCT. 04, 2016	OCT. 31, 2016
159	3	15-DEA-612408	OCT. 05, 2016	OCT. 31, 2016
161	10	15-FBI-005593	OCT. 05, 2016	OCT. 31, 2016
162	10	15-FBI-005595	OCT. 05, 2016	OCT. 31, 2016
163	10	15-FBI-005596	OCT. 05, 2016	OCT. 31, 2016
164	10	15-FBI-005597	OCT. 05, 2016	OCT. 31, 2016
165	10	15-FBI-005598	OCT. 05, 2016	OCT. 31, 2016
166	10	15-FBI-005599	OCT. 05, 2016	OCT. 31, 2016
167	10	15-FBI-005600	OCT. 05, 2016	OCT. 31, 2016
168	10	15-FBI-005601	OCT. 05, 2016	OCT. 31, 2016
169	10	15-FBI-005602	OCT. 05, 2016	OCT. 31, 2016
170	10	15-FBI-005603	OCT. 05, 2016	OCT. 31, 2016
171	10	15-FBI-005604	OCT. 05, 2016	OCT. 31, 2016
172	10	15-FBI-005618	OCT. 05, 2016	OCT. 31, 2016
173	10	15-FBI-005620	OCT. 05, 2016	OCT. 31, 2016
174	10	15-FBI-005621	OCT. 05, 2016	OCT. 31, 2016
175	11	15-FBI-005623	OCT. 05, 2016	OCT. 31, 2016
176	11	15-FBI-005624	OCT. 05, 2016	OCT. 31, 2016
177	11	15-FBI-005625	OCT. 05, 2016	OCT. 31, 2016
178	11	15-FBI-005628	OCT. 05, 2016	OCT. 31, 2016
179	11	15-FBI-005627	OCT. 05, 2016	OCT. 31, 2016
180	11	15-FBI-005628	OCT. 05, 2016	OCT. 31, 2016
181	11	15-FBI-005629	OCT. 05, 2016	OCT. 31, 2016
182	11	15-FBI-005630	OCT. 05, 2016	OCT. 31, 2016
183	11	15-FBI-005631	OCT. 05, 2016	OCT. 31, 2016
184	11	15-FBI-005633	OCT. 05, 2016	OCT. 31, 2016
185	11	15-FBI-005634	OCT. 05, 2016	OCT. 31, 2016
186	11	15-FBI-005635	OCT. 05, 2016	OCT. 31, 2016
187	11	15-FBI-005638	OCT. 05, 2016	OCT. 31, 2016
188	99	CN 14-00034	OCT. 05, 2016	OCT. 31, 2016
189	118	15-ATF-027440	OCT. 05, 2016	OCT. 31, 2016
190	118	14-FWS-000026	OCT. 05, 2016	OCT. 31, 2016
191	118	14-FWS-000028	OCT. 05, 2016	OCT. 31, 2016
192	48	16-AGR-000023	OCT. 05, 2016	OCT. 31, 2016
193	48	16-AGR-000024	OCT. 05, 2016	OCT. 31, 2016
194	94	15-FBI-006854	OCT. 05, 2016	OCT. 31, 2016
195	143	14-ATF-025843	OCT. 05, 2016	OCT. 31, 2016
196	143	14-ATF-025844	OCT. 05, 2016	OCT. 31, 2016
197	143	14-ATF-025845	OCT. 05, 2016	OCT. 31, 2016
198	143	14-ATF-025846	OCT. 05, 2016	OCT. 31, 2016
199	143	14-ATF-025847	OCT. 05, 2016	OCT. 31, 2016
200	143	14-ATF-025848	OCT. 05, 2016	OCT. 31, 2016
201	143	14-ATF-025849	OCT. 05, 2016	OCT. 31, 2016
202	143	14-ATF-025850	OCT. 05, 2016	OCT. 31, 2016
203	143	14-ATF-025851	OCT. 05, 2016	OCT. 31, 2016

2022-011769 MISC Page: 782 of 2782

09/26/2022 03:35:37 PM Receipt #: 22-9381
 Rec Fee: \$30.00 Darrell James Hill
 Gila County, Az, Sadie Jo Bingham, Recorder



783



396

NOTICE 103116: USPS RE 322399279US: 09/28-10/12/16 PROPERTY POSTING TABLE

Author: i man; Darrell-James: Hill

Date: November 16, 2016

USPS RMN RB 898 810 007 US

ID	CLAIM PAGE #	PROPERTY ITEM #	USAO NOTICE	CLAIM NOTICE
204	143	14-ATF-025852	OCT. 05, 2016	OCT. 31, 2016
205	143	14-ATF-025853	OCT. 05, 2016	OCT. 31, 2016
206	160	16-DEA-816806	OCT. 05, 2016	OCT. 31, 2016
207	216	16-DEA-825008	OCT. 05, 2016	OCT. 31, 2016
208	223	14-ATF-025915	OCT. 05, 2016	OCT. 31, 2016
209	223	14-ATF-025917	OCT. 05, 2016	OCT. 31, 2016
210	251	16-ICE-000270	OCT. 05, 2016	OCT. 31, 2016
211	251	16-ICE-000271	OCT. 05, 2016	OCT. 31, 2016
212	279	16-ICE-000725	OCT. 05, 2016	OCT. 31, 2016
213	279	16-ICE-000726	OCT. 05, 2016	OCT. 31, 2016
214	279	16-ICE-001290	OCT. 05, 2016	OCT. 31, 2016
215	279	16-ICE-001291	OCT. 05, 2016	OCT. 31, 2016
216	279	16-ICE-001292	OCT. 05, 2016	OCT. 31, 2016
217	279	16-ICE-001293	OCT. 05, 2016	OCT. 31, 2016
218	279	16-ICE-001295	OCT. 05, 2016	OCT. 31, 2016
219	279	16-ICE-001298	OCT. 05, 2016	OCT. 31, 2016
220	279	16-ICE-001320	OCT. 05, 2016	OCT. 31, 2016
221	285	14-ATF-025677	OCT. 05, 2016	OCT. 31, 2016
222	285	14-ATF-025678	OCT. 05, 2016	OCT. 31, 2016
223	285	14-ATF-025784	OCT. 05, 2016	OCT. 31, 2016
224	291	16-FBI-005428	OCT. 05, 2016	OCT. 31, 2016
225	291	16-FBI-005435	OCT. 05, 2016	OCT. 31, 2016
226	291	16-FBI-005439	OCT. 05, 2016	OCT. 31, 2016
227	291	16-FBI-005578	OCT. 05, 2016	OCT. 31, 2016
228	17	16-FBI-004759	OCT. 06, 2016	OCT. 31, 2016
229	17	16-FBI-004760	OCT. 06, 2016	OCT. 31, 2016
230	101	CN 15CR00634-01 LEK	OCT. 08, 2016	OCT. 31, 2016
231	102	CN 15CR00723 HG	OCT. 06, 2016	OCT. 31, 2016
232	110	13-FBI-008450	OCT. 06, 2016	OCT. 31, 2016
233	110	13-FBI-008451	OCT. 06, 2016	OCT. 31, 2016
234	110	13-FBI-008452	OCT. 06, 2016	OCT. 31, 2016
235	110	13-FBI-008453	OCT. 06, 2016	OCT. 31, 2016
236	110	13-FBI-008454	OCT. 06, 2016	OCT. 31, 2016
237	110	13-FBI-008455	OCT. 06, 2016	OCT. 31, 2016
238	110	13-FBI-008457	OCT. 06, 2016	OCT. 31, 2016
239	110	13-FBI-008458	OCT. 06, 2016	OCT. 31, 2016
240	110	13-FBI-008459	OCT. 06, 2016	OCT. 31, 2016
241	110	13-FBI-008464	OCT. 06, 2016	OCT. 31, 2016
242	110	13-FBI-008465	OCT. 06, 2016	OCT. 31, 2016
243	110	13-FBI-008466	OCT. 06, 2016	OCT. 31, 2016
244	1110	13-FBI-008467	OCT. 06, 2016	OCT. 31, 2016
245	111	11-FBI-001662	OCT. 06, 2016	OCT. 31, 2016
246	219	16-ATF-025075	OCT. 06, 2016	OCT. 31, 2016
247	220	16-ATF-025058	OCT. 06, 2016	OCT. 31, 2016
248	229	16-FBI-005431	OCT. 06, 2016	OCT. 31, 2016
249	13	16-FBI-003914	OCT. 07, 2016	OCT. 31, 2016
250	23	15-FBI-005550	OCT. 07, 2016	OCT. 31, 2016
251	23	15-FBI-005551	OCT. 07, 2016	OCT. 31, 2016
252	25	15-ATF-026292	OCT. 07, 2016	OCT. 31, 2016
253	25	15-ATF-026293	OCT. 07, 2016	OCT. 31, 2016
254	25	15-ATF-026294	OCT. 07, 2016	OCT. 31, 2016
255	25	15-ATF-026295	OCT. 07, 2016	OCT. 31, 2016
256	25	15-ATF-026296	OCT. 07, 2016	OCT. 31, 2016
257	25	15-ATF-026297	OCT. 07, 2016	OCT. 31, 2016
258	25	15-ATF-026298	OCT. 07, 2016	OCT. 31, 2016
259	25	15-ATF-026299	OCT. 07, 2016	OCT. 31, 2016
260	25	15-ATF-026300	OCT. 07, 2016	OCT. 31, 2016
261	25	15-ATF-026301	OCT. 07, 2016	OCT. 31, 2016
262	25	15-ATF-026302	OCT. 07, 2016	OCT. 31, 2016
263	30	16-CBP-000327	OCT. 07, 2016	OCT. 31, 2016
264	30	16-CBP-000328	OCT. 07, 2016	OCT. 31, 2016
265	30	16-CBP-000329	OCT. 07, 2016	OCT. 31, 2016
266	100	CN 13CR00512 DKW	OCT. 07, 2016	OCT. 31, 2016
267	134	15-DEA-604969	OCT. 07, 2016	OCT. 31, 2016
268	151	16-FBI-003561	OCT. 07, 2016	OCT. 31, 2016
269	151	16-FBI-003562	OCT. 07, 2016	OCT. 31, 2016
270	151	16-FBI-004220	OCT. 07, 2016	OCT. 31, 2016

2022-011769 MISC Page: 783 of 2782

09/26/2022 03:35:37 PM Receipt #: 22-9381
 Rec Fee: \$30.00 Darrell James Hill
 Gila County, Az, Sadie Jo Bingham, Recorder



397

NOTICE 103116: USPS RE 322399279US: 09/28-10/12/16 PROPERTY POSTING TABLE

Author: i man; Darrell- James: Hill

Date: November 16, 2016

USPS RMN RB 898 810 007 US

ID	CLAIM PAGE #	PROPERTY ITEM #	USAO NOTICE	CLAIM NOTICE
271	151	16-FBI-005242	OCT. 07, 2016	OCT. 31, 2016
272	151	16-FBI-005243	OCT. 07, 2016	OCT. 31, 2016
273	151	16-FBI-005244	OCT. 07, 2016	OCT. 31, 2016
274	237	16-FBI-000883	OCT. 07, 2016	OCT. 31, 2016
275	288	15-DEA-815707	OCT. 07, 2016	OCT. 31, 2016
276	288	16-DEA-818439	OCT. 07, 2016	OCT. 31, 2016
277	287	16-DEA-818440	OCT. 07, 2016	OCT. 31, 2016
278	18	15-ICE-001858	OCT. 08, 2016	OCT. 31, 2016
279	18	15-ICE-001859	OCT. 08, 2016	OCT. 31, 2016
280	18	15-ICE-001860	OCT. 08, 2016	OCT. 31, 2016
281	37	16-IRS-000576	OCT. 08, 2016	OCT. 31, 2016
282	146	15-FBI-007182	OCT. 08, 2016	OCT. 31, 2016
283	146	15-FBI-007210	OCT. 08, 2016	OCT. 31, 2016
284	146	15-FBI-007212	OCT. 08, 2016	OCT. 31, 2016
285	146	15-FBI-007213	OCT. 08, 2016	OCT. 31, 2016
286	147	15-FBI-007215	OCT. 08, 2016	OCT. 31, 2016
287	182	14-ATF-026782	OCT. 08, 2016	OCT. 31, 2016
288	182	14-ATF-026880	OCT. 08, 2016	OCT. 31, 2016
288	183	15-FBI-001373	OCT. 08, 2016	OCT. 31, 2016
289	183	15-FBI-001375	OCT. 08, 2016	OCT. 31, 2016
291	183	15-FBI-001376	OCT. 08, 2016	OCT. 31, 2016
292	183	15-FBI-001377	OCT. 08, 2016	OCT. 31, 2016
293	183	15-FBI-001378	OCT. 08, 2016	OCT. 31, 2016
294	183	15-FBI-001381	OCT. 08, 2016	OCT. 31, 2016
295	183	15-FBI-001745	OCT. 08, 2016	OCT. 31, 2016
296	183	15-FBI-001746	OCT. 08, 2016	OCT. 31, 2016
297	183	15-FBI-002540	OCT. 08, 2016	OCT. 31, 2016
298	183	15-FBI-002541	OCT. 08, 2016	OCT. 31, 2016
299	183	15-FBI-002542	OCT. 08, 2016	OCT. 31, 2016
300	180	16-ATF-013482	OCT. 08, 2016	OCT. 31, 2016
301	180	16-ATF-013487	OCT. 08, 2016	OCT. 31, 2016
302	180	16-ATF-013470	OCT. 08, 2016	OCT. 31, 2016
303	215	16-ICE-001309	OCT. 08, 2016	OCT. 31, 2016
304	215	16-ICE-001310	OCT. 08, 2016	OCT. 31, 2016
305	215	16-ICE-001311	OCT. 08, 2016	OCT. 31, 2016
308	233	15-IRS-000451	OCT. 08, 2016	OCT. 31, 2016
307	233	15-IRS-000453	OCT. 08, 2016	OCT. 31, 2016
308	233	15-IRS-000454	OCT. 08, 2016	OCT. 31, 2016
309	288	16-ICE-001341	OCT. 08, 2016	OCT. 31, 2016
310	288	16-ICE-001342	OCT. 08, 2016	OCT. 31, 2016
311	288	16-ICE-001343	OCT. 08, 2016	OCT. 31, 2016
312	288	16-ICE-001344	OCT. 08, 2016	OCT. 31, 2016
313	288	16-ICE-001345	OCT. 08, 2016	OCT. 31, 2016
314	288	16-ICE-001348	OCT. 08, 2016	OCT. 31, 2016
315	288	16-ICE-001347	OCT. 08, 2016	OCT. 31, 2016
316	288	16-ICE-001348	OCT. 08, 2016	OCT. 31, 2016
317	288	16-ICE-001349	OCT. 08, 2016	OCT. 31, 2016
318	288	16-ICE-001351	OCT. 08, 2016	OCT. 31, 2016
318	288	16-ICE-001353	OCT. 08, 2016	OCT. 31, 2016
320	280	16-ICE-001323	OCT. 08, 2016	OCT. 31, 2016
321	280	16-ICE-001335	OCT. 08, 2016	OCT. 31, 2016
322	280	16-ICE-001336	OCT. 08, 2016	OCT. 31, 2016
323	280	16-ICE-001337	OCT. 08, 2016	OCT. 31, 2016
324	280	16-ICE-001338	OCT. 08, 2016	OCT. 31, 2016
325	300	16-ATF-006305	OCT. 09, 2016	OCT. 31, 2016
328	300	16-ATF-006314	OCT. 09, 2016	OCT. 31, 2016
327	300	16-ATF-006320	OCT. 09, 2016	OCT. 31, 2016
328	300	16-ATF-006323	OCT. 09, 2016	OCT. 31, 2016
329	300	16-ATF-006324	OCT. 09, 2016	OCT. 31, 2016
330	300	16-ATF-006325	OCT. 09, 2016	OCT. 31, 2016
331	300	16-ATF-006327	OCT. 09, 2016	OCT. 31, 2016
332	300	16-ATF-006330	OCT. 09, 2016	OCT. 31, 2016
333	300	16-ATF-006333	OCT. 09, 2016	OCT. 31, 2016
334	183	14-FBI-002783	OCT. 10, 2016	OCT. 31, 2016
335	183	14-FBI-002808	OCT. 10, 2016	OCT. 31, 2016
336	36	16-CBP-000234	OCT. 10, 2016	OCT. 31, 2016
337	126	16-ATF-001811	OCT. 11, 2016	OCT. 31, 2016

2022-011769 MISC Page: 784 of 2782
 09/26/2022 03:35:37 PM Receipt #: 22-9381
 Rec Fee: \$20.00 Darrell James Hill
 Gila County, Az, Sadie Jo Bingham, Recorder



2017-002378 MISC Page: 581 of 693

03/10/2017 12:35:10 PM Receipt #: 17-1634
 Rec Fee: \$250.00 Darrell- James: Hill
 Gila County, Az, Sadie Jo Bingham, Recorder



USPS RMN RB 898 810 007 US Page 5/6

398

NOTICE 103116: USPS RE 322399279US: 09/28-10/12/16 PROPERTY POSTING TABLE

Author: i man; Darrell- James: Hill

Date: November 16, 2016

USPS RMN RB 898 810 007 US

ID	CLAM PAGE #	PROPERTY ITEM #	USAO NOTICE	CLAM NOTICE
338	14	16-ICE-000815	OCT. 12, 2016	OCT. 31, 2016
339	16	12-ATF-011090	OCT. 12, 2016	OCT. 31, 2016
340	16	12-ATF-011288	OCT. 12, 2016	OCT. 31, 2016
341	16	12-ATF-011587	OCT. 12, 2016	OCT. 31, 2016
342	16	12-ATF-011589	OCT. 12, 2016	OCT. 31, 2016
343	16	12-ATF-011591	OCT. 12, 2016	OCT. 31, 2016
344	16	12-ATF-011593	OCT. 12, 2016	OCT. 31, 2016
345	16	12-ATF-011594	OCT. 12, 2016	OCT. 31, 2016
346	42	16-DEA-622942	OCT. 12, 2016	OCT. 31, 2016
347	103	15-FBI-006529	OCT. 12, 2016	OCT. 31, 2016
348	103	15-FBI-006530	OCT. 12, 2016	OCT. 31, 2016
349	103	15-FBI-006531	OCT. 12, 2016	OCT. 31, 2016
350	113	CN 16 CR 533	OCT. 12, 2016	OCT. 31, 2016
351	121	16-FBI-005805	OCT. 12, 2016	OCT. 31, 2016
352	121	16-FBI-005806	OCT. 12, 2016	OCT. 31, 2016
353	121	16-FBI-005607	OCT. 12, 2016	OCT. 31, 2016
354	121	16-FBI-005608	OCT. 12, 2016	OCT. 31, 2016
355	121	16-FBI-005609	OCT. 12, 2016	OCT. 31, 2016
356	121	16-FBI-005810	OCT. 12, 2016	OCT. 31, 2016
357	159	16-ATF-011479	OCT. 12, 2016	OCT. 31, 2016
358	159	16-ATF-011481	OCT. 12, 2016	OCT. 31, 2016
359	159	16-ATF-012437	OCT. 12, 2016	OCT. 31, 2016
360	214	15-FBI-005515	OCT. 12, 2016	OCT. 31, 2016
361	221	15-FBI-007450	OCT. 12, 2016	OCT. 31, 2016
362	261	16-ATF-018530	OCT. 12, 2016	OCT. 31, 2016
363	261	16-ATF-018531	OCT. 12, 2016	OCT. 31, 2016
364	261	16-ATF-018532	OCT. 12, 2016	OCT. 31, 2016
365	261	16-ATF-018533	OCT. 12, 2016	OCT. 31, 2016
366	261	16-ATF-018535	OCT. 12, 2016	OCT. 31, 2016
367	261	16-ATF-018536	OCT. 12, 2016	OCT. 31, 2016
368	261	16-ATF-018537	OCT. 12, 2016	OCT. 31, 2016
369	261	16-ATF-018539	OCT. 12, 2016	OCT. 31, 2016
370	261	16-ATF-018541	OCT. 12, 2016	OCT. 31, 2016
371	261	16-ATF-018542	OCT. 12, 2016	OCT. 31, 2016
372	261	16-ATF-018543	OCT. 12, 2016	OCT. 31, 2016
373	262	16-ATF-018544	OCT. 12, 2016	OCT. 31, 2016
374	262	16-ATF-018545	OCT. 12, 2016	OCT. 31, 2016
375	262	16-ATF-018546	OCT. 12, 2016	OCT. 31, 2016
376	262	16-ATF-018548	OCT. 12, 2016	OCT. 31, 2016
377	262	16-ATF-018549	OCT. 12, 2016	OCT. 31, 2016
378	262	16-ATF-018550	OCT. 12, 2016	OCT. 31, 2016
379	262	16-ATF-018552	OCT. 12, 2016	OCT. 31, 2016
380	262	16-ATF-018553	OCT. 12, 2016	OCT. 31, 2016
381	262	16-ATF-018554	OCT. 12, 2016	OCT. 31, 2016
382	262	16-ATF-018556	OCT. 12, 2016	OCT. 31, 2016
383	262	16-ATF-018557	OCT. 12, 2016	OCT. 31, 2016

786

2017-002378 MISC Page: 582 of 693
 03/10/2017 12:35:10 PM Receipt #: 17-1634
 Rec Fee: \$250.00 Darrell- James: Hill
 Gila County, Az, Sadie Jo Bingham, Recorder

USPS RMN RB 898 810.007 US Page

399

2022-011769 MISC Page: 785 of 2782
 09/26/2022 03:35:37 PM Receipt #: 22-9981
 Rec Fee: \$30.00 Darrell James Hill
 Gila County, Az, Sadie Jo Bingham, Recorder



APACHE JUNCTION
 151 W SUPERSTITION BLVD
 APACHE JUNCTION
 AZ
 85120-9998
 0302590130
 11/16/2016 (800)275-8777 3:34 PM

Product Description	Sale Qty	Final Price
First-Class Mail Large Envelope (Domestic) (WASHINGTON, DC 20530) (Weight: 0 Lb 4.10 Oz) (Expected Delivery Day) (Saturday 11/19/2016)	1	\$1.78
Registered (Amount: \$0.00) (99USPS Registered Mail #) (R8898810007US)	1	\$11.70
Return Receipt (99USPS Return Receipt #) (9590940220736132026923)	1	\$2.70
Total		\$16.18
Cash Change		\$18.18 (\$2.00)

In a hurry? Self-service kiosks offer quick and easy check-out. Any Retail Associate can show you how.

Text your tracking number to 28777 (2USPS) to get the latest status. Standard Message and Data rates may apply. You may also visit USPS.com USPS Tracking or call 1-800-222-1811.

BRIGHTEN SOMEONE'S MAILBOX. Greeting cards available for purchase at select Post Offices.

Registered No. **R8898810007US** Date Stamp **0130 08**

Reg. Fee	\$1.78	Return Receipt	
Handling Charge	\$11.70	Restricted Delivery	
Postage	\$2.70		
Received by	\$0.00		
		\$16.18	

Customer Must Declare Full Value: \$0.00 11/16/2016 Domestic insurance up to \$5000 is included. International insurance is limited. (See Reverse)

APACHE JUNCTION, AZ 85120

To Be Completed by Customer (Please Print) All Entries Must Be in Subscript or Type	FROM	Darrell James Hill, 3124 East 18th Avenue, Apache Junction, Arizona (85119)
	TO	Loretta U.S. Attorney General 900 Pennsylvania Avenue, N.W. Washington, District of Columbia (20530-0001)

PS Form 3806, Receipt for Registered Mail Copy 1 - Customer
 May 2007 (7530-02-000-9051) (See information on Reverse)

2022-011769 MISC Page: 786 of 2782
 09/25/2022 03:35:37 PM Receipt #: 22-9381
 Rec Fee: \$30.00 Darrell James Hill
 Gila County, Az, Sadie Jo Bingham, Recorder

2017-002378 MISC Page: 583 of 693
 03/10/2017 12:35:10 PM Receipt #: 17-1834
 Rec Fee: \$250.00 Darrell James Hill
 Gila County, Az, Sadie Jo Bingham, Recorder

400

Registered No. RB898810007US

Date Stamp 0130 08

Reg. Fee	\$1.78	
Handling Charge	\$11.70	Return Receipt
Postage	\$2.70	Restricted Delivery
Received by	\$0.00	
		\$16.18

To Be Completed By Post Office

Customer Must Declare Full Value \$0.00 Domestic insurance up to \$25,000 is included on the declared value. International industry is limited. (See Reverse).

APACHE JUNCTION, AZ 85120 OFFICIAL USE

FROM	
Darrell James Hill, 5124 East 18 th Avenue, Apache Junction, Arizona [85119]	
TO	
Loretta: U.S. Attorney General 950 Pennsylvania Avenue, N.W. Washington, District of Columbia [20530-0001]	

PS Form 3806, Receipt for Registered Mail Copy 1 - Customer May 2007 (7530-02-000-9051) For domestic delivery information, visit our website at: www.usps.com

Sent 11/16/15 Rec. 11/25/16

SENDER, COMPLETE THIS SECTION

- Complete items 1, 2, and 3.
- Print your name and address on the reverse so that we can return the card to you.
- Attach this card to the back of the mailpiece, or on the front if space permits.

1. Article Addressed to:
**Loretta: U.S. Attorney General
950 Pennsylvania Avenue, N.W.
Washington, District of Columbia
[20530-0001]**

2. Article Number (Transfer from service label)
RB 898 810 007 US

COMPLETE THIS SECTION IF DELIVERED

A. Signature Agent
 Addressee

B. Received by (Printed Name) C. Date of Delivery

D. Is delivery address different from item 1? Yes
If YES, enter delivery address below: No

3. Service Type

<input type="checkbox"/> Adult Signature	<input type="checkbox"/> Priority Mail Express®
<input type="checkbox"/> Adult Signature Restricted Delivery	<input checked="" type="checkbox"/> Registered Mail™
<input type="checkbox"/> Certified Mail®	<input type="checkbox"/> Registered Mail Restricted Delivery
<input type="checkbox"/> Certified Mail Restricted Delivery	<input type="checkbox"/> Return Receipt for Merchandise
<input type="checkbox"/> Collect on Delivery	<input type="checkbox"/> Signature Confirmation™
<input type="checkbox"/> Collect on Delivery Restricted Delivery	<input type="checkbox"/> Signature Confirmation Restricted Delivery
<input type="checkbox"/> Insured Mail	
<input type="checkbox"/> Insured Mail Restricted Delivery (over \$500)	

PS Form 3811, July 2015 PSN 7530-02-000-8063 Domestic Return Receipt

2022-011769 MISC Page: 787 of 2782
09/26/2022 03:35:37 PM Receipt #: 22-9381
Rec Fee: \$30.00 Darrell James Hill
Gila County, Az, Sadie Jo Bingham, Recorder

788

2017-002378 MISC Page: 584 of 693
03/10/2017 12:35:10 PM Receipt #: 17-1634
Rec Fee: \$250.00 Darrell James Hill
Gila County, Az, Sadie Jo Bingham, Recorder

401

Darrell- James: Hill, 5124 East 18th Avenue, Apache Junction, Arizona [85119]

USPS RE 322 399 251 US

Jeff: U.S. Attorney General
950 Pennsylvania Avenue, N.W.
Washington, District of Columbia [20530-0001]

NOTICE: CLAIM¹

RE: Property disposed to the United States of America in the "UNITED STATES ATTORNEY'S OFFICE; OFFICIAL NOTIFICATION POSTED ON FEBRUARY 13, 2017"

Jeff, Greetings:

i: man²; am "Darrell- James"; and,
i must address you as "Jeff", the man: the highest form and most positive regard possible³.

i:

- a) make this superior-claim⁴ as the owner⁵ in due course of law⁶ to the property⁷ disposed by the United States⁸ court(s) to the "United States of America"⁹ as noticed in the "UNITED STATES ATTORNEY'S OFFICE; OFFICIAL NOTIFICATION POSTED ON FEBRUARY 13, 2017";

Therefore:

- b) my supreme¹⁰ claim to all of the property specifically disposed to the United States of America:
 - 1) is as indicated in the attached Enclosure One- Amended 'UNITED STATES ATTORNEY'S OFFICE; OFFICIAL NOTIFICATION POSTED ON FEBRUARY 13, 2017, 320 pages;
 - 2) is in due course of law specifically superior to and above all corporation and commercial claims, including but not limited to those of the United States Government, et seq.;

- 1 claim means: a demand for something rightfully due.
- 2 man means: man under Almighty God; to wit, one and man-kind of the people of the united States of America.
- 3 man, the highest form and most positive regard possible means: as I believe, man is named by Almighty God, my/ our Creator; to wit, we can achieve no higher honor but to truly be "man". No other title is higher. I believe: No man-given title is higher than our essential and natural honor under Almighty God of being man; of inalienable right.
- 4 superior-claim means: a claim made by one who is higher or greater than another in rank and qualities of kind
- 5 owner means: one who has the rightful title, whether he is the possessor or not.
- 6 law means: under the establishing documents for the union of states of America, including, but not limited to, the Articles of the Bill of Rights (1789) to the Constitution for the United States of America
- 7 property means: that substance of the right of the exclusive and absolute ownership in its any form
- 8 United States means: the corporation; the government for the union of States of America
- 9 United States of America means: the essential essence of the land and people by the people and for the people.
- 10 supreme means: highest in authority, rank and power, etc.; dominant.

789

USPS RE 322 399 251 US

1/3

2022-011769 MISC Page: 788 of 2782
 09/26/2022 03:35:37 PM Receipt #: 22-9981
 Rec Fee: \$30.00 Darrell James Hill
 Gila County, AZ, Sadie Jo Bingham, Recorder

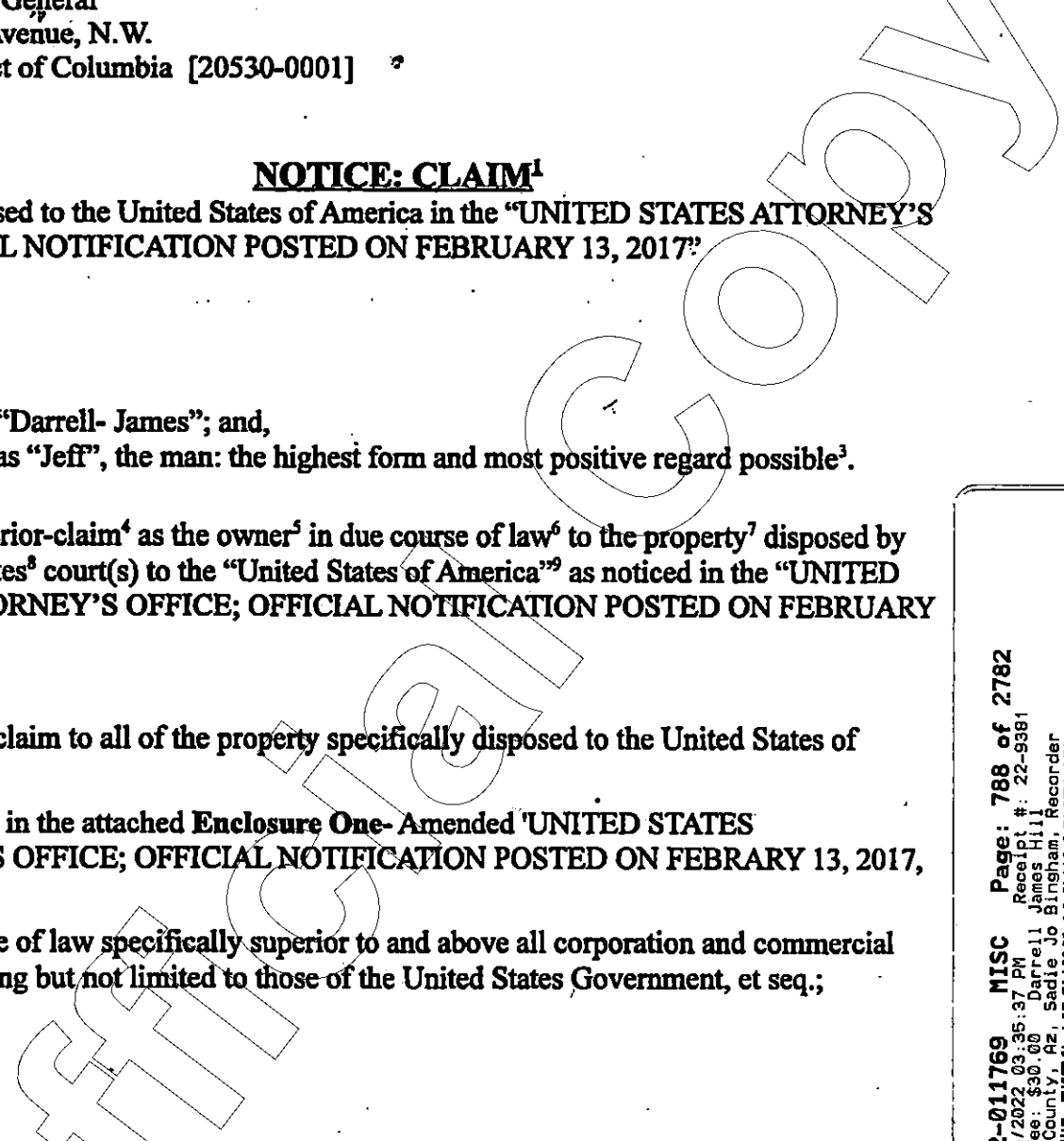
- 3) is made timely within/ about the 60 day time frame timely to co-exist with the ending of U.S. court's commercial petition¹¹ phase, and to avoid appearance of acquiescence or error, and,
- 4) shall be of free and clear title; and all claimed delivered to me, without delay or hesitation following the U.S. court's 60 day petition phase, in regular course of common law.

- Jeff, a) You have 10 days from the time of the receipt of this Notice to respond if you choose; and,
- b) If you do not respond timely then your silence will be accepted as tacit acquiescence of my claim in full. Then after,
 - c) I will recontact you for receipt of my property claimed.

Thank you; Sincerely,

Darrell - James Hill

Darrell- James: Hill

March 19, 2017



Official

¹¹ petition means: A written address, embodying an application or prayer from the person or persona preferring it, to the power, body, or person to whom it is presented, for the exercise of his or their authority in the redress of some wrong, or the grant of some favor, privilege, or license[;] in the nature of Enderson v. Hildenbrand, 52 N.D. 533, 204 N.W. 256; et seq.: Black's Law Dictionary, 4th Ed., p. 1302.



Darrell- James: Hill, 5124 East 18th Avenue, Apache Junction, Arizona [85119]

USPS RE 322 399 251 US

**Enclosure One- Amended 'UNITED STATES ATTORNEY'S OFFICE;
OFFICIAL NOTIFICATION POSTED ON FEBRUARY 13, 2017',
320 pages**

2022-011769 MISC Page: 790 of 2782
09/26/2022 09:35:37 PM Receipt #: 22-9381
Rec Fee: \$30.00 Darrell James Hill
Gila County, Az, Sadie Jo Bingham, Recorder

USPS RE 322 399 251 US

3/3



SENDER - COMPLETE THIS SECTION

ATTACH TO THE FRONT OF THE MAIL OR TO THE REVERSE OF THE MAIL IF SPACE PERMITS

1. Article Addressed to:

**Jeff U.S. Attorney General
950 Pennsylvania Avenue, N.W.
Washington, District of Columbia
[20530-0001]**

2. Article Number (Transfer from PS Form 3800)

RE 322 399 251 US

PS Form 3811, July 2016 PSN 7530-02-000

COMPLETE THIS SECTION ON DELIVERY

A. Signature: *[Signature]*

Agent
 Addressee

B. Received by (Printed Name): *[Name]*

C. Date of Delivery: *[Date]*

3. Yes No

4. Service Type:

Air Mail
 Air Mail Restricted Delivery
 Certified Mail
 Certified Mail Restricted Delivery
 Registered Mail
 Registered Mail Restricted Delivery

5. Priority Mail Express:
 Registered Mail
 Registered Mail Restricted Delivery
 Signature Confirmation
 Signature Confirmation Restricted Delivery

Domestic Return Receipt



Registered No. **RE322399251US**

Reg. Fee	\$13.60	Return Receipt	
Handling Charge	\$11.70	Restricted Delivery	
Postage	\$2.75		
Received by	\$0.00		
Total			\$28.05

Customer Must Declare Full Value: **\$0.00** Date: **03/20/2017**

Domestic Insurance up to \$25,000 is included. International indemnity is limited. (See Reverse).

OFFICIAL USE

FROM: Darrell James Hill, 3124 East 18th Avenue, Apache Junction, Arizona (85119), 85120

TO: Jeff U.S. Attorney General, 950 Pennsylvania Avenue, N.W., Washington, District of Columbia (20530-0001)

PS Form 3806, Receipt for Registered Mail Copy 1 - Customer
May 2007 (7530-02-000-9051) (See Information on Reverse)
For domestic delivery information, visit our website at www.usps.com

APACHE JUNCTION
151 W SUPERSTITION BLVD
APACHE JUNCTION
AZ
85120-9998
0302590130
(800)275-8777 9:44 AM

Product Description	Sale Qty	Final Price
PM 2-Day Med FR Box (Domestic) (WASHINGTON, DC 20530) (Flat Rate) (Expected Delivery Day) (Wednesday 03/22/2017)	1	\$13.60
Registered (Amount: \$0.00) (99USPS Registered Mail #) (RE322399251US)	1	\$11.70
Return Receipt	1	\$2.75
99USPS Return Receipt # (9590940220736132037493)		
Total		\$28.05
Cash		\$40.05
Change		(\$12.00)

Includes up to \$50 insurance

Text your tracking number to 28777 (2USPS) to get the latest status. Standard Message and Data rates may apply. You may also visit USPS.com USPS Tracking or call 1-800-222-1611.

BRIGHTEN SOMEONE'S MAILBOX. Greeting cards available for purchase at select Post Offices.

In a hurry? Self-s...

Claim 2
251

Unofficial Copy

:(C) :Oct. 31- 2016 :Property -Claim: RE 322 399 279 US
:Gila county, Ariz. -Doc. # 2017-002378, :page: 243- 549.

:(K) :Mar. 31- 2017 :Property -Claim: RE 322 399 251 US
:Gila county, Ariz. -Doc. # 2019-009291, :page: 9- 333, 342- 343.

:(T) :Sept. 26- 2017 :Property -Claim: RE 322 399 248 US
:Gila county, Ariz. -Doc. # 2019-009291, :page: 374- 737.

Unofficial Copy

793

2022-011769 MISC Page: 792 of 2782

09/26/2022 03:35:37 PM Receipt #: 22-9381

Rec Fee: \$30.00 Darrell James Hill

Gila County, Az, Sadie Jo Bingham, Recorder



1
2
3
4
5
6
7
8
9
10
11
12
13
14
15
16
17
18
19
20
21
22
23
24
25
26
27
28
29
30
31
32
33
34
35
36
37
38
39
40

AFFIDAVIT¹: PROOF OF CLAIM:

A.R.S. 11-480(D): Gila County Recorder - Doc Num: 2017-002378

Darrell- James: House of Hill, aggrieved party
c/o 5124 East 18th Avenue
Apache Junction, Arizona
Zip Code Exempt, Non-Domestic

**Declaration² In Claim³ Against⁴ Criminal⁵ Wrong-Doings⁶
By State Party⁷ Agents⁸
Of The United States⁹- Department Of Justice⁹, "DOJ", And
Of The 9th Circuit Court Administration¹⁰:**

**Of Deprivation¹¹ Of My Inalienable¹² Fundamental¹³ And Natural
Rights^{14 15} and Freedoms guaranteed¹⁶ Protected¹⁷: By (a) The Constitution¹⁸ For
The United States¹⁹ Of America²⁰ People²¹, 1787, "Const-1787", (b) The Bill Of
Rights²², 1789- 1791, "BORights-1789-91", and (c) The "International Covenant²³
On Civil²⁴ And Political²⁵ Rights²⁶", "ICCPR", Treaty Ratified By The Senate In
1992²⁷, "ICCPR Treaty";**

**Of Deprivations imposed²⁸ Against Me By Men, United States
Government Agents, Wrong-Doers Against "Public Policy²⁹"**

**For The Exercise³⁰ Of My Rights To Secure "Property-Claimed"³¹ And To
A Common Law^{32 33} With Trial³⁴-By-Jury³⁵ At The United States District Court³⁶-,
"USDC", Arizona, Phoenix: To Wit: "In The Hill Court; A 'Federal Court' At
The USDC- Arizona, Phoenix : Claimant Case³⁷ No: CMN 7009 1410 0000,
7868 5703³⁸;**

Content

- Section 1 Foreword**
- Section 2 I am one of the people**
- Section 3 Inalienable Supreme Law of The Land**

AFFIDAVIT: PROOF OF CLAIM: May-July 2017

With the Copy-Claim:

2022-011769 MISC Page: 793 of 2782
09/26/2022 03:35:37 PM Receipt #: 22-9381
Rec Fee: \$30.00 Darrell James Hill
Gila County, Az, Sadie Jo Bingham, Recorder



USDC
794

- 1 Section 4 United States', "State Party", Obligation to the Law of the Land
- 2 Section 5 Enemies, foreign or domestic
- 3 Section 6 Crimes Committed Against Me
- 4 Section 7 Enforce⁴⁰ My Exercise Of My Inalienable Rights
- 5 Section 8 Conclusion

6
7 Section 1 Foreword

8
9 1) I⁴¹, man⁴², Darrell- James: House Of Hill, "Darrell- James: Hill", under oath,
10 do affirm, claim and declare: that: all⁴³ the facts stated herein are to the best of my
11 ability true, correct, complete, not hearsay, not misleading; are admissible as
12 evidence, if not rebutted and proven inaccurate; and, i will verify same in open
13 court:

14 2) Use of any⁴⁴ statutes, codes, rules, regulations, or court citations, within any
15 document created by me, at any time, is only to notice that which is applicable to
16 government personnel, and is not intended, nor shall it be construed, to mean that i
17 have conferred, submitted to, or entered into any jurisdiction alluded to thereby.

18
19 Purpose:

20 3) I proclaim: my fundamental rights and freedoms have been deprived by
21 men acting as State Party Agents and domestic enemies; I believe this behavior
22 is for to prevent me from securing and receiving my property-claimed. My
23 property-claimed is Not State Party Government property⁴⁵. It is my wish this
24 system be stopped by the legitimate United States Government and that i be
25 made whole.

26
27 Section 2 I, man, am one of the people

28
4) "What is man, that thou art mindful of him? and the son of man, that thou
visitest him? For thou hast made him a little lower than the angels, and
hast crowned him with glory and honour. Thou madest him to have
dominion over the works of thy hands; thou hast put all things under his
feet:..." KJV, Psalms 8:4- 6

5) "... Ye are gods; and all of you are children of the most High." KJV,
Psalms-82:6. "Jesus answered them, Is it not written in your law, I said,
Ye are gods?" KJV John 10:34

29
30 6) I, Darrell- James: Hill, am one of the natural non-political aggregate of
31 sovereign people understanding Almighty God. Any presumption that i am the

AFFIDAVIT: PROOF OF CLAIM: May-July 2017

With the Copy-Claim:

2022-011769 MISC Page: 794 of 2782
09/26/2022 03:35:37 PM Receipt #: 22-9381
Rec Fee: \$30.00 Darrell James Hill
Gila County, Az, Sadie Jo Bingham, Recorder



Handwritten signature and initials "n95" in the bottom left corner.

1 Idem- Sonans⁴⁶ "DARRELL JAMES HILL", et seq⁴⁷.- statutory class of persons, a
2 product of the State Party Government, is false and has been denied⁴⁸.

3
4 7) i herein decree⁴⁹ that all statutory presumptions ever been made against
5 me under the presumption of the idem-sonans entity "DARRELL JAMES
6 HILL", et seq., to be void ab-initio^{50 51 52}.

7
8 "United States of America" means the people-sovereigns

- 9 8) I) The "United States of America"⁵³ means the people(s); it refers to an
10 unincorporated man-being, me.
11 9) II) There is no such thing as State Party sovereignty over the natural people-
12 sovereigns⁵⁴.
13 10) III) It is a fact that the State Party Government exists to protect and serve the
14 sovereign people; and,
15 11) IV) the people are commonly sovereign merely by their very existence⁵⁵.

16
17 i Am A Living Soul Unincorporated Inhabitant

18 12) It is an undisputed fact that a cestui-que-vie record of my birth^{56 57} onto the
19 earth was onto the territory of Ohio state in the year one thousand nine hundred and
20 fifty eight. There, i finished high school in the year one thousand nine hundred and
21 seventy six; therefore, i am well past the age of majority; and, further, that i am a
22 living soul sui juris⁵⁸, holder de jure⁵⁹ of the common office of one of the people of
23 the non-political aggregate, and, presently, an unincorporated inhabitant on the
24 Arizona state territory at the time of this signing.

25
26 **Section 3 Inalienable Supreme Law of The Land**

- 27
28 13) a. The Const.-1787 and the BORights-1789-91 are the Supreme
29 inalienable Law of the Land⁶⁰. The Const.-1787⁶¹, The BORights-1789-91, and
30 the statutory ICCPR Treaty⁶² are the Supreme Law of the Land. And,
31
32 14) The Supreme Court of the United States, "SCOTUS", is the final authority
33 for the interpretations of the Constitution- Supreme law of the Land⁶³.
34
35 15) b. The ICCPR Treaty enactment was ratified by United States Senate
36 in 1992. 138 Cong. Rec. S4781-01 (1992). Section IV says: "The Senate's advice
37 and consent is subject to⁶⁴ the following proviso⁶⁵, Nothing⁶⁶ in this Covenant
38 requires⁶⁷ or⁶⁸ authorizes⁶⁹ legislation⁷⁰, or other⁷¹ action⁷², by the United States of
39 America prohibited⁷³ by the Constitution of the United States⁷⁴ as interpreted⁷⁵ by
40 the United States⁷⁶." The prevailing § IV proviso supersedes §§ I, II and III, and

AFFIDAVIT: PROOF OF CLAIM: May-July 2017

Claim:



Handwritten signature and scribbles in the bottom left corner, including the number '296'.

1 establishes the ICCPR Treaty enforceable⁷⁷ as self-operating⁷⁸ and not self-
2 executing^{79 80}.

3
4 **Section 4 United States', "State Party", Obligation to the Law of the Land**

5
6 16) The State Party is obligated to the ICCPR Treaty through the International
7 Covenant(s), and this comes out in the ICCPR Treaty Ratification reservations,
8 obligations, declarations and proviso the State Party made that it would respect
9 these rights:

10
11 17) ICCPR Treaty Ratification: II(5). The Senate's advice and consent is
12 subject to the following understandings, which shall apply to the obligations of the
13 United States under this Covenant: ... (5). That the United States understands that
14 this (ICCPR) Covenant shall be implemented by the Federal Government to
15 the extent that it exercises legislative and judicial jurisdiction over the matters
16 covered therein, and otherwise by the state and local governments: to the extent
17 that state and local governments exercise jurisdiction over such matters, the Federal
18 Government shall take measures appropriate to the Federal system to the end that
19 the competent authorities of the state or local governments may take appropriate
20 measures for the fulfillment of the Covenant.

21
22 18) The State Party Government is obligated under the Supreme Law of The
23 Land in accordance with ICCPR Treaty Ratification: II(5) to persist unequivocally
24 against those State Party Agents who deprived me of my fundamental rights and
25 freedoms guaranteed protected "in accordance with its constitutional processes" -
26 See ICCPR Treaty Article 2(2)⁸¹. And, further;

27
28 *I Exercised My Rights*

29 19) i brought forward the constitutional documents aforementioned which bring-
30 forth the implementing Laws that recognize these rights: The Declaration of
31 Independence to the Supreme Law of the Land - the Const-1787 and the
32 BORights-1789-91, the Ohio and Arizona state constitutions; all say that all men
33 have these inalienable rights; further,

34
35 *i Stand As Man In My Full Legal Capacity Without legal abridgment^{83 84}*

36 20) i am standing as a natural man, one of the of the people of the non-political
37 aggregate, operating in my full legal capacity, exercising my Almighty God-given
38 fundamental rights and freedoms, without legal abridgment. Under the ICCPR
39 Treaty Article 1(1)⁸⁵ supported by the Supreme Law of the Land i claimed
40 fundamental law rights and freedoms to political self-determination to be a man,

APPRANT: PROOF OF CLAIM: May-July 2017

With the Copy-Claim:

2022-011769 MISC Page: 796 of 2782
09/26/2022 03:35:37 PM Receipt #: 22-9381
Rec Fee: \$30.00 Darrell James Hill
Gila County, Az, Sadie Jo Bingham, Recorder



Handwritten signature and number '197' in the bottom left corner.

- 1 one of the of the people of the non-political aggregate, operating *in my full legal*
2 *capacity*;
- 3 21) Deprivation of my natural and fundamental law right to chose to Not to be/
4 engage in the political special statuses or sundry statutory personages, is a violation
5 of the ICCPR Treaty, Article 1(1). Furthermore;
- 6
- 7 22) Under the ICCPR Treaty Article 14(1)⁶⁶ supported by the Supreme Law of
8 the Land i claimed fundamental law rights and freedoms to bring any common
9 law claim with trial by jury.
- 10 23) Deprivation of my right to bring a common law claim with trial by jury is a
11 violation of my rights-exercised under ICCPR Treaty, Article 14(1); and, further,
12
- 13 24) Under the ICCPR Treaty Article 1(2)⁶⁷ supported by the Supreme Law of the
14 Land i claimed fundamental law rights and freedoms to not be forced to make
15 a contribution of my property-claim to the State Party under the principle of
16 mutual benefit.
- 17 25) Depriving me of my property-claimed, possessing, holding and refusing to
18 release my property to me is a violation of my rights-exercised under the ICCPR
19 Treaty, Article 1(2). Moreover,
20
- 21 26) Under the ICCPR Treaty Article 47⁶⁸ supported by the Supreme Law of the
22 Land i claimed fundamental law rights and freedoms to 'utilize fully and freely
23 [my] natural wealth and resources.'
- 24
- 25 27) Any inalienable rights or otherwise right guaranteed protected by the Const-
26 1787 & BORights-1789-91 would be of little value if they could be indirectly
27 denied; in the nature of *Gomillion v. Lightfoot*, 364 U.S. 155.
28
- 29 28) One SCOTUS narrative likened this 'deprivation of rights under the color of
30 law' experience to slavery: [T]he fundamental right to life, liberty, and pursuit of
31 happiness, considered as individual possessions, are secured by those maxims of
32 constitutional law which are the monuments showing the victorious progress of the
33 race in securing to men the blessings of civilization under the reign of just and
34 equal laws, "For the very idea that one man may be compelled to hold his
35 life, or the means of living, or any material right essential to the enjoyment of
36 life at the mere will of another seems to be intolerable in any country where
37 freedom prevails, as being the essence of slavery itself." *Yick Wo v. Hopkins*,
38 118 U.S. 256.
39
- 40 29) No one shall be held in slavery;.... ICCPR Treaty, Article 8(1).

AFFIDAVIT PROOF OF CLAIM: May-July 2017

With the Copy-Claim:



Handwritten signature and the number '298' are visible in the bottom left corner.

1
2
3
4
5
6
7
8
9
10
11
12
13
14
15
16
17
18
19
20
21
22
23
24
25
26
27
28
29
30
31
32
33
34
35
36
37
38
39
40

No ICCPR provision for violation of the Supreme Law of the Land

30) "Nothing in the present Covenant may be interpreted as implying for any State, group or person any right to engage in any activity or perform any act aimed at the destruction of any of the rights and freedoms recognized herein or at their limitation to a greater extent than is provided for in the present Covenant." ICCPR Treaty Article 5(1).

31) Any State Party Agents of National DOJ or of the 9th Circuit Court Administration who under the color of law⁸⁹ violated these provisions of law – the Law of the Land and statutory laws thereupon, as determined by the SCOTUS, have violated my fundamental rights and freedoms by No provision of the ICCPR supported by the Supreme Law of the Land.

32) It may be that it is the obnoxious thing in its mildest and least repulsive form; but illegitimate and unconstitutional practices get their first footing in that way, namely, by silent approaches and slight deviations from legal modes of procedure. This can only be obliterated by adhering to the rule that constitutional provisions for securing of person and property should be liberally construed. A close and literal construction deprives them of half their efficacy, and leads to gradual depreciation of the right, as if it consisted more in sound than in substance. It is the duty of courts to be watchful for the constitutional rights of the [man], and against any stealthy encroachments thereon. *Boyd v. United States*, 116 U.S. 616, 635.⁹⁰

Section 5 Enemies, foreign or domestic

33) My fundamental-inalienable rights and freedoms are not subject to vote; they are forever. And, these fundamental rights and freedoms embodied in the Supreme Law of the Land have been set to recognition internationally within the ICCPR Treaty. When the State Party Agencies or Agents violate the Constitution then they are creating felonies; and, based upon the foundation of our government those State Party Agents are domestic enemies.

34) The United States Government has an obligation⁹¹ to national and international covenants to protect my fundamental-law rights and freedoms. Once these obligations have been breached⁹² by State Party Agents within the National DOJ and the 9th Circuit Court Administration; these State Party Agents that commit felony Constitutional Law violations are criminals: wrong-doers and domestic

AFFIDAVIT PROOF OF CLAIM: May-July 2017

With the Copy-Claim:



Handwritten signature and scribbles in the bottom left corner.

1 enemies, Not representatives of the legitimate Government. The State Party
2 must expediently, assertively/aggressively and assuredly protect me from domestic
3 enemies, which is no more than their obligation.

4
5 **Section 6 Crimes Committed Against Me**

6 At the US DOJ

7 35) From October 2016, a man, a State Party Agent of the National DOJ of the
8 United States Government, et al., I) began criminally holding to possess my
9 property-claimed, II) did Not acknowledge and/or III) ignored my claim for the
10 property with return correspondence or release of property-claimed; and, IV)
11 subsequently, defaulted in Dishonor⁹³, estoppel⁹⁴ by silence⁹⁵. Therefore:

12
13 At the USDC- Arizona, Phoenix

14 36) In the month of January 2017, I ordered an at common law⁹⁶ trial by jury-
15 claim⁹⁷ with the men, State Party Agents, at the USDC- Arizona, Phoenix; the claim
16 was for property-claimed in an amount in controversy of greater than one hundred
17 sixty-five thousand one ounce silver dollars; and, further,

18 37) The State Party Agents did I not file^{98,99} my common-law claim at the USDC
19 as i ordered for to get my property-claimed secured and returned to me: they
20 instead II) filed a commercial¹⁰⁰ complaint^{101, 102} in the USDC, III) without
21 authority¹⁰³: and that, IV) WITHOUT REGARD TO: 1) the express written pre-
22 notifications to the men of my common law-trial by jury intent¹⁰⁴, 2) a rightful¹⁰⁵
23 'Compensation Due agreement¹⁰⁶, activated¹⁰⁷ if the State Party Agents trespassed¹⁰⁸
24 on the case¹⁰⁹, and 3) subsequent demands - Gross trespass on the case¹¹⁰, and
25 felony¹¹¹ Constitutional and statutory violations¹¹²; and, further,

26 38) A month later, the group indicated in writing that my claim, meaning their
27 commercial complaint, would not be heard unless i gave assent¹¹³ legitimizing their
28 jurisdiction¹¹⁴ over their commercial complaint filing of my common law claim
29 documents. - extortion violation of 28 U.S.C. §§ 2071, 2072¹¹⁵ Their lawful duty
30 was to record all proceedings faithfully and impartially¹¹⁶

31
32 At the USDC- Magistrate was Involved

33 39) The magistrate involved was a man who, having not received jurisdiction
34 from me, self-imposed jurisdiction over their commercial complaint. All of my
35 demands made for to proceed upon my common law claim as ordered for suit were
36 ignored¹¹⁷. - Trespass on the case, misprision of felony¹¹⁸, 18 U.S.C. § 241,
37 conspiracy against my fundamental rights and freedoms, and fraud¹¹⁹.

38
39 The Loss¹²⁰, The Damage¹²¹ And The Grief¹²²

40 40) The State Party Agents actions have caused me significant loss, damage and grief:

AFFIDAVIT PROOF OF CLAIM: May-July 2017

With the Copy-Claim:



1 I) deprivation of my inalienable fundamental law rights and freedoms; II) loss and harm
2 by non-possession of my property-claimed; III) loss and harm by non-use benefit of my
3 property-claimed: IV) grief of the after nearly seven months of the extraordinary difficulty
4 of obtaining simple justice from corrupt State Party Agency Administrations of/under ex-
5 President Obama Administration.

6
7 41) i am testifying and declaring the true seeking justice: my rights, my property,
8 my resources, and for the criminals to answer for their crimes and judicial
9 tyranny¹²³.

10
11 **Section 7 Enforce My Exercise Of My Inalienable Rights**
12 **Oath Of Office, Duty And Obligation**
13

14 42) The heart is deceitful above all things, and desperately wicked; who can
15 know it? I the LORD search the heart, I try the reins, even to give every
16 man according to his ways, and according to the fruit of his doings. KJV,
17 Jeremiah 17: 9-10

18 43) It is a snare to the man who devoureth *that which* is holy, and after vows
19 to make enquiry. KJV: proverbs 20:25

20 44) State Party Agents under oath of office to the Constitution, and duty and
21 obligation must ensure, promote, respect, protect and enforce my exercise of my
22 inalienable rights. However, I above testify true and declare a history in fact of
23 record detailing criminal actions against me imposed by State Party Agents:
24 criminal actions, not mere error, systemic, systematic practices to defraud me of
25 and to undermine my exercise of inalienable fundamental rights and freedoms.

26 45) [When a State Party Agent] acts in excess of his statutory authority or in
27 violation of the Constitution... he ceases to represent the Government. United
28 States v. Stewart, 234 F. Supp. 94.

29 **When State Party Agents Are Criminals**

30 46) When the State Party Agents' acts are criminal wrongdoings then the
31 likelihood of any effective administrative remedy in redress of that criminal
32 behavior is perceptively very low to absent: at best a Kangaroo Court¹²⁴. No one is
33 required to pursue an administrative remedy in this situation. But, because;

34 47) *... [T]he [Main] United States understands that this (ICCPR) Covenant shall
35 be implemented by the Federal Government to the extent that it exercises
36 legislative and judicial jurisdiction over the matters covered therein, ... for the

801
AFFIDAVIT: PROOF OF CLAIM: May-July 2017

With the Copy-Claim:



1 fulfillment of the Covenant. -- ICCPR Treaty Ratification, II(5) -- then, to lay to
2 rest speculation,

3
4 48) I reported¹²⁵ my rights deprivation(s) and situation to the 9th Circuit
5 Executive Committee of three¹²⁶ by USPS Registered Mail delivery¹²⁷. After two
6 months, i yet want for a timely Const.-1787 - BORights-1789-91 - ICCPR Treaty
7 compliant response from them; there is No answer regarding their implementation
8 of restraint, control over, correction and/or elimination of their criminal
9 subordinates. --

10
11 The Result: Probable: The Scheme-Scam Is Condoned

12 49) Essentially, working together governmental agencies can steal from
13 anyone, and deny your access to court except under their special Kangaroo Court
14 jurisdiction, and all under their watchful eyes of misprision of felonies; to wit: The
15 initial and continued possession of my property-claimed by the State Party Agents
16 of the National DOJ is in direct violation of ICCPR Treaty Articles 1(1) and 47,
17 Const.-1787, Article 1(8), and Bill of Right-1789-91, Amendment V. And, the
18 State Party Agents of the 9th Circuit Court Administration deprived my right to a
19 common law trial by jury by fraud tantamount to theft¹²⁸ and judicial tyranny in
20 dereliction of duty, obligation and oath to the Supreme Law of The Land. -- a
21 Coordinated organization.

22
23 Remedy And Recourse

24 50) The United States Constitution -- the Const.-1787, BORights-1789-91 --,
25 the Supreme-inalienable Law of The Land, supersedes every other law in the
26 United States' Executive, Legislative or Judicial branches of Government. And, all
27 State Party Agents are sworn under oath to the Constitution to defend the people-
28 sovereigns from all enemies, both foreign and domestic. *This legally binding duty*
29 and obligation under oath of office is to protect me and my exercise of my
30 fundamental rights and freedoms. And, this is what I require:

31
32 51) I) With regard to my inalienable fundamental rights and freedoms secured
33 by the Constitution for the United States of America; I wish my fundamental
34 rights and freedoms ensured, promoted, respected, protected and enforced in
35 my exercise of my rights, here now and to forever; the State Party must
36 aggressively and assuredly protect my rights-exercised by every related access.

37
38 52) II) With regard to that No filing fee is/was required for my common law
39 claims; I wish the filing fee reimbursed immediately to the address above.

40 53) "A state may not impose a charge for the enjoyment of a right granted by the

802
AFFIDAVIT-PROOF OF CLAIM: May-July 2017

With the Copy-Claim:

2022-011769 MISC Page: 801 of 2782
09/26/2022 03:35:37 PM Receipt #: 22-9381
Rec Fee: \$30.00 Darrell James Hill
Gila County, Az, Sadie Jo Bingham, Recorder



1 Federal Constitution." Davis v. Wechsler, 263 U.S. 22, 24[;]

2
3 54) III) With regard to that the State Party Agents of the 9th Circuit Court
4 Administration did systematically trespass on the case; i wish to receive the
5 compensation due for same as agreed: the deprivation by the men began at 10:30
6 am, January 04, 2017, and has not been resolved at the time of this signing;

7
8 55) IV) With regard to that the State Party Agents of the National DOJ have held
9 and continue to hold my property-claimed: 1) i wish to receive the compensation
10 due as agreed: the deprivation began at 04:35 am, October 31, 2016, and has not
11 been resolved at the time of this signing; and, 2) i wish all of my property-
12 claimed released to me post haste to the address above.

13
14 56) "No person shall ... be deprived of life, liberty, or property, without due
15 process of law; nor shall private property be taken for public use, without just
16 compensation." Const.-1787 & BORights-1789-91: Article the seventh
17 [Amendment V]; and,

18
19 57) V) With Regard to the The State Party Criminals who performed in dishonor
20 and dereliction¹²⁹ of duty; i wish them be identified, prosecuted and terminated;
21 never again to hold public office.

22
23 Section 8: Conclusion

24
25 58) i am a common man of the non-political aggregate of people-sovereigns
26 standing upon the principles of justice to exercise my Almighty God- given
27 inalienable fundamental law rights and freedoms.

28
29 59) This Affidavit Proof Of Claim is prima facie sufficient to establish that i
30 indeed have these fundamental rights-inalienable and freedoms.

31
32 60) i claimed and exercised my fundamental rights and freedoms to secure and
33 take receipt of my property-claimed.

34 61) Any federal, state or local State Party Agent who answered my exercise of
35 my rights and freedoms with the violation of my fundamental rights and freedoms
36 is a criminal: enemies domestic; the men State Party Agents of the National DOJ
37 who under the color of law deprived me of my right to receive my property-
38 claimed; and, the men State Party Agents of the 9th Circuit Court Administration
39 who did under the color of law deprived me of my right to a common law trial by
40 jury far to secure and receive my property-claimed.

803
AFFIDAVIT PROOF OF CLAIM: May-July 2017

With the Copy-Claim:



1
2
3
4
5
6
7
8
9
10
11
12
13
14
15
16
17
18
19
20
21
22
23
24
25
26
27
28
29
30
31
32
33
34
35
36
37
38
39
40

62) The entire Const.-1787 and BORights-1789-91 Covenant is in place for the State Party to protect to my fundamental rights and freedoms.

63) I, Darrell- James: Hill, require and demand the men of the legitimate State Party Government, under the ICCPR Treaty supported by the Supreme Law of the Land, to aggressively ensure, promote, respect, protect and enforce my fundamental rights and freedoms against all enemies, to meet the remedies specified above – Section 6 --, to resolve the deprivation of rights/losses sustained from State Party Agents indicated, and to provide report(s) of same subscribed under penalty of perjury.

This affidavit is affirmed under penalties of perjury under the common law within the united States of America and without the United States.

Without Prejudice, All Rights Reserved.
Notice For The Principal Is Notice For the Agent;
Notice For The Agent Is Notice For The Principal

Darrell James: Hill

Darrell- James: Hill,
Living Soul, one of the
common people of the
United States of America

L.S.

Jurat

Arizona state
Pinal county

Sworn and signed before me this 06th day, July 2017.

Heather Wood
Notary



AFFIDAVIT PROOF OF CLAIM: May-July 2017

With the Copy-Claim:

2022-011769 MISC Page: 803 of 2782
09/26/2022 03:35:37 PM Receipt #: 22-9381
Rec Fee: \$30.00 Darrell James Hill
Gila County, Az, Sadie Jo Bingham, Recorder



804



- 1
- 2
- 3
- 4
- 5
- 6
- 7
- 8
- 9
- 10
- 11
- 12
- 13
- 14
- 15
- 16
- 17
- 18
- 19
- 20
- 21
- 22
- 23
- 24
- 25
- 26
- 27
- 28
- 29
- 30
- 31
- 32
- 33
- 34
- 35
- 36
- 37
- 38
- 39
- 40

Unofficial Copy

EXHIBIT ONE:
ICCP Treaty Resolution of Ratification,
4 pages

AFFIDAVIT PROOF OF CLAIM: May-July 2017

With the Court Claim:

805

2022-011769 MISC Page: 804 of 2782
09/26/2022 03:35:37 PM Receipt #: 22-9381
Rec Fee: \$30.00 Darrell James Hill
Gila County, Az, Sadie Jo Bingham, Recorder



1
2
3
4
5
6
7
8
9
10
11
12
13
14
15
16
17
18
19
20
21
22
23
24
25
26
27
28
29
30
31
32
33
34
35
36
37

U. S. reservations, declarations, and understandings.
International Covenant on Civil and Political Rights
138 Cong. Rec. S4781-01 (daily ed., April 2, 1992)

<https://www.state.gov/documents/organization/235639.pdf> - 1/4

IX. TEXT OF RESOLUTION OF RATIFICATION

Resolved, (two-thirds of the Senators present concurring therein),
That the Senate advise and consent to the ratification of the Inter-national Covenant
on Civil and Political Rights, adopted by the United Nations General Assembly on
December 16, 1966, and signed on behalf of the United States on October 5, 1977,
(Executive E, 95-2), subject to the following reservations, understandings,
declarations and proviso:

I. The Senate's advice and consent is subject to the following reservations:

(1) That Article 20 does not authorize or require legislation or other
action by the United States that would restrict the right of free speech
and association protected by the Constitution and laws of the United
States.

(2) That the United States reserves the right, subject to its Constitutional
constraints, to impose capital punishment on any person (other than a
pregnant woman) duly convicted under existing or future laws
permitting the imposition of capital punishment, including such
punishment for crimes committed by persons below eighteen years of
age.

(3) That the United States considers itself bound by Article 7 to the
extent that "cruel, inhuman or degrading treatment or punishment"
means the cruel and unusual treatment or punishment prohibited by the
Fifth, Eighth and/or Fourteenth Amendments to the Constitution of the
United States.

(4) That because U. S. law generally applies to an offender the penalty in

AFFIDAVIT: PROOF OF CLAIM: May-July 2017

With the Copy-Claim:

2022-011769 MISC Page: 805 of 2782
09/26/2022 03:35:37 PM Receipt #: 22-9381
Rec Fee: \$30.00 Darrell James Hill
Gila County, Az, Sadie Jo Bingham, Recorder

806



1 force at the time the offense was committed, the United States does not
2 adhere to the third clause of paragraph 1 of Article 15.

3
4 (5) That the policy and practice of the United States are generally in
5 compliance with and supportive of the Covenant's provisions regarding
6 treatment of juveniles in the criminal justice system. Nevertheless, the
7 United States reserves the right, in exceptional circumstances, to treat
8 juveniles as adults, notwithstanding paragraphs 2(b) and 3 of Article 10
9 and paragraph 4 of Article 14. The United States further reserves to
10 these provisions with respect to individuals who volunteer for military
11 service prior to age 18.

12 II. The Senate's advice and consent is subject to the following
13 understandings, which shall apply to the obligations of the United States
14 under this Covenant:

15 (1) That the Constitution and laws of the United States guarantee all
16 persons equal protection of the law and provide extensive protections
17 against discrimination. The United States understands distinctions based
18 upon race, color, sex, language, religion, political or other opinion,
19 national or social origin, property, birth or any other status - as those
20 terms are used in Article 2, paragraph 1 and Article 26 - to be permitted
21 when such distinctions are, at minimum, rationally related to a
22 legitimate governmental objective. The United States further
23 understands the prohibition in paragraph 1 of Article 4 upon
24 discrimination, in time of public emergency, based "solely" on the status
25 of race, color, sex, language, religion or social origin not to bar
26 distinctions that may have a disproportionate effect upon persons of a
27 particular status.

28
29 (2) That the United States understands the right to compensation referred
30 to in Articles 9(5) and 14(6) to require the provision of effective and
31 enforceable mechanisms by which a victim of an unlawful arrest or
32 detention or a miscarriage of justice may seek and, where justified,
33 obtain compensation from either the responsible individual or the
34 appropriate governmental entity. Entitlement to compensation may be
35 subject of the reasonable requirements of domestic law.

36
37 (3) That the United States understands the reference to "exceptional
38 circumstance" in paragraph 2(a) of Article 10 to permit the

AFFIDAVIT: PROOF OF CLAIM: May-July 2017

With the Copy-Claim:



407

1
2
3
4
5
6
7
8
9
10
11
12
13
14
15
16
17
18
19
20
21
22
23
24
25
26
27
28
29
30
31
32
33
34
35
36
37
38
39

imprisonment of an accused person with convicted persons where appropriate in light of an individual's overall dangerousness, and to permit accused persons to waive their right to segregation from convicted persons. The United States further understands that paragraph 3 of Article 10 does not diminish the goals of punishment, deterrence, and incapacitation as additional legitimate purposes for a penitentiary system.

(4) That the United States understands that subparagraphs 3(b) and (d) of Article 14 do not require the provision of a criminal defendant's counsel of choice when the defendant is provided with court-appointed counsel on grounds of indigence, when the defendant is financially able to retain alternative counsel, or when imprisonment is not imposed. The United States further understands that paragraph 3(e) does not prohibit a requirement that the defendant make a showing that any witness whose attendance he seeks to compel is necessary for his defense. The United States understands the prohibition upon double jeopardy in paragraph 7 to apply only when the judgment of acquittal has been rendered by a court of the same governmental unit, whether the Federal Government or a constituent unit, as is seeking a new trial for the same cause.

(5) That the United States understands that this Covenant shall be implemented by the Federal Government to the extent that it exercises legislative and judicial jurisdiction over the matters covered therein, and otherwise by the state and local governments; to the extent that state and local governments exercise jurisdiction over such matters, the Federal Government shall take measures appropriate to the Federal system to the end that the competent authorities of the state or local governments may take appropriate measures for the fulfillment of the Covenant.

III. The Senate's advice and consent is subject to the following declarations:

(1) That the United States declares that the provisions of Articles 1 through 27 of the Covenant are not self-executing.

(2) That it is the view of the United States that States Party to the Covenant should wherever possible refrain from imposing any restrictions or limitations on the exercise of the rights recognized and protected by the Covenant, even when such restrictions and limitations are permissible under the terms of the Covenant. For the United States, Article 5, paragraph 2, which provides that fundamental human rights

AFFIDAVIT: PROOF OF CLAIM: May-July 2017

With the Copy-Claim:

2022-011769 MISC Page: 807 of 2782
 09/26/2022 03:35:37 PM Receipt #: 22-9381
 Rec Fee: \$30.00 Darrell James Hill
 Gila County, Az, Sadie Jo Bingham, Recorder

808



1
2
3
4
5
6
7
8
9
10
11
12
13
14
15
16
17
18
19
20
21
22
23
24
25
26
27
28
29
30
31
32
33
34

existing in any State Party may not be diminished on the pretext that the Covenant recognizes them to a lesser extent, has particular relevance to Article 19, paragraph 3, which would permit certain restrictions on the freedom of expression. The United States declares that it will continue to adhere to the requirements and constraints of its Constitution in respect to all such restrictions and limitations.

(3) That the United States declares that it accepts the competence of the Human Rights Committee to receive and consider communications under Article 41 in which a State Party claims that another State Party is not fulfilling its obligations under the Covenant.

(4) That the United States declares that the right referred to in Article 47 may be exercised only in accordance with international law.

IV. The Senate's advice and consent is subject to the following proviso, which shall not be included in the instrument of ratification to be deposited by the President:

Nothing in this Covenant requires or authorizes legislation, or other action, by the United States of America prohibited by the Constitution of the United States as interpreted by the United States.

<https://www.state.gov/documents/organization/235639.pdf> -- 4/4

AFFIDAVIT PROOF OF CLAIM: May-July 2017

With the Conv. Claim:

809

2022-011769 MISC Page: 808 of 2782
09/26/2022 03:35:37 PM Receipt #: 22-9381
Rec Fee: \$30.00 Darrell James Hill
Gila County, Az, Sadie Jo Bingham, Recorder



- 1
- 2
- 3
- 4
- 5
- 6
- 7
- 8
- 9
- 10
- 11
- 12
- 13
- 14
- 15
- 16
- 17
- 18
- 19
- 20
- 21
- 22
- 23
- 24
- 25
- 26
- 27
- 28
- 29
- 30
- 31
- 32
- 33
- 34
- 35
- 36
- 37
- 38
- 39
- 40

Unofficial Copy

EXHIBIT TWO
Birth Certificate,
1 page

AFFIDAVIT PROOF OF CLAIM: May-July 2017

With the Copy Claim:

810

2022-011769 MISC Page: 809 of 2782
09/26/2022 03:35:37 PM Receipt #: 22-9381
Rec Fee: \$30.00 Darrell James Hill
Gila County, Az, Sadie Jo Bingham, Recorder



2017-008322 RFF Page: 35 of 54
07/07/2017 10:09:05 AM Receipt #: 17-4724
Rec Fee: \$50.00 Darrell James
Gila County, Az, Sadie Jo Bingham, Recorder

1
2
3
4
5
6
7
8
9
10
11
12

I HEREBY CERTIFY THIS DOCUMENT IS AN EXACT COPY OF THE RECORD ON FILE WITH THE OHIO DEPARTMENT OF HEALTH.

DE 24 08 017341

Judith B. Hagy
JUDITH B. HAGY, STATE REGISTRAR
OFFICE OF VITAL STATISTICS
WITH COUNTY SIGNATURE & SEAL

COPY

OHIO DEPARTMENT OF HEALTH
DIVISION OF VITAL STATISTICS
CERTIFICATE OF LIVE BIRTH

Reg. Dist. No. <u>7701</u>		Register's No. <u>9370</u>	
Primary Reg. Dist. No. <u>7701</u>		Birth No. <u>184-58-208851</u>	
1. PLACE OF BIRTH a. COUNTY <u>Summit</u>		2. USUAL RESIDENCE OF MOTHER (Report each mother listed) a. STATE <u>Ohio</u> b. COUNTY <u>Summit</u>	
3. CITY, VILLAGE, OR LOCATION <u>Akr on</u>		4. CITY, VILLAGE, OR LOCATION <u>Summit</u>	
5. NAME OF HOSPITAL OR INSTITUTION <u>Akron City Hospital</u>		6. STREET ADDRESS <u>219 King Ct.</u>	
7. IS PLACE OF BIRTH INSIDE CITY LIMITS? YES <input checked="" type="checkbox"/> NO <input type="checkbox"/>		8. IS RESIDENCE INSIDE CITY LIMITS? YES <input checked="" type="checkbox"/> NO <input type="checkbox"/>	
9. NAME (TYPE OR PRINT) First <u>Darrell</u> Middle <u>James</u> Last <u>Hill</u>		10. DATE OF BIRTH MONTH <u>NOV</u> DAY <u>20</u> YEAR <u>58</u>	
11. SEX M <input checked="" type="checkbox"/> SINGLE <input checked="" type="checkbox"/> TWIN <input type="checkbox"/> TRIPLE <input type="checkbox"/> 1st <input type="checkbox"/> 2nd <input type="checkbox"/> 3rd <input type="checkbox"/>		12. COLOR OR RACE <u>Negro</u>	
13. NAME First <u>CLAYTON</u> Middle <u>Lee</u> Last <u>Archer</u>		14. COLOR OR RACE <u>Negro</u>	
15. AGE (at time of this birth) <u>35</u> YEARS		16. BIRTHPLACE (State or foreign country) <u>Archer</u>	
17. MAIDEN NAME (Last) <u>Archer</u>		18. PREVIOUS DELIVERIES TO MOTHER (do not include this birth) a. How many OTHER children are now living? <u>3</u> b. How many OTHER children were born alive but are now dead? <u>none</u> c. How many fetal deaths (miscarried born dead or still born)? <u>none</u>	
19. INFORMANT'S NAME OR SIGNATURE <u>Orn Hill</u>		20. DATE SEROLOGIC TEST FOR SYPHILIS <u>Mar 58</u>	
21. SIGNATURE <i>[Signature]</i>		22. DATE SIGNED <u>11-28-58</u>	
23. ADDRESS <u>AKRON, OH</u>		24. ATTENDANT AT BIRTH M. D. <input checked="" type="checkbox"/> N. M. <input type="checkbox"/> MIDWIFE <input type="checkbox"/> OTHER (Specify)	
25. DATE RECORDED BY LOCAL BUREAU <u>11-28-58</u>		26. DATE ON WHICH GIVEN NAME ADDED <u>11-28-58</u>	

AFFIDAVIT PROOF OF CLAIM: May-July 2017

With the Copy-Claim:

2022-011769 MISC Page: 810 of 2782
09/26/2022 03:35:37 PM Receipt #: 22-9381
Rec Fee: \$30.00 Darrell James Hill
Gila County, Az, Sadie Jo Bingham, Recorder

U
811



- 1 Affidavit means: "No more than [affidavits are] necessary to make the Prima facie case." U.S. v. Kis, 658 F. 2nd 526
- 2 declaration means: The first of the pleadings on the part of the plaintiff in an action at law, being a formal and methodical specification of the facts and circumstances constituting his cause of action.
- 3 claim means: a challenge of property or ownership of a thing which is wrongfully withheld from the possession of the claimant. Fowd. 359. A claim is a right or title, actual or supposed, to a debt privilege or other thing in the possession of another;... 2 N. Y. 245, 254[.] Bouvier's Law Dictionary, 1st Ed., p. 209.
- 4 Against means: in opposition to, adverse, hostile; in an opposite direction or position
- 5 criminal means: pertaining to crimes: an act committed in violation of a law prohibiting it, or [an omission] in violation of a law ordering it... 2. extreme violation of the law; wrongdoing of a criminal nature, as felony or treason, which affects the whole public and not just the rights of an individual: distinguished from misdemeanor. Webster's New 20th Century Unabridged, 2nd Ed., p. 431.
- 6 wrong-doing: that which is improper or unjust actions
- 7 State Party means: all The Federal, State And Local Government Entities
- 8 State Party Agents means: all The Federal, State And Local Government's agents or does otherwise who perform for the State Party directly, or through proxy
- 9 National Executive Branch- Department Of Justice, "DOJ" means: Loretta Lynch, et al., et seq. Jeffrey S. All State Party Agents of the DOJ System having knowledge and/or participation, aiding or abetting
- 10 9th Circuit Court Administration means: All State Party Agents of the 9th Circuit Court System having knowledge and/or participation, aiding or abetting
- 11 deprivation means: to entirely take away
- 12 inalienable means: that which cannot be transferred or surrendered, such as an inalienable right: means: A right that cannot be transferred or surrendered, a natural right such as the right to own property. Not subject to statutory manipulation.
- 13 fundamental means: "One's right to life, liberty, and property, to free speech, a free press, freedom of worship and assembly, and other fundamental rights may not be submitted to vote; they depend on the outcome of no elections[.]" West Virginia Bd. of Ed. v. Barnette, 319 U.S. 624, 638, 63 S.Ct. 1178, 87 L.Ed. 1628 (1943).

fundamental law means: The law which determines the constitution of government in a state, and prescribes and regulates the manner of its exercise; the organic law of a state; the constitution.

- 14 natural rights means: those rights that is conceived as part of natural law and that is therefore thought to exist independently of rights created by government or society, such as the right to life, liberty, and property, which grow out of the nature of man and depend upon personality, as distinguished from such as are created by law and depend upon civilized society; or they are those which are plainly assumed by natural law (Borden v. State, 11 Ark. 519, 44 Am.Dec. 217); ...[.] Black's Law Dictionary, 4th Ed., p1487. natural law means: A physical law of nature, i.e. gravity, property.
- 15 rights means: what someone deserves; a just claim, what is morally due; the property of life, liberty and property sacred to one and wholly set aside for private use.
- 16 guaranteed means: held in surety for that the obligation due under covenant must be performed
- 17 protect means: to, in advance, to defend and guard
- 18 Constitution means: the Constitution for the United States of America, 1787, "Const.-1787", generally also making inclusive reference to the BOnights-1789-91
- 19 United States means: one must be cognizant and clear about the usage of the term which means: [1] It may be merely the name of a sovereign occupying the position analogous to that of other sovereigns in the family of nations. [2] It may designate the territory over which the sovereignty of the United States extends, or [3] it may be the collective name of the states which are united by and under the constitution. [.] in the nature of Hooven & Allison Co. vs. Evatt, 324 U.S. 652
- 20 United States of America means: the people of the united States of America
- 21 people means: the word "people" may have various significations according to the connection in which it is used. When we speak of the rights of the people, or of the government of the people by law, or of the people as a non-political aggregate, we mean all the inhabitants of the state or nation, without distinction as to sex, age, or otherwise. But when reference is made to the people as the repository of sovereignty, or as the source of governmental power, or to popular government, we are in fact speaking of that selected and limited class of citizens to whom the constitution accords the elective franchise and the rights of participation in the offices of government. Black. Const. Law 3d Ed., p. 30[.] Black's Law Dictionary, 4th Ed., p1292. repository means: a person to whom something is entrusted or confided; ...[.] Webster's New 20th Century Unabridged, 2nd Ed., p. 1535.
- 22 BOnights means: "... THE Conventions of a number of the States, having at the time of their adopting the Constitution, expressed a desire, in order to prevent misconstruction or abuse of its powers, that further declaratory and restrictive clauses should be added; And as extending the ground of public confidence in the Government, will best ensure the beneficial ends of its in-... BY CONSENT of the Senate and House of Representatives of the United States of

8/12



jurisdictional limits of the court, drawn and selected ..., duly impaneled and sworn [to determine the matters of fact and law] to render a true verdict according to the law [and] evidence[.] in the nature of: Black's Law Dictionary, 4th Ed., p. 993.

- 36 court means: *International Law*: The person and suite of the sovereign; the place where the sovereign sojourns with his regal retinue, wherever that may be. retinue means: group of followers, state of service; literally, that which is retained.
- 37 case means: "trespass on the case". trespass, on the case means: At common law, an action to recover damages that are not the immediate result of a wrongful act but rather a later consequence; Black's Law 7th Ed, p. 1508-9.
- 38 Claimant Case No: CMN 7009 1410 0000 7868-5703 means: In the *Hill Court*; a 'Federal Court' at the USDC- Arizona, Phoenix; January 04, 2017 - USPS RMN RE 322 399 336 US; rec'd 01/04/2017. See Notice: PROOF OF CLAIM' at Gila County Recorder - site: <http://recorder.gilacountyaz.gov/recorder/web/> Document Number: 2017-002378, pp. 182-693 .
- 39 State Party means: the United States Government for the United States of America
- 40 enforce means: to make or gain by force or violence, compel
- 41 I: means: re: capitus dominus. Chief lord. Son understanding the the Most High God of Abraham, Isaac and Jacob of the Holy Bible, and a sovereign over-standing the creation and subsequent creations
- 42 man means: a) a flesh and blood Adam, species of man-kind, understanding Almighty God of Abraham, Isaac and Jacob of the Holy Bible, and a sovereign one who in a collective capacity with others common sovereigns are the people of the United States of America over-standing the government for the people of the United States of America; b) NOT a cestui que trust, corporation, or other classes of persons or fictitious entities; c) NOT a US citizen; d) NOT an inhabitant in a federal area See at Gila County Recorder - site: <http://recorder.gilacountyaz.gov/recorder/web/> Document Number: 2017-002378, pg 199-217.

"... God created man in his *own* image, in the image of God created he him; male and female created he them." KJV, Genesis 1:27

- 43 all means: 100%
- 44 any means: Some; one out of many; an indefinite number[.] in the nature of State v. Pierson, 204 Iowa 837, et seq. One indiscriminately of whatever kind or quantity[.] in the nature of Federal Deposit Ins. Corporation v. Winton, C.C.A.Tenn. , 131 F.2d 780, 782[.] Black's Law Dictionary, 4th Ed., p. 120.
- 45 not State Party property means: Government may seize evidence simply for purpose of proving crime.... Introduction of "mere evidence" does not in itself entitle state to its retention. Warden, Md. Penitentiary v. Hayden, SCOTUS May 29, 1967 387 U.S. 294 87 S.Ct. 1642 18 L.Ed.2d 782
- 46 Idem-Sonans means: Sounding the same or alike; having the same sound. A term applied to names which are substantially the same, though slightly varied in the spelling. [.] in the nature of 1 Comp & M. 806; et seq....; Black's Law Dict. 4th Ed. , p 880.
- 47 DARRELL JAMES HILL means: an Idem-Sonans commercial entity ascribed artificial being or person; "et seq.," having many related forms; in contradistinction to the man "Darrell-James; house of Hill"
- 48 presumptions of Idem Sonans are voided means: Affidavit: Superior Constructive Notice and Demand.... See at Gila County Recorder - site: <http://recorder.gilacountyaz.gov/recorder/web/> Document Number: 2017-002378, pp. 109-127 .
- 49 decree means: declare officially, a decision
- 50 ab initio means: L.; from the first act; entirely; as to all the acts done; in the inception...[.] in the nature of Plow. 6a, 16a; ...[.] Black Law Dict. 4th Ed. , p. 289
- 51 I, Darrell-James: Hill, the living soul, have never, with full knowledge and awareness, knowingly and voluntarily and intentionally, agreed with or established understanding, acceptance, or agreeing with any sort of being identified as a corporation, constructive trust, or any other artificial variety entity via any state party governmental actor, against the Idem-sonans "DARRELL JAMES HILL", et seq.- name variations.
- 52 "The failure of an adverse party to deny under oath the allegation that he is incorporated with the necessity of proof of the fact [it becomes part of the official record];" in the nature of Galleria Bank v. Southwest properties, 498 SW 2nd
- 53 The "United States Of America" defined within the originating documents means the people. "(L) The Stile of the Confederacy shall be The United States of America." Articles of Confederation, November 1777 - 1781.

We the People of the United States in Order to form a more perfect Union, establish Justice, insure domestic Tranquility, provide for the common defence, promote the general Welfare, and secure the Blessings of Liberty to ourselves and our Posterity, do ordain and establish this Constitution for the United States of America." Const.-1787: Preamble.

"All debts contracted and Engagements entered into, before the Adoption of this Constitution [for the United States of America], shall be as valid against the United States [the State Party] under this Constitution, as under the [Articles of] Confederation." Const.-1787, Article VI. Cl. I.

814



The United States Constitution and the laws passed pursuant to it are the supreme laws of the land, binding alike upon states, courts, and the people, anything in the Constitution or laws of any state to the contrary notwithstanding. *Tests v. Katt*, U.S.R.1947, 67 S.Ct. 810, 330 U.S. 386, 91 L.Ed. 967.

The Constitution of the United States is the supreme law of the land to which all government, state and federal is subject." Constitution for the State of Arizona, 1912: Section 3. A.

The provisions of the [Arizona state] Constitution are mandatory unless by express words they are declared to be otherwise. Article 2, §32

- 62 A treaty lawfully entered into stands on the same footing of supremacy as do the Constitution and laws of the United States. *Amaya v. Stanolind Oil & Gas Co.*, C.C.A.5 (Tex.) 1946, 158 F.2d 554, certiorari denied 67 S.Ct. 1191, 331 U.S. 808, 91 L.Ed. 1828, rehearing denied 67 S.Ct. 1530, 331 U.S. 867, 91 L.Ed. 1871.
- 63 While Supreme Court may view conformity with its previous decisions as matter of stare decisis, federal district court must adhere to constitutional interpretations by Supreme Court as matter of law by virtue of this clause. *Joiner v. City of Dallas*, N.D.Tex.1974, 380 F.Supp. 754, affirmed 95 S.Ct. 614, 419 U.S. 1042, 42 L.Ed.2d 637, rehearing denied 95 S.Ct. 818, 419 U.S. 1132, 42 L.Ed.2d 831.

State governments are bound to comply with the Supreme Court of the United States' rulings and court orders based upon the Supreme Court's interpretation of the Constitution. *Cooper v Aaron*, 358 U.S. 1

- 64 subject to means: Liable, subordinate, subservient, inferior, obedient to; ... [i] in the nature of *American Mfg. co. v. Commonwealth*, 251 Mass. 329, et seq.; [i] *Black's Law Dictionary*, 4th Ed., p.1594.
- 65 proviso means: A condition or provision which is inserted in a ... contract, and on the performance or nonperformance of which the validity of the instrument frequently depends; ... A clause or part of a clause in a statute, the office of which is either to except something from the enacting clause, or to qualify or restrain its generality, or to exclude some possible ground of misinterpretation of its extent; [i] in the nature of *Cox v. Hart*, 260 U.S. 427, et seq.; *Black's Law Dictionary*, 4th Ed., p.1390.
- 66 nothing means: not anything; no thing; not any being or existence; the opposite of *anything, something*... [i] a thing does not exist.
- 67 require means: To direct, order, demand, instruct, command, claim, compel, request, need, exact; [i] in the nature of *Beakey v. Kmtson*, 90 Or. 574, et seq.; [i] *Black's Law Dictionary*, 4th Ed., p.1461.
- 68 or means: A disjunctive particle used to express an alternative or to give a choice of one among two or more things... to clarify what has already been said; [i] in the nature of *Peck v. Board of Directs...*, 137 La. 334, [et seq.]. Or is frequently misused; and courts will construe it to mean "and" where it was so used; [i] in the nature of *State v. Circuit Court of Dodge County*, 176 Wis. 198, [et seq.]; *Black's Law Dictionary*, 4th Ed., p.1246.
- 69 authorize means: to empower; to give a right or authority to act; [i] in the nature of *Board of Com'rs of Sedgwick County v. Toland*, 121 Kan. 109, et seq. ... It has mandatory effect of meaning, implying a direction to act; [i] in the nature of *Quality Building & Securities Co. v. Bledsoe*, 125 Cal.App. 493, et seq.; *Black's Law Dictionary*, 4th Ed., p.169.
- 70 legislation means: The Act of giving or enacting law; the power to make laws; the act of legislating; preparation and enactment of law; the making of laws by express decree; [i] in the nature of *State ex rel Yancey v. Hyde*, 121 Ind 20, et seq.; *Black's Law Dictionary*, 4th Ed., p.1045.
- 71 other means: Different or distinct from that already mentioned; additional or further; [i] in the nature of *Cit of Ft. Smith v. Gunter*, 106 Ark. 371, et seq. ... Following an enumeration of particular classes "other" must be read as "other such like," and includes only others of like kind and character; [i] in the nature of *Van Pelt v. Hilliard*, 75 Fla. 792, et seq.; *Black's Law Dictionary*, 4th Ed., p.1253.
- 72 action means: Conduct; behavior; something done; the condition of acting; an act or series of acts; *Black's Law Dictionary*, 4th Ed., p.49.
- 73 prohibit means: To forbid by law; to prevent; - not synonymous with "regulate; [i] in the nature of *Simpkins v. Sate*, 25 Okl.Ct. 143, et seq.; *Black's Law Dictionary*, 4th Ed., p.1377.
- 74 United States means: the usage reference for the government for the people of the United States of America
- 75 interpret means: to construe; to seek out the meaning of language; to translate orally from one tongue to another; [i] *Black's Law Dictionary*, 4th Ed., p.953.
- 76 as interpreted by the United States means: as interpreted by the SCOTUS
- 77 The ICCPR Treaty has been and remains enforceable as depicted in the § IV proviso as "Self-Operating", with No mention of "Not Self-Executing." The ICCPR ratification § III(1) declared treaty portions "not self-executing," while the prevailing § IV proviso depicted the whole treaty as self-operating: to wit: A) self-operating (requiring no special legislation) while B) not self-executing (Not "with accompanying implementing regulations where from a right of action is specified to individuals alleging breach of its provisions"); and, concordantly so, because the "implementing

816



Dictionary, 4th Ed., p. 1554.

96 at common law meaning: 1 Stat. 73 Chap. XX. -- An act to establish the Judiciary Courts of the United States; Sec. 16. And be it further enacted, That suits in equity shall not be sustained in either of the courts of the United States, in any case where plain, adequate and complete remedy may be had at law.

(b) ... If a case is cognizable at common law, the defendant has a right of trial by jury, and a suit upon it cannot be sustained in equity. *Baker v Biddle*, 1 Baldwin's C. C. R. 465. There cannot be concurrent jurisdiction at law and equity, where the right and remedy are the same; but equity may proceed in aid of the remedy at law, by incidental and auxiliary relief, if the remedy at law is complete... The 16th section of the judiciary law is a declaratory act settling the law as to cases of equity jurisdiction, in the nature of a proviso, limitation or exception to its exercise. If the plaintiff have a plain, adequate and complete remedy at law, the case is not a suit in equity, under the constitution, or the judiciary act. ... Though the rules and principles established in English Chancery at the revolution, are adopted in the federal courts, the changes introduced there since, are not followed here; especially in matters of jurisdiction, as to which the 16th section of the act of 1789 is imperative.

97 The BORights-1789-91: Article IX.-Amendment VII

"In suits at common law, where the value in controversy shall exceed twenty dollars, the right of trial by jury shall be preserved, and no fact tried by a jury, shall be otherwise re-examined in any Court of the United States, than according to the rules of the common law." BORights-1789-91: Amendment VII.

The right of trial by jury shall remain inviolate. ... [T]he number of jurors, not less than six, and the number required to render a verdict, shall be specified by law. Arizona State Constitution, Article 2 § 23.

Phrase "suits at common law" in Seventh Amendment refers to suits in which legal rights are to be ascertained and determined, in contradistinction to those where equitable rights alone are recognized and equitable remedies are administered. *Granfinanciera, S.A. v. Nordberg*, U.S.Fla. 1989, 109 S.Ct. 2782, 492 U.S. 33, 106 L.Ed.2d 26.

This [seventh] amendment was designed to preserve the basic institution of [trial by jury] in only its most fundamental elements, and did not bind federal courts to exact procedural incidents or details of jury trial according to common law. *Galloway v. U.S.*, U.S.Cal.1943, 63 S.Ct. 1077, 319 U.S. 372, 87 L.Ed. 1438, rehearing denied 63 S.Ct. 1443, 320 U.S. 214, 87 L.Ed. 851.

While historically Seventh Amendment was intended to preserve right to jury trial as it existed in 1791, guarantees afforded have been interpreted to encompass not merely suits which common law recognized among its old and settled proceedings, but suits in which legal rights are to be ascertained and determined, in contradistinction to those where equitable rights alone are recognized and equitable remedies are administered. *Ginberg v. Tauber*, D.C.1996, 678 A.2d 543, certiorari denied 117 S.Ct. 738, 519 U.S. 1077, 136 L.Ed.2d 677.

This [seventh] amendment preserves to litigants right to jury trial in suits at common law, including not merely suits which common law recognized but suits in which legal rights were to be ascertained and determined, in contradistinction to those where equitable rights alone were recognized and equitable remedies were administered. *Farmers-Peoples Bank v. U.S.*, C.A.6 (Tenn.) 1973, 477 F.2d 752. See, also, *Hyde Properties v. McCoy*, C.A.Tenn.974, 507 F.2d 301.

Seventh Amendment right to jury trial applies not only to common-law causes of action, but also to statutory causes of action analogous to common-law causes of action ordinarily decided in English law courts in the late 18th century, as opposed to those customarily heard by courts of equity or admiralty. *City of Monterey v. Del Monte Dunes at Monterey, Ltd.*, U.S.Cal.1999, 119 S.Ct. 1624, 526 U.S. 687, 143 L.Ed.2d 882.

98 See: The Judiciary Act; September 24, 1789. Sec. 7. And be it [further] enacted, That the Supreme Court, and the district courts shall have power to appoint clerks for their respective courts, and that the clerk for each district court... and each of the said clerks shall, before he enters upon the execution of his office, take the following oath or affirmation, to wit: "I, A. B., being appointed clerk of, do solemnly swear or affirm, that I will truly and faithfully enter and record all the orders, decrees, judgments and proceedings of the said court, and that I will faithfully and impartially discharge and perform all the duties of my said office, according to the best of my abilities and understanding. So help me God!... And the said clerks shall also severally give bond, with sufficient sureties, 1 Stat. 73. *An Act to Establish the Judicial Courts of the United States* [;] and, consistently,

Whoever, being a clerk of a district court of the United States, willfully refuses or neglects to make or forward any report, certificate, statement, or document as required by law, shall be fined under this title or imprisoned not more than one year, or both. 18 U.S.C. § 2076 -- Clerk of United States District Court. 62 Stat. 796; 110 Stat. 3498.

99 did not file meaning: the Clerk of Court, et al., Whoever, being a clerk of a district court of the United States, willfully

818

2022-011769 MISC Page: 817 of 2782

09/26/2022 03:36:37 PM Receipt #: 22-9381
Darrell James Hill
Sadie Jo Bingham, Recorder
Gila County, Az



- nature of *Ex parte Ramirez*, 49 Cal.App.2d 709, et seq; Black's Law Dictionary, 4th Ed., p. 744.
- 112 Violation means: violate: to use force or violence to break a law, rule, promise, etc.; ... to treat roughly or abusively, to mistreat. Webster's 20th Century Unabridged, 2nd Ed., p. 2040.
- 113 assent means: Compliance; approval of something done; a declaration of willingness to do something in compliance with a request[;] in the nature of *Norton v. Davis*, 83 Tex. 32; et seq.; Black's Law Dictionary, 4th Ed., p. 149.
- 114 Jurisdiction means: the legal right by which [judicial officers] exercise their authority[;] in the nature of *Max Amm, Inc. v. Barker*, 293 Ky. 798, et seq.; Black's Law Dictionary, 4th Ed., p. 991.
- 115 28 U.S.C. § 2071 – Judiciary and Judicial Procedure, Part V – Procedure, Chapter 131 – Rules of Courts – Rule-making power generally, (a) the Supreme Court and all courts established by Act of Congress may from time to time prescribe rules for the conduct of their business. Such rules shall be consistent with Acts of Congress and rules of practice and procedure prescribed under section 2072 of this title[;] and,
28 U.S.C. § 2072 – Judiciary and Judicial Procedure, Part V – Procedure, Chapter 131 – Rules of Courts, – Rules of procedure and evidence; power to prescribe, (a) the Supreme Court shall have the power to prescribe general rules of practice and procedure and rules of evidence for cases in the United States district courts (including proceedings before magistrate judges thereof and courts of appeals. (b) Such rules shall not abridge, enlarge or modify any substantive right.
- 116 See: The Judiciary Act; September 24, 1789. Sec. 7. [;] and, consistently, 18 U.S.C. § 2076 – Clerk of United States District Court. 62 Stat. 796; 110 Stat. 3498. Ibid
- 117 ignore means: To disregard willfully; to refuse to recognize; to decline to take notice of [;] in the nature of *Cleburne County v. Morton*, 69 Ark. 48; Black's Law Dictionary, 4th Ed., p. 882.
- 118 18 U.S.C. § 4 Misprision of felony. Whoever, having knowledge of the actual commission of a felony cognizable by a court of the United States, conceals and does not as soon as possible make known the same to some judge or other person in civil or military authority under the United States, shall be fined under this title or imprisoned not more than three years, or both.
- 119 When a court violates the clean and unambiguous language of the Constitution, a fraud is perpetrated and no one is bound to obey it. *State v. Sutton*, 63 Minn. 147

"In *Bradley v. Fisher*, 80 U.S. (13 Wall) 335, 351-352, the supreme Court established the guidelines for determining the scope of judicial immunity: "Where there is clearly no jurisdiction over the subject-matter, any authority exercised is a usurped authority, and for the exercise of such authority, when the want of jurisdiction is known to the judge, no excuse is permissible." *Bauers v. Heisel*, 361 F.2d 581

A void judgment is one that has been procured by extrinsic or collateral fraud, or entered by a court that did not have jurisdiction over the subject matter or the parties. *Reuk v. Reuk* 353 S.E.2d 756

In general, fundamental rights protected by the [Constitutional] Bill of Rights, such as due process apply only to individual persons, not to the federal government. *Lyons v. United States*, 99 Fed.Cl. 552.

"Where rights secured by the Constitution are involved, there can be no rule making or legislation which would abrogate them." *Miranda v. Arizona*, 284 U.S. 436, 491

- 120 loss means: the damage, trouble, disadvantage, deprivation, etc. caused by losing something
- 121 damage means: the hurt or harm as a result of the loss of any property, or use thereof
- 122 grief means: the intense emotional pain caused by loss, misfortune, injury, or evils of any kind
- 123 tyranny means: cruel or unjust use of power
- 124 Kangaroo court means: a sham legal proceeding in which a person's rights a totally disregarded and in which the result is a foregone conclusion because of the bias of the court or other tribunal. Black's Law Dictionary, 6th Ed., p. 868.
- 125 However, in my observation, given the scope and scale of the actions evidenced in my case, and given the conspicuous absence of common law actions in the Phoenix, Arizona area of several million people, the likelihood is that I am in fact testifying and reporting herein about a much larger and serious problem: even, perhaps larger systemic and systematic State Party Agents who by deceit under the color of law are at wrong-doings against the United States of America people by systematic deprivation of constitutionally guaranteed inalienable fundamental rights and freedoms.
- 126 9th Circuit Judicial Council Executive Committee means: Sidney, acting as Chief Judge, Chairman; Richard, acting as Circuit Judge; and Susan, acting as Senior District Judge; c/o Office of Executive Committee, P.O. Box 193939, San Francisco, California 94119-3939
- 127 USPS RMN: RE 322 399 234 US; Sent April 27, 2017; Rec'd May 1, 2017, 1:53pm
- 128 stolen means: condition after to steal, means: to rob and take away, deprive one of
- 129 Dereliction means: voluntarily abandonment; derelict means: to abandon, forsake, desert, cast away

820



Darrell- James: Hill c/o 5124 East 18th Avenue, Apache Junction, Arizona [85119]

USPS RMN RE 322 399 044 US

Jeff, AG Sessions
c/o **Kenneth A, Acting Assistant AG Blanco**
US DOJ Criminal Division
950 Pennsylvania Avenue, NW
Washington, District of Columbia 20530-0001

USPS RMN RE 322 399 058 US

Elizabeth A. Strange, Acting USA
Two Renaissance Square
40 N. Central Avenue, Suite 1200
Phoenix, Arizona 85004-4408

USPS CMN 7015 0640 0001 5883 2655

Office of Information Policy
Laurie, Chief OIP Day
Initial Request Staff
1425 New Your Avenue, N.W., Suite 11050
Washington, District of Columbia 20530-0001

USPS RMN RE 322 399 061 US

Michael E. Horowitz, IG- DOJ,
IG of Investigations
c/o **Robert P. Storch, Deputy IG-DOJ**
1425 New York Avenue, N.W., Suite 7100
Washington, District of Columbia 20530-2011

USPS RMN RE 322 399 089 US

Acting Director, FBI
c/o **Andrew, Deputy Director McCabe**
c/o **David, Assoc. Dep. Dir. Bowdich**
J. Edgar Hoover Building
935 Pennsylvania Avenue NW
Washington, District of Columbia 20535-3000

USPS RMN RE 322 399 075 US

Richard, Branch Manager Benson
Michael, SA in Charge DeLeon
FBI- Phoenix, Arizona
21711 N. 7th Street
Phoenix, Arizona 84024

USPS First Class Mail

Mark, Sheriff Lamb
Pinal county Sheriff Office
971 Jason Lopez Cir., Building C
Florence, Arizona 85132

USPS RMN RE 322 399 092 US

c/o
Office of the POTUS
Donald, Pres. Trump
1600 Pennsylvania Ave N.W.
Washington, District of Columbia 20500

USPS RMN RE 322 399 044 US

821
Affidavit: Notice of Claim in declaration USPS RMN RE 322 399 044 US

1/3

2022-011769 MISC Page: 820 of 2782
09/26/2022 03:35:37 PM Receipt #: 22-9381
Rec Fee: \$30.00 Darrell James Hill
Gila County, Az, Sadie Jo Bingham, Recorder



Darrell- James: Hill c/o 5124 East 18th Avenue, Apache Junction, Arizona [85119]

USPS RMN RE 322 399 044 US

Greetings:

Thank you for your service to the people of the United States of America.

i¹, man², Darrell- James: Hill, am an aggrieved³ one of the people.

- 1) i exercise(d) my fundamental rights and freedoms, and my rights were(have been) taken away by Agents of the State: your criminal subordinates, and other State Party Agents, of the Government for the United States of America who appear to be of one criminal intent;
- 2) My AFFIDAVIT⁴: PROOF OF CLAIM identifies to you how that Governmental criminal subordinates imposed fraud and misdirection to deprive my fundamental right(s) and freedoms secured by the supreme Law of the Land; thus,
- 3) i must represent my declaration of Constitutional abuses directly to the respondeat superior(s), et al., You:

Summary of Event

I) The DOJ holding property-claimed by me: a matter of public record⁵, first Claim

On, October 31, 2016, Loretta, a man acting as the Attorney General Lynch, "AG", for the U.S. Department of Justice, "DOJ", i formally demanded claim upon for property disposed to the United States of America, "property-claimed", to me. Loretta, in Dishonor, did Not dispose my property-claimed to me; this is an AG, et al., trespass. Loretta was 'removed' from office on January 20th, 2017.

II) The 9th Circuit USDC Deprived Common Law Claim: a matter of public record⁶

On January 04th, 2017, i ordered a common law claim with trial by jury at the 9th Circuit USDC- Phoenix for to secure and receive my property-claimed⁷. However, the men of the 9th Circuit Administration, et al., a) ignored all requests and requirements to file my common law claim as ordered, and b) filed a commercial complaint in the USDC- Phoenix⁸; Harm, Criminal: The USDC- Arizona, 9th Circuit Administration deprived me of my Almighty-God given rights secured by the Supreme Law of the Land: ICCPR Treaty, Const.-1787 and the BORights-1789-91⁹; and, prevented receipt of property and benefit of my property-claimed.

III) The FBI and Title 18 U.S.C. §§ 241-242, Constitutional rights and freedoms Violations

The FBI website indicated to report fundamental rights and freedom violations - Title 18

- 1 i: means: re: capitus dominus. Chief lord. Son understanding the the Most High God of Abraham, Isaac and Jacob of the Holy Bible, and a sovereign over-standing the creation and subsequent creations
- 2 man means: See "presumption setting": at Gila County Recorder - site: <http://recorder.gilacountyaz.gov/recorder/web/> Document Number: 2017-002378, pg 198-217.
- 3 See: declaration, AFFIDAVIT: PROOF OF CLAIM -- JULY 06, 2017 -- Attached/ Gila County Recorder - site: <http://recorder.gilacountyaz.gov/recorder/web/> Document Number: 2017-006522.
- 4 Affidavit means: "No more than [affidavits are] necessary to make the Prima facie case." U.S. v. Kis, 658 F. 2nd 526
- 5 See: Notice: First Claim: to Loretta: Gila County Recorder - site: <http://recorder.gilacountyaz.gov/recorder/web/> Document Number: 2017-002378, p. 241-549; rec'd October 31st, 2016: 0435 a.m.
- 6 See: USDC Filing: Doc 1: Gila County Recorder - site: <http://recorder.gilacountyaz.gov/recorder/web/> Document Number: 2017-002378, p. 192-693.
- 7 Ibid, 5.
- 8 See: 9th Circuit USDC- Arizona, Phoenix, CV-17-00026-PHX-BSB, a commercial complaint
- 9 Ibid, 3.

822

Affidavit: Notice of Claim in

2022-011769 MISC Page: 821 of 2782
09/26/2022 03:35:37 PM Receipt #: 22-9381
Rec Fee: \$30.00 Darrell James Hill
Gila County, Az, Sadie Jo Bingham, Recorder



U.S.C. §§ 241-242¹⁰ – to them: FBI Visit on Monday, July 10th, 2017: i arrived at the FBI-Phoenix location at 21711 N 7th Street, Phoenix, Arizona, 85024, about 1130 a.m.. The entry guard at the front entry window screened my desire to file a fundamental rights and freedom claim: a) The security guard at the entry b) gave me a 800-223-5324 number to call. c) The number was a 'hotline', and d) the call was recorded- the man knew who i am and where i was. e) The man said he is not familiar with Title 18 U.S.C. §§ 241-242; and, f) his 4th "referral" - 'legal advice' was tantamount to 'Not protect my rights but call somebody else to "report": DOJ- OIG at 202-514-3435';

IV) The DOJ- OIG Call: 202-514-3435

While yet sitting in the parking area of the FBI Station, i initiated the DOJ- OIG Call: 202-514-3435. The man at the DOJ- OIG suggested writing to: I) the DOJ-OIG at 1425 New York Avenue, N.W., Room 7100, Washington, District of Columbia 20530; Attn: Investigations; and II) to call the Office of Administrative Courts at 202-502-2600 with regard to actions by a judge, clerk, etc. .

4) i wish my fundamental rights and freedoms guaranteed secured by the Supreme Law of the Land be respected, protected, promoted, ensured and secured by You now¹¹, et seq.; i wish receipt of my property-claimed now¹², et seq.

Sincerely;

Darrell James: Hill

Darrell- James: Hill, man sovereign of the people-sovereigns of the non-political aggregate



10 "WHAT WE INVESTIGATE": www.fbi.gov/investigate/civil-rights/federal-civil-rights-statutes

11 Ibid, 3.

12 Ibid, 5.

823



APACHE JUNCTION
151 W SUPERSTITION BLVD
APACHE JUNCTION
AZ
85120-9998
0302590130
07/13/2017 (800)275-8777 4:02 PM

Product Description	Sale Qty	Final Price
First-Class Mail Letter (Domestic) (WASHINGTON, DC 20530) (Weight: 0 Lb 0.70 Oz) (Expected Delivery Day) (Monday 07/17/2017)	1	\$0.49
Registered (Amount: \$0.00) (@USPS Registered Mail #) (RE322399101US)	1	\$11.70
Return Receipt (@USPS Return Receipt #) (9590940220736132033853)	1	\$2.75
First-Class Mail Large Envelope (Domestic) (WASHINGTON, DC 20500) (Weight: 0 Lb 6.10 Oz) (Expected Delivery Day) (Monday 07/17/2017)	1	\$2.24
Registered (Amount: \$0.00) (@USPS Registered Mail #) (RE322399044US)	1	\$11.70
Return Receipt (@USPS Return Receipt #) (9590940220736132027005)	1	\$2.75
First-Class Mail Large Envelope (Domestic) (WASHINGTON, DC 20530) (Weight: 0 Lb 6.10 Oz) (Expected Delivery Day) (Monday 07/17/2017)	1	\$2.24
Registered (Amount: \$0.00) (@USPS Registered Mail #) (RE322399058US)	1	\$11.70
Return Receipt (@USPS Return Receipt #) (9590940220736132033846)	1	\$2.75
First-Class Mail Large Envelope (Domestic) (WASHINGTON, DC 20530) (Weight: 0 Lb 6.10 Oz) (Expected Delivery Day) (Monday 07/17/2017)	1	\$2.24
Registered (Amount: \$0.00) (@USPS Registered Mail #) (RE322399061US)	1	\$11.70

Registered No. RE3223991011

Reg. Fee	\$0.49	Return Receipt	
Handling Charge	\$11.70	Restricted Delivery	
Postage	\$2.75	Received by	00.00
	\$0.00		\$14.94
Customer Must Declare Full Value \$0.00		Received by 07/13/2017	

APACHE JUNCTION AZ JUL 13 2017

OFFICIAL USE

APACHE JUNCTION AZ 85120

FROM: Darrell James Hill
c/o 5124 East 18th Avenue
Apache Junction, Arizona 85119

TO: U.S. AG Services
1100 Pennsylvania Ave NW
Washington, District of Columbia 20530-0001

PS Form 3806, Receipt for Registered Mail
May 2007 (7530-02-000-9051) Copy 1 - Customer
For domestic delivery information, visit our website at www.usps.com

824

Registered No. RE322399044US

Postage \$	\$2.24	Extra Services & Fees (indicate)	
Extra Services & Fees	\$11.70	Signature Confirmation	
Registered Mail (hardcopy) \$	\$2.75	Signature Confirmation	
Return Receipt (hardcopy) \$	\$0.00	Restricted Delivery	
Return Receipt (electronic) \$	\$0.00	Total Postage & Fees	\$16.69
Restricted Delivery \$	\$0.00	Received by	07/13/2017
Customer Must Declare Full Value \$0.00		Received by RWS	

APACHE JUNCTION AZ 85120

FROM: Darrell James Hill
c/o 5124 East 18th Avenue
Apache Junction, Arizona 85119

TO: U.S. AG Services
1100 Pennsylvania Ave NW
Washington, District of Columbia 20530

PS Form 3806, Registered Mail Receipt
April 2015, PSN 7530-02-000-0051 Copy 1 - Customer
For domestic delivery information, visit our website at www.usps.com

mail
 Large Envelope
 (Domestic)
 (FLORENCE, AZ 85004)
 (Weight: 0 Lb 5.80 Oz)
 (Expected Delivery Day)
 (Saturday 07/15/2017)
 Certified 1 \$3.35
 (USPS Certified Mail #)
 (70150640000158832655)
 Return Receipt 1 \$2.75
 (USPS Return Receipt #)
 (9590940220736132026901)
 First-Class Mail 1 \$2.24
 Large Envelope
 (Domestic)
 (FLORENCE, AZ 85132)
 (Weight: 0 Lb 6.10 Oz)
 (Expected Delivery Day)
 (Saturday 07/15/2017)
 Registered 1 \$11.70
 (Amount: \$0.00)
 (USPS Registered Mail #)
 (RE322399092US)
 Return Receipt 1 \$2.75
 (USPS Return Receipt #)
 (9590940220736132026992)

Total \$123.00
 Cash \$123.00

In a hurry? Self-service kiosks offer quick and easy check-out. Any Retail Associate can show you how.
 Text your tracking number to 28777 (2USPS) to get the latest status. Standard Message and Data rates may apply. You may also visit USPS.com for tracking or call 1-800-222-1811.

 BRIGHTEN SOMEONE'S MAILBOX. Greeting cards available for purchase at select Post Offices.

Save this receipt as evidence of insurance. For information on filing an insurance claim go to <https://www.usps.com/help/claims.htm>.

Order stamps at www.usps.com/shop or call 1-800-Stamp24. Go to www.usps.com/clickship to print shipping labels with postage. For other information call 1-800-ASK-USPS.

 Get your mail when and where you want it with a secure Post Office Box. Sign up for a box online at [usps.com/poboxes](https://www.usps.com/poboxes).

All sales final on stamps and postage
 Refunds for guaranteed services only
 Thank you for your business

HELP US SERVE YOU BETTER

TELL US ABOUT YOUR RECENT POSTAL EXPERIENCE

Go to:
<https://postalexperience.com/Pos>

U.S. Postal Service
CERTIFIED MAIL RECEIPT
 Domestic Mail Only
 For delivery with mail, visit our website at www.usps.com
OFFICIAL USE
 Certified Mail Fee \$3.35
 Extra Services & Fees (check box, add fee as appropriate)
 Return Receipt (hardcopy) \$0.00
 Return Receipt (electronic) \$0.00
 Certified Mail Restricted Delivery \$0.00
 Adult Signature Required \$0.00
 Adult Signature Restricted Delivery \$0.00
 Postage \$2.03
 Total Postage and Fees \$8.13
 Sent To Elizabeth A. Brown, Acting USA
 Two Business Floors
 48 N. Central Avenue, Suite 1300
 Phoenix, Arizona 85004-0000
 Serial and Apt. No. or PO#
 City, State, ZIP+4®
 Date Stamp: 07/13/2017
 Registered No. RE322399092US

Registered No. RE322399092US
 Date Stamp 0130 02
 Postage \$ \$2.24
 Extra Services & Fees (check box)
 Signature Confirmation \$0.00
 Signature Confirmation Restricted Delivery \$0.00
 Return Receipt (hardcopy) \$0.00
 Return Receipt (electronic) \$0.00
 Restricted Delivery \$0.00
 Total Postage & Fees \$ \$16.69
 Customer Must Declare Full Value \$0.00
 Received by 07/13/2017
 Domestic insurance up to \$50,000 is included based upon the declared value. International liability is limited. (See Reverse).

OFFICIAL USE
 FROM
 Darrell James Hill
 c/o 5124 East 16th Avenue,
 Apache Junction, Arizona (85119)
 85120
 TO
 Mark James Hill
 571 Juan Lopez Cir, Building C
 Florence, Arizona 85132

PS Form 3806, Registered Mail Receipt
 April 2015, PSN 7530-02-000-0001
 Copy 1 - Customer
 (See Information on Reverse)
 For domestic delivery information, visit our website at www.usps.com



826

95909402207361320218007

First-Class 1 \$2.24
Mail

Large Envelope
(Domestic)
(WASHINGTON, DC 20530)
(Weight: 0 Lb 6.10 Oz)
(Expected Delivery Day)
(Monday 07/17/2017)

Registered 1 \$11.70
(Amount: \$0.00)
(USPS Registered Mail #)
(RE322399058US)

Return Receipt 1 \$2.75
(USPS Return Receipt #)
(9590940220736132033846)

First-Class 1 \$2.24
Mail

Large Envelope
(Domestic)
(WASHINGTON, DC 20530)
(Weight: 0 Lb 6.10 Oz)
(Expected Delivery Day)
(Monday 07/17/2017)

Registered 1 \$11.70
(Amount: \$0.00)
(USPS Registered Mail #)
(RE322399058US)

Return Receipt 1 \$2.75
(USPS Return Receipt #)
(9590940220736132026947)

First-Class 1 \$2.24
Mail

Large Envelope
(Domestic)
(WASHINGTON, DC 20535)
(Weight: 0 Lb 6.10 Oz)
(Expected Delivery Day)
(Monday 07/17/2017)

Registered 1 \$11.70
(Amount: \$0.00)
(USPS Registered Mail #)
(RE322399075US)

Return Receipt 1 \$2.75
(USPS Return Receipt #)
(9590940220736132026976)

First-Class 1 \$2.03
Mail

Registered No. **RE322399058US**

To Be Completed By Post Office	Postage \$ \$2.24	Extra Services & Fees (Amount)
	Extra Services & Fees Registered Mail \$ \$11.70	<input type="checkbox"/> Signature Confirmation
	<input type="checkbox"/> Return Receipt (hardcopy) \$ \$2.75	<input type="checkbox"/> Signature Confirmation Restricted Delivery
	<input type="checkbox"/> Return Receipt (electronic) \$ \$0.00	<input type="checkbox"/> Restricted Delivery
	<input type="checkbox"/> Restricted Delivery \$ \$8.69	Total Postage & Fees \$ \$16.69
Customer Must Declare Full Value \$ \$0.00	Received by 07/13/2017	Signature of Addressee (Required for Restricted Delivery)

APACHE JUNCTION, AZ 85120

OFFICIAL USE

FROM: Darrell James Hill, c/o 5124 East 16th Avenue, Apache Junction, Arizona [85119]

TO: JAG Services, 1425 New York Avenue, N.W., Suite 1110, Washington, District of Columbia 20004-0001

PS Form 3800, Registered Mail Receipt
April 2015, PSN 7530-02-000-0051
For domestic delivery information, visit our website at www.usps.com

Copy 1 - Customer
(See Information on Reverse)

Registered No. **RE322399061US**

To Be Completed By Post Office	Postage \$ \$2.24	Extra Services & Fees (Amount)
	Extra Services & Fees Registered Mail \$ \$11.70	<input type="checkbox"/> Signature Confirmation
	<input type="checkbox"/> Return Receipt (hardcopy) \$ \$2.75	<input type="checkbox"/> Signature Confirmation Restricted Delivery
	<input type="checkbox"/> Return Receipt (electronic) \$ \$0.00	<input type="checkbox"/> Restricted Delivery
	<input type="checkbox"/> Restricted Delivery \$ \$8.69	Total Postage & Fees \$ \$16.69
Customer Must Declare Full Value \$ \$0.00	Received by 07/13/2017	Signature of Addressee (Required for Restricted Delivery)

APACHE JUNCTION, AZ 85120

OFFICIAL USE

FROM: Darrell James Hill, c/o 5124 East 16th Avenue, Apache Junction, Arizona [85119]

TO: Office of Information Policy, 1425 New York Avenue, N.W., Suite 1110, Washington, District of Columbia 20004-0001

PS Form 3800, Registered Mail Receipt
April 2015, PSN 7530-02-000-0051
For domestic delivery information, visit our website at www.usps.com

Copy 1 - Customer
(See Information on Reverse)

827

Darrell- James: Hill c/o 5124 East 18th Avenue, Apache Junction, Arizona [85119]

USPS RMN RE 322 399 101 US

Jeff: U.S. AG Sessions
950 Pennsylvania Avenue, NW
Washington, District of Columbia 20530-0001

RE: Demand for You to dispose property-claimed and essence to me at the address above in re:
NOTICE: CLAIM: USPS RMN RE 322 399 251 US; sent March 21, 2017; rec'd March 31, 2017,
0524 a.m.

Jeff, greetings:

Sufficient time has lapsed for you, et al., to have answered my claim.

With regards to the matter of my right to property claimed referenced above, you have Not responded to me concerning my valid claim to property disposed to the United States of America, "property-claimed", to me, made in exercise of my fundamental rights and freedoms guaranteed under the Supreme Law of the Land.

Sixteen weeks have elapsed without your any response.

Non-response is a settlement of my claim matter of rights-exercised. Acquiescence, whether by a) dereliction of your duty and obligation or b) feelings about my rights, nonetheless, closed the matter henceforth, estoppel by silence. Thereto, this correspondence is to command disposition of my property-claimed; to wit:

Dispose without delay my property-claimed to me at the mailing address in the header above. Mail all related correspondence to the address above until further notice.

Upon delivery of this correspondence, failure to dispose my property-claimed to me is against my wish and causes me harm. For same, thereby, you, et al. group, singularly, tacitly acquiesce and promise to I) without delay pay upon my any request the amount of one ounce silver dollar per minute unit of time, cumulative of any units of time lapsed, until the receipt of my property-claimed matter is resolved, notwithstanding; and, II) to without delay pay all amounts of fees and services and costs associated with the collection of any amounts outstanding, due payable without delay upon accrual.

Sincerely;

Darrell-James: Hill

Darrell- James: Hill, man sovereign of the people-
sovereigns of the non-political aggregate

07-13-2017



Second correspondence to Jeff, USAG Session re

2022-011769 MISC Page: 827 of 2782
09/26/2022 03:35:37 PM Receipt #: 22-9381
Rec Fee: \$30.00 Darrell James Hill
Gila County, Az, Sadie Jo Bingham, Recorder



APACHE JUNCTION
 151 W SUPERSTITION BLVD
 APACHE JUNCTION
 AZ
 85120-9998
 0302590130
 07/13/2017 (800)275-8777 4:02 PM

Product Description	Sale Qty	Final Price
First-Class Mail Letter (Domestic) (WASHINGTON, DC 20530) (Weight: 0 Lb 0.70 Oz) (Expected Delivery Day) (Monday 07/17/2017)	1	\$0.49
Registered (Amount: \$0.00) (@USPS Registered Mail #) (RE322399101US)	1	\$11.70
Return Receipt (@USPS Return Receipt #) (9590940220736132033853)	1	\$2.75
First-Class Mail Large Envelope (Domestic) (WASHINGTON, DC 20500) (Weight: 0 Lb 6.10 Oz) (Expected Delivery Day) (Monday 07/17/2017)	1	\$2.24

Registered (Amount: \$0.00) (@USPS Registered Mail #) (RE322399044US)	1	\$11.70
Return Receipt (@USPS Return Receipt #) (9590940220736132027005)	1	\$2.75
First-Class Mail Large Envelope (Domestic) (WASHINGTON, DC 20530) (Weight: 0 Lb 6.10 Oz) (Expected Delivery Day) (Monday 07/17/2017)	1	\$2.24

Registered (Amount: \$0.00) (@USPS Registered Mail #) (RE322399058US)	1	\$11.70
Return Receipt (@USPS Return Receipt #) (9590940220736132033846)	1	\$2.75
First-Class Mail Large Envelope (Domestic) (WASHINGTON, DC 20530) (Weight: 0 Lb 6.10 Oz) (Expected Delivery Day) (Monday 07/17/2017)	1	\$2.24

829

Registered No. RE322399101U

Reg. Fee	\$0.49	Return Receipt	\$11.70
Handling Charge	\$2.75	Restricted Delivery	\$0.00
Postage	\$0.00	Received by	00.00
Customer Must Declare Full Value \$0.00		07/13/2017	

APACHE JUNCTION, AZ
 JUL 13 2017

OFFICIAL USE

FROM: Darrell James Hill
 c/o 5124 East 18th Avenue
 Apache Junction, Arizona 85119

TO: U.S. AG Sentin
 1000 Pennsylvania Ave N.W.
 Washington, District of Columbia 20530-0001

PS Form 3806, Receipt for Registered Mail Copy 1 - Customer
 May 2007 (7530-02-000-9051) (See Information on Reverse)
 For domestic delivery information, visit our website at www.usps.com

Registered No. RE322399044US

Postage \$	\$2.24	Extra Services & Fees	\$11.70
Extra Services & Fees	\$11.70	Signature Confirmation	\$0.00
Return Receipt (hardcopy) \$	\$2.75	Signature Confirmation	\$0.00
Return Receipt (electronic) \$	\$0.00	Restricted Delivery	\$0.00
Restricted Delivery \$	\$0.00	Total Postage & Fees	\$16.69
Customer Must Declare Full Value \$0.00		Received by	07/13/2017

APACHE JUNCTION, AZ
 JUL 13 2017

OFFICIAL USE

FROM: Darrell James Hill
 c/o 5124 East 18th Avenue
 Apache Junction, Arizona 85119

TO: Office of the P
 1000 Pennsylvania Ave N.W.
 Washington, District of Columbia 20530

PS Form 3806, Registered Mail Receipt Copy 1 - Customer
 April 2015, PSN 7530-02-000-0051 (See Information on Reverse)
 For domestic delivery information, visit our website at www.usps.com

Darrell-James: Hill c/o P.O. Box 3806/ Apache Junction, Arizona 85120-3806

USPS CMN 7015 0640 0001 5883.2662

Jeff, AG Sessions
c/o Kenneth A, Acting Assistant AG Blanco
US DOJ Criminal Division
950 Pennsylvania Avenue, NW
Washington, District of Columbia 20530-0001

NOTICE: ATTENTION TO CONSTITUTIONAL PROTECTED RIGHTS DEPRIVATION

RE: Darrell-James: Hill; "Affidavit: Proof of Claim" - See Affidavit: Gila county Recorder: gilacountyaz.gov/recorder/web/ : Doc. # 2017-006522 - received by you mid-July 2017 by USPS RMN RE 322 399 058 US.

Jeff, Kenneth A., Greetings:

i sent you Jurat in the "Affidavit: Proof of Claim" for the expedient protection of my Constitutionally protected rights-asserted.

My declaration specified deprivations of my rights-asserted imposed by the varied persons.

It has been nearly a month with No response from you, et al., to resolve these violations originating in your department. i believe it is necessary to make this notice to bring your attention to my desire that you promote, ensure, protect and support my rights against all violators/ state party agents, national government agents notwithstanding.

i desire you to expediently resolve these matters in my favor.

Please respond to the mailing address in the header.

Sincerely,

Darrell-James: Hill

Darrell-James: Hill
Living Soul, one of the
common people of the
United States of America

L.S.

830
2022-011769 MISC Page: 829 of 2782
09/26/2022 03:35:37 PM Receipt #: 22-9381
Rec Fee: \$30.00 Darrell James Hill
Gila County, Az, Sadie Jo Bingham, Recorder



APACHE JUNCTION
151 W SUPERSTITION BLVD
APACHE JUNCTION
AZ

85120-9998
0302590130

08/08/2017 (800)275-8777 10:46 AM

Product Description	Sale Qty	Final Price
First-Class Mail Letter	1	\$0.49

(Domestic)
(WASHINGTON, DC 20530)
Weight: 0 Lb 0.50 Oz
Nexted Delivery Day
Monday 08/11/2017

Certified 1 \$3.35
(USPS Certified Mail #)
(7015064000015832662)

Return receipt 1 \$2.75
(USPS Return Receipt #)
(9590940220736132037462)

U.S. Postal Service
CERTIFIED MAIL® RECEIPT
Domestic Mail Only

For delivery information, visit our website at www.usps.com

WASHINGTON, DC 20530

OFFICIAL USE

Certified Mail Fee \$3.35
Postage \$0.49
Total Postage and Fees \$3.84

Extra Services & Fees (check box, add fee as appropriate)
 Return Receipt (hardcopy) \$0.00
 Return Receipt (electronic) \$0.00
 Certified Mail Restricted Delivery \$0.00
 Adult Signature Required \$0.00
 Adult Signature Restricted Delivery \$0.00

Postmark Here
08/08/2017

Sent To: JAIL, AG Division
c/o Kenneth A. Acting Assistant AG Director
9590940220736132037462
Washington, District of Columbia 20530-0001

PS Form 3800, April 2015 PSN 7530-02-000-9047-2 (2) See Reverse for Instructions

2992 6985 1000 040 5702

Total

Cash Change

Text your tracking (2USPS) to get the Standard Message and apply. You may also use USPS Tracking or call

In a hurry? Self-service quick and easy check Associate can show

SENDER COMPLETE THIS SECTION

Complete items 1, 2, and 3.
Print your name and address on the reverse so that we can return the card to you.
Attach this card to the back of the mailpiece, or on the front if space permits.

1. Article Address
JAIL, AG Division
c/o Kenneth A. Acting Assistant AG Director
9590940220736132037462
Washington, District of Columbia 20530-0001

2. Article Number (transfer from each mailpiece)
7015 0640 0001 5832

PS Form 3811, July 2013 PSN 7530-02-000-9047-2

COMPLETE THIS SECTION ON DELIVERY

A. Signature
 Agent
 Addressee

B. Received by (Printed Name)
C. Date of Delivery

D. Is every address different from item 1?
 Yes
 No
If Yes, enter delivery address below:

E. Delivery Type
 Adult Signature
 Adult Signature Restricted Delivery
 Certified Mail
 Certified Mail Restricted Delivery
 Collection Delivery
 Collection Delivery Restricted Delivery
 Certified Mail Restricted Delivery
 Registered Mail
 Registered Mail Restricted Delivery
 Registered Mail Restricted Delivery

F. Priority Mail Express
 Registered Mail™
 Registered Mail Restricted Delivery
 Return Receipt for Merchandise
 Signature Confirmation™
 Signature Confirmation Restricted Delivery

Domestic Return Receipt

BRIGHTEN SOMEONE'S cards available for Post Offices.

831

Darrell-James: Hill, aggrieved man, c/o P.O. Box 3806/ Apache Junction, Arizona 85120 602.618.4595
USPS RMN RE 322 399 132 US

Donald: POTUS Trump
Paul: Gen. Selva, USAF, JCOS, Vice Chairman
Mark: Gen. Milley, US Army, Chief of Staff of the Army
Robert: Gen. Neller, USMC, Commandant of the Marine Corps
John: Adm. Richardson, US Navy, Chief of Naval Operations
David: Gen. Goldfein, USAF, Chief of Staff of the Air Force
Joseph: Gen. Lengyel, USAF, Chief of the National Guard Bureau
c/o Joseph: Gen. Dunford, USMC, JCOS
Chairman of the JCOS
9999 Joint Staff Pentagon
Washington, District of Columbia 20318-9999

NOTICE AND DEMAND

NOTICE	i am a man of the non-political aggregate ¹ ; a) proclaimed forever free, protected by the Constitution for the United States of America-1787 by the Executive Branch and by the military and naval authority ² ; b) i am Not subject to the General Orders No. 100: The Lieber Code ³ ; c) embrace and exercise rights guaranteed protected by the Constitution for the United States of America/ U.S. Constitution that have been ignored by the U.S. Government Judicial Branch dereliction of oath, duty and obligation, and Executive Branch infidelity to oath, duty and obligation.
DEMAND	i wish a favorable end to this controversy. Fidelity in honor of oath, duty and obligation in respect of my status and Almighty-God-Given supreme rights guaranteed by the Constitution for the United States of America, and proclaimed in the Emancipation Proclamation forever proactively protected by the Executive Branch, and the military and naval authority.

Donald, Joseph, Paul, Mark Robert, John, David, Greetings:

i am a man of the non-political aggregate, an inhabitant in Arizona state, write you all because 1) you are man, persons in chief executive branch offices and military historically and distinctly positioned for protection of the free people like me, over-standing the Constitution for the United States of America- 1787. Note as well, in accordance with the Emancipation Proclamation, i am particularly not subject to the 1863 Lieber Code- martial law, et seq.

NOTICE: From my first contacts with you(r) offices – See AFFIDAVIT: PROOF OF CLAIMS; Gila county Recorder: gilacountyaz.gov/recorder/web/ : Doc. # 2017-002378 : pp. 149, 154, 158, 171, in its entirety, incorporated by reference –, I have maintained man-ship of the non-political aggregate. Because the

- 1 Non-political aggregate: AFFIDAVIT: PROOF OF CLAIM: Gila county Recorder: gilacountyaz.gov/recorder/web/ : Doc. # 2017-006522, in its entirety incorporated by reference.
- 2 Emancipation Proclamation: 1863; paragraph 2: "That on the first day of January, in the year of our Lord one thousand eight hundred and sixty-three, all persons held as slaves within any State or designated part of a State, the people whereof shall then be in rebellion against the United States, shall be then, thenceforward, and forever free; and the Executive Government of the United States, including the military and naval authority thereof, will recognize and maintain the freedom of such persons, and will do no act or acts to repress such persons, or any of them, in any efforts they may make for their actual freedom.
- 3 General Orders No. 100: The Lieber Code: 1863; "Art. 2. Martial Law does not cease during the hostile occupation, except by special proclamation, ordered by the commander in chief; or by special mention in the treaty of peace concluding the war, when the occupation of a place or territory continues beyond the conclusion of peace as one of the conditions of the same."

NOTICE AND DEMAND JCOS - POTUS, AUG 232017 U

832

2022-011769 MISC Page: 831 of 2782

09/26/2022 03:35:37 PM Receipt #: 22-9381
Rec Fee: \$30.00 Darrell James Hill
Gila County, Az; Sadie Jo Bingham, Recorder

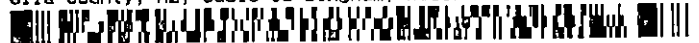

Darrell-James: Hill, aggrieved man, c/o P.O. Box 3806/ Apache Junction, Arizona 85120 602.618.4595
USPS RMN RE 322 399 132 US

core of my demand is for coveted property by others – See AFFIDAVIT: PROOF OF CLAIMS; Gila county Recorder: gilacountyaz.gov/recorder/web/ : Doc. # 2017-002378, pp. 240-549, U.S. Government-state agents have sought by the “ends to justify the means” vindication to deprive my Almighty-God-given rights in order to steal that which they coveted, my property.

DEMAND: i now must request your action for to maintain my protection against the deprivation of my rights-guaranteed-protected under the Law of the land, the Constitution for the United States of America/ U.S. Constitution, et seq., and proclaimed within the Emancipation Proclamation. Thereto, i must assure you receive this NOTICE AND DEMAND, and information regarding the context of my continued contact with the Executive Branch, et al.: agencies, employees, actors, agents, assigns or asset, in demand of my guaranteed protections – **ENCLOSURE ONE**. Please also see the information of continued contact with the Judicial Branch persons directly responsible for the wrong-doers, the Ninth Circuit Executive Committee – **ENCLOSURE TWO**.

ENCLOSURE ONE i have enclosed my NOTICE AND DEMAND Cover Sheet correspondences to a) Donald- POTUS TRUMP – USPS CMN 7015 0640 0001 5883 2686 - respondeat superior for the U.S. government criminal subordinate state actors; b) Jeff, US DOJ Attorney General SESSIONS – USPS CMN 7015 0640 0001 5883 2716; and, c) Elizabeth, Ariz. U.S. Attorney STRANGE – USPS CMN 7015 0640 0001 5883 2709. See Enclosure One, 3 pages. These documents persist my request begun from/in September 2016 that the Judicial Branch, et al., and Executive Branch, et al., actors immediately recognize and maintain my freedoms, to protect and support my asserted- and guaranteed- rights.

ENCLOSURE TWO i have enclosed my document correspondence to date to the Ninth Circuit Executive Committee – 11 pages.

Sincerely;

Darrell-James: Hill
Living Soul, one of the common people of the
united States of America L.S.

833
NOTICE AND DEMAND JCOS - POTUS, AUG 232017 US

2022-011769 MISC Page: 832 of 2782
09/26/2022 03:35:37 PM Receipt #: 22-9381
Rec Fee: \$30.00 Darrell James Hill
Gila County, Az, Sadie Jo Bingham, Recorder



Darrell-James: Hill, aggrieved man, c/o P.O. Box 3806/ Apache Junction, Arizona 85120 602.618.4595
USPS RMN RE 322 399 132 US

Unofficial Copy

Unofficial Copy

834

ENCLOSURE ONE:

NOTICE AND DEMAND Cover Sheets to:

a) Donald- POTUS TRUMP –
USPS CMN 7015 0640 0001 5883 2686

b) Jeff, US DOJ Attorney General SESSIONS –
USPS CMN 7015 0640 0001 5883 2716

c) Elizabeth, Ariz. U.S. Attorney STRANGE –
USPS CMN 7015 0640 0001 5883 2709

3 pages

NOTICE AND DEMAND JCOS - POTUS, AUG 232017 USPS

2022-011769 MISC Page: 833 of 2782
09/26/2022 03:35:37 PM Receipt #: 22-9381
Rec Fee: \$30.00 Darrell James Hill
Gila County, Az, Sadie Jo Bingham, Recorder



Darrell-James Hill c/o P.O. Box 3806/ Apache Junction, Arizona 85120

USPS CMN 7015 0640 0001 5983 2686

Donald: POTUS TRUMP
The White House
1600 Pennsylvania Avenue NW
Washington, District of Columbia 20500

NOTICE AND DEMAND

RE: "Affidavit: Proof of Claim" - See Affidavit: Gila county Recorder:
gilacountyz.gov/recorder/web/ : Doc. # 2017-006522 - received by you July 24th, 2017 by
USPS RMN RE 322 399 044 US - See ENCLOSURE ONE, 30 pages

- NOTICE
- a) You Swore To Protect My Almighty-God-Given Rights By/Under The Ultimate Authority Of The Constitution For The United States Of America; The Same Authority
 - b) Proclaimed By President Lincoln In The "Emancipation Proclamation" Of 1863: I Am
 - 1) Protected By The Constitution For The United States Of America - 1787,
 - 2) Not Subject To Martial Law/Lieber Code - 1863,
 - 3) Forever Free From Slavery; The Same Freedom, Forever
 - 4) Secured By The Executive Government, Including The Military And Naval Authorities

DEMAND I Call Upon You To Immediately Protect And Support All Of My Rights

Donald, Greetings:

I sent you, Respondent Superior, et al., my "Affidavit: Proof of Claim" - See ENCLOSURE ONE - declaring the criminal actions of your subordinates' deprivation of my Constitutionally-protected rights.

NOTICE: The systemic deprivations of my rights imposed by your criminal subordinates are now tantamount to your aiding criminal wrongdoings against me under all American law systems.

DEMAND: Righteously serve; finally correct the unlawful Constitutional matters. Do Not Presume that I am subject to martial law rule. I am Not. As indicated in the Emancipation Proclamation by Presidential predecessor, Abraham, POTUS Lincoln, my rights are directly and unambiguously protected under the Constitution for the United States of America, and are Not subject to corporate presumptions, for ever.

I wish/ history wants for you to righteously promote, protect, ensure and establish my rights. There Is No Way to Justify Unrighteous Half Measures of Depriving Me of My Property and Rights. The Same Corruption In The Beginning Of This Nation To Enslave The Few And Humbled Resulted In All Now Being Legally Sustained Under A System Of Martial Law Rule And/Or Slavery Since 1863: All Except The Southern Slaves Who Were Proclaimed Legally Freed From All Bondage Forever.

See my mailing address change in the header.

Sincerely;

Darrell-James Hill
Living Soul, one of the common people of the
United States of America L.S.

Notice to Donald, POTUS, AUG 21 2017 USPS CMN 7015 0640 0001 5983 2686

1/2

2022-011769 MISC Page: 834 of 2782
09/26/2022 03:35:37 PM Receipt #: 22-9381
Rec Fee: \$30.00 Darrell James Hill
Gila County, Az, Sadie Jo Bingham, Recorder

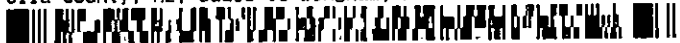

Darrell James Hill c/o P.O. Box 3806/ Apache Junction, Arizona 85120
USPS CMN 7015 0640 0001 5883 2716

Jeff US Attorney General SESSIONS
U.S. DOJ
950 Pennsylvania Avenue, NW
Washington, District of Columbia 20530-0001

NOTICE AND DEMAND

RE: "Affidavit: Proof of Claim" - See Affidavit: Gila county Recorder:
gilacountyaz.gov/recorder/web/ : Doc. # 2017-006522 - received by you on or about July 26,
2017 by USPS RMN RE 322 399 058 US - See ENCLOSURE ONE, 30 pages.

- NOTICE a) You Swore To Protect My Almighty-God-Given Rights By/Under The Ultimate Authority
Of The Constitution For The United States Of America; The Same Authority
- b) Proclaimed By President Lincoln In The "Emancipation Proclamation" Of 1863: I Am
- i) Protected By The Constitution For The United States Of America -- 1787,
- ii) Not Subject To Martial Law/Lieber Code - 1863,
- iii) Forever Free From Slavery; The Same Freedom, Forever
- iv) Secured By The Executive Government, Including The Military And Naval Authorities

DEMAND I Call Upon You To Immediately Protect And Support All Of My Rights

Jeff, Greetings:

i sent your Respondent Superior, et al, my "Affidavit: Proof of Claim" - See ENCLOSURE ONE -
declaring the criminal actions of state agents' deprivation of my Constitutionally-protected rights.

NOTICE: The systemic deprivations of my rights imposed by criminal subordinates are now
transparent to your aiding criminal wrongdoings against me under all American law systems.

DEMAND: Righteously serve; finally correct the unlawful Constitutional matters. Do Not Presume
that i am subject to martial law rule. i am Not. As indicated in the Emancipation Proclamation by Presidential
predecessor Abraham POTUS Lincoln, my rights are directly and unambiguously protected under the
Constitution for the United States of America, and are Not subject to corporate presumptions, for ever.

I wish/ history warns for you to righteously promote, protect, ensure and establish my rights. There Is No
Way to Justify Unrighteous Half Measures of Depriving Me of My Property and Rights. The Same Corruption In
The Beginning Of This Nation To Enslave The Few And Humbled Resulted In All Now Being Legally Sustained
Under A System Of Martial Law Rule And/Or Slavery Since 1863: All Except The Southern Slaves Who Were
Proclaimed Legally Freed From All Bondage Forever.

See my mailing address change in the header.

Sincerely;

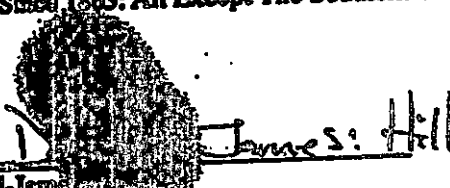
Darrell James Hill
Living Soul, one of the common people of the
united States of America L.S.

Notice to Jeff, DOJ ATTY GEN, AUG 21 2017 USPS CMN 7015 0640 0001 5883 2716

1/2

2022-011769 MISC Page: 835 of 2782
09/26/2022 03:35:37 PM Receipt #: 22-9381
Rec Fee: \$30.00 Darrell James Hill
Gila County, Az, Sadie Jo Bingham, Reorder



Darrell-James: Hill c/o P.O. Box 3806/ Apache Junction, Arizona 85120

USPS CMN 7015 0640 0001 5883 2709

Elizabeth: Acting U.S. Atty Strange
Two Renaissance Square
40 North Central Ave, Ste 1200
Phoenix, Arizona 85004-4408

NOTICE AND DEMAND

RE: "Affidavit: Proof of Claim" - See Affidavit: Gila county Recorder:
gilacountyaz.gov/recorder/web/ : Doc. # 2017-006522 - received by you on or about July 18th,
2017 by USPS CMN 7015 0640 0001 5883 2635 -- See ENCLOSURE ONE, 30 pages

- NOTICE
- a) You Swore To Protect My Almighty-God-Given Rights By/Under The Ultimate Authority Of The Constitution For The United States Of America; The Same Authority
 - b) Proclaimed By President Lincoln In The "Emancipation Proclamation" Of 1863: I Am
 - i) Protected By The Constitution For The United States Of America - 1787,
 - ii) Not Subject To Martial Law/Liber Code - 1863,
 - iii) Forever Free From Slavery; The Same Freedom, Forever
 - iv) Secured By The Executive Government, Including The Military And Naval Authorities

DEMAND I Call Upon You To Immediately Protect And Support All Of My Rights

Elizabeth, Greetings:

I sent your Respondent Superior, et al., my "Affidavit: Proof of Claim" - See ENCLOSURE ONE--
declaring the criminal actions of state agents' deprivation of my Constitutionally-protected rights.

NOTICE: The systemic deprivations of my rights imposed by criminal subordinates are now
tantamount to your aiding criminal wrongdoings against me under all American law systems.

DEMAND: Righteously serve; finally correct the unlawful Constitutional matters. Do Not Presume
that I am subject to martial law rule. I am Not. As indicated in the Emancipation Proclamation by Presidential
prodecessor Abraham, POTUS Lincoln, my rights are directly and unambiguously protected under the
Constitution for the United States of America, and are Not subject to corporate presumptions, for ever.

I wish/ history warns for you to righteously promote, protect, ensure and establish my rights. There is No
Way to Justify Unrighteous Half Measures of Depriving Me of My Property and Rights. The Same Corruption In
The Beginning Of This Nation To Enslave The Few And Humbled Resulted In All Now Being Legally Sustained
Under A System Of Martial Law Rule And/Or Slavery Since 1863: All Except The Southern Slaves Who Were
Proclaimed Legally Freed From All Bondage Forever.

See my mailing address change in the header.

Sincerely;

Darrell-James Hill

Living Soul, one of the common people of the
United States of America L.S.

Notice to Elizabeth, US ATTY GEN AZ, AUG 21 2017 USPS CMN 7015 0640 0001 5883 2709

1/2

2022-011769 MISC Page: 836 of 2782
09/28/2022 03:35:37 PM Receipt #: 22-9381
Rec Fee: \$30.00 Darrell James Hill
Gila County, Az, Sadie Jo Bingham, Recorder



Darrell-James: Hill, aggrieved man, c/o P.O. Box 3806/ Apache Junction, Arizona 85120 602.618.4595
USPS RMN RE 322 399 132 US

Unofficial Copy

ENCLOSURE TWO:
NOTICE AND DEMAND Cover Sheet to:
Ninth Circuit Executive Committee
USPS CMN 7015 0640 0001 5883 2679
including RMN RE 322 399 234 US

Unofficial Copy

838

NOTICE AND DEMAND JCOS - POTUS, AUG 232017 USP

2022-011769 MISC Page: 837 of 2782

09/26/2022 03:35:37 PM Receipt #: 22-9381
Rec Fee: \$30.00 Darrell James Hill
Gila County, Az, Sadie Jo Bingham, Recorder



Darrell- James: Hill, aggrieved man, c/o PO Box 3806, Apache Junction, Arizona 85120
USPS CMN 7015 0640 0001 5883 2679

Sidney; acting as Chief Judge, Chairman;
Richard; acting as Circuit Judge;
Susan; acting as Senior District Judge;
Judicial Council Executive Committee
c/o Office of Executive Committee
P.O. Box 193939
San Francisco, California [94119-3939]

**SECOND NOTICE WITH DEMAND:
TO 9th CIRCUIT EXECUTIVE COMMITTEE
REPORTING CRIMINAL SUBORDINATES' DEPRIVATION
OF THE AGGRIEVED'S RIGHTS UNDER COLOR OF LAW**

Sidney, Richard, Susan: Greetings;

i: man¹ am Darrell- James: Hill who reported to you by USPS Registered Mail with RR, RMN RE 322 399 234 US, delivered to you on May 1st, 2017, criminal wrongdoings and the wrong-doers under your supervision and authority. - See Enclosure One: "Jurat Affidavit- Notice: 9th Circuit Trespass Upon Fundamental and Substantive Rights, and Common-Law-Claim Rights Under Color-of-Law, 6 pages.

i have not received response from you on this critical matter re: unLawful and illegal activities reported to you: Nor has effect of protection/ support of my rights been advanced to me by your subordinates to revert their deprivation of my rights protected by the Constitution for the United States of America, which is your duty and oath of obligation to me. Regarding same, see "AFFIDAVIT: PROOF OF CLAIM: ...": Gila County Recorder, gilacountyaz.gov, DOC. 2017-006522; July 7th, 2017. See excerpt:

AFFIDAVIT: PROOF OF CLAIM:

A.R.S. 11-480(D): Gila County Recorder – Doc. Num: 2017-002378

Darrell- James: House of Hill, aggrieved party
c/o 5124 East 18th Avenue
Apache Junction, Arizona
Zip Code Exempt, Non-Domestic

Declaration³ In Claim⁴ Against⁵ Criminal⁶ Wrong-Doings⁷

- 1 i: man means: a) a flesh and blood man-kind understanding Almighty God of Abraham of the Holy Bible, and a sovereign one who in a collective capacity with others sovereigns are the people of the United States of America over-standing the government for the United States of America; b) NOT a cestui que trust, corporation, or other fictitious entity; c) NOT a US citizen; d) Not an inhabitant of a federal area See at Gila County Recorder – site: <http://recorder.gilacountyaz.gov/recorder/web/> Document Number: 2017-002378, pg 199-217 Affidavit
- 2 Affidavit means: "No more than [affidavits are] necessary to make the Prima facie case." U.S. v. Kis, 658 F. 2nd 526.
- 3 declaration means: The first of the pleadings on the part of the plaintiff in an action at law, being a formal and methodical specification of the facts and circumstances constituting his cause of action.
- 4 claim means: a challenge of property or ownership of a thing which is wrongfully withheld from the possession of the claimant. Plowd. 359. A claim is a right or title, actual or supposed, to a debt privilege or other thing in the possession of another.... 2 N. Y. 245, 254[;] Bouvier's Law Dictionary, 1st Ed, p. 209.
- 5 Against means: in opposition to, adverse, hostile; in an opposite direction or position
- 6 criminal means: pertaining to crime: an act committed in violation of a law prohibiting it, or [an omission] in violation of a law ordering

USPS CMN: 7015 0640 0001 5883 2679 -- 2ND Notice with Demand - Free Copy - Sidney, Richard, Susan 1/5

2022-011769 MISC Page: 838 of 2782
09/26/2022 03:35:37 PM Receipt #: 22-9381
Rec Fee: \$30.00 Darrell James Hill
Gila County, Az, Sadie Jo Bingham, Recorder



By State Party⁹ Agents⁹
Of The United States¹- Department Of Justice¹⁰, "DOJ", And
Of The 9th Circuit Court Administration¹¹:

Of Deprivation¹² Of My Inalienable¹³ Fundamental¹⁴ And Natural Rights^{15 16}
and Freedoms guaranteed¹⁷ Protected¹⁸: By (a) The Constitution¹⁹ For The United
States²⁰ Of America²¹ People²², 1787, "Const.-1787", (b) The Bill Of Rights²³, 1789- 1791,
"BORights-1789-91", and (c) The "International Covenant²⁴ On Civil²⁵ And Political²⁶
Rights²⁷", "ICCPR", Treaty Ratified By The Senate In 1992²⁸, "ICCPR Treaty";

- it... 2. extreme violation of the law, wrongdoing of a criminal nature, as felony or treason, which affects the whole public and not just the rights of an individual: distinguished from misdemeanor. Webster's New 20th Century Unabridged, 2nd Ed., p. 431.
- 7 wrong-doing: that which is improper or unjust actions
 - 8 State Party means: all The Federal, State And Local Government Entities
 - 9 State Party Agents means: all The Federal, State And Local Government's agents or doers otherwise who perform for the State Party directly, or through proxy
 - 10 National Executive Branch- Department Of Justice, "DOJ" means: Loretta Lynch, et al., et seq. Jeffrey S.: All State Party Agents of the DOJ System having knowledge and/or participation, aiding or abetting
 - 11 9th Circuit Court Administration means: All State Party Agents of the 9th Circuit Court System having knowledge and/or participation, aiding or abetting
 - 12 deprivation means: to entirely take away
 - 13 inalienable means: that which cannot be transferred or surrendered, such as an inalienable right: means: A right that cannot be transferred or surrendered, a natural right such as the right to own property. Not subject to statutory manipulation.
 - 14 fundamental means: "One's right to life, liberty, and property, to free speech, a free press, freedom of worship and assembly, and other fundamental rights may not be submitted to vote; they depend on the outcome of no elections[.]" West Virginia Bd. of Ed. v. Barnette, 319 U.S. 624, 638, 63 S.Ct. 1178, 87 L.Ed. 1628 (1943).
- fundamental law means: The law which determines the constitution of government in a state, and prescribes and regulates the manner of its exercise; the organic law of a state; the constitution.
- 15 natural rights means: those rights that is conceived as part of natural law and that is therefore thought to exist independently of rights created by government or society, such as the right to life, liberty, and property, which grow out of the nature of man and depend upon personality, as distinguished from such as are created by law and depend upon civilized society; or they are those which are plainly assured by natural law (Borden v. State, 11 Ark. 519, 44 Am.Dec. 217); ...[.] Black's Law Dictionary, 4th Ed., p1487. natural law means: A physical law of nature, ie. gravity, property.
 - 16 rights means: what someone deserves; a just claim, what is morally due; the property of life, liberty and property sacred to one and wholly set aside for private use.
 - 17 guaranteed means: held in surety for that the obligation due under covenant must be performed
 - 18 protect means: to, in advance to defend and guard
 - 19 Constitution means: the Constitution for the United States of America, 1787, "Const.-1787", generally also making inclusive reference to the BORights-1789-91.
 - 20 United States means: one must be cognizant and clear about the usage of the term which means: [1] It may be merely the name of a sovereign occupying the position analogous to that of other sovereigns in the family of nations. [2] It may designate the territory over which the sovereignty of the United States extends, or [3] it may be the collective name of the states which are united by and under the constitution. [.] in the nature of Hooven & Allison Co. vs. Evatt, 324 U.S. 652
 - 21 United States of America means: the people of the united States of America
 - 22 people means: the word "people" may have various significations according to the connection in which it is used. When we speak of the rights of the people, or of the government of the people by law, or of the people as a non-political aggregate, we mean all the inhabitants of the state or nation, without distinction as to sex, age, or otherwise. But when reference is made to the people as the repository of sovereignty, or as the source of governmental power, or to popular government, we are in fact speaking of that selected and limited class of citizens to whom the constitution accords the elective franchise and the rights of participation in the offices of government. Black. Const. Law 3d Ed., p. 30[.] Black's Law Dictionary, 4th Ed., p1292. repository means: a person to whom something is entrusted or confided; ...[.] Webster's New 20th Century Unabridged, 2nd Ed., p. 1535.
 - 23 BORights means: "... THE Conventions of a number of the States, having at the time of their adopting the Constitution, expressed a desire, in order to prevent misconstruction or abuse of its powers, that further declaratory and restrictive clauses should be added; And as extending the ground of public confidence in the Government, will best ensure the beneficent ends of its institution; RESOLVED by the Senate and House or Representatives of the United States of America, in congress assembled,... Articles, which when ratified*...., to be valid to all intents and purposes, as part of the said Constitution; *The first ten Amendments (BORights) were ratified effective December 15, 1791.

USPS CMN: 7015 0640 0001 5883 2679 - 2ND Notice

2022-011769 MISC Page: 839 of 2782

09/26/2022 03:35:37 PM Receipt #: 22-9381

Rec Fee: \$30.00 Darrell James Hill

Gila County, Az, Sadie Jo Bingham, Recorder



840

Of Deprivations imposed²² Against Me²³ By Men, United States Government Agents, Wrong-Doers Against "Public Policy"²⁰

For The Exercise³¹ Of My Rights To Secure "Property-Claimed"³³ And To A Common Law^{33 34} With Trial³⁵-By-Jury³⁶ At The United States District Court³⁷-, "USDC", Arizona, Phoenix: To Wit: "In The Hill Court; A 'Federal Court' At The USDC-Arizona, Phoenix : Claimant Case³⁸ No: CMN 7009 1410 0000 7868 5703³⁹" ...

[The] Framers intended for the first ten amendments to act as restraints only upon the exercise of power by the new, national government... Alabama Educ. Assn v. Bentley, 788 F.Supp.2d 1283.

As Justice Robert H. Jackson once wrote, [t]he very purpose of a Bill of Rights was to withdraw certain subjects from the vicissitude²⁴ of political controversy, to place them beyond the reach of majorities 775 and officials and to establish them as legal principles to be applied by the courts. One's right to life, liberty, and property, to free speech, a free press, freedom of worship and assembly, and other fundamental rights may not be submitted to vote; they depend on the outcome of no elections[;] West Virginia Bd. of Ed. v. Barnette, 319 U.S. 624, 638, 63 S.Ct. 1178, 87 L.Ed. 1628 (1943); see e.g. Weinberger v. Wiesenfeld, 420 U.S. 636, 638 n. 2, 95 S.Ct. 1225, 43 L.Ed.2d 514 (1975) (stating that the right to equal protection is incorporated within the Fifth Amendment's Due Process Clause).

vicissitude²⁴ means: change or variation occurring irregularly in the course of something; especially, change of circumstances in life; ups and downs of fortune. Webster's New 20th Century Unabridged, 2nd (1983), p. 2036

24 covenant means: [A contractual] agreement, convention, or promise of two or more parties, by deed in writing, signed, sealed, and delivered, by which either of the parties pledges himself to the other that something is either done or shall be done or stipulates for the truth of certain facts[;] in the nature of Commonwealth v. Robinson, 1 Watts, Pa. 160; et seq; Black's Law Dictionary, 4th Ed., p. 436.

25 civil means: Originally, pertaining or appropriate to a member of a civitas or free political community; natural or proper to a citizen. Also, relating to the community, or to the policy and government of the citizens and subjects of a state. Black's Law Dictionary, 4th Ed., p. 311.

26 political means: polity: The form of government; civil constitution.

27 International Covenant on Civil and Political Rights means: the covenant adopted and opened for signature, ratification and accession by General Assembly resolution 2200A (XXI) of 16 December 1966 entry into force 23 March 1976; in accordance with Article 49, "ICCPR".

28 ICCPR Treaty ratification 1992 means: "U. S. reservations, declarations, and understandings, International Covenant on Civil and Political Rights, 138 Cong. Rec. S4781-01 (daily ed, April 2, 1992) - IX. TEXT OF RESOLUTION OF RATIFICATION . See Exhibit One.

29 impose means: inflict by force or authority

30 Public Policy means: the community common sense and common conscience extended and applied throughout the state to matter of public morals, public health, public safety, public welfare, and the like; it is the general and well-settled public opinion relating to man's plain, palpable duty to his fellow men having due regard to all the circumstances of each particular relation and situation[;] in the nature of Pittsburgh, c. c. & St. L. Ry. Co. v. Kinney, 95 Ohio St. 64, et seq. Public policy properly cognizable by courts is that derived or derivable by clear implication from its Constitution, statutes, and judicial decisions[;] in the nature of Brown v. American Ry. Express Co., 128 S.C. 428, et seq.; Black's Law Dictionary, 4th Ed, p. 1318.

31 exercise means: to make use of. Thus, to exercise a right or power is to do something which it enables the holder to do[;] in the nature of U.S. v. Souders, 27 Fed. Cas. 1267, et seq.; Black's Law Dictionary, 4th Ed, p. 682.

32 Initial Claim means: filing for court of record common law claim with trial by jury to decide matters of both fact and law: NOTICE: CLAIM RE: Property disposed.... See at Gila County Recorder - site: <http://recorder.gilacountytaz.gov/recorder/web/> Document Number: 2017-002378, pp. 241-549 .

33 common law means: 1. As distinguished from the Roman law, the modern civil law, the canon law and other systems, the common law is that body of law and juristic theory which was originated, developed and formulated ...[;] in the nature of Lux v. Haggin, 69 Cal. 255, et seq. As distinguished from law created by enactment of legislatures, the common law comprises the body of those principles and rules of action, relating to the government and security of persons and property, which derive their authority solely from usages and customs of immemorial antiquity, or from the judgments and decrees of the courts recognizing, affirming, and enforcing such usages and customs; and, in this sense particularly the ancient unwritten law of England[;] in the nature of I Kent, Comm. 492. Western Union Tel. Co. v. Call Pub. Co., 21 S. Ct. 561, et seq.; Black's Law Dictionary, 4th Ed., pp. 345-346.

34 law means: all the rules of conduct established and enforced by the authority, legislation, or custom of a given community or other group... Law implies a penalty or inconvenience for disobedience, and also generality of application as distinguished from a special command... Webster's 20th Century Unabridged, 2nd Ed., p. 1028.

35 trial means: a judicial examination, in accordance with law of the land, of a cause, either civil or criminal, of the issues between the parties, whether of law or fact, before a court that has jurisdiction over it[;] in the nature of People v. Vitale, 364 Ill, 589, et seq.; Black's Law Dictionary, 4th Ed., p. 1675.

36 trial-by-jury means: the terms "jury" and "trial by jury" as used in the constitution, means twelve competent men, disinterested and impartial, not of kin, nor personal dependents of either of the parties, having their homes within the jurisdictional limits of the court, drawn



Darrell- James: Hill, aggrieved man, c/o PO Box 3806, Apache Junction, Arizona 85120

USPS CMN 7015 0640 0001 5883 2679

i man am not subject to martial law rules, AND i have simply required upon you to fulfill your oath, duty and obligation to this man's rights protected by the Constitution for the United States of America by the US Constitution to ensure you protect my rights asserted and exercised. Yet, at this signing, it is evident that you have enabled your criminal subordinates' trespasses against me be condoned.

I require you to Not proceed in fraud; i want my Common-Law-Claim filed and proceeding with no further abuse against me.

i, say here, and will verify in open court,  herein be true.

Darrell James Hill

August 18th, 2017

INTENTIONALLY LEFT BLANK

and selected ..., duly impaneled and sworn [to determine the matters of fact and law] to render a true verdict according to the law [and] evidence[.] in the nature of: Black's Law Dictionary, 4th Ed., p. 993.

37 court means: *International Law*: The person and suite of the sovereign; the place where the sovereign sojourns with his regal retinue, wherever that may be. retinue means: group of followers, state of service; literally, that which is retained.

38 case means: "trespass on the case". trespass on the case means: At common law, an action to recover damages that are not the immediate result of a wrongful act but rather a later consequence; Black's Law 7th Ed, p. 1508-9.

39 Claimant Case No: CMN 7009 1410 0000 7868 5763 means: In the Hill Court; a 'Federal Court' at the USDC- Arizona, Phoenix; January 04, 2017 - USPS RMN RE 322 399 336 US; rec'd 01/04/2017. See Notice: PROOF OF CLAIM at Gila County Recorder - site: <http://recorder.gilacountyaz.gov/recorder/web/> Document Number: 2017-002378, pp. 182-693.

842 USPS CMN: 7015 0640 0001 5883 2679 - 2ND Notice to Ninth Jud Coun Exec Com: Sidney, Richard, Susan 4/5

2022-011769 MISC Page: 841 of 2782

09/25/2022 03:35:37 PM Receipt #: 22-9381

Rec Fee: \$30.00 Darrell James Hill

Gila County, Az, Sadie Jo Bingham, Recorder



Darrell- James: Hill, aggrieved man, c/o PO Box 3806, Apache Junction, Arizona 85120

USPS CMN 7015 0640 0001 5883 2679

Unofficial Copy

ENCLOSURE ONE:

**"Jurat Affidavit- Notice:
9th Circuit Trespass Upon Fundamental and Substantive Rights,
and Common-Law-Claim Rights Under Color-of-Law,**

6 pages.

2022-011769 MISC Page: 842 of 2782

09/26/2022 03:35:37 PM Receipt #: 22-9381

Rec Fee: \$30.00 Darrell James Hill

Gila County, Az. Sadie Jo Bingham, Recorder



843

USPS CMN: 7015 0640 0001 5883 2679 – 2ND Notice to Ninth Jud Coun Exec Com: Sidney, Richard, Susan 5/5

Darrell- James: Hill, aggrieved man¹
c/o 5142 East 18th Avenue
Apache Junction, Arizona ZIP CODE EXEMPT
without the US Inc. [85119]

Sidney; acting as Chief Judge, Chairman;
Richard; acting as Circuit Judge;
Susan; acting as Senior District Judge;
Judicial Council Executive Committee
c/o Office of Executive Committee
P.O. Box 193939
San Francisco, California 94119-3939

Jurat Affidavit- Notice²:
9th Circuit Trespass Upon Fundamental and Substantive Rights³,
and Common-Law-Claim⁴ Rights Under Color-of-Law⁵

Sidney, Richard, Susan: Greetings;

i: man am writing: because i filed a Common-Law-Claim, "claim", for suit into the federal court in Phoenix, Arizona for an amount in controversy greater than 20 dollars in property-forfeited-to-me⁶. And, administratively, i must make you aware of the destruction⁷ of my rights violations surrounding that case because Ranier and Brian, the Chief Judge- USDC-AZ and the Clerk of Court- USDC-AZ, respectively, are involved in the groups' wrong-doings destroying my claim. And, finally, because you are

- 1 i: man means: a) a flesh and blood man-kind understanding Almighty God of Abraham of the Holy Bible, and a sovereign one who in a collective capacity with others sovereigns are the people of the United States of America over-standing the government for the United States of America; b) NOT a cestui que trust, corporation, or other fictitious entity; c) NOT a US citizen; d) Not an inhabitant of a federal area See at Gila County Recorder – site: <http://recorder.gilacountyaz.gov/recorder/web/> Document Number: 2017-002378, pg 199-217 Affidavit
- 2 notify (v), notice means: to point out information, intelligence, knowledge; formal warning
- 3 fundamental-and-substantive-rights means: a) those inalienable rights from Almighty God inherent to nature and man, the right to protect them, and to the world stewardship, life, liberty and property. b) See Gila County Recorder – <http://recorder.gilacountyaz.gov/recorder/web/> Document Number: 2017-002378, pg 684-690. c) See: Declaration of Independence (1776) re: the Constitution for the United States of America (1787), Amendments VII, IX, and X (1789) d) "... [W]hile powers are delegated to the agencies of government, sovereignty itself remains with the people, by whom and for whom all government exists and acts." – Yick Wo v. Hopkins.
- 4 Common-Law-Claim means: a claim brought by a man, the facts and law determined by a jury and/or by a judge. Section I: See at Gila County Recorder – site: <http://recorder.gilacountyaz.gov/recorder/web/> Document Number: 2017-002378, pg 184-584.
- 5 color-of-law means: appearance of truth, likelihood, validity, or right; justification; an initially apparent or prima-facie right; a sufficient warrant for action; as, color of title. See: Gila County Recorder – site: <http://recorder.gilacountyaz.gov/recorder/web/> Document Number: 2017-002378, pg 193. subscript 12.
- 6 property means: a thing privately owned and set aside for private and exclusive use. See at Gila County Recorder – site: <http://recorder.gilacountyaz.gov/recorder/web/> Document Number: 2017-002378, pg 240-549.
- 7 destruction (n.) destroy means: tear down, lay waste, ravage

USPS RMN: RE 322 399 234 US - Jurat Notice to Ninth Jud Coun Exec Com: Sidney, Richard, Susan 1/4

2022-011769 MISC Page: 843 of 2782
09/26/2022 03:35:37 PM Receipt #: 22-9381
Rec Fee: \$30.00 Darrell James Hill
Gila County, Az, Sadie Jo Bingham, Recorder



8464

the only next responsible party in the 9th Circuit Court for addressing the harm and loss i allege, i want my Common-Law-Claim filed and proceeding with no abuse actions against me.

Section I: Offenders; the Group

For nearly four months, beginning January 04, 2017, my Claim has been destroyed by an employee- "group"⁸ within the 9th, Circuit United States District Court⁹, "USDC", Phoenix, Arizona. As explained below under Section III, the group's disregard for my fundamental-and-substantive-rights, rather than the protection of my rights, is a violation against¹⁰ the sovereign people, "people" – the same United-States-of-America-people giving rise to the government for the United States, the United States government, "USgov", and under it, the inferior-courts.

Section II: The Contract

Understanding Almighty God, the people of the United States formed-the-Constitution¹¹ for the people of the United States, under which the USgov was delegated authority¹² to serve: to establish statutory¹³ judicial rules and inferior courts¹⁴. To wit:

a) No statute, and No code, and No rule on any level of the USgov may exceed the Constitutional limits of authority delegated to it by the people; b) The people are forever sovereign over the USgov. And, c) the USgov is forever bound by the Constitution contract: to understand the limits, duties, and obligations of the authorization enabled it. This is common knowledge in fact and in public records.

Section III: Breach of Contract

i presented a claim for filing suit with trial-by-jury¹⁵, for the recovery of my property re: "Hill v Lynch"¹⁶ In The *Hill Court*; 'A Federal Court'

at 'District Court of the united States
for Phoenix Arizona', U.S.A.

Claimant Case No: CMN 7009 1410 0000 7868 5703 "

The USDC- Phoenix assigned Case No. CV-17-00026-PHX-BSB.

But, my Common-Law-Claim presentment was Not filed for suit as ordered. Instead, the group, at the USDC- Phoenix Clerk of Court, et al.: 1) changed¹⁶ the court¹⁷, 2) changed the trial-by-jury, and 3)

8 employee- "group" means: a) Ranier, acting as Chief Judge and b) Brian, acting as Clerk of Court, (c) et al. employees under Ranier/ Brian: USDC-Ariz., Phoenix

9 USDC means: an inferior court under the authority of the government for the United States of America

10 against means: in opposition to, adverse, hostile

11 formed-the-Constitution means: "We the people of the United States, in Order to form a more perfect Union, ... do ordain and establish this Constitution for the United States of America." Constitution for the United States of America, 1787: preamble.

12 authority means: formal approval or sanction given; authorization

13 statutory (adj.) statute means: any law enacted under the Constitutional contract

14 Inferior courts means: "The Congress shall have power to ... constitute Tribunals inferior to the supreme Court[.] Constitution for the United States of America, 1787: Art. I, sect.8, cl. 9. In example, 9th Circuit Court is an inferior court.

15 trial by jury, try by jury means: judicial examination of the facts/ law of a matter by the jury, a set of people selected to try a matter and render a verdict ~ USDC- Phx No. CV-17-00026-PHX-BSB. Doc 1 - See at Gila County Recorder – site: <http://recorder.gilacountyaz.gov/recorder/web/> Document Number: 2017-002378, pg 607-642. notice: Status:

16 change means: to substitute a one thing for another, so to make the first thing other than what it was.

17 court means: the functional context and purpose for a judicial assembly; "In The *Hill Court*; 'A Federal Court ...'" for a Common Law Claim ~ Doc 1 - See at Gila County Recorder – site: <http://recorder.gilacountyaz.gov/recorder/web/> Document Number: 2017-002378, pg 657: Case Summary, et seq.

845
USPS RMN: RE 322 399 234 US - Jurat Notice to Ninth Jud Coun Exec Com: Sidney, Richard, Susan 2/4

2022-011769 MISC Page: 844 of 2782

09/25/2022 03:35:37 PM Receipt #: 22-9381

Rec Fee: \$30.00 Darrell James Hill

Gila County, Az, Sadie Jo Bingham, Recorder



changed the jurisdiction¹⁸: 3a) without¹⁹ my counsel, 3b) with No-authorization²⁰, and 3c) without jurisdiction; then, they 4) did not issue summons; and, 5) a month later wrote ostensibly²¹ that they would not issue summons unless I agreed to substitute their jurisdiction. Neither the USgov nor an inferior court under it has authorization from the people in the Constitutional contract to impose²² wanton abrogation²³ of fundamental or substantive or common law rights upon the people (upon i: man). To this, any and all presumption of authority for the group's any changes to my claim has been expressly denied²⁴.

Section IV: Intent and Damage

The Arizona group implemented an obscure²⁵ color-of-law scheme using 'rules' and standard-operating-procedure²⁶ with No authority under the USgov to systematically- deprive²⁷ the people of their (i: man of my) fundamental, substantive, and common law rights. The record reflects that the group ostensibly sought to obtain jurisdiction over my claim by willful deception and coercion.

At minimum the group members exceeded the USgov Constitutional authority, and did harm and cause loss upon i: man, and with regard to the trespass-upon-the-case²⁸ of the Common-Law-Claim for suit for an amount in controversy greater than twenty dollars. See Constitution (1787); Bill-of-Rights²⁹ (1789), Amendment VII³⁰, IX³¹ and X³².

Section V: Restoration

Despite my good faith efforts and admonishment, even the conspicuous "compensation due"

18 Jurisdiction: trial by jury means: ~ USDC- Phx No. CV-17-00026-PHX-BSB. Doc 1 -

See at Gila County Recorder – site: <http://recorder.gilacountyaz.gov/recorder/web/> Document Number: 2017-002378, pg 585-587: ORDER; pg 596-599: notice: Rules of Court; pg 607-642: notice: Status:; pg 643- :

NOTICE: (g); pg 665- : Notice: To Magistrate

19 without means: outside of; lacking

20 No-authorization means: No formal approval or sanction or "authority" given

21 ostensibly means: capable of being shown

22 impose means: inflict by force or authority

23 abrogation (n), abrogate means: abolish by authoritative activities

24 denied means: refused, rejected, NOT true

25 obscure means: hidden, covert

26 standard operating procedure means: a set of step-by-step instructions compiled by an organization for help workers carry out routine operations.

27 systematically- deprive means: racketeering, by group criminal conduct

28 trespass-upon-the-case means: a) "Notice to Officers of the Court", et seq.: USDC- Phx No. CV-17-00026-PHX-BSB. Doc 1. See: Gila County Recorder – site: <http://recorder.gilacountyaz.gov/recorder/web/> Document Number: 2017-002378, pg 192; b) "notice: Status; Clerks' non-Supply of Summon" pp. 607-642.

29 Bill-of-Rights means: "... [I]n order to prevent misconstruction or abuse of its powers [] further declaratory and restrictive clauses should be added: ARTICLES in addition to, and Amendment of the Constitution of the United States of America..."

30 Amendment VII means: "Article the ninth In Suits at common law, where the value in controversy shall exceed twenty dollars, the right of trial by jury shall be preserved...." Constitution for the United States of America, 1787; Bill of Rights, 1789.

31 Amendment IX means: "Article the eleventh The enumeration in the Constitution, of certain rights, shall not be construed to deny or disparage others retained by the people." Constitution for the United States of America, 1787; Bill of Rights, 1789.

32 Amendment X means: "Article the twelfth The powers not delegated to the United States by the Constitution, nor prohibited by it to the States, are reserved to the States respectively, or to the people." Constitution for the United States of America, 1787; Bill of Rights, 1789.

USPS RMN: RE 322 399 234 US - Jurat Notice to Ninth Jud Coun Exec Com: Sidney, Richard, Susan 3/4

2022-011769 MISC Page: 845 of 2782
09/26/2022 03:35:37 PM Receipt #: 22-9381
Rec Fee: \$30.00 Darrell James Hill
Gila County, Az, Sadie Jo Bingham, Recorder



agreement³³ -on default³⁴ upon any trespass-upon-the-case, the group members persisted to impose a deprivation of rights scheme or scam against i: man, one of the people. Therefore, upon your receipt of this notice i require³⁵ that: a) this deprivation of rights in breach of Constitutional contract in all its forms of trespass-upon-the-case must be ceased and desisted hereto-forever post haste; b) my Common-Law-Claim presentments must hereto-forever be filed as ordered; c) This deprivation of rights must No longer be permitted; and, d) i: man must be made whole³⁶. I would want to know so to repair the wrong-doings occurring under my oath, authority, duty and obligation, and reputation.

Section VI: Conclusion

There is No USgov authority nor inferior court authority under the USgov for the protection³⁷ of the group's wrong-doings against i: man's (against the people's) inalienable rights or substantive rights or rights to common law claim. The group members knew or should have known that this deprivation of rights by any USgov subordinate was NEVER supposed to be imposed or allowed to happen to the people (to i: man) of the United States of America. And,

This deprivation of rights against the people (i: man) hereto-forever must Not ever be tolerated.

i, say here, and will verify in open court, that all herein be true.

Darrell-James Hill
April 27th, 2017

Jurat

State of Arizona
County of Pinal

On this 27th day of April 2017, before me present is Darrell-James Hill whose identity was proven to me on the basis of satisfactory evidence of an State of Arizona Driver License to be the Authorized Representative claimed: Signed and affirmed before me this 27th day of April, 2017;

Notary Public



- 33 agreement means: the action of consent, assent. The group members all acquiesced to the compensation due upon their actions; agreement - by default in trespass-upon-the-case.
- 34 default means: to put wrong
- 35 require means: a demanding of that which is necessary and proper and critical for proceeding upon a right.
- 36 made whole means: compensation-due; fees for common law filing returned.
- 37 protection means: defend, assist, shelter

847 USPS RMN: RE 322 399 234 US - Jurat Notice to Ninth Jud Coun Exec Com: Sidney, Richard, Susan 4/4

2022-011769 MISC Page: 846 of 2782
09/26/2022 03:35:37 PM Receipt #: 22-9381
Rec Fee: \$30.00 Darrell James Hill
Gila County, Az, Sadie Jo Bingham, Recorder



Registered No. **RE322399234US**

Date Stamp
0130
07

To Be Completed By Post Office	Postage \$ \$0.70	Extra Services & Fees (optional)
	Extra Services & Fees	<input type="checkbox"/> Signature Confirmation
	<input type="checkbox"/> Registered Mail (hardcopy) \$ \$12.50	<input type="checkbox"/> Signature Confirmation Restricted Delivery
	<input type="checkbox"/> Return Receipt (hardcopy) \$ \$2.75	<input type="checkbox"/> Restricted Delivery
<input type="checkbox"/> Return Receipt (electronic) \$ \$0.00	Total Postage & Fees \$ \$15.95	
<input type="checkbox"/> Restricted Delivery \$	Customer Must Declare Full Value \$ \$10.00	Received by 04/27/2017
		Domestic insurance up to \$50,000 is included based upon the declared value. International indemnity is limited. (See Reverse).

APACHE JUNCTION
151 W SUPERSTITION BLVD
APACHE JUNCTION
AZ
85120-9998
0302590130
04/27/2017 (800)275-8777 3:17 PM

Product Description	Sale Qty	Final Price
First-Class Mail Letter (Domestic)	1	\$0.70
Registered (Amount: \$10.00) (USPS Registered Mail #) (RE322399234US)	1	\$12.50
Return Receipt (USPS Return Receipt #) (9590940220736132026930)	1	\$2.75

OFFICIAL USE

To Be Completed By Customer (Please Print) All Entries Must Be in Ink or Typed	FROM	Darrell James Hill, approved mail c/o 5142 East 11 th Avenue Apache Junction, Arizona ZIP CODE EXEMPT without the US Inc. (85119) 85120
	TO	Sally, acting as Chief Judge, Chairman, Richard, acting as Circuit Judge, Thomas, acting as Senior Circuit Judge, Judicial Council, California Committee c/o Office of Executive Councilors P.O. Box 183919 San Francisco, California 94119-3919

PS Form 3806, Registered Mail Receipt
April 2015, PSN 7530-02-600-9051
For domestic delivery information, visit our website at www.usps.com

Copy 1 - Customer
(See Information on Reverse)

Total \$15.95
Cash \$50.00
Change (\$34.05)

In a hurry? Self-service kiosks offer quick and easy check-out. Any Retail Associate can show you how.

Text your tracking number to 28777 (2USPS) to get the latest status. Standard Message and Data rates may apply. You may also visit USPS.com USPS Tracking or call 1-800-222-1811.

BRIGHTEN SOMEONE'S MAILBOX. Greeting cards available for purchase at select Post Offices.

2022-011769 MISC Page: 847 of 2782
09/26/2022 03:35:37 PM Receipt #: 22-9381
Rec Fee: \$30.00 Darrell James Hill
Gila County, Az, Sadie Jo Bingham, Recorder



848
Unofficial

Track Another Package +

Remove X

Tracking Number: RE322399234US

Delivered

Expected Delivery Day: Monday, May 1, 2017
Product & Tracking Information

See Available Actions

Postal Product:
First-Class Mail®

Features:
Registered Mail™
Return Receipt

See tracking for related item: 9500940220733132026930
(/go/TrackConfirmAction?Label=9500940220733132026930)

DATE & TIME	STATUS OF ITEM	LOCATION
May 1, 2017, 1:53 pm	Delivered, Left with Individual	SAN FRANCISCO, CA 94103
Your item was delivered to an individual at the address at 1:53 pm on May 1, 2017 in SAN FRANCISCO, CA 94103.		
May 1, 2017, 11:28 am	Available for Pickup	SAN FRANCISCO, CA 94119
May 1, 2017, 11:25 am	Arrived at Unit	SAN FRANCISCO, CA 94105
May 1, 2017, 12:33 am	Departed USPS Facility	SAN FRANCISCO, CA 94188
April 30, 2017, 9:42 pm	In Transit to Destination	
April 29, 2017, 3:42 pm	Arrived at USPS Destination Facility	SAN FRANCISCO, CA 94188
April 28, 2017, 1:54 am	Departed USPS Facility	PHOENIX, AZ 85026
April 28, 2017, 1:52 am	Arrived at USPS Facility	PHOENIX, AZ 85026
April 27, 2017, 6:12 pm	Departed Post Office	APACHE JUNCTION, AZ 85120
April 27, 2017, 3:15 pm	Acceptance	APACHE JUNCTION, AZ 85120

849



Jeff: U.S. Attorney General Sessions
950 Pennsylvania Avenue, N.W.
Washington, District of Columbia [20530-0001]

CLAIM¹: NOTICE AND DEMAND

RE: Property disposed to the United States of America reported in the "UNITED STATES ATTORNEY'S OFFICE; OFFICIAL NOTIFICATION POSTED ON AUGUST 30, 2017"

Jeff, Greetings: **NOTICE:**

- i: man of the people claim property right protection under the law of the land to:
- a) make this superior-claim to the property² disposed by the United States³ court(s) to the "United States of America"⁴ as reported in the "UNITED STATES ATTORNEY'S OFFICE; OFFICIAL NOTIFICATION POSTED ON AUGUST 30, 2017"; and,
 - b) claim the property specifically disposed to the "United States of America": as,
 - 1) indicated in the attached **Enclosure One- Amended ' OF UNITED STATES ATTORNEY'S OFFICE; FROM THE OFFICIAL NOTIFICATION POSTED ON AUGUST 30, 2017';**
 - 3) made now timely with the ending of any commercial petition phase, and to avoid appearance of tacit acquiescence or error; and,
 - 4) property shall be of free and clear title; delivered without delay immediately in course of common law.
 - 5) This is your sworn oath, duty and obligation to ensure my claim and property to the people protected by the Law of the land under the Constitution for the United States of America.

DEMAND: immediately

- Jeff, a) You are granted 30 days from the time of receipt to comply and to avoid trespass;
- b) Your silence shall be: i) tacit- acquiescence of my any claim AND
ii) full tacit procuration in any related matter,
 - c) for unopposed receipt of any property claimed.

Sincerely;

September 15, 2017



Darrell James Hill
Darrell- James: Hill,
one of the people of the non- political aggregate

1 claim means: man's demand for something rightfully due.
 2 property means: that substance of the right of the exclusive and absolute ownership in its any form
 3 United States means: the corporation; the government service for the people, the United States of America
 4 United States of America means: the essential essence of the land and people by the people and for the people.

Property Claim 3

2022-011769 MISC Page: 850 of 2782
09/26/2022 03:35:37 PM Receipt #: 22-9381
Rec Fee: \$30.00 Darrell James Hill
Gila County, Az, Sadie Jo Bingham, Recorder



Unofficial Copy

Enclosure One-
Amended 'UNITED STATES ATTORNEY'S OFFICE;
OFFICIAL NOTIFICATION POSTED ON AUGUST 30, 2017',
359 pages

852

Property Claim 3

USPS RE 322 399 248 US 2/2
2022-011769 MISC Page: 851 of 2782
09/26/2022 03:35:37 PM Receipt #: 22-9381
Rec Fee: \$30.00 Darrell James Hill
Gila County, Az, Sadie Jo Bingham, Recorder



COMPLETE THIS SECTION

- Complete items 1, 2, and 3.
- Print your name and address on the reverse so that we can return the card to you.
- Attach this card to the back of the mailpiece or on the front if space permits.

1. Article Addressed to:

Jeff: U.S. Attorney General Sessions
 950 Pennsylvania Avenue, N.W.
 Washington, District of Columbia [20530-0001]



9590 9402 2785 7069 6401 36

COMPLETE THIS SECTION ON DELIVERY

A. Signature *Ealy Love* Agent Addressee
 X

B. Received by (Printed Name) *Ealy Love* Date of Delivery *SEP 26 2017*

D. Is delivery address different from item 1? Yes No
 If YES, enter delivery address below:

3. Service Type
- | | |
|--|---|
| <input type="checkbox"/> Adult Signature | <input type="checkbox"/> Priority Mail Express® |
| <input type="checkbox"/> Adult Signature Restricted Delivery | <input type="checkbox"/> Registered Mail™ |
| <input type="checkbox"/> Certified Mail® | <input type="checkbox"/> Registered Mail Restricted Delivery |
| <input type="checkbox"/> Certified Mail Restricted Delivery | <input type="checkbox"/> Return Receipt for Merchandise |
| <input type="checkbox"/> Collect on Delivery | <input type="checkbox"/> Signature Confirmation™ |
| <input type="checkbox"/> Collect on Delivery Restricted Delivery | <input type="checkbox"/> Signature Confirmation Restricted Delivery |
| <input type="checkbox"/> Insured Mail | |
| <input type="checkbox"/> Insured Mail Restricted Delivery (over \$500) | |

2. Article Number (Transfer from service label)
 RE 322 399 248 US

PS Form 3811, July 2015 PSN 7530-02-000-9063

Domestic Return Receipt

Unofficial Copy

853

Registered No RE322399248US

Date Stamp 0130 08

To Be Completed By Post Office	Reg. Fee	\$20.05	
	Handling Charge	\$12.50	Return Receipt
	Postage	\$2.75	Restricted Delivery
		\$0.00	
	Received by	\$0.00	\$35.30

Customer Must Declare Full Value \$1.00 09/15/2017
 Domestic Insurance up to \$25,000 is included based upon the declared value. International indemnity is limited. (See Reverse).

OFFICIAL USE

To Be Completed By Customer (Please Print) All Entries Must Be in Ballpoint or Typed	FROM	Derrell James Hill 5124 East 18 th Avenue, Apache Junction, Arizona [85119]
	TO	Jeff U.S. Attorney General Sessions WASHINGTON, DC 20530 Washington, District of Columbia [20530-0001]

PS Form 3806, Receipt for Registered Mail Copy 1 - Customer
 May 2007 (7530-02-000-9051) (See Information on Reverse)
 For domestic delivery information, visit our website at www.usps.com®

APACHE JUNCTION
 151 W SUPERSTITION BLVD
 APACHE JUNCTION

AZ
 85120-9998
 0302590130

09/15/2017 (800)275-8777 11:11 AM

Product Description	Sale Qty	Final Price
PH 2-Day (Domestic) (WASHINGTON, DC 20530) (Height:3 Lb 11.20 Oz) (Expected Delivery Day) (Monday 09/18/2017)	1	\$20.05
Registered (Amount:\$21.00) (@USPS Registered Mail #) (RE322399248US)	1	\$12.50
Return Receipt (9590940227857069540136)	1	\$2.75
Total		\$35.30
Cash		\$100.30
Change		(\$65.00)

Includes up to \$50 insurance

In a hurry? Self-service kiosks offer quick and easy check-out. Any Retail Associate can show you how.

Text your tracking number to 28777 (2USPS) to get the latest status. Standard Message and Data rates may apply. You may also visit USPS.com USPS Tracking or call 1-800-222-1811.

 BRIGHTEN SOMEONE'S MAILBOX. Greeting cards available for purchase at select Post Offices.

Save this receipt as evidence of

854

09/26/2022 03:35:37 PM Receipt #: 22-9381
 Rec Fee: \$30.00 Darrell James Hill
 Gila County, Az, Sadie Jo Bingham, Recorder



Claim 3
248

Copy

:(C) :Oct. 31- 2016 :Property -Claim: RE 322 399 279 US
:Gila county, Ariz. -Doc. # 2017-002378, :page: 243- 549.

:(K) :Mar. 31- 2017 :Property -Claim: RE 322 399 251 US
:Gila county, Ariz. -Doc. # 2019-009291, :page: 9- 333, 342- 343.

:(T) :Sept. 26- 2017 :Property -Claim: RE 322 399 248 US
:Gila county, Ariz. -Doc. # 2019-009291, :page: 374- 549- 737.

855

2022-011769 MISC Page: 854 of 2782
09/26/2022 03:35:37 PM Receipt #: 22-9381
Rec Fee: \$30.00 Darrell James Hill
Gila County, Az, Sadie Jo Bingham, Recorder



:Darrell-James: Hill c/o PO Box 3806, Apache Junction, Arizona 85120

USPS RMN RE 322 399 146 US

**:Jeff, acting: in the role of the
United States Attorney General Sessions
950 Pennsylvania Avenue, N.W.
Washington, District of Columbia [20530]**

:DISHONOR

**Re: A: August 16, 2016, CLAIM: USPS RMN RE 322 399 279 US;
February 17, 2017 CLAIM: USPS RMN RE 322 399 251 US; and,
September 15, 2017 CLAIM: USPS RMN RE 322 399 248 US**

**B: CLAIMS VIOLATIONS: January 09, 2018: ITEMIZED BILLS TOTAL
DUE-NOW-PAID is: '1,123,300' ~one million one hundred twenty-three thousand
three hundred: 1- ounce .999 silver U.S. dollars.**

Greetings Jeff:

i:man¹ claim natural and fundamental rights to life, liberty, property and: private-property-claimed owned now² by the right³ of the i:man :Darrell-James: Hill.

1: i: man understand the Almighty God; and, no-thing stands between the Almighty God and :Darrell-James: Hill.

2: Almighty God gave to this i:man inalienable rights of the nature, society, dominion and government authority.

3: You Jeff now are in DISHONOR by ignoring repeated Registered Mail demands for the lawful turn of my property to i:man :Darrell-James: Hill.

4: i: man claimed⁴ and exercised⁵ my natural and fundamental rights to the private-property-

1 i: man, i:man means: Almighty God's: man, of the people of the nation states of America.

2 now means: immediately, with no delay and with no hesitation.

3 Bill of Rights-1789, Amendment IX. The enumeration in the Constitution, of certain rights, shall not be construed to deny or disparage others retained by the people.

4 SLL: Amendment IX. The enumeration in the Constitution, of certain rights, shall not be construed to deny or disparage others retained by the people.

ICCPR: Article 1: 2. All peoples may, for their own ends, freely dispose of their natural wealth and resources without prejudice to any obligations arising out of international economic co-operation, based upon the principle of mutual benefit, and international law. In no case may a people be deprived of its own means of subsistence.

ICCPR-1992: (5) That the United States understands that this Covenant shall be implemented by the Federal Government to the extent that it exercises legislative and judicial jurisdiction over the matter covered therein, ... for the fulfillment of the Covenant.

5 SLL: Amendment X. The powers not delegated to the United States by the Constitution, nor prohibited by it to the States, are reserved to the States respectively, or to the people.

ICCPR: Article 2: 2. Where not already provided for by existing legislative or other measures, each State Party to the present Covenant undertakes to take the necessary steps, in accordance with its constitutional processes and with the provisions of the present Covenant, to adopt such laws or other measures as may be necessary to give

:Letter: Jeff: Property: January 2018 A.D. USPS RMN RE 322 399 146 US

1/3

**2022-011769 MISC Page: 855 of 2782
09/26/2022 03:35:37 PM Receipt #: 22-9384
Rec Fee: \$30.00 Darrell James Hill
Gila County, Az, Sadie Jo Bingham, Recorder**



856

:Darrell-James: Hill c/o PO Box 3806, Apache Junction, Arizona 85120

USPS RMN RE 322 399 146 US

claimed⁶.

- 5: i:man do not grant, understand nor consent to the rights violation⁷/deprivation⁸ by any presumption⁹ or person(s) acting in a role for the United States government.
- 6: i:man do not authorize you possession of my private-property.
- 7: i:man do not authorize you otherwise dispose of my private-property.
- 8: i:man do not authorize you deprive me of the private-property.
- 9: i:man do not authorize you harming and damaging i:man :Darrell-James: Hill.
- 10: i:man do not authorize your breach of the sworn duty and obligation: CftUSofA^{10 11 12}.

ORDER:

- 11: You Jeff store now to the owner: Darrell-James: Hill, heirs, assigns and agents: private-property-claimed.
- 12: For the fee schedule of the Claim Violations by the agreement¹³ :January 09, 2018, **BILL TOTAL DUE-NOW-PAID is: '1,123,300' ~ one million one hundred twenty-three**

effect to the rights recognized in the present Covenant.

ICCPR-1992: III. The Senate's advice and consent is subject to the following declarations: (1) The United States declares that the provisions of Articles 1 through 27 of the Covenant are not self-executing.

SELF-EXECUTING means: "Self-executing treaty" is one that becomes domestic law of signatory nation without implementing legislation, and provides private right of action to individuals alleging breach of its provisions. U.S. v. Noriega, S.D.Fla. 1992, 808 F.Supp. 791.

- 6 **Private-property-claimed** means: August 16, 2016, CLAIM: USPS RMN RE 322 399 279 US; :February 17, 2017 CLAIM: USPS RMN RE 322 399 251 US; and :September 15, 2017 CLAIM: USPS RMN RE 322 399 248 US.
- 7 **Modern Day Slavery: President Donald J. Trump-29 December 2017- Proclamation: January 2018 National Slavery and Human Trafficking Prevention Month:** "I call upon ... ending all forms of modern slavery...."
- 8 **Rights Deprivation(1): CftUSofA: Art.1, Sec.9, Cl.4:** "No Capitation, or other direct, Tax shall be laid, unless in Proportion to the Census or Enumeration herein before directed to be taken [Art.1, Sec.8, Cl.1]"
Rights Deprivation(2): DONALD J. TRUMP: December 20, 2017: EO Blocking the Property of Persons Involved in Serious Human (sic) Rights Abuse or Corruption: Section 1, (B)(1) "corruption, including the misappropriation of state assets, the expropriation of private assets for personal gain, corruption related to government contract or ..., or bribery:
- 9 **Presumption: USAG, et al.:** USPS RMN RE 322 399 282 US ~ October 14, 2016: US President, et al.: USPS RMN RE 322 398 208 US ~ September 09, 2016 .
- 10 **CftUSofA** means: the Constitution for the united States of America -1787 and Bill of Right-1789 by, to and for the people sovereigns, 'CftUSofA people'. See: The sovereignty of the United States [government] resides in the people, and Congress cannot invoke the sovereignty of the people to override their will as declared in the Constitution. Perry v. U.S. 294 U.S. 330, 353
- 11 **Emancipation Proclamation:** January 1863; the Law of the Land, 'LL': ""That on the first day of January, in the year of our Lord one thousand eight hundred and sixty-three, all persons held as slaves within ... shall be then, thenceforward, and forever free; ... And by virtue of the power, ... the Executive government of the United States, including the military and naval authorities thereof, will recognize and maintain the freedom of said persons."
- 12 **ICCPR- 1992** means: International Covenant for Civil and Political Rights, ratified by the U.S. Senate- 1992 - U.S. reservations, declarations, and understandings, International Covenant on Civil and Political Rights, 138 Cong. Rec. S4781-01 (daily ed., April 2, 1992).-- LL: international covenant by the United States' signatory for to ensure, protect and promote private-property-claimed rights exercised are made sure by the United States government.
- 13 **USAG:** USPS CMN 7016 0340 0000 6402 7789 ~November 10, 2016: One-ounce .999 U.S. silver dollar for each minute unit measurement of the time/ claim. [e.g.:each claim x 1 ounce .999 silver U.S. dollars x 60 minutes = 60(sixty)- 1 ounce .999 silver U.S. dollars/ 60 minutes/ each claim]

:Letter: Jeff: Property: January 2018 A.D. USPS RMN RE 322 399 146 US

2/3

2022-011769 MISC Page: 856 of 2782

09/26/2022 03:35:37 PM Receipt #: 22-9381

Rec Fee: \$30.00 Darrell James Hill

Gila County, Az, Sadie Jo Bingham, Recorder



857

:Darrell-James: Hill c/o PO Box 3806, Apache Junction, Arizona 85120

USPS RMN RE 322 399 146 US

thousand three hundred: 1- ounce .999 silver U.S. dollars due now upon delivery of this ORDER.

12B: January 09, 2018: ITEMIZED BILLS ATTACHED:

- 1: August 16, 2016 CLAIM: '604,800'~six hundred four thousand eight hundred: 1- ounce .999 silver U.S. dollars: August 16, 2016 to December 25, 2017;
- 2: February 17, 2017 CLAIM: '388,800'~three hundred eighty-eight thousand eight hundred: 1- ounce .999 silver U.S. dollars: February 17, 2017 to December 30, 2017;
- 3: September 15, 2017 CLAIM: '129,600'~one hundred twenty-nine thousand six hundred: 1- ounce .999 silver U.S. dollars: September 15, 2017 to December 25, 2017;

Sincerely:

:Darrell-James: Hill

:Darrell-James: Hill, i:man

INTENTIONALLY LEFT BLANK

:Letter: Jeff: Property: January 2018 A.D. USPS RMN RE 322 399 146 US

3/3

2022-011769 MISC Page: 857 of 2782
09/26/2022 03:35:37 PM Receipt #: 22-9381
Rec Fee: \$30.00 Darrell James Hill
Gila County, Az, Sadie Jo Bingham, Recorder



Unofficial

858

:August 16, 2016 CLAIM:
USPS RMN RE 322399 279 US:

January 09, 2018: ITEMIZED BILL
:August 16, 2016 to December 25, 2017

from: Darrell-James: Hill
c/o PO Box 3806
Apache Junction, Arizona 85120
/USPS RMN RE 322 399 146 US

:Jeff Sessions

:six hundred four thousand eight hundred'

:DUE NOW

Name	30 day pay now period	Minute units/period	Amt due (1 oz. .999 silver U.S. dollar/minute)/ accum.	Amt paid/ Bal due now
1 ORDER: #12	Oct. 31, 2016 – Nov. 30, 2016	43200	43200/43200	0/43200
2 ORDER: #12	Nov. 30, 2016 – Dec. 30, 2016	43200	43200/86400	0/86400
3 ORDER: #12	Dec. 30, 2016 – Jan. 29, 2017	43200	43200/129600	0/129600
4 ORDER: #12	Jan. 29, 2017 – Feb. 28, 2017	43200	43200/172800	0/172800
5 ORDER: #12	Feb. 28, 2017 – Mar. 30, 2017	43200	43200/216000	0/216000
6 ORDER: #12	Mar. 30, 2017 – April 29, 2017	43200	43200/259200	0/259200
7 ORDER: #12	April 29, 2017 – May 29, 2017	43200	43200/302400	0/302400
8 ORDER: #12	May 29, 2017 – June 28, 2017	43200	43200/345600	0/345600
9 ORDER: #12	June 28, 2017- July 28, 2017	43200	43200/388800	0/388800
10 ORDER: #12	July 28, 2017 – Aug. 27, 2017	43200	43200/432000	0/432000
11 ORDER: #12	Aug. 27, 2017 – Sept. 26, 2017	43200	43200/475200	0/475200
12 ORDER: #12	Sept. 26, 2017 – Oct. 26, 2017	43200	43200/518400	0/518400
13 ORDER: #12	Oct. 26, 2017 – Nov. 25, 2017	43200	43200/561600	0/561600
14 ORDER: #12	Nov. 25, 2017 – Dec. 25, 2017	43200	43200/604800	0/604800
15 Sub total				604800
16 Credits				0
17 Total				604800
18				
19				
20				
21				
22				

2022-011769 MISC Page: 858 of 2782
09/26/2022 03:35:37 PM Receipt #: 22-9381
Rec Fee: \$30.00 Darrell James Hill
Gila County, Az, Sadie Jo Bingham, Recorder



859 :August 16, 2016 CLAIM: January 09, 2018: ITEMIZED BILL :USPS RMN RE 322 399 146 US

:February 17, 2017 CLAIM:
USPS RMN RE 322 399 251 US

January 09, 2018: ITEMIZED BILL
February 17, 2017 to December 30, 2017

from: Darrell James Hill
c/o PO Box 3806
Apache Junction, Arizona 85120
/USPS RMN RE 322 399 146

:Jeff Sessions

:three hundred eighty-eight thousand eight hundred¹

:DUE NOW

Name	30 day pay now period	Minute units/ period	Amt due (1 oz. .999 silver U.S. dollar/ minute)/ accum.	Amt paid/ Bal due now
1 ORDER: #12	April 04, 2017 – May 04, 2017	43200	43200/43200	0/43200
2 ORDER: #12	May 04, 2017 – June 03, 2017	43200	43200/86400	0/86400
3 ORDER: #12	June 03, 2017- July 03, 2017	43200	43200/129600	0/129600
4 ORDER: #12	July 03, 2017 – Aug. 02, 2017	43200	43200/172800	0/172800
5 ORDER: #12	Aug. 02, 2017 – Sept. 01, 2017	43200	43200/216000	0/216000
6 ORDER: #12	Sept. 01, 2017 – Oct. 01, 2017	43200	43200/259200	0/259200
7 ORDER: #12	Oct. 01, 2017 – Oct. 31, 2017	43200	43200/302400	0/302400
8 ORDER: #12	Oct. 31, 2017 – Nov. 30, 2017	43200	43200/345600	0/345600
9 ORDER: #12	Nov. 30, 2017 – Dec. 30, 2017	43200	43200/388800	0/388800
10 :Sub total				:388800
11 :Credits				0
12 :Total				:388800
13				
14				
15				
16				
17				
18				
19				
20				
21				
22				

2022-011769 MISC Page: 859 of 2782

09/26/2022 03:35:37 PM Receipt #: 22-9381

Rec Fee: \$30.00 Darrell James Hill

Gila County, Az, Sadie Jo Bingham, Recorder



860
1:February 17, 2017 CLAIM: January 09, 2018: ITEMIZED BILL :USPS RMN RE 322 399 146 US

:September 15, 2017 CLAIM:
USPS RMN RE 322 599 248 US

January 09, 2018: ITEMIZED BILL
September 15, 2017 to December 25, 2017

from: Darrell-James: Hill
c/o PO Box 3806
Apache Junction, Arizona 85120
:USPS RMN RE 322 399 146 US

:Jeff Sessions

:one hundred twenty-nine thousand six hundred⁴

:DUE NOW

Name	30 day pay now period	Minute units/period	Amt due (1 oz. .999 silver U.S. dollar/minute)/ accum.	Amt paid/ Bal due now
1 ORDER: #12	April 04, 2017 – May 04, 2017	43200	43200/43200	0/43200
2 ORDER: #12	Sept. 26, 2017 – Oct. 26, 2017	43200	43200/86400	0/86400
3 ORDER: #12	Oct. 26, 2017 – Nov. 25, 2017	43200	43200/129600	0/129600
4 :Sub total				:129600
5 :Credits				0
6 :Total				:129600
7				
8				
9				
10				
11				
12				
13				
14				
15				
16				
17				
18				
19				
20				
21				
22				

861

2022-011769 MISC Page: 860 of 2782
09/26/2022 03:35:37 PM Receipt #: 22-9381
Rec Fee: \$30.00 Darrell James Hill
Gila County, Az, Sadie Jo Bingham, Recorder

1:September 15, 2017 CLAIM: January 09, 2018: ITEMIZED BILL :USPS RMN RE 322 399 146 US

Registered No.

RE322399146US

Date Stamp



To Be Completed By Post Office	Reg. Fee	\$0.70	Return Receipt
	Handling Charge	\$12.50	Restricted Delivery
	Postage	\$2.75	Received by
	Customer Must Declare Full Value \$	\$21.00	01/17/2018
	Domestic Insurance up to \$5,000 is included based upon the declared value. International delivery is limited. (See Remarks)		913-999

APACHE JUNCTION
151 W SUPERSTITION BLVD
APACHE JUNCTION
AZ

85120-9998
0302590130

01/17/2018 (800)275-8777 4:22 PM

Product Description	Sale Qty	Final Price
First-Class Mail Letter	1	\$0.70
Registered	1	\$12.50
Return Receipt	1	\$2.75
Affixed Postage	1	(\$0.29)
Total		\$15.66
Cash Change		\$20.00 (\$4.34)

Product Description: First-Class Mail Letter
 Sale Qty: 1
 Final Price: \$0.70

Registered (Amount:\$21.00)
 (®USPS Registered Mail #)
 (RE322399146US)

Return Receipt (®USPS Return Receipt #)
 (9590940306765196708833)

Affixed Postage (Affixed Amount:\$0.29)

Total \$15.66
 Cash Change \$20.00 (\$4.34)

Text your tracking number (2USPS) to get the latest Standard Message and Data apply. You may also visit USPS Tracking or call 1-800-275-8777

OFFICIAL USE

APACHE JUNCTION, AZ 85120

FROM: Darrell James Hill, PO Box 3535, Apache Junction, Arizona 85120

TO: United States Attorney General Election, 550 Pennsylvania Avenue, N.W., Washington, D.C. 20530

PS Form 3806, Receipt for Registered Mail Copy 1 - Customer May 2007 (7530-02-000-9051) (See Information on Reverse) For domestic delivery information, visit our website at www.usps.com

RECEIVED COPY 1/17/18 5:04 PM

1. Complete items 1, 2, and 3

2. Print your name and address on the reverse so that we can return the card to you.

3. Attach this card to the back of the mail piece or on the front in space provided.

4. Sample Addressed to:

550 Pennsylvania Avenue, N.W. Washington, District of Columbia 20530

Signature: Darrell James Hill

Date: JAN 29 2018

RE 322 399 146 06 11

2022-011769 MISC Page: 861 of 2782
09/26/2022 03:35:37 PM Receipt #: 22-9381
Rec Fee: \$30.00 Darrell James Hill
Gila County, Az, Sadie Jo Bingham, Recorder



:Holy Bible

Book of Proverbs: 1

- (10) My son, if sinners entice thee, consent thou not.
- (11) If they say, Come with us, let us lay wait for blood, let us lurk privily for the innocent without cause: (12) Let us swallow them up alive as the grave; and whole, as those that go down into the pit: (13) We shall find all precious substance, we shall fill our houses with spoil: (14) Cast in thy lot among us; let us all have one purse: (15) My son, walk not thou in the way with them; refrain thy foot from their path: (16) For their feet run to evil, and make haste to shed blood.
- (17) Surely in vain the net is spread in the sight of any bird.
- (18) And they lay wait for their own blood; they lurk privily for their own lives.
- (19) So are the ways of every one that is greedy of gain; which taketh away the life of the owners thereof.

Land, 'SLL'⁹, Law of the Land, 'LL'¹⁰, and: POTUS and military of the 'United States government'.

:Jeff actor in the role of the fiduciary in the office of the USAG failed in the support of the claims executed¹¹ by the i:man. Notice and Demands with regard to the fundamental rights-exercised were sent to the man of the USAG¹², POTUS¹³, and military¹⁴ actors in the roles of a fiduciary for the i:man :Darrell-James: Hill. Then- after this man waited in good faith for the man USAG and POTUS and Military's CfUSofA, Emancipation Proclamation and ICCPR adherence, assurance, promotion and protections of the Almighty God-given rights exercised.

:Jeff in the role of the USAG showed dishonor¹⁵ by the criminal-negligence of his fiduciary duty¹⁶.

For the lack of the fiduciary duty by the man Jeff: i:man now appoint for the fiduciary :man Donald for the remedy of the wrong-doings with regard to the store of my private-property and now payment of the fee bills due for the bias in the prejudice shown against the i:man¹⁷ :Darrell-James: Hill by the man Jeff

9 The Constitution for the United States of America, CfUSofA, Supreme Law of the Land, 'SLL' and Law of the Land, 'LL'.

10 LL means: SLL augmented by the 'Emancipation Proclamation' and the International Covenant on Civil and Political Rights', 'ICCPR', etc.

11 ICCPR Senate ratification: March 1992: 'rights executed are promoted and protected by the full power of the United States'

12 USAG means: man - 1) Loretta and 2) Jeff

1) Loretta: a) August 16, 2016, Claim-1: USPS RMN RE 322 399 279 US - Recv'd October 31, 2016,

b) October 14, 2016 *fu* Claim-1: USPS RMN RE 322 399 282 US - Recv'd October 24, 2016,

c) November 10, 2016 *fu* Claim-1: USPS CMN 7016 0340 0000 6402 7789 - Recv'd November 16, 2016,

d) November 16, 2016 *fu* Claim-1: USPS RMN RB 898 810 007 US - Recv'd November 25, 2016; and,

2) Jeff: a) March 20, 2017 Claim-2: USPS RE 322 399 251 US - Recv'd April 04, 0217

b) July 13, 2017 *fu* Claim-1: USPS RMN RE 322 399 058 US - Recv'd July 24, 2017,

c) July 13, 2017 *fu* Claim-2: USPS RE 322 399 101 US - Recv'd July 24, 2017

d) August 11, 2017 *fu* Claim-1 & Claim-2: USPS 7015 0640 0001 5883 2662 - Recv'd August 21, 2017

e) August 21, 2017 *fu* Claim-1 & Claim-2: USPS 7015 0640 0001 5883 2716 - Recv'd August 28, 2017

f) September 15, 2017 Claim-3: USPS RE 322 399 248 US - Recv'd September 25, 0217

g) DISHONOR: January 17, 2018 *fu* Claim-1, Claim-2 & Claim-3: USPS RMN RE 322 399 146 US - Recv'd January 29, 2018

13 POTUS means: man - 1) Barack and 2) Donald

1) Barack: September 09, 2016 *fu* Claim-1: USPS RMN 322 398 208 US - Recv'd September 27, 2016

2) Donald a) July 13, 2017 *fu* Claim-1: USPS RMN RE 322 399 044 US - Recv'd July 13, 2017

b) August 21, 2017 *fu* Claim-1: USPS CMN 7015 0640 0001 5883 2769 - Recv'd August 22, 2017

c) c/o CJCOS: 1 August 23, 2017 *fu* Claim-1: USPS RMN RE 322 399 132 US - Recv'd August 31, 2017

14 military means: 1) CJCOS Dunford, 2) COS Army Miley and 3) JCOS

1) CJCOS Dunford: September 09, 2016 *fu* Claim-1: USPS RMN 322 398 211 US - Recv'd September 22, 2016

2) COS Army Miley: September 09, 2016 *fu* Claim-1: USPS RMN 322 398 225 US - Recv'd September 16, 2016

3) JCOS c/o CJCOS: August 23, 2017 *fu* Claim-1 & Claim-2, Claim-3: USPS RMN RE 322 399 132 US - Recv'd August 31, 2017

15 :DISHONOR means: man Jeff: fiduciary in the office of the USAG is in the breach of the duty. Documented in the USPS RMN RE 322 399 146 US: Jeff, acting in the role of the fiduciary: USAG, -January 2018 - Recv'd January 29, 2018

16 duty means: 'United States Government' under the CfUSofA contract

17 prejudice shown against the i:man means:

a) December 29, 2017: President Donald J. Trump Proclaims January 2018 as National Slavery ... Prevention Month, we recommit ourselves to eradicating the evil of enslavement.... In addition to these governmental actions, Americans must learn how to identify and combat the evil of enslavement....

:Letter: c/o Donald re: Dishonor Session/ Property: January 31, 2018 A.D. USPS RMN 322 399 150 US

2/3

2022-011769 MISC Page: 863 of 2782

09/26/2022 03:35:37 PM Receipt #: 22-9381

Rec Fee: \$30.00 Darrell James Hill

Gila County, Az, Sadie Jo Bingham, Recorder



:Holy Bible

Book of Proverbs: 1

- (10) My son, if sinners entice thee, consent thou not.
- (11) If they say, Come with us, let us lay wait for blood, let us lurk privily for the innocent without cause: (12) Let us swallow them up alive as the grave; and whole, as those that go down into the pit: (13) We shall find all precious substance, we shall fill our houses with spoil: (14) Cast in thy lot among us; let us all have one purse: (15) My son, walk not thou in the way with them; refrain thy foot from their path: (16) For their feet run to evil, and make haste to shed blood.
- (17) Surely in vain the net is spread in the sight of any bird.
- (18) And they lay wait for their own blood; they lurk privily for their own lives.
- (19) So are the ways of every one that is greedy of gain; which taketh away the life of the owners thereof.

acting in his criminal negligence in spite of his fiduciary duty.

i: man :Darrell-James: Hill am grieved and damaged by the willful apartheid-wrongdoings¹⁸ with the negligence to the sworn contract under the color of Law with the criminal breaches of the SLL and LL against this i:man.

With regard to the mute-answer of the three claims and protection of the fundamental right claims by the i:man is the fiduciary-acquiesced fee schedule for a remedy¹⁹ for the wrong doings against the rights and powers in the claims exercised. For the fee-schedule amounts due paid now see: January 2018 Itemized Bills: USPS RMN RE 322 399 146 US: January 2018.

:Many federal, state, and local official and people know of my private-property-claimed: authentication of my Almighty God- given rights-exercised is in the public records of the Recorder.gilacountyaz.gov, Gila County, Arizona, #2017-002378²⁰. Thus: this fraud, theft and dishonor by Jeff: USAG Sessions begins and end as FRAUD, THEFT AND DISHONOR.

:Jeff willfully violates my Almighty God-given – SLL and LL exercised and protected powers and rights with his, et al., STEALING and embezzlement of the millions of the dollars value of my property by a modern day slavery model with a modern day apartheid-governed by an 'ends justifies the means' evil negligence of duty. i:man discern him as a thief in the dishonor.

:Donald, for the short term survival of these wrongs is the fee-schedule of the payments due-now-paid and kept current until the private property is completely now stored to me; and, :i:man want now stored my private-property to the i:man :Darrell-James: Hill :son of the Most High God.

Shalom;

January 31, 2018

:Darrell-James: Hill
:Darrell-James: Hill, son of the Most High God,
i:man



b) December 20, 2017: Executive Order Blocking the Property of Persons Involved in Serious Human Rights Abuse or Corruption, ... Human rights abuse and corruption undermine the values that form an essential foundation of stable, secure, and functioning societies; have devastating impacts of individuals; weaken democratic institutions; degrade the rule of law; The United States seeks to impose tangible and significant consequences on those who commit serious human rights abuse or engage in corruption...

18 Apartheid wrongdoings means: 'deprivations of this man's rights (under the color of the laws)

19 fee schedule remedy means: acquiesced fee schedule for the negligence of the fiduciary authority: 1 oz. silver U.S. dollar/minute : August 16, 2016, Claim-1: USPS RMN RE 322 399 279 US – Recv'd October 31, 2016; November 16, 2016 /fu Claim-1: USPS RMN RB 898 810 007 US – Recv'd November 25, 2016; July 13, 2017 /fu Claim-2: USPS RE 322 399 101 US – Recv'd July 24, 2017

20 Letter to man Ranier; role; chief judge: USDC-Arizona, USPS CMN 700- 1410 0000 7868 5703: p. 610-

:Letter: c/o Donald re: Dishonor Session/ P

865

2022-011769 MISC Page: 864 of 2782

09/26/2022 03:35:37 PM Receipt #: 22-9381
Rec Fee: \$30.00 Darrell James Hill
Gila County, Az, Sadie Jo Bingham, Recorder



Registered No. RE322399150U9

Date Stamp

0130
77

APACHE JUNCTION
151 W SUPERSTITION BLVD
APACHE JUNCTION
AZ

85120-9998
0302590130
(800)275-8777

01/31/2018 2:06 PM

To Be Completed
By Post Office

Postage \$ 0.71
Extra Services & Fees
 Registered Mail \$12.60
 Return Receipt (hardcopy) \$2.75
 Return Receipt (electronic) \$0.00
 Restricted Delivery \$0.00

Extra Services & Fees
 Signature Confirmation
 Signature Confirmation Restricted Delivery
Total Postage & Fees \$16.06

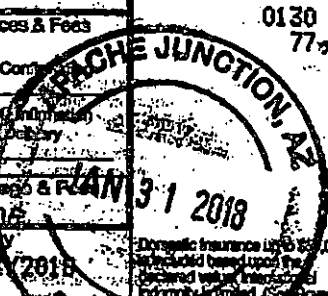

Customer Must Declare Full Value \$21.00

Received by 01/31/2018

Domestic Insurance up to \$5000 included based upon the declared value. Additional insurance must be purchased (See Reverse).

OFFICIAL USE

Product Description Sale Qty Final Price

First-Class Mail Letter 1 \$0.71

(Domestic)
(WASHINGTON, DC 20500)
(Weight: 0 Lb 1.80 Oz)
(Estimated Delivery Date)
(Saturday 02/03/2018)

Registered 1 \$12.60
(Amount: \$21.00)
(USPS Registered Mail #)
(RE322399150U9)

Return Receipt 1 \$2.75
(USPS Return Receipt #)
(9590940306765196708819)

Total \$16.06

Cash \$20.00
(\$3.94)

FROM: Apache Junction, AZ 85120
TO: 1600 Pennsylvania Ave NW, Washington, D.C. 20500

PS Form 3806, Registered Mail Receipt

Copy 1 - Customer

April 2015, PSN 7530-02-000-9051

(See Information on Reverse)

For domestic delivery information, visit our website at www.usps.com

PS Form 3811, April 2015, PSN 7530-02-000-0753. Includes return address, recipient address, and service type checkboxes.

If-service kiosks offer check-out. Any Retail show you how. ...king number to 28777 the latest status. ...ge and Data rates may also visit USPS.com or call 1-800-222-1811.

NE'S MAILBOX. Greeting
e for purchase at select

ent of evidence of

866

Psa 3:1-3 A Psalm of David, when he fled from Absalom his son. LORD, how are they increased that trouble me! many are they that rise up against me. 2 Many there be which say of my soul, There is no help for him in God. Selah. 3 But thou, O LORD, art a shield for me; my glory, and the lifter up of mine head.

:Darrell-James: Hill c/o PO Box 3806, Apache Junction, Arizona [85120] :USPS RMN RE 322 398 242 US :April 2018 A.D.

:Donald :appointed fiduciary²: Commander-in-Chief -
:military :Joseph :actor in the role of the JCOS General Dunford;
:Mark :actor in the role of the COS Army General Miley
c/o :Donald :actor in the role of the POTUS³ Trump 'United States government'⁴
1600 Pennsylvania Ave NW
Washington, D.C. 20500

NOTICE OF DEFAULT
Option to Cure Default

Donald, Greetings:

With in regard of the RMN 322 399 150 US DEMAND FOR THE FIDUCIARY PROTECTION OF FUNDAMENTAL RIGHTS re: DISHONOR: USPS RMN RE 322 399 146 US: man: Jeff: acting in the role of the AG-DOJ, i:man contacted you :man for the remedy from the apartheid of the God-given rights. YOU have silent-response to date in the resolve of this theft & trespass by your appointee. YOUR protection of my Almighty God-given rights is your role Against this modern day slavery Donald.

Donald, you can only serve one master. You can Not serve The Almighty God and mammon.

i:man demand the sum property of the three Claims: August 16, 2016, Claim: USPS RMN RE 322 399 279 US; February 17, 2017 Claim: USPS RMN RE 322 399 251 US; September 15, 2017 Claim: USPS RMN RE 322 399 248 US; AND, all fees for Claims Violations paid now, including but not limited to, 1.123.300' ~one Million One Hundred Twenty-Three Thousand Three Hundred: 1- Ounce .999 Silver U.S. Dollars as of January 09, 2018.

:You are obligated under the contract to forthrightly promote and protect Almighty God given rights UPON EXERCISE OF THE RIGHTS; thus: i contacted you man for the remedy from the Jeff's apartheid of the God-given rights.

Remedy for the daily ongoing injury to i is the direct and unfettered enforcement of my God-given rights: forthright 1) obtainment of the private-property detailed in the three registered claims, and 2) now payment of all fees now due and until the full resolve of the trespass upon each claim.

Option to Cure Default: You have two weeks before DISHONOR.

Sincerely:

Darrell-James: Hill

Darrell-James: Hill, man: Shioan

:day :13th:April: 2018

- 1 In the Correct-Sentence-Sense-Correct-Parse-Syntax-Grammar- prepositional phraseology
- 2 fiduciary means: 'person' to whom some other natural person's property or the management of that property is trusted
- 3 POTUS meant: 2012-2016: Barack; and means 2017-now: Donald: "The President of the United States".
- 4 'United States government' means: 'United States Incorporated', et seq., administrating "United States Government"... ~1958 unto now under 'the Constitution for the United States of America'.

:Letter :Donald :Notice of D

2022-011769 MISC Page: 866 of 2782
09/26/2022 03:35:37 PM Receipt #: 22-9381
Rec Fee: \$30.00 Darrell James Hill
Gila County, Az, Sadie Jo Bingham, Recorder



867

Registered No. RE32239824208

Date Stamp

01:30
07

APACHE JUNCTION
151 W SUPERSTITION BLVD
APACHE JUNCTION
AZ
85120-9998
0302590130
4/13/2018 (800)275-8777 11:34 AM

Postage \$ 00.71	Extra Services & Fees
Extra Services & Fees \$12.60	<input type="checkbox"/> Signature Confirmation
<input type="checkbox"/> Registered Mail \$	<input type="checkbox"/> Signature Confirmation
<input type="checkbox"/> Return Receipt (hardcopy) \$02.75	<input type="checkbox"/> Restricted Delivery
<input type="checkbox"/> Return Receipt (electronic) \$00.00	<input type="checkbox"/> Signature Confirmation
<input type="checkbox"/> Restricted Delivery \$	<input type="checkbox"/> Restricted Delivery
Total Postage & Fees \$16.03	
Customer Must Declare Full Value \$21.00	Received by 04/13/2018

Domestic insurance up to \$50,000 is included based upon the declared value. International indemnity is limited. (See Reverse).

Product Description	Sale Qty	Final Price
First-Class Mail Letter (Domestic) (WASHINGTON, DC 20500) (Weight:0 Lb 1.20 Oz) (Estimated Delivery Date) (Monday 04/16/2018)	1	\$0.71
Registered (Amount:\$21.00) (USPS Registered Mail #) (RE322398242US)	1	\$12.60
Return Receipt (USPS Return Receipt #) (9590940227857069618739)	1	\$2.75
Affixed Postage (Affixed Amount:\$0.03)	1	(\$0.03)
Total		\$16.03
Cash		\$16.03

OFFICIAL USE

APACHE JUNCTION

FROM	Darrell James Hill c/o PO Box 1825 Apache Junction, Arizona (85130)
TO	Washington, DC 20500
TO	Domestic FOTDS Tramp c/o 1400 Pennsylvania Ave NW Washington, D.C. 20004

PS Form 3808, Registered Mail Receipt

April 2015, PSN 7530-02-000-9051

Copy 1 - Customer

(See Information on Reverse)

For domestic delivery information, visit our website at www.usps.com

Next your tracking number to 28777 (USPS) to get the latest status. Standard Message and Data rates may apply. You may also visit USPS.com or USPS Tracking or call 1-800-222-1811.

In a hurry? Self-service kiosks offer quick and easy check-out. Any Retail Associate can show you how.

Use this receipt as evidence of insurance. For information on filing an insurance claim go to <https://www.usps.com/help/claims.htm>.

Unofficial

866



Psa 3:1-3 A Psalm of David, when he fled from Absalom his son. LORD, how are they increased that trouble me! many are they that rise up against me. 2 Many there be which say of my soul, There is no help for him in God. Selah. 3 But thou, O LORD, art a shield for me; my glory, and the lifter up of mine head.

:Darrell-James: Hill c/o PO.Box 3806, Apache Junction, Arizona [85120]

:USPS RMN RE 047 636 404 US

:Donald :appointed fiduciary²: Commander-in-Chief -
:military :Joseph :actor in the role of the JCOS General Dunford;
:Mark :actor in the role of the COS Army General Miley
c/o :Donald: POTUS³ Trump 'United States government'
1600 Pennsylvania Ave NW
Washington, D.C. 20500

:DISHONOR

Donald, Greetings:

For the regard of the RMN 322 399 150 US DEMAND FOR THE FIDUCIARY PROTECTION OF FUNDAMENTAL RIGHTS re: DISHONOR: USPS RMN RE 322 399 146 US: man: Jeff: acting in the role of the AG-DOJ, and: USPS RMN RE 322 398 242 US :April 2018 A.D.: NOTICE OF DEFAULT Option to Cure Default sent to you, et al., all responses have been silence.
Upon this mailing you are in DISHONOR.

Sincerely:

:day : 21th :May: 2018

Darrell-James: Hill, man,



- 1 In the Correct-Sentence-Sense-Correct-Parse-Syntax-Grammar- prepositional phrasology
- 2 fiduciary means: 'person' to whom some other natural person's property or the management of that property is trusted
- 3 POTUS meant: 2012-2016: Barack; and means 2017-now: Donald: "The President of the United States".
- 4 'United States government' means: 'United States Incorporated', et seq., administrating "United States Government"... ~1958 unto now under 'the Constitution for the United States of America'.

:Letter :Donald :Notice of De

2022-011769 MISC Page: 868 of 2782
09/26/2022 03:35:37 PM Receipt #: 22-9381
Rec Fee: \$30.00 Darrell James Hill
Gila County, Az, Sadie Jo Bingham, Recorder



:Holy Bible

Book of Proverbs: 1

(10) My son, if sinners entice thee, consent thou not.
(11) If they say, Come with us, let us lay wait for blood, let us lurk privily for the innocent without cause: (12) Let us swallow them up alive as the grave; and whole, as those that go down into the pit: (13) We shall find all precious substance, we shall fill our houses with spoil: (14) Cast in thy lot among us; let us all have one purse: (15) My son, walk not thou in the way with them; refrain thy foot from their path: (16) For their feet run to evil, and make haste to shed blood.
(17) Surely in vain the net is spread in the sight of any bird.
(18) And they lay wait for their own blood; they lurk privily for their own lives.
(19) So are the ways of every one that is greedy of gain; which taketh away the life of the owners thereof.

:Darrell-James: Hill c/o PO Box 3806, Apache Junction, Arizona 85120

USPS RMN 322 399 150 US :January 31, 2018 A.D.

:Donald :appointed fiduciary²: Commander-in-Chief -

:military :Joseph :actor in the role of the JCOS General Dunford;

:Mark :actor in the role of the COS Army General Miley

c/o :Donald :actor in the role of the POTUS³ Trump 'United States government'⁴

1600 Pennsylvania Ave NW

Washington, D.C. 20500

DEMAND FOR THE FIDUCIARY PROTECTION OF FUNDAMENTAL RIGHTS

Re: DISHONOR: USPS RMN RE 322 399 146 US: Jeff actor in the role of the fiduciary United States Attorney General Sessions, 'USAG', -January 2018 – Recv'd January 29, 2018

**W/ Re: Claims: August 16, 2016, CLAIM: USPS RMN RE 322 399 279 US;
February 17, 2017 CLAIM: USPS RMN RE 322 399 251 US;
September 15, 2017 CLAIM: USPS RMN RE 322 399 248 US; and:**

Bills: CLAIMS VIOLATIONS (3): January 09, 2018: ITEMIZED BILLS TOTAL DUE-NOW-PAID is: '1,123,300' ~one million one hundred twenty-three thousand three hundred: 1- ounce .999 silver U.S. dollars.

Dear Donald, Greetings:

i: man¹: Darrell-James: Hill in the claim of my Almighty God- given rights by the exercise of the rights made correct claims for the obtainment of my⁶ private-property⁷ ⁸ protected by the Supreme Law of the

- 1 In the Correct-Sentence-Sense-Correct-Parse-Syntax-Grammar- prepositional phraseology**
- 2 fiduciary means: 'person' to whom some other natural person's property or the management of that property is trusted**
- 3 POTUS meant: 2012-2016: Barack; and means 2017-now: Donald: "The President of the United States".**
- 4 'United States government' means: 'United States Incorporated', et seq., administrating "United States Government"... ~1958 unto now under 'the Constitution for the United States of America'.**
- 5 i: man, i:man means: Almighty God's: man of the people of the nation states of America, "The United States of America"**
- 6 i:man is: one of the people of The United States of America and owner of the private-property by the showing of the claim**
- 7 August 16, 2016, CLAIM: USPS RMN RE 322 399 279 US;
February 17, 2017 CLAIM: USPS RMN RE 322 399 251 US; and,
September 15, 2017 CLAIM: USPS RMN RE 322 399 248 US**
- 8 For the Claim Trespasses is: January 09, 2018- ITEMIZED BILLS TOTAL DEBT DUE-PAID Now: 1,123,3006 ~one million one hundred twenty-three thousand three hundred: 1- ounce .999 silver U.S. dollars.**

:Letter: c/o Donald re: Dishonor Session/ Property: January 31 2018 A.D. USPS RMN 322 399 150 US

863

2022-011769 MISC Page: 862 of 2782
09/25/2022 03:35:37 PM Receipt #: 22-9381
Rec Fee: \$30.00 Darrell James Hill
Gila County, Az. Sadie Jo Bingham, Recorder



Registered No. RE322399132

Date Stamp

APACHE JUNCTION
151 W SUPERSTITION BLVD
APACHE JUNCTION
AZ
85120-9998
0302590130
08/23/2017 (800)275-8777 12.26 PM

Reg. Fee	\$1.61	Return Receipt	
Handling Charge	\$12.50	Restricted Delivery	
Postage	\$2.75	Received by	\$0.00
			\$16.86
Customer Must Declare Full Value \$21.00		Date of Declaration 08/23/2017	

Product Description	Sale Qty	Final Price
First-Class Mail Large Envelope (Domestic) (WASHINGTON, DC 20318) (Weight: 0 Lb 4.00 Oz) (Expected Delivery Day) (Saturday 08/26/2017)	1	\$1.61
Registered (Amount: \$21.00) (USPS Registered Mail #) (RE322399132US)	1	\$12.50
Return Receipt (USPS Return Receipt #) (9590940220736132033891)	1	\$2.75

OFFICIAL USE

FROM: Darrell James Hill, c/o P.O. Box 3806, Apache Junction, Arizona 85120

TO: [Redacted]

PS Form 3806, Receipt for Registered Mail May 2007 (7530-02-000-9051) For domestic delivery information, visit our website at www.usps.com

Total \$16.86

Cash Change \$20.00

In a hurry? Self-service kiosks offer quick and easy check-out. Any Retail Associate can show you how.

Text your tracking number to 2877 (2USPS) to get the latest status. Standard Message and Data rates may apply. You may also visit USPS.com, USPS Tracking or call 1-800-222-1877.

BRIGHTEN SOMEONE'S MAILBOX. Greeting cards available for purchase at Post Offices.

SENDER: COMPLETE THIS SECTION

1. Article Addressed to: [Redacted]

COMPLETE THIS SECTION ON DELIVERY

A. Signature: [Signature]

B. Received by (Print Name): [Signature]

C. Date of Delivery: 08-23-2017

D. Is delivery address different from item 1? [] Yes [] No

E. Service Type: [] Adult Signature [] Certified Mail [] Collect on Delivery [] Insured Mail [] Registered Mail [] Return Receipt for Merchandise [] Signature Confirmation [] Signature Confirmation Restricted Delivery [] Priority Mail Express [] Registered Mail [] Restricted Mail Restricted Delivery [] Return Receipt for Merchandise [] Signature Confirmation [] Signature Confirmation Restricted Delivery

9590 9402 2073 6132 0338 91

RE 322 399 132 US

PS Form 3811, July 2015 PSN 7530-02-000-8053

Uno

First-Class 1 \$2.24

Mail

Large Envelope

(Domestic)
(WASHINGTON, DC 20535)
(Weight: 0 Lb 6.10 Oz)
(Expected Delivery Day)
(Monday 07/17/2017)

Registered 1 \$11.70

(Amount: \$0.00)
(@USPS Registered Mail #)
(RE322399075US)

Return 1 \$2.75

Receipt
(@USPS Return Receipt #)
(9590940220736132026978)

First-Class 1 \$2.03

Mail

Large Envelope

(Domestic)
(WASHINGTON, DC 20530)
(Weight: 0 Lb 6.00 Oz)
(Expected Delivery Day)
(Monday 07/17/2017)

Registered 1 \$11.70

(Amount: \$0.00)
(@USPS Registered Mail #)
(RE322399089US)

Return 1 \$2.75

Receipt
(@USPS Return Receipt #)
(9590940220736132026985)

First-Class 1 \$2.03

Mail

Large Envelope

(Domestic)
(PHOENIX, AZ 85004)
(Weight: 0 Lb 5.80 Oz)
(Expected Delivery Day)
(Saturday 07/15/2017)

Certified 1 \$3.35

(@USPS Certified Mail #)
(70150640000158832655)

Return 1 \$2.75

Receipt
(@USPS Return Receipt #)
(9590940220736132026961)

Bill #: 840-58520028-4-1691414-2

Clerk: 02

Registered No. RE322399075US

To Be Completed By Post Office	Postage \$ \$2.24	Extra Services & Fees (max \$3)
	Extra Services & Fees \$ \$11.70	<input type="checkbox"/> Signature Confirmation
	<input type="checkbox"/> Registered Mail \$ \$0.00	<input type="checkbox"/> Signature Confirmation Restricted Delivery
	<input type="checkbox"/> Return Receipt (hardcopy) \$ \$2.75	<input type="checkbox"/> Signature Confirmation Restricted Delivery
	<input type="checkbox"/> Return Receipt (electronic) \$ \$0.00	Total Postage & Fees \$ \$16.69
	<input type="checkbox"/> Restricted Delivery \$ \$0.00	Customer Must Declare Full Value \$ \$0.00
		Received by 07/13/2017 RWS

APACHE JUN
JUL 13 2017

OFFICIAL USE

FROM: Darrell James Hill
c/o 5124 East 15th Avenue,
Apache Junction, Arizona (85119)
85120

TO: Acting Director, FBI
45 Andover, Deputy Director McClellan
Washington, DC 20535-3000
7. Edgar Hoover Building
925 Pennsylvania Avenue NW
Washington, District of Columbia 20535-3000

PS Form 3806, Registered Mail Receipt
April 2015, PSN 7530-02-000-9051
For domestic delivery information, visit our website at www.usps.com

Copy 1 - Customer
(See Information on Reverse)

Registered No. RE322399089US

To Be Completed By Post Office	Postage \$ \$2.03	Extra Services & Fees (max \$3)
	Extra Services & Fees \$ \$11.70	<input type="checkbox"/> Signature Confirmation
	<input type="checkbox"/> Registered Mail \$ \$0.00	<input type="checkbox"/> Signature Confirmation Restricted Delivery
	<input type="checkbox"/> Return Receipt (hardcopy) \$ \$2.75	<input type="checkbox"/> Signature Confirmation Restricted Delivery
	<input type="checkbox"/> Return Receipt (electronic) \$ \$0.00	Total Postage & Fees \$ \$16.48
	<input type="checkbox"/> Restricted Delivery \$ \$0.00	Customer Must Declare Full Value \$ \$0.00
		Received by 07/13/2017 RWS

PHOENIX JUL 13 2017

OFFICIAL USE

FROM: Darrell James Hill
c/o 5124 East 15th Avenue,
Apache Junction, Arizona (85119)
85120

TO: Michael E. Barwick, IC-DOJ
UACB
1425 New York Avenue, N.W., Suite 7100
Washington, District of Columbia 20530-3011

PS Form 3806, Registered Mail Receipt
April 2015, PSN 7530-02-000-9051
For domestic delivery information, visit our website at www.usps.com

Copy 1 - Customer
(See Information on Reverse)

Unofficial

825



refuses or neglects to make or forward any report, certificate, statement, or document as required by law, shall be fined under this title or imprisoned not more than one year, or both. 18 U.S.C. § 2076 – Clerk of United States District Court. 62 Stat. 796; 110 Stat. 3498.

- 100 commercial means: relating to or connected with trade and traffic or commerce in general[;] in the nature of "Zante Currents", C.C.Cal., 73 F. 189. Occupied-with-commerce[;] in the nature of Bowles v. Co-Operative G. I. F. Farm Products, D.C.N.Y., 53 F.Supp. 413, 415[;] Black's Law Dictionary, 4th Ed., p337.
- 101 complaint means: In civil practice. ... [T]he complaint is the first or initiatory pleading on the part of the plaintiff in a civil action. It corresponds to the declaration in the common law practice. Code N.Y. § 141; et seq.; Black's Law Dictionary, 4th Ed., p356.
- 102 commercial complaint means: USDC-AZ: CV-17-00026-PHX-BSB
- 103 28 U.S. Code § 955. Practice of law restricted. The clerk of each court and his deputies and assistants shall not practice law in any court of the United States. Subject to 18 U.S.C. § 205 – Activities of officers and employees in claims against and other matters affecting the Government. See also: 18 U.S.C. §§ 242, 241
- 104 intent means: Design, resolve, or determination with which [a man] acts; in the nature of Winters v. United States, 106 F.2d 837, et seq.; Black's Law Dictionary, 4th Ed., p. 947.
- 105 The BORights-1789-91: Article Eleven - Ninth Amendment
"The enumeration in the constitution, of certain rights, shall not be construed to deny or disparage others retained by the people." Const.-1787 & BORights-1789-91: Article the eleventh [Amendment IX]

The enumeration in this [Arizona state] Constitution of certain rights shall not be construed to deny others retained by the people. Article 2, § 33.

Rather than enunciating particular affirmative right, Ninth Amendment serves to protect other fundamental rights that are not set forth in Constitution. U.S. v. Vital Health Products, Ltd., E.D.Wis.1992, 786 F.Supp. 761, affirmed 985 F.2d 563.

The Ninth Amendment is not a substantive source of constitutional guarantees, but was drafted to cope with the problem created by the enumeration of specific rights in the bill of rights, to avoid lowering, degrading or rejecting any rights not specifically mentioned in the Bill of Rights. Schertz v. Wauapaca County, E.D.Wis.1988, 683 F.Supp. 1551, affirmed 875 F.2d 578.

The BORights-1789-91: Article Twelve -Tenth Amendment

"The powers not delegated to the United States by the Constitution, nor prohibited by it to the States, are reserved to the States respectively, or to the people. Const.-1787 & BORights-1789-91: Article the Twelfth [Amendment X].

In determining whether challenged power has been constitutionally exercised, conditions to which power is addressed must be considered, but extraordinary conditions do not create or enlarge constitutional power and cannot justify action which lies outside sphere of constitutional authority. A.L.A. Schechter Poultry Corporation v. U.S., U.S.N.Y.1935, 55 S.Ct. 837, 295 U.S. 495, 79 L.Ed. 1570, 2 O.G. 493.

- 106 compensation due agreement means: agreed compensation payable to claimant upon trespass on the case means: one ounce silver dollar cumulative per minute from the beginning to the ending of the trespass on the case. See 'Initial Filing' "Notice to Officers of the Court" at Gila County Recorder – site: <http://recorder.gilacountyaz.gov/recorder/web/DocumentNumber:2017-002378>, pp. 192-194.
- 107 activated meaning: trespass on the case
- 108 trespass means: direct injury to persons or property whether willful or accidental
- 109 trespass on the case means: At common law, an action to recover damages that are not the immediate result of a wrongful act but rather a later consequence; Black's Law 7th Ed, p. 1508-9.
- 110 Gross- trespass on the case means: 1) [W]hile statutes enjoy the presumption of constitutionality, "delegations of legislative power are valid only if they establish specific policies and fix definite standards to guide the official, agency, or board in the exercise of the power. Delegations of legislative power which lack such policies and standards are unconstitutional and void." (citing Ames v. Town of Painter, 389 S.E.2d 702, 705) Bell v. Dorey Elec. Co. 448 S.E.2d 627[;] moreover,
2) Though the court may think an Act of Congress embodies a commendable social plan and are in sympathy with its purpose and intended result, if its provisions go beyond the limits of federal power and extend into the field of power reserved to the states [or the people], the court must so declare. Davis v. Boston & M. R. Co., C.C.A.1 (Mass.) 1937, 89 F.2d 368.
- 111 felony means: a serious crime, "...of a graver or more atrocious nature than those designated as misdemeanors[;] in the

Page: 818 of 2782
Receipt #: 22-9381

2022-011769 MISC
09/26/2022 03:35:37 PM
Rec Fee: \$30.00 Darrell James Hill
Gila County, Az, Sadie Jo Bingham, Recorder

819



- legislation' of the ICCPR Treaty provisions is the Court-1787 and the BORights-1789-91.
- 78 SELF-OPERATING means: A treaty is generally self-operating in that it requires no legislation by either Congress or the state. *Amaya v. Stanolind Oil & Gas Co., C.C.A.5 (Tex.) 1946, 158 F.2d 554, certiorari denied 67 S.Ct. 1191, 331 U.S. 808, 91 L.Ed. 1828, rehearing denied 67 S.Ct. 1530, 331 U.S. 867, 91 L.Ed. 1871.*
 - 79 SELF-EXECUTING means: "Self-executing treaty" is one that becomes domestic law of signatory nation without implementing legislation, and provides private right of action to individuals alleging breach of its provisions. *U.S. v. Noriega, S.D.Fla.1992, 808 F.Supp. 791.*
 - 80 "Statutory construction must begin with the language employed by Congress and the assumption that the ordinary meaning of that language accurately expresses the legislative purpose." *Park N Ft, Inc. v. Dollar Park & Ft, Inc., 469 U.S. 189, 194, 105 S.Ct. 658, 83 L.Ed.2d 582 (1985).* That assumption, however, does not apply where Congress (or the Courts) provides a statutory definition. See *United States v. Mohrbacher, 182 F.3d 1041, 1048 (9th Cir.1999)* (holding that in the absence of a statutory definition, a term should be accorded its ordinary meaning); in that nature of: *U.S. v. Havelock, 664 F.3d 1284 (2012).*

Supremacy of [the] Constitution [for the United States of America] over treaties also applies to executive agreements. *Holmes v. Laird, C.A.D.C.1972, 459 F.2d 1211, 148 U.S.App.D.C. 187, certiorari denied 93 S.Ct. 197, 402 U.S. 869, 34 L.Ed.2d 120.*

- 81 State Party means: the United States Government for the United States of America
- 82 ICCPR Treaty: Article 2(2). "Where not already provided for by existing legislative or other measures, each State Party to the present Covenant undertakes to take the necessary steps, in accordance with its constitutional processes and with the provisions of the present Covenant, to adopt such laws or other measures as may be necessary to give effect to the rights recognized in the present Covenant."
- 83 abridgment means: abridge: to reduce or contract; usually spoken of written language.
- 84 legal abridgment means: effect of the legal creation of personages under terms such as "homeowner" or "driver" possessing civil rights and privileges conferred by and subject to law system creating it, and to whom obedience and allegiance is pledged/ presumed. This: 1) is a choice of man in his political self-determination, even if unwitting, and this choice 2) reduces man's full fundamental-inalienable rights and freedoms.
- 85 ICCPR Treaty, Article 1(1). "All people have the right of self-determination. By virtue of that right they freely determine their political status and freely pursue their economic, social and cultural development."
- 86 ICCPR Treaty, Article 14(1). "All persons shall be equal before the courts and tribunals. In determination of ...his rights and obligations in a suit at law, everyone shall be entitled to a fair and public hearing by a competent, independent and impartial tribunal established by law."
- 87 ICCPR Treaty, Article 1(2). "All peoples may, for their own ends, freely dispose of their natural wealth and resources without prejudice to any obligations ... based upon the principle of mutual benefits.... In no case may a people be deprived of its own means of subsistence."
- 88 ICCPR Treaty, Article 47. "Nothing in the present covenant shall be interpreted as impairing the inherent right of all peoples to enjoy and utilize fully and freely their natural wealth and resources."
- 89 color of law means: appearance of truth, likelihood, validity, or right; justification; an initially apparent or prima-facie right; a sufficient warrant for action; as, color of title. See: Gila County Recorder - site: <http://recorder.gilacountyaz.gov/recorder/web/> Document Number: 2017-002378, pg 193, subscript 12.
- 90 Though the court may think an Act of Congress embodies a commendable social plan and are in sympathy with its purpose and intended result, if its provisions go beyond the limits of federal power and extend into the field of power reserved to the states [or the people], the court must so declare. *Davis v. Boston & M. R. Co., C.C.A.1 (Mass.) 1937, 89 F.2d 368.*
- 91 obligation means: The binding power of a vow, promise, oath, or contract, or of law, civil, political, or moral, independent of a promise; that which constitutes legal or moral duty, and which renders a person liable to coercion and punishment for neglecting it. Webster.
At tie which binds us to pay or do something agreeably to the laws and customs of the country in which the obligation is made. Inst. 3, 14
- 92 breach means: The breaking or violating of a law, right, or duty, either by commission or omission. Black's Law Dictionary, 4th Ed., p. 235.
- 93 dishonor means: discredit. A Notice given by the secured party to the debtor party, that the debtor party has been discredited as not honorable by nonacceptance on presentment for acceptance, or by nonpayment, etc., of an obligation due.
- 94 estoppel means: to stop, bar or hinder a man's act, especially in a legal sense, based upon his own prior acts or declarations
- 95 estoppel by silence means: A condition that arises where a person is under duty to another to speak or failure to speak is inconsistent with honest dealings;[] in the nature of *In re McArdle's Estate, 250 N.Y.S. 276, 287, et seq.; Black's Law*

U
817

2022-011769 MISC Page: 816 of 2782
09/26/2022 03:35:37 PM Receipt #: 22-9381
Rec Fee: \$30.00 Darrell James Hill
Gila County, Az, Sadie Jo Bingham, Recorder



All political power is inherent in the people, and governments derive their just powers from the consent of the governed, and are established to protect and maintain individual rights and freedoms. Arizona State Constitution, Article 2 § 2.

JUSTICE MATTHEWS. In the opinion of the court[.] re: Yick Wo v. Hopkins, wrote: "When we consider the nature and the theory of our institutions of government, the principles upon which they are supposed [370] to rest, and review the history of their development, we are constrained to conclude that they do not mean to leave room for the play and action of purely personal and arbitrary power. Sovereignty itself is, of course, not subject to law, for it is the author and source of law; but, in our system, while sovereign powers are delegated to the agencies of government, sovereignty itself remains with the people, by whom and for whom all government exists and acts. ... Yick Wo v. Hopkins, 118 U.S. 256.

54 See: Commonwealth Of Puerto Rico v. Valle : SCOTUS; No. 15-108 (08/15/2015): Puerto Rico Is Not "Sovereign" Because There Is No Such Thing As A Sovereign Territory, pp. 25-28. The people of the United States of America in creation of the Government under the Constitution for the United States of America did not create a sovereign government over but clearly under, and in service to, the people.

55 "The rule in America is that the American people are the sovereigns, and in them is lodged all power, and the agencies of government possess no authority save that which is delegated to them by the people in the written compact entered into between the people, which is styled in the Constitution...." Kemper v. State, 138 S.W. 1025, 1043

The sovereignty of the United States [government] resides in the people, and Congress cannot invoke the sovereignty of the people to override their will as declared in the Constitution. Perry v. U.S. 294 U.S. 380, 353

56 birth means: the act of being born* or wholly brought into separate existence. Wallace v. State, 10 Tex. App. 270[.] Black Law Dict.. 4th Ed., p 213. born* brought into life or existence[.] Webster's New 20th Century Unabridged, 2nd Ed., p. 211.

57 certificate means: I) a written or printed statement testifying to a fact, qualification, or promise[.] Webster's New 20th Century Unabridged, 2nd Ed., p. 297. II) A written assurance made or issuing from some court, and designed as a notice of things done therein ... [.] in the nature of people v. Foster, 27 Misc. Rep. 576, et seq. III) a "certificate" by a public officer is a statement written and signed, but not necessarily or customarily sworn to, which is by law made evidence of the truth of the facts stated for all or for certain purposes[.] in the nature of State v. Abernethy, 190 N.C. 768, et seq.; Black Law Dict.. 4th Ed., p 285. See Exhibit Two

58 sui juris means: of full legal age and capacity

59 de jure means: of or from right of law: legitimate

60 The Ohio Constitution, Preamble. We, the people of the State of Ohio, grateful to Almighty God for our freedom, to secure its blessings and promote our common welfare, do establish this Constitution. Article I: Bill of Rights, Inalienable Rights. §1 of 21. All men are, by nature, free and independent, and have certain inalienable rights, among which are those of enjoying and defending life and liberty, acquiring, possessing, and protecting property, and seeking and obtaining happiness and safety.

Arizona State Constitution, Preamble. We the people of the State of Arizona, grateful to Almighty God for our liberties, do ordain this Constitution. Article II. Declaration of Rights: 1. Fundamental principles; recurrence to, Section 1. A frequent recurrence to fundamental principles is essential to the security of individual rights and the perpetuity of free government. 2. Political power; purpose of government, Section 2. All political power is inherent in the people, and governments derive their just power from the consent of the governed, and are established to protect and maintain individual rights.

The Declaration of Independence, 1776, para 2. line. We hold these truths to be self-evident, that all men are created equal, that they are endowed by their Creator with certain unalienable Rights, that among these are Life, Liberty and the pursuit of Happiness.

That to secure these rights Governments are instituted among Men, deriving their just powers from the consent of the governed.

61 The Supremacy Clause On The Const-1787, Article 6, Clause 2

"This Constitution, and the Laws of the United States which shall be made in Pursuance thereof; and all Treaties made, or which shall be made, under the Authority of the United States, shall be the supreme Law of The Land, and the Judges in every State shall be bound thereby, any Thing in the Constitution or Laws of any State to the Contrary notwithstanding."

Const-1787 Article IV, Section. 4. The United States shall guarantee to every State in this Union a Republican Form of Government,

815



America, in congress assembled, ... Articles, which when ratified* ... to be valid to all intents and purposes, as part of the said Constitution; *The first ten Amendments (BORights) were ratified effective December 15, 1791.

[The] Framers intended for the first ten amendments to act as restraints only upon the exercise of power by the new, national government.... Alabama Educ. Assn v. Bentley, 788 F.Supp.2d 1283.

As Justice Robert H. Jackson once wrote, [t]he very purpose of a Bill of Rights was to withdraw certain subjects from the vicissitude* of political controversy, to place them beyond the reach of majority 775 and officials and to establish them as legal principles to be applied by the courts. One's right to life, liberty, and property, to free speech, a free press, freedom of worship and assembly, and other fundamental rights may not be submitted to vote; they depend on the outcome of no elections[;] West Virginia Bd. of Ed. v. Barnette, 319 U.S. 624, 638, 63 S.Ct. 1178, 87 L.Ed. 1628 (1943); see e.g. Weinberger v. Wiesenfeld, 420 U.S. 636, 638 n. 2, 95 S.Ct. 1225, 43 L.Ed.2d 514 (1975) (stating that the right to equal protection is incorporated within the Fifth Amendment's Due Process Clause).
vicissitude* means: change or variation occurring irregularly in the course of something; especially, change of circumstances in life; ups and downs of fortune. Webster's New 20th Century Unabridged, 2nd (1983), p. 2036

- 23 covenant means: [A contractual] agreement, convention, or promise of two or more parties, by deed in writing, signed, sealed, and delivered, by which either of the parties pledges himself to the other that something is either done or shall be done or stipulates for the truth of certain facts[;] in the nature of Commonwealth v. Robinson, 1 Watts, Pa. 160; et seq; Black's Law Dictionary, 4th Ed., p. 436.
- 24 civil means: Originally, pertaining or appropriate to a member of a civitas or free political community; natural or proper to a citizen. Also, relating to the community, or to the policy and government of the citizens and subjects of a state. Black's Law Dictionary, 4th Ed., p. 311.
- 25 political means: polity: The form of government; civil constitution.
- 26 International Covenant on Civil and Political Rights means: the covenant adopted and opened for signature, ratification and accession by General Assembly resolution 2200A (XXI) of 16 December 1966 entry into force 23 March 1976, in accordance with Article 49, "ICCPR".
- 27 ICCPR Treaty ratification 1992 means: "U. S. reservations, declarations, and understandings, International Covenant on Civil and Political Rights, 138 Cong. Rec. S4781-01 (daily ed, April 2, 1992) -- IX. TEXT OF RESOLUTION OF RATIFICATION . See Exhibit One.
- 28 impose means: inflict by force or authority
- 29 Public Policy means: the community common sense and common conscience extended and applied throughout the state to matter of public morals, public health, public safety, public welfare, and the like; it is the general and well-settled public opinion relating to man's plain, palpable duty to his fellow men having due regard to all the circumstances of each particular relation and situation[;] in the nature of Pittsburgh, c. & St. L. Ry. Co. v. Kinney, 95 Ohio St. 64, et seq. Public policy properly cognizable by courts is that derived or derivable by clear implication from its Constitution, statutes, and judicial decisions[;] in the nature of Brown v. American Ry. Express Co., 128 S.C. 428, et seq.; Black's Law Dictionary, 4th Ed, p. 1318.
- 30 exercise means: to make use of. Thus, to exercise a right or power is to do something which it enables the holder to do[;] in the nature of U.S. v. Sanders, 27 Fed. Cas. 1267, et seq.; Black's Law Dictionary, 4th Ed, p. 682.
- 31 Initial Claim means: filing for court of record common law claim with trial by jury to decide matters of both fact and law: NOTICE: CLAIM RE: Property disposed.... See at Gila County Recorder - site: <http://recorder.gilacountynaz.gov/recorder/web/> Document Number: 2017-002378, pp. 241-549 .
- 32 common law means: 1. As distinguished from the Roman law, the modern civil law, the canon law and other systems, the common law is that body of law and juristic theory which was originated, developed and formulated ...[;] in the nature of Lux v. Huggin, 69 Cal. 255, et seq. As distinguished from law created by enactment of legislatures, the common law comprises the body of those principles and rules of action, relating to the government and security of persons and property, which derive their authority solely from usages and customs of immemorial antiquity, or from the judgments and decrees of the courts recognizing, affirming, and enforcing such usages and customs; and, in this sense particularly the ancient unwritten law of England[;] in the nature of 1 Kent, Comm. 492. Western Union Tel. Co. v. Call Pub. Co., 21 S. Ct. 56, et seq.; Black's Law Dictionary, 4th Ed., pp. 345-346.
- 33 law means: all the rules of conduct established and enforced by the authority, legislation, or custom of a given community or other group.... Law implies a penalty or inconvenience for disobedience, and also generality of application as distinguished from a special command.... Webster's 20th Century Unabridged, 2nd Ed., p. 1028.
- 34 trial means: a judicial examination, in accordance with law of the land, of a cause, either civil or criminal, of the issues between the parties, whether of law or fact, before a court that has jurisdiction over it[;] in the nature of People v. Vitale, 364 Ill. 589, et seq.; Black's Law Dictionary, 4th Ed., p. 1675.
- 35 trial-by-jury means: the terms "jury" and "trial by jury" as used in the constitution, means twelve competent men, disinterested and impartial, not of kin, nor personal dependents of either or the parties, who shall sit at their homes within the

U

813



Donald

Registered No. **RE047636404US**

Postage \$ **\$0.50**

Extra Services & Fees **\$12.60**

Return Receipt (hardcopy) \$ **\$2.75**

Return Receipt (electronic) \$ **\$0.00**

Restricted Delivery \$ **\$0.00**

Customer Must Declare Full Value **\$21.00**

Date Stamp: **APACHE JUNCTION, AZ**
MAY 29 2018
01 30 77

Signature Confirmation
Signature Confirmation Restricted Delivery

Total Postage & Fees **\$15.85**

Received by **05/29/2018**

Domestic Insurance up to \$50,000 is included based on the declared value. International liability is limited. (See Reverse).

OFFICIAL USE

APACHE JUNCTION, AZ 85120

FROM: Darrell James Hill
c/o PO Box 3804
Apache Junction, Arizona (85120)

TO: Darrell James Hill
c/o PO Box 3804
Washington, D.C. 20508

Form 3806, Registered Mail Receipt
Copy 1 - Customer

APACHE JUNCTION
151 W SUPERSTITION BLVD
APACHE JUNCTION
AZ
85120-9998
0302590130
(800)275-8777

05/29/2018 12:47 PM

Product Description	Sale Qty	Final Price
First-Class Mail Letter (Domestic) (WASHINGTON, DC 20500) (Weight: 0 Lb 0.50 Oz) (Estimated Delivery Date) (Friday 06/01/2018)	1	\$0.50
Registered (Amount: \$21.00) (USPS Registered Mail #) (RE047636404US)	1	\$12.60
Return Receipt (USPS Return Receipt #) (9590940306765196708901)	1	\$2.75
Total		\$15.85
Cash Change		\$50.00 (\$34.15)

Text your tracking number to 28777 (2USPS) to get the latest status. Standard Message and Data rates may apply. You may also visit www.usps.com USPS Tracking or call 1-800-222-1811.

In a hurry? Self-service kiosks offer quick and easy check-out. Any Retail Associate can show you how.

Save this receipt as evidence of

Unofficial

868



:BILL OF COSTS:

State of Arizona

County of Pinal

Darrell-James: Hill personally presents before me, the undersigned Notary, duly authorized by the laws of the State of Arizona to administer oaths; now on this 18th day July month, 2018: 3 : 10 am, 6 pm, being by me first duly sworn on his affirmation, affiant deposes and says:

With the regard to the Trespass on the Case: Common Law Claim #: CMN 7009 1410 0000 7868 5703; filed on the January 4th, 2017: USPS RE 322 399 336 US : you, Ranier and Brian are now mailed:

Ranier: Chief Judge,
USDC; District of Arizona
Evo A. DeConcini U.S. Courthouse
405 West Congress Street, Suite 5190
Tucson, Arizona [85701]
520-20504540 –

Brian: Clerk of Court
USDC; District of Arizona – Phoenix Div,
Sandra Day O'Conner U.S. Courthouse, Ste. 130
401 Washington Street, SPC 1
Phoenix, Arizona [85003-2118]
602-322-7200 –

USPS CMN 7017 1000 0000 9343 0704 ; and: USPS CMN 7015 1730 0002 3063 9300 ; that,

By your choice, since January 4th, 2017; the: Darrell-James: Hill, man, declaration for the common-law claim-executed, Case # CMN 7009 1410 0000 7868 5703 is Not yet filed – instead, you illegally and forcibly filed a civil action trick – in the despite of the clear execution of the Almighty-God-Given Constitutionally-protected right to the common-law action demanded, and with your acceptance of the fee-schedule for the “trespass on the case” of the “one-ounce U.S. silver dollar per minute”, and for the fact that i:man do not consent to your actions to not file the common law case ordered. To wit: your illegal forcing of the common law claim of: i: man into a civil action deception is wrong-doing trespass upon the case of the common law action ordered.

Wherefore, on March 9th, 2017: you received invoices for the fee-schedule amounts agreed due for your choice of the trespass upon the case of: i: man – See: Ranier – USPS CMN 7015 0640 0001 5883 2617 and Brian – 7015 0640 0001 5883 2600 – for the amount due on the April 6th, 2017: Eighty-three thousand, eight hundred ninety-three, “83,893”, – one ounce U.S. Silver dollars.

Now: July 19th, 2018: this bill, due payable per our agreement for the continued trespass on the case is: Eight hundred ninety-three thousand two hundred twenty, “893,220”, one-ounce U.S. silver dollars owed as described below.

Line	Trespass Upon Case	Time period	Fee-schedule: 1 oz. U.S. Silver dollar/ minute	Quantity minutes	Quantity silver dollars
1	“ “	01/06/2017: 10:30a 01/31/2017: 5:30p	“ “	36420	36420
2	“ “	01/31/2017: 5:30p 02/28/2017; 5: 30p	“ “	40320	40320
3	“ “	02/28/2017; 5: 30p 03/31/2017; 5: 30p	“ “	44640	44640
4	Trespass Upon Case	03/31/2017; 5: 30p 04/30/2017; 5: 30p	1 oz. U.S. Silver dollar/ minute	43200	43200
5	“ “	04/30/2017; 5: 30p 05/31/2017; 5: 30p	“ “	44640	44640
6	Trespass Upon Case	05/31/2017; 5: 30p 06/30/2017; 5: 30p	1 oz. U.S. Silver dollar/ minute	43200	43200
7	“ “	06/30/2017; 5: 30p 07/31/2017; 5: 30p	“ “	44640	44640
8	“ “	07/31/2017; 5: 30p 08/31/2017; 5: 30p	“ “	44640	44640
9	Trespass Upon Case	08/31/2017; 5: 30p 09/30/2017; 5: 30p	1 oz. U.S. Silver dollar/ minute	43200	43200
10	“ “	09/30/2017; 5: 30p	“ “	44640	44640

Darrell-James: Hill, c/o PO Box 3806, Apache Junction, Arizona 85117
USPS CMN 7017 1000 0000 9343 0704 : Ranier; USPS USPS CMN 7015 1730 0002 3063 9300 : Brian



:BILL OF COSTS:

		10/31/2017; 5: 30p			
11	“ “	10/31/2017; 5: 30p 11/30/2017; 5: 30p	“ “	43200	43200
12	Trespass Upon Case	11/30/2017; 5: 30p 12/31/2017; 5: 30p	1 oz. U.S. Silver dollar/ minute	44640	44640
13	“ “	12/31/2017; 5: 30p 01/31/2018; 5: 30p	“ “	44640	44640
14	“ “	01/31/2018; 5: 30p 02/28/2018; 5: 30p	“ “	40320	40320
15	Trespass Upon Case	02/28/2018; 5: 30p 03/31/2018; 5: 30p	1 oz. U.S. Silver dollar/ minute	44640	44640
16	“ “	03/31/2018; 5: 30p 04/30/2018; 5: 30p	“ “	43200	43200
17	“ “	04/30/2018; 5: 30p 05/31/2018; 5: 30p	“ “	44640	44640
18	Trespass Upon Case	05/31/2018; 5: 30p 06/30/2018; 5: 30p	1 oz. U.S. Silver dollar/ minute	43200	43200
19	“ “	06/30/2018; 5: 30p 07/18/2018; 5: 30p	“ “	25920	25920
Total Due	Trespass Upon Case	01/06/2017: 10:30a 07/18/2018: 5:30p	“ “	893220	893220

Payment Amount-due now: Eight hundred ninety-three thousand two hundred twenty, “893,220”, one-ounce U.S. silver dollars. Send: payment to: Darrell-James: Hill
c/o PO Box 3806
Apache Junction, Arizona 85117.

:Notice: Bill to the agent is bill to the principal;
:Notice: Bill to the principal is bill to the agent.

Autographed: 18th day: July month: 2018.

Without prejudice

:Darrell-James: Hill

Sworn to and subscribed before me now on the 18th day: July month: 2018
Produced identification: type: Arizona Driver License.

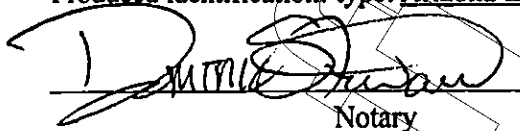
Notary

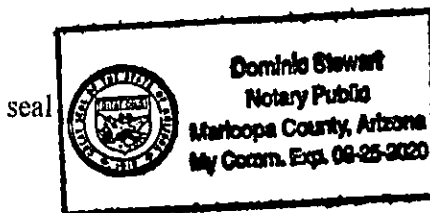

Darrell-James: Hill, c/o PO Box 3806, Apache Junction, Arizona 85117
USPS CMN 7017 1000 0000 9343 0704 : Ranier; USPS CMN 7015 1730 0002 3063 9300 : Brian

APACHE JUNCTION
151 W SUPERSTITION BLVD
APACHE JUNCTION, AZ
85120-9998
0302590130
07/18/2018 (800)275-8777 3:29 PM

Product Description	Sale Qty	Final Price
First-Class Mail Letter	1	\$0.50

(Domestic)
(TUCSON, AZ 85701)
(Weight: 0 Lb 0.80 Oz)
(Estimated Delivery Date)
(Friday 07/20/2018)

Certified	1	\$3.45
Return Receipt	1	\$2.75

(USPS Certified Mail #)
(7017100000093430704)

First-Class Mail Letter	1	\$0.50
-------------------------	---	--------

(Domestic)
(PHOENIX, AZ 85003)
(Weight: 0 Lb 0.90 Oz)
(Estimated Delivery Date)
(Friday 07/20/2018)

Certified	1	\$3.45
Return Receipt	1	\$2.75

(USPS Certified Mail #)
(70151730000230639300)

(USPS Return Receipt #)
(9590940227857069640051)

Total \$13.40
Cash Change \$20.00 (\$6.60)

Text your tracking number to 28777 (2USPS) to get the latest status. Standard Message and Data rates may apply. You may also visit www.usps.com USPS Tracking or call 1-800-222-1811.

U.S. Postal Service
CERTIFIED MAIL RECEIPT
Domestic Mail Only

For delivery information, visit our website at www.usps.com

OFFICIAL USE

Certified Mail Fee \$3.45

Extra Services & Fees (check box, add fee if applicable)

<input type="checkbox"/> Return Receipt (hardcopy)	\$0.00
<input type="checkbox"/> Return Receipt (electronic)	\$0.00
<input type="checkbox"/> Certified Mail Restricted Delivery	\$0.00
<input type="checkbox"/> Adult Signature Required	\$0.00
<input type="checkbox"/> Adult Signature Restricted Delivery	\$0.00

Postage \$0.50

Total Postage and Fees \$6.70

Postmark Here 07/18/2018

Sent To: **Ranker, Chief Judge, USDC, District of Arizona, Evo A. DeCesari U.S. Courthouse, 405 West Congress Street, Suite 5190, Tucson, Arizona (85701)**

PS Form 3800, April 2015

U.S. Postal Service
CERTIFIED MAIL RECEIPT
Domestic Mail Only

For delivery information, visit our website at www.usps.com

OFFICIAL USE

Certified Mail Fee \$3.45

Extra Services & Fees (check box, add fee if applicable)

<input type="checkbox"/> Return Receipt (hardcopy)	\$0.00
<input type="checkbox"/> Return Receipt (electronic)	\$0.00
<input type="checkbox"/> Certified Mail Restricted Delivery	\$0.00
<input type="checkbox"/> Adult Signature Required	\$0.00
<input type="checkbox"/> Adult Signature Restricted Delivery	\$0.00

Postage \$0.50

Total Postage and Fees \$6.70

Postmark Here 07/18/2018

Sent To: **Ranker, Chief Judge, USDC, District of Arizona - Phoenix, Evo A. DeCesari U.S. Courthouse, 100 491 Washington Street, Suite 1, Phoenix, Arizona (85003-2122)**

PS Form 3800, April 2015

2022-011769 MISC Page: 872 of 2782
09/26/2022 03:35:37 PM Receipt #: 22-9381
Rec Fee: \$30.00 Darrell James Hill
Gila County, AZ, Sadie Jo Bingham, Recorder

SENDER: COMPLETE THIS SECTION

- Complete items 1, 2, and 3.
- Print your name and address on the reverse so that we can return the card to you.
- Attach this card to the back of the mailpiece, or on the front if space permits.

1. Article Addressed to:

Ranker, Chief Judge,
USDC, District of Arizona
Evo A. DeCesari U.S. Courthouse
405 West Congress Street, Suite 5190
Tucson, Arizona (85701)

2. Article Number (Transfer from service label)

7017 1000 0000 9343 0704

COMPLETE THIS SECTION ON DELIVERY

A. Signature Agent Addressee

B. Received by (Printed Name) **Bernie Williams**

C. Date of Delivery **7-23-2018**

D. Is delivery address different from item 1? Yes No
If YES, enter delivery address below:

3. Service Type

<input type="checkbox"/> Adult Signature	<input type="checkbox"/> Priority Mail Express®
<input type="checkbox"/> Adult Signature Restricted Delivery	<input type="checkbox"/> Registered Mail™
<input type="checkbox"/> Certified Mail®	<input type="checkbox"/> Registered Mail Restricted Delivery
<input type="checkbox"/> Certified Mail Restricted Delivery	<input type="checkbox"/> Return Receipt for Merchandise
<input type="checkbox"/> Collect on Delivery	<input type="checkbox"/> Signature Confirmation™
<input type="checkbox"/> Collect on Delivery Restricted Delivery	<input type="checkbox"/> Signature Confirmation Restricted Delivery
<input type="checkbox"/> Insured Mail	
<input type="checkbox"/> Insured Mail Restricted Delivery (over \$500)	

USPS Tracking®

FAQs > (<http://faq.usps.com/?articleId=220900>)

Track Another Package +

Tracking Number: 7017100000093430704

Remove X

Your item was delivered to an individual at the address at 1:50 pm on July 23, 2018 in TUCSON, AZ 85701.

✓ Delivered

July 23, 2018 at 1:50 pm
Delivered, Left with Individual
TUCSON, AZ 85701

Get Updates ▾

Text & Email Updates ▾

Tracking History ▲

July 23, 2018, 1:50 pm
Delivered, Left with Individual
TUCSON, AZ 85701
Your item was delivered to an individual at the address at 1:50 pm on July 23, 2018 in TUCSON, AZ 85701.

July 20, 2018, 11:24 am
Out for Delivery
TUCSON, AZ 85701

July 20, 2018, 11:14 am
Sorting Complete
TUCSON, AZ 85701

July 20, 2018, 7:28 am
Arrived at Unit
TUCSON, AZ 85701

July 19, 2018, 11:42 pm
Departed USPS Regional Facility
TUCSON AZ DISTRIBUTION CENTER

July 19, 2018, 12:26 am
Arrived at USPS Regional Facility
TUCSON AZ DISTRIBUTION CENTER

July 18, 2018, 6:56 pm
Arrived at USPS Regional Facility

2022-011769 MISC Page: 873 of 2782
09/26/2022 03:35:37 PM Receipt #: 22-9381
Rec Fee: \$30.00 Darrell James Hill
Gila County, Az, Sadie Jo Bingham, Recorder



APACHE JUNCTION
151 W SUPERSTITION BLVD
APACHE JUNCTION, AZ
85120-9998
0302590130
(800)275-8777 3:29 PM

Product Description	Sale Qty	Final Price
First-Class Mail Letter (Domestic) (TUCSON, AZ 85701) (Weight: 0 Lb 0.80 Oz) (Estimated Delivery Date) (Friday 07/20/2018)	1	\$0.50
Certified (USPS Certified Mail #) (7017100000093430704)	1	\$3.45
Return Receipt (USPS Return Receipt #) (9590940227857069640068)	1	\$2.75
First-Class Mail Letter (Domestic) (PHOENIX, AZ 85003) (Weight: 0 Lb 0.90 Oz) (Estimated Delivery Date) (Friday 07/20/2018)	1	\$0.50
Certified (USPS Certified Mail #) (70151730000230639300)	1	\$3.45
Return Receipt (USPS Return Receipt #) (9590940227857069640051)	1	\$2.75

Total \$13.40
Cash Change \$20.00 (\$6.60)

Text your tracking number to 28777 (2USPS) to get the latest status. Standard Message and Data rates may apply. You may also visit www.usps.com USPS Tracking or call 1-800-222-1811.

U.S. Postal Service
CERTIFIED MAIL® RECEIPT
Domestic Mail Only

For delivery information, visit our website at www.usps.com

OFFICIAL USE

TUCSON, AZ 85701

Certified Mail Fee	\$3.45	0130 06 Postmark Here
Extra Services & Fees (check box, add fee as appropriate)	\$2.75	
<input type="checkbox"/> Return Receipt (hardcopy)	\$0.00	
<input type="checkbox"/> Return Receipt (electronic)	\$0.00	
<input type="checkbox"/> Certified Mail Restricted Delivery	\$0.00	
<input type="checkbox"/> Adult Signature Required	\$0.00	07/18/2018
<input type="checkbox"/> Adult Signature Restricted Delivery	\$0.00	
Postage	\$0.50	
Total Postage and Fees	\$6.70	

Sent To: **Reiner, Chief Judge, USDC, District of Arizona, Eva A. DeCocchini U.S. Courthouse, 401 West Congress Street, Suite 3190, Tucson, Arizona 85701**

PS Form 3800, April 2015

U.S. Postal Service
CERTIFIED MAIL® RECEIPT
Domestic Mail Only

For delivery information, visit our website at www.usps.com

OFFICIAL USE

PHOENIX, AZ 85003

Certified Mail Fee	\$3.45	0130 06 Postmark Here
Extra Services & Fees (check box, add fee as appropriate)	\$2.75	
<input type="checkbox"/> Return Receipt (hardcopy)	\$0.00	
<input type="checkbox"/> Return Receipt (electronic)	\$0.00	
<input type="checkbox"/> Certified Mail Restricted Delivery	\$0.00	
<input type="checkbox"/> Adult Signature Required	\$0.00	07/18/2018
<input type="checkbox"/> Adult Signature Restricted Delivery	\$0.00	
Postage	\$0.50	
Total Postage and Fees	\$6.70	

Sent To: **Brien, Clerk of Court, USDC, District of Arizona - Phoenix Div., Sandra Day O'Connor U.S. Courthouse, Ste. 130, 401 Washington Street, SPC 1, Phoenix, Arizona 85003-2119**

PS Form 3800, April 2015

2022-011769 MISC Page: 874 of 2782
09/25/2022 03:35:37 PM Receipt #: 22-9381
James Hill
Darrrell James Hill
Recorder
Gila County, Az. Sadie Jo Bingham

SENDER: COMPLETE THIS SECTION	COMPLETE THIS SECTION ON DELIVERY
<ul style="list-style-type: none"> Complete items 1, 2, and 3. Print your name and address on the reverse so that we can return the card to you. Attach this card to the back of the mailpiece, or on the front if space permits. 	<p>A. Signature <input checked="" type="checkbox"/> Agent <input type="checkbox"/> Addressee</p> <p>B. Received by (Printed Name) Ben O...</p> <p>C. Date of Receipt 7/19/18</p> <p>D. Is delivery address different from the address on the mailpiece? If YES, enter delivery address below:</p>
<p>1. Article Addressed to:</p> <p>Brien, Clerk of Court USDC, District of Arizona - Phoenix Div. Sandra Day O'Connor U.S. Courthouse, Ste. 130 401 Washington Street, SPC 1 Phoenix, Arizona 85003-2119</p>	<p>3. Service Type</p> <ul style="list-style-type: none"> <input type="checkbox"/> Adult Signature <input type="checkbox"/> Adult Signature Restricted Delivery <input checked="" type="checkbox"/> Certified Mail® <input type="checkbox"/> Certified Mail Restricted Delivery <input type="checkbox"/> Collect on Delivery <input type="checkbox"/> Collect on Delivery Restricted Delivery <input type="checkbox"/> Insured Mail <input type="checkbox"/> Insured Mail Restricted Delivery (over \$500) <input type="checkbox"/> Priority Mail Express® <input type="checkbox"/> Registered Mail™ <input type="checkbox"/> Registered Mail Restricted Delivery <input type="checkbox"/> Return Receipt for Merchandise <input type="checkbox"/> Signature Confirmation™ <input type="checkbox"/> Signature Confirmation Restricted Delivery
<p>2. Article Number (Transfer from service label)</p> <p>7015 1730 0002 3063 9300</p>	

8772

USPS Tracking®

FAQs > (<http://faq.usps.com/?articleId=220900>)

Track Another Package +

Tracking Number: 70151730000230639300

Remove X

Your item has been delivered to an agent at 11:05 am on July 19, 2018 in PHOENIX, AZ 85003.

✓ Delivered

July 19, 2018 at 11:05 am
Delivered, To Agent
PHOENIX, AZ 85003

Get Updates ✓

Text & Email Updates

Tracking History

July 19, 2018, 11:05 am
Delivered, To Agent
PHOENIX, AZ 85003

Your item has been delivered to an agent at 11:05 am on July 19, 2018 in PHOENIX, AZ 85003.

July 19, 2018, 7:57 am
Departed USPS Regional Facility
PHOENIX AZ DISTRIBUTION CENTER

July 18, 2018, 6:41 pm
Arrived at USPS Regional Facility
PHOENIX AZ DISTRIBUTION CENTER

July 18, 2018, 4:09 pm
Departed Post Office
APACHE JUNCTION, AZ 85120

2022-011769 MISC Page: 875 of 2782

09/26/2022 03:35:37 PM Receipt #: 22-9381
Rec Fee: \$30.00 Darrell James Hill
Gila County, Az, Sadie Jo Bingham, Recorder

7/19/18, 12:26 PM



873

Original Copy

BRIAN D. KARTH
District Court Executive / Clerk of Court
Sandra Day O'Connor U. S. Courthouse
Suite 130
401 West Washington Street, SPC 1
Phoenix, Arizona 85003-2118

**UNITED STATES DISTRICT COURT
DISTRICT OF ARIZONA
OFFICE OF THE CLERK**



MICHAEL S. O'BRIEN
Chief Deputy Clerk
Evo A. Deconcini U.S. Courthouse
405 W. Congress, Suite 1500
Tucson, Arizona 85701-5010

DEBRA D. LUCAS
Chief Deputy Clerk
Sandra Day O'Connor U. S. Courthouse
Suite 130
401 West Washington Street, SPC 1
Phoenix, Arizona 85003-2118

July 20, 2018

Darrel James Hill
PO Box 3806
Apache Junction, AZ 85117

RE: Return of Document

Dear Mr. Hill,

It is unclear how to process the enclosed document, therefore it is being returned to your attention unprocessed.

Brian D. Karth
District Court Executive/Clerk of Court

By s/ K. Smith
Deputy Clerk

2022-011769 MISC Page: 876 of 2782
09/26/2022 03:35:37 PM Receipt #: 22-9381
Rec Fee: \$30.00 Darrell James Hill
Gila County, Az, Sadie Jo Bingham, Recorder



Please send all correspondence to:

Customer Service ■ Sandra Day O'Connor U.S. Courthouse ■ Suite 130 ■ 401 W. Washington St., SPC 1 ■ Phoenix, AZ 85003-2118

875

CLERK, UNITED STATES DISTRICT COURT
SANDRA DAY O'CONNOR U.S. COURTHOUSE, SUITE 130
401 W. WASHINGTON ST., SPC. 1
PHOENIX, AZ 85003-2118

OFFICIAL BUSINESS

PHOENIX
AZ 85003
23 JUL '18
PM 10:11

NEOPOST FIRST-CLASS MAIL

07/23/2018
US POSTAGE \$000.47



ZIP 85003
041M11277589

Darrel James Hill
PO Box 3806
Apache Junction, AZ 85117

Return
7015 1730 0002 8063 9300
USPS CLAIM 7017 1000 0000
4343 0704 Phoenix

85117-413706

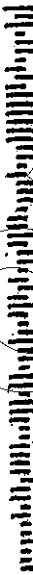

2022-011769 MISC Page: 877 of 2782
09/26/2022 03:35:37 PM Receipt #: 22-9381
Rec Fee: \$30.00 Darrell James Hill
Gila County, Az, Sadie Jo Bingham, Recorder



Copy

:BILL OF COSTS:

State of Arizona

County of Pinal

Darrell-James: Hill personally presents before me, the undersigned Notary, duly authorized by the laws of the State of Arizona to administer oaths; now on this 18th day July month, 2018: 3 : 10 am/pm, being by me first duly sworn on his affirmation, affiant deposes and says:

With the regard to the Trespass on the Case: Common Law Claim #: CMN 7009 1410 0000 7868 5703; filed on the January 4th, 2017: USPS RE 322 399 336 US : you, Ranier and Brian are now mailed:

Ranier: Chief Judge,
USDC; District of Arizona
Evo A. DeConcini U.S. Courthouse
405 West Congress Street, Suite 5190
Tucson, Arizona [85701]
520-20504540 -

Brian: Clerk of Court
USDC; District of Arizona - Phoenix Div.
Sandra Day O'Conner U.S. Courthouse, Ste. 130
401 Washington Street, SPC 1
Phoenix, Arizona [85003-2118]
602-322-7200 -

USPS CMN 7017 1000 0000 9343 0704 ; and: USPS CMN 7015 1730 0002 3063 9300 ; that,

By your choice, since January 4th, 2017; the: Darrell-James: Hill, man, declaration for the common-law claim-executed, Case # CMN 7009 1410 0000 7868 5703 is Not yet filed - instead, you illegally and forcibly filed a civil action trick - in the despite of the clear execution of the Almighty-God-Given Constitutionally-protected right to the common-law action demanded, and with your acceptance of the fee-schedule for the "trespass on the case" of the "one-ounce U.S. silver dollar per minute", and for the fact that i:man do not consent to your actions to not file the common law case ordered. To wit: your illegal forcing of the common law claim of: i: man into a civil action deception is wrong-doing trespass upon the case of the common law action ordered.

Wherefore, on March 9th, 2017: you received invoices for the fee-schedule amounts agreed due for your choice of the trespass upon the case of: i: man - See: Ranier - USPS CMN 7015 0640 0001 5883 2617 and Brian - 7015 0640 0001 5883 2600 - for the amount due on the April 6th, 2017: Eighty-three thousand, eight hundred ninety-three, "83,893", - one ounce U.S. Silver dollars.

Now: July 19th, 2018: this bill, due payable per our agreement for the continued trespass on the case is: Eight hundred ninety-three thousand two hundred twenty, "893,220", one-ounce U.S. silver dollars owed as described below.

Line	Trespass Upon Case	Time period	Fee-schedule: 1 oz. U.S. Silver dollar/ minute	Quantity minutes	Quantity silver dollars
1	" "	01/06/2017: 10:30a 01/31/2017: 5:30p	" "	36420	36420
2	" "	01/31/2017: 5:30p 02/28/2017; 5: 30p	" "	40320	40320
3	" "	02/28/2017; 5: 30p 03/31/2017; 5: 30p	" "	44640	44640
4	Trespass Upon Case	03/31/2017; 5: 30p 04/30/2017; 5: 30p	1 oz. U.S. Silver dollar/ minute	43200	43200
5	" "	04/30/2017; 5: 30p 05/31/2017; 5: 30p	" "	44640	44640
6	Trespass Upon Case	05/31/2017; 5: 30p 06/30/2017; 5: 30p	1 oz. U.S. Silver dollar/ minute	43200	43200
7	" "	06/30/2017; 5: 30p 07/31/2017; 5: 30p	" "	44640	44640
8	" "	07/31/2017; 5: 30p 08/31/2017; 5: 30p	" "	44640	44640
9	Trespass Upon Case	08/31/2017; 5: 30p 09/30/2017; 5: 30p	1 oz. U.S. Silver dollar/ minute	43200	43200
10	" "	09/30/2017; 5: 30p	" "	44640	44640

Darrell-James: Hill, c/o PO Box 3806, Apache Junction, Arizona 85117
USPS CMN 7017 1000 0000 9343 0704 : Ranier; USPS USPS.CMN 7015 1730 0002 3063 9300 : Brian



876

:BILL OF COSTS:

		10/31/2017; 5: 30p			
11	" "	10/31/2017; 5: 30p 11/30/2017; 5: 30p	" "	43200	43200
12	Trespass Upon Case	11/30/2017; 5: 30p 12/31/2017; 5: 30p	1 oz. U.S. Silver dollar/ minute	44640	44640
13	" "	12/31/2017; 5: 30p 01/31/2018; 5: 30p	" "	44640	44640
14	" "	01/31/2018; 5: 30p 02/28/2018; 5: 30p	" "	40320	40320
15	Trespass Upon Case	02/28/2018; 5: 30p 03/31/2018; 5: 30p	1 oz. U.S. Silver dollar/ minute	44640	44640
16	" "	03/31/2018; 5: 30p 04/30/2018; 5: 30p	" "	43200	43200
17	" "	04/30/2018; 5: 30p 05/31/2018; 5: 30p	" "	44640	44640
18	Trespass Upon Case	05/31/2018; 5: 30p 06/30/2018; 5: 30p	1 oz. U.S. Silver dollar/ minute	43200	43200
19	" "	06/30/2018; 5: 30p 07/18/2018; 5: 30p	" "	25920	25920
Total Due	Trespass Upon Case	01/06/2017: 10:30a 07/18/2018: 5:30p	" "	893220	893220

Payment Amount-due now: Eight hundred ninety-three thousand two hundred twenty, "893,220", one-ounce U.S. silver dollars. Send: payment to: Darrell-James: Hill
c/o PO Box 3806
Apache Junction, Arizona 85117.

:Notice: Bill to the agent is bill to the principal;
:Notice: Bill to the principal is bill to the agent.

Autographed: 18th day: July month: 2018.

Without prejudice

Darrell James Hill
:Darrell-James: Hill

Sworn to and subscribed before me now on the 18th day: July month: 2018
Produced identification: type: Arizona Driver License.

Domino Stewart
Notary

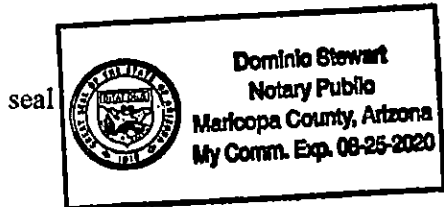

Darrell-James: Hill, c/o PO Box 3806, Apache Junction, Arizona 85117
USPS CMN 7017 1000 0000 9343 0704 : Ranier; USPS CMN 7015 1730 0002 3063 9300 : Brian



877

MIME-Version:1.0 From:azddb_responses@azd.uscourts.gov To:azddb_nefs@localhost.localdomain
Bcc: Message-Id:<17969107@azd.uscourts.gov>Subject:Activity in Case 2:17-cv-00026-BSB Hill v.
Lynch et al Order Content-Type: text/html

This is an automatic e-mail message generated by the CM/ECF system. Please DO NOT RESPOND to this e-mail because the mail box is unattended.

*****NOTE TO PUBLIC ACCESS USERS***** Judicial Conference of the United States policy permits attorneys of record and parties in a case (including pro se litigants) to receive one free electronic copy of all documents filed electronically, if receipt is required by law or directed by the filer. PACER access fees apply to all other users. To avoid later charges, download a copy of each document during this first viewing. However, if the referenced document is a transcript, the free copy and 30 page limit do not apply.

**U.S. District Court
DISTRICT OF ARIZONA**

Notice of Electronic Filing

The following transaction was entered on 7/31/2018 at 4:39 PM MST and filed on 7/31/2018

Case Name: Hill v. Lynch et al
Case Number: 2:17-cv-00026-BSB
Filer:

WARNING: CASE CLOSED on 05/05/2017

Document Number: 24

Docket Text:

ORDER - The Clerk of Court shall strike Plaintiff's [23] Bill of Costs. This case shall remain closed. IT IS FURTHER ORDERED that Plaintiff must not file any additional documents in this closed case, except in furtherance of an appeal. Signed by Magistrate Judge Bridget S Bade on 7/31/18. (GMP)

**2:17-cv-00026-BSB Notice has been electronically mailed to:
2:17-cv-00026-BSB Notice will be sent by other means to those listed below if they are affected by this filing:
Darrell James Hill
5124 E 18th St.
Apache Junction, AZ 85119**

The following document(s) are associated with this transaction:

878

2022-011769 MISC Page: 880 of 2782
09/26/2022 03:35:37 PM Receipt #: 22-9381
Rec Fee: \$30.00 Darrell James Hill
Gila County, Az, Sadie Jo Bingham, Recorder



Document description:Main Document

Original filename:n/a

Electronic document Stamp:

[STAMP dcecfStamp_ID=1096393563 [Date=7/31/2018] [FileNumber=17969105-0] [892804e2c3ec00a90802452effe8d5cfd0811bec49445d78b015be329d1a5819524b49df0f0b6ce42ef1758e38eca5635bef2be5a07a15f2c48dbbba2751b0b3]]

Unofficial Copy

879

2022-011769 MISC Page: 881 of 2782
09/26/2022 03:35:37 PM Receipt #: 22-9381
Rec Fee: \$30.00 Darrell James Hill
Gila County, Az, Sadie Jo Bingham, Recorder



1
2
3
4
5
6
7
8
9
10
11
12
13
14
15
16
17
18
19
20
21
22
23
24
25
26
27
28

IN THE UNITED STATES DISTRICT COURT
FOR THE DISTRICT OF ARIZONA

Darrell James Hill,
Plaintiff,

v.

Loretta Lynch, et al.,
Defendants.

No. CV-17-00026-PHX-BSB

ORDER

This action was dismissed in May 2017 for failure to serve pursuant to Federal Rule of Civil Procedure 4(m) (Doc. 22). Plaintiff has filed what is styled as a Bill of Costs and seeks \$893,220. This document will be stricken as improperly filed.

Accordingly,

IT IS ORDERED that the Clerk of Court shall strike Plaintiff's Bill of Costs (Doc. 23). This case shall remain closed.

IT IS FURTHER ORDERED that Plaintiff must not file any additional documents in this closed case, except in furtherance of an appeal.

Dated this 31st day of July, 2018.



Bridget S. Bade
United States Magistrate Judge



Darrell James Hill

5124 E 18th St.
Apache Junction, AZ 85119

Unofficial Copy

581

2022-011769 MISC Page: 883 of 2782

09/26/2022 03:35:37 PM Receipt #: 22-9381

Rec Fee: \$30.00 Darrell James Hill
Gila County, Az, Sadie Jo Bingham, Recorder



PHOENIX
AZ 850
01 AUG '18
PM 11.1

CLERK, UNITED STATES DISTRICT COURT
SANDRA DAY O'CONNOR U.S. COURTHOUSE, SUITE 130
401 W. WASHINGTON ST., SPC-1
PHOENIX, AZ 85003-2118

OFFICIAL BUSINESS

NEOPOST FIRST-CLASS MAIL

08/01/2018

US POSTAGE \$000.47



ZIP 85003
041M11277589

*Pres'd bode
08-03-2018
Duffenard*

9519-937424



2022-011769 MISC Page: 884 of 2782
09/26/2022 03:35:37 PM Receipt #: 22-9381
Rec Fee: \$30.00 Darrell James Hill
Gila County, Az, Sadie Jo Bingham, Recorder



882

UNOFFICIAL COPY

:BILL OF COSTS:

State of Arizona

County of Pinal

Darrell-James: Hill personally presents before me, the undersigned Notary, duly authorized by the laws of the State of Arizona to administer oaths; now on this 19th day July month, 2018: JD: 36 am/pm, being by me first duly sworn on his affirmation, affiant deposes and says:

With the regard to the Trespass on the Case: "AFFIDAVIT: JURAT: CURATIVE REGISTRATION OF THE LIVE LIFE: Darrell-James: Hill Grantee: CESTUI QUE VIE – ESTATE TRUST NAMED: DARRELL JAMES HILL"; sent for the recordation on the April 12th, 2018: USPS RMN RE 322,399 163 US : you, Kristen and and Katie are now mailed:

Kristen: Summit County Fiscal Officer Scalise
175 South Main Street
Akron, Ohio [44308-1354]

Katie: *Executive Assistant* IMancino
175 South Main Street
Akron, Ohio [44308-1354]
330.643.2530-

USPS CMN 7015 1730 0002 3063 9287 ; and: USPS CMN 7015 1730 0002 3063 9294 ; that,

By your choice, since April 18th, 2018; the: Darrell-James: Hill, man, declaration of live-life and political election instrument-executed for recordation is Not yet recorded – instead, you illegally and forcibly refused to record the document – in the despite of the clear execution of the Almighty-God-Given Constitutionally-protected right to the action demanded, and with your acceptance of the fee-schedule for the trespass on the case of the "one pre-1933 one-ounce- 99% or higher-gold United States Coin per minute cumulative from this registration until upon the full remedy is resolved; ...[:]" and, for the fact that i:man do not consent to your actions to not record the instrument. To wit: your repeated refusal to file the live-life and political election document of: i:man with No cause Nor remedy is illegal wrong-doing and trespass upon the case.

Wherefore, on April 25th, 2018: you received the second attempt from the man to record the necessary instrument, and for the resolve of the denial of the right, and with the clear notice of the fee-schedule amounts agreed due for your choice of the trespass upon the case of: i: man – See: Kristen c/o :Katie – USPS RMN RE 32399194 US – : document was also sent to: Steve: Summit County Sheriff Barry for the common law and state and federal criminal activity developments in this trespass on the case of: i:man: Darrell-James: Hill.

Now: July 19th, 2018: this bill, due payable per our agreement for the continued trespass on the case: pre-1933 one-ounce- 99% or higher-gold United States Coin per minute – unit measure of time – is: one hundred forty-one thousand four hundred sixty-eight, "141,468"; payment owed as described below.

Darrell-James: Hill, c/o PO Box 3806, Apache Junction, Arizona 85117
USPS CMN 7015 1730 0002 3063 9287 : Kristen; U

2022-011769 MISC Page: 885 of 2782
09/26/2022 03:35:37 PM Receipt #: 22-9381
Rec Fee: \$30.00 Darrell James Hill
Gila County, Az, Sadie Jo Bingham, Recorder



883

:BILL OF COSTS:

Line	Trespass Upon, Case	Time period	Fee-schedule: one-ounce- 99% or higher-gold United States Coin per minute/ minute	Quantity minutes	Quantity one-ounce- 99% or higher-gold United States Coin
1	" "	04/12/2018: 11:42a 04/30/2018; 5: 30p	" "	26268	26268
2	" "	04/30/2018; 5: 30p 05/31/2018; 5: 30p	" "	44640	44640
3	Trespass Upon Case	05/31/2018; 5: 30p 06/30/2018; 5: 30p	" "	43200	43200
4		06/30/2018; 5: 30p 07/19/2018; 5: 30p	" "	27360	27360
Total Due	Trespass Upon Case	04/12/2018: 11:42a 07/19/2018: 5:30p	" "	141468	141468

Payment Amount-due now: One hundred forty-one thousand four hundred sixty-eight, "141,468", pre-1933 one-ounce- 99% or higher-gold United States Coins.

Send: payment to: Darrell-James: Hill
c/o PQ Box 3806
Apache Junction, Arizona 85117.

:Notice: Bill to the agent is bill to the principal;
:Notice: Bill to the principal is bill to the agent.

Without prejudice:

Autographed: 19th day: July month: 2018.

Darrell-James Hill
:Darrell-James: Hill, m...

Sworn to and subscribed before me now on the 19th day: July month: 2018
Produced identification: type: Arizona Driver License.

Heather Wood
Notary

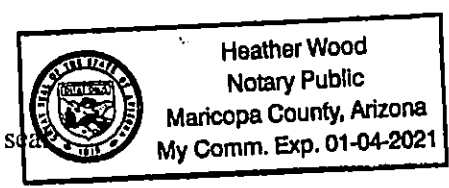

2022-011769 MISC Page: 886 of 2782
09/26/2022 03:35:37 PM Receipt #: 22-9381
Rec Fee: \$30.00 Darrell James Hill
Gila County, Az. Sadie Jo Bingham, Recorder

Darrell-James: Hill, c/o PO Box 3806, Apache Junction, Arizona 85117
USPS CMN 7015 1730 0002 3063 9287 : Kristen; USPS CMN 7015 1730 0002 3063 9294 : Katie

7015 1730 0002 3063 9284

U.S. Postal Service
CERTIFIED MAIL® RECEIPT
 Domestic Mail Only

For delivery information, visit our website at www.usps.com

OFFICIAL USE

Certified Mail Fee	\$3.45
Extra Services & Fees (check box, add fee amount)	\$2.75
<input type="checkbox"/> Return Receipt (hardcopy)	\$0.00
<input type="checkbox"/> Return Receipt (electronic)	\$0.00
<input type="checkbox"/> Certified Mail Restricted Delivery	\$0.00
<input type="checkbox"/> Adult Signature Required	\$0.00
<input type="checkbox"/> Adult Signature Restricted Delivery	\$0.00

0130
11
Postmark Here
07/19/2018

Postage	\$0.50
Total Postage and Fees	\$8.70

Sent To
 Katie Executive Assistant / Manager
 Street and Apt. No., or PO Box 175 South Main Street
 Akron, Ohio 44308-1354
 City, State, ZIP+4®

U.S. Postal Service
CERTIFIED MAIL® RECEIPT
 Domestic Mail Only

For delivery information, visit our website at www.usps.com

OFFICIAL USE

Certified Mail Fee	\$3.45
Extra Services & Fees (check box, add fee amount)	\$2.75
<input type="checkbox"/> Return Receipt (hardcopy)	\$0.00
<input type="checkbox"/> Return Receipt (electronic)	\$0.00
<input type="checkbox"/> Certified Mail Restricted Delivery	\$0.00
<input type="checkbox"/> Adult Signature Required	\$0.00
<input type="checkbox"/> Adult Signature Restricted Delivery	\$0.00

0130
11
Postmark Here
07/19/2018

Postage	\$0.50
Total Postage and Fees	\$8.70

Sent To
 Kristin Summit County Fiscal Officer Scalfes
 Street and Apt. No., or PO Box 175 South Main Street
 Akron, Ohio 44308-1354
 City, State, ZIP+4®

7015 1730 0002 3063 9287

APACHE JUNCTION
 151 W SUPERSTITION BLVD
 APACHE JUNCTION, AZ
 85120-9998
 0302590130
 (800)275-8777 11:04 AM

Product Description	Sale Qty	Final Price
First-Class Mail Letter (Domestic) (AKRON, OH 44308) (Weight: 0 Lb 0.60 Oz) (Estimated Delivery Date) (Monday 07/23/2018)	1	\$0.50
Certified (USPS Certified Mail #) (70151730000230639294)	1	\$3.45
Return Receipt (USPS Return Receipt #) (9590940227857069640082)	1	\$2.75
First-Class Mail Letter (Domestic) (AKRON, OH 44308) (Weight: 0 Lb 0.60 Oz) (Estimated Delivery Date) (Monday 07/23/2018)	1	\$0.50
Certified (USPS Certified Mail #) (70151730000230639287)	1	\$3.45
Return Receipt (USPS Return Receipt #) (9590940227857069640075)	1	\$2.75

Total \$13.40
 Cash Change \$14.60 (\$0.60)

Text your tracking number to 28777 (2USPS) to get the latest status.

SENDER: COMPLETE THIS SECTION

- Complete items 1, 2, and 3.
- Print your name and address on the reverse so that we can return the card to you.
- Attach this card to the back of the mailpiece, or on the front if space permits.

1. Article Addressed to:

Kristin Summit County Fiscal Officer Scalfes
 175 South Main Street
 Akron, Ohio 44308-1354



9590 9402 2785 7069 6400 75

2. Article Number (Transfer from service label)
 7015 1730 0002 3063 9287

COMPLETE THIS SECTION ON DELIVERY

A. Signature
 Addressee
 Agent
 B. Received by (Printed Name) _____ Date of Delivery _____

D. Is delivery address different from item 1? Yes
 If YES, enter delivery address below: No

3. Service Type
- Adult Signature
 - Adult Signature Restricted Delivery
 - Certified Mail®
 - Certified Mail Restricted Delivery
 - Collect on Delivery
 - Collect on Delivery Restricted Delivery
 - Registered Mail™
 - Registered Mail Restricted Delivery
 - Return Receipt for Merchandise
 - Signature Confirmation™
 - Signature Confirmation Restricted Delivery
 - Priority Mail Express®

2022-011769 MISC Page: 887 of 2782
 09/26/2022 09:35:37 PM Receipt #: 22-9381
 Rec Fee: \$30.00 Darrell James Hill
 Gila County, AZ, Sadie Jo Bingham Recorder

885 UNOFFICIAL

4626 E90E 2000 DELT 570L 7015 1730 0002 3063 9287

4626 E90E 2000 DELT 570L 7015 1730 0002 3063 9287

APACHE JUNCTION
151 W SUPERSTITION BLVD
APACHE JUNCTION, AZ
85120-9998
0302590130
07/19/2018 (800)275-8777 11:04 AM

Product Description Sale Qty Final Price
First-Class Mail Letter (Domestic) (AKRON, OH 44308) (Weight: 0 Lb 0.60 Oz) (Estimated Delivery Date) (Monday 07/23/2018)

Certified 1 \$3.45
Return Receipt 1 \$2.75

First-Class Mail Letter (Domestic) (AKRON, OH 44308) (Weight: 0 Lb 0.60 Oz) (Estimated Delivery Date) (Monday 07/23/2018)

Certified 1 \$3.45
Return Receipt 1 \$2.75

Total \$13.40
Cash Change \$14.00 (\$0.60)

Text your tracking number to 28777 (2USPS) to get the latest status.

U.S. Postal Service™
CERTIFIED MAIL® RECEIPT
Domestic Mail Only

For delivery information, visit our website at www.usps.com

OFFICIAL USE

Certified Mail Fee \$3.45
Extra Services & Fees (check box, add fee as appropriate)
 Return Receipt (hardcopy) \$0.00
 Return Receipt (electronic) \$0.00
 Certified Mail Restricted Delivery \$0.00
 Adult Signature Required \$0.00
 Adult Signature Restricted Delivery \$0.00

0130 11
Postmark Here
07/19/2018

Postage \$0.50
Total Postage and Fees \$6.70

Sent To
Katie Executive Assistant / Mancino
Street and Apt. No., or PO Box 175 South Main Street
Akron, Ohio [44308-1354]
City, State, ZIP+4®
PS Form 3800, April 2015 See Reverse for Instructions

U.S. Postal Service™
CERTIFIED MAIL® RECEIPT
Domestic Mail Only

For delivery information, visit our website at www.usps.com

OFFICIAL USE

Certified Mail Fee \$3.45
Extra Services & Fees (check box, add fee as appropriate)
 Return Receipt (hardcopy) \$0.00
 Return Receipt (electronic) \$0.00
 Certified Mail Restricted Delivery \$0.00
 Adult Signature Required \$0.00
 Adult Signature Restricted Delivery \$0.00

0130 11
Postmark Here
07/19/2018

Postage \$0.50
Total Postage and Fees \$6.70

Sent To
Kristin: Summit County Fiscal Officer Scales
Street and Apt. No., or PO 175 South Main Street
Akron, Ohio [44308-1354]
City, State, ZIP+4®
PS Form 3800, April 2015 See Reverse for Instructions

2022-011769 MISC Page: 888 of 2782
09/26/2022 03:35:37 PM Receipt #: 22-9381
Rec Fee: \$60.00 Darrell James Hill
Gita County, Az, Sadie Jo Blingham, Recorder

SENDER: COMPLETE THIS SECTION

- Complete items 1, 2, and 3.
- Print your name and address on the reverse so that we can return the card to you.
- Attach this card to the back of the mailpiece, or on the front if space permits.

1. Article Addressed to:

Katie Executive Assistant / Mancino
175 South Main Street
Akron, Ohio [44308-1354]



9590 9402 2785 7069 6400 82

2. Article Number (Transfer from service label)
7015 1730 0002 3063 9287

COMPLETE THIS SECTION ON DELIVERY

A. Signature
COUNTY OF SUMMIT Agent Addressee
B. Received by (Printed Name) C. Date of Delivery
D. Is delivery address different from item 1? Yes No
If YES, enter delivery address below:

3. Service Type
 Adult Signature Priority Mail Express®
 Adult Signature Restricted Delivery Registered Mail™
 Certified Mail® Registered Mail Restricted Delivery
 Certified Mail Restricted Delivery Return Receipt for Merchandise
 Collect on Delivery Signature Confirmation™
 Collect on Delivery Restricted Delivery Signature Confirmation Restricted Delivery
 Insured Mail Signature Confirmation Restricted Delivery (over \$500)
 Insured Mail Restricted Delivery (over \$500)

:CERTIFICATE OF PROTEST:

STATE OF ARIZONA

COUNTY OF MARICOPA

For the fact be it known that on the 24th day: July month: 2018 year A.D., at the request of the corporate entity :DARRELL JAMES HILL, by the Authorized Representative :Darrell- James: Hill, man – c/o PO Box 3806, Apache Junction, Arizona 85117 – , I: JOHN KRAISS: notary public in and for the STATE OF ARIZONA, duly appointed, commissioned and sworn, residing in the CITY: GILBERT, in the COUNTY: MARICOPA, and in the STATE aforesaid, presented the annexed instruments – See: Affiant's Statement: “:AFFIDAVIT: Claim Of The Event and Filing: Common Law Case: Claimant Case No: CMN 7009 1410 0000 7868 5703” by the man: Darrell- James: Hill of the documents made for the obtainment of the inherent and Constitutionally preserved right claimed by the man: Darrell- James: Hill – to which has been coercive obfuscation response to-date from the man:Public-persons who deprived the affiant's private property-claimed;

Whereupon, I, the said notary public, at the request aforesaid by these presents do solemnly protest against the man:Public-persons, Ranier: Chief Judge Collins: USDC- Arizona, and Brian: Clerk of Court Karth: USDC- Arizona, Phoenix, and all of the man:Public-persons to whom it may concern, for the filing of the common law action presented with the protection of the same, and for all the costs, damages, and interest already incurred, and hereafter incurred, by the reason of the deprivation of the right to the property-claimed heretofore.

And: I do hereby certify that, on this same day and year above written, I deposited this “CERTIFICATE OF PROTEST” and the annexed instrument(s) – “:AFFIDAVIT: Claim Of The Event and Filing: Common Law Case: Claimant Case No: CMN 7009 1410 0000 7868 5703” – , postage-paid to the post office at the 13 East Ray Road, Gilbert, Arizona 85296 location, directed to the man parties to be charged:

Ranier: Chief Judge Collins
 Evo A. DeConcini U.S. Courthouse
 405 West Congress Street, Suite 5190
 Tucson, Arizona [85701]

USPS CMN 7015 1730 0002 3063 9263

Brian: Clerk of Court Karth
 Sandra Day O'Connor U.S. Courthouse, Suite 130
 401 West Washington Street, SPC 1
 Phoenix Arizona [85003-2118]

USPS CMN 701501730 0002 6063 9256

Reason for the certification of the protest is: coercive obfuscation response to-date from the man:Public-persons who deprived the affiant's private property-claimed, as indicated in the Affiant's Statement: “:AFFIDAVIT: Claim Of The Event and Filing: Common Law Case: Claimant Case No: CMN 7009 1410 0000 7868 5703” by the affiant: Darrell- James: Hill.

IN THE WITNESS WHEREOF: I have hereunto subscribed my name and affixed my seal of office.

Notary

Seal

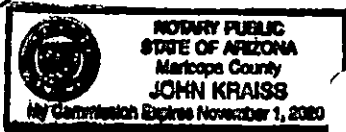

2022-011769 MISC Page: 889 of 2782
 09/26/2022 03:35:37 PM Receipt #: 22-9381
 Rec Fee: \$30.00 Darrell James Hill
 Gila County, Az, Sadie Jo Bingham, Recorder



887

7015 1730 000 2002 3063 926

U.S. Postal Service™
CERTIFIED MAIL® RECEIPT
 Domestic Mail Only

For delivery information, visit our website at www.usps.com.

PHOENIX AZ 85003

Certified Mail Fee	\$3.45	0381
Extra Services & Fees (check box, add fee as appropriate)		
<input type="checkbox"/> Return Receipt (hardcopy)	\$0.00	06
<input type="checkbox"/> Return Receipt (electronic)	\$0.00	
<input type="checkbox"/> Certified Mail Restricted Delivery	\$0.00	
<input type="checkbox"/> Adult Signature Required	\$0.00	
<input type="checkbox"/> Adult Signature Restricted Delivery	\$0.00	
Postage	\$2.68	
Total Postage and Fees	\$8.88	

Postmark:
 JUL 25 2018
 PHOENIX AZ 85003

Street and Apt. No., or PO Box: **Brink: Clark of Court Kirk; et al. Sandra Day O'Connor U.S. Courthouse, Suite 130 401 West Washington Street, SPC 1 Phoenix Arizona (85003-3118)**

City, State, ZIP+4®

PS Form 3800, April 2015 PSN 7530-02-000-9037 See Reverse for Instructions

7015 1730 000 2002 3063 926

U.S. Postal Service™
CERTIFIED MAIL® RECEIPT
 Domestic Mail Only

For delivery information, visit our website at www.usps.com.

TUCSON AZ 85701

Certified Mail Fee	\$3.45	
Extra Services & Fees (check box, add fee as appropriate)		
<input type="checkbox"/> Return Receipt (hardcopy)	\$0.00	
<input type="checkbox"/> Return Receipt (electronic)	\$0.00	
<input type="checkbox"/> Certified Mail Restricted Delivery	\$0.00	
<input type="checkbox"/> Adult Signature Required	\$0.00	
<input type="checkbox"/> Adult Signature Restricted Delivery	\$0.00	
Postage	\$2.68	
Total Postage and Fees	\$8.88	

Postmark:
 JUL 25 2018
 HIGLEY AZ 85238

Street and Apt. No., or PO Box No: **Rankin: Chief Judge Collins, Evo A. DeConcini U.S. Courthouse 405 West Congress Street, Suite 5190 Tucson, Arizona (85701)**

City, State, ZIP+4®

PS Form 3800, April 2015 PSN 7530-02-000-9037 See Reverse for Instructions

HIGLEY
 3324 E RAY RD
 HIGLEY
 AZ
 85238-4500
 0338850381
 (800)275-8777 11:49 AM

Product Description Sale Qty Final Price

Large Envelope (Domestic) (PHOENIX, AZ 85003) (Weight: 0 Lb 8.30 Oz) (Estimated Delivery Date) (Friday 07/27/2018)			
Certified (1) (USPS Certified Mail #) (70151730000230639256)		1	\$3.45
Return Receipt (1) (USPS Return Receipt #) (9590940100195071110754)		1	\$2.75
First-Class Mail (1)		1	\$2.68
Large Envelope (Domestic) (TUCSON, AZ 85701) (Weight: 0 Lb 8.20 Oz) (Estimated Delivery Date) (Friday 07/27/2018)			
Certified (1) (USPS Certified Mail #) (70151730000230639263)		1	\$3.45
Return Receipt (1) (USPS Return Receipt #) (9590940306765196708918)		1	\$2.75
Total			\$34.05
Cash Change			\$100.00 (\$65.95)

Text your tracking number to 28777 (2USPS) to get the latest status. Standard Message and Data rates may apply. You may also visit www.usps.com

2022-011769 MISC Page: 890 of 2782
 08/25/2022 03:35:37 PM Receipt #: 22-9881
 Rec Fee: \$30.00 Darrell James Hill
 Gila County, AZ, Sadie Jo Bingham, Recorder

<p>SENDER: COMPLETE THIS SECTION</p> <ul style="list-style-type: none"> Complete items 1, 2, and 3. Print your name and address on the reverse so that we can return the card to you. Attach this card to the back of the mailpiece or on the front if space permits. <p>Article Addressed to: Rankin: Chief Judge Collins, Evo A. DeConcini U.S. Courthouse 405 West Congress Street, Suite 5190 Tucson, Arizona (85701)</p> <p>588</p> <p>Barcode: 9590940306765196708918</p> <p>(2) Article Number (Identical from left to right): 7015 1730 0002 3063 9263</p> <p>PS Form 3811, April 2015 PSN 7530-02-000-9053</p>	<p>COMPLETE THIS SECTION OF DELIVERY</p> <p>A. Signature <input checked="" type="checkbox"/> Bonnie Williams Agent <input type="checkbox"/> Addressee</p> <p>B. Received by (Printed Name) Bonnie Williams</p> <p>C. Date of Delivery 7-25-2018</p> <p>D. Is delivery address different from item 1? <input type="checkbox"/> Yes If YES, enter delivery address below: <input type="checkbox"/> No</p> <p>3. Service Type <input type="checkbox"/> Adult Signature <input type="checkbox"/> Adult Signature Restricted Delivery <input type="checkbox"/> Certified Mail® <input type="checkbox"/> Certified Mail Restricted Delivery <input type="checkbox"/> Collect on Delivery <input type="checkbox"/> Collect on Delivery Restricted Delivery <input type="checkbox"/> Registered Mail® <input type="checkbox"/> Registered Mail Restricted Delivery <input type="checkbox"/> Return Receipt for Merchandise <input type="checkbox"/> Signature Confirmation™ <input type="checkbox"/> Signature Confirmation Restricted Delivery</p> <p>Domestic Return Receipt</p>
--	--

USPS Tracking®

FAQs > (<http://faq.usps.com/?articleId=220900>)

Track Another Package +

Tracking Number: 70151730000230639263

Remove X

Your item was delivered to an individual at the address at 11:54 am on July 30, 2018 in TUCSON, AZ 85701.

✓ Delivered

July 30, 2018 at 11:54 am
Delivered, Left with Individual
TUCSON, AZ 85701

Get Updates ▾

Text & Email Updates ▾

Tracking History ▲

July 30, 2018, 11:54 am
Delivered, Left with Individual
TUCSON, AZ 85701

Your item was delivered to an individual at the address at 11:54 am on July 30, 2018 in TUCSON, AZ 85701.

July 27, 2018, 2:37 pm
Delivery Attempted - No Access to Delivery Location
TUCSON, AZ 85701

July 27, 2018, 4:35 am
Departed USPS Regional Facility
TUCSON AZ DISTRIBUTION CENTER

July 26, 2018, 4:21 pm
Arrived at USPS Regional Facility
TUCSON AZ DISTRIBUTION CENTER

July 26, 2018
In Transit to Next Facility

889

2022-011769 MISC Page: 891 of 2782

09/26/2022 03:35:37 PM Receipt #: 22-9381

Rec Fee: \$30.00 Darrell James Hill

Gila County, Az, Sadie Jo Bingham, Recorder



U.S. Postal Service™
CERTIFIED MAIL® RECEIPT
 Domestic Mail Only

For delivery information, visit our website at www.usps.com

PHOENIX, AZ 85003
OFFICIAL USE

Certified Mail Fee	\$3.45	0381
Extra Services & Fees (check box, add fee as appropriate)	\$2.75	06
<input type="checkbox"/> Return Receipt (hardcopy)	\$0.00	
<input type="checkbox"/> Return Receipt (electronic)	\$0.00	
<input type="checkbox"/> Certified Mail Restricted Delivery	\$0.00	
<input type="checkbox"/> Adult Signature Required	\$0.00	
<input type="checkbox"/> Adult Signature Restricted Delivery	\$0.00	
Postage	\$2.68	
Total Postage and Fees	\$8.88	

Sent To
 Street and Apt. No., or PO Box: **Briaz, Clerk of Court Kartik, et al, Sandra Day O'Connor U.S. Courthouse, Suite 130, 401 West Washington Street, SPC 1, Phoenix, Arizona (85003-2118)**
 City, State, ZIP+4®

PS Form 3800, April 2015 PSN 7530-02-000-9053 See Reverse for Instructions

U.S. Postal Service™
CERTIFIED MAIL® RECEIPT
 Domestic Mail Only

For delivery information, visit our website at www.usps.com

TUCSON, AZ 85701
OFFICIAL USE

Certified Mail Fee	\$3.45	
Extra Services & Fees (check box, add fee as appropriate)	\$2.75	
<input type="checkbox"/> Return Receipt (hardcopy)	\$0.00	
<input type="checkbox"/> Return Receipt (electronic)	\$0.00	
<input type="checkbox"/> Certified Mail Restricted Delivery	\$0.00	
<input type="checkbox"/> Adult Signature Required	\$0.00	
<input type="checkbox"/> Adult Signature Restricted Delivery	\$0.00	
Postage	\$2.68	
Total Postage and Fees	\$8.88	

Sent To
 Street and Apt. No., or PO Box No.: **Banker: Chief Judge Collins, Evo A. DeCencia U.S. Courthouse, 405 West Congress Street, Suite 5190, Tucson, Arizona (85701)**
 City, State, ZIP+4®

PS Form 3800, April 2015 PSN 7530-02-000-9053 See Reverse for Instructions

HIGLEY
 3324 E RAY RD
 HIGLEY
 AZ

85236-4500
 0338850381

07/25/2018 (800)275-8777 11:49 AM

Product Description	Sale Qty	Final Price
---------------------	----------	-------------

Large Envelope (Domestic) (PHOENIX, AZ 85003) (Weight: 0 Lb 8.30 Oz) (Estimated Delivery Date) (Friday 07/27/2018)	1	\$3.45
Certified (USPS Certified Mail #) (70151730000230639256)	1	\$2.75
Return Receipt (USPS Return Receipt #) (9590940100195071110754)	1	\$2.68
First-Class Mail	1	\$2.68
Large Envelope (Domestic) (TUCSON, AZ 85701) (Weight: 0 Lb 8.20 Oz) (Estimated Delivery Date) (Friday 07/27/2018)	1	\$3.45
Certified (USPS Certified Mail #) (70151730000230639263)	1	\$2.75
Return Receipt (USPS Return Receipt #) (9590940306765196708918)	1	\$2.75
Total		\$34.05
Cash		\$100.00
Change		(\$65.95)

Text your tracking number to 28777 (2USPS) to get the latest status. Standard Message and Data rates may apply. You may also visit www.usps.com USPS Tracking or call 1-800-222-1811.

SENDER: COMPLETE THIS SECTION

- Complete items 1, 2, and 3.
- Print your name and address on the reverse so that we can return the card to you.
- Attach this card to the back of the mailpiece, or on the front if space permits.

1. Article Addressed to:

Briaz, Clerk of Court Kartik, et al, Sandra Day O'Connor U.S. Courthouse, Suite 130, 401 West Washington Street, SPC 1, Phoenix, Arizona (85003-2118)



2. Article Number (Transfer from service label)

7015 1730 0002 3063 9256

PS Form 3811, April 2015 PSN 7530-02-000-9053

COMPLETE THIS SECTION ON DELIVERY

A. Signature

B. Received by (Print name) C. Date of Delivery

D. Is delivery address different from item 1? If YES, enter delivery address below:

3. Service Type

- Adult Signature
- Adult Signature Restricted Delivery
- Certified Mail
- Certified Mail Restricted Delivery
- Collect on Delivery
- Collect on Delivery Restricted Delivery
- Priority Mail Express
- Registered Mail
- Registered Mail Restricted Delivery
- Return Receipt for Merchandise
- Signature Confirmation™
- Signature Confirmation Restricted Delivery

Page: 892 of 2782

2022-011769 MISC

09/26/2022 03:35:37 PM Receipt #: 22-9381
 Rec Fee: \$30.00 Darrell James Hill
 Gila County, Az, Sadie Jo Bingham, Recorder



890

Domestic Return Receipt

USPS Tracking®

FAQs > (<http://faq.usps.com/?articleId=220900>)

Track Another Package +

Tracking Number: 70151730000230639256

Remove X

Expected Delivery by

FRIDAY

27 JULY 2018 ⓘ

by **8:00pm** ⓘ

Delivered

July 27, 2018 at 11:43 am
Delivered, Left with Individual
PHOENIX, AZ 85003

Get Updates ▾

Text & Email Updates ▾

Tracking History ▲

July 27, 2018, 11:43 am
Delivered, Left with Individual
PHOENIX, AZ 85003

Your item was delivered to an individual at the address at 11:43 am on July 27, 2018 in PHOENIX, AZ 85003.

July 26, 2018, 4:49 pm
Departed USPS Regional Facility
PHOENIX AZ DISTRIBUTION CENTER ANNEX

July 26, 2018
In Transit to Next Facility

July 25, 2018, 9:13 pm
Arrived at USPS Regional Facility
PHOENIX AZ DISTRIBUTION CENTER ANNEX

2022-011769 MISC Page: 893 of 2782

09/26/2022 03:35:37 PM Receipt #: 22-9381
Rec Fee: \$30.00 Darrell James Hill
Gila County, Az, Sadie Jo Bingham, Recorder

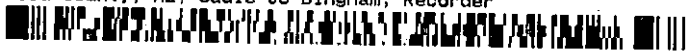

891

:AFFIDAVIT:
Claim Of The Event and Filing: Common Law Case:
Claimant Case No: CMN 7009 1410 0000 7868 5703

State of Arizona
County of Pinal

Darrell- James: Hill, man, personally appears before me, the undersigned Notary duly authorized by the laws of Arizona to administer oaths; now on this 24th day: July month: 2018 : 1 : 00 an pm being by me first duly sworn on his affirmation, affiant deposes and says:

i:man :Darrell- James: Hill, an Ohioan with the all inherent rights, am: sole beneficiary and authorized administrator of the equitable title of the DARRELL JAMES HILL ® © 1958 trust -- See: Gila County, Arizona: -- recorder.gilacountyaz.gov/recorder/web/ -- Recorder Doc. # 2017-002378, page: 198- 217 of 693, annexed; and: Gila County, Arizona: Recorder Doc. #2018-005176, page: 18- 21 of 21; and, that:

- (a) On January 3rd, 2017, i:man executed the Constitutionally preserved right to a trial by jury in suit at common law, where the value in controversy far exceeded twenty (20) dollars. By the right is and was the common law claim was ordered; however, by the man officers of the court, et al., was the right of the common law claim trespassed; and this, in the spite of the Constitutional restrictions; and, in the spite of the fee schedule for the trespass: one ounce of silver U.S. Dollar per minute, agreed upon by the officers. See: Gila County, Arizona: Recorder Doc. # 2017-002378 documents: 182-217, 238-245, 548-552, 592-608, 616, and 678-693 of 693; annexed: To wit:
- (b) On January 3th, 2017, i:man by the USPS Certified Mail No. 7009 1410 0000 7868 5703 sent to the man: Ranier: Chief Judge Collins – "Notification: Claimant Case No: CMN 7009 1410 0000 7868 5703" Recv'd on January 6th, 2017 – See: Gila County, Arizona: Recorder Doc. # 2017-002378, page: 188 of 693, annexed;
- (c) On January 3rd, 2017: i:man by the USPS Registered Mail No. RE 322 399 336 US delivered sent to the man: Brian: Clerk of Court Karth "Claimant Case No: CMN 7009 1410 0000 7868 5703" for the execution of the common law suit for a claim in a controversy of an amount greater than twenty-one dollars under the Constitutionally preserved right to a trial by jury in suit at common law, where the value in controversy shall exceed twenty dollars. See: Gila County, Arizona: Recorder Doc. # 2017-002378, page: 184- 217 of 693, annexed;
- (d) On January 4, 2017: common law claim " Claimant Case No: CMN 7009 1410 0000 7868 5703" ordered by i:man was stamped received but Not filed by the Clerk of Court;
- (e) On January 4, 2017, against express written consent, without authorization, nor contract, nor recourse, a civil action instead of the common law-action was unknowingly filed by the Clerk of Court, et al., in the spite of all of the personal risk for the violation of trust against the right of the common law claim preserved to the i:man under the contract: The Constitution for the United States of America - Bill of Rights: Amendment VII, et seq.;
- (f) From the January 2017 filing and following, in spite of the sundry written requests, and in spite of the personal risks, "(a) and (e) above": men: Ranier: Chief Judge and Brian: Clerk of Court, et al., did not file the common law case ordered, and stated in writing that 'neither would they issue summons for the common law suit submitted until and unless i:man beneficiary changed from the Constitutionally preserved right of the case for the common law suit executed to the privilege of a case in a civil action in a different court and in a form of their choosing: something that was never ordered by nor contracted to by the beneficiary.' See: Gila County, Arizona: Recorder Doc. # 2017-002378, page: 604 of 693; annexed;
- (g) Unto this date the common law claim "Claimant Case No: CMN 7009 1410 0000 7868 5703" ordered by the beneficiary: Darrell- James: Hill, is not yet filed, nor has the i:man agreed to contract for a change in the order for the common law suit; nor has there been made by the men: Ranier or Brian, et al., correction for the deception(s) or for the deprivation of the right acts coerced against the beneficiary: Darrell- James: Hill.

Autographed: 24th day: July month: 2018

Without prejudice,

Darrell James Hill

Darrell- James: Hill, beneficiary, man

Sworn to and subscribed before me now on this 24th day: July month: 2018.

Produced identification: type: Arizona Driver License.

Adrianna Ramirez
Notary

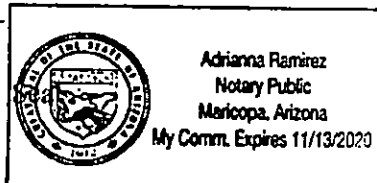

:CERTIFICATE OF PROTEST:

STATE OF ARIZONA

COUNTY OF MARICOPA

For the fact be it known that on the 25th day: July month: 2018 year A.D., at the request of the corporate entity :DARRELL JAMES HILL, by the Authorized Representative :Darrell- James: Hill, man - c/o PO Box 3806, Apache Junction, Arizona 85117 - , I: JOHN KRAISS: notary public in and for the STATE OF ARIZONA, duly appointed, commissioned and sworn, residing in the CITY: GILBERT, in the COUNTY: MARICOPA, and in the STATE aforesaid, presented the annexed instruments - See: Affiant's Statement: "AFFIDAVIT: CLAIM OF THE EVENT AND FILING: "AFFIDAVIT: JURAT: CURATIVE REGISTRATION OF THE FOUND LIVE LIFE: Darrell- James: Hill; Grantee: CESTUI QUE VIE-ESTATE TRUST NAMED: DARRELL JAMES HILL" by the man: Darrell- James: Hill of the documents made for the obtainment of the inherent and Constitutionally preserved right claimed by the man: Darrell- James: Hill - to which has been "no-reason" - no remedy response to-date from the man:Public-persons who deprived the affiant's private property-claimed; Whereupon, I, the said notary public, at the request aforesaid by these presents do solemnly protest against the man:Public-persons, Kristin: Summit County Fiscal Officer Scalise, and Katie: Executive Assistant I Mancino, and all of the man:Public-persons to whom it may concern, for the filing of the common law action presented with the protection of the same, and for all the costs, damages, and interest already incurred, and hereafter incurred, by the reason of the deprivation of the right to the property-claimed heretofore.

And: I do hereby certify that, on this same day and year above written, I deposited this "CERTIFICATE OF PROTEST" and the annexed instrument(s) - "AFFIDAVIT: CLAIM OF THE EVENT AND FILING: "AFFIDAVIT: JURAT: CURATIVE REGISTRATION OF THE FOUND LIVE LIFE: Darrell- James: Hill; Grantee: CESTUI QUE VIE-ESTATE TRUST NAMED: DARRELL JAMES HILL" -, postage-paid to the post office at the 13 East Ray Road, Gilbert, Arizona 85296 location, directed to the man parties to be charged:

Kristin: Summit County Fiscal Officer Scalise
c/o 175 South Main Street
Akron, Ohio [44308-1354]

USPS CMN 7017 1000 0000 9343 0650

Katie: Executive Assistant I Mancino
c/o 175 South Main Street
Akron, Ohio [44308]

USPS CMN 7015 1730 0002 3063 9270

Reason for the certification of the protest is: deprivation of the right with no response nor remedy to-date from the man:Public-persons who deprived the affiant's private property-claimed, as indicated in the Affiant's Statement: "AFFIDAVIT: CLAIM OF THE EVENT AND FILING: "AFFIDAVIT: JURAT: CURATIVE REGISTRATION OF THE FOUND LIVE LIFE: Darrell- James: Hill; Grantee: CESTUI QUE VIE-ESTATE TRUST NAMED: DARRELL JAMES HILL" by the affiant: Darrell- James: Hill.

IN THE WITNESS WHEREOF: I have hereunto subscribed my name and affixed my seal of office.

Notary

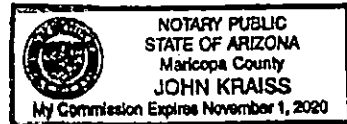

Seal

893



**:AFFIDAVIT: CLAIM OF THE EVENT AND FILING:
"AFFIDAVIT: JURAT: CURATIVE REGISTRATION OF THE FOUND LIVE LIFE: Darrell- James: Hill; Grantee: CESTUI QUE VIE-ESTATE TRUST NAMED: DARRELL JAMES HILL"**

State of Arizona
County of Pinal

Darrell- James: Hill, man, personally appears before me, the undersigned Notary duly authorized by the laws of Arizona to administer oaths; now on this 25th day: July month: 2018 : 9 : 00 am/pm, being by me first duly sworn on his affirmation, affiant deposes and says:

i:man :Darrell- James: Hill, an Ohioan with the all inherent rights, am: sole beneficiary and authorized administrator of the equitable title of the DARRELL JAMES HILL ® © 1958 trust; and, that:

- (a) On April 14th, 2018: i:man executed the right and responsibility to set for the recordation in the Summit county, Ohio state of the birth of the man beneficiary: Darrell- James: Hill: "AFFIDAVIT: JURAT: CURATIVE REGISTRATION OF THE FOUND LIVE LIFE: Darrell- James: Hill; Grantee: CESTUI QUE VIE-ESTATE TRUST NAMED: DARRELL JAMES HILL" by the USPS Registered Mail No. RE 322 399 163 US. However, the "live-life" document was denied recordation in the Summit county for the "no-reason" – no remedy given; and,
- (b) In the recourse, in good faith response for the testimony in the Jurat: "(a) above"; and, expressly willing to affirm same in open court, on the April 25th, 2018: i:man executed the right and responsibility to set for the recordation in the Summit county, Ohio state of the birth of the man beneficiary: Darrell- James: Hill, again by the Jurat: "AFFIDAVIT: JURAT: CURATIVE REGISTRATION OF THE FOUND LIVE LIFE: Darrell- James: Hill; Grantee: CESTUI QUE VIE-ESTATE TRUST NAMED: DARRELL JAMES HILL" by the USPS Registered Mail No. RE 322 399 194 US, addressed to the man: Kristen: Summit County Fiscal Officer Scalise; and to: Steve: Summit County Sheriff Barry by the USPS Registered Mail No. RE 322 399 203 US; and,
- (c) Regarding the "(b) above": the "live-life" document was again denied recordation in the Summit county for the "no-reason" and no remedy given; and: this, in the spite of the reiterated fee schedule for the trespass due until and upon the full remedy is resolved; Wherefore,
- (d) On the July 5th, 2018; as was determined in the "(b) above" to the man: Steve: Summit County Sheriff Barry (by the USPS Registered Mail No. RE 322 399 203 US) was reported to the Sheriff Barry by the USPS Certified Mail No. 7015 1730 0002 3063 9362: "AFFIDAVIT: CLAIM OF CRIMINAL WRONG-DOING... See: AFFIDAVIT: CLAIM OF CRIMINAL WRONG-DOING: DEPRIVATION OF THE PROTECTED RIGHT FOR TO RECORD DOCUMENT INTO THE PUBLIC RECORD IN CRIMINALLY VIOLATED BY THE PEOPLE AT THE SUMMIT COUNTY OHO RECORDATION AGENCY (Summit County Fiscal Office): annexed: 14 pages."
- (e) Regarding the "(b) and (c) above" fee schedule, on the July 19th, 2018, i:man sent to the man: Kristen by the USPS Certified Mail No. 7015 1730 0002 3063 9287; and: Katie by the USPS Certified Mail No. 7015 1730 0002 3063 9294: BILL OF COSTS for the fee-schedule payment due-now-paid calculated from the April 12th, 2018: 11:42a to the July 19th, 2018: 5:30p. See ":BILL OF COSTS:" annexed: 3 pages.
- (f) As of the time of this sending: i:man, beneficiary :Darrell- James: Hill have not recieved as yet notification of the resolve of this trespass from the man:persons: Kristen: Fiscal Officer or Katie: Executive Assistant I.

Autographed: 25th day: July month: 2018

Without prejudice,

Darrell- James: Hill
Darrell- James: Hill, beneficiary, man

Sworn to and subscribed before me now on this 25th day: July month: 2018.
Produced identification: type: Arizona Driver License.

Heather Wood
Notary

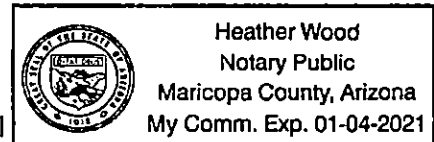



:Darrell-James: Hill, and
Beverly-Jean: Romero-Hill
PO Box 3806
Apache Junction, Arizona 85120

AFFIDAVIT: STATEMENT OF CLAIM

Re: Gila County: #2017-002378

I. For the lawful need: we :Darrell-James: Hill and Beverly-Jean: Romero-Hill on the April 12th, 2018 did assure delivery of the items by USPS Registered Mailing delivery w/ return receipt:

a: RMN RE 322 399 177 US Affidavit: Jurat: Curative Registration of the Live Life: Beverly-Jean: Romero-Hill :grantee: CESTUI QUE VIE – ESTATE TRUST NAMED: BEVERLY-JEAN: ROMERO-HILL to the Rio Arriba county, New Mexico state Recorder (attached), and:

b: RMN RE 322 399 163 US: Affidavit: Jurat: Curative Registration of the Live Life: Darrell-James: Hill :grantee: CESTUI QUE VIE – ESTATE TRUST NAMED: DARRELL-JAMES: HILL to the Summit county, Ohio state Recorder (attached)

for recordation of the documents.

For the reasons now-time unknown, the item b: RMN RE 322 399 163 US was not filed in the Summit county, Ohio state designated recorder, and was returned with the item c:

c: From: Office of the KRISTEN M SCALISE CPA, CFE, SUMMIT COUNTY FISCAL OFFICER by the "Katie Mancino, Executive Assistant 1".

II. For the lawful need: we :Darrell-James: Hill and Beverly-Jean: Romero-Hill on the April 25th, 2018 sent items b: and c: with the COVER LETTER: item d: (attached) by the USPS Registered Mailing RMN 322 399 194 US delivery w/ return receipt to take Summit county Kristen: Fiscal Officer.

d: In re: A) USPS RMN RE 322 399 163 US document "AFFIDAVIT...."

And, for the lawful need: we :Darrell-James: Hill and Beverly-Jean: Romero-Hill on the April 25th, 2018 sent to: Steve: Sheriff Barry, Summit County: COVER LETTER: item d with the reference to the criminal trespass and the itemized acquiesced fee schedule: pgs. 1- 2/ 6: item b by the USPS Registered Mailing w/ return receipt: RMN RE 322 399 203 US. For the MAILING AND DELIVERY INFORMATION: Kristin: Recorder and Steve: Sheriff, Summit County, Ohio see: item e:

e: MAILING AND DELIVERY INFORMATION: Kristin: Recorder and Steve: Sheriff, Summit County, Ohio.

JURAT

Darrell-James Hill
Darrell-James: Hill: man-beneficiary

Beverly-Jean Romero-Hill
Beverly-Jean: Romero-Hill: man-beneficiary

Affirmed and autographed before me this 11th day: May 2018

Adrianna Ramirez
Notary

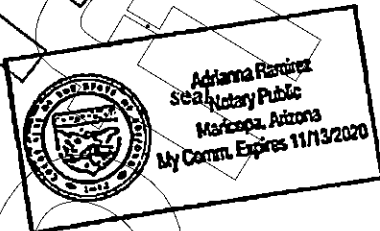

895

AFFIDAVIT:

ENCLOSURES MAILING STATEMENT

For the verification of the USPS Registered mailing of the document for the registration:
1: "AFFIDAVIT: JURAT: CURATIVE REGISTRATION OF THE LIVE LIFE: Darrell-James: Hill :Grantee: CESTUI QUE VIE -ESTATE TRUST NAMED: DARRELL JAMES HILL" with the 2: \$ _____ money order # _____
by the USPS RMN 322 399 163 US is for the intent of the recording of the document at the Recorder addressee: Summit County Fiscal Office Recording Division, 175 South Main Street, 4th Floor, Akron, OH 44308 done this 10th April: 2018.

mailee: Beverly Jean Bowen-Hill
mailee: Mark-Hewitt-Lutz

JURAT

Sworn and signed on this 10th day: April: 2018. _____ :time in my presence and before me.

Notary

seal

Unofficial Copy

896



CUSTOMER'S RECEIPT

SEE BACK OF THIS RECEIPT FOR IMPORTANT CLAIM INFORMATION

NOT NEGOTIABLE

Pay to Summit County Fiscal Office
Address 175 S. Main St, 4th Floor
Akron, OH 44308

KEEP THIS RECEIPT FOR YOUR RECORDS

Serial Number
24890959113

Year, Month, Day Post Office Amount Date
2018-04-11 852200 \$52.00 19



POSTAL MONEY ORDER

Serial Number

24890959113

\$52.00

Pay to Summit County Fiscal Office
Address 175 S. Main St, 4th Floor
Akron, Ohio

Date 19

Memo 5 pages: Curative

00000800 21

Unofficial Copy

897



DAISY MOUNTAIN
 44047 N 43RD AVE
 PHOENIX
 AZ
 85087-9998
 0363920092
 (602)275-8777 11:02 AM
 04/12/2018

Product Description	Sale Qty	Final Price
First-Class Mail Large Envelope (Domestic) (AKRON, OH 44308) (Height: 0 Lb 1.80 Oz) (Estimated Delivery Date) (Monday 04/16/2018)	1	\$1.21
Registered (Amount: \$0.00) (93USPS Registered Mail #) (RE322399163US)	1	\$11.90
Return Receipt (93USPS Return Receipt #) (9590940306765196708826)	1	\$2.75
Total		\$15.86
Cash Change		\$20.00 (\$4.14)

Registered No. RE322399163US

Postage \$ 1.21	Extra Services & Fees (continued)
Extra Services & Fees	<input type="checkbox"/> Signature Confirmation
<input type="checkbox"/> Registered Mail \$ 11.90	<input type="checkbox"/> Signature Confirmation Restricted Delivery
<input type="checkbox"/> Return Receipt (hardcopy) \$ 2.75	
<input type="checkbox"/> Return Receipt (electronic) \$ 0.00	
<input type="checkbox"/> Restricted Delivery \$ 0.00	
Total Postage & Fees \$ 15.86	
Customer Must Declare Full Value \$ 0.00	Received by 04/12/2018

OFFICIAL USE

PHOENIX, AZ 85087

DARRELL JAMES HILL, GRANTOR
 c/o Darrell James Hill Administrator
 GENERAL POST OFFICE BOX 3865
 APACHE JUNCTION, ARIZONA 85120

Summit County Fiscal Office
 Recording Division
 175 South Main Street, 4th Floor
 Akron, OH 44308

PS Form 3809, Registered Mail Receipt
 April 2016, PSN 7630-02-000-9051
 For domestic delivery information, visit our website at www.usps.com

Copy 1 - Customer (See information on Reverse)

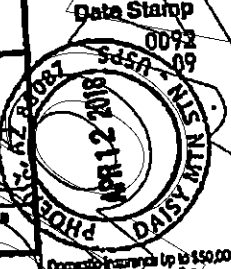

Text your tracking number to 28777 (2USPS) to get the latest status. Standard Message and Data rates may apply. You may also visit USPS.com USPS Tracking or call 1-800-222-1811

In a hurry? Self-service kiosks offer quick and easy check Associate can show

Save this receipt for insurance. For info on an insurance claim, https://www.usps.com

SENDER: COMPLETE THIS SECTION

- Complete items 1, 2, and 3.
- Print your name and address on the reverse so that we can return the card to you.
- Attach this card to the back of the mailpiece, or on the front if space permits.

Article Addressed to:
 Summit County Fiscal Office
 Recording Division
 175 South Main Street, 4th Floor
 Akron, OH 44308



PS Form 3811, April 2016 PSN 7630-02-000-9053

COMPLETE THIS SECTION ON DELIVERY

A. Signature
 X *Therly Hill* Agent Addressee

B. Received by (Printed Name)
 C. Date of Delivery

Is the delivery address different from item 1? Yes No
 YES, enter delivery address below No

3. Service Type
- Adult Signature
 - Adult Signature Restricted Delivery
 - Certified Mail
 - Certified Mail Restricted Delivery
 - Collect on Delivery
 - Collect on Delivery Restricted Delivery
 - Priority Mail Express®
 - Registered Mail™
 - Registered Mail Restricted Delivery
 - Return Receipt for Merchandise
 - Signature Confirmation™
 - Signature Confirmation Restricted Delivery

Domestic Return Receipt

Unrecorded

898



**KRISTEN M SCALISE CPA, CFE
SUMMIT COUNTY FISCAL OFFICER
175 S. MAIN STREET, AKRON, OHIO 44308-1354**

The document(s) we received for Recording is/are being returned to your office for the reasons indicated below. If you have any questions you may wish to consult legal counsel before proceeding with the final recording process, as **THIS OFFICE CANNOT GIVE LEGAL ADVICE.**

- Proper recording fee-\$ _____ (FEE PER DOCUMENT \$28.00 first two pgs., \$8.00 ea. additional page, \$4.00 for each cross reference, \$20.00 if not compliant to ORC 317.114)
- This document is not compliant with ORC 317.114 because of _____ margins, _____ font size, _____ ink color/highlighting
- Unable to refund cash
- Check(s) should be made payable to **SUMMIT COUNTY FISCAL OFFICE**
- Check not _____ signed _____ enclosed, _____ within 90 days
- Not recordable in this _____ County _____ Office _____ State
- Document not _____ signed _____ notarized (ORC5301.01)
- Notary didn't acknowledge the document properly (see attached list)
- Official capacity (Title) of corporate signatory is absent
- Institution/Corporate name **MUST** be typed above signing officer's signature or in notary clause
- Contents of document not sufficiently legible (O.R.C.317.112)
- Signatures must be original and legible (O.R.C.317.112) type or print names below signature (Effective February 1, 2001 witnesses are no longer needed, however, if they appear on a document they also **MUST** be legible)
- "This instrument was prepared by (name)" must appear on the document (O.R.C.317.111)
- Grantor/Grantee name(s) is missing
- Power of Attorney must be recorded prior to recording documents that are signed by the POA (O.R.C.1337.04), and the reference is required to be listed on the document.
- When re-recording a document **ALL PAGES** must be included.
- Volume and page/reception number for cross-reference is _____ absent _____ incorrect (documents filed prior to 3/24/97 will have a volume and page, documents filed after 3/24/97 will have an 8 digit reception number)
- Cancellation clause is _____ not signed _____ incorrect
- No assignment of mortgage shall be accepted unless it contains the mailing address of the assignee (O.R.C.5301.32)
- NO** Blanket Releases/Assignments (O.R.C.317.37)
- Mentioned exhibits are not attached to document
- Legal description appears to be _____ absent _____ incorrect _____ illegible _____ not a complete legal description
- Poor reproduction quality (O.R.C. 317.112) due to _____ paper color _____ print size _____ color of ink _____ highlighting _____ exhibits
- Include a self-addressed stamped envelope
- A return address must be included on all documents. **IT MUST MATCH THE RETURN ENVELOPE EXACTLY!**
- Other _____

**KRISTEN M. SCALISE CPA, CFE
FISCAL OFFICER, COUNTY OF SUMMIT**

KATIE MANGINO
Executive Assistant I
Summit County Fiscal Office
Ohio Building
175 S. Main Street
Akron, OH 44308

Phone: 330.643.2530
Fax: 330.643.8154
E-mail: kmangino@summitoh.net
http://FiscalOffice.summitoh.net



4 WHEN RETURNING CORRECTED DOCUMENTS

_____, Day **2018-005176 MISC Page: 13 of 21**
M-4:00PM 05/14/2018 02:29:31 PM Receipt #: 18-3665
 Rec Fee: \$28.00 Darrell James Hill
 Gila County, Az, Sadie Jo Bingham, Recorder



2022-011769 MISC Page: 901 of 2782
 09/26/2022 03:35:37 PM Receipt #: 22-9381
 Rec Fee: \$30.00 Darrell James Hill
 Gila County, Az, Sadie Jo Bingham, Recorder



899

7015 1730 0002 3063 9270

U.S. Postal Service™ CERTIFIED MAIL® RECEIPT

Domestic Mail Only

For delivery information, visit our website at www.usps.com™.

OFFICIAL USE

Certified Mail Fee \$3.45

Extra Services & Fees (check box, add fee as indicated)

Return Receipt (hardcopy) \$0.00

Return Receipt (electronic) \$0.00

Certified Mail Restricted Delivery \$40.00

Adult Signature Required \$0.00

Adult Signature Restricted Delivery \$0.00



Postage \$1.84

Total Postage and Fees \$8.04

Sent To
 Street and Apt. No., or PO Kristin: Executive Assistant / Mancini
175 South Main Street
 City, State, ZIP+4® Akron, Ohio [44308-1354]

PS Form 3800, April 2015 PSN 7530-02-000-9047 See Reverse for Instructions

HIGLEY
 3324 E RAY RD
 HIGLEY
 AZ
 85236-4500
 0338850381
 07/25/2018 (800)275-8777 11:49 AM

Product Description	Sale Qty	Final Price
Prepaid Mail	1	
(Weight: 9 lbs. 7.00 oz.)		
(Destination: ROSEVILLE, CA 95747)		
(Acceptance Date: 07/25/2018 11:42:32)		
(Label #: 420957479405503699300269524933)		

First-Class Mail	1	\$1.84
Large Envelope (Domestic) (AKRON, OH 44308) (Weight: 0 Lb 5.00 Oz) (Estimated Delivery Date) (Saturday 07/28/2018)		
Certified (USPS Certified Mail #) (70151730000230639270)	1	\$3.45
Return Receipt (USPS Return Receipt #) (9590940227857069640105)	1	\$2.75
First-Class Mail	1	\$2.05
Large Envelope (Domestic) (AKRON, OH 44308) (Weight: 0 Lb 5.10 Oz) (Estimated Delivery Date) (Saturday 07/28/2018)		
Certified (USPS Certified Mail #) (7017100000093430650)	1	\$3.45
Return Receipt (USPS Return Receipt #) (9590940227857069640099)	1	\$2.75

0590 4343 0000 0000 2102

U.S. Postal Service™ CERTIFIED MAIL® RECEIPT

Domestic Mail Only

For delivery information, visit our website at www.usps.com™.

OFFICIAL USE

Certified Mail Fee \$3.45

Extra Services & Fees (check box, add fee as indicated)

Return Receipt (hardcopy) \$0.00

Return Receipt (electronic) \$0.00

Certified Mail Restricted Delivery \$40.00

Adult Signature Required \$0.00

Adult Signature Restricted Delivery \$0.00



Postage \$2.05

Total Postage and Fees \$8.25

Sent To
 Street and Apt. No., or PO Kristin: Summit County Fiscal Officer Scalle
175 South Main Street
 City, State, ZIP+4® Akron, Ohio [44308-1354]

PS Form 3800, April 2015 PSN 7530-02-000-9047 See Reverse for Instructions

First-Class Mail	1	\$2.68
Large Envelope (Domestic) (AKRON, OH 44308) (Weight: 0 Lb 5.10 Oz) (Estimated Delivery Date) (Saturday 07/28/2018)		
Certified (USPS Certified Mail #) (7017100000093430650)	1	\$3.45
Return Receipt (USPS Return Receipt #) (9590940227857069640099)	1	\$2.75

SENDER: COMPLETE THIS SECTION

Complete items 1, 2, and 3.

Print your name and address on the reverse so that we can return the card to you.

Attach this card to the back of the mailpiece or on the front if space permits.

Article Addressed to:

Kristin: Executive Assistant / Mancini
 175 South Main Street
 Akron, Ohio [44308-1354]



7015 1730 0002 3063 9270

COMPLETE THIS SECTION ON DELIVERY

Agent
 Addressee
 B. Received by (Print name) x Higley, Kristin

C. Date of Delivery _____

D. Is delivery address different from item 1? Yes
 If YES, enter delivery address below: No

Number to 28777 at ext status.
 Data rates may visit www.usps.com
 1-800-222-1811.

our Mail Packages FREE delivery.com

3. Service Type

Adult Signature

Adult Signature Restricted Delivery

Certified Mail®

Certified Mail Restricted Delivery

Collect on Delivery

Collect on Delivery Restricted Delivery

Priority Mail Express®

Registered Mail™

Registered Mail Restricted Delivery

Return Receipt for Merchandise

Signature Confirmation™

Signature Confirmation Restricted Delivery

2022-011769 MISC Page: 902 of 2782
 09/26/2022 03:35:37 PM Receipt #: 22-9381
 Rec Fee: \$0.00 Darrell James Hill
 Giles County, Az, Sadie Jo Bingham, Recorder

Track Another Package +

Tracking Number: 70151730000230639270

Remove X

Your item was delivered to an individual at the address at 12:10 pm on July 30, 2018 in AKRON, OH 44308.

✓ Delivered

July 30, 2018 at 12:10 pm
Delivered, Left with Individual
AKRON, OH 44308

Get Updates ▾

Text & Email Updates ▾

Tracking History ▲

July 30, 2018, 12:10 pm
Delivered, Left with Individual
AKRON, OH 44308
Your item was delivered to an individual at the address at 12:10 pm on July 30, 2018 in AKRON, OH 44308.

July 28, 2018, 11:18 am
Delivery Attempted - No Access to Delivery Location
AKRON, OH 44320

July 28, 2018, 10:30 am
Departed USPS Regional Facility
AKRON OH DISTRIBUTION CENTER

July 27, 2018, 12:18 pm
Arrived at USPS Regional Destination Facility
AKRON OH DISTRIBUTION CENTER

July 26, 2018, 12:47 am
Departed USPS Regional Origin Facility
PHOENIX AZ DISTRIBUTION CENTER ANNEX

July 25, 2018, 9:08 pm
Arrived at USPS Regional Origin Facility
PHOENIX AZ DISTRIBUTION CENTER ANNEX

July 25, 2018, 3:04 pm
Departed Post Office

901

2022-011769 MISC Page: 903 of 2782

09/26/2022 03:35:37 PM Receipt #: 22-9381
Rec Fee: \$30.00 Darrell James Hill
Gila County, Az, Sadie Jo Bingham, Recorder



0270 5906 2000 3063 9270

U.S. Postal Service™
CERTIFIED MAIL® RECEIPT
Domestic Mail Only

For delivery information, visit our website at www.usps.com

OFFICIAL USE

Certified Mail Fee \$3.45
Extra Services & Fees (check box, add fee as appropriate)
 Return Receipt (hardcopy) \$2.75
 Return Receipt (electronic) \$0.00
 Certified Mail Restricted Delivery \$0.00
 Adult Signature Required \$0.00
 Adult Signature Restricted Delivery \$0.00

Postage \$1.84
Total Postage and Fees \$8.04

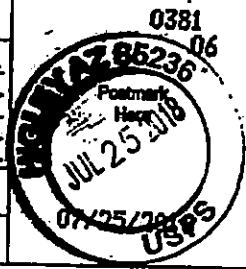

Sent To
Street and Apt. No., or PO: Katic Executive Assistant / Manager
175 South Main Street
Akron, Ohio (44308-1354)
City, State, ZIP+4®

PS Form 3800, April 2015 See Reverse for Instructions

HIGLEY
3324 E RAY RD
HIGLEY
AZ
85236-4500
0338850381
07/25/2018 (800)275-8777 11:49 AM

Product Description Sale Qty Final Price
Prepaid Mail 1
(Weight: 9 lbs. 7.00 oz.)
(Destination: ROSEVILLE, CA 95747)
(Acceptance Date: 07/25/2018 11:42:32)
(Label #: 420957479405503699300269524933)

First-Class Mail 1 \$1.84
Large Envelope (Domestic) (AKRON, OH 44308) (Weight: 0 Lb 5.00 Oz) (Estimated Delivery Date) (Saturday 07/28/2018)
Certified 1 \$3.45
(USPS Certified Mail #) (70151730000230639270)
Return Receipt 1 \$2.75
(USPS Return Receipt #) (9590940227857069640105)
First-Class Mail 1 \$2.05
Large Envelope (Domestic) (AKRON, OH 44308) (Weight: 0 Lb 5.10 Oz) (Estimated Delivery Date) (Saturday 07/28/2018)

Certified 1 \$3.45
(USPS Certified Mail #) (7017100000093430650)
Return Receipt 1 \$2.75
(USPS Return Receipt #) (9590940227857069640099)
\$2.68

\$100.00
(\$65.95)

0590 5496 0000 9343 0650

U.S. Postal Service™
CERTIFIED MAIL® RECEIPT
Domestic Mail Only

For delivery information, visit our website at www.usps.com

OFFICIAL USE

Certified Mail Fee \$3.45
Extra Services & Fees (check box, add fee as appropriate)
 Return Receipt (hardcopy) \$2.75
 Return Receipt (electronic) \$0.00
 Certified Mail Restricted Delivery \$0.00
 Adult Signature Required \$0.00
 Adult Signature Restricted Delivery \$0.00

Postage \$2.05
Total Postage and Fees \$8.25

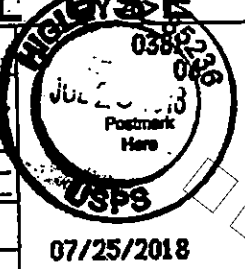

Sent To
Street and Apt. No., or PO: Kristin Summit County Fiscal Officer Scales
175 South Main Street
Akron, Ohio (44308-1354)
City, State, ZIP+4®

PS Form 3800, April 2015 See Reverse for Instructions

A. Signature
X
B. Delivered By (Printed Name) C. Date of Delivery
ber to 28777
est status.
ata rates may
sit www.usps.com
1-800-222-1811.

D. Is delivery address different from item 1? Yes
If YES, enter delivery address below: No
r Mail
ackages
FREE @
livery.com

SENDER: COMPLETE THIS SECTION

- Complete items 1, 2, and 3.
- Print your name and address on the reverse so that we can return the card to you.
- Attach this card to the back of the mailpiece, or on the front if space permits.

Article Addressed to:
Kristin Summit County Fiscal Officer Scales
175 South Main Street
Akron, Ohio (44308-1354)



Article Number (Transfer from service label)
0590 5496 0000 9343 0650

COMPLETE THIS SECTION ON DELIVERY

3. Service Type
 Adult Signature
 Adult Signature Restricted Delivery
 Certified Mail®
 Certified Mail Restricted Delivery
 Collect on Delivery
 Priority Mail Express®
 Registered Mail™
 Registered Mail Restricted Delivery
 Return Receipt for Merchandise
 Signature Confirmation™
 Signature Confirmation Restricted Delivery

2022-011769 MISC Page: 904 of 2782
09/25/2022 03:35:37 PM Receipt #: 22-9381
Rec Fee: \$30.00 Darrell James Hill
Gila County, AZ, Sadie Jo Bingham, Recorder

USPS Tracking®

FAQs > (<http://faq.usps.com/?articleId=220900>)

Track Another Package +

Tracking Number: 7017100000093430650

Remove X

Your item was delivered to an individual at the address at 12:10 pm on July 30, 2018 in AKRON, OH 44308.

✓ Delivered

July 30, 2018 at 12:10 pm
Delivered, Left with Individual
AKRON, OH 44308

Get Updates ▾

Text & Email Updates ▾

Tracking History ▲

July 30, 2018, 12:10 pm
Delivered, Left with Individual
AKRON, OH 44308

Your item was delivered to an individual at the address at 12:10 pm on July 30, 2018 in AKRON, OH 44308.

July 28, 2018, 11:18 am
Delivery Attempted - No Access to Delivery Location
AKRON, OH 44320

July 28, 2018, 10:30 am
Departed USPS Regional Facility
AKRON OH DISTRIBUTION CENTER

July 27, 2018, 12:18 pm
Arrived at USPS Regional Destination Facility
AKRON OH DISTRIBUTION CENTER

July 26, 2018, 12:47 am
Departed USPS Regional Origin Facility
PHOENIX AZ DISTRIBUTION CENTER ANNEX

July 25, 2018, 9:08 pm
Arrived at USPS Regional Origin Facility
PHOENIX AZ DISTRIBUTION CENTER ANNEX

July 25, 2018, 3:04 pm
Departed Post Office

2022-011769 MISC Page: 905 of 2782

09/26/2022 03:35:37 PM Receipt #: 22-9381

Rec Fee: \$30.00 Darrell James Hill

Gila County, Az, Sadie Jo Bingham, Recorder



903

Official Copy

:Darrell-James: Hill :man, administrator: c/o PO Box 3806, Apacl

:Kristen M :Fisc. Officer Scalise CPA, CFE, public servant
c/o :Katie :Exec. Asst.~ I Mancino, public servant
Summit County Fiscal Office
Ohio Building
178 S. Main Street
Akron, Ohio 44308-1354
Telephone: 330-643-2530
Fax: 330-643-8154

:Steve :Sheriff Barry, Summit county
53 University Ave.
Akron, Ohio 44308
Telephone: 330-643-2154
Fax: 330-434-2701

USPS RMN RE 322 399 217 US

USPS RMN RE 322 399 194 US

In re: A) USPS RMN RE 322 399 163 US document "AFFIDAVIT: JURAT: CURATIVE REGISTRATION OF THE LIVE LIFE: Darrell-James: Hill: Grantee: CESTUI OUE VIE -ESTATE TRUST NAMED: DARRELL JAMES HILL", with the attached US POSTAL MONEY ORDER #24890959113 ~Delivered: April 18th, 2018; and, B) Your accompanying form: "KRISTEN M SCALISE- Rev 7/19/17... THIS OFFICE CANNOT GIVE LEGAL ADVICE ... form, with the Katie Mancino, Exec. Assistant I, business card stapled thereon ~ A) AND B) stapled together as received; ATTACHED.

Dear Kristen, Katie, Steve; Greetings,

Kristen :i :Darrell-James: Hill am: Ohioan born on the land in the Summit county Ohio state territory as the Certificate Of Birth established this fact of my nationality and standing: common law owner, one of the people.

:You are man acting in the role of PUBLIC SERVANTS. And, failure of your public duty with the without-remedy-denial of this man's document for the recordation is denied. And, as provided, your without-remedy-attached-denial-form instructs to this man to seek legal advice for to decipher your hypothetically legitimate denial of a common law public service duty and obligation² to the Ohio state national :Darrell-James: Hill. Your without-cause-denial process employed by your creating the impasse is effectively coercive and thereby tantamount to the giving legal advice to this Ohio state national. :i do not consent to your legal advice. Furthermore, the document for the recordation is Not a statutory request. To wit:

This man's document for the recordation is a common law exercise of the right and responsibility of the man-beneficiary and administrator :Darrell-James: Hill¹. And, i: administrator require you :public trustee to file the referenced document now. Moreover:

Important to note; under the paragraph number four, of seq.: "INTENT OF THE CLAIM: CURATIVE REGISTRATION AND RECORDATION OF THE FOUND LIVE LIFE: Darrell-James: Hill", continuing on page 2/4, b.i) "READ CAREFULLY"; the fee schedule for the trespass in your denial-to-record this common law document in the Summit county Ohio state is specified. For the any further trespass of your public trustee oath, duty or obligation to this Ohioan is thereupon-heretofore-willful; and: fee is thereupon due-now-upon-request beginning from the day of your receipt of the document: April 18th, 2018; 11:42:am., and ending upon the resolve of this matter despite any legal proceedings, and without statute of limitation.

:Steve :Notice of a common law crime is hereby now upon this receipt before you and a known crime has and, influenced upon the response to this man's document, has is occurring in your county against the Ohio state national :Darrell-James: Hill. Upon this, as stated above, for the any further damage, an Affidavit of Claim of Criminal Activity will be issued to your office for the reimbursement of these additional costs and for the payment of the fee schedule due-payable-now upon the request by :Darrell-James: Hill for the deprivation-of-right injury(s).

:i affirm the all herein is true and correct and will testify to the same in the open courts.

:Day :April 25, 2018

Darrell-James Hill
:Darrell-James: Hill :man, administrator

JURAT

Arizona State
County Pfual

Today presented a living man proven to me to be Darrell-James: Hill who affirmed and autographed this testimony before me this 25th dly of the month April in the year Two thousand eighteen, a.d.

Arlanna Ramirez
PUBLIC NOTARY

MY COMMISSION EXPIRES ON: 11/13/2020

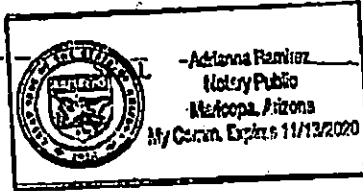

- 1 See: Ohio Stream Management Guide: Guide No. 02. (Last viewed: 04/24/2018: <http://groundwater/portals/soilwater/pdf/atrcamp/stfs02.pdf>) in the nature of: ORC Title 53, Chapter 5301.252 .
- 2 See: 18 U.S. Code § 2071 – Concealment, removal, or mutilation generally
- 3 See: International Covenant On Civil and Political Rights: 102d Congress, 2d Session; Exec. Rep 102-23. (Last viewed: 04/24/2018: <http://stateswoman/documents/organization/235639.pdf>); p. 9, No. 5. *Federalism*.

Report of Criminal Activity to :Steve: Summit County Sheriff Barry: USPS RMN RE 322 399 203 US
2nd mailing of 1st document: Kristin c/o Katie: USPS RMN 322 399 194 US :April 25, 2018 1/1

904

APACHE JUNCTION
 151 W SUPERSTITION BLVD
 APACHE JUNCTION
 AZ
 85120-9998
 0302590130
 04/25/2018 (800)275-8777 1:55 PM

Product Description	Sale Qty	Final Price
First-Class Mail Large Envelope (Domestic) (AKRON, OH 44308) (Weight: 0 Lb 2.10 Oz) (Estimated Delivery Date) (Saturday 04/28/2018)	1	\$1.42
Registered (Amount: \$21.00) (USPS Registered Mail #) (RE322399194US)	1	\$12.60
Return Receipt (USPS Return Receipt #) (9590940306765195708840)	1	\$2.75

First-Class Mail Large Envelope (Domestic) (AKRON, OH 44308) (Weight: 0 Lb 1.30 Oz) (Estimated Delivery Date) (Saturday 04/28/2018)	1	\$1.21
Registered (Amount: \$21.00) (USPS Registered Mail #) (RE322399203US)	1	\$12.60
Return Receipt (USPS Return Receipt #) (9590940306765195708857)	1	\$2.75

Total \$33.33
 Cash Change \$40.00 (\$6.67)

Text your tracking number to 28777 (2USPS) to get the latest status. Standard Message and Data Rates may apply.

Registered No. RE322399194US Date Stamp

Postage \$ 1.42	Extra Services & Fees
Extra Services & Fees	Registered Mail \$ 12.60
Return Receipt (hardcopy) \$ 2.75	Return Receipt (electronic) \$ 0.00
Restricted Delivery \$ 0.00	Total Postage & Fees \$ 14.77
Customer Must Declare Full Value \$ 21.00	Received by 04/25/2018

APACHE JUNCTION, AZ 85120

FROM: Darrell James Hill, Administrator, c/o PO Box 3806, Apache Junction, Arizona 85120

TO: Kristen M. Flus, Officer Scottie CPA, CFE, Summit County First Office, Akron, Ohio 44308

PS Form 3806, Registered Mail Receipt April 2015, PSN 7530-02-000-9051 For domestic delivery information, visit our website at www.usps.com

Registered No. RE322399203US Date Stamp 0130 77

Postage \$ 1.21	Extra Services & Fees
Extra Services & Fees	Registered Mail \$ 12.60
Return Receipt (hardcopy) \$ 2.75	Return Receipt (electronic) \$ 0.00
Restricted Delivery \$ 0.00	Total Postage & Fees \$ 14.56
Customer Must Declare Full Value \$ 21.00	Received by 04/25/2018

APACHE JUNCTION, AZ 85120

FROM: Darrell James Hill, Administrator, c/o PO Box 3806, Apache Junction, Arizona 85120

TO: Steve Sheriff Barry, Summit County, Ohio State, Akron, Ohio 44308

PS Form 3806, Registered Mail Receipt April 2015, PSN 7530-02-000-9051

SENDER: COMPLETE THIS SECTION

- Complete items 1, 2, and 3.
- Print your name and address on the reverse so that we can return the card to you.
- Attach this card to the back of the mailpiece, or on the front if space permits.

1. Article Addressed to:
:Kristen M :Pisc. Officer Scalise CPA, CFE
Summit County Fiscal Office
Ohio Building
178 S. Main Street
Akron, Ohio 44308-1354



9590 9403 0678 5198 7088 40

2. Article Number (Transfer from service label)
RE 322 399 194 US

A. Signature

X

- Agent
- Addressee

B. Received by (Printed Name)

C. Date of Delivery

D. Is delivery address different from item 1? Yes
If YES, enter delivery address below: No

3. Service Type

- Adult Signature
- Adult Signature Restricted Delivery
- Certified Mail
- Certified Mail Restricted Delivery
- Collect on Delivery
- Delivery Restricted Delivery
- Restricted Delivery (over \$500)
- Priority Mail Express
- Registered Mail™
- Registered Mail Restricted Delivery
- Return Receipt for Merchandise
- Signature Confirmation™
- Signature Confirmation Restricted Delivery

PS Form 3811, April 2015 PSN 7530-02-000-9063

Domestic Return Receipt

Unofficial Copy

906



05/14/2018 02:29:31 PM Receipt #: 18-3665
Rec Fee: \$28.00 Darrell James Hill
Gila County, Az, Sadie Jo Bingham, Recorder

SENDER: COMPLETE THIS SECTION

- Complete items 1, 2, and 3.
- Print your name and address on the reverse so that we can return the card to you.
- Attach this card to the back of the mailpiece, or on the front if space permits.

1. Article Addressed to:

Steve Sheriff Barry
53 University Ave.
Akron, Ohio 44308



9590 8403 0676 5198 7088 57

2. Article Number (transfer from service label)

11 RA1322 1399 1203/US

PS Form 3817, April 2016 PSN 7530-02-000-9053

COMPLETE

A. Sign

[Signature]

- Agent
- Addressee

B. Received by (Printed Name)

Bitter Marshall

C. Date of Delivery

- Yes
- No

If YES, enter delivery address below:

3. Service Type

- Adult Signature
- Adult Signature Restricted Delivery
- Certified Mail
- Certified Mail Restricted Delivery
- Collect on Delivery
- Collect on Delivery Restricted Delivery
- Priority Mail Express
- Registered Mail
- Registered Mail Restricted Delivery
- Return Receipt for Merchandise
- Signature Confirmation
- Signature Confirmation Restricted Delivery

Domestic Return Receipt

Unofficial Copy

09/26/2022 03:35:37 PM Receipt #: 22-9381
Rec Fee: \$30.00 Darrell James Hill
Gila County, Az, Sadie Jo Bingham, Recorder



AFFIDAVIT JURAT:
CURATIVE REGISTRATION OF THE LIVE LIFE: Darrell-James: Hill
:Grantee: CESTUI QUE VIE - ESTATE TRUST NAMED: DARRELL JAMES HILL

L.S.

Returnee:
DARRELL JAMES HILL, GRANTOR
c/o Darrell-James: Hill: Administrator
GENERAL POST OFFICE BOX 3806
APACHE JUNCTION, ARIZONA 85120

FOR THE PROVIDING OF THE FILING OF THE NAME[S] WHEN BUSINESS IS CONDUCTED UNDER ASSUMED NAME: "SESSIONS LAW 145:1907; CHAPTER 145 [H.B. 64] OF THE STATE OF WASHINGTON; AN ACT PROVIDING THAT WHEN ANY BUSINESS OTHER THEN A CORPORATION(S) OR LIMITED PARTNERSHIP, IS CONDUCTED UNDER AN ASSUMED NAME, A CERTIFICATE SHOWING THE REAL PARTIES IN INTEREST SHALL BE FILED WITH THE COUNTY CLERK AND FIXING A PENALTY x 2. TOGU BE DEEMED A PUBLIC OFFICER YOU MUST PRODUCE AND BE VETTED BY THE ADMINISTRATOR OF THIS DOCUMENT, A LETTER OF INTENT, A LETTER OF COMPLIANCE WITH ALL STATE AND FEDERAL RULES AND REGULATIONS AS PRESCRIBED BY THE SECRETARY OF STATE OR ANY PRIVATE PERSON WHO DOES NOT PROPERLY IDENTIFY THEMSELVES UPON REQUEST BY PRODUCING A BUSINESS LICENSE, A UBI NUMBER, AND A BOND FILLED OUT IN THE C.A.P. NAME ON THIS CERTIFICATE. ARE FINED ON THE SPOT FOR 500.00 IN CONSIDERATION. FEE SCHEDULE; TO BE DETERMINED BY THE HEAD ADMINISTRATOR OF THIS DOCUMENT AT THE TIME OF ENGAGEMENT. And Also The Corresponding Session Laws Of The State Of Ohio including, but not limited to: 129th General Assembly file No. 9, HB 9, §1: A) Chapter 1307, as relates to treaty; B) Chapter 1301 as relates to: i) transactions entered into before 7-1-62; ii) reservation of rights, and obtainment of remedy in 'Common Law'; and, C) Chapter 1303 as relates to: i) negotiable instruments, ii) holder in due course. And, 130th General Assembly File No. 41, HB 72, §1: D) chapter 5301 as relates to memorandum of trust. And, 2008 HB 332: Chapter 1701 as relates to transfer of reserved name.

For where the GRANTOR: DARRELL JAMES HILL is a Cestui Que Vie Trust formed without the knowledge or consent of the Grantee: Darrell-James: Hill, and has accumulated unauthorized debt against the ESTATE Trust to the benefit of non-owners as secondary non-holder beneficiaries merely presumed to exist and claiming to have an interest in the Estate with a presumption established upon the MUNICIPAL LAW OF THE DISTRICT OF COLUMBIA and the DISTRICT OF COLUMBIA MUNICIPAL CORPORATION. Therefore:

CLAIM OF THE ARTICLE IV⁴, CESTUI QUE VIE ACT OF 1666: Darrell-James: Hill

i: man: actual Grantee of the Estate Trust DARRELL JAMES HILL, the living man known to the public as: Darrell-James: Hill, by the inherent power to manage all affairs, claim now the provision of Article IV of the Cestui Que Vie Act of 1666 as a man "having been found live" and owed all of the benefit, control, and interest in the Grantor Trust Estate set free and clear of all liens, debts, titles held under color of law, titles, fees, and all other encumbrances established by the United States of America, Inc., THE UNITED STATES OF AMERICA, INC., the UNITED STATES, (INC.) and all and any franchises thereof ab initio from the date of first registration of the Estate Trust: "DARRELL JAMES HILL," as relates herein to: Darrell-James: Hill, and all and any derivatives thereof/therefrom, including but not limited to DARRELL JAMES HILL. Furthermore:

INTENT OF THE CLAIM: CURATIVE REGISTRATION AND RECORDATION OF THE FOUND LIVE LIFE: Darrell-James: Hill

a) Re-vestment to the actual OWNER-Holder In Due Course of the Estate Name and in the Estate Property and in the All Interest Due:

a.i) Public And Private Recognition: Grantee as the In Lawful Title Holder In The Due Course of The Foreign Grantor Trust Estate Named: DARRELL JAMES HILL, et seq., as of 20 November 1958.

a.ii) For The Public And Private Acknowledgment and Settlement: thus:

1. Usufruct of The Cestui Que Vie Trust Entity named herein as described is Now-to-fore Denied; all usufruct activity must cease forthwith now;
2. Re-vestment to the Grantee Holder in due Course: Darrell-James: Hill of the all of the accounts with the accounting to the penny is required to be provide forthwith now;

- 1 Registration means: USPS RMN 322 399 163 US w/ return receipt
- 2 Live-Life means: now-time live status of the man in this life
- 3 Real Party in Interest: 1:man :darrell james of the family hill, also synonymously expressed as :Darrell-James: Hill Given name and Surname of the Ohloan man-male child born in the city of the Akron with the birth-day: twentieth-day: November-month: one thousand nine hundred fifty-eight -year a.d. as the progeny of the ancestry people-parties: birth-mother man-female, Ora-Lee: (Archer) Hill and birth-father man-male, Clarence: Hill by their marriage under Almighty God.
- 4 See COPY CERTIFICATION: a) Certificate of Birth and b) Arizona Driver License: Darrell-James: Hill, p. 3/4
- 5 Cestui Que Vie means: Cestui Que Vie Trust as relates to The Cestui Que Vie Act 1666, the/an Estate Trust named: DARRELL JAMES HILL established upon/at the birth of the Live-life man-beneficiary: Darrell-James: Hill.
- 6 Article IV - "If the supposed dead Man prove to be alive, then the Title is re-vested. Action for mean Profits with Interest."

Affidavit: Jurat: Curative Registration : Dar

3. All of the records of all of the accounts of the non-usufruct and usufruct status/ condition are required re-vested forthwith now in a written report per each account in descending chronology; and,
4. All related records in fact must be provided upon this registration/ recordation; trespass/ theft/ obfuscation by the commission/omission is wrongdoing in perpetuity.

b) Trespass Upon The Estate Trust Re-Vestment

b.i) ***READ CAREFULLY*** :Fee Schedule for the trespass upon/ against this Cestui Que Vie Trust of 1666- Article IV re-vest of the Estate Trust property to the Holder in Due Course Darrell-James: Hill Is with the cost of one pre-1933 one-ounce- 99% or higher-gold United States Coin per minute cumulative from this registration until upon the full remedy is resolved; and: all of the any amount due shall be forthwith now-payable subject to the tacit procurator in any court upon the grantee's request.

b.ii) All violators, agents, actors, etc. and/or proxies under the color of law and arising and/or sustaining action under the color of law authority presumably claimed and/or authorized by any corporation, association, of subcontractor, agency or agent of any kind or the like in the violating and/or attempting to violate the political status and/or the In Title Order(s) of the Grantee at any time now of the past, or of the present, or of the future must be liable severally, and jointly, by the tacit procurator to this certificate as an affidavit of the obligation in the normal commercial sense. Such is the severity representing accounts receivable; there is a lien upon the real and movable property, malpractice insurance and performance bonds of any such violators in perpetuity and Not dischargeable in the bankruptcy court nor subject to any probate claim. For all of the time(s) the owner-holder in due course-property is exempt from third party levy, and all related vessels in his commerce are tax pre-paid.

c) Grantee Administration: Commercial Account(s)

c.i) The assumed/ registered names are as designed to conduct business in the commerce and furthermore are to accompany any continued or new business account administration heretofore executed by this Owner-Holder in Due Course: Darrell-James: Hill Grantee.

1. Under the any form or the creation of a qualification or an attachment of any condition, the United States and the United States of America, however styled or construed, their agents, et al, can Not in effect, inflict a punishment for a past act which was not punishable at the time in was committed and which was not the knowing, willing, and consensual act of the actual Holder in Due Course of the given name and estate⁷.

:BUSINESS INFORMATION

LEGAL ENTITY: HEIR GRANTEE, PRIVATE, PUBLIC, SIGNATURE TRUST

BUSINESS DESCRIPTION: COMMERCE, GRANTOR, PRIVATE, PUBLIC, SIGNATORY

BUSINESS NAME: dba DARRELL JAMES HILL and HILL, DARRELL JAMES and DARRELL J. HILL and all and any derivatives thereof in any way related to the ESTATE so NAMED.

POST OFFICE ADDRESS: c/o GENERAL POST OFFICE BOX 3806, APACHE JUNCTION, ARIZONA 85120

:OWNER INFORMATION

True and Real

Trade Name Title: Grantee, Private Creditor, Signatory, Beneficiary, Holder, Transferee:

Appellation: STYLE: Given Name and Surname

Given Name: Darrell-James

Surname: Hill

Post Office Address

(Physical): c/o General Post Office Box 3806, Apache Junction, Arizona, zip code exempt;

Post Master Location: 151 Superstition Boulevard, Apache Junction, AZ, Postal Code 85120.

:HABEAS CORPUS

iman :Darrell-James: Hill claim on the perpetual writ of the Habeas Corpus to institute and maintain actions of any kind in the court/COURT of "this" state while maintaining true domicile on the land of these: worlds, including, but not limited to the united States of America, Earth, to take, hold and dispose of the property either Real, Intangible or Personal held in the name of the FOREIGN GRANTOR TRUST dba DARRELL JAMES HILL together with all derivative NAMES and Names and styles thereof, together with guarantee of prepayment and exemption from Taxes, Tithes, and Fees, together with re-conveying all actual assets thereto to this Lawful Holder-in-Due-Course, and real-party-in-interest: Darrell-James: Hill.

~1 of 5 FOR THIS CLAIMANT'S-KNOWLEDGE OF THESE FACTS IS WITH THE CLAIM OF THIS LIVE-LIFE-BIRTH/NATIVITY: Darrell-James: Hill ON THIS BIRTH-TIME OF THE DAY ~ TWENTIETH IN THE ~MONTH-~NOVEMBER IN THE ~YEAR~ONE THOUSAND NINE HUNDRED FIFTY-EIGHT A.D. WITH THE TIME: 11:35:A.M.

~2 OF 5 FOR THESE WITNESS-KNOWLEDGE OF THIS LIVE-LIFE ARE WITH THESE CLAIMS OF THIS LIVE-LIFE-BIRTH/NATIVITY IN THE CITY OF THE AKRON IN THE OHIO STATE WITH THE PROGENY OF THE ANCESTRY PEOPLE-PARTIES: MAN-FEMALE BIRTH-MOTHER, Ora-Lee: (Archer) Hill AND MAN-MALE BIRTH-FATHER, Clarence: Hill BY THEIR MARRIAGE UNDER The Almighty God.

~3 OF 5 FOR THE WITNESS-KNOWLEDGE OF THIS LIVE-LIFE-CLAIM ARE WITH THE CLAIM OF THIS LIVE-LIFE-BIRTH WITH AN AUTHORIZATION OF THESE WITNESS-AUTOGRAPHS:

~4 OF 5 FOR THE WITNESS-KNOWLEDGE OF THESE FACTS ARE WITH THIS LIVE-LIFE-BIRTH-CLAIM WITH THIS CORRECT-SENTENCE-STRUCTURE-COMMUNICATION-PARSE-SYNTAX-GRAMMAR "CSSCPSG"-PERFORMANCE OF THIS BABEL-CSSCPSG- COMMUNICATIONS-CLAIM WITH THIS LIVE-LIFE-PARTY: Darrell-James: Hill.

~5 OF 5 FOR THE WITNESS-KNOWLEDGE OF THESE FACTS ARE WITH THIS LIVE-LIFE-BIRTH-CLAIM WITH THIS CORRECT-SENTENCE-STRUCTURE-COMMUNICATION-PARSE-SYNTAX-GRAMMAR "CSSCPSG"-PERFORMANCE OF THIS BABEL-CSSCPSG- COMMUNICATIONS-CLAIM WITH THIS LIVE-LIFE-PARTY: Darrell-James: Hill.

7 "Without Prejudice" I reserve my common law right Not to be compelled to perform under any contract, commercial agreement, or bankruptcy that I did not enter into knowingly, voluntarily and intentionally. Furthermore, I do Not accept the liability associated with the any compelled benefit of any unrevealed contract or commercial agreement or bankruptcy.

909

COPY CERTIFICATION: a) Certificate Of Birth and b) Arizona Driver License

STATE OF OHIO
 OFFICE OF VITAL STATISTICS

CERTIFICATION OF BIRTH

STATE FILE NUMBER: 1958208851 DATE RECORD FILED: 11/28/1968

NAME: DARRELL JAMES HILL

DATE OF BIRTH: 1/20/1958 SEX: MALE

BIRTHPLACE: OHIO FATHER'S NAME: CLARENCE HILL

MOTHER'S NAME: ORA LEE HILL

LAST NAME PRIOR TO FIRST MARRIAGE: ARCHER

MOTHER'S BIRTHPLACE: ARKANSAS FATHER'S BIRTHPLACE: ALABAMA

Note: This is a true certification of the name and birth facts as recorded in the Office of Vital Statistics, Columbus, Ohio. Witness my signature and seal of the Department of Health this 01 day of August, 2018.

 State Registrar of Vital Statistics

HE 17-2488 SUMMIT COUNTY GENERAL HEALTH DISTRICT

REV. 7/2015

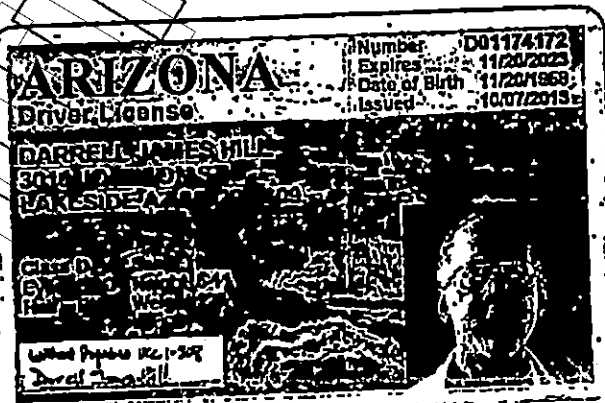

COPY CERTIFICATION

State of Arizona
 County of Yavapai

Jetta Buckman, a notary public, do certify that on the 01st day of April, 2018, I personally made the above face copies of the/a Certificate Of Birth and Arizona Driver License from the originals, and they are true, exact, complete and unaltered copies.

Jetta Buckman
 PUBLIC NOTARY

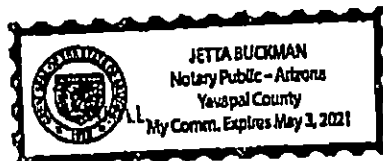

2022-011769 MISC Page: 912 of 2782
 09/26/2022 03:35:37 PM Receipt #: 22-9981
 Rec Fee: \$30.00 Darrell James Hill
 Gila County, Az, Sadie Jo Bingham, Recorder

:ACKNOWLEDGMENT OF THE SOLE ADMINISTRATOR FROM THE HOME OFFICE, PRIVATE BANKER, c/o Darrell-James: Hill, the true and real trade name by my hand and seal, I man take office without encumbrance and without debt or other obligation, fully exempt, indemnified, and with No grant of an other power of attorney dba: DARRELL JAMES HILL and HILL, DARRELL JAMES and ALL DERIVATIVES ALSO INCLUDING DARRELL J. HILL at c/o General Post Office Box 3806; Apache Junction, Arizona; Returnee: Darrell-James: Hill.

NOTICE TO AGENTS IS NOTICE TO PRINCIPALS, NOTICE TO PRINCIPALS IS NOTICE TO AGENTS; WITNESS BY NOTARY DOES NOT ALTER STATUS.

ISSUED THIS 6th DAY: APRIL IN THE YEAR 2018 ON AND FOR THE COUNTY OF YAVAPAI ON THE STATE OF ARIZONA;

:Live-Life-Party man Finger Print: Left

:Live-Life-Party man Finger Print: Right



Without Prejudice:
DARRELL JAMES HILL: GRANTOR

copyclaim ~ 6th day ~ april ~ 2018, a.d.

Darrell James Hill
Darrell-James: Hill: Administrator

:autograph

JURAT

Arizona State
County Yavapai

Today presented a living man proven to me to be Darrell-James: Hill who affirmed and autographed this "AFFIDAVIT: JURAT: CURATIVE REGISTRATION OF THE LIVE LIFE: Darrell-James: Hill :Grantee: CESTUI QUE VIE -ESTATE TRUST NAMED: DARRELL JAMES HILL", inclusive, before me this 6th day of the month April in the year Two thousand eighteen, a.d.

[Signature]
PUBLIC NOTARY

MY COMMISSION EXPIRES ON: 5/3/21



10 day ~ april ~ 2018, a.d.

:witness *Mark-Hewitt Luttz*

:autograph

10 day ~ april ~ 2018, a.d.

:witness *Beverly Jean Romeros Hill*

:autograph

8 Private Banker: I man engaged in the business of banking as the holder in possession to enforce an instrument

Affidavit: Jurat: Curative Registration :

:BILL OF COSTS:

State of Arizona

County of Pinal

Darrell-James: Hill personally presents before me, the undersigned Notary, duly authorized by the laws of the State of Arizona to administer oaths; now on this 19th day July month, 2018: 10 : 36 am pm, being by me first duly sworn on his affirmation, affiant deposes and says:

With the regard to the Trespass on the Case: "AFFIDAVIT: JURAT: CURATIVE REGISTRATION OF THE LIVE LIFE: Darrell-James: Hill Grantee: CESTUI QUE VIE – ESTATE TRUST NAMED: DARRELL JAMES HILL"; sent for the recordation on the April 12th, 2018: USPS RMN RE 322.399 163 US : you, Kristen and and Katie are now mailed:

Kristen: Summit County Fiscal Officer Scalise
175 South Main Street
Akron, Ohio [44308-1354]

Katie: *Executive Assistant I Mancino*
175 South Main Street
Akron, Ohio [44308-1354]
330.643.2530-

USPS CMN 7015 1730 0002 3063 9287 ; and: USPS CMN 7015 1730 0002 3063 9294 ; that,

By your choice, since April 18th, 2018; the: Darrell-James: Hill, man, declaration of live-life and political election instrument-executed for recordation is Not yet recorded – instead, you illegally and forcibly refused to record the document – in the despite of the clear execution of the Almighty-God-Given Constitutionally-protected right to the action demanded, and with your acceptance of the fee-schedule for the trespass on the case of the "one pre-1933 one-ounce- 99% or higher-gold United States Coin per minute cumulative from this registration until upon the full remedy is resolved; ...[:]" and, for the fact that i:man do not consent to your actions to not record the instrument. To wit: your repeated refusal to file the live-life and political election document of: i:man with No cause Nor remedy is illegal wrong-doing and trespass upon the case.

Wherefore, on April 25th, 2018: you received the second attempt from the man to record the necessary instrument, and for the resolve of the denial of the right, and with the clear notice of the fee-schedule amounts agreed due for your choice of the trespass upon the case of: i: man – See: Kristen c/o :Katie – USPS RMN RE 32399194 US – : document was also sent to: Steve: Summit County Sheriff Barry for the common law and state and federal criminal activity developments in this trespass on the case of: i:man: Darrell-James: Hill.

Now: July 19th, 2018: this bill, due payable per our agreement for the continued trespass on the case: pre-1933 one-ounce- 99% or higher-gold United States Coin per minute – unit measure of time – is: one hundred forty-one thousand four hundred sixty-eight, "141,468"; payment owed as described below.

Darrell-James: Hill, c/o PO Box 3806, Apache Junction, Arizona 85117
USPS CMN 7015 1730 0002 3063 9287 : Kristen; USF

912

2022-011769 MISC Page: 914 of 2782
09/26/2022 03:35:37 PM Receipt #: 22-9381
Rec Fee: \$30.00 Darrell James Hill
Gila County, Az, Sadie Jo Bingham, Recorder



:BILL OF COSTS:

Line	Trespass Upon, Case	Time period	Fee-schedule: one-ounce- 99% or higher-gold United States Coin per minute/ minute	Quantity minutes	Quantity one-ounce- 99% or higher-gold United States Coin
1	" "	04/12/2018: 11:42a 04/30/2018; 5: 30p	" "	26268	26268
2	" "	04/30/2018; 5: 30p 05/31/2018; 5: 30p	" "	44640	44640
3	Trespass Upon Case	05/31/2018; 5: 30p 06/30/2018; 5: 30p	" "	43200	43200
4		06/30/2018; 5: 30p 07/19/2018; 5: 30p	" "	27360	27360
Total Due	Trespass Upon Case	04/12/2018: 11:42a 07/19/2018: 5:30p	" "	141468	141468

Payment Amount-due now: One hundred forty-one thousand four hundred sixty-eight, "141,468", pre-1933 one-ounce- 99% or higher-gold United States Coins.

Send: payment to: **Darrell-James: Hill
c/o PO Box 3806
Apache Junction, Arizona 85117..**

:Notice: Bill to the agent is bill to the principal;
:Notice: Bill to the principal is bill to the agent.

Without prejudice

Autographed: 19th day: July month: 2018.

Darrell-James Hill
:Darrell-James: Hill, m

Sworn to and subscribed before me now on the 19th day: July month: 2018
Produced identification: type: Arizona Driver License.

Heather Wood

Notary

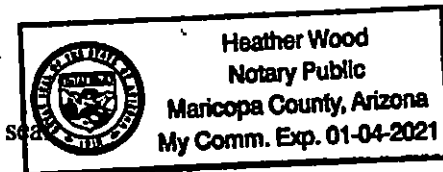

2022-0111769 MISC Page: 915 of 2782
09/26/2022 03:35:37 PM Receipt #: 22-9381
Rec Fee: \$30.00 Darrell James Hill
GIS County: 02, Sadie Jo Bingham, Recorder

Darrell-James: Hill, c/o PO Box 3806, Apache Junction, Arizona 85117
USPS CMN 7015 1730 0002 3063 9287 : Kristen; USPS CMN 7015 1730 0002 3063 9294 : Katie

913

7015 1730 002 3063 9294

7015 1730 002 3063 9287

APACHE JUNCTION
151 W SUPERSTITION BLVD
APACHE JUNCTION
AZ

85120-9998
0302590130

07/19/2018 (800)275-8777 11:04 AM

Product Description	Sale Qty	Final Price
First-Class Mail Letter	1	\$0.50
Certified	1	\$3.45
Return Receipt	1	\$2.75
First-Class Mail Letter	1	\$0.50
Certified	1	\$3.45
Return Receipt	1	\$2.75
Total		\$13.40
Cash		\$14.00
Change		(\$0.60)

Text your tracking number to 28777 (2USPS) to get the latest status.

U.S. Postal Service™
CERTIFIED MAIL® RECEIPT
Domestic Mail Only

For delivery information, visit our website at www.usps.com

OFFICIAL USE

Certified Mail Fee \$3.45

Extra Services & Fees (check box, add fee as appropriate)

Return Receipt (hardcopy) \$0.00

Return Receipt (electronic) \$0.00

Certified Mail Restricted Delivery \$0.00

Adult Signature Required \$0.00

Adult Signature Restricted Delivery \$0.00

Postage \$0.50

Total Postage and Fees \$6.70

0130
11

Postmark
Here

07/19/2018

Sent To

Katie: Executive Assistant / Mincino

Street and Apt. No., or PO Box 175 South Main Street
Akron, Ohio (44308-1354)

City, State, ZIP+4®

PS Form 3800, April 2015 PSN 7530-02-000-9047 See Reverse for Instructions

U.S. Postal Service™
CERTIFIED MAIL® RECEIPT
Domestic Mail Only

For delivery information, visit our website at www.usps.com

OFFICIAL USE

Certified Mail Fee \$3.45

Extra Services & Fees (check box, add fee as appropriate)

Return Receipt (hardcopy) \$0.00

Return Receipt (electronic) \$0.00

Certified Mail Restricted Delivery \$0.00

Adult Signature Required \$0.00

Adult Signature Restricted Delivery \$0.00

Postage \$0.50

Total Postage and Fees \$6.70

0130
11

Postmark
Here

07/19/2018

Sent To

Kristina: Summit County Fiscal Officer Sealine

Street and Apt. No., or PO 175 South Main Street
Akron, Ohio (44308-1354)

City, State, ZIP+4®

PS Form 3800, April 2015 PSN 7530-02-000-9047 See Reverse for Instructions

UNOFFICIAL

914



Darrell- James: Hill c/o PO Box 3806, Apache Junction, Arizona 85117

Doug: Arizona Governor Ducey
Office of the Governor- Arizona
1700 West Washington Street
Phoenix, Arizona 85007

Michele: Secretary of State Reagan
Office of the Secretary of State- Arizona
1700 West Washington Street, 7th Floor
Phoenix, Arizona 85007

USPS RMN RE 047 636 466 US

USPS RMN RE 047 636 470 US

Doug, Michele; Greetings,

i:man :beneficiary of the inherent right of the people and public trust named DARRELL JAMES HILL am an Ohioan inhabitant on the Arizona state and also known as :Darrell- James: Hill¹. i:man write to end criminal wrong-doing by you/people:persons under your charge, that the violations will never again occur against i:man. Here is the account:

- (a) On the Tuesday: July 3rd 2018: i:man sent: "State of Arizona - Office of the Secretary of State: Apostille/ Certification of Authentication Request" and all contents also including the 12.00 fee asked for the ministerial request made.
- (b) On or about the Friday: July 27th, 2018: i:man received back all of the contents of the item (a) above; however, the Arizona-notary is not-authenticated as i:man requested and required. - This was not expected.
- (c) Sent with the returned request package of documents: item (b)-above, is: "APOSTILLE/ AUTHENTICATION RETURN FORM", "Return Form"; presented solely: not dated; nor signed; nor with prior correspondence. On the bottom of this form for the determination of the denial of the rightful authentication are two inset items x-checked that suggest & claim a statutory discretionary authority to discriminate any document based solely and only upon a "reasonable belief". See: Return Form copy: annexed: 1 page. Wherefore:
- (d) Wanton violations are demonstrated within this application of the Return Form; for:
 - 1: the request executed by i:man for the authentication of the Arizona-notary is the extent of the request; and,
 - 2: the request executed by i:man for the authentication of the Arizona-notary is a ministerial act required;
 - 3: no contract exists authorizing discretion in the place of the ministerial requirement requested;
 - 4: no such presumed discretionary authority over the rightful requirement exists at this time²;
 - 5: only void Arizona legislation, and including A.R.S. § 41-121(B), may authorize "due process" violations to any person; and:
 - 6: only void Arizona legislation, and including A.R.S. § 41-121(B), may authorize harm to the beneficiary of the rights- inherent and of the public trust;
 - 7: personal, not governmental nor immune, are individuals' violations against the protection of the rights of the beneficiary; and, thereby, causing the beneficiary harm demonstrates the criminal trespass and breach of duty by the trustee.
- (e) If, in the spite of the considerations in the item (d) above: you, et al., yet believe you possess a statutory discretionary authority to discriminate any document based solely and only upon your "reasonable belief" then your every denial of a ministerial act requested and required by i:man must at the same time present your written statement for your action. However:
- (f) See: "AFFIDAVIT: Superior Constructive Notice and Demand: Permanent Non-Commercial Presumption: man: Darrell- James: Hill¹", et seq., - annexed: 19 pages - for to set the presumption and for the avoidance of the willful violation. - Note: The fee schedule for the violation of the right of this beneficiary is due payable upon request and accumulative until the resolve of the violation is fulfilled.

cc: ATTN: Head of the Notary Division
1700 W. Washington Street, FL. 7
Phoenix, Arizona 85007-2808

USPS CMN 7017 1000 0000 9343 0773 :

Notice to the Principal is Notice to the Agent:
Notice to the Agent is Notice to the Principal.

I, say here, and will verify in open court, that all herein be true.

Without Prejudice:
Beneficiary:

Darrell James Hill
:Darrell- James: Hill
American state national

Autographed: 31st day: July month: 2018:

1 See: Gila County, Arizona, Recorder: Doc. # 2017-002378: pages: 1-24, 76-79, 108-123, 148-152, and 178-181 of 693.
2 Ibid.

Notice to principals: Doug; Gov- and Michele: Secretary- Arizona RMN RE047636466&470 US :31JULY2018

2022-011769 MISC Page: 917 of 2782

09/26/2022 03:35:37 PM Receipt #: 22-9381
Rec Fee: \$30.00 Darrell James Hill
Gila County, Az, Sadie Jo Bingham, Recorder



915



DATE _____

APOSTILLE/AUTHENICATION RETURN FORM

We are unable to process your request for the following reason(s):

- Please indicate what COUNTRY the document(s) will be sent.
- Please use enclosed apostille request form.
- Please send your payment of \$3.00 per notarized and/or certified document.

Total fee \$ _____

- Please enclose a self-address stamped envelope.
- Your document(s) were not received.
- Your document(s) is/are improperly notarized. Please have the notary review their reference manual or visit our website at www.azsos.gov on how to perform a proper notarization:
 - Notary is acting outside the scope of her authority; statements should be coming from signer not the notary. When you resubmit, please make sure it is the original document and it has a notarial language certificate.
 - Venue is missing on notarizations, List State and County of where notarization took place. Please have the notary review his/her reference manual for instruction on how to properly notarize a document.
 - The signer's personal information cannot be part of the notarial certificate because a notary public cannot attest to that. Please have the notary review his/her reference manual for instructions on how to properly notarize a document.
- An apostille is a certification of a Notary or public official, in your case you would need to have all of your documents notarized prior to sending them in for apostille.
- NOTARIAL LANGUAGE IS MISSING:** A Notary who notarizes a document without notarial language has performed an incomplete notarization. A court of law could declare the notarization invalid. (samples attached)

The Secretary of State has been advised by the U.S. Department of State to refuse to notarize, authenticate, or affix the Hague Apostille to certain documents: Additionally, A.R.S. § 41-121(B) grants the Secretary of State authority to deny such requests. The Secretary of State may refuse to perform a service or refuse a filing after the document/filing has been reviewed.

After reviewing your documents the secretary has decided to not issue your apostille/certificate of authentication, this is not a document that our office can authenticate.

2022-011769 MISC Page: 918 of 2782
09/26/2022 03:35:37 PM Receipt #: 22-9381
Rec Fee: \$30.00 Darrell James Hill
Gila County, Az, Sadie Jo Bingham, Recorder





State of Arizona – Office of the Secretary of State
Apostille/Certificate of Authentication Request

DO NOT WRITE IN THIS SPACE

MICHELE REAGAN Secretary of State

SEND BY MAIL TO: Secretary of State Michele Reagan, Attn: Notary Division 1700 W. Washington Street, FL 7, Phoenix, AZ 85007-2808

OR return the request in person: PHOENIX - State Capitol Executive Tower, 1700 W. Washington Street, 2nd Fl., Ste. 220 TUCSON - Arizona State Complex, 400 W. Congress, 1st Fl., Suite 141 Office Hours: Monday through Friday, 8 a.m. to 5 p.m., except state holidays.

FOR OFFICE USE ONLY SOSBSAP REV. 2/20/2018

PLEASE NOTE: The Secretary of State issues apostilles (certificates of notarization authenticity) on documents being sent to a foreign country and also authenticates public documents being sent to foreign countries. An apostille from the Arizona Secretary of State's Office certifies an ARIZONA NOTARY, STATE CLERK, JUDGE or other PUBLIC OFFICER whose oath is on file with the Secretary of State.

INSTRUCTIONS

When to use this form: Use this form to request an apostille or certificate of authentication under A.R.S. § 41-326. When not to use this form: Do NOT use this form if the document for which you are seeking an apostille has been signed or notarized by a federal official. Direct your request to the United States Department of State at (202) 647-4000. Such documents might include those that have been signed by a federal official with the official seal of that agency, American Consular Officer, Military Notary (10 USC 1044a) or Foreign Consul. Be Accurate: To avoid errors please write legibly or computer generate this request. This form has been designed to be filled out and printed online. Sign and date the request. Website: All forms are available on the Secretary of State's Website, www.azsos.gov.

Types of documents authenticated: Government documents such as a birth certificate, death certificate, marriage record, corporation document, etc. must be a CERTIFIED COPY issued by that government office. Filing Fee and Payment: \$3 PER DOCUMENT; Checks or money orders shall be made payable to the Secretary of State. Credit cards are not accepted. Cash accepted in-person only. Submission: Include your payment and a self-addressed, postage paid envelope to avoid any delays or rejections. We are unable to process any requests with insufficient postage. If you send your documents by mail and require expedited service you may want to use express mail and include a self-addressed, express mail envelope for the return of the processed document. Processing: 10 Business Days Questions? Call (602) 542-6167; in-state/toll-free (800) 458-

Form with sections: 1. Type of document(s) (AFFIDAVIT), 2. Foreign Country in which document(s) will be used (Ohio state), 3. Requestor Information (DARRELL JAMES HILL, APACHE JUNCTION, ARIZ, 85117), 4. Submission (4 documents, \$12.00 fee, MONEY ORDER).

2022-011769 MISC Page: 919 of 2782 09/26/2022 03:35:37 PM Receipt #: 22-9381 Rec Fee: \$30.00 Darrell James Hill Gila County, Az, Sadie Jo Bingham Recorder

917

RE047636466US

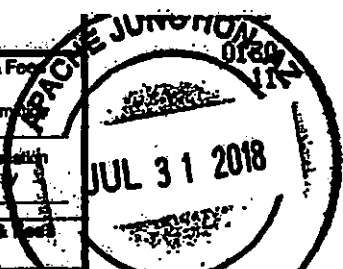

Postage \$ \$1.84	Extra Services & Fees (add-on)
Extra Services & Fees	<input type="checkbox"/> Signature Confirmation
<input type="checkbox"/> Registered Mail \$ \$12.60	<input type="checkbox"/> Signature Confirmation Restricted Delivery
<input type="checkbox"/> Return Receipt (hardcopy) \$ \$2.75	<input type="checkbox"/> Signature Confirmation Restricted Delivery
<input type="checkbox"/> Return Receipt (electronic) \$ \$0.00	Total Postage & Fees \$ \$17.19
<input type="checkbox"/> Restricted Delivery \$	
Customer Must Declare Full Value \$ \$21.00	Received by 07/31/2018
	Domestic Insurance up to \$500 is included based upon \$5.00 per \$100 of declared value. Additional insurance available. (See Reverse).

OFFICIAL USE

APACHE JUNCTION, AZ 85120	
FROM	Darrell James Hill c/o PO Box 3806 Apache Junction, Arizona 85117
TO	PHOENIX, AZ 85007 Doug Arizona Governor Ducey Office of the Governor 1700 West Washington Street Phoenix, Arizona 85007

PS Form 3806, Registered Mail Receipt Copy 1 - Customer

Registered No. **RE047636470US**

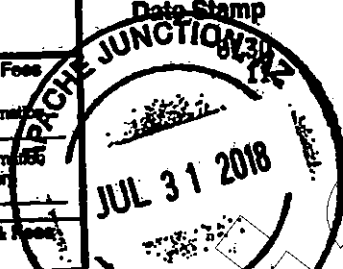

Postage \$ \$1.84	Extra Services & Fees (add-on)
Extra Services & Fees	<input type="checkbox"/> Signature Confirmation
<input type="checkbox"/> Registered Mail \$ \$12.60	<input type="checkbox"/> Signature Confirmation Restricted Delivery
<input type="checkbox"/> Return Receipt (hardcopy) \$ \$2.75	<input type="checkbox"/> Signature Confirmation Restricted Delivery
<input type="checkbox"/> Return Receipt (electronic) \$ \$0.00	Total Postage & Fees \$ \$17.19
<input type="checkbox"/> Restricted Delivery \$	
Customer Must Declare Full Value \$ \$21.00	Received by 07/31/2018
	Domestic Insurance up to \$500 is included based upon \$5.00 per \$100 of declared value. Additional insurance available. (See Reverse).

OFFICIAL USE

APACHE JUNCTION, AZ 85120	
FROM	Darrell James Hill c/o PO Box 3806 Apache Junction, Arizona 85117
TO	PHOENIX, AZ 85007 Doug Arizona Governor Ducey Office of the Governor 1700 West Washington Street Phoenix, Arizona 85007

PS Form 3806, Registered Mail Receipt April 2015, PSN 7538-02-000-9051 For domestic delivery information, visit our website

APACHE JUNCTION
151 W SUPERSTITION BLVD
APACHE JUNCTION
AZ
85120-9998
0302590130
07/31/2018 (800)275-8777 9:20 AM

Product Description	Sale Qty	Final Price
First-Class Mail	1	\$1.84
Large Envelope (Domestic) (PHOENIX, AZ 85007) (Weight: 0 Lb 4.40 Oz) (Estimated Delivery Date) (Thursday 08/02/2018)		
Registered	1	\$12.60
(Amount: \$21.00) (USPS Registered Mail #) (RE047636470US)		
Return Receipt	1	\$2.75
(USPS Return Receipt #) (9590940227857069640112)		
First-Class Mail	1	\$1.84
Large Envelope (Domestic) (PHOENIX, AZ 85007) (Weight: 0 Lb 4.50 Oz) (Estimated Delivery Date) (Thursday 08/02/2018)		
Registered	1	\$12.60
(Amount: \$21.00) (USPS Registered Mail #) (RE047636466US)		
Return Receipt	1	\$2.75
(USPS Return Receipt #) (9590940227857069640129)		
Total		\$34.38
Cash		\$40.00
Change		(\$5.62)

2022-011769 MISC Page: 920 of 2782
09/26/2022 03:35:37 PM Receipt #: 22-9381
Rec Fee: \$30.00 Darrell James Hill
Gila County, Az, Sadie Jo Bingham, Recorder

SENDER: COMPLETE THIS SECTION

- Complete items 1, 2, and 3.
- Print your name and address on the reverse so that we can return the card to you.
- Attach this card to the back of the mailpiece, or on the front if space permits.

1. Article Addressed to:

Doug Arizona Governor Ducey
Office of the Governor
1700 West Washington Street
Phoenix, Arizona 85007



9590 9402 2785 7069 6401 29

2. Article Number (Transfer from service label) **RE 047 636 466 US**

COMPLETE THIS SECTION ON DELIVERY

A. Signature **Thomas B. Stickney** Agent Addressee

B. Received by (Printed Name) _____ C. Date of Delivery _____

D. Is delivery address different from item 1? Yes No
If YES, enter delivery address below: _____

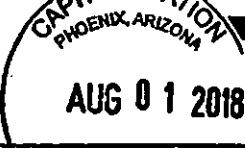

3. Service Type Registered Mail Express® Registered Mail™

Adult Signature Restricted Delivery® Registered Mail Restricted Delivery

Certified Mail® Return Receipt for Merchandise

Collect on Delivery Signature Confirmation™

Collect on Delivery Restricted Delivery Signature Confirmation Restricted Delivery

PS Form 3811 July 2015 PSN 7538-02-000-9051 Domestic Return Receipt

USPS Tracking®

FAQs > (<https://www.usps.com/faqs/uspstracking-faqs.htm>)

Track Another Package +

Tracking Number: RE047636466US

Remove X

Your item was delivered at 7:56 am on August 1, 2018 in PHOENIX, AZ 85009.

Delivered

August 1, 2018 at 7:56 am
Delivered
PHOENIX, AZ 85009

Tracking History

August 1, 2018, 7:56 am
Delivered
PHOENIX, AZ 85009

Your item was delivered at 7:56 am on August 1, 2018 in PHOENIX, AZ 85009.

August 1, 2018, 7:49 am
Arrived at Unit
PHOENIX, AZ 85009

July 31, 2018, 11:49 pm
Departed USPS Facility
PHOENIX, AZ 85026

July 31, 2018, 11:48 pm
Arrived at USPS Facility
PHOENIX, AZ 85026

July 31, 2018, 12:13 pm

2022-011769 MISC Page: 921 of 2782
09/26/2022 03:35:37 PM Receipt #: 22-9381
Rec Fee: \$30.00 Darrell James Hill
Gila County, Az, Sadie Jo Bingham, Recorder



919

RE047636466US

Postage \$ \$1.84	Extra Services & Fees (continued)
Extra Services & Fees	<input type="checkbox"/> Signature Confirmation
<input type="checkbox"/> Registered Mail \$ \$12.60	<input type="checkbox"/> Signature Confirmation Restricted Delivery
<input type="checkbox"/> Return Receipt (hardcopy) \$ \$2.75	<input type="checkbox"/> Signature Confirmation Restricted Delivery
<input type="checkbox"/> Return Receipt (electronic) \$ \$0.00	<input type="checkbox"/> Signature Confirmation Restricted Delivery
<input type="checkbox"/> Restricted Delivery \$ \$0.00	<input type="checkbox"/> Signature Confirmation Restricted Delivery
Total Postage & Fees \$17.19	
Customer Must Declare Full Value \$21.00	Received by 07/31/2018
	Domestic Insurance up to \$500 is included based upon the declared value of the contents. Additional insurance is available. (See Reverse).

To Be Completed By Post Office

To Be Completed By Customer (Please Print) All Entries Must Be in Ballpoint or Typed

OFFICIAL USE

APACHE JUNCTION, AZ 85120	
FROM	Darrell James Hill c/o PO Box 3806 Apache Junction, Arizona 85117
TO	PHOENIX, AZ 85007 Dyck, Arizona Governor Ducey 1700 West Washington Street Phoenix, Arizona 85007

PS Form 3806, Registered Mail Receipt April 2015, PSN 7530-02-000-9053 Copy 1 - Customer

Registered No. RE047636470US	Date Stamp JUL 31 2018
Postage \$ \$1.84	Extra Services & Fees (continued)
Extra Services & Fees	<input type="checkbox"/> Signature Confirmation
<input type="checkbox"/> Registered Mail \$ \$12.60	<input type="checkbox"/> Signature Confirmation Restricted Delivery
<input type="checkbox"/> Return Receipt (hardcopy) \$ \$2.75	<input type="checkbox"/> Signature Confirmation Restricted Delivery
<input type="checkbox"/> Return Receipt (electronic) \$ \$0.00	<input type="checkbox"/> Signature Confirmation Restricted Delivery
<input type="checkbox"/> Restricted Delivery \$ \$0.00	<input type="checkbox"/> Signature Confirmation Restricted Delivery
Total Postage & Fees \$17.19	
Customer Must Declare Full Value \$21.00	Received by 07/31/2018
	Domestic Insurance up to \$500 is included based upon the declared value of the contents. Additional insurance is available. (See Reverse).

APACHE JUNCTION, AZ 85120	
FROM	Darrell James Hill c/o PO Box 3806 Apache Junction, Arizona 85117
TO	PHOENIX, AZ 85007 Dyck, Arizona Governor Ducey 1700 West Washington Street, 7th Floor Phoenix, Arizona 85007

PS Form 3806, Registered Mail Receipt April 2015, PSN 7530-02-000-9053 For domestic delivery information, visit our website

APACHE JUNCTION
151 W SUPERSTITION BLVD
APACHE JUNCTION
AZ
85120-9998
0302590130

07/31/2018 (800)275-8777 9:20 AM

Product Description	Sale Qty	Final Price
First-Class Mail Large Envelope (Domestic) (PHOENIX, AZ 85007) (Weight: 0 Lb 4.40 Oz) (Estimated Delivery Date) (Thursday 08/02/2018)	1	\$1.84
Registered (Amount: \$21.00) (USPS Registered Mail #) (RE047636470US)	1	\$12.60
Return Receipt (USPS Return Receipt #) (9590940227857069640112)	1	\$2.75
First-Class Mail Large Envelope (Domestic) (PHOENIX, AZ 85007) (Weight: 0 Lb 4.50 Oz) (Estimated Delivery Date) (Thursday 08/02/2018)	1	\$1.84
Registered (Amount: \$21.00) (USPS Registered Mail #) (RE047636466US)	1	\$12.60
Return Receipt (USPS Return Receipt #) (9590940227857069640129)	1	\$2.75
Total		\$34.38
Cash		\$40.00
Change		(\$5.62)

2022-011769 MISC Page: 922 of 2782
09/26/2022 03:35:37 PM Receipt # 22-9381
Rec Fee: \$30.00 Darrell James Hill
Gila County, Az, Sadie Jo Bingham, Recorder

SENDER: COMPLETE THIS SECTION

- Complete items 1, 2, and 3.
- Print your name and address on the reverse so that we can return the card to you.
- Attach this card to the back of the mailpiece, or on the front if space permits.

1. Article Addressed to:

Michelle, Secretary of State Reagan
State Capitol, West Wing
1700 West Washington Street, 7th Floor
Phoenix, Arizona 85007



2. Article Number (Transfer from service label)

RE 047 636 470 US

COMPLETE THIS SECTION ON DELIVERY

A. Signature Agent Addressee

B. Received by Agent Addressee

C. Date of Delivery

D. Is delivery restricted to item 1? Yes No
If YES, enter delivery address below:



3. Service Type

Adult Signature Priority Mail Express®

Adult Signature Restricted Delivery Registered Mail™

Certified Mail® Certified Mail Restricted Delivery

Collect on Delivery Collect on Delivery Restricted Delivery

Signature Confirmation™ Signature Confirmation Restricted Delivery

PS Form 3811, July 2015 PSN 7530-02-000-9053

Domestic Return Receipt

920

USPS Tracking®

FAQs > (<https://www.usps.com/faqs/uspstracking-faqs.htm>)

Track Another Package +

Tracking Number: RE047636470US

Remove X

Your item was delivered at 7:56 am on August 1, 2018 in PHOENIX, AZ 85009.

✓ Delivered

August 1, 2018 at 7:56 am
Delivered
PHOENIX, AZ 85009

Tracking History ^

August 1, 2018, 7:56 am
Delivered
PHOENIX, AZ 85009
Your item was delivered at 7:56 am on August 1, 2018 in PHOENIX, AZ 85009.

August 1, 2018, 7:49 am
Arrived at Unit
PHOENIX, AZ 85009

July 31, 2018, 11:50 pm
Departed USPS Facility
PHOENIX, AZ 85026

July 31, 2018, 11:48 pm
Arrived at USPS Facility
PHOENIX, AZ 85026

July 31, 2018, 12:13 pm

2022-011769 MISC Page: 923 of 2782
09/26/2022 03:35:37 PM Receipt #: 22-9381
Rec Fee: \$30.00 Darrell James Hill
Gila County, Az, Sadie Jo Bingham, Recorder



921

**U.S. Postal Service™
CERTIFIED MAIL RECEIPT**

Domestic Mail Only

For delivery information, visit our website at www.usps.com

PHOENIX, AZ 85007
OFFICIAL USE

Certified Mail Fee **\$3.45**

0130
11

Extra Services & Fees (check box, add fee)
 Return Receipt (hardcopy) \$0.00
 Return Receipt (electronic) \$0.00
 Certified Mail Restricted Delivery \$0.00
 Adult Signature Required \$0.00
 Adult Signature Restricted Delivery \$0.00

Postmark
Here

Postage **\$1.63**

07/31/2018

Total Postage and Fees **\$5.08**

Sent To

Street and Apt. No., or PO Box

ATTN: Head of the Notary Division
1700 W. Washington Street, FL. 7
Phoenix, Arizona 85007-2808

City, State, ZIP+4®

PS Form 3800, April 2015

See Reverse for Instructions

APACHE JUNCTION
151 W SUPERSTITION BLVD
APACHE JUNCTION

AZ

85120-9998

0302590130

(800)275-8777

9:21 AM

07/31/2018

Product Description	Sale Qty	Final Price
---------------------	----------	-------------

First-Class Mail	1	\$1.63
------------------	---	--------

Large Envelope
(Domestic)
(PHOENIX, AZ 85007)
(Weight: 0 LB 4.00 Oz)
(Estimated Delivery Date)
(Thursday 08/02/2018)

Certified	1	\$3.45
-----------	---	--------

(®USPS Certified Mail #)
(7017100000093430773)

Total		\$5.08
-------	--	--------

Cash	\$5.13
Change	(\$0.05)

Text your tracking number to 28777 (2USPS) to get the latest status. Standard Message and Data rates may apply. You may also visit www.usps.com USPS Tracking or call 1-800-222-1811.

In a hurry? Self-service kiosks offer quick and easy check-out. Any Retail Associate can show you how.

Prefer our Mail

2022-011769 MISC Page: 924 of 2782

09/26/2022 03:35:37 PM Receipt #: 22-9381

Rec Fee: \$30.00 Darrell James Hill

Gila County, Az, Sadie Jo Bingham, Recorder



E24D EHEB D000 D00T 2702

Unofficial Copy

Unofficial Copy

922

ALERT: DUE TO WILDFIRES IN CALIFORNIA, USPS SERVICES ARE IMPACTED IN THOSE AREAS. READ MORE.

USPS Tracking®

FAQs > (<http://faq.usps.com/?articleId=220800>)

[Track Another Package +](#)

Tracking Number: 70171000000093430773

Remove X

On Time

Expected Delivery on

THURSDAY

2

AUGUST
2018

by
8:00pm

Delivered

August 2, 2018 at 10:14 am

Delivered

PHOENIX, AZ 85009

[Get Updates](#) ▾

[Text & Email Updates](#) ▾

[Tracking History](#) ▲

August 2, 2018, 10:14 am

Delivered

PHOENIX, AZ 85009

Your item was delivered at 10:14 am on August 2, 2018 in PHOENIX, AZ 85009.

August 2, 2018, 6:47 am

Arrived at Unit

PHOENIX, AZ 85009

August 1, 2018, 10:52 am

Available for Pickup

PHOENIX, AZ 85009

923

2022-011769 MISC Page: 925 of 2782

09/26/2022 03:35:37 PM Receipt #: 22-9381

Rec Fee: \$30.00 Darrell James Hill

Gila County, Az, Sadie Jo Bingham, Recorder



BRIAN D. KARTH
District Court Executive / Clerk of Court
Sandra Day O'Connor U. S. Courthouse
Suite 130
401 West Washington Street, SPC 1
Phoenix, Arizona 85003-2118

**UNITED STATES DISTRICT COURT
DISTRICT OF ARIZONA
OFFICE OF THE CLERK**



MICHAEL S. O'BRIEN
Chief Deputy Clerk
Evo A. Deconcini U.S. Courthouse
405 W. Congress, Suite 1500
Tucson, Arizona 85701-5010

DEBRA D. LUCAS
Chief Deputy Clerk
Sandra Day O'Connor U. S. Courthouse
Suite 130
401 West Washington Street, SPC 1
Phoenix, Arizona 85003-2118

August 1, 2018

Darrell James Hill
P.O. Box 3806
Apache Junction, AZ 85117

RE: Notification

Dear Mr. Hill:

The Clerk's Office is in receipt of a document you submitted entitled "Certificate of Protest." Since it is unclear as to how it should be processed, it is being returned to your attention unprocessed.

If you are attempting to file a new case, please review Local Rule Civil 7.1 for instructions on how to properly format a document for filing in the United States District Court, District of Arizona. In addition, you must pay the \$400.00 filing fee or file an application to proceed in forma pauperis with any case initiating documents.

For information on court forms, the Local Rules, and how to file a new case, please visit our website at www.azd.uscourts.gov.

Brian D. Karth
District Court Executive/Clerk of Court

By s/ S. Strong
Deputy Clerk

2022-011769 MISC Page: 926 of 2782
09/26/2022 03:35:37 PM Receipt #: 22-9381
Rec Fee: \$30.00 Darrell James Hill
Gila County, Az, Sadie Jo Bingham, Recorder



Please send all correspondence to:

Customer Service ■ Sandra Day O'Connor U.S. Courthouse ■ Suite 130 ■ 401 W. Washington St., SPC 1 ■ Phoenix, AZ 85003-2118

NEOPOST FIRST-CLASS
08/01/2018
USPOSTAGE \$002.60
ZIP 85004
041M1127



Darrell James Hill
P.O. Box 3806
Apache Junction, AZ 85117

WWW.HILLSAPACHEJUNCTION.COM

2022-011769 MISC Page: 927 of 2782
09/26/2022 03:35:37 PM Receipt #: 22-9381
Rec Fee: \$30.00 Darrell James Hill
Gila County, Az, Sadie Jo Bingham, Recorder



CLERK OF DISTRICT COURT
GILA COUNTY, ARIZONA

UNITED STATES DISTRICT COURT
DISTRICT OF ARIZONA
OFFICE OF THE CLERK

BRIAN D. KARTH
District Court Executive / Clerk of Court
Sandra Day O'Connor U.S. Courthouse
Suite 130
401 West Washington Street, SPC 1
Phoenix, Arizona 85003-2118



MICHAEL S. O'BRIEN
Chief Deputy Clerk
Evo A. DeConcini U.S. Courthouse
405 W. Congress, Suite 1500
Tucson, Arizona 85701-5010

DEBRA D. LUCAS
Chief Deputy Clerk
Sandra Day O'Connor U.S. Courthouse
Suite 130
401 West Washington Street, SPC 1
Phoenix, Arizona 85003-2118

August 2, 2018

Darrell-James Hill
PO Box 3806
Apache Junction, AZ 85117

Dear Mr. Hill,

The enclosed documents are being returned to you as they do not comport with the Courts Local Rules. If you wish to file a new complaint, please refer to the Local Rules of Practice for the District of Arizona.

Sincerely,

A handwritten signature in cursive script, appearing to be "AC".

AC
Deputy Clerk



NEOPOST
08/02/2018

FIRST-CLASS MAIL

US POSTAGE \$002.68

ZIP 85701
041M11277628



122



Darrell-James Hill
PO Box 3806
Apache Junction, AZ 85117

2022-011769 MISC Page: 929 of 2782
09/26/2022 03:35:37 PM Receipt #: 22-9381
Rec Fee: \$30.00 Darrell James Hill
Gila County, Az, Sadie Jo Bingham, Recorder



Darrell- James: Hill, beneficiary, A.R.: c/o PO Box 3806, Apache Junction, Arizona 85117

Michele: Secretary of State Reagan
c/o Attention: Notary Division
1700 W. Washington Street, FL. 7
Phoenix, Arizona 85007-2808

USPS RMN RB 898 809 936 US

Re: ARS 41-325. Evidence of authenticity of a notarial act performed; (A)... may be evidenced by ...; 1. A certificate of authority from the secretary of state authenticated as necessary.

For the legal and lawful purposes of the beneficiary on the four documents enclosed it is necessary that the notarial acts performed be authenticated. See enclosed: two SOSBSAP REV. 2/20/2018 forms for the four document authentications requested.

Michele, greetings:

i:man :beneficiary of the inherent right of the people and public trust named DARRELL JAMES HILL am an Ohioan inhabitant on the Arizona state and also known as :Darrell- James: Hill'. i:man write again² for the initial of many necessary authentication(s) of notarial acts by the Arizona notaries indicated in the documents i:man require and authorize only for the ministerial authentication of the notarial acts done by the Arizona notaries upon the documents enclosed for the legal and lawful purposes of i:man³, and for no further obstruction: present or assumed or otherwise.

Notice to the Principal is Notice to the Agent:
Notice to the Agent is Notice to the Principal.

i, say here, and will verify in the open court, that: all herein be true.

Without Prejudice:
DARRELL JAMES HILL

Autographed: 9th day: August month: 2018:

Darrell James Hill, A.R.
:Darrell- James: Hill, beneficiary, A.R.

2022-011769 MISC Page: 930 of 2782
09/26/2022 03:35:37 PM Receipt #: 22-9981
Rec Fee: \$30.00 Darrell James Hill
Gila County, Az, Sadie Jo Bingham, Recorder

1. See: Gila County, Arizona, Recorder: Doc. # 2017-002378: pages: 1-24, 76-79, 108-123, 148-152, and 178-181 of 693.
2. Notice to principals: Doug; Arizona Governor Ducey: USPS RMN RE047636466; and Michele: Secretary of State Reagan- Arizona: USPS RMN 047636470 US ; and, ATTN: Head of the Notary Division: USPS CMN 7017 1000 0000 9343 0773 : sent: 31st JULY, 2018.
3. Ibid.

928

ATTN: Head of the Notary Division: USPS RMN RB 898 809 936 US



State of Arizona - Office of the Secretary of State Apostille/Certificate of Authentication Request

DO NOT WRITE IN THIS SPACE

SEND BY MAIL TO:

Secretary of State Michele Reagan, Attn: Notary Division
1700 W. Washington Street, FL 7, Phoenix, AZ 85007-2808

OR return the request in person:

PHOENIX - State Capitol Executive Tower, 1700 W. Washington Street, 2nd Fl., Ste. 220
TUCSON - Arizona State Complex, 400 W. Congress, 1st Fl., Suite 141
Office Hours: Monday through Friday, 8 a.m. to 5 p.m., except state holidays.



FOR OFFICE USE ONLY
SOSBSAP REV. 2/20/2018

PLEASE NOTE: The Secretary of State issues apostilles (certificates of notarization authenticity) on documents being sent to a foreign country and also authenticates public documents being sent to foreign countries. An apostille from the Arizona Secretary of State's Office certifies an ARIZONA NOTARY, STATE CLERK, JUDGE or other PUBLIC OFFICER whose oath is on file with the Secretary of State.

INSTRUCTIONS

When to use this form: Use this form to request an apostille or certificate of authentication under A.R.S. § 41-326.

When not to use this form: Do NOT use this form if the document for which you are seeking an apostille has been signed or notarized by a federal official. Direct your request to the United States Department of State at (202) 647-4000. Such documents might include those that have been signed by a federal official with the official seal of that agency, American Consular Officer, Military Notary (10 USC 1044a) or Foreign Consul.

Be Accurate: To avoid errors please write legibly or computer generate this request. This form has been designed to be filled out and printed online. Sign and date the request.

Website: All forms are available on the Secretary of State's Website, www.azsos.gov.

Types of documents authenticated: Government documents such as a birth certificate, death certificate, marriage record, corporation document, etc. must be a **CERTIFIED COPY** issued by that government office.

Filing Fee and Payment: \$3 PER DOCUMENT; Checks or money orders shall be made payable to the Secretary of State. Credit cards are not accepted. Cash accepted in-person only.

Submission: Include your payment and a self-addressed, postage paid envelope to avoid any delays or rejections. We are unable to process any requests with insufficient postage.

If you send your documents by mail and require expedited service you may want to use express mail and include a self-addressed, pre-paid express mail envelope for the return of the processed document.

Processing: 10 Business Days

Questions? Call (602) 542-6187; in-state/toll-free (800) 458-

1. Type of document(s)

Type of Document
AFFIDAVIT

Type of Document
AFFIDAVIT

Type of Document
AFFIDAVIT

Type of Document
AFFIDAVIT

2. Foreign Country in which document(s) will be used

Name of Foreign Country (Cannot be United States)

Ohio state

3. Requestor Information:

Requestor's First Name

DARRELL JAMES

Requestor's Last Name

HILL

Address (include street, box or suite number)

PO BOX 3806

City

APACHE JUNCTION

State

ARIZ

Zip Code

85117

Phone Number (include area code)

(602) 618-4595

Requestor's Signature

Darrell James Hill, AR.

Date

08 | 09 | 2018

4. Submission:

Enclosed is a: Pre-paid express mail envelope for the return of the processed document(s).
 Self-addressed stamped envelope for the return of the processed document(s). Please remember the returned documents will include official certificates. It is recommended to include catalog 9 x 12 sized envelopes to return your documents.

Number of Documents:

Number of Documents

4

Includes the cost for 4 documents @ \$3.00 =

TOTAL Processing Fee

12.00

Payment:

Enclosed is a:

CHECK

MONEY ORDER

to include the Total Processing Fee above.

USPS PMD Ser# 24890969002

Page: 931 of 2782

2022-011769 MISC
09/26/2022 03:35:37 PM
Receipt #: 22-9381

Darrell James Hill
Gila County, Az, Sadie Jo Bingham, Recorder



929



State of Arizona – Office of the Secretary of State
Apostille/Certificate of Authentication Request

DO NOT WRITE IN THIS SPACE

MICHELE REAGAN Secretary of State

SEND BY MAIL TO: Secretary of State Michele Reagan, Attn: Notary Division 1700 W. Washington Street, FL 7, Phoenix, AZ 85007-2808

OR return the request in person: PHOENIX - State Capitol Executive Tower, 1700 W. Washington Street, 2nd Fl., Ste. 220 TUCSON - Arizona State Complex, 400 W. Congress, 1st Fl., Suite 141 Office Hours: Monday through Friday, 8 a.m. to 5 p.m., except state holidays.



FOR OFFICE USE ONLY SOSBSAP REV. 2/20/2018

PLEASE NOTE: The Secretary of State issues apostilles (certificates of notarization authenticity) on documents being sent to a foreign country and also authenticates public documents being sent to foreign countries. An apostille from the Arizona Secretary of State's Office certifies an ARIZONA NOTARY, STATE CLERK, JUDGE or other PUBLIC OFFICER whose oath is on file with the Secretary of State.

INSTRUCTIONS

When to use this form: Use this form to request an apostille or certificate of authentication under A.R.S. § 41-326. When not to use this form: Do NOT use this form if the document for which you are seeking an apostille has been signed or notarized by a federal official. Direct your request to the United States Department of State at (202) 647-4000. Such documents might include those that have been signed by a federal official with the official seal of that agency, American Consular Officer, Military Notary (10 USC 1044a) or Foreign Consul. Be Accurate: To avoid errors please write legibly or computer generate this request. This form has been designed to be filled out and printed online. Sign and date the request. Website: All forms are available on the Secretary of State's Website, www.azsos.gov.

Types of documents authenticated: Government documents such as a birth certificate, death certificate, marriage record, corporation document, etc. must be a CERTIFIED COPY issued by that government office. Filing Fee and Payment: \$3 PER DOCUMENT; Checks or money orders shall be made payable to the Secretary of State. Credit cards are not accepted. Cash accepted in-person only. Submission: Include your payment and a self-addressed, postage paid envelope to avoid any delays or rejections. We are unable to process any requests with insufficient postage. If you send your documents by mail and require expedited service you may want to use express mail and include a self-addressed, express mail envelope for the return of the processed document. Processing: 10 Business Days Questions? Call (602) 542-6187; In-state/toll-free (800) 458-

Form with sections: 1. Type of document(s) (AFFIDAVIT), 2. Foreign Country in which document(s) will be used (Ohio state), 3. Requestor Information (DARRELL JAMES HILL, APACHE JUNCTION, ARIZ, 85117), 4. Submission (Pre-paid express mail envelope, 4 documents, \$12.00 fee, USPS PMD Ser# 24890969002).

2022-011769 MISC Page: 932 of 2782 09/26/2022 03:35:37 PM Receipt #: 22-9381 Rec Fee: \$30.00 Darrell James Hill Gila County, Az, Sadie Jo Bingham, Recorder

930



POSTAL MONEY ORDER

IN THIS SPACE

Serial Number

2018-07-13 852200

U.S. Dollars and Cents

24890969250

Three Dollars and 00/100

\$3.00

MIC
REA

Pay to *Ariz. Sec of State - Notary Darrell James Hill*

Secreta Address *1700 W. Washington St. #718 Phoenix, Ariz 85007*

PLEASE also auth NOTARY, Memo *Arth Kraiss*

Postage paid stamp: *David James Hill*
Address: *PO Box 3806 Apache Junction AZ 85117*



Country and an ARIZONA

INSTRUC

When to u certificate documents such as a

When not use this form if the document for which you are seeking an apostille has been signed or notarized by a federal official. Direct your request to the United States Department of State at (202) 647-4000. Such documents might include those that have been signed by a federal official with the official seal of that agency, American Consular Officer, Military Notary (10 USC 1044a) or Foreign Consul.

etc. must be a CERTIFIED COPY issued by that government office. Filing Fee and Payment: \$3 PER DOCUMENT; Checks or money orders shall be made payable to the Secretary of State. Credit cards are not accepted. Cash accepted in-person only.

Be Accurate: To avoid errors please write legibly or computer generate this request. This form has been designed to be filled out and printed online. Sign and date the request.

Submission: Include your payment and a self-addressed, postage paid envelope to avoid any delays or rejections. We are unable to process any requests with insufficient postage.

Website: All forms are available on the Secretary of State's Website, www.azsos.gov.

If you send your documents by mail and require expedited service may want to use express mail and include a self-addressed, express mail envelope for the return of the processed document.

Processing: 10 Business Days
Questions? Call (602) 542-6187; in-state/toll-free (800) 458-

1. Type of document(s)

Type of Document	NOTARIAL CERTIFICATE OF PROTEST
Type of Document	-----
Type of Document	-----
Type of Document	-----

2. Foreign Country in which document(s) will be used

Name of Foreign Country (Cannot be United States)	DISTRICT OF COLUMBIA
---	----------------------

3. Requestor Information:

Requestor's First Name	DARRELL JAMES	Requestor's Last Name	HILL				
Address (include street, box or suite number)	PO BOX 3806	City	APACHE JUNCTION	State	ARIZ	Zip Code	85117
Phone Number (include area code)	(602) 618-4595	Requestor's Signature	<i>David James Hill, A.R.</i>	Date	08 09 2018		

4. Submission:

Enclosed is a:	<input type="checkbox"/> Pre-paid express mail envelope for the return of the processed document(s). <input type="checkbox"/> Self-addressed stamped envelope for the return of the processed document(s). Please remember the returned documents will include official certificates. It is recommended to include catalog 9 x 12 sized envelopes to return your documents.
Number of Documents:	Number of Documents: 1 X (Times) the cost per document \$3.00 = TOTAL Processing Fee 3.00
Payment:	Enclosed is a: <input type="checkbox"/> CHECK <input checked="" type="checkbox"/> MONEY ORDER to include the Total Processing Fee above. <i>USPS PMO: Serial 24890969250</i>

2022-011769 MISC Page: 933 of 2782
 09/26/2022 03:35:37 PM Receipt # 22-9381
 Rec Fee: \$30.00 Darrell James Hill
 Gila County, Az. Sadie Jo Bingham, Recorder

931

Registered Mail RB 898 809 936 US

APACHE JUNCTION, AZ
AUG 06 2018
85100

APACHE JUNCTION
151 W SUPERSTITION BLVD
APACHE JUNCTION
AZ
85120-9998
0302590130
08/09/2018 (800)275-8777 10:36 AM

Postage \$ 2.05
Extra Services & Fees
Registered Mail \$ 12.40
Return Receipt (hardcopy) \$ 2.75
Return Receipt (electronic) \$ 1.75
Total Postage & Fees \$ 19.65
Customer Must Declare Full Value \$ 21.00

Product Description	Sale Qty	Final Price
\$5 Waves (Unit Price:\$5.00)	1	\$5.00
Purple Heart 1	1	\$0.50
2 (Unit Price:\$0.50)		
First-Class Mail Large Envelope (Domestic) (PHOENIX, AZ 85007) (Weight:0 Lb 5.90 Oz) (Estimated Delivery Date) (Saturday 08/11/2018)	1	\$2.05
Registered (Amount:\$21.00) (USPS Registered Mail #) (R898809936US)	1	\$12.60
Return Receipt (USPS Return Receipt #) (9590940242158121976309)	1	\$2.75
Total		\$22.90
Cash Change		\$23.00 (\$0.10)

OFFICIAL USE

To Be Completed By Customer (Please Print) All Entries Must Be in Blockprint or Typed

FROM: Darrell James Hill, c/o PO Box 3886, Apache Junction, Arizona 85117

TO: ATTN: Head of the History Division, 1700 W. Washington Street, FL. 7, Phoenix, Arizona 85007-2808

PS Form 3806, Registered Mail Receipt April 2015 PSN 7530-02-000-6053 Copy 1 - Customer

Text your tracking number to 28777 (2USPS) to get the latest status. Standard Message and Data rates may apply. You may also visit www.usps.com USPS Tracking or call 1-800-222-1811.

In a hurry? Self-service kiosks offer quick and easy check-out Any Retail

- SENDER CONFIRMS THIS RECEIPT
- Complete items 1, 2, and 3.
 - Print your name and address on the reverse so that we can return the card to you.
 - Attach this card to the back of the mailpiece, or on the front if space permits.

1. Article Addressed to:

ATTN: Head of the History Division
1700 W. Washington Street, FL. 7
Phoenix, Arizona 85007-2808



2. Article Number (Transfer from previous label)

RB 898 809 936 US

A. Signature: [Signature]

B. Recipient's Name and Address: [Address]

C. Date of Delivery: [Date]

D. Is delivery address correct? Yes/No

AUG 10 2018 PHOENIX, AZ 85007

3. Service Type: Registered Mail, Return Receipt for Merchandise, Signature Confirmation Restricted Delivery

932

USPS Tracking®

FAQs > (<https://www.usps.com/faqs/uspstracking-faqs.htm>)

Track Another Package +

Tracking Number: RB898809936US

Remove X

Your item was picked up at a postal facility at 7:56 am on August 10, 2018 in PHOENIX, AZ 85009.

Delivered

August 10, 2018 at 7:56 am
Delivered, Individual Picked Up at Postal Facility
PHOENIX, AZ 85009

Tracking History

August 10, 2018, 7:56 am
Delivered, Individual Picked Up at Postal Facility
PHOENIX, AZ 85009
Your item was picked up at a postal facility at 7:56 am on August 10, 2018 in PHOENIX, AZ 85009.

August 10, 2018, 7:45 am
Arrived at Unit
PHOENIX, AZ 85009

August 10, 2018, 12:47 am
Departed USPS Facility
PHOENIX, AZ 85026

August 10, 2018, 12:46 am
Arrived at USPS Facility
PHOENIX, AZ 85026

933

2022-011769 MISC Page: 935 of 2782
09/26/2022 03:35:37 PM Receipt #: 22-9381
Rec Fee: \$30.00 Darrell James Hill
Gila County, Az, Sadie Jo Bingham, Recorder



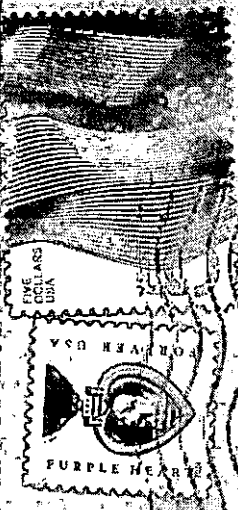

West Valley P&DC
THU 23 AUG 2018 PM

Darrell James Hill
c/o PO Box 3806
Apache Junction, Arizona 85117



2017 1000 0000 9343 0711

934

www.hamrick.com
9/18/18

2022-011769 MISC Page: 936 of 2782
09/26/2022 03:35:37 PM Receipt #: 22-9381
Rec Fee: \$30.00 Darrell James Hill
Gila County, Az, Sadie Jo Bingham, Recorder



:CERTIFICATE OF DISHONOR:

STATE OF ARIZONA

COUNTY OF MARICOPA

For the fact be it known that: I: JOHN KRAISS: notary public do now wherefore the actions by the man:Public-
persons: Katie: *Executive Assistant I* Mancino, et al., in the response to the CERTIFICATE OF PROTEST –
USPS CMN 7015 1730 0002 3063 9270, received: July 30th, 2018; and: Kristin: Summit County Fiscal Officer
Scalise, et al., in the response to the CERTIFICATE OF PROTEST, received: July 30th, 2018 – USPS CMN
7017 1000 0000 9343 0650 – who deprived the beneficiary affiant's private property in the right-executed
lucidated by the refusal of the Certificate of the Protest, and for all the costs, damages, and interest already
incurred, and hereafter incurred by the deprivation of rights refusal thereof, hereby certify on this 14th day:
August month, 2018 year A.D., that the CERTIFICATE OF PROTEST presented upon the request of the legal
entity :DARRELL JAMES HILL, by the Authorized Representative : Darrell- James: Hill, beneficiary – c/o PO
Box 3806, Apache Junction, Arizona 85117 – is dishonored for the reason of the silent - no-response answer in
the refusal of the CERTIFICATE OF PROTEST; no- payment of the Bill Of Costs presented according to the fee
schedule agreed activated by the deprivation of the right-executed and of the remedy due to the man: beneficiary.
See the BENEFICIARY CLAIM OF THE SILENT – NO-RESPONSE ANSWER RECEIVED IN THE
RESPONSES OFF THE CERTIFICATE OF PROTEST – annexed: 23 pages.

Whereof:

For the fact be it known that on this this 14th day: August month: 2018 year A.D., that I: John Kraiss deposited
this :CERTIFICATE OF DISHONOR postage-paid to the post office at the 13 East Ray Road, Gilbert, Arizona
85296 location, directed to the man: Public-persons charged:

Kristin: Summit County Fiscal Officer Scalise
c/o 175 South Main Street
Akron, Ohio [44308-1354]

USPS RMN RE 047 636 449 US

Katie: Executive Assistant I Mancino
c/o 175 South Main Street
Akron, Ohio [44308]

USPS RMN RB 898 809 975 US

Reason for the certification of the dishonor is: the silent - no-response answer in the refusal of the
CERTIFICATE OF PROTEST; no- payment of the Bill Of Costs in accordance with the fee schedule agreed
activated upon the deprivation of the right-executed and of the remedy to the man: beneficiary.

IN THE WITNESS WHEREOF: I have hereunto subscribed my name and affixed my seal of office.

Notary

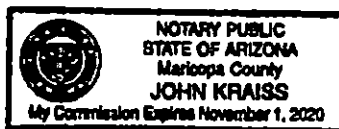

Seal

2022-011769 MISC Page: 937 of 2782
09/26/2022 03:35:37 PM Receipt #: 22-9381
Rec Fee: \$30.00 Darrell James Hill
Gila County, Az, Sadie Jo Bingham, Recorder

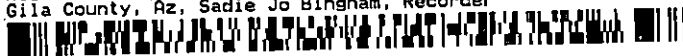

935

AFFIDAVIT: BENEFICIARY CLAIM OF THE SILENT - NO- RESPONSE ANSWER RECEIVED IN THE RESPONSES OF THE 'CERTIFICATE OF PROTEST

STATE OF ARIZONA

COUNTY OF PINAL

Darrell- James: Hill, man, personally presents before me, the undersigned Notary duly authorized by the laws of Arizona to administer oaths; now on this 13th, day: August month: 2018, being by me first duly sworn on his affirmation, affiant deposes and says:

- 1) i:man, also known as: Darrell- James: Hill, am: beneficiary of the natural- and public- trust rights- exercised in the regard unto the Certificate Of Protest presented to the parties: Katie: etc., et al., USPS CMN 7015 1730 0002 3063 9270– annexed: 18 pages; and: Kristin: etc., et al., USPS CMN 7017 1000 0000 9343 0650– annexed: 18 pages.
- 2) i:man requested the Certificate Of Protest presentation unto the parties.
- 3) i:man received USPS return receipt notification that: Certificate Of Protest mailings were received. See: Certificate Of Protest to: Katie: etc., et al., USPS CMN 7015 1730 0002 3063 9270 – annexed: 2 pages; and: Kristin: etc., et al., USPS CMN 7017 1000 0000 9343 0650 – annexed: 2 pages; thereto:
- 4) Answer from Katie: etc., et al., now to date is: silent – no-response answer; and:
- 5) Answer from Kristen: etc., et al., now to date is: silent – no-response answer.

Without prejudice,

Autographed: 13th day: August month: 2018

Darrell- James: Hill
Darrell- James: Hill :beneficiary



Sworn to and subscribed before me now on this 13th day: August month: 2018.
Produced identification: type: Arizona Driver License.

[Signature]
Notary

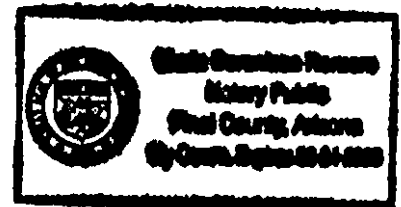

Seal

938

Registered Mail Receipt

Postage \$ **2.26**

Extra Services & Fees (continued)

Signature Confirmation \$

Registered Mail \$ **12.60**

Return Receipt (hardcopy) \$ **2.75**

Return Receipt (electronic) \$ **0.00**

Restricted Delivery \$ **0.00**

Total Postage & Fees \$ **17.61**

Customer Must Declare Full Value \$ **21.00**

Received by **08/14/2018**

Domestic insurance up to \$50,000 is included based upon the declared value. International indemnity is limited. (See Reverse).

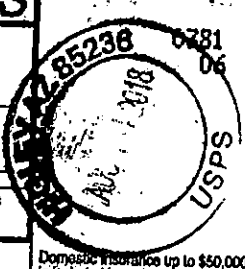

OFFICIAL USE

FROM: HIGLEY, AZ 85236

Darrell James Hill
c/o PO Box 3806
Apache Junction, Arizona 85117

TO: Akron, OH 44308

Katie, Executive Assistant / Mancino
175 South Main Street
Akron, Ohio 44308-1354

PS Form 3806, Registered Mail Receipt
April 2015, PSN 7530-02-000-9051
For domestic delivery information, visit our website at www.usps.com

3324 E. RAY RD
HIGLEY
AZ
85236-4500
0338850381
08/14/2018 (800)275-8777 9:06 AM

Product Description	Sale Qty	Final Price
First-Class Mail Large Envelope (Domestic) (PHOENIX, AZ 85003) (Weight: 0 Lb 9.60 Oz) (Estimated Delivery Date) (Thursday 08/16/2018)	1	\$2.89

Return Receipt 1 \$2.75

Registered (Amount: \$21.00) 1 \$12.60

First-Class Mail Large Envelope (Domestic) (TUCSON, AZ 85701) (Weight: 0 Lb 9.60 Oz) (Estimated Delivery Date) (Thursday 08/16/2018)

Registered (Amount: \$21.00) 1 \$12.60

Return Receipt 1 \$2.75

First-Class Mail Large Envelope (Domestic) (AKRON, OH 44308) (Weight: 0 Lb 6.10 Oz) (Estimated Delivery Date) (Friday 08/17/2018)

Registered (Amount: \$21.00) 1 \$12.60

Return Receipt 1 \$2.75

Registered No. **RE 087636449 US**

Postage \$ **2.05**

Extra Services & Fees (continued)

Signature Confirmation \$

Registered Mail \$ **12.60**

Return Receipt (hardcopy) \$ **2.75**

Return Receipt (electronic) \$ **0.00**

Restricted Delivery \$ **0.00**

Total Postage & Fees \$ **17.60**

Customer Must Declare Full Value \$ **21.00**

Received by **08/14/2018**

Domestic insurance up to \$50,000 is included based upon the declared value. International indemnity is limited. (See Reverse).

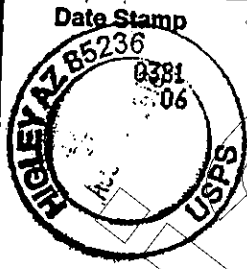

OFFICIAL USE

FROM: HIGLEY, AZ 85236

Darrell James Hill
c/o PO Box 3806
Apache Junction, Arizona 85117

TO: Akron, OH 44308

Katie, Executive Assistant / Mancino
175 South Main Street
Akron, Ohio 44308-1354

Registered (Amount: \$21.00) 1 \$12.60

Return Receipt 1 \$2.75

First-Class Mail Large Envelope (Domestic) (AKRON, OH 44308) (Weight: 0 Lb 6.10 Oz) (Estimated Delivery Date) (Friday 08/17/2018)

Registered (Amount: \$21.00) 1 \$12.60

Return Receipt 1 \$2.75

SENDER: COMPLETE THIS SECTION

- Complete items 1, 2, and 3.
- Print your name and address on the reverse so that we can return the card to you.
- Attach this card to the back of the mailpiece or on the front if space permits.

COMPLETE THIS SECTION ON DELIVERY

Received by (Printed Name) **[Signature]**

Date of Delivery **08/14/2018**

is delivery address different from item 1? Yes No

If YES, enter delivery address below:

Receipt #) 21976330

1 \$2.05

1 \$12.60

1 \$2.75

Receipt #) 1976347

\$71.49

\$80.00

(\$8.51)

1. Article Addressed to:

Katie, Executive Assistant / Mancino
175 South Main Street
Akron, Ohio 44308-1354

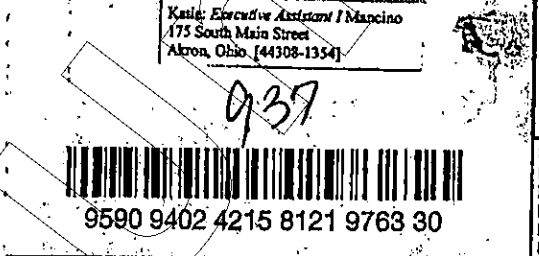

2. Article Number (Transfer from service label)
RB 898 809 975 US

PS Form 3811, July 2015 PSN 7530-02-000-9053

Domestic Return Receipt member to 28777

MISC Page: 939 of 2782
09/26/2022 03:35:37 PM Receipt #: 22-9381
Rec Fee: \$30.00 Darrell James Hill
Gila County, Az, Sadie Jo Bingham, Recorder

USPS Tracking®

FAQs > (<https://www.usps.com/faqs/uspstracking-faqs.htm>)

Track Another Package +

Tracking Number: RB898809975US

Remove X

Your item was delivered to an individual at the address at 10:49 am on August 21, 2018 in AKRON, OH 44308.

Delivered

August 21, 2018 at 10:49 am
Delivered, Left with Individual
AKRON, OH 44308

Tracking History

August 21, 2018, 10:49 am
Delivered, Left with Individual
AKRON, OH 44308

Your item was delivered to an individual at the address at 10:49 am on August 21, 2018 in AKRON, OH 44308.

August 21, 2018, 9:37 am
Out for Delivery
AKRON, OH 44308

August 21, 2018, 5:52 am
Arrived at Unit
AKRON, OH 44302

August 20, 2018, 10:43 pm
Arrived at USPS Regional Destination Facility
AKRON OH DISTRIBUTION CENTER

2022-011769 MISC Page: 940 of 2782

09/26/2022 03:35:37 PM Receipt #: 22-9381

Rec Fee: \$30.00 Darrell James Hill

Gila County, Az, Sadie Jo Bingham, Recorder



938

USPS Tracking®

FAQs > (<https://www.usps.com/faqs/uspstracking-faqs.htm>)

Track Another Package +

Tracking Number: RE047636449US

Remove X

Your item was delivered to an individual at the address at 10:49 am on August 21, 2018 in AKRON, OH 44308.

✓ Delivered

August 21, 2018 at 10:49 am
Delivered, Left with Individual
AKRON, OH 44308

Tracking History ^

August 21, 2018, 10:49 am
Delivered, Left with Individual
AKRON, OH 44308

Your item was delivered to an individual at the address at 10:49 am on August 21, 2018 in AKRON, OH 44308.

August 21, 2018, 9:37 am
Out for Delivery
AKRON, OH 44308

August 21, 2018, 5:52 am
Arrived at Unit
AKRON, OH 44302

August 20, 2018, 10:43 pm
Arrived at USPS Regional Destination Facility
AKRON OH DISTRIBUTION CENTER

2022-011769 MISC Page: 941 of 2782
09/26/2022 03:35:37 PM Receipt #: 22-9381
Rec Fee: \$30.00 Darrell James Hill
Gila County, Az, Sadie Jo Bingham, Recorder



939

Official Copy

:CERTIFICATE OF DISHONOR:

**STATE OF ARIZONA
COUNTY OF MARICOPA**

For the fact be it known that: I: JOHN KRAISS: notary public do now wherefore the actions by the man:Public- persons: Brian: Clerk of Court Karth - USDC: Arizona, Phoenix, et al., in the response to the CERTIFICATE OF PROTEST – CMN 7015 1730 0002 3063 9256, received: July 27th, 2018; and: Ranier: Chief Judge Collins – USDC Arizona, et al. in the response to the CERTIFICATE OF PROTEST, received: July 30th, 2018 – CMN 7015 1730 0002 3063 9263 – who deprived the beneficiary affiant's private property in the right-executed lucidated by the refusal of the Certificate of the Protest, and for all the costs, damages, and interest already incurred, and hereafter incurred by the deprivation of rights refusal thereof, hereby certify on this 14th day: August month, 2018 year A.D., that the CERTIFICATE OF PROTEST presented upon the request of the legal entity :DARRELL JAMES HILL, by the Authorized Representative : Darrell- James: Hill, beneficiary – c/o PO Box 3806, Apache Junction, Arizona 85117 – is dishonored for the reason in the answer from the man:Public persons charged is non-responsive to the CERTIFICATE OF PROTEST; to wit: man:Public persons charged refused the CERTIFICATE OF PROTEST – returning the document with: no mention of the charges of the CERTIFICATE OF PROTEST; no payment of the fee schedule for the trespass on the case unto the initial common law claim-referenced, no correction made for the common law trial by jury claim ordered as required; and, no promotion, ensurance, nor protection of the beneficiary's rights-executed for the common law trial by jury made unto the man:Public persons Brian, et al., and Ranier, et al., upon the initial common law claim process: January- 2017. See BENEFICIARY CLAIM OF NON-RESPONSIVE ANSWER IN THE REFUSAL OF THE CERTIFICATE OF PROTEST – annexed: 51 pages.

Whereof:

For the fact be it known that on this this 14th day: August month: 2018 year A.D., that I: John Kraiss deposited this: **CERTIFICATE OF DISHONOR** postage-paid to the post office at the 13 East Ray Road, Gilbert, Arizona 85296 location, directed to the man parties charged:

Ranier: Chief Judge Collins
DeConcini U.S. Courthouse
405 West Congress Street, Suite 5190
Tucson, Arizona [85701]

USPS RMN RE 047 636 435 US

Brian: Clerk of Court Karth
Sandra Day O'Connor U.S. Courthouse, Suite 130
401 West Washington Street, SPC 1
Phoenix Arizona [85003-2118]

USPS RMN RB 898 809 940 US

Reason for the certification of the dishonor is: CERTIFICATE OF PROTEST – for the no filing of the common law claim-referenced against the right of the beneficiary for the establishment of the common law trial by jury court at the Phoenix venue; no- payment of the fee schedule required as agreed for the trespass upon the case against the right of the beneficiary for the establishment of the common law trial by jury court at the Phoenix venue - response in the refusal of the Certificate of the Protest.

IN THE WITNESS WHEREOF, I have hereunto subscribed my name and affixed my seal of office.

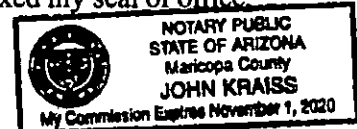

Seal

**AFFIRMATION: BENEFICIARY CLAIM OF NON- RESPONSIVE ANSWER
IN THE REFUSAL OF THE CERTIFICATE OF PROTEST**

Arizona state

Maricopa county

i: man :Darrell- James: Hill, now on this 13th day: August month: 2018, affirm and say:

- 1) i:man am: beneficiary of the inherent right and public trust named: DARRELL JAMES HILL, also known as: Darrell- James: Hill :Ohioan and Authorized Representative for the rights-executed in the regard unto the Certificate Of Protest presented to the parties: Brian: etc., et al., – CMN 7015 1730 0002 3063 9256, – and: Ranier: etc., et al., – CMN 7015 1730 0002 3063 9263.
- 2) i:man requested for the Certificate Of Protest presentation to the parties: Brian and Ranier: et al.
- 3) i:man received USPS return receipt of the notification: Certificate Of Protest mailings were received. See: Certificate Of Protest to: Brian: etc., et al., – CMN 7015 1730 0002 3063 9256 – annexed: 2 pages; and: Ranier: etc., et al., – CMN 7015 1730 0002 3063 9263 – annexed: 2 pages. Thereto:
- 4) Answer from Brian: etc., et al., now to date is: return of the documents sent with the no filing of the common law claim as is required by the man: beneficiary - see annexed: 47 pages of content; nor payment of the Bill Of Costs according to the fee schedule agreed activated upon this trespass upon the case; and:
- 5) Answer from Ranier: etc., et al., now to date is: return of the documents sent with the no filing of the common law claim as is required by the man: beneficiary - see annexed: 47 pages; nor payment of the Bill Of Costs according to the fee schedule agreed activated upon this trespass upon the case.
- 6) Answer from the wrong-doers is with the near identical offers for to proceed under their presumption; and:
- 7) Both of the near identical offers by the same hand from the wrong-doers for this beneficiary to contract under the coercion of their presumptive jurisdiction that is at the basis of this claim is an unconscionable contract by the wrong-doers' deliberate design for the continued deprivation of the aggrieved beneficiary's right-executed for the common law trial by the jury originally ordered: January- 2017.

i:man say now and will affirm same in the open court.

Without prejudice,
DARRELL JAMES HILL

:Darrell- James: Hill
:Darrell- James: Hill, beneficiary, A.R.

Autographed: 13th day: August month: 2018

2022-011769 MISC Page: 943 of 2782
09/26/2022 03:35:37 PM Receipt #: 22-9381
Rec Fee: \$30.00 Darrell James Hill
Gila County, Az, Sadie Jo Bingham, Recorder



8889809940US

3324 E RAY RD
HIGLEY
AZ
85236-4500
0338850381

0381
06

08/14/2018 (800)275-8777 9:06 AM

To Be Completed By Post Office	
Postage \$ \$2.89	Extra Services & Fees (optional)
Extra Services & Fees	<input type="checkbox"/> Signature Confirmation
<input type="checkbox"/> Registered Mail \$ \$12.60	<input type="checkbox"/> Signature Confirmation Restricted Delivery
<input type="checkbox"/> Return Receipt (hardcopy) \$ \$2.75	<input type="checkbox"/> Signature Confirmation Restricted Delivery
<input type="checkbox"/> Return Receipt (electronic) \$ \$0.00	<input type="checkbox"/> Signature Confirmation Restricted Delivery
<input type="checkbox"/> Restricted Delivery \$ \$0.00	<input type="checkbox"/> Signature Confirmation Restricted Delivery
Total Postage & Fees \$ \$18.24	
Customer Must Declare Full Value \$ \$21.00	Received by 08/14/2018

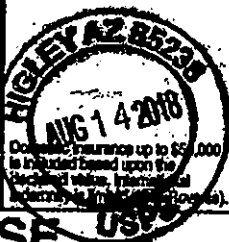

OFFICIAL USE

FROM	
HIGLEY, AZ 85236	
Darril James Hill c/o PO Box 3806 Apache Junction, Arizona 85117	
TO	
PHOENIX, AZ 85003	
First Class of Court Clerk, et al. Sandra Day O'Connor U.S. Courthouse, Suite 130 401 West Washington Street, SPC 1 Phoenix Arizona (85003-2118)	

Form 3806, Registered Mail Receipt
 April 2015, PSN 7530-02-000-9051
 For domestic delivery information, visit our website at www.usps.com

registered No. **RE047636435US**

To Be Completed By Post Office	
Postage \$ \$2.89	Extra Services & Fees (optional)
Extra Services & Fees	<input type="checkbox"/> Signature Confirmation
<input type="checkbox"/> Registered Mail \$ \$12.60	<input type="checkbox"/> Signature Confirmation Restricted Delivery
<input type="checkbox"/> Return Receipt (hardcopy) \$ \$2.75	<input type="checkbox"/> Signature Confirmation Restricted Delivery
<input type="checkbox"/> Return Receipt (electronic) \$ \$0.00	<input type="checkbox"/> Signature Confirmation Restricted Delivery
<input type="checkbox"/> Restricted Delivery \$ \$0.00	<input type="checkbox"/> Signature Confirmation Restricted Delivery
Total Postage & Fees \$ \$18.24	
Customer Must Declare Full Value \$ \$21.00	Received by 08/14/2018

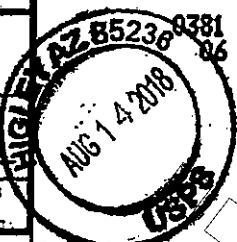

OFFICIAL USE

FROM	
HIGLEY, AZ 85236	
Darril James Hill c/o PO Box 3806 Apache Junction, Arizona 85117	
TO	
TUCSON, AZ 85701	
Barry Collins Evo A. DeLoach U.S. Courthouse 405 West Congress Street, Suite 5190 Tucson, Arizona (85701)	

Form 3806, Registered Mail Receipt
 April 2015, PSN 7530-02-000-9051
 For domestic delivery information, visit our website at www.usps.com

Product Description Sale Qty Final Price

First-Class Mail 1 \$2.89
 Large Envelope (Domestic) (PHOENIX, AZ 85003) (Weight:0 Lb 9.60 Oz) (Estimated Delivery Date) (Thursday 08/16/2018)

Return Receipt 1 \$2.75
 (USPS Return Receipt #) (9590940242158121976316)

Registered 1 \$12.60
 (Amount:\$21.00) (USPS Registered Mail #) (8889809940US)

First-Class Mail 1 \$2.89
 Large Envelope (Domestic) (TUCSON, AZ 85701) (Weight:0 Lb 9.60 Oz) (Estimated Delivery Date) (Thursday 08/16/2018)

Registered 1 \$12.60
 (Amount:\$21.00) (USPS Registered Mail #) (RE047636435US)

Return Receipt 1 \$2.75
 (USPS Return Receipt #) (9590940242158121976323)

First-Class Mail 1 \$2.26
 Large Envelope (Domestic) (AKRON, OH 44308) (Weight:0 Lb 6.10 Oz) (Estimated Delivery Date) (Friday 08/17/2018)

Registered 1 \$12.60
 (Amount:\$21.00) (USPS Registered Mail #)

2022-011769 MISC Page: 944 of 2782
 09/26/2022 03:35:37 PM Receipt #: 22-9381
 Rec Fee: \$30.00 Darrell James Hill, Recorder
 Gila County, Az, Sadie Jo Bingham

SENDER: COMPLETE THIS SECTION

- Complete items 1, 2, and 3.
- Print your name and address on the reverse so that we can return the card to you.
- Attach this card to the back of the mailpiece, or on the front if space permits.

1. Article Addressed to:

Barry Chief Judge Collins,
 Evo A. DeLoach U.S. Courthouse
 405 West Congress Street, Suite 5190
 Tucson, Arizona (85701)



2. Article Number (transfer from sender label)

RE 047 636 435 US

PS Form 3811, July 2015 PSN 7530-02-000-9053

COMPLETE THIS SECTION ON DELIVERY

A. Signature *[Signature]* Agent Addressee

B. Received by (Printed Name) _____ C. Date of Delivery _____

D. Is delivery address different from item 1? Yes No
 If YES, enter delivery address below: _____

3. Service Type

Adult Signature Priority Mail Express®

Adult Signature Restricted Delivery Registered Mail™

Certified Mail® Registered Mail Restricted Delivery

Certified Mail Restricted Delivery Return Receipt for Merchandise

Collect on Delivery Signature Confirmation™

Collect on Delivery Restricted Delivery Signature Confirmation Restricted Delivery

Text your tracking number to 48484 (TUSCON) to get the latest status
 Domestic Return Receipt

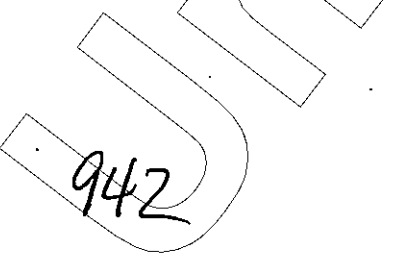

USPS Tracking®

FAQs > (<http://faq.usps.com/?articleId=220900>)

Track Another Package +

Tracking Number: RE047636435US

Remove X

Expected Delivery on

WEDNESDAY

15 AUGUST 2018 ⓘ

by **8:00pm** ⓘ

Delivered

August 15, 2018 at 2:41 pm
Delivered, Left with Individual
TUCSON, AZ 85701

Get Updates ▾

Text & Email Updates ▾

Tracking History ▲

August 15, 2018, 2:41 pm
Delivered, Left with Individual
TUCSON, AZ 85701

Your item was delivered to an individual at the address at 2:41 pm on August 15, 2018 in TUCSON, AZ 85701.

August 15, 2018, 9:56 am
Out for Delivery
TUCSON, AZ 85701

August 15, 2018, 9:46 am

2022-011769 MISC Page: 945 of 2782

09/26/2022 03:35:37 PM Receipt #: 22-9381

Rec Fee: \$30.00 Darrell James Hill

Gila County, Az, Sadie Jo Bingham, Recorder



PM

943

Official Copy

RB898809940US

3324 E RAY RD

HIGLEY

AZ

85236-4500

0338850381

(800)275-8777

9:06 AM

0381
06

08/14/2018

To Be Completed
By Post Office

Postage \$	\$2.89	Extra Services & Fees (included)	
Extra Services & Fees		<input type="checkbox"/> Signature Confirmation	
<input type="checkbox"/> Registered Mail \$	\$12.60	<input type="checkbox"/> Signature Confirmation Restricted Delivery	
<input type="checkbox"/> Return Receipt (hardcopy) \$	\$2.75		
<input type="checkbox"/> Return Receipt (electronic) \$	\$0.00		
<input type="checkbox"/> Restricted Delivery \$	\$0.00		
Total Postage & Fees			\$18.24
Customer Must Declare Full Value \$		Received by	08/14/2018

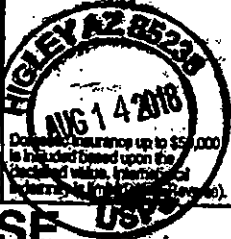

Domestic insurance up to \$50,000 is included based upon the declared value. International insurance is limited to \$100 (see Form 3800).

OFFICIAL USE

FROM		HIGLEY, AZ 85236
		Darrell James Hill c/o PO Box 3806 Apache Junction, Arizona 85117
TO		PHOENIX, AZ 85003
		Eric Clark of Court Karik, et al. Sandra Day O'Connor U.S. Courthouse, Suite 130 401 West Washington Street, SPC 1 Phoenix Arizona (85003-2118)

Form 3806, Registered Mail Receipt
© 2015, PSN 7530-02-000-9051
For domestic delivery information, visit our website at www.usps.com

registered No. RE047636435US Date Stamp

Postage \$	\$2.89	Extra Services & Fees (included)	
Extra Services & Fees		<input type="checkbox"/> Signature Confirmation	
<input type="checkbox"/> Registered Mail \$	\$12.60	<input type="checkbox"/> Signature Confirmation Restricted Delivery	
<input type="checkbox"/> Return Receipt (hardcopy) \$	\$2.75		
<input type="checkbox"/> Return Receipt (electronic) \$	\$0.00		
<input type="checkbox"/> Restricted Delivery \$	\$0.00		
Total Postage & Fees			\$18.24
Customer Must Declare Full Value \$		Received by	08/14/2018

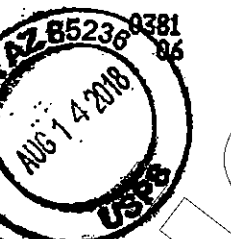

Domestic insurance up to \$50,000 is included based upon the declared value. International insurance is limited. (See Reverse).

OFFICIAL USE

FROM		HIGLEY, AZ 85236
		Darrell James Hill c/o PO Box 3806 Apache Junction, Arizona 85117
TO		TUCSON, AZ 85701
		Eric Clark of Court Karik, et al. Sandra Day O'Connor U.S. Courthouse, Suite 130 401 West Washington Street, SPC 1 Phoenix Arizona (85003-2118)

Form 3806, Registered Mail Receipt
© 2015, PSN 7530-02-000-9051
For domestic delivery information, visit our website

SENDER: COMPLETE THIS SECTION

- Complete items 1, 2, and 3.
- Print your name and address on the reverse so that we can return the card to you.
- Attach this card to the back of the mailpiece, or on the front if space permits.

1. Article Addressed to:

Eric Clark of Court Karik, et al.
Sandra Day O'Connor U.S. Courthouse, Suite 130
401 West Washington Street, SPC 1
Phoenix Arizona (85003-2118)

2. Article Number (Transfer from service label)
RB 898 809 940 US

PS Form 3811, July 2015 PSN 7530-02-000-9053

COMPLETE THIS SECTION ON DELIVERY

A. Signature Agent Addressee

B. Received by (Printed Name) Agent Addressee

C. Date of Delivery 8/15/18

D. Is delivery address different from item 1? Yes No
If YES, enter delivery address below:

3. Service Type

Adult Signature Priority Mail Express®

Adult Signature Restricted Delivery Registered Mail™

Certified Mail® Registered Mail Restricted Delivery

Certified Mail Restricted Delivery Return Receipt for Merchandise

Collect on Delivery Signature Confirmation™

Collect on Delivery Restricted Delivery Signature Confirmation Restricted Delivery

Insured Mail Signature Confirmation Restricted Delivery (over \$500)



9590 9402 4215 8121 9763 16

2022-011769 MISC Page: 946 of 2782
08/26/2022 03:35:37 PM Receipt #: 22-9381
Rec Fee: \$30.00 Darrell James Hill
Gila County, Az, Sadie Jo Bingham, Recorder

944

Text your tracking number to 28777 (211506) to get the latest status

USPS Tracking®

FAQs > (<http://faq.usps.com/?articleId=220900>)

Track Another Package +

Tracking Number: RB898809940US

Remove X

Expected Delivery on

WEDNESDAY

15 AUGUST
2018 ⓘ

by
8:00pm ⓘ

Delivered

August 15, 2018 at 12:00 pm
Delivered, To Agent
PHOENIX, AZ 85003

Get Updates ▾

Text & Email Updates ▾

Tracking History ▲

August 15, 2018, 12:00 pm
Delivered, To Agent
PHOENIX, AZ 85003

Your item has been delivered to an agent at 12:00 pm on August 15, 2018 in PHOENIX, AZ 85003.

August 15, 2018, 6:57 am
Arrived at Unit
PHOENIX, AZ 85034

August 14, 2018, 11:02 pm

2022-011769 MISC Page: 947 of 2782
09/26/2022 03:35:37 PM Receipt #: 22-9381
Rec Fee: \$30.00 Darrell James Hill
Gila County, Az, Sadie Jo Bingham, Recorder



3/2018, 9:16 PM

945

Official Copy

Beverly- Jean: Romero- Hill PO Box 3806, Apache Junction, Arizona 85119 (480) 276-1014

Jovita: Treasurer Carranza
Office of the Treasurer, Room 2134
1500 Pennsylvania Avenue, NW
Washington, District of Columbia 20220

USPS CMN 7018 0360 0000 5969 3885

Jack: Fiscal Assistant Secretary Lew
Department of the Treasury
1500 Pennsylvania Ave., NW
Washington, District of Columbia 20220

USPS CMN 7018 0360 0000 5969 3892

Steven- Turner: Secretary Mnuchin
Department of the Treasury
1500 Pennsylvania Ave., NW
Washington, District of Columbia 20220

USPS CMN 7018 0360 0000 5969 3908

Kimberly: Commissioner Troy
Bureau of the Fiscal Service
3201 Penny Drive, Building E
Landover, Maryland 20785

USPS CMN 7018 0360 0000 5969 3915

Jovita, Steven, Jack, Kimberly, Greetings,

i: man: beneficiary of the inherent- and public- trusts am: Beverly: live, New Mexican, sixty years of age, sound mind; am: authorized representative -and holder in the due course of the New Mexico Birth Certificate: No. 1480261, established with the subrogation: BEVERLY JEAN ROMERO - CUSIP # [REDACTED] - for the use by the United States as the trustee for the estate trust(s) or foreign situs trust(s) or public transmitting utility(ies) for the benefit of the i:man: beneficiary.

i: need and require from the United States trusteeship: description of the property, accounting and debt of the same as is indicated - See: AFFIDAVIT: PROOF OF LIFE TO SUPPORT PAYMENT - annexed: 5 pages.

Notice to agent is notice to the principal: Notice to principal is notice to the agent; and, Thank you in advance.

I say now and will affirm the same in the open court.

Without Prejudice
BEVERLY JEAN ROMERO



Autographed: 20th day: August month: 2018

Beverly Jean: Romero Hill
:Beverly- Jean: Romero- Hill, beneficiary, A.R.

UNOFFICIAL

2022-011769 MISC Page: 948 of 2782
09/26/2022 03:35:37 PM Receipt #: 22-9381
Rec Fee: \$30.00 Darrell James Hill
Gila County, Az, Sadie Jo Bingham, Recorder



AFFIDAVIT: PROOF OF LIFE TO SUPPORT PAYMENT

Beneficiary Affiant: man-female: Beverly- Jean: Romero- Hill', is:
a) live, New Mexican, sixty years of age, sound mind; and,
b) demands: United States- trustee for:
i) description of the property and accounts in trust, and
ii) the accounts summary to the fiscal years ending: 2016 and 2017

Arizona state
Pinal county

i: man: beneficiary of the inherent- and public- trusts am: **Beverly-Jean: Romero- Hill © @ 1958;**
i: beneficiary am: live, New Mexican, sixty years age, sound mind; am: authorized representative, "A.R." and,
am: holder in the due course and subrogee of the **New Mexico Birth Certificate: No. 1480261²**, registered with
the idem sonans subrogation: **BEVERLY JEAN ROMERO – :CUSIP # [REDACTED]** – for the use by the United
States as the trustee for the estate trust(s) and foreign situs trust(s) and public transmitting utility(-ies), also by/
with varied derivative names, for the benefit of the i:man: beneficiary :**Beverly-Jean: Romero- Hill, – wife to:**
Darrell-James: Hill © @ 1958 :sole first beneficiary of i:man: **Beverly-Jean: Romero- Hill** for: all-property and
accounts, herein now affirmed –
Whereof:

U.S. Trustee United States- trustee to i:man: beneficiary- subrogee delegated fiduciary duty and
responsibility to the man:Public person "Kimberly: Commissioner Troy; understanding: Jack:
Fiscal Assistant Secretary Lew, understanding: Steven- Turner: Secretary Mnuchin with advise
from: Jovita: Treasurer Carranza

Beneficiary- Subrogee Request i: beneficiary- subrogee: **Beverly-Jean: Romero- Hill, A.R.,** require:
1) individual reports of the description of all the property;
2) all account reports for the fiscal years: 2016 and 2017; and,
3) account of the public side debt owed by this beneficiary.

Notice: Promotion and guarantee in the help and assurance of the obtainment of this right-executed is
required per the ICCPR 1992 Treaty⁴. Please be informed: fee schedule⁵ is in place for the
United States" Executive Branch for the any man:Public person any wrong-doing in the
fiduciary duty to this beneficiary.

Notice to the agent is notice to the principal: Notice to the principal is notice to the agent. – Thank you.

i: man say now and will affirm same in the open court.

Without Prejudice
BEVERLY JEAN ROMERO- HILL

Autographed: 21th day: August month: 2018

Beverly Jean Romero Hill
:Beverly- Jean: Romero- Hill, beneficiary, A.R.

Sworn to and subscribed before me now on this 21st day: August month: 2018.
Produced identification: type: Arizona Driver License⁶

Notary

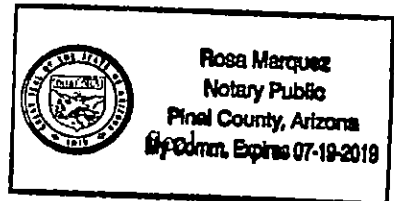

1 See: 'Live-Life Document': Rio Arriba County, New Mexico Recorder Doc Id: 2018-02361; pp 1-7 of 7; and Gila
County, Arizona Recorder: Doc # 2018-005176, pp 2-9 of 21. AFFIDAVIT: JURAT: CURATIVE REGISTRATION
OF THE FOUND LIVE LIFE: Beverly- Jean: Romero- Hill, grantee: CESTUI QUE VIE-ESTATE TRUST-NAMED:
BEVERLY JEAN ROMERO' recorder.gilacountyaz.gov/recorder/web/ -last visited: August 20th, 2018
2 See: copy of authentication: New Mexico Birth Certificate: **BEVERLY JEAN ROMERO: No. 1480261** – annexed: 3
pages.
3 **BEVERLY JEAN ROMERO: CUSIP # 585049917**, a person's SSN without the hyphenations, et seq.
4 ICCPR 1992 Treaty means: U.S. Reservations, declarations, and understandings, International Covenant on Civil and
Political Rights: 138 Cong. Rec. S4781-01 (daily ed., April 2, 1992)
<https://www.state.gov/documents/organization/235639.pdf> -last visited: August 20th, 2018
5 Fee schedule means: AFFIDAVIT: Superior Constructive Notice and Demand: permanent Non-Commercial
Presumption, et seq.: AFFIDAVIT of **BEVERLY JEAN ROMERO- HILL** Commercial Status. Gila County, Arizona,
Recorder Doc. #: 2017-002378: pp. 128-152 of 693, et seq.; and: Office of the Treasury: pp. 161-163 of 693: received:
September – October 2016, respectfully.
6 Arizona Driver License: See Copy Certification: Arizona Driver License: **BEVERLY JEAN ROMERO- HILL: No.**
D01385612 – annexed: 1 page

947



United States of America



DEPARTMENT OF STATE

To all to whom these presents shall come, Greetings:

I Certify That the document hereunto annexed is under the Seal of the State(s) of New Mexico, and that such Seal(s) is/are entitled to full faith and credit.*

**For the contents of the annexed document, the Department assumes no responsibility
This certificate is not valid if it is removed or altered in any way whatsoever*

In testimony whereof, I, Michael R. Pompeo, Secretary of State, have hereunto caused the seal of the Department of State to be affixed and my name subscribed by the Assistant Authentication Officer, of the said Department, at the city of Washington, in the District of Columbia, this fifteenth day of August, 2018.

Michael R. Pompeo

Secretary of State

By _____

Assistant Authentication Officer,
Department of State

Issued pursuant to Chap. XIV, State of
Sept. 15, 1789, 1 Stat. 68-69; 22
USC 2657; 22USC 2651a; 5 USC
301; 28 USC 1733 et. seq.; 8 USC
1443(f); RULE 44 Federal Rules of
Civil Procedure.

2022-011769 MISC Page: 950 of 2782
09/26/2022 03:35:37 PM Receipt #: 22-9381
Rec Fee: \$30.00 Darrell James Hill
Gila County, Az. Sadie Jo Bingham, Recorder



Unofficial Copy

For information purpose *Only*
: Beverly Jean Romero Hill / Beneficiary A/R

949

2022-011769 MISC Page: 951 of 2782
09/26/2022 03:35:37 PM Receipt #: 22-9381
Rec Fee: \$30.00 Darrell James Hill
Gila County, Az, Sadie Jo Bingham, Recorder



STATE OF NEW MEXICO



OFFICE OF THE
SECRETARY OF STATE
CERTIFICATE

I, MAGGIE TOULOUSE OLIVER, SECRETARY OF STATE FOR NEW MEXICO, DO
HEREBY CERTIFY

THAT

DONNA DOSSEY was the State Registrar VITAL STATISTICS, OFFICE OF VITAL RECORDS
AND HEALTH STATISTICS, PUBLIC HEALTH DIVISION, DEPARTMENT OF HEALTH for the
state of New Mexico on the date of execution shown on the Birth Certificate for BEVERLY JEAN
ROMERO CERTIFICATE NO. (19581503459) and appointed to the office with full authority to exercise
the duties and responsibilities of State Registrar and legally entrusted with the possession and custody of
the records and files thereof

GIVEN UNDER MY HAND AND THE
GREAT SEAL OF THE STATE OF
NEW MEXICO, IN THE CITY OF
SANTA FE, THE CAPITAL, ON THIS
16TH DAY OF JULY, 2018 A.D.

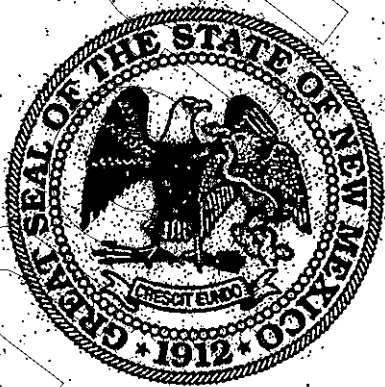

Maggie Toulouse Oliver

SECRETARY OF STATE

2022-011769 MISC Page: 952 of 2782
09/26/2022 03:35:37 PM Receipt #: 22-9381
Rec Fee: \$30.00 Darrell James Hill
Gila County, Az, Sadie Jo Bingham, Recorder



950

For information purpose Only
: Beverly Jean Romero Hill / Pennington / AR



951

2022-011769 MISC Page: 953 of 2782
09/26/2022 03:35:37 PM Receipt #: 22-9381
Rec Fee: \$30.00 Darrell James Hill
Gila County, Az, Sadie Jo Bingham, Recorder



That the following birth is registered in the New Mexico Vital Records and Health Statistics
Certified que en la Seccion del Registro de Nacimientos a mi cargo aparece la siguiente inscripcion

Request No. / Numero de Solicitud	County of Birth / Condado de Nacimiento	
9581563159	RIO ARriba	
Date of Birth / Fecha de Nacimiento	Date of Registration / Fecha de Inscripcion	Sex / Sexo
JUNE 15 1958	JUNE 15 1958	FEMALE
Name of Person Registered / Nombre del Registrado		
BEVERLY JEAN ROMERO		
Name of Father or Parent One / Nombre del Padre		
DELFERIO C ROMERO		
Birth Name of Mother or Parent Two / Nombre de Soltera de la Madre		
MARY ARGUELLO		

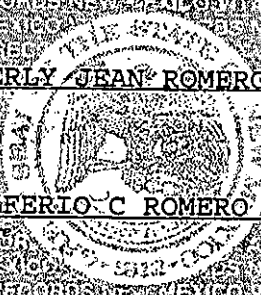

No 2254494

WARNING: IT IS ILLEGAL TO COPY OR COUNTERFEIT THIS CERTIFICATE
ADVERTENCIA: ES ILLEGAL COPIAR O FALSIFICAR ESTE CERTIFICADO

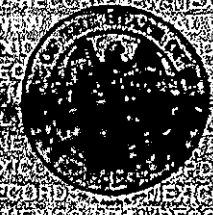

Donna Doney

SIGNATURE OF STATE REGISTRAR
FIRMA DEL REGISTRADOR DEL ESTADO
DECEMBER 18 2008

DO NOT DUPLICATE BY ANY MEANS

WARNING: It is illegal to alter, copy or counterfeit this certificate • ADVERTENCIA: Es ilegal alterar, copiar o falsificar este certificado

In testimony whereof, I, Michael R. Pompeo, Secretary of State, have hereunto caused the seal of the Department of State to be affixed and my name subscribed by the Assistant Authentication Officer, of the said Department, at the city of Washington, in the District of Columbia, this fifteenth day of August, 2018.

Michael R. Pompeo
Secretary of State

By *[Signature]*
Assistant Authentication Officer,
Department of State

Issued pursuant to CHXIV, State of Sept. 15, 1789, 1 Stat. 68-69, 22 USC 2657; 22 USC 2651a; 5 USC 301; 28 USC 1733 et. seq.; 8 USC 1443(f); RULE 44 Federal Rules of Civil Procedure.

952



For information purposes only

Beverly Jean Romero-Hill, Beneficiary AR

953

2022-011769 MISC Page: 955 of 2782
09/26/2022 03:35:37 PM Receipt #: 22-9381
Rec Fee: \$30.00 Darrell James Hill
Gila County, Az, Sadie Jo Bingham, Recorder



Beverly- Jean: Romero- Hill PO Box 3806, Apache Junction, Arizona 85119 (480) 276-1014

Jovita: Treasurer Carranza
Office of the Treasurer, Room 2134
1500 Pennsylvania Avenue, NW
Washington, District of Columbia 20220

USPS CMN 7018 0360 0000 5969 3885

Jack: Fiscal Assistant Secretary Lew
Department of the Treasury
1500 Pennsylvania Ave., NW
Washington, District of Columbia 20220

USPS CMN 7018 0360 0000 5969 3892

Steven- Turner: Secretary Mnuchin
Department of the Treasury
1500 Pennsylvania Ave., NW
Washington, District of Columbia 20220

USPS CMN 7018 0360 0000 5969 3908

Kimberly: Commissioner Troy
Bureau of the Fiscal Service
3201 Pennsy Drive, Building E
Landover, Maryland 20785

USPS CMN 7018 0360 0000 5969 3915

Jovita, Steven, Jack, Kimberly, Greetings,

i: man: beneficiary of the inherent- and public- trusts am: Beverly: live, New Mexican, sixty years of age, sound mind; am: authorized representative -and holder in the due course of the New Mexico Birth Certificate: No. 1480261, established with the subrogation: **BEVERLY JEAN ROMERO – CUSIP # [REDACTED]** – for the use by the United States as the trustee for the estate trust(s) or foreign situs trust(s) or public transmitting utility(ies) for the benefit of the i:man: beneficiary.

i: need and require from the United States trusteeship: description of the property, accounting and debt of the same as is indicated – See: **AFFIDAVIT: PROOF OF LIFE TO SUPPORT PAYMENT** – annexed: 5 pages.

Notice to agent is notice to the principal: Notice to principal is notice to the agent; and, Thank you in advance.

I say now and will affirm the same in the open court.

Without Prejudice
BEVERLY JEAN ROMERO



Autographed: 20th day: August month: 2018

Beverly Jean Romero Hill
:Beverly- Jean: Romero- Hill, beneficiary, A.R.

Unofficial Copy

2022-011769 MISC Page: 956 of 2782
09/26/2022 03:35:37 PM Receipt #: 22-9381
Rec Fee: \$30.00 Darrell James Hill
Gila County, Az, Sadie Jo Bingham, Recorder

954

State of Arizona
County of Pinal
[Name of County]

I, Heather Wood, a notary public, do certify that, on
[Name of Notary Performing the Certification]

the 20 day of August, 2018, I personally made the
[Day] [Month] [Year]

above/attached copy of Driver License from the
[Document Title]

original, and it is a true, exact, complete, and unaltered copy.

(seal) Heather Wood

[Affix Seal Here] Notary Public [Notary Public Signature]

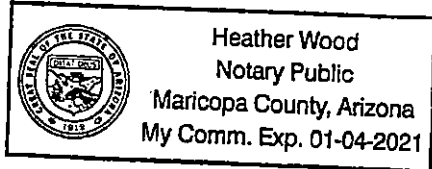

ARIZONA
Driver License

Number	D01385612
Expires	06/15/2023
Date of Birth	06/15/1958
Issued	10/07/2013

BEVERLY JEAN ROMERO HILL
3018 JOHNSON ST
LAKESIDE AZ 85929-5309

Class: D Sex: F
Eye: BR Height: 5-03
Hair: BR Weight: 150

without previous
Beverly Jean Romero Hill



955

2022-011769 MISC Page: 957 of 2782
09/26/2022 03:35:37 PM Receipt #: 22-9381
Rec Fee: \$30.00 Darrell James Hill
Gila County, Az, Sadie Jo Bingham, Recorder



SENDER: COMPLETE THIS SECTION

- Complete items 1, 2, and 3.
- Print your name and address on the reverse so that we can return the card to you.
- Attach this card to the back of the mailpiece, or on the front if space permits.

1. Article Addressed to:

Jovita: Treasurer Carranza
Office of the Treasurer, Room 2134
1500 Pennsylvania Avenue, NW
Washington, District of Columbia 20220

9590 9402 3852 8032 5376 11

7018 0360 0000 5969 3885

COMPLETE THIS SECTION ON DELIVERY

A. Signature
X Agent
 Addressee

B. Received by (Printed Name) C. Date of Delivery

Received
SEP 24 2018
FRP 306

D. Is delivery address different from item 1? Yes
If YES, enter delivery address below: No

3. Service Type
 Adult Signature Priority Mail Express®
 Adult Signature Restricted Delivery Registered Mail™
 Certified Mail® Registered Mail Restricted Delivery
 Certified Mail Restricted Delivery Return Receipt for Merchandise
 Collect on Delivery Signature Confirmation™
 Collect on Delivery Restricted Delivery Signature Confirmation Restricted Delivery
 1 Mail Signature Confirmation Restricted Delivery (over \$500)

PS Form 3811, July 2015 PSN 7530-02-000-9053 Domestic Return Receipt

SENDER: COMPLETE THIS SECTION

- Complete items 1, 2, and 3.
- Print your name and address on the reverse so that we can return the card to you.
- Attach this card to the back of the mailpiece, or on the front if space permits.

1. Article Addressed to:

Jack: Fiscal Assistant Secretary Lew
Department of the Treasury
1500 Pennsylvania Ave., NW
Washington, District of Columbia 20220

9590 9402 3852 8032 5376 04

2. Article Number (Transfer from service label)
7018 0360 0000 5969 3892

COMPLETE THIS SECTION ON DELIVERY

A. Signature
X Agent
 Addressee

B. Received by (Printed Name) C. Date of Delivery

Received
SEP 24 2018
FRP 306

D. Is delivery address different from item 1? Yes
If YES, enter delivery address below: No

3. Service Type
 Adult Signature Priority Mail Express®
 Adult Signature Restricted Delivery Registered Mail™
 Certified Mail® Registered Mail Restricted Delivery
 Certified Mail Restricted Delivery Return Receipt for Merchandise
 Collect on Delivery Signature Confirmation™
 Collect on Delivery Restricted Delivery Signature Confirmation Restricted Delivery
 Restricted Delivery

PS Form 3811, July 2015 PSN 7530-02-000-9053 Domestic Return Receipt

SENDER: COMPLETE THIS SECTION

- Complete items 1, 2, and 3.
- Print your name and address on the reverse so that we can return the card to you.
- Attach this card to the back of the mailpiece, or on the front if space permits.

1. Article Addressed to:

956
Steven Turner: Secretary Mnuchin
Department of the Treasury
1500 Pennsylvania Ave., NW
Washington, District of Columbia 20220

9590 9402 3852 8032 5325 00

2. Article Number (Transfer from service label)
7018 0360 0000 5969 3908

COMPLETE THIS SECTION ON DELIVERY

A. Signature
X Agent
 Addressee

B. Received by (Printed Name) C. Date of Delivery

Received
SEP 24 2018
FRP 306

D. Is delivery address different from item 1? Yes
If YES, enter delivery address below: No

3. Service Type
 Adult Signature Priority Mail Express®
 Adult Signature Restricted Delivery Registered Mail™
 Certified Mail® Registered Mail Restricted Delivery
 Certified Mail Restricted Delivery Return Receipt for Merchandise
 Collect on Delivery Signature Confirmation™
 Collect on Delivery Restricted Delivery Signature Confirmation Restricted Delivery
 Restricted Delivery

PS Form 3811, July 2015 PSN 7530-02-000-9053 Domestic Return Receipt

COPIED

2022-011769 MISC Page: 958 of 2782
09/26/2022 03:35:37 PM Receipt #: 22-9381
Rec Fee: \$30.00 Darrell James Hill Recorder
Gila County, AZ, Saddle Jo Bingham

Darrell-James: Hill c/o PO Box 3806, Apache Junction, Arizona 85117

Kristin: Summit County Fiscal Officer Scalise
c/o 175 South Main Street
Akron, Ohio 44308-1354

Kristin, Greetings,

I am beneficiary of the inherent rights and public-trust known by the idem sonans subrogation **DARRELL JAMES HILL** am :Darrell- James: Hill © ® 1958, subrogee and Authorized Representative, "A.R." i: and my wife :Beverly- Jean: Romero- Hill © ® 1958 are inhabitants on the Arizona state around and about the Apache Junction areas.

According to the records, documents a) and b) (indicated below) to you were received from a third party. This short questionnaire is only for to help ascertain that you have received the prescribed document(s).

Question:	Answer	Other: What did you receive?
a) Did you receive: Certificate of Protest , addressed to: Kristin: ~ USPS CMN 7017 1000 0000 9343 0650	Y	
a) Did you receive: Certificate of Dishonor , address: Kristin: ~ USPS RMN RE 047 636 449 US	Y	

- Instructions:**
- i. *If you have received the documents as described then you need not answer.*
 - ii. *Please complete the appropriate answer or answer Other.*
 - iii. *Return the completed questionnaire within 14 days time after this USPS receipt.*
 - iv. *If you do not answer then thereby you concede receipt of the prescribed documentati*

If you have Not received the prescribed document(s) then please promptly assure return of this clarification within 14 days from the date of this USPS CMN 7018 0360 0000 5969 3861 receipt.

Thank you

Without prejudice
DARRELL JAMES HILL

Autographed this 29th day: August month: 2018

Darrell-James: Hill
:Darrell- James: Hill A.R.

7018 0360 0000 5969 3861

2022-011769 MISC Page: 959 of 2782
 09/26/2022 03:35:37 PM Receipt #: 22-9381
 Rec Fee: \$30.00 Darrell James Hill, Recorder
 Gila County, Az, Sadie Jo Bingham

959

7018 0360 0000 5969 3678
 7018 0360 0000 5969 3678
 7018 0360 0000 5969 3678

U.S. Postal Service
CERTIFIED MAIL® RECEIPT
 Domestic Mail Only

For delivery information visit our website at www.usps.com

AKRON OH 44308 OFFICIAL USE

Certified Mail Fee	\$3.45	0130 77	Postmark Here
Extra Services & Fees (check box, add fee)	\$0.00		
<input type="checkbox"/> Return Receipt (hardcopy)	\$0.00	08/30/2018	
<input type="checkbox"/> Return Receipt (electronic)	\$0.00		
<input type="checkbox"/> Certified Mail Restricted Delivery	\$0.00		
<input type="checkbox"/> Adult Signature Required	\$0.00		
<input type="checkbox"/> Adult Signature Restricted Delivery	\$0.00		
Postage	\$0.50		
Total Postage and Fees	\$3.95		

Sent To: **Katie: Executive Assistant / Mascio**
 Street and Apt. No., or P.O. Box: **175 South Main Street**
 City, State, ZIP+4®: **Akron, Ohio (44308-1354)**

U.S. Postal Service
CERTIFIED MAIL® RECEIPT
 Domestic Mail Only

For delivery information visit our website at www.usps.com

AKRON OH 44308 OFFICIAL USE

Certified Mail Fee	\$3.45	0130 77	Postmark Here
Extra Services & Fees (check box, add fee)	\$0.00		
<input type="checkbox"/> Return Receipt (hardcopy)	\$0.00	08/30/2018	
<input type="checkbox"/> Return Receipt (electronic)	\$0.00		
<input type="checkbox"/> Certified Mail Restricted Delivery	\$0.00		
<input type="checkbox"/> Adult Signature Required	\$0.00		
<input type="checkbox"/> Adult Signature Restricted Delivery	\$0.00		
Postage	\$0.50		
Total Postage and Fees	\$3.95		

Sent To: **Kristina: Summit County Fiscal Officer Scalfes**
 Street and Apt. No., or P.O. Box: **175 South Main Street**
 City, State, ZIP+4®: **Akron, Ohio (44308-1354)**

①

APACHE JUNCTION
 151 W SUPERSTITION BLVD
 APACHE JUNCTION
 AZ
 85120-9998
 0302590130
 (800)275-8777 9:09 AM

Product Description	Sale Qty	Final Price
First-Class Mail Letter	1	\$0.50
(Domestic) (AKRON, OH 44308) (Weight: 0 Lb 0.40 Oz) (Estimated Delivery Date) (Tuesday 09/04/2018)		
Certified	1	\$3.45
(USPS Certified Mail #) (7018036000059693878)		
Affixed Postage	1	(\$0.50)
(Affixed Amount: \$0.50)		
First-Class Mail Letter	1	\$0.50
(Domestic) (AKRON, OH 44308) (Weight: 0 Lb 0.30 Oz) (Estimated Delivery Date) (Tuesday 09/04/2018)		
Certified	1	\$3.45
(USPS Certified Mail #) (7018036000059693861)		
Affixed Postage	1	(\$0.50)
(Affixed Amount: \$0.50)		
Total		\$6.90
Cash		\$20.00
Change		(\$13.10)

Text your tracking number to 28777 (2USPS) to get the latest status. Standard Message and Data rates may



Unofficial
 968

USPS Tracking®

FAQs > (<https://www.usps.com/faqs/uspstracking-faqs.htm>)

Track Another Package +

Tracking Number: 70180360000059693861

Remove X

Your item was delivered to the front desk, reception area, or mail room at 12:46 pm on September 4, 2018 in AKRON, OH 44308.

Delivered

September 4, 2018 at 12:46 pm
Delivered, Front Desk/Reception/Mail Room
AKRON, OH 44308

Tracking History

September 4, 2018, 12:46 pm
Delivered, Front Desk/Reception/Mail Room
AKRON, OH 44308

Your item was delivered to the front desk, reception area, or mail room at 12:46 pm on September 4, 2018 in AKRON, OH 44308.

September 4, 2018, 9:12 am
Arrived at Unit
AKRON, OH 44302

September 3, 2018
In Transit to Next Facility

September 1, 2018, 8:36 pm
Departed USPS Regional Facility
CLEVELAND OH DISTRIBUTION CENTER

2022-011769 MISC Page: 961 of 2782
09/26/2022 03:35:37 PM Receipt #: 22-9381
Rec Fee: \$30.00 Darrell James Hill
Gila County, Az, Sadie Jo Bingham, Recorder



959

Darrell-James: Hill c/o PO Box 3806, Apache Junction, Arizona 85117

Katie: Executive Assistant I Mancino
c/o 175 South Main Street
Akron, Ohio 44308

Katie, Greetings,

i:man: beneficiary of the inherent rights and public- trust known by the idem sonans subrogation DARRELL JAMES HILL am :Darrell- James: Hill © ® 1958, subrogee and Authorized Representative, "A.R." i: and my wife :Beverly- Jean: Romero- Hill © ® 1958 are inhabitants on the Arizona state around and about the Apache Junction areas.

According to the records, documents a) and b) (indicated below) to you were received from a third party. This short questionnaire is only for to help ascertain that you have received the prescribed document(s).

Question:	Answer	Other: What did you receive?
a) Did you receive: Certificate of Protest, addressed to: <u>Katie</u> : ~ USPS CMN 7015 1730 0002 3063 9270	Y	
a) Did you receive: Certificate of Dishonor, addressed to: <u>Katie</u> : ~ USPS RMN RB 898 809 975 US	Y	

- Instructions:
- i. *If you have received the documents as described then you need not answer.*
 - ii. *Please complete the appropriate answer or answer Other.*
 - iii. *Return the completed questionnaire within 14 days time after this USPS receipt.*
 - iv. *If you do not answer then thereby you concede receipt of the prescribed documentation.*

If you have Not received the prescribed document(s) then please promptly assure return of this clarification within 14 days from the date of this USPS CMN 7018 0360 0000 5969 3878 receipt.

Thank you

Without prejudice
DARRELL JAMES HILL

Darrell James Hill
:Darrell- James: Hill

Autographed this 29th day: August month: 2018

2022-011769 MISC Page: 962 of 2782
09/26/2022 03:35:37 PM Receipt #: 22-9981
Rec Fee: \$30.00 Darrell James Hill
Gila County, Az, Sadie Jo Bingham, Recorder

8 0360 0000 5969 3878



U.S. Postal Service[®]
CERTIFIED MAIL[®] RECEIPT
Domestic Mail Only

For delivery information, visit our website at www.usps.com

AKRON, OH 44308
OFFICIAL USE

Certified Mail Fee \$3.45
 Extra Services & Fees (check box, add fee)
 Return Receipt (hardcopy) \$0.00
 Return Receipt (electronic) \$0.00
 Certified Mail Restricted Delivery \$0.00
 Adult Signature Required \$0.00
 Adult Signature Restricted Delivery \$0.00

0130
 77

Postmark
 Here

Postage \$0.50
 Total Postage and Fees \$3.95

08/30/2018

Sent To: **Katie Executive Assistant / Manager**
 Street and Apt. No., or: **175 South Main Street**
 City, State, ZIP+4[®]: **Akron, Ohio (44308-1354)**

U.S. Postal Service[®]
CERTIFIED MAIL[®] RECEIPT
Domestic Mail Only

For delivery information, visit our website at www.usps.com

AKRON, OH 44308
OFFICIAL USE

Certified Mail Fee \$3.45
 Extra Services & Fees (check box, add fee)
 Return Receipt (hardcopy) \$0.00
 Return Receipt (electronic) \$0.00
 Certified Mail Restricted Delivery \$0.00
 Adult Signature Required \$0.00
 Adult Signature Restricted Delivery \$0.00

0130
 77

Postmark
 Here

Postage \$0.50
 Total Postage and Fees \$3.95

08/30/2018

Sent To: **Kristen Sangrik County Fiscal Officer Scalfie**
 Street and Apt. No., or: **175 South Main Street**
 City, State, ZIP+4[®]: **Akron, Ohio (44308-1354)**

①

APACHE JUNCTION
 151 W SUPERSTITION BLVD
 APACHE JUNCTION
 AZ

85120-9998
 0302590130

08/30/2018 (800)275-8777 9:09 AM

Product Description	Sale Qty	Final Price
---------------------	----------	-------------

First-Class Mail Letter (Domestic) (AKRON, OH 44308) (Weight: 0 Lb 0.40 Oz) (Estimated Delivery Date) (Tuesday 09/04/2018)	1	\$0.50
Certified (USPS Certified Mail #) (7018036000059693878)	1	\$3.45
Affixed Postage (Affixed Amount: \$0.50)	1	(\$0.50)
First-Class Mail Letter (Domestic) (AKRON, OH 44308) (Weight: 0 Lb 0.30 Oz) (Estimated Delivery Date) (Tuesday 09/04/2018)	1	\$0.50
Certified (USPS Certified Mail #) (7018036000059693861)	1	\$3.45
Affixed Postage (Affixed Amount: \$0.50)	1	(\$0.50)

Total \$5.90

Cash \$20.00
 Change (\$13.10)

Text your tracking number to 28777 (2USPS) to get the latest status. Standard Message and Data rates may

7018 0360 0000 5969 3878

7018 0360 0000 5969 3861

Unofficial

961



USPS Tracking®

FAQs > (<https://www.usps.com/faqs/uspstracking-faqs.htm>)

Track Another Package +

Tracking Number: 70180360000059693878

Remove X

Your item was delivered to the front desk, reception area, or mail room at 12:53 pm on September 4, 2018 in AKRON, OH 44308.

✓ Delivered

September 4, 2018 at 12:53 pm
Delivered, Front Desk/Reception/Mail Room
AKRON, OH 44308

Tracking History

September 4, 2018, 12:53 pm
Delivered, Front Desk/Reception/Mail Room
AKRON, OH 44308

Your item was delivered to the front desk, reception area, or mail room at 12:53 pm on September 4, 2018 in AKRON, OH 44308.

September 4, 2018, 9:12 am
Arrived at Unit
AKRON, OH 44302

September 3, 2018
In Transit to Next Facility

September 1, 2018, 8:36 pm
Departed USPS Regional Facility
CLEVELAND OH DISTRIBUTION CENTER

2022-011769 MISC Page: 964 of 2782
09/26/2022 03:35:37 PM Receipt #: 22-9381
Rec Fee: \$30.00 Darrell James Hill
Gila County, Az. Sadie Jo Bingham, Recorder



8/29/19, 8:30 PM

:Darrell-James: Hill and Beverly- Jean: Romero- Hill c/o PO Box 3806, Apache Junction, Ariz. 85117

Mark: Pinal County Arizona Sheriff Lamb
c/o Pinal County Sheriff's Office
971 Jason Lopez Circle, Building C
Florence, Ariz 85132
800-420-8689

USPS CMN 7017 1000 0000 9343 0728

Mark: Arizona Attorney General Brnovich
Office of the Attorney General
Phoenix Office
2005 N Central Ave
Phoenix, Ariz. 85004- 2926

First class mail

Michele: Arizona Secretary of State Reagan
c/o Office of the Secretary of State
1700 W Washington St Fl 7
Phoenix Ariz. 85007- 2808

First class mail

John: Chairman, President and CEO Stumpf
Wells Fargo and Company
420 Montgomery St.
San Francisco, Calif. 94163
(866) 878-5865

USPS CMN 7017 1000 0000 9343 0735

Lawrence: Bank Manager Lee
Wells Fargo Mac S4049-011
2891 West Apache Trail
Apache Junction, Arizona 85120

First class mail or hand delivered

Mark: Sheriff, Mark, Michele, John, Lawrence, Greetings,

i:man: beneficiary of the inherent rights and public- trust known by the idem sonans subrogation BEVERLY JEAN ROMERO- HILL am :Beverly-Jean: Romero- Hill © ® 1958, subrogee and Authorized Representative. i and my husband :Darrell- James: Hill © ® 1958 are inhabitants on the Arizona state around and about the Apache Junction. And,

In accordance with out best effort to be complete in the statements attached – See our Affidavits: Claim of Wrong-doing by Aaron Jacob: Service manager, Assistant Vice President Jaime.... - annexed: 8 pages, – we in good faith efforts failed to find resolve with a Wells Fargo manager denying an Arizona Secretary of State notary officer from performing in accordance with the Arizona state law simply as he wanted to do so, and in despite of the effort and presentment of the Arizona law the manager ignored Arizona laws. It seemed the notary was also afraid of losing her position/ job security.

Essentially, this manager is the authority for to determine employee notaries' compliance with Arizona state law. Is this a Wells Fargo policy? Is this a special agreement with the Wells Fargo and Company and the Arizona government? Or, is this some independent, private people discrimination? I wish not to be disrespected, harassed or threatened by this man again.

We will speak out. But how many do not?

I (We) say now and will affirm same in the court.

Without prejudice
DARRELL JAMES HILL

Autographed this 29th day: August month: 2018

:Darrell- James: Hill, A.R.

Without prejudice
BEVERLY JEAN ROMERO- HILL

Autographed this 29th day: August month: 2018

:Beverly- Jean: Romero- Hill, A.R.

7017 1000 0000 9343 0728

7017 1000 0000 9343 0735



**AFFIDAVIT: CLAIM OF WRONG-DOING by
Aaron Jacob: Service Manager, Assistant Vice President Jaime:
Apac Trail & Meridian Branch, Mac S4049-011 – Meeting 1/2
(aaron.j.jaime@wellsfargo.com)**

**State of Arizona
County of Pinal**

Beverly- Jean: Romero- Hill personally presented before me, the undersigned Notary duly authorized by the laws of Arizona to administer oaths; now on this 29th day: August month: 2018, being by me first duly sworn on his affirmation, affiant deposes and says:

i:man: beneficiary of the inherent rights and public- trust known by the idem sonans subrogation BEVERLY JEAN ROMERO am :Beverly-Jean: Romero- Hill © ® 1958, subrogee and Authorized Representative, "A.R." i: and my husband :Darrell- James: Hill © ® 1958 are inhabitants on the Arizona state around and about the Apache Junction.

i maintain a Wells Fargo Bank account, and commonly seek Arizona state notary services at the Wells Fargo Bank mentioned. We are in good faith appreciative for the Arizona state notary services.

On the 20th: August: 2018: We, Darrell, grand-baby and i, at the Wells Fargo location indicated above: address: 2891 W. Apache Trail, Apache Junction, Ariz. 85120, were denied notary services by the man: Aaron Jacob: Service Manager, Assistant Vice President Jaime, by his denial of the authorization for the Wells Fargo employee, an Arizona Secretary of State notary Heather Wood, to follow state law; as such:

1. Notary Heather Wood, Comm: expires: 01-04-21, became available to notarize.
2. We requested Copy Certification and presented our documents: 1- Arizona Driver License: BEVERLY JEAN ROMERO- HILL and 1- New Mexico Certificate Of Live Birth: BEVERLY JEAN ROMERO.
3. Heather said she did not know how, had never before completed a Copy Certification, and needed to go ask about it.
4. Heather: notary returned to the office cubicle with a man who identified himself as: Aaron: Vice President. He later provided his Wells Fargo business card.
5. Aaron: Service Manager came with two booklets marked from a NNA(?) organization, pamphlets regarding notary actions from which he read. Aaron: Service Manager claimed that he was not a notary, had not been to the class in a long time, and had not since been a notary for many years.
6. After a couple minutes Aaron: Service Manager said to Darrell and i that according to his booklets that he would not authorize (Heather: notary) to Copy Certify our documents.
7. Darrell and i did not agree; Darrell- James then said that according to the Secretary of State; – he'd been to the class, – our documents can be rightfully copy certified; progressively commenting that: 1) the documents needed to be sent out of state, 2) it is extremely expensive for us to send original documentation to each out of state recipients, 3) sending original would be impractical, and 4) asked to read whatever was being relied upon to deny the Copy Certification.
8. Darrell read the booklet references, and indicated that: a) the booklets are very general; and: b) the booklets are not law: Arizona.
9. Aaron: Service Manager then instructed Heather: notary to call the NNA(?), which she did, 2-3 times as the clarification for the lawful reason for the denial continued;
10. At this point, Aaron: Service Manager began raising his voice, being insistent that he was somehow correct, determining that he was going to follow the NNA(?).
11. Aaron: Service Manager then sat at Heather: notary's computer, printed and presented to Darrell and i the Secretary of State: Arizona, Notary Manual: p. 28. – Thereon: 3. Copy Certification A.R.S. § 41-

- 311(3).... See page 29.... Examples ... are:
12. Darrell-James read p. 28 and asked Aaron:Service Manager to print the next page 29. regarding the Arizona Notary Manual direction, but Aaron:Service Manager said no, saying that we've already taken too much time, are not going to do anything else; are not going to print to clarify any more, and that other people are waiting
 13. Darrell then asked Heather:notary to print the necessary information, to which Aaron:Service Manager replied, "What don't you understand, we're not going to do anything else."
 14. Darrell pointed-out to Aaron:Service Manager and Heather:notary that the page 28 is not Arizona law, that the manual only made examples, that there is something wrong, and again asked for the ARS sections to clarify. Clarification by/ with the Arizona law was denied.
 15. Aaron:Service Manager speaking loudly exclaimed, If it's not law then why would the Secretary of State write it in the manual?!
 16. Aaron:Service Manager then instructed Heather:notary to call to the Secretary of State Arizona Notary Help Line (?), etc., which she did. We did not hear the conversation, but discerned that Heather was directed to the A.R.S. § 41-311, which she wrote down. She found out that she was able to copy certify Arizona Driver License, and answered no more questions regarding information she received.
 17. Darrell offered to go home (~ 6 miles), do the research, and return with the findings in order to obtain the notary service requested and required.
 18. Aaron:Service Manager replied, 'You can go and do all the research you want to do at home, we are still going to follow the booklet.'
 19. Darrell then asserted: the offer is for our willingness to do the research and return with the findings either way in good faith. And, Aaron:Service Manager agreed to meet. Then,
 20. Aaron:Service Manager walked away, permanently.
 21. Aaron:Service Manager now absent, Darrell and i apologized to Heather for this level of difficulty with the Copy Certification, in that we had not a clue this would happen, and that it would take so much time ~ 2 hours.
 22. Darrell-James affirmed to Heather that she could Copy Certify both documents according to Arizona law. And,
 23. Heather:notary responded with in a low quiet expression that: I will do whatever Wells Fargo's policy says, said as if lawful notary compliance would mean the threat to the position/ job security.
 24. Heather then stated: I'll probably get in trouble but I am going to Copy Certify the Arizona Driver License because you've been here so long; commenting: But, I don't think I'll do this again.
 25. Lastly, with the Copy Certification: ADL: BEVERLY JEAN ROMERO- HILL completed; and, with the New Mexico Certificate of Live Birth Not completed, we went to do our research in hopes of obtaining notary Copy Certification consistent with the foundational original affidavit (**AFFIDAVIT: PROOF OF LIFE TO SUPPORT PAYMENT**) already notarized by Heather:notary referring to a New Mex. Certificate of Live Birth Copy Certification.

Autographed: 29th day: August month: 2018

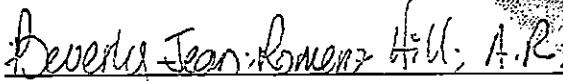
Without prejudice
BEVERLY JEAN ROMERO- HILL

Beverly-Jean: Romero- Hill, A.R.

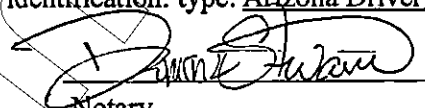
Sworn to and subscribed before me now on this 29th day: August month: 2018.
Produced identification: type: Arizona Driver License.

9/65

Notary

Seal

Dominic Stewart
Notary Public
Maricopa County, Arizona
My Comm. Exp. 08-25-2020

AFFIDAVIT: CLAIM OF WRONG-DOING by
Aaron Jacob:Service Manager, Assistant Vice President Jaime:
Apac Trail & Meridian Branch, Mac S4049-011 – Meeting 1/2
(aaron.j.jaime@wellsfargo.com)

State of Arizona
County of Pinal

Darrell- James: Hill personally presented before me, the undersigned Notary duly authorized by the laws of Arizona to administer oaths; now on this 29th day: August month: 2018, being by me first duly sworn on his affirmation, affiant deposes and says:

i:man: beneficiary of the inherent rights and public- trust known by the idem/sonans subrogation DARRELL JAMES HILL am :Darrell- James: Hill © ® 1958, subrogee and Authorized Representative, "A.R." i: and my wife :Beverly- Jean: Romero- Hill © ® 1958 are inhabitants on the Arizona state around and about the Apache Junction.

Beverly- Jean and i maintain a Wells Fargo Bank accounts, and commonly seek Arizona state notary services at the Wells Fargo Bank mentioned. We are in good faith appreciative for the Arizona state notary services.

On the 20th: August: 2018: We, Beverly, grand-baby and i, at the Wells Fargo location indicated above: address: 2891 W. Apache Trail, Apache Junction, Ariz. 85120, were denied notary services by the man: Aaron Jacob: Service Manager, Assistant Vice President Jaime, by his denial of the authorization for the Wells Fargo employee, an Arizona Secretary of State notary Heather Wood, to follow state law; as such:

1. Notary Heather Wood, Comm: expires: 01-04-21, became available to notarize.
2. We requested Copy Certification and presented our documents: 1- Arizona Driver License: BEVERLY JEAN ROMERO- HILL and 1- New Mexico Certificate Of Live-Birth: BEVERLY JEAN ROMERO.
3. Heather:notary said she did not know how, had never before completed a Copy Certification, and needed to go ask about it.
4. Heather:notary returned to the office cubicle with a man who identified himself as: Aaron:Vice President. He later provided his Wells Fargo business card.
5. Aaron came with two booklets marked from a NNA(?) organization, pamphlets regarding notary actions from which he read. Aaron:Service Manager claimed that he was not a notary, had not been to the class in a long time, and had not since been a notary for many years.
6. After a couple minutes Aaron:Service Manager said to Beverly- Jean and i that according to his booklets that he would not authorize (Heather:notary) to Copy Certify our documents.
7. Beverly- Jean and i did not agree: i then said that according to the Secretary of State; – i went to the class, – our documents can be rightfully copy certified; progressively commenting that: 1) the documents needed to be sent out of state, 2) it is extremely expensive for us to send original documentation to each out of state recipients, 3) sending original would be impractical, and 4) asked to read whatever was being relied upon to deny the Copy Certification.
8. i read the booklet references, and indicated that: a) the booklets are very general; and: b) the booklets are not law: Arizona.
9. Aaron:Service Manager then instructed Heather:notary to call the NNA(?), which she did, 2-3 times as the clarification for the lawful reason for the denial continued;
10. At this point, Aaron:Service Manager began raising his voice, being insistent that he was somehow correct, determining that he was going to follow the NNA(?).
11. Aaron:Service Manager then sat at Heather:notary's computer, printed and presented to Beverly and i the Secretary of State: Arizona, Notary Manual: p. 28. – Thereon: 3. Copy Certification A.R.S. § 41-

9/6/6
2022-011769 MISC Page: 968 of 2782
09/26/2022 03:35:37 PM Receipt #: 22-9381
Rec Fee: \$30.00 Darrell James Hill
Gila County, Az, Sadie Jo Bingham, Recorder

;-DOING by Aaron Jacob: Service Manager – Meeting 1/2 1/2



- 311(3).... See page 29.... Examples ... are:
12. i:man read p. 28 and asked Aaron:Service Manager to print the next page 29. regarding the Arizona Notary Manual directions, but Aaron:Service Manager said no, saying, we've already taken too much time, are not going to do anything else; are not going to print to clarify any more, and that other people are waiting
 13. i:man then asked Heather:notary to print the necessary information, to which Aaron:Service Manager replied, "What don't you understand; we're not going to do anything else."
 14. i pointed-out to Aaron:Service Manager and Heather:notary that the page 28 is not Arizona law, that the manual only made examples, that there is something wrong, and again asked for the ARS sections to clarify Aaron:Service Manager's determination. Clarification by/ with the Arizona law was denied.
 15. Aaron:Service Manager speaking loudly exclaimed, If it's not law then why would the Secretary of State write it in the manual?!
 16. Aaron:Service Manager then instructed Heather:notary to call to the Secretary of State Arizona Notary Help Line (?), etc., which she did. We did not hear the conversation, but discerned that Heather was directed to the A.R.S. § 41-311, which she wrote down. She found out that she was able to copy certify Arizona Driver License, and she answered no more questions regarding information she received.
 17. i:man offered to go home (~ 6 miles), do the research, and return with the findings in order to obtain the notary service requested and required.
 18. Aaron:Service Manager replied, 'You can go and do all the research you want to do at home, we are still going to follow the booklet.'
 19. i:man then asserted: the offer is for our willingness to do the research and return with the findings either way in good faith. And, Aaron:Service Manager agreed to meet. Then,
 20. Aaron:Service Manager walked away, permanently.
 21. Aaron:Service Manager now absent, Beverly and i apologized to Heather for this level of difficulty with the Copy Certification, in that we had not a clue this would happen, and that it would take so much time ~ 2 hours.
 22. i:man affirmed to Heather that she could Copy Certify both documents according to Arizona law. And,
 23. Heather:notary responded with in a low quiet expression that: I will do whatever Wells Fargo's policy says, said as if disagreement with Aaron would mean a threat to her position/ job security.
 24. Heather then stated: I'll probably get in trouble but I am going to Copy Certify the Arizona Driver License because you've been here so long; commenting: But, I don't think I'll do this again.
 25. Lastly, with the Copy Certification: ADL; BEVERLY JEAN ROMERO- HILL completed; and, with the New Mexico Certificate of Live Birth Not completed, we went to do our research in hopes of obtaining notary Copy Certification consistent with the foundational original affidavit (**AFFIDAVIT: PROOF OF LIFE TO SUPPORT PAYMENT**) already notarized by Heather:notary referring to a New Mex. Certificate of Life Birth Copy Certification.

Without prejudice
 DARRELL JAMES HILL

Darrell James Hill, AR
 Darrell- James: Hill, A.R.

Autographed: 29th day: August month: 2018

Sworn to and subscribed before me now on this 29th day: August month: 2018.
 Produced identification: type: Arizona Driver License.

Dominic Stewart
 Notary

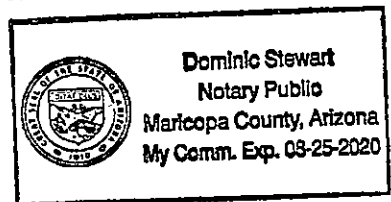

Seal



**U.S. Postal Service™
CERTIFIED MAIL® RECEIPT**
Domestic Mail Only

For delivery information, visit our website at www.usps.com

OFFICIAL USE

Certified Mail Fee	\$3.45	0130
Postage	\$0.71	77
Total Postage and Fees	\$4.16	08/30/2018
Postmark Here		
Sent To: John Chairman, President and CEO Stamp Wells Fargo and Company 420 Montgomery St. San Francisco, Calif. 94163 (866) 878-5263		

**U.S. Postal Service™
CERTIFIED MAIL® RECEIPT**
Domestic Mail Only

For delivery information, visit our website at www.usps.com

OFFICIAL USE

Certified Mail Fee	\$3.45	0130
Postage	\$0.71	77
Total Postage and Fees	\$4.16	08/30/2018
Postmark Here		
Sent To: John Chairman, President and CEO Stamp Wells Fargo and Company 420 Montgomery St. San Francisco, Calif. 94163 (866) 878-5263		

4

APACHE JUNCTION
151 W SUPERSTITION BLVD
APACHE JUNCTION
AZ

85120-9998
0302590130
08/30/2018 (800)275-8777 9:17 AM

Product Description	Sale Qty	Final Price
Uncle Sams Hat (Unit Price:\$0.21)	3	\$0.63
First-Class Mail Letter (Domestic) (FLORENCE, AZ 85132) (Weight:0 Lb 1.80 Oz) (Estimated Delivery Date) (Saturday 09/01/2018)	1	\$0.71
Certified (@USPS Certified Mail #) (70171000000093430728)	1	\$3.45
Affixed Postage (Affixed Amount:\$0.50)	1	(\$0.50)
First-Class Mail Letter (Domestic) (SAN FRANCISCO, CA 94163) (Weight:0 Lb 1.70 Oz) (Estimated Delivery Date) (Tuesday 09/04/2018)	1	\$0.71
Certified (@USPS Certified Mail #) (70171000000093430735)	1	\$3.45
Affixed Postage (Affixed Amount:\$0.50)	1	(\$0.50)
Total		\$7.95
Cash		\$20.00
Change		(\$12.05)

Text your tracking number to 28777 (2USPS) to get the latest status.

7017 1000 0000 9343 0728

5320 4369 0000 0000 0000

9/68



Darrell-James: Hill c/o PO Box 3806, Apache Junction

Ranier: Chief Judge Collins
DeConcini U.S. Courthouse
405 West Congress Street, Suite 5190
Tucson, Arizona 85701

Ranier, Greetings,

I am: beneficiary of the inherent rights and public- trust known by the idem sonans subrogation DARRELL JAMES HILL, am :Darrell- James: Hill © ® 1958, subrogee and Authorized Representative, "A.R." I and my wife :Beverly- Jean: Romero- Hill © ® 1958 are inhabitants on the Arizona state around and about the Apache Junction areas.

According to the records, documents a) and b) (indicated below) to you were received from a third party. This short questionnaire is only for to help ascertain that you have received the prescribed document(s).

Question:	Answer	Other: What did you receive?
a) Did you receive: Certificate of Protest, addressed to: <u>Ranier:</u> ~ USPS CMN 7015 1730 0002 3063 9263	Y	
a) Did you receive: Certificate of Dishonor, addressed to: Ranier: ~ USPS RMN RE 047 636 435 US	Y	

- Instructions:
- i. If you have received the documents as described then you need not answer.
 - ii. Please complete the appropriate answer or answer Other.
 - iii. Return the completed questionnaire within 14 days time after this USPS receipt.
 - iv. If you do not answer then thereby you concede receipt of the prescribed documentation.

If you have Not received the prescribed document(s) then please promptly assure return of this clarification within 14 days from the date of this USPS CMN 7018 0360 0000 5969 3847 receipt.

Thank you

Without prejudice
DARRELL JAMES HILL

Darrell James Hill
:Darrell- James: Hill, A.R.

Autographed this 29th day: August month: 2018

969

7018 0360 0000 5969 3847

49E 6965 0000 0960 9702

U.S. Postal Service™
CERTIFIED MAIL® RECEIPT
Domestic Mail Only

For delivery information, visit our website at www.usps.com®.

TUCSON, AZ 85701
OFFICIAL USE

Certified Mail Fee	\$3.45
Extra Services & Fees (check box, add fee as appropriate)	\$0.00
<input type="checkbox"/> Return Receipt (hardcopy)	\$0.00
<input type="checkbox"/> Return Receipt (electronic)	\$0.00
<input type="checkbox"/> Certified Mail Restricted Delivery	\$0.00
<input type="checkbox"/> Adult Signature Required	\$0.00
<input type="checkbox"/> Adult Signature Restricted Delivery	\$0.00
Postage	\$0.50
Total Postage and Fees	\$3.95

0130
77
Postmark
Here
08/30/2018

Sent To
Street and Apt. No., or PO Box: Ranier, Chief Judge Collins, Evo A. DeCocini U.S. Courthouse, 405 West Congress Street, Suite 5190
City, State, ZIP+4®: Tucson, Arizona [85701]

PS Form 3800, April 2015 PSN 7530-02-000-9047 See Reverse for Instructions

2

APACHE JUNCTION
151 W SUPERSTITION BLVD
APACHE JUNCTION
AZ
85120-9998
0302590130
08/30/2018 (800)275-8777 9:11 AM

Product Description Sale Qty Final Price

First-Class Mail Letter (Domestic) (TUCSON, AZ 85701) (Weight: 0 Lb 0.40 Oz) (Estimated Delivery Date) (Saturday 09/01/2018)	1	\$0.50
Certified (@USPS Certified Mail #) (70180360000059693847)	1	\$3.45
Affixed Postage (Affixed Amount:\$0.50)	1	(\$0.50)
First-Class Mail Letter (Domestic) (PHOENIX, AZ 85003) (Weight: 0 Lb 0.40 Oz) (Estimated Delivery Date) (Saturday 09/01/2018)	1	\$0.50
Certified (@USPS Certified Mail #) (70180360000059693854)	1	\$3.45
Affixed Postage (Affixed Amount:\$0.50)	1	(\$0.50)

Total \$6.90
Cash \$7.00
Change (\$0.10)

Text your tracking number to 28777 (2USPS) to get the latest status. Standard Message and Data rates may

49E 6965 0000 0960 9702

U.S. Postal Service™
CERTIFIED MAIL® RECEIPT
Domestic Mail Only

For delivery information, visit our website at www.usps.com®.

PHOENIX, AZ 85003
OFFICIAL USE

Certified Mail Fee	\$3.45
Extra Services & Fees (check box, add fee as appropriate)	\$0.00
<input type="checkbox"/> Return Receipt (hardcopy)	\$0.00
<input type="checkbox"/> Return Receipt (electronic)	\$0.00
<input type="checkbox"/> Certified Mail Restricted Delivery	\$0.00
<input type="checkbox"/> Adult Signature Required	\$0.00
<input type="checkbox"/> Adult Signature Restricted Delivery	\$0.00
Postage	\$0.50
Total Postage and Fees	\$3.95

0130
77
Postmark
Here
08/30/2018

Sent To
Street and Apt. No., or PO Box: Brian, Clerk of Court Karth, et al, Sandra Day O'Connor U.S. Courthouse, Suite 139, 401 West Washington Street, SPC 1
City, State, ZIP+4®: Phoenix Arizona [85003-2118]

PS Form 3800, April 2015 PSN 7530-02-000-9047 See Reverse for Instructions

Unofficial

970

2022-011769 MISC Page: 972 of 2782

09/26/2022 03:35:37 PM Receipt #: 22-9381
Rec Fee: \$30.00 Darrell James Hill
Gila County, Az, Sadie Jo Bingham, Recorder



Darrell-James: Hill c/o PO Box 3806, Apache Junction, Arizona 85117

Brian: Clerk of Court Karth
Sandra Day O'Connor U.S. Courthouse, Suite 130
401 West Washington Street, SPC1
Phoenix, Arizona 85003-2118

Brian, Greetings,

I am beneficiary of the inherent rights and public-trust known by the idem sonans subrogation DARRELL JAMES HILL am :Darrell- James: Hill © ® 1958, subrogee and Authorized Representative, "A.R." i: and my wife :Beverly- Jean: Romero- Hill © ® 1958 are inhabitants on the Arizona state around and about the Apache Junction areas.

According to the records, documents a) and b) (indicated below) to you were received from a third party. This short questionnaire is only for to help ascertain that you have received the prescribed document(s).

Question:	Answer	Other: What did you receive?
a) Did you receive: Certificate of Protest , addressed to: <u>Brian</u> : ~ USPS CMN 7015 1730 0002 6063 9256	Y	_____ _____ _____
a) Did you receive: Certificate of Dishonor , addressed to: <u>Brian</u> : ~ USPS RMN RE 898 809 940 US	Y	_____ _____ _____

- Instructions:**
- i. *If you have received the documents as described then you need not answer.*
 - ii. *Please complete the appropriate answer or answer Other.*
 - iii. *Return the completed questionnaire within 14 days time after this USPS receipt.*
 - iv. *If you do not answer then thereby you concede receipt of the prescribed documentation.*

If you have Not received the prescribed document(s) then please promptly assure return of this clarification within 14 days from the date of this USPS CMN 7018 0360 0000 5969 3854 receipt.

Thank you

Without prejudice
DARRELL JAMES HILL

:Darrell-James: Hill
:Darrell- James: Hill, A.R.

Autographed this 29th day: August month: 2018

977

2022-011769 MISC Page: 973 of 2782

09/26/2022 03:35:37 PM Receipt #: 22-9381

Rec Fee: \$30.00 Darrell James Hill

Gila County, Az, Sadie Jo Bingham, Recorder

7018 0360 0000



U.S. Postal Service™
CERTIFIED MAIL® RECEIPT
 Domestic Mail Only

For delivery information, visit our website at www.usps.com®.

OFFICIAL USE

Certified Mail Fee \$3.45
 Extra Services & Fees (check box, add fee as appropriate)
 Return Receipt (hardcopy) \$0.00
 Return Receipt (electronic) \$0.00
 Certified Mail Restricted Delivery \$0.00
 Adult Signature Required \$0.00
 Adult Signature Restricted Delivery \$0.00

0130
77

Postmark
Here

Postage \$0.50

08/30/2018

Total Postage and Fees \$3.95

Sent To

Street and Apt. No., or PO Box: Ranier, Chief Judge Collins,
 Evo A. DeConcini U.S. Courthouse
 City, State, ZIP+4®: 405 West Congress Street, Suite 5190
 Tucson, Arizona 85701

PS Form 3800, April 2015 PSN 7530-02-000-9047 See Reverse for Instructions

7018 0360 0000 5965 3847

U.S. Postal Service™
CERTIFIED MAIL® RECEIPT
 Domestic Mail Only

For delivery information, visit our website at www.usps.com®.

OFFICIAL USE

Certified Mail Fee \$3.45
 Extra Services & Fees (check box, add fee as appropriate)
 Return Receipt (hardcopy) \$0.00
 Return Receipt (electronic) \$0.00
 Certified Mail Restricted Delivery \$0.00
 Adult Signature Required \$0.00
 Adult Signature Restricted Delivery \$0.00

0130
77

Postmark
Here

Postage \$0.50

08/30/2018

Total Postage and Fees \$3.95

Sent To

Street and Apt. No.: Brian, Clerk of Court Karth, et al.
 Sandra Day O'Connor U.S. Courthouse, Suite 130
 City, State, ZIP+4®: 401 West Washington Street, SPC 1
 Phoenix Arizona 85003-2118

PS Form 3800, April 2015 PSN 7530-02-000-9047 See Reverse for Instructions

459E 6965 0000 0960 9101

2

APACHE JUNCTION
 151 W SUPERSTITION BLVD
 APACHE JUNCTION
 AZ
 85120-9998
 0302590130
 (800)275-8777 9:11 AM

Product Description	Sale Qty	Final Price
---------------------	----------	-------------

First-Class Mail Letter	1	\$0.50
-------------------------	---	--------

(Domestic)
 (TUCSON, AZ 85701)
 (Weight: 0 Lb 0.40 Oz)
 (Estimated Delivery Date)
 (Saturday 09/01/2018)

Certified	1	\$3.45
-----------	---	--------

(@USPS Certified Mail #)
 (70180360000059693847)

Affixed Postage	1	(\$0.50)
-----------------	---	----------

First-Class Mail Letter	1	\$0.50
-------------------------	---	--------

(Domestic)
 (PHOENIX, AZ 85003)
 (Weight: 0 Lb 0.40 Oz)
 (Estimated Delivery Date)
 (Saturday 09/01/2018)

Certified	1	\$3.45
-----------	---	--------

(@USPS Certified Mail #)
 (70180360000059693854)

Affixed Postage	1	(\$0.50)
-----------------	---	----------

Total		\$6.90
-------	--	--------

Cash	\$7.00
Change	(\$0.10)

Text your tracking number to 28777
 (2USPS) to get the latest status.
 Standard Message and Data rates may

Unofficial

972

2022-011769 MISC Page: 974 of 2782

09/26/2022 03:35:37 PM Receipt #: 22-9381
 Rec Fee: \$30.00 Darrell James Hill
 Gila County, Az, Sadie Jo Bingham, Recorder





Customer Correspondence
MAC D1108-030
1525 West WT Harris Boulevard
Charlotte, NC 28262
wellsfargo.com

September 6, 2018

Darrell J. Hill
5124 E 18th Avenue
Apache Junction, AZ 85119

Dear Darrell J. Hill:

Thank you for writing with your important comments addressed to Wells Fargo Bank. Your feedback is very important to us, and we appreciate the opportunity to review your concerns.

Your concerns have been received by our Customer Correspondence Department. We are currently researching the items brought to our attention and will respond to you within ten business days with our findings.

In the meantime, if we can assist you in any way, please call *Wells Fargo Phone Bank*SM at 1-800-TO-WELLS (1-800-869-3557). Phone bankers are available 24 hours a day, 7 days a week.

Thank you.

Sincerely,
Customer Correspondence

993

2022-011769 MISC Page: 975 of 2782
09/26/2022 03:35:37 PM Receipt #: 22-9381
Rec Fee: \$30.00 Darrell James Hill
Gila County, Az, Sadie Jo Bingham, Recorder



U.S. POSTAGE PITNEY BOWES

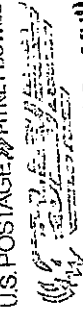

ZIP 28262 \$ 000.47
02.4N
0000335733 SEP 07 2018

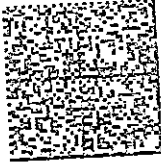

Wells Fargo Bank, N.A.
N9777-112CC
PO Box 5141
Sioux Falls, SD 57117-5141



Darrell J. Hill
5124 E 18th Avenue
Apache Junction, AZ 85119

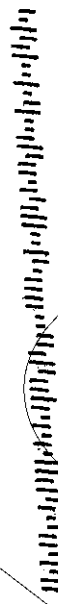

851199374 R016

974

2022-011769 MISC Page: 976 of 2782
09/26/2022 03:35:37 PM Receipt #: 22-9381
Rec Fee: \$30.00 Darrell James Hill
Gila County, Az, Sadie Jo Bingham, Recorder

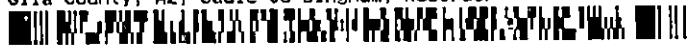

Unofficial Copy

Darrell-James: Hill c/o PO Box 3806, Apache Junction, Arizona 85117

Donald: POTUS Trump
c/o President of the United States
1600 Pennsylvania Ave NW
Washington, District of Columbia 20500

Donald, Greetings,

I am beneficiary of the inherent rights and public trust known by the idem sonans subrogation DARRELL JAMES HILL am Darrell- James: Hill © © 1958, subrogee and Authorized Representative, "A.R." I and my wife Beverly- Jean: Romero- Hill © © 1958 are inhabitants on the Arizona state around and about the Apache Junction areas.

According to the records, documents a) and b) (indicated below) to you were received from a third party. This short questionnaire is only for to help ascertain that you have received the prescribed document(s).

Question:	Answer	Other: What did you receive?
a) Did you receive: Certificate of Protest, addressed to: Donald: ~ USPS CMN 7017 1000 0000 9343 0698	Y	
a) Did you receive: Certificate of Dishonor, addressed to: Donald: ~ USPS RMN RE 047 636 418 US	Y	

- Instructions:
- i. If you have received the documents as described then you need not answer.
 - ii. Please complete the appropriate answer or answer Other.
 - iii. Return the completed questionnaire within 14 days time after this USPS receipt.
 - iv. If you do not answer then thereby you concede receipt of the prescribed documentation.

If you have Not received the prescribed document(s) then please promptly assure return of this clarification within 14 days from the date of this USPS CMN 7018 0360 0000 5969 3830 receipt.

Thank you

Without prejudice
DARRELL JAMES HILL

Autographed this 30th day: August month: 2018

Darrell James Hill
:Darrell- James: Hill, A.R.

7018 0360 0000 5969 3830

2022-011769 MISC Page: 977 of 2782
 09/26/2022 03:35:37 PM Receipt #: 22-9381
 Rec Fee: \$30.00 Darrell James Hill
 Gila County, Az, Sadie Jo Bingham, Recorder



975

**U.S. Postal Service™
CERTIFIED MAIL® RECEIPT**
Domestic Mail Only

For delivery information, visit our website at www.usps.com™.

WASHINGTON DC 20530
OFFICIAL USE

Certified Mail Fee	\$3.45
Extra Services & Fees (check box, add fee as appropriate)	\$0.00
<input type="checkbox"/> Return Receipt (hardcopy)	\$0.00
<input type="checkbox"/> Return Receipt (electronic)	\$0.00
<input type="checkbox"/> Certified Mail Restricted Delivery	\$0.00
<input type="checkbox"/> Adult Signature Required	\$0.00
<input type="checkbox"/> Adult Signature Restricted Delivery	\$0.00
Postage	\$0.50
Total Postage and Fees	\$3.95

0130
77
Postmark
Here
08/30/2018

Sent To
Street and Apt. No., or POE Jeff. U.S. Attorney General Sessions
c/o United States Attorney General
950 Pennsylvania Avenue, N.W.
City, State, ZIP+4® Washington, District of Columbia 20530

PS Form 3800, April 2015 PSN 7530-02-000-9-2-17 See Reverse for Instructions

3

APACHE JUNCTION
151 W SUPERSTITION BLVD
APACHE JUNCTION
AZ
85120-9998
0302590130
(800)275-8777 9:13 AM

Product Description Sale Qty Final Price

First-Class Mail Letter (Domestic) (WASHINGTON, DC 20530) (Weight: 0 Lb 0.40 Oz) (Estimated Delivery Date) (Tuesday 09/04/2018) Certified 1 \$3.45 (®USPS Certified Mail #) (70180360000059688935)	1	\$0.50
Affixed Postage (Affixed Amount: \$0.50)	1	(\$0.50)
First-Class Mail Letter (Domestic) (WASHINGTON, DC 20500) (Weight: 0 Lb 0.40 Oz) (Estimated Delivery Date) (Tuesday 09/04/2018) Certified 1 \$3.45 (®USPS Certified Mail #) (70180360000059693830)	1	\$0.50
Affixed Postage (Affixed Amount: \$0.50)	1	(\$0.50)

Total \$6.90
Cash \$7.00
Change (\$0.10)

Text your tracking number to 28777 (2USPS) to get the latest status. Standard Message and Data rates may

**U.S. Postal Service™
CERTIFIED MAIL® RECEIPT**
Domestic Mail Only

For delivery information, visit our website at www.usps.com™.

WASHINGTON DC 20500
OFFICIAL USE

Certified Mail Fee	\$3.45
Extra Services & Fees (check box, add fee as appropriate)	\$0.00
<input type="checkbox"/> Return Receipt (hardcopy)	\$0.00
<input type="checkbox"/> Return Receipt (electronic)	\$0.00
<input type="checkbox"/> Certified Mail Restricted Delivery	\$0.00
<input type="checkbox"/> Adult Signature Required	\$0.00
<input type="checkbox"/> Adult Signature Restricted Delivery	\$0.00
Postage	\$0.50
Total Postage and Fees	\$3.95

0130
77
Postmark
Here
08/30/2018

Sent To
Street and Apt. No., or POE Donald: POTUS Trump
c/o President of the United States
1600 Pennsylvania Ave NW
City, State, ZIP+4® Washington, District of Columbia, 20500

PS Form 3800, April 2015 PSN 7530-02-000-9-2-17 See Reverse for Instructions

701A 0360 0000 596A 3830

701A 0360 0000 596A 3830

Unofficial
976

09/26/2022 03:35:37 PM Receipt #: 22-9381
Rec Fee: \$30.00 Darrell James Hill
Gila County, Az, Sadie Jo Bingham, Recorder





FAQs > (<https://www.usps.com/faqs/uspstracking-faqs.htm>)

Track Another Package +

Tracking Number: 70180360000059693830

Remove X

Your item was delivered at 3:51 am on September 5, 2018 in WASHINGTON, DC 20500.

Delivered

September 5, 2018 at 3:51 am
Delivered
WASHINGTON, DC 20500

Tracking History

September 5, 2018, 3:51 am
Delivered
WASHINGTON, DC 20500
Your item was delivered at 3:51 am on September 5, 2018 in WASHINGTON, DC 20500.

September 4, 2018, 1:42 pm
Available for Pickup
WASHINGTON, DC 20500

September 4, 2018, 12:36 pm
Arrived at Unit
WASHINGTON, DC 20018

September 3, 2018
In Transit to Next Facility

977

2022-011769 MISC Page: 979 of 2782
09/26/2022 03:35:37 PM Receipt #: 22-9381
Rec Fee: \$30.00 Darrell James Hill
Gila County, Az, Sadie Jo Bingham, Recorder



Darrell-James: Hill c/o PO Box 3806, Apache Junction, Arizona 85117

Jeff: U.S. Attorney General Sessions
c/o United States Attorney General
950 Pennsylvania Ave NW
Washington, District of Columbia 20530

Jeff, Greetings,

i:man: beneficiary of the inherent rights and public- trust known by the idem sonans subrogation DARRELL JAMES HILL am :Darrell- James: Hill © ® 1958, subrogee and Authorized Representative, "A.R." i: and my wife :Beverly- Jean: Romero- Hill © ® 1958 are inhabitants on the Arizona state around and about the Apache Junction areas.

According to the records, documents a) and b) (indicated below) to you were received from a third party. This short questionnaire is only for to help ascertain that you have received the prescribed document(s).

Question:	Answer	Other: What did you receive?
a) Did you receive: Certificate of Protest, addressed to: Jeff: ~ USPS CMN 7017 1730 0002 3063 9324	Y	
a) Did you receive: Certificate of Dishonor, addressed to: Jeff: ~ USPS RMN RB 898 809 919 US	Y	

- Instructions:
- i. If you have received the documents as described then you need not answer.
 - ii. Please complete the appropriate answer or answer Other.
 - iii. Return the completed questionnaire within 14 days time after this USPS receipt.
 - iv. If you do not answer then thereby you concede receipt of the prescribed documentation.

If you have Not received the prescribed document(s) then please promptly assure return of this clarification within 14 days from the date of this USPS CMN 7018 0360 0000 5968 8935 receipt.

Thank you

Without prejudice
DARRELL JAMES HILL

Autographed this 30th day: August month: 2018

Darrell James Hill
:Darrell- James: Hill: A.R.

978

7018 0360 0000

2022-011769 MISC Page: 980 of 2782
 09/26/2022 03:35:37 PM Receipt #: 22-9381
 Rec Fee: \$30.00 Darrell James Hill
 Gila County, Az, Sadie Jo Bingham, Recorder



U.S. Postal Service™
CERTIFIED MAIL® RECEIPT
 Domestic Mail Only

For delivery information, visit our website at www.usps.com®.

WASHINGTON DC 20530

OFFICIAL USE

Certified Mail Fee	\$3.45
Extra Services & Fees (check box, add fee as appropriate)	\$0.00
<input type="checkbox"/> Return Receipt (hardcopy)	\$0.00
<input type="checkbox"/> Return Receipt (electronic)	\$0.00
<input type="checkbox"/> Certified Mail Restricted Delivery	\$0.00
<input type="checkbox"/> Adult Signature Required	\$0.00
<input type="checkbox"/> Adult Signature Restricted Delivery	\$0.00
Postage	\$0.50
Total Postage and Fees	\$3.95

0130
77

Postmark
Here

08/30/2018

Sent To

Street and Apt. No., or PO Box: Jeff U.S. Attorney General Sessions
 c/o United States Attorney General
 950 Pennsylvania Avenue, N.W.
 City, State, ZIP+4®: Washington, District of Columbia 20530

PS Form 3800, April 2015 PSN 7530-02-900-0247 See Reverse for Instructions

3

APACHE JUNCTION
 151 W SUPERSTITION BLVD
 APACHE JUNCTION
 AZ
 85120-9998
 0302590130
 (800)275-8777 9:13 AM

Product Description	Sale Qty	Final Price
---------------------	----------	-------------

First-Class Mail Letter	1	\$0.50
-------------------------	---	--------

(Domestic)
 (WASHINGTON, DC 20530)
 (Weight: 0 Lb 0.40 Oz)
 (Estimated Delivery Date)
 (Tuesday 09/04/2018)

Certified	1	\$3.45
(®USPS Certified Mail #)		
(7018036000059688935)		
Affixed Postage	1	(\$0.50)

First-Class Mail Letter	1	\$0.50
-------------------------	---	--------

(Domestic)
 (WASHINGTON, DC 20500)
 (Weight: 0 Lb 0.40 Oz)
 (Estimated Delivery Date)
 (Tuesday 09/04/2018)

Certified	1	\$3.45
(®USPS Certified Mail #)		
(7018036000059693830)		
Affixed Postage	1	(\$0.50)

Total	\$6.90
Cash	\$7.00
Change	(\$0.10)

Text your tracking number to 28777 (2USPS) to get the latest status. Standard Message and Data rates may

U.S. Postal Service™
CERTIFIED MAIL® RECEIPT
 Domestic Mail Only

For delivery information, visit our website at www.usps.com®.

WASHINGTON DC 20500

OFFICIAL USE

Certified Mail Fee	\$3.45
Extra Services & Fees (check box, add fee as appropriate)	\$0.00
<input type="checkbox"/> Return Receipt (hardcopy)	\$0.00
<input type="checkbox"/> Return Receipt (electronic)	\$0.00
<input type="checkbox"/> Certified Mail Restricted Delivery	\$0.00
<input type="checkbox"/> Adult Signature Required	\$0.00
<input type="checkbox"/> Adult Signature Restricted Delivery	\$0.00
Postage	\$0.50
Total Postage and Fees	\$3.95

0130
77

Postmark
Here

08/30/2018

Sent To

Street and Apt. No., or PO Box: Donald: POTUS Trump
 c/o President of the United States
 1600 Pennsylvania Ave NW
 City, State, ZIP+4®: Washington, District of Columbia 20500

PS Form 3800, April 2015 PSN 7530-02-900-2047 See Reverse for Instructions

701A 0360 0000 5919 3830

978



USPS Tracking®

FAQs > (<https://www.usps.com/faqs/uspstracking-faqs.htm>)

Track Another Package +

Tracking Number: 70180360000059688935

Remove X

Your item was delivered at 5:47 am on September 5, 2018 in WASHINGTON, DC 20530.

Delivered

September 5, 2018 at 5:47 am
Delivered
WASHINGTON, DC 20530

Tracking History 

Product Information 

See Less ^

Can't find what you're looking for?

Go to our FAQs section to find answers to your tracking questions.

FAQs (<https://www.usps.com/faqs/uspstracking-faqs.htm>)

2022-011769 MISC Page: 982 of 2782
09/26/2022 03:35:37 PM Receipt #: 22-9301
Rec Fee: \$30.00 Darrell James Hill
Gila County, AZ, Sadie Jo Bingham, Recorder





Customer Correspondence
MAC D1108-030
1525 West WT Harris Boulevard
Charlotte, NC 28262
wellsfargo.com

September 6, 2018

Beverly J Romero-Hill
P.O. Box 3806
Apache Junction, AZ 85117

Dear Beverly J Romero-Hill:

Thank you for writing with your important comments addressed to Wells Fargo Bank. Your feedback is very important to us, and we appreciate the opportunity to review your concerns.

Your concerns have been received by our Customer Correspondence Department. We are currently researching the items brought to our attention and will respond to you within ten business days with our findings.

In the meantime, if we can assist you in any way, please call *Wells Fargo Phone Bank*SM at 1-800-TO-WELLS (1-800-869-3557). Phone bankers are available 24 hours a day, 7 days a week.

Thank you.

Sincerely,
Customer Correspondence

2022-011769 MISC Page: 983 of 2782
09/26/2022 03:35:37 PM Receipt #: 22-9381
Rec Fee: \$30.00 Darrell James Hill
Gila County, Az, Sadie Jo Bingham, Recorder

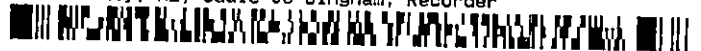

981



Wells Fargo Bank, N.A.
N977-112CC
PO Box 5141
Sioux Falls, SD 57117-5141

Beverly J Romero-Hill
P.O. Box 3806
Apache Junction, AZ 85117

9511784137 8036

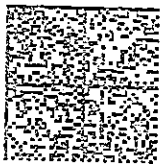
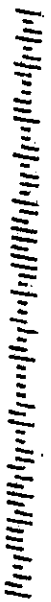

U.S. POSTAGE® PITNEY BOWES
ZIP 28262 \$000.470
02 4W
0000335733 SEP 07 2013

Unofficial Copy

982

2022-011769 MISC Page: 984 of 2782
09/26/2022 03:35:37 PM Receipt #: 22-9381
Rec Fee: \$30.00 Darrell James Hill
Gila County, Az, Sadie Jo Bingham, Recorder





MARK BRNOVICH
ATTORNEY GENERAL

OFFICE OF THE ARIZONA ATTORNEY GENERAL
CIVIL LITIGATION DIVISION
CONSUMER PROTECTION & ADVOCACY SECTION

CONSUMER INFORMATION &
COMPLAINTS
(602) 542-5763
(IN-STATE ONLY) (800) 352-8431

September 10, 2018

Darrell-James Hill
P.O. Box 3806
Apache Junction, AZ 85117

RE: CIC 18-008885 /

Dear Consumer:

The Consumer Protection and Advocacy Section of our office is in receipt of your correspondence concerning the above-referenced matter; unfortunately, it is not clear if you are filing a complaint with this office.

If you wish to file a complaint, please complete the enclosed form detailing all misrepresentations that occurred in the transaction. Please refer to the enclosed information sheet for the details of our procedures. With your consent, a copy of your complaint will be sent to the party against whom you are complaining. Should you, however, decide that you do not want any correspondence forwarded to the business, we will keep the complaint on file for our information only.

We thank you for bringing potential violations of the Consumer Fraud Act to our attention.

Sincerely,

Consumer Information and Complaints

Enclosure: Complaint Form
CPA:11

983

2022-011769 MISC Page: 985 of 2782
09/26/2022 03:35:37 PM Receipt #: 22-9381
Rec Fee: \$30.00 Darrell James Hill
Gila County, Az, Sadie Jo Bingham, Recorder

2005 NORTH CENTRAL AVENUE, PHOENIX, AZ 85004 • PHONE 602.542.5763



:Darrell-James: Hill and Beverly- Jean: Romero- Hill c/o PO Box 3806, Apache Junction, Ariz. 85117

Mark: Pinal County Arizona Sheriff Lamb
c/o Pinal County Sheriff's Office
971 Jason Lopez Circle, Building C
Florence, Ariz 85132
800-420-8689

USPS CMN 7017 1000 0000 9343 0728

Mark: Arizona Attorney General Brnovich
Office of the Attorney General
Phoenix Office
2005 N Central Ave
Phoenix, Ariz. 85004- 2926

First class mail

Michele: Arizona Secretary of State Reagan
c/o Office of the Secretary of State
1700 W Washington St Fl 7
Phoenix Ariz. 85007- 2808

First class mail

John: Chairman, President and CEO Stumpf
Wells Fargo and Company
420 Montgomery St.
San Francisco, Calif. 94163
(866) 878-5865

USPS CMN 7017 1000 0000 9343 0735

Lawrence: Bank Manager Lee
Wells Fargo Mac S4049-011
2891 West Apache Trail
Apache Junction, Arizona 85120

First class mail or hand delivered

Mark: Sheriff, Mark, Michele, John, Lawrence, Greetings,

i: man: beneficiary of the inherent rights and public trust known by the idem sonans subrogation BEVERLY JEAN ROMERO- HILL am :Beverly-Jean: Romero- Hill © © 1958, subrogee and Authorized Representative. i and my husband :Darrell- James: Hill © © 1958 are inhabitants on the Arizona state around and about the Apache Junction. And,

In accordance with out best effort to be complete in the statements attached – See our Affidavits: Claim of Wrong-doing by Aaron Jacob: Service manager, Assistant Vice President Jaime.... - annexed: 8 pages, – we in good faith efforts failed to find resolve with a Wells Fargo manager denying an Arizona Secretary of State notary officer from performing in accordance with the Arizona state law simply as he wanted to do so, and in despite of the effort and presentment of the Arizona law the manager ignored Arizona laws. It seemed the notary was also afraid of losing her position/ job security.

Essentially, this manager is the authority for to determine employee notaries' compliance with Arizona state law. Is this a Wells Fargo policy? Is this a special agreement with the Wells Fargo and Company and the Arizona government? Or, is this some independent, private people discrimination? I wish not to be disrespected, harassed or threatened by this man again.

We will speak out. But how many do not?

I (We) say now and will affirm same in the court.

Without prejudice
DARRELL JAMES HILL

Autographed this 29th day: August month: 2018

Darrell-James Hill
:Darrell- James: Hill, A.R.

Without prejudice
BEVERLY JEAN ROMERO- HILL

Autographed this 29th day: August month: 2018

Beverly-Jean Romero Hill
:Beverly- Jean: Romero- Hill, A.R.

2022-011769 MISC Page: 986 of 2782
09/26/2022 03:35:37 PM Receipt #: 22-9381
Rec Fee: \$30.00 Darrell James Hill
Gila County, Az, Sadie Jo Bingham, Recorder



984

COPY



Complaint/Confirmation #: 18-008885

Darrell-James Hill
 YOUR NAME
 P.O. Box 3806
 YOUR ADDRESS
 Apache Junction AZ 85117
 CITY STATE ZIP
 HOME PHONE NUMBER BEST NUMBER TO CALL DURING THE DAY
 EMAIL ADDRESS

NAME OR FIRM YOU ARE COMPLAINING AGAINST
 ADDRESS OF FIRM
 CITY STATE ZIP
 PHONE NUMBER OF FIRM EMAIL ADDRESS

For statistical purposes, please indicate:

- Your Age:
 Under the age of 30 Between the age of 60-79
 Between the age of 31-59 Over the age of 80
- How did you hear about our complaint form (please choose only one):
 Called Phoenix AG Office Visited an AG Satellite Office
 Called Tucson AG Office An out of State Agency
 Went onto AG Website Media: Newspaper/Radio/TV
- Military/Veteran:
 Currently in military service
 A veteran
 Another Arizona State Agency/State Legislator
 Attended AG Presentation/Event
 Other

May we send a copy of this to the person or firm you are complaining against: YES NO

(By selecting the answer, "Yes", to the question, "May we send a copy of this to the person or business you are complaining against," I hereby authorize the Office of the Arizona Attorney General to communicate with and provide information to the party(ies) against whom I have filed this complaint. I also authorize the party(ies) against whom I have filed this complaint to communicate with and provide information to the Office of the Arizona Attorney General in connection with this complaint. If your response is "No", we may be precluded from taking any action on your complaint.)

May we provide your name and telephone number to the media in the event of an inquiry about this matter: YES NO

May we send a copy of your complaint to another government agency for their review or investigation: YES NO

Was an oral or written warranty given: YES NO

Did you sign any documents: YES NO

Date of transaction: _____ Place of transaction: _____

Witness to transaction: _____ Salesperson's name: _____

Total amount of damages (list actual loss only): _____

Have you complained to the firm: YES NO

What was their response: _____

Was the product or service advertised: YES NO

If yes, indicate the date and how it was advertised:

Date: _____ Description: _____

Do you have an attorney: YES NO

If yes, please provide the attorney's name and address: _____

Is any legal action pending: YES NO

List any other consumer agencies contacted: _____

PLEASE EXPLAIN THE ENTIRE CIRCUMSTANCES SURROUNDING YOUR COMPLAINT IN THE FOLLOWING PAGE PROVIDED.

I declare, under penalty of perjury, that the facts and statements contained in this declaration, including any attached statements, are true, correct, and based upon my personal knowledge:

Signature _____

Date _____

985

COPY

2022-011769 MISC Page: 987 of 2782
 09/26/2022 03:35:37 PM Receipt #: 22-9381
 Rec Fee: \$30.00 Darrell James Hill
 Gila County, AZ, Sadie Jo Bingham, Recorder



ARIZONA ATTORNEY GENERAL
 CONSUMER INFORMATION AND COMPLAINTS
 2005 N CENTRAL AVENUE
 PHOENIX, AZ 85004-1592

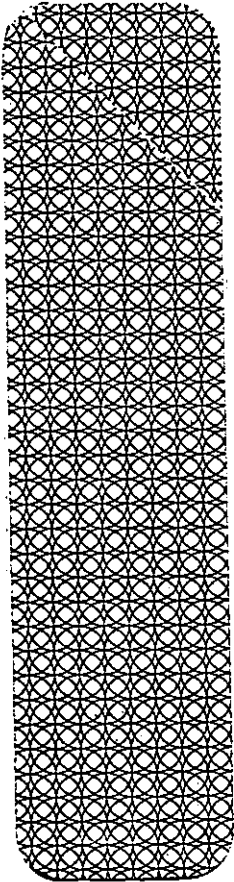

ES11784137 B035

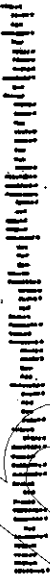

ZIP 85007
 041M11284346

NEOPOST
 09/11/2018
 FIRST-CLASS MAIL
 POSTAGE \$000.479

2022-011769 MISC Page: 988 of 2782
 09/26/2022 03:35:37 PM Receipt #: 22-9381
 Rec Fee: \$30.00 Darrell James Hill
 Gila County, Az, Sadie Jo Bingham, Recorder



988

Unofficial Copy



Customer Correspondence
MAC D1108-030
1525 West WT Harris Boulevard
Charlotte, NC 28262

wellsfargo.com

September 12, 2018

Darrell Hill and Beverly-Jean Romero-Hill
P.O. Box 3806
Apache Junction, AZ 85117

Subject: Service Issue

Dear Darrell Hill and Beverly-Jean Romero-Hill:

We are committed to building better every day by understanding and addressing customer concerns. We want to let you know that your letter dated August 29, 2018, was forwarded to Customer Correspondence for research. We appreciate the opportunity to address your concerns.

We regret to hear that you had an unpleasant experience when you visited the Apache Trail & Meridian Branch. At Wells Fargo, we pride ourselves on developing and maintaining quality financial relationships and strive to consistently deliver the exemplary service we know our customers deserve. We strive to provide prompt, hassle-free service to all of our customers. It was difficult to learn we have not met your expectations. Your comments are very important to us, as feedback is vital to providing stellar service. Your comments and concerns have been forwarded to the appropriate management for review.

In your complaint, you inquired if there was an independent form of "private, people discrimination" in regard to the branch declining your request. Please be assured Wells Fargo takes all allegations of discrimination very seriously, and does not tolerate such behavior from our employees or from individuals with whom we do business. We are committed to being an inclusive company where all people are treated fairly and recognized for their individuality. Our intent is to provide hassle-free service to all customers with the most professional, courteous and efficient customer assistance possible. We sincerely apologize for any inconvenience or frustration you might have experienced as a result of your visits.

In researching your complaint our office contacted the Apache Trail & Meridian Branch with regard to your concerns. The Branch Manager informed us that during your visit that a birth certificate and an Arizona state driver's license were presented to be notarized. Upon review, they contacted the Secretary of State and confirmed that they would not be able to notarize the birth certificate but they would be allowed to notarize the driver's license if Wells Fargo provided the correct form. At this time, Wells Fargo does not provide the form required to notarize the requested documents so the request was declined. It was also advised that you were provided with Notary Books Edition Thirteen and Fourteen that confirmed they would not be able to complete your request.

2022-011769 MISC Page: 989 of 2782
09/26/2022 03:35:37 PM Receipt #: 22-9381
Rec Fee: \$30.00 Darrell James Hill
Gila County, Az, Sadie Jo Bingham, Recorder



987



We understand our procedures can be frustrating. Our intent is to provide hassle-free service to all customers with the most professional, courteous and efficient customer assistance possible. It is not the bank's intent to make your banking experience difficult, but to ensure we are consistent in applying bank policy and our security measures to all of the bank's customers.

We regret these circumstances have caused a negative perception of our company. We value your relationship with us and we are committed to regaining your confidence in Wells Fargo. If you have any questions, please call *Wells Fargo Phone Bank*SM at 1-800-TO-WELLS (1-800-869-3557). Phone Bankers are available to assist you 24 hours a day, 7 days a week.

Sincerely,

G. Shaw
Research/Remediation Analyst





Wells Fargo Bank, N.A.
N9777-112CC
PO Box 5141
Sioux Falls, SD 57117-5141

Darrell Hill and Beverly-Jean Romero-Hill
P.O. Box 3806
Apache Junction, AZ 85117

8511784137 8035

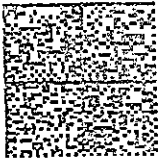
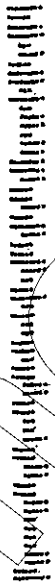

U.S. POSTAGE HTNEY BOWES
ZIP 28262 \$ 000.47
02 AM
0000335733 SEP 13 2018

2022-011769 MISC Page: 991 of 2782
09/26/2022 03:35:37 PM Receipt #: 22-9381
Rec Fee: \$30.00 Darrell James Hill
Gila County, Az, Sadie Jo Bingham, Recorder



Unofficial Copy

Beverly- Jean: Romero- Hill PO Box 3806, Apache Junction, Arizona 85117 (602) 618-4595

Treasury Retail Securities Site
PO Box 7015
Minneapolis, MN 55480-7015

Re: FS Form 5444 – TreasuryDirect® Account Authorization
Minor Account information requests

Identification

The identity of the man beneficiary- owner :Beverly- Jean: Romero- Hill © ® 1958: New Mexican, of the minor account held by the United States government- trustee is established within the annexed page: "FS Form 5444 – TreasuryDirect® Account Authorization".

Right to Information Requests:

- 1) **Custodian** – Who is the person who performs fiduciary duties for the account(s) for this beneficiary?
Please provide that name and complete contact information so that I may address him on the matters on the account(s).
- 2) **Accounts Information**
Current – Please provide current account items location print-out so that I may check the current information.
Historical – Please provide the fiscal years; 2016 and 2017 accounting for the minor account, including the confirmation number, Issue Date, Face Amount, CUSIP No., and other identifiers of:
 - a) the list of the bond types;
 - b) the list of the national investments;
 - c) the list or the international investments;
 - d) the list of the liquid resource ledgers with explanations;
 - e) the list of the public side debt ledgers with explanations; and,
 - f) the list of any other debt ledgers with explanations, ex. Trustee compensation.

Neither Email Nor Arizona home delivery box are secure; I authorize the information requested to be sent: a) by signed receipt delivery, or b) to the United States Post Office location: "
Beverly- Jean: Romero- Hill
c/o PO Box 3806
Apache Junction, Arizona 85117 "

I affirm the contents of this delivery, request and mailing authorization, and will state same in open court.

Without Prejudice
BEVERLY JEAN ROMERO

Autographed: 24th day October month, 2018

Beverly- Jean: Romero- Hill, A.R.
:Beverly- Jean: Romero- Hill: A.R.

2022-011769 MISC Page: 992 of 2782
09/26/2022 03:35:37 PM Receipt #: 22-9381
Rec Fee: \$30.00 Darrell James Hill
Gila County, Az, Sadie Jo Bingham, Recorder

USPS CMN 7018 0630 0000 5968 9811



TreasuryDirect Account Authorization

IMPORTANT: Follow instructions in filling out this form. Making any false, fictitious, or fraudulent claim or statement to the United States is a crime.
INSTRUCTIONS: Mail the completed authorization form to: Treasury Retail Securities Site, PO Box 7015, Minneapolis, MN 55480-7015.

AUTHORIZATION: I, man under the Almighty God am :Beverly- Jean: (of the family) Romero- Hill © © 1958: New Mexican, beneficiary, subrogee, sui juris - Authorized Representative, "A.R.", to the owner-beneficiary interest in: i) the trust subrogation named BEVERLY JEAN ROMERO~&etcetera-derivative-forms from the 'UNITED STATES government' service provider-trustee-subrogor; and, ii) the inherent trust from God Almighty - to wit: Nothing stands between I:man and the Almighty God. Wherefore: a) I authorize a TreasuryDirect account as a natural person, without prejudice of any natural rights or constitutional protections pursuant to the Trustee's transfer of the any property free and clear and without any further obligation(s), including, but not limited to: 31 CFR Ch. II (07-01-2003) §§ 363.110 - 119, et seq. for all intents and purposes; b) I authorize the TreasuryDirect account for activation based upon the approval of this authorization in lieu of 31 CFR Ch. II (07-01-2003) §363.126(c), et seq. for all intents and purposes; and, c) I affirm the information provided is true, correct and complete, and will state same in the open court.

Authorized Representative
 Autograph: Beverly-Jean Romero Hill, A.R.
 (Natural person)

BEVERLY JEAN ROMERO
 (Subrogation: natural person)

Habitat 5124 East 18th Avenue
 (Number and Street)

Apache Junction Arizona 85119
 (city) (state) (zip code)

480-276-1014
 (Telephone Number)

bev4yah@gmail.com
 (e-mail)

Check to remove Hardlock

Instructions to Certifying Officer: 1. Name of the natural person who presented and the day of presence MUST be completed. 2. If a Medallion stamp is used an original signature is required. 3. Natural person must sign in your presence.

I CERTIFY that Beverly Jean Romero, whose identity(-ies)
 (Name: Natural Person Who Presented)

is/are known or proven to me, personally presented before me this 20th day of October 2018
 (Month/Year)

at Apache Junction, Arizona and autographed this form.
 (City, State)

[Signature] Personal Banker
 (Signature and Title of Certifying Officer)

Wells Fargo Bank
 (Name of Financial Institution)

231 S Phelps Dr
 (Address)

Apache Junction, AZ 85120
 (City, State, ZIP code)

480-982-1039
 (Telephone)

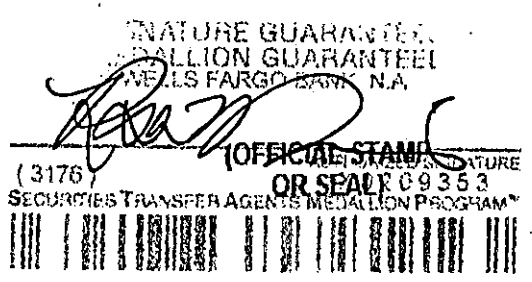

(Notary certification is NOT acceptable.)

991

2022-011769 MISC Page: 993 of 2782
 09/26/2022 03:35:37 PM Receipt #: 22-9381
 Rec Fee: \$30.00 Darrell James Hill
 Gila County, Az, Sadie Jo Bingham, Recorder



United States of America



DEPARTMENT OF STATE

To all to whom these presents shall come, Greetings:

I Certify That the document hereunto annexed is under the Seal of the State(s) of New Mexico, and that such Seal(s) is/are entitled to full faith and credit.*

**For the contents of the annexed document, the Department assumes no responsibility
This certificate is not valid if it is removed or altered in any way whatsoever*

2022-011769 MISC Page: 994 of 2782
09/26/2022 03:35:37 PM Receipt #: 22-9381
Rec Fee: \$30.00 Darrell James Hill
Gila County, Az, Sadie Jo Bingham, Recorder

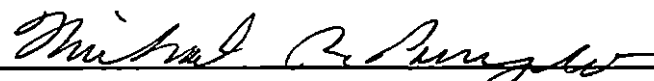

In testimony whereof, I, Michael R. Pompeo, Secretary of State, have hereunto caused the seal of the Department of State to be affixed and my name subscribed by the Assistant Authentication Officer, of the said Department, at the city of Washington, in the District of Columbia, this fifteenth day of August, 2018.

Secretary of State

By 
Assistant Authentication Officer,
Department of State

Issued pursuant to CHXIV, State of Sept. 15, 1789, 1 Stat. 68-69; 22 USC 2657; 22 USC 2651a; 5 USC 301; 28 USC 1733 et. seq.; 8 USC 1443(f); RULE 44 Federal Rules of Civil Procedure.

992

151 W SUPERSTITION BLVD
 APACHE JUNCTION
 AZ
 85120-9998
 0302590130

10/24/2018 (800)275-8777 3:17 PM

Product Description	Sale Qty	Final Price
---------------------	----------	-------------

First-Class Mail Letter (Domestic)	1	\$0.50
------------------------------------	---	--------

(Domestic)
 (MINNEAPOLIS, MN 55480)
 (Weight: 0 Lb 0.60 Oz)
 (Estimated Delivery Date)
 (Saturday 10/27/2018)

Certified Mail #	1	\$3.45
------------------	---	--------

(@@USPS Certified Mail #)
 (70180360000059688911)

Return Receipt	1	\$2.75
----------------	---	--------

(@@USPS Return Receipt #)
 (9590940238528032532467)

Affixed Postage	1	(\$0.50)
-----------------	---	----------

(Affixed Amount: \$0.50)

First-Class Mail Letter (Domestic)	1	\$0.50
------------------------------------	---	--------

(Domestic)
 (MINNEAPOLIS, MN 55480)
 (Weight: 0 Lb 0.60 Oz)
 (Estimated Delivery Date)
 (Saturday 10/27/2018)

Certified Mail #	1	\$3.45
------------------	---	--------

(@@USPS Certified Mail #)
 (70180360000059688928)

Return Receipt	1	\$2.75
----------------	---	--------

(@@USPS Return Receipt #)
 (9590940238528032532470)

Affixed Postage	1	(\$0.50)
-----------------	---	----------

(Affixed Amount: \$0.50)

Total		\$12.40
-------	--	---------

Cash		\$20.00
------	--	---------

Change		
--------	--	--

Next your USPS tracking number will be printed on the label. Standard rates apply. Your USPS Tracking number will be printed on the label.

SENDER: COMPLETE THIS SECTION

- Complete items 1, 2, and 3.
- Print your name and address on the reverse so that we can return the card to you.
- Attach this card to the back of the mailpiece, or on the front if space permits.

1. Article Addressed to:

Treasury Retail Securities Site
 PO Box 7015
 Minneapolis, MN 55480-7015



9590 9402 3852 8032 5324 70

7018 0360 0000 5968 8928

PS Form 3811, July 2015 PSN 7530-02-000-9053

993

U.S. Postal Service CERTIFIED MAIL® RECEIPT
 Domestic Mail Only

For delivery information, visit our website at www.usps.com

MINNEAPOLIS MN 55480 OFFICIAL USE

Certified Mail Fee	\$3.45
Extra Services & Fees (check box, add fee as appropriate)	\$2.75
<input type="checkbox"/> Return Receipt (hardcopy)	\$0.00
<input type="checkbox"/> Return Receipt (electronic)	\$0.00
<input type="checkbox"/> Certified Mail Restricted Delivery	\$0.00
<input type="checkbox"/> Adult Signature Required	\$0.00
<input type="checkbox"/> Adult Signature Restricted Delivery	\$0.00

Postage	\$0.50
---------	--------

Total Postage and Fees	\$6.70
------------------------	--------

Sent To

Treasury Retail Securities Site
 PO Box 7015

City, State, ZIP+4® Minneapolis, MN 55480-7015

PS Form 3800, April 2015 PSN 7530-02-000-9047

0130 06

Postmark Here

10/24/2018

U.S. Postal Service CERTIFIED MAIL® RECEIPT
 Domestic Mail Only

For delivery information, visit our website at www.usps.com

MINNEAPOLIS MN 55480 OFFICIAL USE

Certified Mail Fee	\$3.45
Extra Services & Fees (check box, add fee as appropriate)	\$2.75
<input type="checkbox"/> Return Receipt (hardcopy)	\$0.00
<input type="checkbox"/> Return Receipt (electronic)	\$0.00
<input type="checkbox"/> Certified Mail Restricted Delivery	\$0.00
<input type="checkbox"/> Adult Signature Required	\$0.00
<input type="checkbox"/> Adult Signature Restricted Delivery	\$0.00

Postage	\$0.50
---------	--------

Total Postage and Fees	\$6.70
------------------------	--------

Sent To

Treasury Retail Securities Site
 PO Box 7015

City, State, ZIP+4® Minneapolis, MN 55480-7015

PS Form 3800, April 2015 PSN 7530-02-000-9047

0130 06

Postmark Here

10/24/2018

COMPLETE THIS SECTION ON DELIVERY

A. Signature
 Federal Reserve Bank
 C. J. [Signature]

Agent
 Addressee

B. Received by (Printed Name)

C. Date of Delivery
 OCT 26 7 30

D. Is delivery address different from item 1? Yes
 If YES, enter delivery address below: No

3. Service Type
 Adult Signature
 Adult Signature Restricted Delivery
 Certified Mail®
 Certified Mail Restricted Delivery
 Collect on Delivery
 Collect on Delivery Restricted Delivery
 Priority Mail Express®
 Registered Mail™
 Registered Mail Restricted Delivery
 Return Receipt for Merchandise
 Signature Confirmation™
 Signature Confirmation

2022-011769 MISC Page: 995 of 2782

09/26/2022 03:35:37 PM Receipt #: 22-9381

Rec Fee: \$30.00 Darrell James Hill

Gila County, Az, Sadie Jo Bingham, Recorder



USPS Tracking®

FAQs > (<https://www.usps.com/faqs/uspstracking-faqs.htm>)

Track Another Package +

Tracking Number: 70180360000059688928

Remove X

Your item was delivered at 8:51 am on October 29, 2018 in MINNEAPOLIS, MN 55480.

✓ Delivered

October 29, 2018 at 8:51 am
Delivered
MINNEAPOLIS, MN 55480

Get Updates ▾

Text & Email Updates ▾

Tracking History ▴

October 29, 2018, 8:51 am
Delivered
MINNEAPOLIS, MN 55480
Your item was delivered at 8:51 am on October 29, 2018 in MINNEAPOLIS, MN 55480.

October 27, 2018, 7:03 am
Sorting Complete
MINNEAPOLIS, MN 55480

October 27, 2018, 1:20 am
Arrived at Unit
MINNEAPOLIS, MN 55401

October 26, 2018, 4:32 pm
Departed USPS Regional Destination Facility
MINNEAPOLIS MN DISTRIBUTION CENTER

October 26, 2018, 12:06 pm

Feedback

994

2022-011769 MISC Page: 996 of 2782

09/26/2022 03:35:37 PM Receipt #: 22-9381
Rec Fee: \$30.00 Darrell James Hill

Gila County, Az, Sadie Jo Bingham, Recorder



Darrell- James: Hill PO Box 3806, Apache Junction, Arizona 85117 (602) 618-4595

Treasury Retail Securities Site
PO Box 7015
Minneapolis, MN 55480-7015

Re: FS Form 5444 – TreasuryDirect® Account Authorization
Minor Account information requests

Identification

The identity of the man beneficiary- owner :Darrell- James: Hill © © 1958: Ohioan, of the minor account held by the United States government- trustee is established within the annexed page: "FS Form 5444 – TreasuryDirect® Account Authorization".

Right to Information Requests:

- 1) **Custodian** – Who is the person who performs fiduciary duties for the account(s) for this beneficiary? Please provide that name and complete contact information so that I may address him on the matters on the account(s).
- 2) **Accounts Information**
 - Current – Please provide current account items location print-out so that I may check the current information.
 - Historical – Please provide the fiscal years: 2016 and 2017 accounting for the minor account, including the confirmation number, Issue Date, Face Amount, CUSIP No., and other identifiers of:
 - a) the list of the bond types;
 - b) the list of the national investments;
 - c) the list or the international investments;
 - d) the list of the liquid resource ledgers with explanations;
 - e) the list of the public side debt ledgers with explanations; and,
 - f) the list of any other debt ledgers with explanations, ex. Trustee compensation.

Neither Email Nor Arizona home delivery box are secure; I authorize the information requested to be sent: a) by signed receipt delivery, or b) to the United States Post Office location: "Darrell- James: Hill c/o PO Box 3806 Apache Junction, Arizona 85117 "

I affirm the contents of this delivery, request and mailing authorization, and will state same in open court.

Without Prejudice
DARRELL JAMES HILL

:Darrell- James: Hill, A.R.
:Darrell- James: Hill, A.R.

Autographed: 24th day October month, 2018

USPS CMN 7018 0630 0000 5968 9828

2022-011769 MISC Page: 997 of 2782
09/26/2022 03:35:37 PM Receipt #: 22-9381
Rec Fee: \$30.00 Darrell James Hill
Gila County, Az, Sadie Jo Bingham, Recorder

TreasuryDirect Account Authorization



IMPORTANT: Follow instructions in filling out this form. Making any false, fictitious, or fraudulent claim or statement to the United States is a crime.

INSTRUCTIONS: Mail the completed authorization form to: Treasury Retail Securities Site, PO Box 7015, Minneapolis, MN 55480-7015.

AUTHORIZATION: I, man under the Almighty God am :Darrell- James: (of the family) Hill © © 1958: Ohioan, beneficiary, subrogee, sui juris - Authorized Representative, "A.R.", to the owner-beneficiary interest in: i) the trust subrogation named DARRELL JAMES HILL~&cetera-derivative-forms from the "UNITED STATES government" service provider-trustee~subrogor; and, ii) the inherent trust from God Almighty - to wit: Nothing stands between I:man and the Almighty God. Wherefore: a) i authorize a TreasuryDirect account as a natural person, without prejudice of any natural rights or constitutional protections pursuant to the Trustee's transfer of the any property free and clear and without any further obligation(s), including, but not limited to: 31 CFR Ch. II (07-01-2003) §§ 363.110- 119, et seq. for all intents and purposes; b) i authorize the TreasuryDirect account for activation based upon the approval of this authorization in lieu of 31 CFR Ch. II (07-01-2003) §363.126(c), et seq. for all intents and purposes; and, c) i affirm the information provided is true, correct and complete, and will state same in the open court.

Authorized Representative Autograph: Darrell - James Hill, A.R.
(Autograph of the natural person)

DARRELL JAMES HILL
(Subrogation: natural person)

Habitat 5124 East 18th Avenue
(Number and Street)

Apache Junction, Arizona 85119
(city) (state) (zip code)

(602) 618-4595
(Telephone Number)

djhil4yah@gmail.com
(e-mail)

[Redacted]
(Social Security Number)

Check to remove Hardlock

Instructions to Certifying Officer: 1. Name of the natural person who presented and the day of presence MUST be completed. 2. If a Medallion stamp is used an original signature is required. 3. Natural person must sign in your presence.

I CERTIFY that Darrell James Hill, whose identity(-ies) (Name: Natural Person Who Presented)

is/are known or proven to me, personally presented before me this 22ND day of October 2018 (Month/Year)

at Apache Junction, Arizona and autographed this form. (City, State)

[Signature] Personal Banker
(Signature and Title of Certifying Officer)

Wells Fargo Bank
(Name of Financial Institution)

231 S Phelps Dr
(Address)

Apache Junction, AZ 85120
(City, State, ZIP code)

480-982-1039
(Telephone)

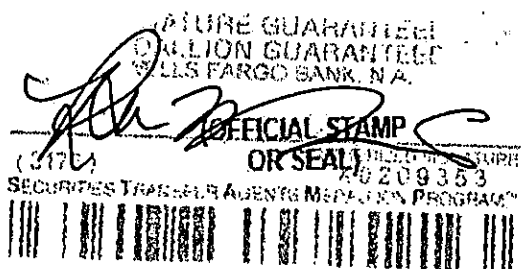

(Notary certification is NOT acceptable.)

996

2022-011769 MISC Page: 998 of 2782
 09/26/2022 03:35:37 PM Receipt #: 22-9381
 Rec Fee: \$30.00 Darrell James Hill
 Gila County, Az, Sadie Jo Bingham, Recorder

United States of America



DEPARTMENT OF STATE

To all to whom these presents shall come, Greetings:

I Certify That the document hereunto annexed is under the Seal of the Secretary of State of the State(s) of Ohio, and that such Seal(s) is/are entitled to full faith and credit.*

**For the contents of the annexed document, the Department assumes no responsibility
This certificate is not valid if it is removed or altered in any way whatsoever*

In testimony whereof, I, Michael R. Pompeo, Secretary of State have hereunto caused the seal of the Department of State to be affixed and my name subscribed by the Assistant Authentication Officer, of the said Department, at the city of Washington, in the District of Columbia, this seventeenth day of July, 2018.

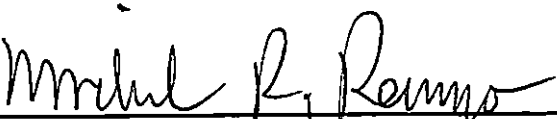
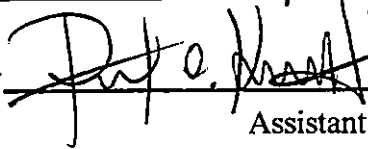
Secretary of State
By 
Assistant Authentication Officer,
Department of State

Issued pursuant to CHXIV, State of
Sept. 15, 1789, 1 Stat. 68-69; 22
USC 2657; 22 USC 2651a; 5 USC
301; 28 USC 1733 et. seq.; 8 USC
1443(f); RULE 44 Federal Rules of
Civil Procedure.

997

2022-011769 MISC Page: 999 of 2782

09/26/2022 03:35:37 PM Receipt #: 22-9381
Rec. Fee: \$30.00 Darrell James Hill
Gila County, Az, Sadie Jo Bingham, Recorder



Official Copy

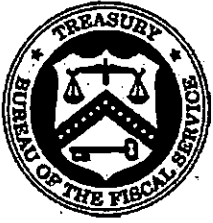

Treasury Securities Services

November 7, 2018

Customer: 0002689606S
Darrell Hill



DARRELL HILL
PO BOX 3806
APACHE JUNCTION AZ 85117

Dear Darrell Hill:

This letter refers to your recent transaction and/or inquiry.

The FS Form 5444 was received, however we could not locate a TreasuryDirect under the social security number provided.

Please let us know if we can be of further service. For general questions about Treasury Securities, visit our website at www.treasurydirect.gov.

Sincerely,

Treasury Services

998
2022-011769 MISC Page: 1000 of 2782
09/26/2022 03:35:37 PM Receipt #: 22-9381
Rec Fee: \$30.00 Darrell James Hill
Gila County, Az; Sadie Jo Bingham, Recorder



For information about Treasury Retail securities, go to:
www.treasurydirect.gov

BUREAU OF THE FISCAL SERVICE
PO BOX 1328
PARKERSBURG WV 26106

156 1 SP 0.470

DARRELL HILL
PO BOX 3806
APACHE JUNCTION AZ 85117

November 7, 2018

Treasury Retail Securities

IMPORTANT INFORMATION

Thank you for your recent inquiry regarding Treasury Retail Securities. If you are responding to our correspondence, please include this bar code sheet with your response. Failure to include this sheet may delay the processing of your request. Please note:

- Place this bar code sheet on the top of all documents you submit.
- Mail your transaction to the address provided below using the enclosed return envelope.
- Ensure that the return address at the bottom of this sheet is visible in the envelope window.
- Make a note of the Customer Number (Shown below) for all future reference or communication purposes.

For Internal purposes only

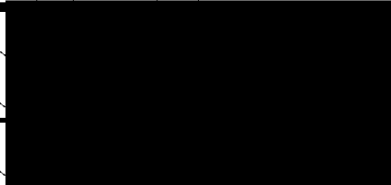

156 1 SP 0.470

CSAS2

TREASURY RETAIL SECURITIES SITE
PO BOX 9150
MINNEAPOLIS MN 55480

2022-011769 MISC Page: 1001 of 2782
09/26/2022 03:35:37 PM Receipt #: 22-9381
Rec Fee: \$30.00 Darrell James Hill
Gila County, Az, Sadie Jo Bingham, Recorder



For information about Treasury Retail securities, go to:
www.treasurydirect.gov



999

UNITED STATES DISTRICT COURT
FOR THE NORTHERN DISTRICT OF NEW YORK
COURT CASE NUMBER: 16-CR-166 (NAM); NOTICE OF FORFEITURE

Notice is hereby given that on September 23, 2016, in the case of U.S. v. Jason Chisholm, Court Case Number 16-CR-166 (NAM), the United States District Court for the Northern District of New York entered an Order condemning and forfeiting the following property to the United States of America:

\$649.00 U.S. Currency (16-FBI-003218)

The United States hereby gives notice of its intent to dispose of the forfeited property in such manner as the United States Attorney General may direct. Any person, other than the defendant(s) in this case, claiming interest in the forfeited property must file a Petition within 60 days of the first date of publication (September 29, 2016) of this Notice on this official government internet web site, pursuant to Rule 32.2 of the Federal Rules of Criminal Procedure and 21 U.S.C. § 853(n)(1). The petition must be filed with the Clerk of the Court, U.S. District Court Clerk's Office, Northern District of NY, P.O. Box 7367, 100 South Clinton Street, Syracuse, NY 13261, and a copy served upon Assistant United States Attorney Tamara Thomson, 100 South Clinton Street, Suite 900, Syracuse, NY 13261. The petition shall be signed by the petitioner under penalty of perjury and shall set forth the nature and extent of the petitioner's right, title or interest in the forfeited property, the time and circumstances of the petitioner's acquisition of the right, title and interest in the forfeited property and any additional facts supporting the petitioner's claim and the relief sought, pursuant to 21 U.S.C. § 853(n).

Following the Court's disposition of all petitions filed, or if no such petitions are filed, following the expiration of the period specified above for the filing of such petitions, the United States shall have clear title to the property and may warrant good title to any subsequent purchaser or transferee.

2022-011769 MISC Page: 1002 of 2782
09/26/2022 03:35:37 PM Receipt #: 22-9381
Rec Fee: \$30.00 Darrell James Hill
Gila County, Az, Sadie Jo Bingham, Recorder



U.S. POSTAGE PITNEY BOWES

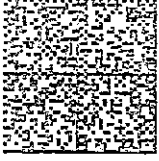

ZIP 55401 \$ 000.47
02 4W 0000345222 NOV 07 2018

1000
Unofficial Copy

2022-011769 MISC Page: 1003 of 2782
09/26/2022 03:35:37 PM Receipt #: 22-9381
Rec Fee: \$30.00 Darrell James Hill
Gila County, Az, Sadie Jo Bingham, Recorder





Treasury Securities Services

November 9, 2018

Customer: 0002689611S
Beverly Romero



BEVERLY ROMERO
PO BOX 3806
APACHE JUNCTION AZ 85117

Dear Beverly Romero:

This letter refers to your recent transaction and/or inquiry.

A TreasuryDirect account is only used to purchase United States Savings Bonds, Treasury Bills, Treasury Notes and Treasury Bonds with your own money deducted from your personal checking or savings account where you conduct banking business.

Please be aware that neither your birth certificate nor your social security number are savings bonds, nor are they any other type of Department of Treasury obligation. The information regarding your entitlement to securities and/or savings bonds is incorrect. Contrary to what you believe, your birth certificate is NOT a security, and therefore there are not any Government funds to which you are entitled because you were born in this country. This is a birthright scam. There is nothing further we can do to assist you.

For general questions about Treasury Securities, visit our website at www.treasurydirect.gov.

Sincerely,

Treasury Services

2022-011769 MISC Page: 1004 of 2782
09/26/2022 03:35:37 PM Receipt #: 22-9381
Rec Fee: \$30.00 Darrell James Hill
Gila County, Az, Sadie Jo Bingham, Recorder

For information about Treas
www.treasu



COPY

Unofficial

1001

BUREAU OF THE FISCAL SERVICE
PO BOX 1328
PARKERSBURG WV 26106

331 1 SP 0.470

BEVERLY ROMERO
PO BOX 3806
APACHE JUNCTION AZ 85117

November 9, 2018

Treasury Retail Securities

IMPORTANT INFORMATION

Thank you for your recent inquiry regarding Treasury Retail Securities. If you are responding to our correspondence, please include this bar code sheet with your response. Failure to include this sheet may delay the processing of your request. Please note:

- Place this bar code sheet on the top of all documents you submit.
- Mail your transaction to the address provided below using the enclosed return envelope.
- Ensure that the return address at the bottom of this sheet is visible in the envelope window.
- Make a note of the Customer Number (shown below) for all future reference or communication purposes.

For Internal purposes only

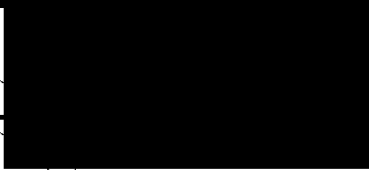



CSAS2

TREASURY RETAIL SECURITIES SITE
PO BOX 9150
MINNEAPOLIS MN 55480

1002

2022-011769 MISC Page: 1005 of 2782
09/26/2022 03:35:37 PM Receipt #: 22-9381
Rec Fee: \$30.00 Darrell James Hill
Gila County, Az, Sadie Jo Bingham, Recorder

For information about Treasury
www.treasury



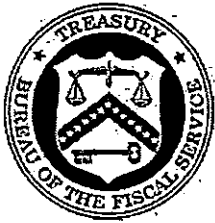

Treasury Securities Services

December 10, 2018

Customer: 0002689611S
Beverly Romero



BEVERLY ROMERO
PO BOX 3806
APACHE JUNCTION AZ 85117

Dear Beverly Romero:

This letter refers to your recent transaction and/or inquiry.

You don't have a TreasuryDirect account because you never opened one. TreasuryDirect® is our Web-based system that allows you to purchase the full range of Treasury consumer securities in one convenient online account. In your TreasuryDirect account, you can purchase and hold bills, notes, bonds, Treasury Inflation-Protected Securities (TIPS), Series EE or I savings bonds, and Zero-Percent Certificates of Indebtedness (C of I). It's available 24 hours a day, 7 days a week. But that's not all. You can also:

- Convert paper Series EE/E and I savings bonds to electronic securities and hold them in your TreasuryDirect account.
- Transfer marketable securities (bills, notes, bonds, and TIPS) from a Legacy Treasury Direct® account or from the commercial market into your TreasuryDirect account.

Your TreasuryDirect account is protected by a password of your choosing. The system allows you to conduct most of your routine transactions online. You can purchase, reinvest, or sell securities, and perform account maintenance from your home or work computer. Adding or editing bank information and some transfers will require a paper form. You can also view all your account information, including pending transactions. TreasuryDirect offers all of these features with no maintenance fees, no matter how much you have invested. With TreasuryDirect, there are no paper securities.

For additional information or to open an account, log on to <http://www.treasurydirect.gov/>. To open an account, click on Open An Account in the right-hand section of the screen. On the TreasuryDirect - Open an Account screen, click on TreasuryDirect.

Sincerely,

Treasury Services

1003



For information about Treas
www.treasur

2022-011769 MISC Page: 1006 of 2782
09/26/2022 03:35:37 PM Receipt #: 22-9381
Rec Fee: \$30.00 Darrell James Hill
Gila County, Az, Sadie Jo Bingham, Recorder



COPY

U.S. POSTAGE & FINES LOWERS

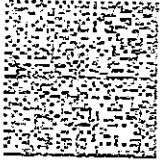

ZIP 55401 \$ 000.470
02 4H
0000345222 DEC 10 2018

MINNEAPOLIS

MN 554

10 DEC '18

FMS 1

1004

Unofficial Copy

2022-011769 MISC Page: 1007 of 2782

09/26/2022 03:35:37 PM Receipt #: 22-9381

Rec Fee: \$30.00 Darrell James Hill

Gila County, Az, Sadie Jo Bingham, Recorder



BUREAU OF THE FISCAL SERVICE
PO BOX 1328
PARKERSBURG WV 26106

186 1 SP 0.470

BEVERLY ROMERO
PO BOX 3806
APACHE JUNCTION AZ 85117

December 10, 2018

Treasury Retail Securities

IMPORTANT INFORMATION

Thank you for your recent inquiry regarding Treasury Retail Securities. **If you are responding to our correspondence, please include this bar code sheet with your response.** Failure to include this sheet may delay the processing of your request. Please note:

- Place this bar code sheet on the top of all documents you submit.
- Mail your transaction to the address provided below using the enclosed return envelope.
- Ensure that the return address at the bottom of this sheet is visible in the envelope window.
- Make a note of the Customer Number (shown below) for all future reference or communication purposes.

For Internal purposes only

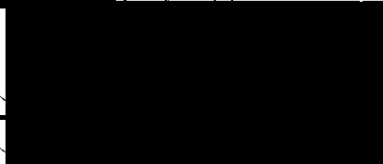

CSAS2

TREASURY RETAIL SECURITIES SITE
PO BOX 9150
MINNEAPOLIS MN 55480

1005



For information about Treas
www.treasur

2022-011769 MISC Page: 1008 of 2782
09/26/2022 03:35:37 PM Receipt #: 22-9381
Rec Fee: \$30.00 Darrell James Hill
Gila County, Az, Sadie Jo Bingham, Recorder



Notice: Revocation of the Internal-Revenue-Service Power of the Attorney

:Darrell-James: Hill, A.R.
c/o DARRELL JAMES HILL
PO Box 3806
Apache Junction, Arizona 85117

Internal Revenue Service Center
Ogden, Utah 84201-0002

USPS CMN 7018 0360 0000 5968 8904

Arizona State
Pinal County

Notice: Revocation of the Internal Revenue Service Power of the Attorney

Notice to the agent is notice to the principal, Greetings:

i: man am :Darrell-James: Hill © ® TM 1958: Ohioan: beneficiary and Authorized Representative of the 1) inherent-trust from the Almighty God where nothing stands between the Almighty God and i; and: 2) principal, subrogee and Authorized Representative for the subrogation named: **DARRELL JAMES HILL~et al. derivatives with the [REDACTED]~Social-Security-Numbers from the United States government-trustee~service-provider and subrogor. And:**

- 1 For the any Internal-Revenue-Service power or authority granted and/or presumed under the any power-of-attorney for the affairs of the man: Darrell-James: Hill: beneficiary and A.R. by/with the subrogation: **DARRELL JAMES HILL~et al. derivatives with the [REDACTED] Social-Security-Numbers is now revoked.**
- 2 i: Darrell-James: Hill, A.R., now revoke and withdraw all of the Internal-Revenue-Service power or authority granted and/or presumed to act in any matter by/with the subrogation: **DARRELL JAMES HILL~et al. derivatives with the [REDACTED] Social-Security-Numbers as an attorney-in-fact for: i.**
- 3 Whereupon after the 10 days of a silence in the response to this absolute restriction by :Darrell-James: Hill: beneficiary and A.R. of the subrogation: **DARRELL JAMES HILL~et al. derivatives with the [REDACTED] Social-Security-Numbers then: Notice: Revocation of the Internal-Revenue-Service power of the attorney is: Internal Revenue Service-agreement by the tacit-acquiescence with the tacit-procuration for the payment by the fee-schedule-agreement for the violation of this absolute-revocation-agreement.**

For the fee-schedule-agreement with the violation of this revocation-agreement is: a) one U.S. silver dollar in the specie per the minute-unit of the time from the receipt of this document unto the resolve of this matter; and: b) payment-due-now upon the presentment of a request for the any period of the payment-now-due by the undersigned and: heirs, agents or assigns.

Jurat:

DARRELL JAMES HILL
Without Prejudice

Darrell-James Hill, A.R.
Darrell-James: Hill: beneficiary, A.R.

Affirmed and autographed before me this 15th day November, 2018 A.D.

Type of Identification: Arizona Driver License

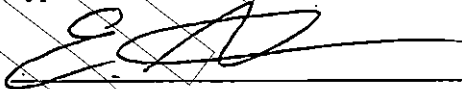

notary

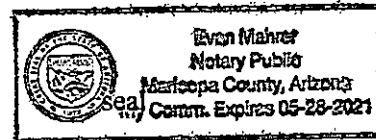

2022-011769 MISC Page: 1009 of 2782
09/26/2022 03:35:37 PM Receipt #: 22-9381
Rec Fee: \$30.00 Darrell James Hill
Gila County, Az, Sadie Jo Bingham, Recorder



APACHE JUNCTION
151 W SUPERSTITION BLVD
APACHE JUNCTION
AZ

85120-9998
0302590130

11/15/2018 (800)275-8777 12:00 PM

Product Description	Sale Qty	Final Price
---------------------	----------	-------------

First-Class Mail Letter	1	\$0.50
-------------------------	---	--------

(Domestic)
(OGDEN, UT 84201)
(Weight: 0 Lb 0.40 Oz)
(Estimated Delivery Date)
(Monday 11/19/2018)

Certified	1	\$3.45
-----------	---	--------

(@USPS Certified Mail #)
(70180360000059688904)

Return Receipt	1	\$2.75
----------------	---	--------

(@USPS Return Receipt #)
(9590940238528032532432)

First-Class Mail Letter	1	\$0.50
-------------------------	---	--------

(Domestic)
(OGDEN, UT 84201)
(Weight: 0 Lb 0.30 Oz)
(Estimated Delivery Date)
(Monday 11/19/2018)

Certified	1	\$3.45
-----------	---	--------

(@USPS Certified Mail #)
(70180360000059692949)

Return Receipt	1	\$2.75
----------------	---	--------

(@USPS Return Receipt #)
(9590940238528032532449)

Total \$13.40

Cash Change \$50.00 (\$36.60)

Text your tracking number to 28777

U.S. Postal Service
CERTIFIED MAIL® RECEIPT
Domestic Mail Only

For delivery information, visit our website at www.usps.com

OGDEN OFFICIAL USE

Certified Mail Fee \$3.45
Extra Services & Fees (check box, add fee as appropriate)
 Return Receipt (hardcopy) \$0.00
 Return Receipt (electronic) \$0.00
 Certified Mail Restricted Delivery \$0.00
 Adult Signature Required \$0.00
 Adult Signature Restricted Delivery \$0.00

0130
06

Postmark Here

Postage \$0.50
Total Postage and Fees \$6.70

11/15/2018

Sent To
Street and Apt. No., or PO Box Internal Revenue Service Center
Ogden, Utah 84201-0002
City, State, ZIP+4®

PS Form 3800, April 2015 PSN 7530-02-000-9047 See Reverse for Instructions

U.S. Postal Service
CERTIFIED MAIL® RECEIPT
Domestic Mail Only

For delivery information, visit our website at www.usps.com

OGDEN OFFICIAL USE

Certified Mail Fee \$3.45
Extra Services & Fees (check box, add fee as appropriate)
 Return Receipt (hardcopy) \$0.00
 Return Receipt (electronic) \$0.00
 Certified Mail Restricted Delivery \$0.00
 Adult Signature Required \$0.00
 Adult Signature Restricted Delivery \$0.00

0130
06

Postmark Here

Postage \$0.50
Total Postage and Fees \$6.70

11/15/2018

Sent To
Street and Apt. No., or PO Internal Revenue Service Center
Ogden, Utah 84201-0002
City, State, ZIP+4®

PS Form 3800, April 2015 PSN 7530-02-000-9047 See Reverse for Instructions

SENDER: COMPLETE THIS SECTION

- Complete items 1, 2, and 3.
- Print your name and address on the reverse so that we can return the card to you.
- Attach this card to the back of the mailpiece, or on the front if space permits.

1. Article Addressed to:

Internal Revenue Service Center
Ogden, Utah 84201-0002



9590 9402 3852 8032 5324 32

2. Article Number (Transfer from service label)

7018 0360 0000 5968 8904

COMPLETE THIS SECTION ON DELIVERY

A. Signature Agent Addressee

X B. Received by (Printed Name) C. Date of Delivery

D. Is delivery address different from item 1? Yes No
If YES, enter delivery address below.

3. Service Type
- Adult Signature
 - Adult Signature Restricted Delivery
 - Certified Mail®
 - Certified Mail Restricted Delivery
 - Collect on Delivery
 - Collect on Delivery Restricted Delivery
 - Priority Mail Express®
 - Registered Mail™
 - Registered Mail Restricted Delivery
 - Return Receipt for Merchandise
 - Signature Confirmation™
 - Signature Confirmation Restricted Delivery

PS Form 3811, July 2015 PSN 7530-02-000-9053

2022-011769 MISC Page: 1010 of 2782

09/26/2022 03:35:37 PM Receipt #: 22-9381
Rec Fee: \$30.00 Darrell James Hill
Gila County, Az, Sadie Jo Bingham, Recorder



Notice: Revocation of the Internal-Revenue-Service Power of the Attorney

:Beverly-Jean: Romero- Hill, A.R.
c/o BEVERLY JEAN ROMERO- HILL
PO Box 3806
Apache Junction, Arizona 85117

Internal Revenue Service Center
Ogden, Utah 84201-0002

USPS 7018 0360 0000 5969 2949

Arizona State
Pinal County

Notice: Revocation of the Internal Revenue Service Power of the Attorney

Notice to the agent is notice to the principal, Greetings:

i: man am :Beverly-Jean: Romero- Hill © ® TM 1958: New Mexican: beneficiary and Authorized Representative of the 1) inherent-trust from the Almighty God where nothing stands between the Almighty God and i; and: 2) principal, subrogee and Authorized Representative for the subrogation named: BEVERLY JEAN ROMERO-HILL~et al. derivatives with the [REDACTED]-Social-Security-Numbers from the United States government-trustee~service-provider and subrogor. And:

- 1 For the any Internal-Revenue-Service power or authority granted and/or presumed under the any power-of-attorney for the affairs of the man: Beverly-Jean: Romero- Hill: beneficiary and A.R. by/with the subrogation: BEVERLY JEAN ROMERO- HILL~et al. derivatives with the [REDACTED]-Social-Security-Numbers is now revoked.
- 2 i: Beverly-Jean: Romero- Hill, A.R., now revoke and withdraw all of the Internal-Revenue-Service power or authority granted and/or presumed to act in any matter by/with the subrogation: BEVERLY JEAN ROMERO-HILL~et al. derivatives with the [REDACTED]-Social-Security-Numbers as an attorney-in-fact for: i.
- 3 Whereupon after the 10 days of a silence in the response to this absolute restriction by :Beverly-Jean: Romero-Hill: beneficiary and A.R. of the subrogation: BEVERLY JEAN ROMERO- HILL~et al. derivatives with the [REDACTED]-Social-Security-Numbers then: Notice: Revocation of the Internal-Revenue-Service power of the attorney is: Internal Revenue Service-agreement by the tacit-acquiescence with the tacit-procuration for the payment by the fee-schedule-agreement for the violation of this absolute-revocation-agreement.

For the fee-schedule-agreement with the violation of this revocation-agreement is: a) one U.S. silver dollar in the specie per the minute-unit of the time from the receipt of this document unto the resolve of this matter; and: b) payment-due-now upon the presentment of a request for the any period of the payment-now-due by the undersigned and: heirs, agents or assigns.

Jurat:

BEVERLY JEAN ROMERO- HILL
Without Prejudice

Beverly-Jean Romero Hill, A.R.
:Beverly-Jean: Romero- Hill: beneficiary, A.R.

Affirmed and autographed before me this 15th day November, 2018 A.D.

Type of Identification: Arizona Driver License

[Signature]
notary

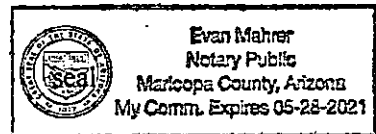

APACHE JUNCTION
151 W SUPERSTITION BLVD
APACHE JUNCTION
AZ

85120-9998
0302590130

11/15/2018 (800)275-8777 12:00 PM

Product Description	Sale Qty	Final Price
---------------------	----------	-------------

First-Class Mail Letter	1	\$0.50
-------------------------	---	--------

(Domestic)
(OGDEN, UT 84201)
(Weight: 0 Lb 0.40 Oz)
(Estimated Delivery Date)
(Monday 11/19/2018)

Certified	1	\$3.45
-----------	---	--------

(@USPS Certified Mail #)
(70180360000059688904)

Return Receipt	1	\$2.75
----------------	---	--------

(@USPS Return Receipt #)
(9590940238528032532432)

First-Class Mail Letter	1	\$0.50
-------------------------	---	--------

(Domestic)
(OGDEN, UT 84201)
(Weight: 0 Lb 0.30 Oz)
(Estimated Delivery Date)
(Monday 11/19/2018)

Certified	1	\$3.45
-----------	---	--------

(@USPS Certified Mail #)
(70180360000059692949)

Return Receipt	1	\$2.75
----------------	---	--------

(@USPS Return Receipt #)
(9590940238528032532449)

Total \$13.40

Cash \$50.00

Change (\$36.60)

Text your tracking number to 28777

(@USPS) to get the latest status

U.S. Postal Service
CERTIFIED MAIL® RECEIPT
Domestic Mail Only

For delivery information, visit our website at www.usps.com

OGDEN UT 84201
OFFICIAL USE

Certified Mail Fee	\$3.45	0130 06 Postmark Here
Extra Services & Fees (check box, add fee as appropriate)	\$7.75	
<input type="checkbox"/> Return Receipt (hardcopy)	\$0.00	
<input type="checkbox"/> Return Receipt (electronic)	\$0.00	
<input type="checkbox"/> Certified Mail Restricted Delivery	\$0.00	
<input type="checkbox"/> Adult Signature Required	\$0.00	11/15/2018
<input type="checkbox"/> Adult Signature Restricted Delivery	\$0.00	
Postage	\$0.50	Sent To
Total Postage and Fees	\$6.70	
Street and Apt. No., or P.O. Box Internal Revenue Service Center Ogden, Utah 84201-0002		
City, State, ZIP+4®		

PS Form 3800, April 2015 PSN 7530-02-000-9047 See Reverse for Instructions

U.S. Postal Service
CERTIFIED MAIL® RECEIPT
Domestic Mail Only

For delivery information, visit our website at www.usps.com

OGDEN UT 84201
OFFICIAL USE

Certified Mail Fee	\$3.45	0130 06 Postmark Here
Extra Services & Fees (check box, add fee as appropriate)	\$7.75	
<input type="checkbox"/> Return Receipt (hardcopy)	\$0.00	
<input type="checkbox"/> Return Receipt (electronic)	\$0.00	
<input type="checkbox"/> Certified Mail Restricted Delivery	\$0.00	
<input type="checkbox"/> Adult Signature Required	\$0.00	11/15/2018
<input type="checkbox"/> Adult Signature Restricted Delivery	\$0.00	
Postage	\$0.50	Sent To
Total Postage and Fees	\$6.70	
Street and Apt. No., or P.O. Box Internal Revenue Service Center Ogden, Utah 84201-0002		
City, State, ZIP+4®		

PS Form 3800, April 2015 PSN 7530-02-000-9047 See Reverse for Instructions

SENDER: COMPLETE THIS SECTION

- Complete items 1, 2, and 3.
- Print your name and address on the reverse so that we can return the card to you.
- Attach this card to the back of the mailpiece, or on the front if space permits.

1. Article Addressed to:

Internal Revenue Service Center
Ogden, Utah 84201-0002

9590 9402 3852 8032 5324 49

2. Article Number (Transfer from service label)

7018 0360 0000 5969 2949

PS Form 3811, July 2015 PSN 7530-02-000-9053

COMPLETE THIS SECTION ON DELIVERY

A. Signature Agent Addressee

B. Received by (Printed Name) _____ Date of Delivery _____

D. Is delivery address different from item 1? Yes No
If YES, enter delivery address below: _____

3. Service Type

<input type="checkbox"/> Adult Signature	<input type="checkbox"/> Priority Mail Express®
<input type="checkbox"/> Adult Signature Restricted Delivery	<input type="checkbox"/> Registered Mail™
<input checked="" type="checkbox"/> Certified Mail®	<input type="checkbox"/> Registered Mail Restricted Delivery
<input type="checkbox"/> Certified Mail Restricted Delivery	<input type="checkbox"/> Return Receipt for Merchandise
<input type="checkbox"/> Collect on Delivery	<input type="checkbox"/> Signature Confirmation™
<input type="checkbox"/> Collect on Delivery Restricted Delivery	<input type="checkbox"/> Signature Confirmation Restricted Delivery

NOV 27 2018
OGDEN, UT

Domestic Return Receipt

2022-011769 MISC Page: 1012 of 2782
09/26/2022 03:35:37 PM Receipt #: 22-9981
Rec Fee: \$30.00 Darrell James Hill
Gila County, Az, Sadie Jo Bingham, Recorder

1009

7018 0360 0000 5969 2956

BEVERLY JEAN ROMERO- HILL
c/o Beverly-Jean: Romero- Hill, A.R.
PO Box 3806
Apache Junction, Arizona 85119

Bureau of the Fiscal Service
Treasury Retail Securities Site
PO Box 9150
Minneapolis, Minnesota 55480

Re: See attached Sheet

To whom it may concern:

Thank you for the November 9th, 2018 response. I was wondering about the rumors of the birth certificate and the SSA number birthright stuff, so I asked about it. I suggest you make a public declaration about it and explain it to everyone. Otherwise, more people are going to be writing formally inquiring about/for the truth as I did.

Now that I, Beverly-Jean: Romero- Hill have been identified per the verified request, please open the primary TreasuryDirect Account per the request that I may freely purchase United States Savings Bonds, Treasury Bills, Treasury Notes and Treasury Bonds from my personal checking or savings account where I conduct banking business.

Without Prejudice
BEVERLY JEAN ROMERO- HILL

Autographed: 22nd November 2018:

Beverly Jean Romero Hill, A.R.
Beverly-Jean: Romero- Hill, A.R.

~~1010~~
1010

2022-011769 MISC Page: 1013 of 2782
 09/26/2022 03:35:37 PM Receipt #: 22-9381
 Rec Fee: \$30.00 Darrell James Hill
 Gila County, Az, Sadie Jo Bingham, Recorder



USPS CMN 7018 0360 0000 5969 2956

:Darrell-James: Hill c/o: PO Box 3806, Apache Junction, Arizona 85117

Bureau of the Fiscal Service
c/o Treasury Retail Securities Site
PO Box 9150
Minneapolis, Minnesota 55480

Re: Case#: 1-3479183059

USPS CMN 7018 0360 0000 5968 8898

Hello:

You stated in your November 7th 2018 letter in the response to my FS Form 5444 with the social security number: [REDACTED], that: the social security number: [REDACTED] is unassociated with a minor account for me. – Is this correct?

It is my understanding that all people born as Ohio state nationals and receiving a 'birth certificate', et seq. have a minor account established for them. – Is this correct in my case?

Has there ever been a minor account for me with the social security number: [REDACTED]

– If so, what happened to that account?

I do not comprehend/understand how or why no minor account was located for me under the social security number: [REDACTED] And,

Please, help me comprehend the minor accounts:

1. Who creates the minor accounts for the people?
2. Are minor accounts established for all of the people born as an Ohio state national and provided a birth certificate, et seq.?
3. Could there exist another minor account established for me by a different social security number & other numbers: e.g. birth certificate number?
4. If a minor account for me by some other designation exists then what is your procedure for appropriately verifying that minor account?

Sincerely,

Without prejudice,
DARRELL JAMES HILL

Darrell James Hill A.R.

Autographed this 17th day December: 2018

:Darrell-James: Hill :beneficiary and A.R. of:
subrogation: DARRELL JAMES HILL –
1958.

1011
2022-011769 MISC Page: 1014 of 2782
09/26/2022 03:35:37 PM Receipt #: 22-9381
Rec Fee: \$30.00 Darrell James Hill
Gila County, Az, Sadie Jo Bingham, Recorder

7018 0360 0000 5968 8898

U.S. Postal Service™
CERTIFIED MAIL® RECEIPT
Domestic Mail Only

*For delivery information, visit our website at www.usps.com®.

MINNEAPOLIS, MN 55480
OFFICIAL USE

Certified Mail Fee	\$3.45
Extra Services & Fees (check box, add fee as appropriate)	\$0.00
<input type="checkbox"/> Return Receipt (hardcopy)	\$0.00
<input type="checkbox"/> Return Receipt (electronic)	\$0.00
<input type="checkbox"/> Certified Mail Restricted Delivery	\$0.00
<input type="checkbox"/> Adult Signature Required	\$0.00
<input type="checkbox"/> Adult Signature Restricted Delivery	\$0.00
Postage	\$0.50
Total Postage and Fees	\$3.95

0130

Postmark Here

12/19/2018

Sent To

Bureau of the Fiscal Service
 c/o Treasury Retail Securities Site
 PO Box 9150
 Minneapolis, Minnesota 55480

Street and Apt. No., or PO Box

City, State, ZIP+4®

PS Form 3800, April 2015 PSN 7530-02-000-9047 See Reverse for Instructions

9598 995 0000 090 9108

APACHE JUNCTION
 151 W SUPERSTITION BLVD
 APACHE JUNCTION
 AZ
 85120-9998
 0302590130
 12/19/2018 (800)275-8777 10:43 AM

Product Description	Qty	Final Price
First-Class Mail Letter	1	\$0.50

(Domestic)
 (MINNEAPOLIS, MN 55480)
 (Weight: 0 Lb 0.60 Oz)
 (Estimated Delivery Date)
 (Saturday 12/22/2018)

Certified 1 \$3.45
 (@@USPS Certified Mail #)
 (7012036000005968898)

Affixed Postage 1 (\$0.50)
 (Affixed Amount: \$0.50)

Total \$3.45

Cash \$3.50
 Change (\$0.05)

Text your tracking number to 28777 (2USPS) to get the latest status. Standard Message and Data rates may apply. You may also visit www.usps.com USPS Tracking or call 1-800-222-1811.

In a hurry? Self-service kiosks offer quick and easy check-out. Any Retail Associate can show you how.

Preview your Mail
 Track your Packages
 Sign up for FREE @
www.informedeelivery.com

Official Use

1012



:2019 A.D.

#	:man- trustee	:association	:year, :day	USPO, other	:covenant
1	:man	:U.S.-Corp.- :Government of the United-States of 1933-, 2003 A.D.- self-Indenture: EBA-1933-A.D. -:GoftUS-1933-A.D, :GoftUS-:2003-A.D.:GoftUS-1933-A.D., -:2003-A.D. -:Trustee	06/07/19	RE 322 404 075 US ✓	:Beverly-Jean: Romero- Hill, -:notice-of-claim: - :Verification of the Known-Birth/Berth-Statuses; :Verification of the Civilian-Status
2	:man	:U.S.-Corp.- :Government of the United-States of 1933-, 2003 A.D.- self-Indenture: EBA-1933-A.D. ~:GoftUS-1933-A.D, :GoftUS-:2003-A.D, :GoftUS-1933-A.D., -:2003-A.D. -:Trustee	06/07/19	RE 322 404 067 US ✓	:Darrell-James: Hill, -:notice-of-claim: - :Verification of the Known-Birth/Berth-Statuses; :Verification of the Civilian-Status
3	:man; :Dominic: Stewart; :Berenisse: Romero	:Wells-Fargo, Bank, N.A.; personal-banker; bank-manager.	06/11/19	Claim: Unlawful-denial of Signature-Guarantee for: Exempted-Security: June 2019	:Securities Act of 1933 ~ appended.
4	:man	:U.S.- Corp.- :GoftUS-:2003-A.D, :GoftUS-1933-A.D.,	06/14/19	:2019-1158-001 - RE 322 404 067 US ✓	:Demand-Equity-Promissory-Note ~DEN~: Darrell-James: Hill -Ohioan-beneficiary: DOI-1776-A.D., et seq., -:beneficiary-Executor: EBA-1933-A.D. -

1013

2022-011769 MISC Page: 1016 of 2782
 09/26/2022 08:35:37 PM Receipt #: 22-9381
 Rec Fee: \$30.00 Darrell James Hill
 Gila County, Az; Sadie Jo Bingham, Recorder



		:2003-A.D. -:Trustee, to -:Bank-of-the-West: BNP- Paribas			48 Stat. L.1, and 40 Stat. L. 411, and 48 Stat. L. 881, and 61 Stat., Chap. 388; RE 322 404 067 US .		
5	:man	:GoftUS-2003-A.D., -:Trustee, to -:Bank-of-the- West: BNP- Paribas	06/14/19	:2019-0658-001 - RE 322 404 075 US ✓	:Demand-Equity-Promissory-Note: Beverly-Jean: Romero- Hill- New-Mexican: DOI-1776-A.D., et seq., -:beneficiary-Executor: EBA-1933-A.D. - 48 Stat. L.1, and 40 Stat. L. 411, and 48 Stat. L. 881, and 61 Stat., Chap. 388; RE 322 404 067 US .		
6	:man	:U.S.-Corp.- :GoftUS-1933, -:2003-A.D. -:Trustee, to -:Federal-Reserve-Act of 12/13/1913 ~FRA-1213- A.D.~ -:Federal-Reserve- Bank, -:Trustee	06/14/19	38 Stat. 251, Pub. Law 63-43 ✓	:U.S.-Corp.- :GoftUS-1933-A.D., -:2003-A.D., -:FRA- 1913-A.D.		
7	:man	:U.S.-Corp.- :GoftUS-1933, -:2003-A.D. -:Trustee, to -:Title 1-General provisions of 1947	06/14/19	61 Stat., Chap. 388 ~ 61. Stat. 633. ✓	:General- Provisions- 1947, appended, p. 633- 664.		
8							
		:man- trustee		:association	:year, :day	USPO, other	:covenant
9	:man	:GoftUS-1933-A.D., -:2003- A.D. -:Trustee to: Securites Act of 1933 ~SA-1933- A.D.~ et seq.-: :Security Exchange Act of 1934	06/14/19	48 Stat. 74, Pub Law 73- 22, -:SA-1933-A.D. ✓	:Securities Act of 1933 ~ appended. 48 Stat. 881, Pub. Law 73-291 ~SEA-1934-A.D.~		

2022-011769 MISC Page: 1017 of 2782

09/26/2022 03:35:37 PM Receipt #: 22-9981

James Hill Darrell Jo Bingham, Recorder

Rec Fee: \$30.00 Gila County, Az, Sadie Jo



1014

~SEA-1934-A.D.~

10 :William-P.: Barr, U.S. :AG -APC -CLT 06/27/19 RE 322 404 084 US ✓

:Alien-Property-Custodian -APC~ Notices: Agreement: Civillian-Status, for -:Darrell-James: Hill and Beverly-Jean: Romero- Hill, -:appendices: Beverly-Jean: Romero- Hill- New-Mexican-beneficiary-Executor: DOI-1776-A.D., -:beneficiary-Executor: EBA-1933-A.D.-verified, -:Civillian; and, :Darrell-James: Hill- Ohioan-beneficiary-Executor: DOI-1776-A.D., -:beneficiary-Executor: EBA-1933-A.D.-verified, -:Civillian.

11 :Donald: Trump cc: POTUS 06/27/19 RE 322 404 098 US ✓

:Alien-Property-Custodian -APC~ Notices: Agreement: Civillian-Status, for -:Darrell-James: Hill and Beverly-Jean: Romero- Hill, -:appendices: Beverly-Jean: Romero- Hill- New-Mexican-beneficiary-Executor: DOI-1776-A.D., -:beneficiary-Executor: EBA-1933-A.D.-verified, -:Civillian; and, :Darrell-James: Hill- Ohioan-beneficiary-Executor: DOI-1776-A.D., -:beneficiary-Executor: EBA-1933-A.D.-verified, -:Civillian.

Notice of claim

RE 322 404 075 US

	:man- trustee	:association	:year, :day	USPO, other	:covenant
12	:Mary-C.: Daly	Federal-Reserve-Bank: San-Francisco, :President	06/11/19	RE 322 404 067 US	:Darrell-James: Hill- Ohioan-beneficiary-Executor: DOI-1776-A.D., -:beneficiary-Executor: EBA-1933-A.D.-verified, -:Civillian, -:Claimant: Deprivation-of-Right by the BNP-Paribas-BOTW- Phoenix.

1015



13 :Nandita: Bakhshi :Bank of the West: 06/12/19 cc: RE 322 404 067 US. ✓
 President and CEO; Co- 7018 0360 0000 5968 6122
 Chief- Executive-Officer;
 BNP-Paribas: USA, Inc.

14 :Raj: Gopal :Sr.- Exec-V-P and Chief- 06/12/19
 Risk-Officer cc: RE 322 404 067 US. - ✓
 7018 0360 0000 5968 6122

:Beverly-Jean: Romero- Hill- New-Mexican-beneficiary-
 Executor: DOI-1776-A.D., -:beneficiary-Executor: EBA-
 1933-A.D.- verified, -:Civillian, -:Claimant: Deprivation
 of-Right by the BNP-Paribas-BOTW- Phoenix

:Darrell-James: Hill- Ohioan-beneficiary-Executor: DC
 1776-A.D., -:beneficiary-Executor: EBA-1933-A.D.-
 verified, -:Civillian, -:Claimant: Deprivation-of-Right by
 the BNP-Paribas-BOTW- Phoenix.

:Beverly-Jean: Romero- Hill- New-Mexican-beneficiary-
 Executor: DOI-1776-A.D., -:beneficiary-Executor: EBA-
 1933-A.D.- verified, -:Civillian, -:Claimant: Deprivation-
 of-Right by the BNP-Paribas-BOTW- Phoenix

:man- trustee	:association	:year, :day	USPO, other
15 :Donald: Trump	POTUS	07/25/19	cc: RE 322 404 067 US. - ✓ RE 322 404 212 US ✓ :Documents redress the :United States EBA-1933- 2003-A.D. indenture -naked- legislature-Trust.

:Darrell-James: Hill- Ohioan-beneficiary-Executor: DOI-
 1776-A.D., -:beneficiary-Executor: EBA-1933-A.D.-
 verified, -:Civillian, -:Claimant: Deprivation-of-Right by
 the BNP-Paribas-BOTW- Phoenix. - :i- man .. require
that you- trustees... release all-property.

2022-011769 MISC Page: 1019 of 2782
 09/26/2022 03:35:37 PM Receipt #: 22-9381
 Rec Fee: \$30.00 Darrell James Hill
 Gila County, AZ, Sadie Jo Blingham, Recorder



1016

	:man- trustee	:association	:year, :day	USPO, other	:covenant
16	:William-P.: Barr	US – AG, APC, CLT	07/25/19	↓ cc: RE 322 404 067 US. – RE 322 404 107 US ✓ :Documents redress the :United States EBA-1933- 2003-A.D. indenture -naked- legislature- Trust.	↓ :Darrell-James: Hill- Ohioan-beneficiary-Executor: DO 1776-A.D., -:beneficiary-Executor: EBA-1933-A.D.- verified, -:Civillian, -:Claimant: Deprivation- of-Right by the BNP-Paribas-BOTW- Phoenix – :i- man .. require that you- trustees... release all-property.
17	:Mary-C.: Daly	Federal-Reserve-Bank: San-Francisco, -:President	07/25/19	cc: RE 322 404 212 US ✓ 7009 2820 0003 9570 8031	:Beverly-Jean: Romero- Hill- New-Mexican-beneficiary Executor: DOI-1776-A.D., -:beneficiary-Executor: EBA- 1933-A.D.- verified, -:Civillian, -:Claimant: Deprivation- of-Right by the BNP-Paribas-BOTW- Phoenix – :i- man .. require that you- trustees... release all-property. :Claim to the Trustees: Donald:Trump, :Obligor : RE 322 404 212 US and William-P.: Barr, US- AG, APC, CLT, :Obligor: RE 322 404 107 US as relates to the DEN to you: Mary-G.: USPO RMN: RE 322 404 067 US -sent to -:YOU: 07/11/19.
18	:Stephen-F.: McCarville	:Pinal-County-Arizona- State, -:Superior-Court, -:Judge	08/01/19	RE 322 404 115 US ✓	:Right-of-Consusane. The commercial-court now being imposed upon the man- Jay-Roy: Ingold in my observation is wrong-doing. The :Court-of-Record with



1017

the trial-by-jury to-hear and try the matter of the fact and in the law is the- :only-righteous-means to-safeguard the good-faith-duty to the man- Jay-Roy: Ingold, et al., and specifically, :- man- Darrell-James: Hill, et al., ...[] in the accordance with the Ingold-Pinal-2017-A.D. -covenant.

19 :Todd: House Pinal-County-Arizona-State, -:Board-Supervisor 08/02/19 cc: RE 322 404 115 US ✓ RE 322 404 209 US ✓

:Right-of-Conusance. → Ingold-Pinal-2017-A.D. - covenant- agreement

20 :Steve: Miller Pinal-County-Arizona-State, -:Board-Supervisor 08/02/19 ↓

21 :Pete: Rios Pinal-County-Arizona-State, -:Board-Supervisor 08/02/19 ↓

22 :Mike: Goodman Pinal-County-Arizona-State, -:Board-Supervisor 08/02/19 RE 322 404 209 US ✓

:Right-of-Conusance. → Ingold-Pinal-2017-A.D. - covenant- agreement

:man- trustee

:association

:year, :day

USPO, other

:covenant

23 :Anthony: Smith Pinal-County-Arizona-State, -:Board-Supervisor 08/02/19 ↓

24 :Natasha: Kennedy Pinal-County-Arizona-State, -:Board-Clerk ↓ RE 322 404 209 US ✓

:Right-of-Conusance. → Ingold-Pinal-2017-A.D. - covenant- agreement

25 :Kent: Volkmer Pinal-County-Arizona-State, -:Board-Clerk ↓ ↓

2022-011769 MISC Page: 1021 of 2782

09/26/2022 03:35:37 PM Receipt #: 22-9381

James Hill, Darrell, Recorder

Gila County, Az, Sadie Jo Bingham, Recorder



1018

26	:Kevin-D.: White	:Pinal-County-Arizona- State, -:Superior-Court, -:Judge	08/02/19	RE 322 404 209 US	:Right-of-Conusance. → covenant- agreement	↓ Ingold-Pinal-2017-A.D. -
27	:Jason-R.: Holmberg	:Pinal-County-Arizona- State, -:Superior-Court, -:Judge	↓	↓		
28	:Mark-A.: Milley	USofA-1787-A.D.- military, -:General	↓	↓		↓
	:man- trustee	:association	:year, :day	USPO, other		:covenant
29	:John: Hyten	USofA-1787-A.D.- military, -:General	02/28/18	RE 322 404 209 US	:Right-of-Conusance. → covenant- agreement	↓ Ingold-Pinal-2017-A.D. -
30	:David-H.: Berger	USofA-1787-A.D.- military, -:General	↓	↓		↓
31	:Joseph-M.: Martin	USofA-1787-A.D.- military, -:Lt. -General	↓	↓		↓
32	:David-L.: Goldfein	USofA-1787-A.D.- military, -:general	↓ 08/28	↓ RE 322 404 209 US	:Right-of-Conusance. → covenant- agreement	↓ Ingold-Pinal-2017-A.D. -
	:man- trustee	:association	:year, :day	USPO, other		:covenant
33						

2022-011759 MISC Page: 1022 of 2782
 09/26/2022 03:35:37 PM Receipt #: 22-9981
 James Hill
 Darrell J. Bingham, Recorder
 Rec Fee: \$30.00
 Gila County, Az



1619

34	:Sadie-Jo: Bingham	Gila-County-Arizona-State-Recorder	10/29/19	Gila-County-Recorder-Doc.#: 2019-009291	:Affidavit: Proof-of-Claims – August- 2019; related to: Gila-County-Recorder-Doc.##: 2017-002378; 2017-006522; 2018-005176
34	:Mark: Lamb	:Pinal-County-Arizona-State, -:Sheriff	08/30/19	7008 1300 0002 2256 4712 with -:RE 322 404 169 US	:Statement-of-Claim -: RE 322 404 169 US -:Ingold-Pinal-2017-A.D.-Covenant- Debt-Notice: Render of -:Bill, -:demand for the payment.
35	:Sadie-Jo: Bingham	Gila-County-Arizona-State-Recorder	10/29/19	Gila-County-Recorder-Doc.#: 2019-011722	:Affidavit: Proof-of-Claims – August- 2019; related to: Gila-County-Recorder-Doc.##: 2017-002378; 2017-006522; 2018-005176

2022-011769 MISC Page: 1023 of 2762
 09/26/2022 03:35:37 PM Receipt #: 22-9981
 Rec Fee: \$30.00 Darrell James Hill
 Gila County, Az, Sadie Jo Bingham, Recorder

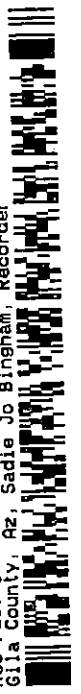

Ingold Pinal

1020

:Demand- :Equity Note: 2019-1158-001 - RE 322 404 067 US-

Tender in terms of: 48 STAT. L. 1 - the Emergency Banking Act of 1933 - §§1, 2, 3, 401, 403; 40 STAT. L. 411 - Trading With The Enemy Act - 1917, § 9; 48 STAT. L. 881 - Securities Act, SEA, of 1934, §§ 2(1), 3(a), et seq., and 12(A) as relates to 42(A), 61 STAT. 388 - General Provisions, § 112; and: RE 322 404 067 US^{1, 2}

This Demand Note was issued at:
Apache Junction, Arizona
Date: June 14th, 2019

AMOUNT: \$10,000,000.00
AMOUNT: TEN MILLION UNITED STATES DOLLARS
*******USD**

This Certifies that:

I: DARRELL JAMES HILL, ID/Account Number: [REDACTED] issuer, certify and authorize the **UNITED STATES government Trustee³** to issue to the **BANK OF THE WEST: BNP - PARIBAS** (HOLDER) the full amount specified on this Note, for value of the services as required, received, and agreed.

Terms & Conditions

The payment of the described account is by the direct exercise of the right to the obligation on the United States government Trustee upon the demand by the HOLDER, at the **Bank of Bank of the West - BNP Paribas :2555 E. Camelback Rd., Suite 160, Phoenix, Arizona 85016**, and/or HOLDER IN DUE COURSE of this Demand Note, to use this Note. - I hereby give permission to the HOLDER and/or THE HOLDER IN DUE COURSE of this Demand Note to use this NOTE in any way necessary as a negotiable instrument to be financially traded on; whereas such trade shall be made with the issuer's permission for the directed-payment demand-obligation upon the United States government Trustee herein.

COPY

Without prejudice,

Darrell James Hill, AR

:Darrell-James: Hill⁴, Executor :beneficiary

JURAT

Sworn to and autographed before me now on this ___ day: June: 2019.
Produced Identification: type: Arizona Driver License.

Notary

Seal

- 1 :Demand :Equity Note : 2019-1158-001 - RE 322 404 067 US - with notices of the claims attached: 3 claims: 8 pages.
- 2 Appended: a) Notice of Claim: RE 322 404 067 US: Verification of the Known Birth/Berth Statuses: man: Darrell-James Hill - four (4) pages; b) Notice of Claim: RE 322 404 067 US: Verification of the Civilian Status: man: Darrell-James: Hill - one (1) page; and: c) notice of Claim: Denial of Signature Guarantee for: Exempted Security: June 2019: Wells Fargo, Bank, N.A., Personnel at the MAC S3913-011 ~Apache Junction, Arizona~ ,with: Stated Corroboration of: Wells Fargo Bank's Resolution Department and Legal Department - three (3) pages.
- 3 United States government Trustee exempted-security: SEA-1934 §
- 4 Gila county, Arizona: Recorder. Doc ##: 2017_002378 - Affidavit: Statement of Claim (Civilly a Live-Life); and: # 2017_006522 - Af

2022-011769 MISC Page: 1024 of 2782
09/26/2022 03:35:37 PM Receipt #: 22-9381
Rec Fee: \$30.00 Darrell James Hill
Gila County, Az, Sadie Jo Bingham, Recorder



1021

Notice of Claim: USPS RMN~ RE 322 404 067 US:

Verification of the Known Birth/Berth Statuses: man: Darrell-James: Hill

Arizona state
Pinal county

:Man :Darrell- James: Hill personally presents before me, the undersigned Notary duly authorized by the laws of Arizona to administer oaths; now on this 7th day: June: 2019, being by me first duly sworn on his affirmation, claimant deposes and says:

:i- man of the family Hill am a) :Darrell-James (given-name)-beneficiary, and :owner of the property (a) :inherent-trust by the Almighty-God and (b): beneficiary -subrogee -in the idem sonans- trust by the subrogor: UNITED-STATES-government- Trustee as established and presented within the riveted- certified- instrument ~Not-altered-authentication~ attached (3 pages): p. 1/3 (at the bottom): certified- document: OHIO DEPARTMENT OF HEALTH~ DIVISION OF VITAL STATISTICS~ CERTIFICATE OF LIVE BIRTH -Birth No. 134 - 58 - 20881: document number F4012640; and: p. 2/3 :certification~ of~ authenticity by the United States of America~ State of Ohio~ Office of the Secretary of State- C074912; and: p. 3/3: with the 18047749-2~ United States of America~ [emblem] DEPARTMENT OF STATE.

Claim

:i -man am :Darrell-James: Hill, by the known presents: 1958~A.D- November~20th -Ohioan-birth of :i ~wherefrom and throughout the eternity nothing exists between :i -man and Almighty God, and by the known-presents: 1958-November-28 -OHIOAN-berth in the idem~sonans of the subrogation: DARRELL JAMES HILL. - AND :i- man am :soul-beneficiary :sui juris :Authorized Representative/~Executor of (A) the inherent trust by Almighty-God and (B) of the subrogee- trust by the UNITED STATES government-services-Trustee as established and presented by the within- riveted- certified- instrument;

:i- man verify that all stated herein is true and correct and will state same onto the record in the open court.

Without prejudice:

Autographed this 7th day June 2019 A.D.

Darrell James Hill A.R
:Darrell-James: Hill, :beneficiary, Executor



JURAT

Sworn to and subscribed before me now on this 7th day: June: 2019.
Produced identification: type: Arizona Driver License.

Dominic Stewart
Notary

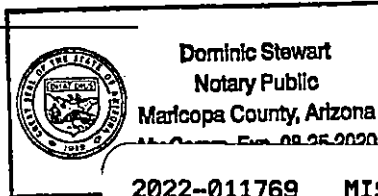

seal

2022-011769 MISC Page: 1025 of 2782
09/26/2022 03:35:37 PM Receipt #: 22-9381
Rec Fee: \$30.00 Darrell James Hill
Gila County, Az, Sadie Jo Bingham, Recorder



1072

United States of America



DEPARTMENT OF STATE

To all to whom these presents shall come, Greetings:

I Certify That the document hereunto annexed is under the Seal of the Secretary of State of the State(s) of Ohio, and that such Seal(s) is/are entitled to full faith and credit.*

****For the contents of the annexed document, the Department assumes no responsibility
This certificate is not valid if it is removed or altered in any way whatsoever***

In testimony whereof, I, Michael R. Pompeo, Secretary of State, have hereunto caused the seal of the Department of State to be affixed and my name subscribed by the Assistant Authentication Officer, of the said Department, at the city of Washington, in the District of Columbia, this seventeenth day of July, 2018.

Michael R. Pompeo

Secretary of State

By *Pat O. Hill*

Assistant Authentication Officer

Issued pursuant to CHXIV, State of
Sept. 15, 1789, 1 Stat. 68-69; 22
USC 2657; 22USC 2651a; 5 USC
301; 28 USC 1733 et. seq.; 8 USC
1443(f); RULE 44 Federal Rules of
Civil Procedure.

2022-011769 MISC Page: 1026 of 2782
09/26/2022 03:35:37 PM Receipt #: 22-9381
Rec Fee: \$30.00 Darrell James Hill
Gila County, Az, Sadie Jo Bingham, Recorder



7023

For: Demonstration Purposes Only
Day: June 11, 2019
Autograph: Darrell James Hill



1024

Unofficial Copy

2022-011769 MISC Page: 1027 of 2782
09/26/2022 03:35:37 PM Receipt #: 22-9381
Rec Fee: \$30.00 Darrell James Hill
Gila County, Az, Sadie Jo Bingham, Recorder



United States of America
State of Ohio
Office of the Secretary of State

I, **JON HUSTED**, Secretary of State, do hereby certify that I am the duly elected, qualified and acting Secretary of State of the State of Ohio, and I further certify that

JUDITH B. NAGY

is the duly appointed, State Registrar, Vital Statistics Division, Department of Health, for the State of Ohio. She is the custodian of the records of Vital Statistics, and that she is the proper official to make said attestation, which is in due form; and that her official acts are entitled to full faith and credit.

This certification certifies only the authenticity of the signature of the official who signed the document, the capacity in which that official acted, and where appropriate, the identity of the seal or stamp, which the document bears. This certification does not imply that the contents of the document(s) are correct, nor that they have the approval of this office.

IN TESTIMONY WHEREOF, I have hereunto subscribed my name and affixed the official Seal of the Secretary of State of Ohio, at Columbus, Ohio, this 14th day of June, 2018.

Jon Husted
Jon Husted
Secretary of State

SEC4000 (Rev. 1/11)

1025

2022-011769 MISC Page: 1028 of 2782
09/26/2022 03:35:37 PM Receipt #: 22-9381
Rec Fee: \$30.00 Darrell James Hill
Gila County, Az, Sadie Jo Bingham, Recorder



For: Demonstration Purposes Only
Day: June 11, 2019

Autograph: Darrell James



1026

2022-011769 MISC Page: 1029 of 2782
09/26/2022 03:35:37 PM Receipt #: 22-9381
Rec Fee: \$30.00 Darrell James Hill
Gila County, Az, Sadie Jo Bingham, Recorder



Unofficial Copy

OHIO DEPARTMENT OF HEALTH
DIVISION OF VITAL STATISTICS
CERTIFICATE OF LIVE BIRTH

1. PLACE OF BIRTH CINCINNATI		2. USUAL RESIDENCE OF MOTHER CINCINNATI	
3. CITY, VILLAGE, OR LOCATION CINCINNATI		4. CITY, VILLAGE, OR LOCATION CINCINNATI	
5. NAME OF HOSPITAL OR INFIRMARY CINCINNATI		6. STREET ADDRESS 219 KING ST.	
7. NAME OF BIRTH PARENTS DARRELL HILL		8. NAME OF BIRTH PARENTS CLARENCE HILL	
9. SEX M		10. RACE W	
11. DATE OF BIRTH MAY 9 2018		12. TIME OF BIRTH NOON	
13. WEIGHT 7.5		14. LENGTH 20.0	
15. HEAD CIRCUMFERENCE 34.0		16. HEART RATE 120	
17. AIRWAY OPEN YES		18. BREASTS FEELING GOOD	
19. SIGNATURE <i>[Signature]</i>		20. DATE SIGNED MAY 09 2018	
21. ADDRESS CINCINNATI		22. DATE OF WHICH BIRTH WAS ANNOUNCED MAY 09 2018	

Judith B. Nagy
State Registrar

MAY - 9 2018

[Signature]

2022-011769 MISC Page: 1030 of 2782
09/26/2022 03:35:37 PM Receipt #: 22-9381
Rec Fee: \$30.00 Darrell James Hill
Gila County, Az, Sadie Jo Bingham, Recorder



1027

HEREBY CERTIFY THIS DOCUMENT IS AN EXACT COPY OF THE ORIGINAL

For: Demonstration Purposes Only:
Day: June 11, 2019
Autograph: 



Unofficial Copy

1028

2022-011769 MISC Page: 1031 of 2782
09/26/2022 03:35:37 PM Receipt #: 22-9381
Rec Fee: \$30.00 Darrell James Hill
Gila County, Az, Sadie Jo Bingham, Recorder



Notice of Claim: USPS RMN~ RE 322 404 067 US:

Verification of the Civilian Status: man: Darrell-James: Hill

**Arizona state
Pinal county**

:Man :Darrell- James: Hill personally presents before me, the undersigned Notary duly authorized by the laws of Arizona to administer oaths; now on this 7th day: June: 2019, being by me first duly sworn on his affirmation, claimant deposes and says:

Claim

(A) :i- man of the family Hill am a) :Darrell-James (given-name)-beneficiary, and :owner of the property (a) :inherent-trust by the Almighty-God and (b): beneficiary -subrogee -in the idem sonans- trust by the subrogor: UNITED-STATES-government- Trustee. See: **Notice of Claim: USPS RMN~ RE 322 404 067 US: Verification of the Known Birth/Berth Statuses: man: Darrell-James: Hill** , attached: 4 pages; AND

(B) :i -man am :Darrell-James: Hill, :Ohioan by the known presents and within the regard to the Trading With The Enemy Act of 1917 (49 Stat. L. 411), as amended, am :civilian ~ am-Not :combatant, and am-Not :enemy, and am-Not :ally-of-enemy.

:i- man verify that all stated herein is true and correct and will state same onto the record in the open court.

Without prejudice:

Autographed this 7th day June 2019 A.D.

Darrell-James Hill, H.R.
:Darrell-James: Hill, :beneficiary, Executor

JURAT

Sworn to and subscribed before me now on this 7th day: June: 2019.

Produced identification: type: Arizona Driver License.

Dominic Stewart
Notary

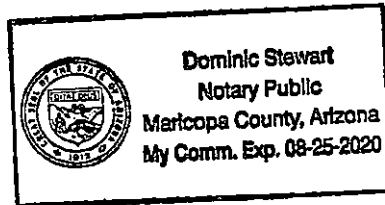

seal

1029

:Demand :Equity Note: 2019-0658-001 - RE 322 404 075 US-

Tender in terms of: 48 STAT. L. 1 - the Emergency Banking Act of 1933 - §§1, 2, 3, 401, 403; 40 STAT. L. 411 - Trading With The Enemy Act -1917, § 9; 48 STAT. L. 881 - Securities Act, SEA, of 1934, §§ 2(1), 3(a), et seq., and 12(A) as relates to 42(A); 61 STAT. 388 - General Provisions. § 112; and: RE 322 404 075 US^{1 2}

This Demand Note was issued at:
Apache Junction, Arizona
Date: June 14th, 2019

AMOUNT: \$10,000,000.00
AMOUNT: TEN MILLION UNITED STATES DOLLARS
*******USD**

This Certifies that:

I: **BEVERLY JEAN ROMERO- HILL**, ID/Account Number: [REDACTED] issuer, certify and authorize the **UNITED STATES government Trustee³** to issue to the **BANK OF THE WEST: BNP - PARIBAS** (HOLDER) the full amount specified on this Note, for value of the services as required, received, and agreed.

Terms & Conditions

The payment of the described account is by the direct exercise of the right to the obligation on the United States government Trustee upon the demand by the HOLDER, at the **Bank of Bank of the West - BNP Paribas :2555 E. Camelback Rd., Suite 160, Phoenix, Arizona 85016**, and/or HOLDER IN DUE COURSE of this Demand Note, to use this Note. - I hereby give permission to the HOLDER and/or THE HOLDER IN DUE COURSE of this Demand Note to use this NOTE in any way necessary as a negotiable instrument to be financially traded on; whereas such trade shall terminate the Issuer's permission for the directed-payment-demand-obligation upon the United States government Trustee herein.

COPY

Without prejudice,

:Beverly-Jean: Romero- Hill⁴, :Executor
:beneficiary

JURAT

Sworn to and subscribed before me now on this ___ day: June: 2019.
Produced Identification: type: Arizona Driver License.

Notary

Seal

- 1 :Demand :Equity Note : 2019-0658-001 - RE 322 404 075 US - with notices of the Claim attached: 2 claims: 5 pages.
- 2 Appended: a) Notice of Claim: RE 322 404 075 US: Verification of the Known Birth/Berth Statuses: man: Beverly-Jean: Romero- Hill - four (4) pages; and: b) Notice of Claim: RE 322 404 075 US: Verification of the Civilian Status: man: Beverly-Jean: Romero- Hill - one (1) page.
- 3 United States government Trustee exempted-security: SEA-1934: §
- 4 Gila county, Arizona: Recorder: Doc ##: 2017_002378 - Affidavit Statement of Claim (Civilly a Live-Life).

2022-011769 MISC. Page: 1033 of 2782
 09/26/2022 03:35:37 PM Receipt #: 22-9381
 Rec Fee: \$30.00 Darrell James Hill
 Gila County, Az, Sadie Jo Bingham, Recorder



1036

Notice of Claim: USPS RMN~ RE 322 404 075 US:

Verification of the Known Birth/Berth Statuses: man: Beverly-Jean: Romero-Hill

**Arizona state
Pinal County**

:Man :Beverly-Jean: Romero- Hill personally presents before me, the undersigned Notary duly authorized by the laws of Arizona to administer oaths; now on this 7th day: June: 2019, being by me first duly sworn on his affirmation, claimant deposes and says:

:i- man of the family Romero am a) :Beverly-Jean (given-name)-beneficiary, and :owner of the property (a) :inherent-trust by the Almighty-God and (b): beneficiary -subrogee -in the idem sonans- trust by the subrogor: UNITED-STATES-government- Trustee as established and presented within the riveted- certified- instrument ~Not-altered-authentication~ attached (3 pages): p. 1/3 (at the bottom): certified- document: CERTIFICATE OF BIRTH~STATE OF NEW MEXICO -File No. 19581503459, :document No. 2254494; and: p. 2/3 :certification~ of~ authenticity by the State of New Mexico ~ (emblem)~ OFFICE OF THE SECRETARY OF STATE – CERTIFICATE regarding the NO: 19581503459; and: p. 3/3: with the 18053840-2~ United States of America~ [emblem]~ DEPARTMENT OF STATE.

Claim

:i -man am :Beverly-Jean: Romero- Hill, by the known presents: 1958~A.D- June~15th -New Mexican-birth of :i ~wherefrom and throughout the eternity nothing exists between :i -man and Almighty God~, and by the known-presents that after the : 1958-June~15th -New Mexican- berth in the idem~sonans is the subrogation: BEVERLY JEAN ROMERO. – And :i- man am :soul-beneficiary :sui juris :Authorized Representative/~Executor of (A) the inherent trust by Almighty-God and (B) of the subrogation- trust by the UNITED STATES government-services-Trustee as established and presented by the within- riveted- certified- instrument;

:i- man verify that all stated herein is true and correct; and: i- man will state same onto the record in the open court.

Without prejudice:

Autographed this 7th day June 2019 A.D.

Beverly Jean Romero Hill
:Beverly-Jean: Romero- Hill, :beneficiary, :Executor

JURAT

Sworn to and subscribed before me now on this 7th day: June: 2019.
Produced identification: type: Arizona Driver License.

Dominic Stewart

Notary

seal

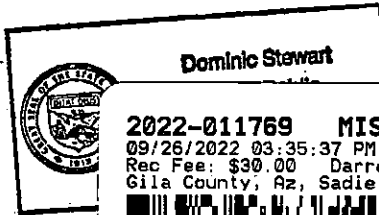

2022-011769 MISC Page: 1034 of 2782
09/26/2022 03:35:37 PM Receipt #: 22-9381
Rec Fee: \$30.00 Darrell James Hill
Gila County, Az, Sadie Jo Bingham, Recorder



1031

United States of America



DEPARTMENT OF STATE

To all to whom these presents shall come, Greetings:

I Certify That the document hereunto annexed is under the Seal of the State(s) of New Mexico, and that such Seal(s) is/are entitled to full faith and credit.*

**For the contents of the annexed document, the Department assumes no responsibility
This certificate is not valid if it is removed or altered in any way whatsoever*

In testimony whereof, I, Michael R. Pompeo, Secretary of State, have hereunto caused the seal of the Department of State to be affixed and my name subscribed by the Assistant Authentication Officer, of the said Department, at the city of Washington, in the District of Columbia, this fifteenth day of August, 2018.

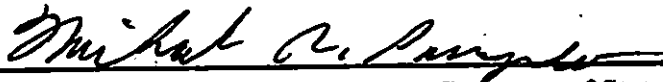
Secretary of State

By 

Issued pursuant to CHXIV, State of Sept. 15, 1789, 1 Stat. 68-69; 22 USC 2637; 22USC 2651a; 5 USC 301; 28 USC 1733 et. seq.; 8 USC 1443(); RULE 44 Federal Rules of Civil Procedure.

1532

2022-011769 MISC Page: 1035 of 2782
09/26/2022 03:35:37 PM Receipt #: 22-9381
Rec Fee: \$30.00 Darrell James Hill
Gila County, Az; Sadie Jo Bingham, Recorder



For: Demonstration Purposes Only;
Day: June 11, 2019
Autograph: *Darrell James Hill*



Unofficial Copy

1033

2022-011769 MISC Page: 1036 of 2782
09/26/2022 03:35:37 PM Receipt #: 22-9381
Rec Fee: \$30.00 Darrell James Hill
Gila County, Az, Sadie Jo Bingham, Recorder



STATE OF NEW MEXICO



OFFICE OF THE
SECRETARY OF STATE
CERTIFICATE

I, MAGGIE TOULOUSE OLIVER, SECRETARY OF STATE FOR NEW MEXICO, DO
HEREBY CERTIFY

THAT

DONNA DOSSEY was the State Registrar VITAL STATISTICS, OFFICE OF VITAL RECORDS
AND HEALTH STATISTICS, PUBLIC HEALTH DIVISION, DEPARTMENT OF HEALTH for the
state of New Mexico on the date of execution shown on the Birth Certificate for BEVERLY JEAN
ROMERO CERTIFICATE NO: (19581503459) and appointed to the office with full authority to exercise
the duties and responsibilities of State Registrar and legally entrusted with the possession and custody of
the records and files thereof.

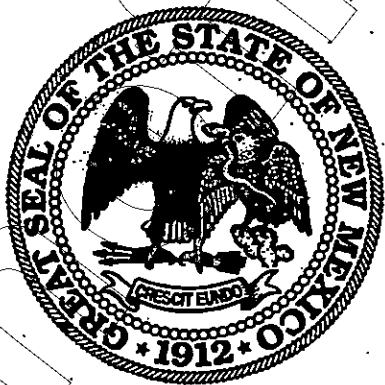

GIVEN UNDER MY HAND AND THE
GREAT SEAL OF THE STATE OF
NEW MEXICO, IN THE CITY OF
SANTA FE, THE CAPITAL, ON THIS
16TH DAY OF JULY, 2018 A.D.

Maggie Toulouse Oliver

SECRETARY OF STATE

2022-011769 MISC Page: 1037 of 2782
09/26/2022 03:35:37 PM Receipt #: 22-9381
Rec Fee: \$30.00 Darrell James Hill
Gila County, Az, Sadie Jo Bingham, Recorder



1034

**For: Demonstration Purposes Only;
Day: June 11, 2019
Autograph: Beverly Jean Darrell James Hill**



1035

2022-011769 MISC Page: 1038 of 2782
09/26/2022 03:35:37 PM Receipt #: 22-9381
Rec Fee: \$30.00 Darrell James Hill
Gila County, Az, Sadie Jo Bingham, Recorder



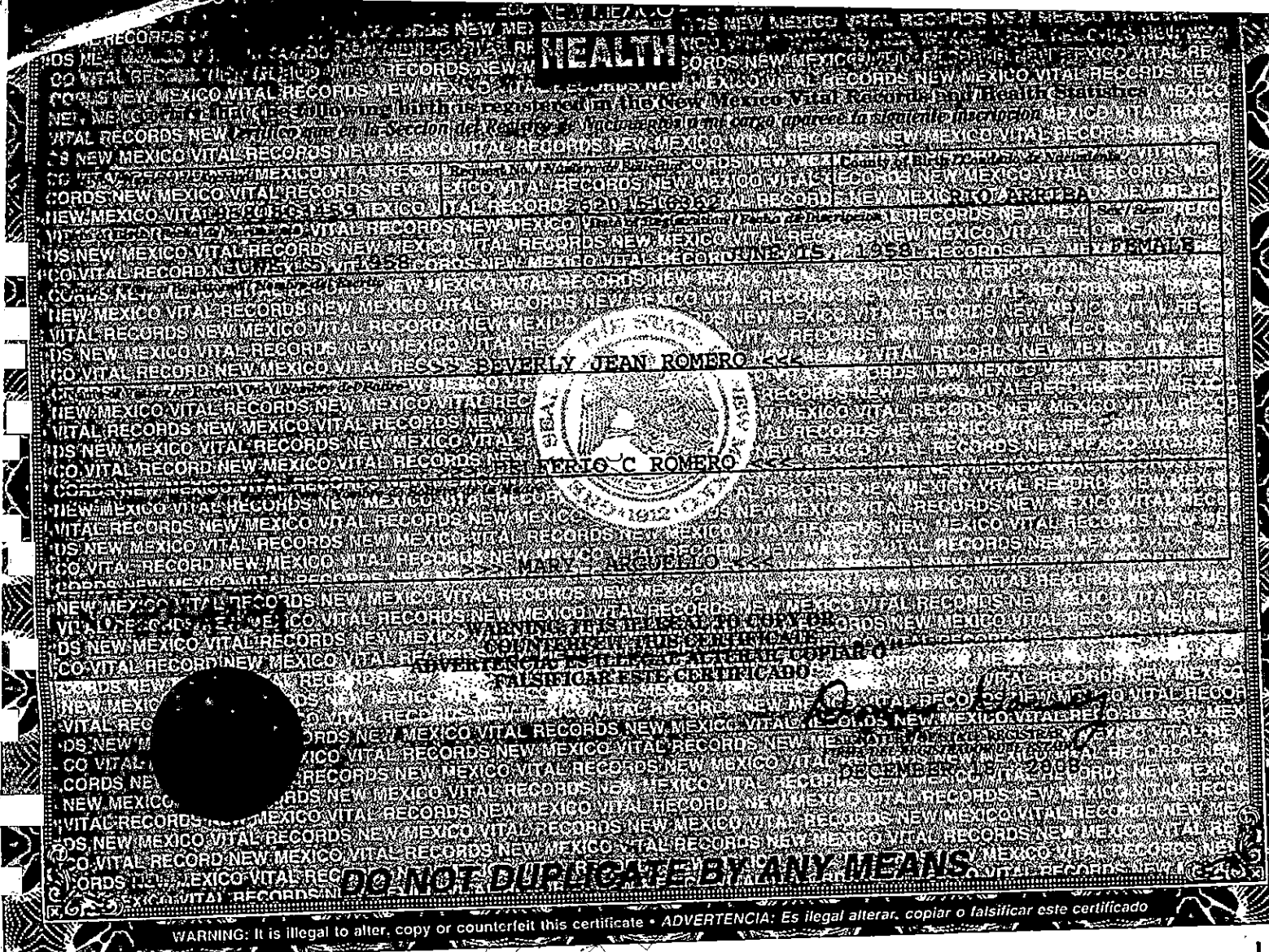

BEVERLY JEAN ROMERO
BERTO C ROMERO

WARNING: It is illegal to alter, copy or counterfeit this certificate • ADVERTENCIA: Es ilegal alterar, copiar o falsificar este certificado

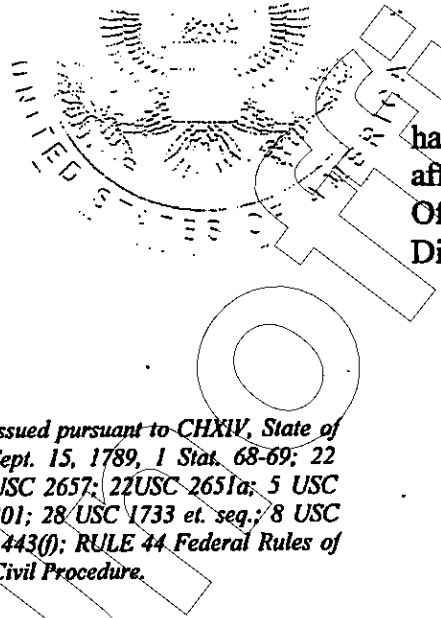

In testimony whereof, I, Michael R. Pompeo, Secretary of State, have hereunto caused the seal of the Department of State to be affixed and my name subscribed by the Assistant Authentication Officer, of the said Department, at the city of Washington, in the District of Columbia, this fifteenth day of August, 2018.

Michael R. Pompeo
Secretary of State

By *[Signature]*
Assistant Authentication Officer,
Department of State

Issued pursuant to CHXIV, State of Sept. 15, 1789, 1 Stat. 68-69; 22 USC 2657; 22 USC 2651a; 5 USC 301; 28 USC 1733 et. seq.; 8 USC 1443(f); RULE 44 Federal Rules of Civil Procedure.

10316

2022-011769 MISC Page: 1039 of 2782
09/26/2022 03:35:37 PM Receipt #: 22-9381
Rec Fee: \$30.00 Darrell James Hill
Gila County, Az, Sadie Jo Bingham, Recorder

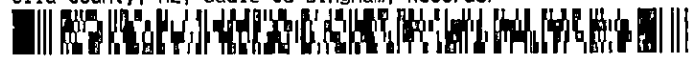

For: Demonstration Purposes Only;
Day: June 11, 2019
Autograph: *Darrell James Hill*



1037

2022-011769 MISC Page: 1040 of 2782
09/26/2022 03:35:37 PM Receipt #: 22-9381
Rec Fee: \$30.00 Darrell James Hill
Gila County, Az, Sadie Jo Bingham, Recorder



Notice of Claim: RE 322 404 075 US:

Verification of the Civilian Status: man: Beverly-Jean: Romero-Hill

Arizona state
Pinal county

:Man :Beverly-Jean: Romero- Hill personally presents before me, the undersigned Notary duly authorized by the laws of Arizona to administer oaths; now on this 7th day: June: 2019, being by me first duly sworn on his affirmation, claimant deposes and says:

Claim

(A) :i- man of the family Romero am a) :Beverly-Jean (given-name)-beneficiary, and :owner of the property (a) :inherent-trust by the Almighty-God and (b): beneficiary -subrogee -in the idem sonans- trust by the subrogor: UNITED-STATES-government- Trustee. See: Notice of Claim: **RE 322 404 075 US: Verification of the Known Birth/Berth Statues: man: Beverly-Jean: Romero-Hill** , attached: 4 pages; AND

(B) :i- man am: Beverly- Jean: Romero- Hill, :New Mexican by the known presents and within the regard to of the Trading With The Enemy Act of 1917 (49 Stat. L. 411), as amended, am :civilian ~ am-Not :combatant, and am-Not :enemy, and am-Not :ally-of-enemy.

:i- man verify that all stated herein is true and correct; and: i- man will state same onto the record in the open court.

Without prejudice:

Autographed this 7th day June 2019 A.D.

Beverly Jean Romero Hill A.R
:Beverly-Jean: Romero- Hill, :beneficiary, :Executor

JURAT

Sworn to and subscribed before me now on this 7th day: June: 2019.

Produced identification: type: Arizona Driver License.

Dominic Stewart
Notary

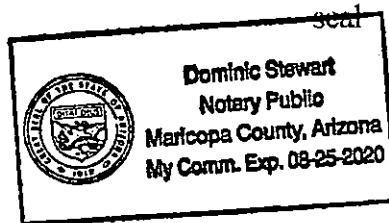

1038



[PUBLIC—No. 43—63D CONGRESS.]

[H. R. 7837.]

An Act To provide for the establishment of Federal reserve banks, to furnish an elastic currency, to afford means of rediscounting commercial paper, to establish a more effective supervision of banking in the United States, and for other purposes.

Be it enacted by the Senate and House of Representatives of the United States of America in Congress assembled, That the short title of this Act shall be the "Federal Reserve Act."

Wherever the word "bank" is used in this Act, the word shall be held to include State bank, banking association, and trust company, except where national banks or Federal reserve banks are specifically referred to.

The terms "national bank" and "national banking association" used in this Act shall be held to be synonymous and interchangeable. The term "member bank" shall be held to mean any national bank, State bank, or bank or trust company which has become a member of one of the reserve banks created by this Act. The term "board" shall be held to mean Federal Reserve Board; the term "district" shall be held to mean Federal reserve district; the term "reserve bank" shall be held to mean Federal reserve bank.

FEDERAL RESERVE DISTRICTS.

SEC. 2. As soon as practicable, the Secretary of the Treasury, the Secretary of Agriculture and the Comptroller of the Currency, acting as "The Reserve Bank Organization Committee," shall designate not less than eight nor more than twelve cities to be known as Federal reserve cities, and shall divide the continental United States, excluding Alaska, into districts, each district to contain only one of such Federal reserve cities. The determination of said organization committee shall not be subject to review except by the Federal Reserve Board when organized: *Provided*, That the districts shall be apportioned with due regard to the convenience and customary course of business and shall not necessarily be coterminous with any State or States. The districts thus created may be readjusted and new districts may from time to time be created by the Federal Reserve Board, not to exceed twelve in all. Such districts shall be known as Federal reserve districts and may be designated by number. A majority of the organization committee shall constitute a quorum with authority to act.

Said organization committee shall be authorized to employ counsel and expert aid, to take testimony, to send for persons and papers, to administer oaths, and to make such investigation as may be deemed necessary by the said committee in determining the reserve districts and in designating the cities within such districts where such Federal reserve banks shall be severally located. The said committee shall supervise the organization in each of the cities designated of a Federal reserve bank, which shall include in its title the name of the city in which it is situated, as "Federal Reserve Bank of Chicago."

1039
Digitized for FRASER
<http://fraser.stlouisfed.org/>
Federal Reserve Bank of St. Louis

2022-011769 MISC Page: 1042 of 2782
09/26/2022 03:35:37 PM Receipt #: 22-9381
Rec Fee: \$30.00 Darrell James Hill
Gila County, Az, Sadie Jo Binsham, Recorder



Under regulations to be prescribed by the organization committee, every national banking association in the United States is hereby required, and every eligible bank in the United States and every trust company within the District of Columbia, is hereby authorized to signify in writing, within sixty days after the passage of this Act, its acceptance of the terms and provisions hereof. When the organization committee shall have designated the cities in which Federal reserve banks are to be organized, and fixed the geographical limits of the Federal reserve districts, every national banking association within that district shall be required within thirty days after notice from the organization committee, to subscribe to the capital stock of such Federal reserve bank in a sum equal to six per centum of the paid-up capital stock and surplus of such bank, one-sixth of the subscription to be payable on call of the organization committee or of the Federal Reserve Board, one-sixth within three months and one-sixth within six months thereafter, and the remainder of the subscription, or any part thereof, shall be subject to call when deemed necessary by the Federal Reserve Board, said payments to be in gold or gold certificates.

The shareholders of every Federal reserve bank shall be held individually responsible, equally and ratably, and not one for another, for all contracts, debts, and engagements of such bank to the extent of the amount of their subscriptions to such stock at the par value thereof in addition to the amount subscribed, whether such subscriptions have been paid up in whole or in part, under the provisions of this Act.

Any national bank failing to signify its acceptance of the terms of this Act within the sixty days aforesaid, shall cease to act as a reserve agent, upon thirty days' notice, to be given within the discretion of the said organization committee or of the Federal Reserve Board.

Should any national banking association in the United States now organized fail within one year after the passage of this Act to become a member bank or fail to comply with any of the provisions of this Act applicable thereto, all of the rights, privileges, and franchises of such association granted to it under the national-bank Act, or under the provisions of this Act, shall be thereby forfeited. Any noncompliance with or violation of this Act shall, however, be determined and adjudged by any court of the United States of competent jurisdiction in a suit brought for that purpose in the district or territory in which such bank is located, under direction of the Federal Reserve Board, by the Comptroller of the Currency in his own name before the association shall be declared dissolved. In cases of such noncompliance or violation, other than the failure to become a member bank under the provisions of this Act, every director who participated in or assented to the same shall be held liable in his personal or individual capacity for all damages which said bank, its shareholders, or any other person shall have sustained in consequence of such violation.

Such dissolution shall not take away or impair any remedy against such corporation, its stockholders or officers, for any liability or penalty which shall have been previously incurred.

Should the subscriptions by banks to the stock of said Federal reserve banks or any one or more of them be, in the judgment of the organization committee, insufficient to provide the amount of capital



required therefor, then and in that event the said organization committee may, under conditions and regulations to be prescribed by it, offer to public subscription at par such an amount of stock in said Federal reserve banks, or any one or more of them, as said committee shall determine, subject to the same conditions as to payment and stock liability as provided for member banks.

No individual, copartnership, or corporation other than a member bank of its district shall be permitted to subscribe for or to hold at any time more than \$25,000 par value of stock in any Federal reserve bank. Such stock shall be known as public stock and may be transferred on the books of the Federal reserve bank by the chairman of the board of directors of such bank.

Should the total subscriptions by banks and the public to the stock of said Federal reserve banks, or any one or more of them, be, in the judgment of the organization committee, insufficient to provide the amount of capital required therefor, then and in that event the said organization committee shall allot to the United States such an amount of said stock as said committee shall determine. Said United States stock shall be paid for at par out of any money in the Treasury not otherwise appropriated, and shall be held by the Secretary of the Treasury and disposed of for the benefit of the United States in such manner, at such times, and at such price, not less than par, as the Secretary of the Treasury shall determine.

Stock not held by member banks shall not be entitled to voting power.

The Federal Reserve Board is hereby empowered to adopt and promulgate rules and regulations governing the transfers of said stock.

No Federal reserve bank shall commence business with a subscribed capital less than \$4,000,000. The organization of reserve districts and Federal reserve cities shall not be construed as changing the present status of reserve cities and central reserve cities, except in so far as this Act changes the amount of reserves that may be carried with approved reserve agents located therein. The organization committee shall have power to appoint such assistants and incur such expenses in carrying out the provisions of this Act as it shall deem necessary, and such expenses shall be payable by the Treasurer of the United States upon voucher approved by the Secretary of the Treasury, and the sum of \$100,000, or so much thereof as may be necessary, is hereby appropriated, out of any moneys in the Treasury not otherwise appropriated, for the payment of such expenses.

BRANCH OFFICES.

SEC. 3. Each Federal reserve bank shall establish branch banks within the Federal reserve district in which it is located and may do so in the district of any Federal reserve bank which may have been suspended. Such branches shall be operated by a board of directors under rules and regulations approved by the Federal Reserve Board. Directors of branch banks shall possess the same qualifications as directors of the Federal reserve banks. Four of said directors shall be selected by the reserve bank and three by the Federal Reserve Board, and they shall hold office during the pleasure, respectively, of the parent bank and the Federal Reserve Board. The reserve bank shall designate one of the directors as manager.

20308 U-58-22

Digitized for FRASER
<http://fraser.stlouisfed.org/>
Federal Reserve Bank of St. Louis

2022-011769 MISC Page: 1044 of 2782
09/26/2022 03:35:37 PM Receipt #: 22-9381
Rec Fee: \$30.00 Darrell James Hill
Gila County, Az, Sadie Jo Bingham, Recorder



FEDERAL RESERVE BANKS.

SEC. 4. When the organization committee shall have established Federal reserve districts as provided in section two of this Act, a certificate shall be filed with the Comptroller of the Currency showing the geographical limits of such districts and the Federal reserve city designated in each of such districts. The Comptroller of the Currency shall thereupon cause to be forwarded to each national bank located in each district, and to such other banks declared to be eligible by the organization committee which may apply therefor, an application blank in form to be approved by the organization committee, which blank shall contain a resolution to be adopted by the board of directors of each bank executing such application, authorizing a subscription to the capital stock of the Federal reserve bank organizing in that district in accordance with the provisions of this Act.

When the minimum amount of capital stock prescribed by this Act for the organization of any Federal reserve bank shall have been subscribed and allotted, the organization committee shall designate any five banks of those whose applications have been received, to execute a certificate of organization, and thereupon the banks so designated shall, under their seals, make an organization certificate which shall specifically state the name of such Federal reserve bank, the territorial extent of the district over which the operations of such Federal reserve bank are to be carried on, the city and State in which said bank is to be located, the amount of capital stock and the number of shares into which the same is divided, the name and place of doing business of each bank executing such certificate, and of all banks which have subscribed to the capital stock of such Federal reserve bank and the number of shares subscribed by each, and the fact that the certificate is made to enable those banks executing same, and all banks which have subscribed or may thereafter subscribe to the capital stock of such Federal reserve bank, to avail themselves of the advantages of this Act.

The said organization certificate shall be acknowledged before a judge of some court of record or notary public; and shall be, together with the acknowledgment thereof, authenticated by the seal of such court, or notary, transmitted to the Comptroller of the Currency, who shall file, record and carefully preserve the same in his office.

Upon the filing of such certificate with the Comptroller of the Currency as aforesaid, the said Federal reserve bank shall become a body corporate and as such, and in the name designated in such organization certificate, shall have power—

- First. To adopt and use a corporate seal.
- Second. To have succession for a period of twenty years from its organization unless it is sooner dissolved by an Act of Congress, or unless its franchise becomes forfeited by some violation of law.
- Third. To make contracts.
- Fourth. To sue and be sued, complain and defend, in any court of law or equity.
- Fifth. To appoint by its board of directors, such officers and employees as are not otherwise provided for in this Act, to define their duties, require bonds of them and fix the penalty thereof, and to dismiss at pleasure such officers or employees.

Sixth. To prescribe by its board of directors, by-laws not inconsistent with law, regulating the manner in which its general business may be conducted, and the privileges granted to it by law may be exercised and enjoyed.

Seventh. To exercise by its board of directors, or duly authorized officers or agents, all powers specifically granted by the provisions of this Act and such incidental powers as shall be necessary to carry on the business of banking within the limitations prescribed by this Act.

Eighth. Upon deposit with the Treasurer of the United States of any bonds of the United States in the manner provided by existing law relating to national banks, to receive from the Comptroller of the Currency circulating notes in blank, registered and countersigned as provided by law, equal in amount to the par value of the bonds so deposited, such notes to be issued under the same conditions and provisions of law as relate to the issue of circulating notes of national banks secured by bonds of the United States bearing the circulating privilege, except that the issue of such notes shall not be limited to the capital stock of such Federal reserve bank.

But no Federal reserve bank shall transact any business except such as is incidental and necessarily preliminary to its organization until it has been authorized by the Comptroller of the Currency to commence business under the provisions of this Act.

Every Federal reserve bank shall be conducted under the supervision and control of a board of directors.

The board of directors shall perform the duties usually appertaining to the office of directors of banking associations and all such duties as are prescribed by law.

Said board shall administer the affairs of said bank fairly and impartially and without discrimination in favor of or against any member bank or banks and shall, subject to the provisions of law and the orders of the Federal Reserve Board, extend to each member bank such discounts, advancements and accommodations as may be safely and reasonably made with due regard for the claims and demands of other member banks.

Such board of directors shall be selected as hereinafter specified and shall consist of nine members, holding office for three years, and divided into three classes, designated as classes A, B, and C.

Class A shall consist of three members, who shall be chosen by and be representative of the stock-holding banks.

Class B shall consist of three members, who at the time of their election shall be actively engaged in their district in commerce, agriculture or some other industrial pursuit.

Class C shall consist of three members who shall be designated by the Federal Reserve Board. When the necessary subscriptions to the capital stock have been obtained for the organization of any Federal reserve bank, the Federal Reserve Board shall appoint the class C directors and shall designate one of such directors as chairman of the board to be selected. Pending the designation of such chairman, the organization committee shall exercise the powers and duties appertaining to the office of chairman in the organization of such Federal reserve bank.

No Senator or Representative in Congress shall be a member of the Federal Reserve Board or an officer or a director of a Federal reserve bank.

1043
UN



No director of class B shall be an officer, director, or employee of any bank.

No director of class C shall be an officer, director, employee, or stockholder of any bank.

Directors of class A and class B shall be chosen in the following manner:

The chairman of the board of directors of the Federal reserve bank of the district in which the bank is situated or, pending the appointment of such chairman, the organization committee shall classify the member banks of the district into three general groups or divisions. Each group shall contain as nearly as may be one-third of the aggregate number of the member banks of the district and shall consist, as nearly as may be, of banks of similar capitalization. The groups shall be designated by number by the chairman.

At a regularly called meeting of the board of directors of each member bank in the district it shall elect by ballot a district reserve elector and shall certify his name to the chairman of the board of directors of the Federal reserve bank of the district. The chairman shall make lists of the district reserve electors thus named by banks in each of the aforesaid three groups and shall transmit one list to each elector in each group.

Each member bank shall be permitted to nominate to the chairman one candidate for director of class A and one candidate for director of class B. The candidates so nominated shall be listed by the chairman, indicating by whom nominated, and a copy of said list shall, within fifteen days after its completion, be furnished by the chairman to each elector.

Every elector shall, within fifteen days after the receipt of the said list, certify to the chairman his first, second, and other choices of a director of class A and class B, respectively, upon a preferential ballot, on a form furnished by the chairman of the board of directors of the Federal reserve bank of the district. Each elector shall make a cross opposite the name of the first, second, and other choices for a director of class A and for a director of class B, but shall not vote more than one choice for any one candidate.

Any candidate having a majority of all votes cast in the column of first choice shall be declared elected. If no candidate have a majority of all the votes in the first column, then there shall be added together the votes cast by the electors for such candidates in the second column and the votes cast for the several candidates in the first column. If any candidate then have a majority of the electors voting, by adding together the first and second choices, he shall be declared elected. If no candidate have a majority of electors voting when the first and second choices shall have been added, then the votes cast in the third column for other choices shall be added together in like manner, and the candidate then having the highest number of votes shall be declared elected. An immediate report of election shall be declared.

Class C directors shall be appointed by the Federal Reserve Board. They shall have been for at least two years residents of the district for which they are appointed, one of whom shall be designated by said board as chairman of the board of directors of the Federal reserve bank and as "Federal reserve agent." He shall be a person of tested banking experience; and in addition to his duties as chairman



of the board of directors of the Federal reserve bank he shall be required to maintain under regulations to be established by the Federal Reserve Board a local office of said board on the premises of the Federal reserve bank. He shall make regular reports to the Federal Reserve Board, and shall act as its official representative for the performance of the functions conferred upon it by this Act. He shall receive an annual compensation to be fixed by the Federal Reserve Board and paid monthly by the Federal reserve bank to which he is designated. One of the directors of class C, who shall be a person of tested banking experience, shall be appointed by the Federal Reserve Board as deputy chairman and deputy Federal reserve agent to exercise the powers of the chairman of the board and Federal reserve agent in case of absence or disability of his principal.

Directors of Federal reserve banks shall receive, in addition to any compensation otherwise provided, a reasonable allowance for necessary expenses in attending meetings of their respective boards, which amount shall be paid by the respective Federal reserve banks. Any compensation that may be provided by boards of directors of Federal reserve banks for directors, officers or employees shall be subject to the approval of the Federal Reserve Board.

The Reserve Bank Organization Committee may, in organizing Federal reserve banks, call such meetings of bank directors in the several districts as may be necessary to carry out the purposes of this Act, and may exercise the functions herein conferred upon the chairman of the board of directors of each Federal reserve bank pending the complete organization of such bank.

At the first meeting of the full board of directors of each Federal reserve bank, it shall be the duty of the directors of classes A, B and C, respectively, to designate one of the members of each class whose term of office shall expire in one year from the first of January nearest to date of such meeting, one whose term of office shall expire at the end of two years from said date, and one whose term of office shall expire at the end of three years from said date. Thereafter every director of a Federal reserve bank chosen as hereinbefore provided shall hold office for a term of three years. Vacancies that may occur in the several classes of directors of Federal reserve banks may be filled in the manner provided for the original selection of such directors, such appointees to hold office for the unexpired terms of their predecessors.

STOCK ISSUES; INCREASE AND DECREASE OF CAPITAL.

SEC. 5. The capital stock of each Federal reserve bank shall be divided into shares of \$100 each. The outstanding capital stock shall be increased from time to time as member banks increase their capital stock and surplus or as additional banks become members, and may be decreased as member banks reduce their capital stock or surplus or cease to be members. Shares of the capital stock of Federal reserve banks owned by member banks shall not be transferred or hypothecated. When a member bank increases its capital stock or surplus, it shall thereupon subscribe for an additional amount of capital stock of the Federal reserve bank of its district equal to six per centum of the said increase, one-half of said sub-



scription to be paid in the manner hereinbefore provided for original subscription, and one-half subject to call of the Federal Reserve Board. A bank applying for stock in a Federal reserve bank at any time after the organization thereof must subscribe for an amount of the capital stock of the Federal reserve bank equal to six per centum of the paid-up capital stock and surplus of said applicant bank, paying therefor its par value plus one-half of one per centum a month from the period of the last dividend. When the capital stock of any Federal reserve bank shall have been increased either on account of the increase of capital stock of member banks or on account of the increase in the number of member banks, the board of directors shall cause to be executed a certificate to the Comptroller of the Currency showing the increase in capital stock, the amount paid in, and by whom paid. When a member bank reduces its capital stock it shall surrender a proportionate amount of its holdings in the capital of said Federal reserve bank, and when a member bank voluntarily liquidates it shall surrender all of its holdings of the capital stock of said Federal reserve bank and be released from its stock subscription not previously called. In either case the shares surrendered shall be canceled and the member bank shall receive in payment therefor, under regulations to be prescribed by the Federal Reserve Board, a sum equal to its cash-paid subscriptions on the shares surrendered and one-half of one per centum a month from the period of the last dividend, not to exceed the book value thereof, less any liability of such member bank to the Federal reserve bank.

Sec. 6. If any member bank shall be declared insolvent and a receiver appointed therefor, the stock held by it in said Federal reserve bank shall be canceled, without impairment of its liability, and all cash-paid subscriptions on said stock, with one-half of one per centum per month from the period of last dividend, not to exceed the book value thereof, shall be first applied to all debts of the insolvent member bank to the Federal reserve bank, and the balance, if any, shall be paid to the receiver of the insolvent bank. Whenever the capital stock of a Federal reserve bank is reduced, either on account of a reduction in capital stock of any member bank or of the liquidation or insolvency of such bank, the board of directors shall cause to be executed a certificate to the Comptroller of the Currency showing such reduction of capital stock and the amount repaid to such bank.

DIVISION OF EARNINGS.

Sec. 7. After all necessary expenses of a Federal reserve bank have been paid or provided for, the stockholders shall be entitled to receive an annual dividend of six per centum on the paid-in capital stock, which dividend shall be cumulative. After the aforesaid dividend claims have been fully met, all the net earnings shall be paid to the United States as a franchise tax, except that one-half of such net earnings shall be paid into a surplus fund until it shall amount to forty per centum of the paid-in capital stock of such bank.

The net earnings derived by the United States from Federal reserve banks shall, in the discretion of the Secretary, be used to supplement the gold reserve held against outstanding United States notes, or shall be applied to the reduction of the outstanding bonded indebtedness of



the United States under regulations to be prescribed by the Secretary of the Treasury. Should a Federal reserve bank be dissolved or go into liquidation, any surplus remaining, after the payment of all debts, dividend requirements as hereinbefore provided, and the par value of the stock, shall be paid to and become the property of the United States and shall be similarly applied.

Federal reserve banks, including the capital stock and surplus therein, and the income derived therefrom shall be exempt from Federal, State, and local taxation, except taxes upon real estate.

Sec. 8. Section fifty-one hundred and fifty-four, United States Revised Statutes, is hereby amended to read as follows:

Any bank incorporated by special law of any State or of the United States or organized under the general laws of any State or of the United States and having an unimpaired capital sufficient to entitle it to become a national banking association under the provisions of the existing laws may, by the vote of the shareholders owning not less than fifty-one per centum of the capital stock of such bank or banking association, with the approval of the Comptroller of the Currency be converted into a national banking association, with any name approved by the Comptroller of the Currency:

Provided, however, That said conversion shall not be in contravention of the State law. In such case the articles of association and organization certificate may be executed by a majority of the directors of the bank or banking institution, and the certificate shall declare that the owners of fifty-one per centum of the capital stock have authorized the directors to make such certificate and to change or convert the bank or banking institution into a national association. A majority of the directors, after executing the articles of association and the organization certificate, shall have power to execute all other papers and to do whatever may be required to make its organization perfect and complete as a national association. The shares of any such bank may continue to be for the same amount each as they were before the conversion, and the directors may continue to be directors of the association until others are elected or appointed in accordance with the provisions of the statutes of the United States. When the Comptroller has given to such bank or banking association a certificate that the provisions of this Act have been complied with, such bank or banking association, and all its stockholders, officers, and employees, shall have the same powers and privileges, and shall be subject to the same duties, liabilities, and regulations, in all respects, as shall have been prescribed by the Federal Reserve Act and by the national banking Act for associations originally organized as national banking associations.

STATE BANKS AS MEMBERS.

SEC. 9. Any bank incorporated by special law of any State, or organized under the general laws of any State or of the United States, may make application to the reserve bank organization committee, pending organization, and thereafter to the Federal Reserve Board for the right to subscribe to the stock of the Federal reserve bank organized or to be organized within the Federal reserve district where the applicant is located. The organization committee or the Federal Reserve Board, under such rules and regulations as

1047
Digitized for FRASER
<http://fraser.stlouisfed.org/>
Federal Reserve Bank of St. Louis

2022-011769 MISC Page: 1050 of 2782
09/26/2022 03:35:37 PM Receipt #: 22-9381
Rec Fee: \$30.00 Darrell James Hill
Gila County, Az, Sadie Jo Bingham, Recorder



it may prescribe, subject to the provisions of this section, may permit the applying bank to become a stockholder in the Federal reserve bank of the district in which the applying bank is located. Whenever the organization committee or the Federal Reserve Board shall permit the applying bank to become a stockholder in the Federal reserve bank of the district, stock shall be issued and paid for under the rules and regulations in this Act provided for national banks which become stockholders in Federal reserve banks.

The organization committee or the Federal Reserve Board shall establish by-laws for the general government of its conduct in acting upon applications made by the State banks and banking associations and trust companies for stock ownership in Federal reserve banks. Such by-laws shall require applying banks not organized under Federal law to comply with the reserve and capital requirements and to submit to the examination and regulations prescribed by the organization committee or by the Federal Reserve Board. No applying bank shall be admitted to membership in a Federal reserve bank unless it possesses a paid-up unimpaired capital sufficient to entitle it to become a national banking association in the place where it is situated, under the provisions of the national banking Act.

Any bank becoming a member of a Federal reserve bank under the provisions of this section shall, in addition to the regulations and restrictions hereinbefore provided, be required to conform to the provisions of law imposed on the national banks respecting the limitation of liability which may be incurred by any person, firm, or corporation to such banks, the prohibition against making purchase of or loans on stock of such banks, and the withdrawal or impairment of capital, or the payment of unearned dividends, and to such rules and regulations as the Federal Reserve Board may, in pursuance thereof, prescribe.

Such banks, and the officers, agents, and employees thereof, shall also be subject to the provisions of and to the penalties prescribed by sections fifty-one hundred and ninety-eight, fifty-two hundred, fifty-two hundred and one, and fifty-two hundred and eight, and fifty-two hundred and nine of the Revised Statutes. The member banks shall also be required to make reports of the conditions and of the payments of dividends to the comptroller, as provided in sections fifty-two hundred and eleven and fifty-two hundred and twelve of the Revised Statutes, and shall be subject to the penalties prescribed by section fifty-two hundred and thirteen for the failure to make such report.

If at any time it shall appear to the Federal Reserve Board that a member bank has failed to comply with the provisions of this section or the regulations of the Federal Reserve Board, it shall be within the power of the said board, after hearing, to require such bank to surrender its stock in the Federal reserve bank; upon such surrender the Federal reserve bank shall pay the cash-paid subscriptions to the said stock with interest at the rate of one-half of one per centum per month, computed from the last dividend, if earned, not to exceed the book value thereof, less any liability to said Federal reserve bank, except the subscription liability not previously called, which shall be canceled, and said Federal reserve bank shall, upon notice from the Federal Reserve Board, be required to suspend said bank from further privileges of membership, and shall within thirty days of such notice



cancel and retire its stock and make payment therefor in the manner herein provided. The Federal Reserve Board may restore membership upon due proof of compliance with the conditions imposed by this section.

FEDERAL RESERVE BOARD.

SEC. 10. A Federal Reserve Board is hereby created which shall consist of seven members, including the Secretary of the Treasury and the Comptroller of the Currency, who shall be members ex officio, and five members appointed by the President of the United States, by and with the advice and consent of the Senate. In selecting the five appointive members of the Federal Reserve Board, not more than one of whom shall be selected from any one Federal reserve district, the President shall have due regard to a fair representation of the different commercial, industrial and geographical divisions of the country. The five members of the Federal Reserve Board appointed by the President and confirmed as aforesaid shall devote their entire time to the business of the Federal Reserve Board and shall each receive an annual salary of \$12,000, payable monthly together with actual necessary traveling expenses, and the Comptroller of the Currency, as ex officio member of the Federal Reserve Board, shall, in addition to the salary now paid him as Comptroller of the Currency, receive the sum of \$7,000 annually for his services as a member of said Board.

The members of said board, the Secretary of the Treasury, the Assistant Secretaries of the Treasury, and the Comptroller of the Currency shall be ineligible during the time they are in office and for two years thereafter to hold any office, position, or employment in any member bank. Of the five members thus appointed by the President at least two shall be persons experienced in banking or finance. One shall be designated by the President to serve for two, one for four, one for six, one for eight, and one for ten years, and thereafter each member so appointed shall serve for a term of ten years unless sooner removed for cause by the President. Of the five persons thus appointed, one shall be designated by the President as governor and one as vice governor of the Federal Reserve Board. The governor of the Federal Reserve Board, subject to its supervision, shall be the active executive officer. The Secretary of the Treasury may assign offices in the Department of the Treasury for the use of the Federal Reserve Board. Each member of the Federal Reserve Board shall within fifteen days after notice of appointment make and subscribe to the oath of office.

The Federal Reserve Board shall have power to levy semiannually upon the Federal reserve banks, in proportion to their capital stock and surplus, an assessment sufficient to pay its estimated expenses and the salaries of its members and employees for the half year succeeding the levying of such assessment, together with any deficit carried forward from the preceding half year.

The first meeting of the Federal Reserve Board shall be held in Washington, District of Columbia, as soon as may be after the passage of this Act, at a date to be fixed by the Reserve Bank Organization Committee. The Secretary of the Treasury shall be ex officio chairman of the Federal Reserve Board. No member of the Federal Reserve Board shall be an officer or director of any bank, banking



institution, trust company, or Federal reserve bank nor hold stock in any bank, banking institution, or trust company; and before entering upon his duties as a member of the Federal Reserve Board he shall certify under oath to the Secretary of the Treasury that he has complied with this requirement. Whenever a vacancy shall occur, other than by expiration of term, among the five members of the Federal Reserve Board appointed by the President, as above provided, a successor shall be appointed by the President, with the advice and consent of the Senate, to fill such vacancy, and when appointed he shall hold office for the unexpired term of the member whose place he is selected to fill.

The President shall have power to fill all vacancies that may happen on the Federal Reserve Board during the recess of the Senate, by granting commissions which shall expire thirty days after the next session of the Senate convenes.

Nothing in this Act contained shall be construed as taking away any powers heretofore vested by law in the Secretary of the Treasury which relate to the supervision, management, and control of the Treasury Department and bureaus under such department, and wherever any power vested by this Act in the Federal Reserve Board or the Federal reserve agent appears to conflict with the powers of the Secretary of the Treasury, such powers shall be exercised subject to the supervision and control of the Secretary.

The Federal Reserve Board shall annually make a full report of its operations to the Speaker of the House of Representatives, who shall cause the same to be printed for the information of the Congress.

Section three hundred and twenty-four of the Revised Statutes of the United States shall be amended so as to read as follows: There shall be in the Department of the Treasury a bureau charged with the execution of all laws passed by Congress relating to the issue and regulation of national currency secured by United States bonds and, under the general supervision of the Federal Reserve Board, of all Federal reserve notes, the chief officer of which bureau shall be called the Comptroller of the Currency and shall perform his duties under the general directions of the Secretary of the Treasury.

SEC. 11. The Federal Reserve Board shall be authorized and empowered:

(a) To examine at its discretion the accounts, books and affairs of each Federal reserve bank and of each member bank and to require such statements and reports as it may deem necessary. The said board shall publish once each week a statement showing the condition of each Federal reserve bank and a consolidated statement for all Federal reserve banks. Such statements shall show in detail the assets and liabilities of the Federal reserve banks, single and combined, and shall furnish full information regarding the character of the money held as reserve and the amount, nature and maturities of the paper and other investments owned or held by Federal reserve banks.

(b) To permit, or, on the affirmative vote of at least five members of the Reserve Board to require Federal reserve banks to rediscount the discounted paper of other Federal reserve banks at rates of interest to be fixed by the Federal Reserve Board.

(c) To suspend for a period not exceeding thirty days, and from time to time to renew such suspension for periods not exceeding



fifteen days, any reserve requirement specified in this Act: *Provided*, That it shall establish a graduated tax upon the amounts by which the reserve requirements of this Act may be permitted to fall below the level hereinafter specified: *And provided further*, That when the gold reserve held against Federal reserve notes falls below forty per centum, the Federal Reserve Board shall establish a graduated tax of not more than one per centum per annum upon such deficiency until the reserves fall to thirty-two and one-half per centum, and when said reserve falls below thirty-two and one-half per centum, a tax at the rate increasing of not less than one and one-half per centum per annum upon each two and one-half per centum or fraction thereof that such reserve falls below thirty-two and one-half per centum. The tax shall be paid by the reserve bank, but the reserve bank shall add an amount equal to said tax to the rates of interest and discount fixed by the Federal Reserve Board.

(d) To supervise and regulate through the bureau under the charge of the Comptroller of the Currency the issue and retirement of Federal reserve notes, and to prescribe rules and regulations under which such notes may be delivered by the Comptroller to the Federal reserve agents applying therefor.

(e) To add to the number of cities classified as reserve and central reserve cities under existing law in which national banking associations are subject to the reserve requirements set forth in section twenty of this Act; or to reclassify existing reserve and central reserve cities or to terminate their designation as such.

(f) To suspend or remove any officer or director of any Federal reserve bank, the cause of such removal to be forthwith communicated in writing by the Federal Reserve Board to the removed officer or director and to said bank.

(g) To require the writing off of doubtful or worthless assets upon the books and balance sheets of Federal reserve banks.

(h) To suspend, for the violation of any of the provisions of this Act, the operations of any Federal reserve bank, to take possession thereof, administer the same during the period of suspension, and, when deemed advisable, to liquidate or reorganize such bank.

(i) To require bonds of Federal reserve agents, to make regulations for the safeguarding of all collateral, bonds, Federal reserve notes, money or property of any kind deposited in the hands of such agents, and said board shall perform the duties, functions, or services specified in this Act, and make all rules and regulations necessary to enable said board effectively to perform the same.

(j) To exercise general supervision over said Federal reserve banks.

(k) To grant by special permit to national banks applying therefor, when not in contravention of State or local law, the right to act as trustee, executor, administrator, or registrar of stocks and bonds under such rules and regulations as the said board may prescribe.

(l) To employ such attorneys, experts, assistants, clerks, or other employees as may be deemed necessary to conduct the business of the board. All salaries and fees shall be fixed in advance by said board and shall be paid in the same manner as the salaries of the members of said board. All such attorneys, experts, assistants, clerks, and other employees shall be appointed without regard to the provisions of the Act of January sixteenth, eighteen hundred and eighty-three (volume twenty-two, United States Statutes at Large,



page four hundred and three), and amendments thereto, or any rule or regulation made in pursuance thereof: *Provided*, That nothing herein shall prevent the President from placing said employees in the classified service.

FEDERAL ADVISORY COUNCIL.

SEC. 12. There is hereby created a Federal Advisory Council, which shall consist of as many members as there are Federal reserve districts. Each Federal reserve bank by its board of directors shall annually select from its own Federal reserve district one member of said council, who shall receive such compensation and allowances as may be fixed by his board of directors subject to the approval of the Federal Reserve Board. The meetings of said advisory council shall be held at Washington, District of Columbia, at least four times each year, and oftener if called by the Federal Reserve Board. The council may in addition to the meetings above provided for hold such other meetings in Washington, District of Columbia, or elsewhere, as it may deem necessary, may select its own officers and adopt its own methods of procedure, and a majority of its members shall constitute a quorum for the transaction of business. Vacancies in the council shall be filled by the respective reserve banks, and members selected to fill vacancies, shall serve for the unexpired term.

The Federal Advisory Council shall have power, by itself or through its officers, (1) to confer directly with the Federal Reserve Board on general business conditions; (2) to make oral or written representations concerning matters within the jurisdiction of said board; (3) to call for information and to make recommendations in regard to discount rates, rediscount business, note issues, reserve conditions in the various districts, the purchase and sale of gold or securities by reserve banks, open-market operations by said banks, and the general affairs of the reserve banking system.

POWERS OF FEDERAL RESERVE BANKS.

SEC. 13. Any Federal reserve bank may receive from any of its member banks, and from the United States, deposits of current funds in lawful money, national-bank notes, Federal reserve notes, or checks and drafts upon solvent member banks, payable upon presentation; or, solely for exchange purposes, may receive from other Federal reserve banks deposits of current funds in lawful money, national-bank notes, or checks and drafts upon solvent member or other Federal reserve banks, payable upon presentation.

Upon the indorsement of any of its member banks, with a waiver of demand, notice and protest by such bank, any Federal reserve bank may discount notes, drafts, and bills of exchange arising out of actual commercial transactions; that is, notes, drafts, and bills of exchange issued or drawn for agricultural, industrial, or commercial purposes, or the proceeds of which have been used, or are to be used, for such purposes, the Federal Reserve Board to have the right to determine or define the character of the paper thus eligible for discount, within the meaning of this Act. Nothing in this Act contained shall be construed to prohibit such notes, drafts, and bills of exchange, secured by staple agricultural products, or other goods, wares, or merchandise



from being eligible for such discount; but such definition shall not include notes, drafts, or bills covering merely investments or issued or drawn for the purpose of carrying or trading in stocks, bonds, or other investment securities, except bonds and notes of the Government of the United States. Notes, drafts, and bills admitted to discount under the terms of this paragraph must have a maturity at the time of discount of not more than ninety days: *Provided*, That notes, drafts, and bills drawn or issued for agricultural purposes or based on live stock and having a maturity not exceeding six months may be discounted in an amount to be limited to a percentage of the capital of the Federal reserve bank, to be ascertained and fixed by the Federal Reserve Board.

Any Federal reserve bank may discount acceptances which are based on the importation or exportation of goods and which have a maturity at time of discount of not more than three months, and indorsed by at least one member bank. The amount of acceptances so discounted shall at no time exceed one-half the paid-up capital stock and surplus of the bank for which the rediscounts are made.

The aggregate of such notes and bills bearing the signature or indorsement of any one person, company, firm, or corporation rediscounted for any one bank shall at no time exceed ten per centum of the unimpaired capital and surplus of said bank; but this restriction shall not apply to the discount of bills of exchange drawn in good faith against actually existing values.

Any member bank may accept drafts or bills of exchange drawn upon it and growing out of transactions involving the importation or exportation of goods having not more than six months sight to run; but no bank shall accept such bills to an amount equal at any time in the aggregate to more than one-half its paid-up capital stock and surplus.

Section fifty-two hundred and two of the Revised Statutes of the United States is hereby amended so as to read as follows: No national banking association shall at any time be indebted, or in any way liable, to an amount exceeding the amount of its capital stock at such time actually paid in and remaining undiminished by losses or otherwise, except on account of demands of the nature following:

- First. Notes of circulation.
- Second. Moneys deposited with or collected by the association.
- Third. Bills of exchange or drafts drawn against money actually on deposit to the credit of the association, or due thereto.
- Fourth. Liabilities to the stockholders of the association for dividends and reserve profits.
- Fifth. Liabilities incurred under the provisions of the Federal Reserve Act.

The rediscount by any Federal reserve bank of any bills receivable and of domestic and foreign bills of exchange, and of acceptances authorized by this Act, shall be subject to such restrictions, limitations, and regulations as may be imposed by the Federal Reserve Board.

OPEN-MARKET OPERATIONS.

SEC. 14. Any Federal reserve bank may, under rules and regulations prescribed by the Federal Reserve Board, purchase and sell in the open market, at home or abroad, either from or to domestic or

PROY

1053



foreign banks, firms, corporations, or individuals, cable transfers and bankers' acceptances and bills of exchange of the kinds and maturities by this Act made eligible for rediscount, with or without the indorsement of a member bank.

Every Federal reserve bank shall have power:

(a) To deal in gold coin and bullion at home or abroad, to make loans thereon, exchange Federal reserve notes for gold, gold coin, or gold certificates, and to contract for loans of gold coin or bullion, giving therefor, when necessary, acceptable security, including the hypothecation of United States bonds or other securities which Federal reserve banks are authorized to hold;

(b) To buy and sell, at home or abroad, bonds and notes of the United States, and bills, notes, revenue bonds, and warrants with a maturity from date of purchase of not exceeding six months, issued in anticipation of the collection of taxes or in anticipation of the receipt of assured revenues by any State, county, district, political subdivision, or municipality in the continental United States, including irrigation, drainage and reclamation districts, such purchases to be made in accordance with rules and regulations prescribed by the Federal Reserve Board;

(c) To purchase from member banks and to sell, with or without its indorsement, bills of exchange arising out of commercial transactions, as hereinbefore defined;

(d) To establish from time to time, subject to review and determination of the Federal Reserve Board, rates of discount to be charged by the Federal reserve bank for each class of paper, which shall be fixed with a view of accommodating commerce and business;

(e) To establish accounts with other Federal reserve banks for exchange purposes and, with the consent of the Federal Reserve Board, to open and maintain banking accounts in foreign countries, appoint correspondents, and establish agencies in such countries wheresoever it may deem best for the purpose of purchasing, selling, and collecting bills of exchange, and to buy and sell with or without its indorsement, through such correspondents or agencies, bills of exchange arising out of actual commercial transactions which have not more than ninety days to run and which bear the signature of two or more responsible parties

GOVERNMENT DEPOSITS.

SEC. 15. The moneys held in the general fund of the Treasury, except the five per centum fund for the redemption of outstanding national bank notes and the funds provided in this Act for the redemption of Federal reserve notes may, upon the direction of the Secretary of the Treasury, be deposited in Federal reserve banks, which banks, when required by the Secretary of the Treasury, shall act as fiscal agents of the United States; and the revenues of the Government or any part thereof may be deposited in such banks, and disbursements may be made by checks drawn against such deposits.

No public funds of the Philippine Islands, or of the postal savings, or any Government funds, shall be deposited in the continental United States in any bank not belonging to the system established by this Act: *Provided, however,* That nothing in this Act shall be construed to deny the right of the Secretary of the Treasury to use member banks as depositories.



NOTE ISSUES.

SEC. 16. Federal reserve notes, to be issued at the discretion of the Federal Reserve Board for the purpose of making advances to Federal reserve banks through the Federal reserve agents as hereinafter set forth and for no other purpose, are hereby authorized. The said notes shall be obligations of the United States and shall be receivable by all national and member banks and Federal reserve banks and for all taxes, customs, and other public dues. They shall be redeemed in gold on demand at the Treasury Department of the United States, in the city of Washington, District of Columbia, or in gold or lawful money at any Federal reserve bank.

Any Federal reserve bank may make application to the local Federal reserve agent for such amount of the Federal reserve notes hereinbefore provided for as it may require. Such application shall be accompanied with a tender to the local Federal reserve agent of collateral in amount equal to the sum of the Federal reserve notes thus applied for and issued pursuant to such application. The collateral security thus offered shall be notes and bills, accepted for rediscount under the provisions of section thirteen of this Act, and the Federal reserve agent shall each day notify the Federal Reserve Board of all issues and withdrawals of Federal reserve notes to and by the Federal reserve bank to which he is accredited. The said Federal Reserve Board may at any time call upon a Federal reserve bank for additional security to protect the Federal reserve notes issued to it.

Every Federal reserve bank shall maintain reserves in gold or lawful money of not less than thirty-five per centum against its deposits and reserves in gold of not less than forty per centum against its Federal reserve notes in actual circulation, and not offset by gold or lawful money deposited with the Federal reserve agent. Notes so paid out shall bear upon their faces a distinctive letter and serial number, which shall be assigned by the Federal Reserve Board to each Federal reserve bank. Whenever Federal reserve notes issued through one Federal reserve bank shall be received by another Federal reserve bank they shall be promptly returned for credit or redemption to the Federal reserve bank through which they were originally issued. No Federal reserve bank shall pay out notes issued through another under penalty of a tax of ten per centum upon the face value of notes so paid out. Notes presented for redemption at the Treasury of the United States shall be paid out of the redemption fund and returned to the Federal reserve banks through which they were originally issued, and thereupon such Federal reserve bank shall, upon demand of the Secretary of the Treasury, reimburse such redemption fund in lawful money or, if such Federal reserve notes have been redeemed by the Treasurer in gold or gold certificates, then such funds shall be reimbursed to the extent deemed necessary by the Secretary of the Treasury in gold or gold certificates, and such Federal reserve bank shall, so long as any of its Federal reserve notes remain outstanding, maintain with the Treasurer in gold an amount sufficient in the judgment of the Secretary to provide for all redemptions to be made by the Treasurer. Federal reserve notes received by the Treasury, otherwise than for redemption, may be exchanged for gold out of the redemption fund



hereinafter provided and returned to the reserve bank through which they were originally issued, or they may be returned to such bank for the credit of the United States. Federal reserve notes unfit for circulation shall be returned by the Federal reserve agents to the Comptroller of the Currency for cancellation and destruction.

The Federal Reserve Board shall require each Federal reserve bank to maintain on deposit in the Treasury of the United States a sum in gold sufficient in the judgment of the Secretary of the Treasury for the redemption of the Federal reserve notes issued to such bank, but in no event less than five per centum; but such deposit of gold shall be counted and included as part of the forty per centum reserve hereinbefore required. The board shall have the right, acting through the Federal reserve agent, to grant in whole or in part or to reject entirely the application of any Federal reserve bank for Federal reserve notes; but to the extent that such application may be granted the Federal Reserve Board shall, through its local Federal reserve agent, supply Federal reserve notes to the bank so applying, and such bank shall be charged with the amount of such notes and shall pay such rate of interest on said amount as may be established by the Federal Reserve Board, and the amount of such Federal reserve notes so issued to any such bank shall, upon delivery, together with such notes of such Federal reserve bank as may be issued under section eighteen of this Act upon security of United States two per centum Government bonds, become a first and paramount lien on all the assets of such bank.

Any Federal reserve bank may at any time reduce its liability for outstanding Federal reserve notes by depositing, with the Federal reserve agent, its Federal reserve notes, gold, gold certificates, or lawful money of the United States. Federal reserve notes so deposited shall not be reissued, except upon compliance with the conditions of an original issue.

The Federal reserve agent shall hold such gold, gold certificates, or lawful money available exclusively for exchange for the outstanding Federal reserve notes when offered by the reserve bank of which he is a director. Upon the request of the Secretary of the Treasury the Federal Reserve Board shall require the Federal reserve agent to transmit so much of said gold to the Treasury of the United States as may be required for the exclusive purpose of the redemption of such notes.

Any Federal reserve bank may at its discretion withdraw collateral deposited with the local Federal reserve agent for the protection of its Federal reserve notes deposited with it, and shall at the same time substitute therefor other like collateral of equal amount with the approval of the Federal reserve agent under regulations to be prescribed by the Federal Reserve Board.

In order to furnish suitable notes for circulation as Federal reserve notes, the Comptroller of the Currency shall, under the direction of the Secretary of the Treasury, cause plates and dies to be engraved in the best manner to guard against counterfeits and fraudulent alterations, and shall have printed therefrom and numbered such quantities of such notes of the denominations of \$5, \$10, \$20, \$50, \$100, as may be required to supply the Federal reserve banks. Such notes shall be in form and tenor as directed by the Secretary of the Treasury under the provisions of this Act and shall bear the



distinctive numbers of the several Federal reserve banks through which they are issued.

When such notes have been prepared, they shall be deposited in the Treasury, or in the subtreasury or mint of the United States nearest the place of business of each Federal reserve bank and shall be held for the use of such bank subject to the order of the Comptroller of the Currency for their delivery, as provided by this Act.

The plates and dies to be procured by the Comptroller of the Currency for the printing of such circulating notes shall remain under his control and direction, and the expenses necessarily incurred in executing the laws relating to the procuring of such notes, and all other expenses incidental to their issue and retirement, shall be paid by the Federal reserve banks, and the Federal Reserve Board shall include in its estimate of expenses levied against the Federal reserve banks a sufficient amount to cover the expenses herein provided for.

The examination of plates, dies, and pieces, and so forth, and regulations relating to such examination of plates, dies, and so forth, of national-bank notes provided for in section fifty-one hundred and seventy-four Revised Statutes, is hereby extended to include notes herein provided for.

Any appropriation heretofore made out of the general funds of the Treasury for engraving plates and dies, the purchase of distinctive paper, or to cover any other expense in connection with the printing of national-bank notes or notes provided for by the Act of May thirtieth, nineteen hundred and eight, and any distinctive paper that may be on hand at the time of the passage of this Act may be used in the discretion of the Secretary for the purposes of this Act, and should the appropriations heretofore made be insufficient to meet the requirements of this Act in addition to circulating notes provided for by existing law, the Secretary is hereby authorized to use so much of any funds in the Treasury not otherwise appropriated for the purpose of furnishing the notes aforesaid: *Provided, however,* That nothing in this section contained shall be construed as exempting national banks or Federal reserve banks from their liability to reimburse the United States for any expenses incurred in printing and issuing circulating notes.

Every Federal reserve bank shall receive on deposit at par from member banks or from Federal reserve banks checks and drafts drawn upon any of its depositors, and when remitted by a Federal reserve bank, checks and drafts drawn by any depositor in any other Federal reserve bank or member bank upon funds to the credit of said depositor in said reserve bank or member bank. Nothing herein contained shall be construed as prohibiting a member bank from charging its actual expense incurred in collecting and remitting funds, or for exchange sold to its patrons. The Federal Reserve Board shall, by rule, fix the charges to be collected by the member banks from its patrons whose checks are cleared through the Federal reserve bank and the charge which may be imposed for the service of clearing or collection rendered by the Federal reserve bank.

The Federal Reserve Board shall make and promulgate from time to time regulations governing the transfer of funds and charges therefor among Federal reserve banks and their branches, and may at its discretion exercise the functions of a clearing house for such Federal reserve banks, or may designate a Federal reserve bank to

20360 0-58-23

PROV

1057
US

Digitized for FRASER
<http://fraser.stlouisfed.org/>
Federal Reserve Bank of St. Louis

2022-011769 MISC Page: 1060 of 2782
09/26/2022 03:35:37 PM Receipt #: 22-9381
Rec Fee: \$30.00 Darrell James Hill
Gila County, Az, Sadie Jo Bingham, Recorder



exercise such functions, and may also require each such bank to exercise the functions of a clearing house for its member banks.

SEC. 17. So much of the provisions of section fifty-one hundred and fifty-nine of the Revised Statutes of the United States, and section four of the Act of June twentieth, eighteen hundred and seventy-four, and section eight of the Act of July twelfth, eighteen hundred and eighty-two, and of any other provisions of existing statutes as require that before any national banking associations shall be authorized to commence banking business it shall transfer and deliver to the Treasurer of the United States a stated amount of United States registered bonds is hereby repealed.

REFUNDING BONDS.

SEC. 18. After two years from the passage of this Act, and at any time during a period of twenty years thereafter, any member bank desiring to retire the whole or any part of its circulating notes, may file with the Treasurer of the United States an application to sell for its account, at par and accrued interest, United States bonds securing circulation to be retired.

The Treasurer shall, at the end of each quarterly period, furnish the Federal Reserve Board with a list of such applications, and the Federal Reserve Board may, in its discretion, require the Federal reserve banks to purchase such bonds from the banks whose applications have been filed with the Treasurer at least ten days before the end of any quarterly period at which the Federal Reserve Board may direct the purchase to be made: *Provided*, That Federal reserve banks shall not be permitted to purchase an amount to exceed \$25,000,000 of such bonds in any one year, and which amount shall include bonds acquired under section four of this Act by the Federal reserve bank.

Provided further, That the Federal Reserve Board shall allot to each Federal reserve bank such proportion of such bonds as the capital and surplus of such bank shall bear to the aggregate capital and surplus of all the Federal reserve banks.

Upon notice from the Treasurer of the amount of bonds so sold for its account, each member bank shall duly assign and transfer, in writing, such bonds to the Federal reserve bank purchasing the same, and such Federal reserve bank shall, thereupon, deposit lawful money with the Treasurer of the United States for the purchase price of such bonds, and the Treasurer shall pay to the member bank selling such bonds any balance due after deducting a sufficient sum to redeem its outstanding notes secured by such bonds, which notes shall be canceled and permanently retired when redeemed.

The Federal reserve banks purchasing such bonds shall be permitted to take out an amount of circulating notes equal to the par value of such bonds.

Upon the deposit with the Treasurer of the United States of bonds so purchased, or any bonds with the circulating privilege acquired under section four of this Act, any Federal reserve bank making such deposit in the manner provided by existing law, shall be entitled to receive from the Comptroller of the Currency circulating notes in blank, registered and countersigned as provided by law, equal in amount to the par value of the bonds so deposited. Such notes



shall be the obligations of the Federal reserve bank procuring the same, and shall be in form prescribed by the Secretary of the Treasury, and to the same tenor and effect as national-bank notes now provided by law. They shall be issued and redeemed under the same terms and conditions as national-bank notes except that they shall not be limited to the amount of the capital stock of the Federal reserve bank issuing them.

Upon application of any Federal reserve bank, approved by the Federal Reserve Board, the Secretary of the Treasury may issue, in exchange for United States two per centum gold bonds bearing the circulation privilege, but against which no circulation is outstanding, one-year gold notes of the United States without the circulation privilege, to an amount not to exceed one-half of the two per centum bonds so tendered for exchange, and thirty-year three per centum gold bonds without the circulation privilege for the remainder of the two per centum bonds so tendered: *Provided*, That at the time of such exchange the Federal reserve bank obtaining such one-year gold notes shall enter into an obligation with the Secretary of the Treasury binding itself to purchase from the United States for gold at the maturity of such one-year notes, an amount equal to those delivered in exchange for such bonds, if so requested by the Secretary, and at each maturity of one-year notes so purchased by such Federal reserve bank, to purchase from the United States such an amount of one-year notes as the Secretary may tender to such bank, not to exceed the amount issued to such bank in the first instance, in exchange for the two per centum United States gold bonds; said obligation to purchase at maturity such notes shall continue in force for a period not to exceed thirty years.

For the purpose of making the exchange herein provided for, the Secretary of the Treasury is authorized to issue at par Treasury notes in coupon or registered form as he may prescribe in denominations of one hundred dollars, or any multiple thereof, bearing interest at the rate of three per centum per annum, payable quarterly, such Treasury notes to be payable not more than one year from the date of their issue in gold coin of the present standard value, and to be exempt as to principal and interest from the payment of all taxes and duties of the United States except as provided by this Act, as well as from taxes in any form by or under State, municipal, or local authorities. And for the same purpose, the Secretary is authorized and empowered to issue United States gold bonds at par, bearing three per centum interest payable thirty years from date of issue, such bonds to be of the same general tenor and effect and to be issued under the same general terms and conditions as the United States three per centum bonds without the circulation privilege now issued and outstanding.

Upon application of any Federal reserve bank, approved by the Federal Reserve Board, the Secretary may issue at par such three per centum bonds in exchange for the one-year gold notes herein provided for.

BANK RESERVES.

Sec. 19. Demand deposits within the meaning of this Act shall comprise all deposits payable within thirty days, and time deposits shall comprise all deposits payable after thirty days, and all savings accounts and certificates of deposit which are subject to not less than thirty days' notice before payment.



When the Secretary of the Treasury shall have officially announced, in such manner as he may elect, the establishment of a Federal reserve bank in any district, every subscribing member bank shall establish and maintain reserves as follows:

(a) A bank not in a reserve or central reserve city as now or hereafter defined shall hold and maintain reserves equal to twelve per centum of the aggregate amount of its demand deposits and five per centum of its time deposits, as follows:

In its vaults for a period of thirty-six months after said date five-twelfths thereof and permanently thereafter four-twelfths.

In the Federal reserve bank of its district, for a period of twelve months after said date, two-twelfths, and for each succeeding six months an additional one-twelfth, until five-twelfths have been so deposited, which shall be the amount permanently required.

For a period of thirty-six months after said date the balance of the reserves may be held in its own vaults, or in the Federal reserve bank, or in national banks in reserve or central reserve cities as now defined by law.

After said thirty-six months' period said reserves, other than those hereinbefore required to be held in the vaults of the member bank and in the Federal reserve bank, shall be held in the vaults of the member bank or in the Federal reserve bank, or in both, at the option of the member bank.

(b) A bank in a reserve city, as now or hereafter defined, shall hold and maintain reserves equal to fifteen per centum of the aggregate amount of its demand deposits and five per centum of its time deposits, as follows:

In its vaults for a period of thirty-six months after said date six-fifteenths thereof, and permanently thereafter five-fifteenths.

In the Federal reserve bank of its district for a period of twelve months after the date aforesaid at least three-fifteenths, and for each succeeding six months an additional one-fifteenth, until six-fifteenths have been so deposited, which shall be the amount permanently required.

For a period of thirty-six months after said date the balance of the reserves may be held in its own vaults, or in the Federal reserve bank, or in national banks in reserve or central reserve cities as now defined by law.

After said thirty-six months' period all of said reserves, except those hereinbefore required to be held permanently in the vaults of the member bank and in the Federal reserve bank, shall be held in its vaults or in the Federal reserve bank, or in both, at the option of the member bank.

(c) A bank in a central reserve city, as now or hereafter defined, shall hold and maintain a reserve equal to eighteen per centum of the aggregate amount of its demand deposits and five per centum of its time deposits, as follows:

In its vaults six-eighteenths thereof.

In the Federal reserve bank seven-eighteenths.

The balance of said reserves shall be held in its own vaults or in the Federal reserve bank, at its option.

Any Federal reserve bank may receive from the member banks as reserves, not exceeding one-half of each installment, eligible paper as



described in section fourteen properly indorsed and acceptable to the said reserve bank.

If a State bank or trust company is required by the law of its State to keep its reserves either in its own vaults or with another State bank or trust company, such reserve deposits so kept in such State bank or trust company shall be construed, within the meaning of this section, as if they were reserve deposits in a national bank in a reserve or central reserve city for a period of three years after the Secretary of the Treasury shall have officially announced the establishment of a Federal reserve bank in the district in which such State bank or trust company is situate. Except as thus provided, no member bank shall keep on deposit with any nonmember bank a sum in excess of ten per centum of its own paid-up capital and surplus. No member bank shall act as the medium or agent of a nonmember bank in applying for or receiving discounts from a Federal reserve bank under the provisions of this Act except by permission of the Federal Reserve Board.

The reserve carried by a member bank with a Federal reserve bank may, under the regulations and subject to such penalties as may be prescribed by the Federal Reserve Board, be checked against and withdrawn by such member bank for the purpose of meeting existing liabilities: *Provided, however,* That no bank shall at any time make new loans or shall pay any dividends unless and until the total reserve required by law is fully restored.

In estimating the reserves required by this Act, the net balance of amounts due to and from other banks shall be taken as the basis for ascertaining the deposits against which reserves shall be determined. Balances in reserve banks due to member banks shall, to the extent herein provided, be counted as reserves.

National banks located in Alaska or outside the continental United States may remain nonmember banks, and shall in that event maintain reserves and comply with all the conditions now provided by law regulating them; or said banks, except in the Philippine Islands, may, with the consent of the Reserve Board, become member banks of any one of the reserve districts, and shall, in that event, take stock, maintain reserves, and be subject to all the other provisions of this Act.

SEC. 20. So much of sections two and three of the Act of June twentieth, eighteen hundred and seventy-four, entitled "An Act fixing the amount of United States notes, providing for a redistribution of the national bank currency, and for other purposes," as provides that the fund deposited by any national banking association with the Treasurer of the United States for the redemption of its notes shall be counted as a part of its lawful reserve as provided in the Act aforesaid, is hereby repealed. And from and after the passage of this Act such fund of five per centum shall in no case be counted by any national banking association as a part of its lawful reserve.

BANK EXAMINATIONS.

10601
SEC. 21. Section fifty-two hundred and forty, United States Revised Statutes, is amended to read as follows:

The Comptroller of the Currency, with the approval of the Secretary of the Treasury, shall appoint examiners who shall examine



every member bank at least twice in each calendar year and oftener if considered necessary: *Provided, however,* That the Federal Reserve Board may authorize examination by the State authorities to be accepted in the case of State banks and trust companies and may at any time direct the holding of a special examination of State banks or trust companies that are stockholders in any Federal reserve bank. The examiner making the examination of any national bank, or of any other member bank, shall have power to make a thorough examination of all the affairs of the bank and in doing so he shall have power to administer oaths and to examine any of the officers and agents thereof under oath and shall make a full and detailed report of the condition of said bank to the Comptroller of the Currency.

The Federal Reserve Board, upon the recommendation of the Comptroller of the Currency, shall fix the salaries of all bank examiners and make report thereof to Congress. The expense of the examinations herein provided for shall be assessed by the Comptroller of the Currency upon the banks examined in proportion to assets or resources held by the banks upon the dates of examination of the various banks.

In addition to the examinations made and conducted by the Comptroller of the Currency, every Federal reserve bank may, with the approval of the Federal reserve agent or the Federal Reserve Board, provide for special examination of member banks within its district. The expense of such examinations shall be borne by the bank examined. Such examinations shall be so conducted as to inform the Federal reserve bank of the condition of its member banks and of the lines of credit which are being extended by them. Every Federal reserve bank shall at all times furnish to the Federal Reserve Board such information as may be demanded concerning the condition of any member bank within the district of the said Federal reserve bank.

No bank shall be subject to any visitatorial powers other than such as are authorized by law, or vested in the courts of justice or such as shall be or shall have been exercised or directed by Congress, or by either House thereof or by any committee of Congress or of either House duly authorized.

The Federal Reserve Board shall, at least once each year, order an examination of each Federal reserve bank, and upon joint application of ten member banks the Federal Reserve Board shall order a special examination and report of the condition of any Federal reserve bank.

SEC. 22. No member bank or any officer, director, or employee thereof shall hereafter make any loan or grant any gratuity to any bank examiner. Any bank officer, director, or employee violating this provision shall be deemed guilty of a misdemeanor and shall be imprisoned not exceeding one year or fined not more than \$5,000, or both; and may be fined a further sum equal to the money so loaned or gratuity given. Any examiner accepting a loan or gratuity from any bank examined by him or from an officer, director, or employee thereof shall be deemed guilty of a misdemeanor and shall be imprisoned not exceeding one year or fined not more than \$5,000, or both; and may be fined a further sum equal to the money so loaned or gratuity given; and shall forever thereafter be disqualified from holding office as a national-bank examiner. No national-bank examiner shall perform



any other service for compensation while holding such office for any bank or officer, director, or employee thereof.

Other than the usual salary or director's fee paid to any officer, director, or employee of a member bank and other than a reasonable fee paid by said bank to such officer, director, or employee for services rendered to such bank, no officer, director, employee, or attorney of a member bank shall be a beneficiary of or receive, directly or indirectly, any fee, commission, gift, or other consideration for or in connection with any transaction or business of the bank. No examiner, public or private, shall disclose the names of borrowers or the collateral for loans of a member bank to other than the proper officers of such bank without first having obtained the express permission in writing from the Comptroller of the Currency, or from the board of directors of such bank, except when ordered to do so by a court of competent jurisdiction, or by direction of the Congress of the United States, or of either House thereof, or any committee of Congress or of either House duly authorized. Any person violating any provision of this section shall be punished by a fine of not exceeding \$5,000 or by imprisonment not exceeding one year, or both.

Except as provided in existing laws, this provision shall not take effect until sixty days after the passage of this Act.

SEC. 23. The stockholders of every national banking association shall be held individually responsible for all contracts, debts, and engagements of such association, each to the amount of his stock therein, at the par value thereof in addition to the amount invested in such stock. The stockholders in any national banking association who shall have transferred their shares or registered the transfer thereof within sixty days next before the date of the failure of such association to meet its obligations, or with knowledge of such impending failure, shall be liable to the same extent as if they had made no such transfer, to the extent that the subsequent transferee fails to meet such liability; but this provision shall not be construed to affect in any way any recourse which such shareholders might otherwise have against those in whose names such shares are registered at the time of such failure.

LOANS ON FARM LANDS.

SEC. 24. Any national banking association not situated in a central reserve city may make loans secured by improved and unencumbered farm land, situated within its Federal reserve district, but no such loan shall be made for a longer time than five years, nor for an amount exceeding fifty per centum of the actual value of the property offered as security. Any such bank may make such loans in an aggregate sum equal to twenty-five per centum of its capital and surplus or to one-third of its time deposits and such banks may continue hereafter as heretofore to receive time deposits and to pay interest on the same.

The Federal Reserve Board shall have power from time to time to add to the list of cities in which national banks shall not be permitted to make loans secured upon real estate in the manner described in this section.

1063



FOREIGN BRANCHES.

SEC. 25. Any national banking association possessing a capital and surplus of \$1,000,000 or more may file application with the Federal Reserve Board, upon such conditions and under such regulations as may be prescribed by the said board, for the purpose of securing authority to establish branches in foreign countries or dependencies of the United States for the furtherance of the foreign commerce of the United States, and to act, if required to do so, as fiscal agents of the United States. Such application shall specify, in addition to the name and capital of the banking association filing it, the place or places where the banking operations proposed are to be carried on, and the amount of capital set aside for the conduct of its foreign business. The Federal Reserve Board shall have power to approve or to reject such application if, in its judgment, the amount of capital proposed to be set aside for the conduct of foreign business is inadequate, or if for other reasons the granting of such application is deemed inexpedient.

Every national banking association which shall receive authority to establish foreign branches shall be required at all times to furnish information concerning the condition of such branches to the Comptroller of the Currency upon demand, and the Federal Reserve Board may order special examinations of the said foreign branches at such time or times as it may deem best. Every such national banking association shall conduct the accounts of each foreign branch independently of the accounts of other foreign branches established by it and of its home office, and shall at the end of each fiscal period transfer to its general ledger the profit or loss accruing at each branch as a separate item.

SEC. 26. All provisions of law inconsistent with or superseded by any of the provisions of this Act are to that extent and to that extent only hereby repealed: *Provided*, Nothing in this Act contained shall be construed to repeal the parity provision or provisions contained in an Act approved March fourteenth, nineteen hundred entitled "An Act to define and fix the standard of value, to maintain the parity of all forms of money issued or coined by the United States, to refund the public debt, and for other purposes," and the Secretary of the Treasury may for the purpose of maintaining such parity and to strengthen the gold reserve, borrow gold on the security of United States bonds authorized by section two of the Act last referred to or for one-year gold notes bearing interest at a rate of not to exceed three per centum per annum, or sell the same if necessary to obtain gold. When the funds of the Treasury on hand justify, he may purchase and retire such outstanding bonds and notes.

SEC. 27. The provisions of the Act of May thirtieth, nineteen hundred and eight, authorizing national currency associations, the issue of additional national-bank circulation, and creating a National Monetary Commission, which expires by limitation under the terms of such Act on the thirtieth day of June, nineteen hundred and fourteen, are hereby extended to June thirtieth, nineteen hundred and fifteen, and sections fifty-one hundred and fifty-three, fifty-one hundred and seventy-two, fifty-one hundred and ninety-one, and fifty-two hundred and fourteen of the Revised Statutes of the United States, which were amended by the Act of May thirtieth, nineteen



hundred and eight, are hereby reenacted to read as such sections read prior to May thirtieth, nineteen hundred and eight, subject to such amendments or modifications as are prescribed in this Act: *Provided, however,* That section nine of the Act first referred to in this section is hereby amended so as to change the tax rates fixed in said Act by making the portion applicable thereto read as follows:

National banking associations having circulating notes secured otherwise than by bonds of the United States, shall pay for the first three months a tax at the rate of three per centum per annum upon the average amount of such of their notes in circulation as are based upon the deposit of such securities, and afterwards an additional tax rate of one-half of one per centum per annum for each month until a tax of six per centum per annum is reached, and thereafter such tax of six per centum per annum upon the average amount of such notes.

SEC. 28. Section fifty-one hundred and forty-three of the Revised Statutes is hereby amended and reenacted to read as follows: Any association formed under this title may, by the vote of shareholders owning two-thirds of its capital stock, reduce its capital to any sum not below the amount required by this title to authorize the formation of associations; but no such reduction shall be allowable which will reduce the capital of the association below the amount required for its outstanding circulation, nor shall any reduction be made until the amount of the proposed reduction has been reported to the Comptroller of the Currency and such reduction has been approved by the said Comptroller of the Currency and by the Federal Reserve Board, or by the organization committee pending the organization of the Federal Reserve Board.

SEC. 29. If any clause, sentence, paragraph, or part of this Act shall for any reason be adjudged by any court of competent jurisdiction to be invalid, such judgment shall not affect, impair, or invalidate the remainder of this Act, but shall be confined in its operation to the clause, sentence, paragraph, or part thereof directly involved in the controversy in which such judgment shall have been rendered.

SEC. 30. The right to amend, alter, or repeal this Act is hereby expressly reserved.

Approved, December 23, 1913.



Unofficial Copy

1066

Digitized for FRASER
<http://fraser.stlouisfed.org/>
Federal Reserve Bank of St. Louis

2022-011769 MISC Page: 1069 of 2782
09/26/2022 03:35:37 PM Receipt #: 22-9381
Rec Fee: \$30.00 Darrell James Hill
Gila County, Az, Sadie Jo Bingham, Recorder



INDEX TO FEDERAL RESERVE ACT.

	Page.	Section.
A.		
APPLICATION For Membership Federal Reserve Bank.....	4	4
B.		
BANK Definition.....	1	1
BANK EXAMINATIONS See Examinations.		
BANK RESERVES See Reserve.		
BOARD Definition.....	1	1
Federal Reserve. (See Federal Reserve Board.)		
BRANCH BANKS How established.....	3	3
Managed by Board of Directors.....	3	3
How Selected.....	3	3
Manager of.....	3	3
BRANCH OFFICES See Branch Banks.		
D.		
DEMAND DEPOSITS Definition.....	21	19
DIRECTORS of Federal Reserve Banks.....	5	4
of Branch Banks.....	3	3
of Member banks, fees or commissions for loans prohibited.....	25	22
Penalty for.....	25	22
DISSOLUTION of Member Banks effect.....	2	2
DISTRICT Definition.....	1	1
DIVISION OF EARNINGS See Earnings.		
E.		
EARNINGS of Federal Reserve Banks.....	8	7
How distributed.....	8	7
Dividends to Stockholders.....	8	7
U. S. franchise tax.....	8	7
Surplus fund.....	8	7
U. S. Earnings, how applied.....	8	7
EMERGENCY CURRENCY Limitations of, Act of May 30, 1908, extended to June 30, 1915.....	26	27
EXAMINATIONS of Member Banks.....	24	21
Periodical.....	24	21
Special examinations by order of Federal Reserve Board.....	24	21
By Federal Reserve Banks.....	24	21
Expenses of, how paid.....	24	21
Other visitorial powers.....	24	21

(28)

Digitized for FRASER
<http://fraser.stlouisfed.org/>
 Federal Reserve Bank of St. Louis

2022-011769 MISC Page: 1070 of 2782
 09/26/2022 03:35:37 PM Receipt #: 22-9381
 Rec Fee: \$30.00 Darrell James Hill
 Gila County, Az, Sadie Jo Bingham, Recorder



1067

	Page.	Section.
EXAMINERS		
How appointed.....	23	21
Salaries.....	24	21
Not to receive gratuities from banks examined.....	24	22
Penalty for.....	24	22
Not to perform other services for banks examined.....	25	22
F.		
FARM LANDS		
See Loans on Farm Lands.		
FEDERAL ADVISORY COUNCIL		
How appointed.....	14	12
Meetings.....	14	12
Powers.....	14	12
FEDERAL RESERVE AGENT.		
Salary.....	6	4
Deputy.....	7	4
FEDERAL RESERVE BANKS		
Organized by Reserve Bank Organization Committee.....	1	2
Name of.....	1	2
National Banks to signify intention to become members.....	2	2
Subscription of member banks 6% of capital & surplus.....	1	2
Stock (see stock).....	7	5
Payments, how made.....	2	2
How organized.....	4	4
Powers.....	4	4
	14	13
	15	14
	16	14
Directors, how elected.....	5	4
Class A by Member Banks.....	5	4
Class B by Member Banks.....	5	4
Class C by Federal Reserve Board.....	5	4
No senator or congressman eligible.....	5	4
Electors selected from groups.....	6	4
Preferential ballot.....	6	4
Directors, salaries & expenses.....	7	4
Decrease and increase of stock.....	7	5
May be Government depositories and required to act as fiscal agents.....	16	15
To receive checks at par.....	19	16
Required to purchase 2% Government bonds at par after two years.....	20	18
Limitation of purchase.....	20	18
May issue notes against bonds purchased.....	21	18
May exchange 2% bonds purchased for 3% bonds.....	21	18
Must re-purchase one-year bonds from year to year.....	21	18
FEDERAL RESERVE BOARD		
How appointed.....	11	10
Secretary of the Treasury, Comptroller of the Currency, members ex officio.....	11	10
Salaries.....	11	10
Terms of office.....	11	10
Expenses, how paid.....	11	10
First meeting.....	11	10
Members ineligible to serve as Directors or officers of member banks for two years after retirement.....	11	10
Vacancies, how filled.....	12	10
Powers in conflict with those of the Secretary of the Treasury.....	12	10
To supervise issue of Federal Reserve Notes.....	12	10
General powers.....	12	11
General powers.....	13	11
Power to fix rules governing exchange charges.....	19	16
To act as clearing house for Federal Reserve Banks.....	19	16

1068



	Page.	Section.
FEDERAL RESERVE CITIES		
Number.....	1	2
Designated by.....	1	2
How determined.....	1	2
Subject to review by.....	1	2
FEDERAL RESERVE DISTRICTS		
Number.....	1	2
Designated by number.....	1	2
How changed.....	1	2
Reviewed by.....	1	2
FEDERAL RESERVE NOTES		
How issued.....	17	16
Term and effect.....	17	16
Reserve against, held by banks.....	17	16
Redemption of.....	17	16
Withdrawal of collateral security for.....	18	16
How printed.....	18	16
Where deposited.....	19	16
Denominations.....	18	16
Delivered to Federal Reserve Agent.....	19	16
Appropriation for.....	19	16
Expenses of issue, how paid.....	19	16
FOREIGN BRANCHES		
National banks may establish when.....	26	25
Regulations to be prescribed by Federal Reserve Board.....	26	25
May be required to act as fiscal agents of United States.....	26	25
G.		
GOLD RESERVE		
Secretary to maintain.....	26	26
GOVERNMENT DEPOSITS		
May be made with Federal Reserve Banks.....	16	15
With Member Banks.....	16	15
I.		
INCONSISTENT LAWS REPEALED.....		
	26	26
L.		
LOANS ON FARM LANDS		
Member banks not in reserve cities may make.....	25	24
Federal Reserve Board may extend list.....	25	24
Amount and time of such loans.....	25	24
N.		
NATIONAL BANK.		
Definition.....	1	1
Limitation of liabilities extended to include debts due Federal Reserve Banks.....	15	13
Need not deposit U. S. Government bonds before commencing business.....	20	17
Reduction of Capital Stock, how affected.....	27	28
NOTE ISSUE		
See Federal Reserve Notes		
O.		
ORGANIZATION COMMITTEE		
See Reserve Bank Organization Committee.		
P.		
PENALTY		
For failure to signify acceptance of provisions of this act.....	2	2
For violating provisions.....	2	2
For violating provisions by State Bank Members.....	10	9



	Page.	Section.
R.		
RESERVE BANK		
Definition.....	1	1
RESERVE BANK ORGANIZATION COMMITTEE		
Composed of.....	1	2
Powers.....	2	2
S.		
STATE BANKS		
Converted to National Banks.....	9	8
May become Members as State Banks.....	9	9
Conditions of membership.....	9	9
Regulations.....	10	9
Must be eligible to conversion as National Banks.....	10	9
Penalty for violation of provisions.....	10	9
Reserve required.....	23	10
Stock		
Member banks.....	3	2
Public stock.....	3	2
Non Voting.....	3	2
U. S. Stock.....	3	2
How Public and U. S. stock transferred.....	3	2
Minimum Capital for any Federal Reserve Bank.....	3	2

1070

Digitized for FRASER
<http://fraser.stlouisfed.org/>
 Federal Reserve Bank of St. Louis

2022-011769 MISC Page: 1073 of 2782
 09/26/2022 03:35:37 PM Receipt #: 22-9381
 Rec Fee: \$30.00 Darrell James Hill
 Gila County, Az, Sadie Jo Bingham, Recorder



[CHAPTER 38.]

AN ACT

May 27, 1933.
[H.R. 5430.]
[Public, No. 22.]

To provide full and fair disclosure of the character of securities sold in interstate and foreign commerce and through the mails, and to prevent frauds in the sale thereof, and for other purposes.

Securities Act of 1933.
I'ed. p. 1026.

Be it enacted by the Senate and House of Representatives of the United States of America in Congress assembled,

TITLE I

SHORT TITLE

Title cited. SECTION 1. This title may be cited as the "Securities Act of 1933".

DEFINITIONS

Definitions. SEC. 2. When used in this title, unless the context otherwise requires—

"Security." Post, p 905. (1) The term "security" means any note, stock, treasury stock, bond, debenture, evidence of indebtedness, certificate of interest or participation in any profit-sharing agreement, collateral-trust certificate, preorganization certificate or subscription, transferable share, investment contract, voting-trust certificate, certificate of interest in property, tangible or intangible, or, in general, any instrument commonly known as a security, or any certificate of interest or participation in, temporary or interim certificate for, receipt for, or warrant or right to subscribe to or purchase, any of the foregoing.

"Person." (2) The term "person" means an individual, a corporation, a partnership, an association, a joint-stock company, a trust, any unincorporated organization, or a government or political subdivision thereof. As used in this paragraph the term "trust" shall include only a trust where the interest or interests of the beneficiary or beneficiaries are evidenced by a security.

"Trust." "Sale," etc. (3) The term "sale", "sell", "offer to sell", or "offer for sale" shall include every contract of sale or disposition of, attempt or offer to dispose of, or solicitation of an offer to buy, a security or interest in a security, for value; except that such terms shall not include preliminary negotiations or agreements between an issuer and any underwriter. Any security given or delivered with, or as a bonus on account of, any purchase of securities or any other thing, shall be conclusively presumed to constitute a part of the subject of such purchase and to have been sold for value. The issue or transfer of a right or privilege, when originally issued or transferred with a security, giving the holder of such security the right to convert such security into another security of the same issuer or of another person, or giving a right to subscribe to another security of the same issuer or of another person, which right cannot be exercised until some future date, shall not be deemed to be a sale of such other security; but the issue or transfer of such other security upon the exercise of such right of conversion or subscription shall be deemed a sale of such other security.

When conversion right exercised. "Issuer." (4) The term "issuer" means every person who issues or proposes to issue any security or who guarantees a security either as to principal or income; except that with respect to certificates of deposit, voting-trust certificates, or collateral-trust certificates, or with respect to certificates of interest or shares in an unincorporated investment trust not having a board of directors (or persons performing similar functions) or of the fixed, restricted management, or unit type, the

1071

2022-011769 MISC Page: 1074 of 2782
09/26/2022 03:35:37 PM Receipt #: 22-9381
Rec Fee: \$30.00 Darrell James Hill
Gila County, Az, Sadie Jo Bingham, Recorder



term "issuer" means the person or persons performing the acts and assuming the duties of depositor or manager pursuant to the provisions of the trust or other agreement or instrument under which such securities are issued; and except that with respect to equipment-trust certificates or like securities, the term "issuer" means the person by whom the equipment or property is or is to be used.

(5) The term "Commission" means the Federal Trade Commission.

(6) The term "Territory" means Alaska, Hawaii, Puerto Rico, the Philippine Islands, Canal Zone, the Virgin Islands, and the insular possessions of the United States.

(7) The term "interstate commerce" means trade or commerce in securities or any transportation or communication relating thereto among the several States or between the District of Columbia or any Territory of the United States and any State or other Territory, or between any foreign country and any State, Territory, or the District of Columbia, or within the District of Columbia.

(8) The term "registration statement" means the statement provided for in section 6. and includes any amendment thereto and any report, document, or memorandum accompanying such statement or incorporated therein by reference.

(9) The term "write" or "written" shall include printed, lithographed, or any means of graphic communication.

(10) The term "prospectus" means any prospectus, notice, circular, advertisement, letter, or communication, written or by radio, which offers any security for sale; except that (a) a communication shall not be deemed a prospectus if it is proved that prior to such communication a written prospectus meeting the requirements of section 10 was received, by the person to whom the communication was made, from the person making such communication or his principal, and (b) a notice, circular, advertisement, letter, or communication in respect of a security shall not be deemed to be a prospectus if it states from whom a written prospectus meeting the requirements of section 10 may be obtained and, in addition, does no more than identify the security, state the price thereof, and state by whom orders will be executed.

(11) The term "underwriter" means any person who has purchased from an issuer with a view to, or sells for an issuer in connection with, the distribution of any security, or participates or has a direct or indirect participation in any such undertaking, or participates or has a participation in the direct or indirect underwriting of any such undertaking; but such term shall not include a person whose interest is limited to a commission from an underwriter or dealer not in excess of the usual and customary distributors' or sellers' commission. As used in this paragraph the term "issuer" shall include, in addition to an issuer, any person directly or indirectly controlling or controlled by the issuer, or any person under direct or indirect common control with the issuer.

(12) The term "dealer" means any person who engages either for all or part of his time, directly or indirectly, as agent, broker, or principal, in the business of offering, buying, selling, or otherwise dealing or trading in securities issued by another person.

Equipment-trust securities.

"Commission"

"Territory."

"Interstate commerce."

"Registration statement." Post, p. 78.

"Write" or "written."

"Prospectus."

Exceptions.

Post, pp. 81, 805.

"Underwriter."

Persons not included.

"Issuer."

"Dealer."

EXEMPTED SECURITIES

SEC. 3. (a) Except as hereinafter expressly provided, the provisions of this title shall not apply to any of the following classes of securities:

Exempted securities.

1072



- Prior sale. (1) Any security which, prior to or within sixty days after the enactment of this title, has been sold or disposed of by the issuer or bona fide offered to the public, but this exemption shall not apply to any new offering of any such security by an issuer or underwriter subsequent to such sixty days;
- New offering excluded. (2) Any security issued or guaranteed by the United States or any Territory thereof, or by the District of Columbia, or by any State of the United States, or by any political subdivision of a State or Territory, or by any public instrumentality of one or more States or Territories exercising an essential governmental function, or by any corporation created and controlled or supervised by and acting as an instrumentality of the Government of the United States pursuant to authority granted by the Congress of the United States, or by any national bank, or by any banking institution organized under the laws of any State or Territory, the business of which is substantially confined to banking and is supervised by the State or territorial banking commission or similar official; or any security issued by or representing an interest in or a direct obligation of a Federal reserve bank;
- Securities guaranteed by United States, State, or political subdivision, etc. Post, p. 906. (3) Any note, draft, bill of exchange, or banker's acceptance which arises out of a current transaction or the proceeds of which have been or are to be used for current transactions, and which has a maturity at the time of issuance of not exceeding nine months, exclusive of days of grace, or any renewal thereof the maturity of which is likewise limited;
- Government corporations. (4) Any security issued by a corporation organized and operated exclusively for religious, educational, benevolent, fraternal, charitable, or reformatory purposes and not for pecuniary profit, and no part of the net earnings of which inures to the benefit of any person, private stockholder, or individual;
- National, etc., banks. (5) Any security issued by a building and loan association, home-
stead association, savings and loan association, or similar institution, substantially all the business of which is confined to the making of loans to members (but the foregoing exemption shall not apply with respect to any such security where the issuer takes from the total amount paid or deposited by the purchaser, by way of any fee, cash value or other device whatsoever, either upon termination of the investment at maturity or before maturity, an aggregate amount in excess of 3 per centum of the face value of such security), or any security issued by a farmers' cooperative association as defined in paragraphs (12), (13), and (14) of section 103 of the Revenue Act of 1932;
- Federal reserve bank obligations. (6) Any security issued by a common carrier which is subject to the provisions of section 20a of the Interstate Commerce Act, as amended;
- Current transactions. (7) Certificates issued by a receiver or by a trustee in bankruptcy, with the approval of the court;
- Short-term paper. (8) Any insurance or endowment policy or annuity contract or optional annuity contract, issued by a corporation subject to the supervision of the insurance commissioner, bank commissioner, or any agency or officer performing like functions, of any State or Territory of the United States or the District of Columbia.
- Religious, etc., organizations. Post, p. 906. (b) The Commission may from time to time by its rules and regulations, and subject to such terms and conditions as may be prescribed therein, add any class of securities to the securities exempted as provided in this section, if it finds that the enforcement of this title with respect to such securities is not necessary in the public interest and for the protection of investors by reason of the small amount
- Building and loan associations, etc., where business substantially confined to members. Exception.
- Farmers' cooperatives. Vol. 47, pp. 193, 194.
- Common carriers. Vol. 41, p. 484. U.S.C., p. 1070.
- Certificates in bankruptcy proceedings.
- Annuity contracts, etc. Post, p. 906.
- Additional classes permitted.



involved or the limited character of the public offering; but no issue of securities shall be exempted under this subsection where the aggregate amount at which such issue is offered to the public exceeds \$100,000.

EXEMPTED TRANSACTIONS

SEC. 4. The provisions of section 5 shall not apply to any of the following transactions:

- (1) Transactions by any person other than an issuer, underwriter, or dealer; transactions by an issuer not with or through an underwriter and not involving any public offering; or transactions by a dealer (including an underwriter no longer acting as an underwriter in respect of the security involved in such transaction), except transactions within one year after the last date upon which the security was bona fide offered to the public by the issuer or by or through an underwriter (excluding in the computation of such year any time during which a stop order issued under section 8 is in effect as to the security), and except transactions as to securities constituting the whole or a part of an unsold allotment to or subscription by such dealer as a participant in the distribution of such securities by the issuer or by or through an underwriter.
- (2) Brokers' transactions, executed upon customers' orders on any exchange or in the open or counter market, but not the solicitation of such orders.
- (3) The issuance of a security of a person exchanged by it with its existing security holders exclusively, where no commission or other remuneration is paid or given directly or indirectly in connection with such exchange; or the issuance of securities to the existing security holders or other existing creditors of a corporation in the process of a bona fide reorganization of such corporation under the supervision of any court, either in exchange for the securities of such security holders or claims of such creditors or partly for cash and partly in exchange for the securities or claims of such security holders or creditors.

Restriction.

Exempted transactions.

By individuals. Post, p. 906.

Post, p. 70.

Brokers' transactions.

Issuance of securities to existing security holders, creditors, etc.

PROHIBITIONS RELATING TO INTERSTATE COMMERCE AND THE MAILS

SEC. 5. (a) Unless a registration statement is in effect as to a security, it shall be unlawful for any person, directly or indirectly—

- (1) to make use of any means or instruments of transportation or communication in interstate commerce or of the mails to sell or offer to buy such security through the use or medium of any prospectus or otherwise; or
- (2) to carry or cause to be carried through the mails or in interstate commerce, by any means or instruments of transportation, any such security for the purpose of sale or for delivery after sale.
- (b) It shall be unlawful for any person, directly or indirectly—
 - (1) to make use of any means or instruments of transportation or communication in interstate commerce or of the mails to carry or transmit any prospectus relating to any security registered under this title, unless such prospectus meets the requirements of section 10; or
 - (2) to carry or to cause to be carried through the mails or in interstate commerce any such security for the purpose of sale or for delivery after sale, unless accompanied or preceded by a prospectus that meets the requirements of section 10.
- (c) The provisions of this section relating to the use of the mails shall not apply to the sale of any security where the issue of which

Prohibitions relating to interstate commerce and the mails.

Transmission of broker's prospectus, etc.

Transporting such security for sale or delivery after sale.

Unlawful to transmit. Prospectus relating to registered security.

Post, p. 81.

Security.

Intrastate sales excluded. Post, p. 900.

1074



it is a part is sold only to persons resident within a single State or Territory, where the issuer of such securities is a person resident and doing business within, or, if a corporation, incorporated by and doing business within, such State or Territory.

REGISTRATION OF SECURITIES AND SIGNING OF REGISTRATION STATEMENT

Registration of securities and signing of registration statement.

Foreign or Territorial person.

Security of foreign governments.

Signatures.

Unauthorized signing.

Filing fee.

Registration statement effective on filing, etc.

Availability of registration information.

Not operative first 40 days.

SEC. 6. (a) Any security may be registered with the Commission under the terms and conditions hereinafter provided, by filing a registration statement in triplicate, at least one of which shall be signed by each issuer, its principal executive officer or officers, its principal financial officer, its comptroller or principal accounting officer, and the majority of its board of directors or persons performing similar functions (or, if there is no board of directors or persons performing similar functions, by the majority of the persons or board having the power of management of the issuer), and in case the issuer is a foreign or Territorial person by its duly authorized representative in the United States; except that when such registration statement relates to a security issued by a foreign government, or political subdivision thereof, it need be signed only by the underwriter of such security. Signatures of all such persons when written on the said registration statements shall be presumed to have been so written by authority of the person whose signature is so affixed and the burden of proof, in the event such authority shall be denied, shall be upon the party denying the same. The affixing of any signature without the authority of the purported signer shall constitute a violation of this title. A registration statement shall be deemed effective only as to the securities specified therein as proposed to be offered.

(b) At the time of filing a registration statement the applicant shall pay to the Commission a fee of one one-hundredth of 1 per centum of the maximum aggregate price at which such securities are proposed to be offered, but in no case shall such fee be less than \$25.

(c) The filing with the Commission of a registration statement, or of an amendment to a registration statement, shall be deemed to have taken place upon the receipt thereof, but the filing of a registration statement shall not be deemed to have taken place unless it is accompanied by a United States postal money order or a certified bank check or cash for the amount of the fee required under subsection (b).

(d) The information contained in or filed with any registration statement shall be made available to the public under such regulations as the Commission may prescribe, and copies thereof, photostatic or otherwise, shall be furnished to every applicant at such reasonable charge as the Commission may prescribe.

(e) No registration statement may be filed within the first forty days following the enactment of this Act.

INFORMATION REQUIRED IN REGISTRATION STATEMENT

Information required: Schedules.

Post, p. 88.

Foreign government securities.

Post, p. 91.

Optional, in certain classes.

SEC. 7. The registration statement, when relating to a security other than a security issued by a foreign government, or political subdivision thereof, shall contain the information, and be accompanied by the documents, specified in Schedule A, and when relating to a security issued by a foreign government, or political subdivision thereof, shall contain the information, and be accompanied by the documents, specified in Schedule B; except that the Commission may by rules or regulations provide that any such information or document need not be included in respect of any class of issuers or securities if it finds that the requirement of such information or document is inapplicable to such class and that disclosure fully adequate for the protection of investors is otherwise required to be

2022-011769 MISC Page: 1078 of 2782
09/26/2022 03:35:37 PM Receipt #: 22-9381
Rec Fee: \$30.00 Darrell James Hill
Gila County, Az, Sadie Jo Bingham, Recorder



included within the registration statement. If any accountant, engineer, or appraiser, or any person whose profession gives authority to a statement made by him, is named as having prepared or certified any part of the registration statement, or is named as having prepared or certified a report or valuation for use in connection with the registration statement, the written consent of such person shall be filed with the registration statement. If any such person is named as having prepared or certified a report or valuation (other than a public official document or statement) which is used in connection with the registration statement, but is not named as having prepared or certified such report or valuation for use in connection with the registration statement, the written consent of such person shall be filed with the registration statement unless the Commission dispenses with such filing as impracticable or as involving undue hardship on the person filing the registration statement. Any such registration statement shall contain such other information, and be accompanied by such other documents, as the Commission may by rules or regulations require as being necessary or appropriate in the public interest or for the protection of investors.

Professional statements.

Written consent to use, required.

Additional information, etc.

TAKING EFFECT OF REGISTRATION STATEMENTS AND AMENDMENTS THERE TO

Registration statements and amendments thereto.

SEC. 8. (a) The effective date of a registration statement shall be the twentieth day after the filing thereof, except as hereinafter provided, and except that in case of securities of any foreign public authority, which has continued the full service of its obligations in the United States, the proceeds of which are to be devoted to the refunding of obligations payable in the United States, the registration statement shall become effective seven days after the filing thereof. If any amendment to any such statement is filed prior to the effective date of such statement, the registration statement shall be deemed to have been filed when such amendment was filed; except that an amendment filed with the consent of the Commission, prior to the effective date of the registration statement, or filed pursuant to an order of the Commission, shall be treated as a part of the registration statement.

Effective date.

Foreign securities.

(b) If it appears to the Commission that a registration statement is on its face incomplete or inaccurate in any material respect, the Commission may, after notice by personal service or the sending of confirmed telegraphic notice not later than ten days after the filing of the registration statement, and opportunity for hearing (at a time fixed by the Commission) within ten days after such notice by personal service or the sending of such telegraphic notice, issue an order prior to the effective date of registration refusing to permit such statement to become effective until it has been amended in accordance with such order. When such statement has been amended in accordance with such order the Commission shall so declare and the registration shall become effective at the time provided in subsection (a) or upon the date of such declaration, whichever date is the later.

Incomplete or inaccurate statements.

Opportunity to amend.

Effective date of amended statement.

(c) An amendment filed after the effective date of the registration statement, if such amendment, upon its face, appears to the Commission not to be incomplete or inaccurate in any material respect, shall become effective on such date as the Commission may determine, having due regard to the public interest and the protection of investors.

Amendment filed after effective date.

Determination of date, if not defective.

(d) If it appears to the Commission at any time that the registration statement includes any untrue statement of a material fact or

Stop order provisions.

1076



Notice.

omits to state any material fact required to be stated therein or necessary to make the statements therein not misleading, the Commission may, after notice by personal service or the sending of confirmed telegraphic notice, and after opportunity for hearing (at a time fixed by the Commission) within fifteen days after such notice by personal service or the sending of such telegraphic notice, issue a stop order suspending the effectiveness of the registration statement. When such statement has been amended in accordance with such stop order the Commission shall so declare and thereupon the stop order shall cease to be effective.

Investigations authorized. Powers of Commission.

(e) The Commission is hereby empowered to make an examination in any case in order to determine whether a stop order should issue under subsection (d). In making such examination the Commission or any officer or officers designated by it shall have access to and may demand the production of any books and papers of, and may administer oaths and affirmations to and examine, the issuer, underwriter, or any other person, in respect of any matter relevant to the examination, and may, in its discretion, require the production of a balance sheet exhibiting the assets and liabilities of the issuer, or its income statement, or both, to be certified to by a public or certified accountant approved by the Commission. If the issuer or underwriter shall fail to cooperate, or shall obstruct or refuse to permit the making of an examination, such conduct shall be proper ground for the issuance of a stop order.

Grounds for issuance of stop order.

Service of notice.

(f) Any notice required under this section shall be sent to or served on the issuer, or, in case of a foreign government or political subdivision thereof, to or on the underwriter, or, in the case of a foreign or Territorial person, to or on its duly authorized representative in the United States named in the registration statement, properly directed in each case of telegraphic notice to the address given in such statement.

Court review of Commission's orders.

COURT REVIEW OF ORDERS

Petition allowed to appropriate circuit court of appeals, etc.

SEC. 9. (a) Any person aggrieved by an order of the Commission may obtain a review of such order in the Circuit Court of Appeals of the United States, within any circuit wherein such person resides or has his principal place of business, or in the Court of Appeals of the District of Columbia, by filing in such court, within sixty days after the entry of such order, a written petition praying that the order of the Commission be modified or be set aside in whole or in part. A copy of such petition shall be forthwith served upon the Commission, and thereupon the Commission shall certify and file in the court a transcript of the record upon which the order complained of was entered. No objection to the order of the Commission shall be considered by the court unless such objection shall have been urged before the Commission. The finding of the Commission as to the facts, if supported by evidence, shall be conclusive. If either party shall apply to the court for leave to adduce additional evidence, and shall show to the satisfaction of the court that such additional evidence is material and that there were reasonable grounds for failure to adduce such evidence in the hearing before the Commission, the court may order such additional evidence to be taken before the Commission and to be adduced upon the hearing in such manner and upon such terms and conditions as to the court may seem proper. The Commission may modify its findings as to the facts, by reason of the additional evidence so taken, and it shall file such modified or new findings, which, if supported by evidence, shall be conclu-

Copy thereof to Commission.

Proceedings and evidence.

Unofficial
10m



sive, and its recommendation, if any, for the modification or setting aside of the original order. The jurisdiction of the court shall be exclusive and its judgment and decree, affirming, modifying, or setting aside, in whole or in part, any order of the Commission, shall be final, subject to review by the Supreme Court of the United States upon certiorari or certification as provided in sections 239 and 240 of the Judicial Code, as amended (U.S.C., title 28, secs. 346 and 347).

(b) The commencement of proceedings under subsection (a) shall not, unless specifically ordered by the court, operate as a stay of the Commission's order.

INFORMATION REQUIRED IN PROSPECTUS

SEC. 10. (a) A prospectus—

(1) when relating to a security other than a security issued by a foreign government or political subdivision thereof, shall contain the same statements made in the registration statement, but it need not include the documents referred to in paragraphs (28) to (32), inclusive, of Schedule A;

(2) when relating to a security issued by a foreign government or political subdivision thereof shall contain the same statements made in the registration statement, but it need not include the documents referred to in paragraphs (13) and (14) of Schedule B.

(b) Notwithstanding the provisions of subsection (a)—

(1) when a prospectus is used more than thirteen months after the effective date of the registration statement, the information in the statements contained therein shall be as of a date not more than twelve months prior to such use,

(2) there may be omitted from any prospectus any of the statements required under such subsection (a) which the Commission may by rules or regulations designate as not being necessary or appropriate in the public interest or for the protection of investors.

(3) any prospectus shall contain such other information as the Commission may by rules or regulations require as being necessary or appropriate in the public interest or for the protection of investors.

(4) in the exercise of its powers under paragraphs (2) and (3) of this subsection, the Commission shall have authority to classify prospectuses according to the nature and circumstances of their use, and, by rules and regulations and subject to such terms and conditions as it shall specify therein, to prescribe as to each class the form and contents which it may find appropriate to such use and consistent with the public interest and the protection of investors.

(c) The statements or information required to be included in a prospectus by or under authority of subsection (a) or (b), when written, shall be placed in a conspicuous part of the prospectus in type as large as that used generally in the body of the prospectus.

(d) In any case where a prospectus consists of a radio broadcast, copies thereof shall be filed with the Commission under such rules and regulations as it shall prescribe. The Commission may by rules and regulations require the filing with it of forms of prospectuses used in connection with the sale of securities registered under this title.

Jurisdiction of court.

Certiorari to Supreme Court.

U.S.C., p. 906.

Commission's order not stayed.

Information required in prospectus.

Domestic securities.

Post, p. 91.

Foreign government, etc., securities

Post, p. 92.

Statement in prospectus used more than 13 months.

Post, p. 906.

Statements that may be omitted.

Additional information required.

Classification of prospectuses.

Regulations governing form, etc., of classes.

Printing requirement.

Radio broadcasts. Copies to be filed.

86637*—34—6

1078

2022-011769 MISC Page: 1081 of 2782

09/26/2022 03:35:37 PM Receipt #: 22-9381

Rev. Fee: \$30.00 Darrell James Hill

Gila County, Az, Sadie Jo Bingham, Recorder



CIVIL LIABILITIES ON ACCOUNT OF FALSE REGISTRATION STATEMENT

Civil liabilities for false registration statement. Post, p 907.

SEC. 11. (a) In case any part of the registration statement, when such part became effective, contained an untrue statement of a material fact or omitted to state a material fact required to be stated therein or necessary to make the statements therein not misleading, any person acquiring such security (unless it is proved that at the time of such acquisition he knew of such untruth or omission) may, either at law or in equity, in any court of competent jurisdiction, sue—

Responsibility of signator. Director, partner, etc.

(1) every person who signed the registration statement:
(2) every person who was a director of (or person performing similar functions) or partner in, the issuer at the time of the filing of the part of the registration statement with respect to which his liability is asserted;

Prospective director, partner, etc.

(3) every person who, with his consent, is named in the registration statement as being or about to become a director, person performing similar functions, or partner;

Accountant's, etc., statements.

(4) every accountant, engineer, or appraiser, or any person whose profession gives authority to a statement made by him, who has with his consent been named as having prepared or certified any part of the registration statement, or as having prepared or certified any report or valuation which is used in connection with the registration statement, with respect to the statement in such registration statement, report, or valuation, which purports to have been prepared or certified by him;

Underwriter to such security. Exemption, if burden of proof sustained.

(5) every underwriter with respect to such security.

(b) Notwithstanding the provisions of subsection (a) no person, other than the issuer, shall be liable as provided therein who shall sustain the burden of proof—

Resignation, etc., before effective date of statement.

(1) that before the effective date of the part of the registration statement with respect to which his liability is asserted (A) he had resigned from or had taken such steps as are permitted by law to resign from, or ceased or refused to act in, every office, capacity, or relationship in which he was described in the registration statement as acting or agreeing to act, and (B) he had advised the Commission and the issuer in writing that he had taken such action and that he would not be responsible for such part of the registration statement; or

Notification to Commission, etc., accordingly.

(2) that if such part of the registration statement became effective without his knowledge, upon becoming aware of such fact he forthwith acted and advised the Commission, in accordance with paragraph (1), and, in addition, gave reasonable public notice that such part of the registration statement had become effective without his knowledge; or

Advised commission of false statement.

Public notice, additional.

Belief in probity of statements, not expert, etc.

(3) that (A) as regards any part of the registration statement not purporting to be made on the authority of an expert, and not purporting to be a copy of or extract from a report or valuation of an expert, and not purporting to be made on the authority of a public official document or statement, he had, after reasonable investigation, reasonable ground to believe and did believe, at the time such part of the registration statement became effective, that the statements therein were true and that there was no omission to state a material fact required to be stated therein or necessary to make the statements therein not misleading; and (B) as regards any part of the registration statement purporting to be made upon his authority as an expert or purporting to be a copy of or extract from a report or valuation of himself as an expert, (i) he had, after reasonable

No material fact omitted.

Statement made as expert true.

1079



investigation, reasonable ground to believe and did believe, at the time such part of the registration statement became effective, that the statements therein were true and that there was no omission to state a material fact required to be stated therein or necessary to make the statements therein not misleading, or (ii) such part of the registration statement did not fairly represent his statement as an expert or was not a fair copy of or extract from his report or valuation as an expert; and (C) as regards any part of the registration statement purporting to be made on the authority of an expert (other than himself) or purporting to be a copy of or extract from a report or valuation of an expert (other than himself), he had reasonable ground to believe and did believe, at the time such part of the registration statement became effective, that the statements therein were true and that there was no omission to state a material fact required to be stated therein or necessary to make the statements therein not misleading, and that such part of the registration statement fairly represented the statement of the expert or was a fair copy of or extract from the report or valuation of the expert; and (D) as regards any part of the registration statement purporting to be a statement made by an official person or purporting to be a copy of or extract from a public official document, he had reasonable ground to believe and did believe, at the time such part of the registration statement became effective, that the statements therein were true, and that there was no omission to state a material fact required to be stated therein or necessary to make the statements therein not misleading, and that such part of the registration statement fairly represented the statement made by the official person or was a fair copy of or extract from the public official document.

(c) In determining, for the purpose of paragraph (3) of subsection (b) of this section, what constitutes reasonable investigation and reasonable ground for belief, the standard of reasonableness shall be that required of a person occupying a fiduciary relationship.

(d) If any person becomes an underwriter with respect to the security after the part of the registration statement with respect to which his liability is asserted has become effective, then for the purposes of paragraph (3) of subsection (b) of this section such part of the registration statement shall be considered as having become effective with respect to such person as of the time when he became an underwriter.

(e) The suit authorized under subsection (a) may be either (1) to recover the consideration paid for such security with interest thereon, less the amount of any income received thereon, upon the tender of such security, or (2) for damages if the person suing no longer owns the security.

(f) All or any one or more of the persons specified in subsection (a) shall be jointly and severally liable, and every person who becomes liable to make any payment under this section may recover contribution as in cases of contract from any person who, if sued separately, would have been liable to make the same payment, unless the person who has become liable was, and the other was not, guilty of fraudulent misrepresentation.

(g) In no case shall the amount recoverable under this section exceed the price at which the security was offered to the public.

No omitted nor misleading statements.

Registration statement at variance, etc

Statement of expert (other than himself). Post, p. 907

Public official or documents. Post, p. 907.

Reasonable investigation or ground for belief. Post, p. 907.

Becoming underwriter after liability attaches.

Suits authorized herein. Security payment Post, p. 907.

Damages.

Liability, joint and several

Contribution.

Exception.

Recovery limitation.

1080



Civil liabilities connected with prospectuses and communications.

CIVIL LIABILITIES ARISING IN CONNECTION WITH PROSPECTUSES AND COMMUNICATIONS

Sales through interstate commerce and mails. Ante, p. 77. Through false prospectuses, etc. Ante, p. 73.

SEC. 12. Any person who—

- (1) sells a security in violation of section 5, or
- (2) sells a security (whether or not exempted by the provisions of section 3, other than paragraph (2) of subsection (a) thereof), by the use of any means or instruments of transportation or communication in interstate commerce or of the mails, by means of a prospectus or oral communication, which includes an untrue statement of a material fact or omits to state a material fact necessary in order to make the statements, in the light of the circumstances under which they were made, not misleading (the purchaser not knowing of such untruth or omission), and who shall not sustain the burden of proof that he did not know, and in the exercise of reasonable care could not have known, of such untruth or omission,

Recovery by purchaser.

shall be liable to the person purchasing such security from him, who may sue either at law or in equity in any court of competent jurisdiction, to recover the consideration paid for such security with interest thereon, less the amount of any income received thereon, upon the tender of such security, or for damages if he no longer owns the security.

LIMITATION OF ACTIONS

Limitation of actions.

Post, p. 608.

SEC. 13. No action shall be maintained to enforce any liability created under section 11 or section 12 (2) unless brought within two years after the discovery of the untrue statement or the omission, or after such discovery should have been made by the exercise of reasonable diligence, or, if the action is to enforce a liability created under section 12 (1), unless brought within two years after the violation upon which it is based. In no event shall any such action be brought to enforce a liability created under section 11 or section 12 (1) more than ten years after the security was bona fide offered to the public.

CONTRARY STIPULATIONS VOID

Contrary stipulations void.

SEC. 14. Any condition, stipulation, or provision binding any person acquiring any security to waive compliance with any provision of this title or of the rules and regulations of the Commission shall be void.

LIABILITY OF CONTROLLING PERSONS

Liability of controlling persons. Post, p. 608.

SEC. 15. Every person who, by or through stock ownership, agency, or otherwise, or who, pursuant to or in connection with an agreement or understanding with one or more other persons by or through stock ownership, agency, or otherwise, controls any person liable under section 11 or 12, shall also be liable jointly and severally with and to the same extent as such controlled person to any person to whom such controlled person is liable.

ADDITIONAL REMEDIES

Remedies to be additional to existing rights, etc.

SEC. 16. The rights and remedies provided by this title shall be in addition to any and all other rights and remedies that may exist at law or in equity.

FRAUDULENT INTERSTATE TRANSACTIONS

Fraudulent interstate transactions.

SEC. 17. (a) It shall be unlawful for any person in the sale of any securities by the use of any means or instruments of transportation

1081



or communication in interstate commerce or by the use of the mails, directly or indirectly—

- (1) to employ any device, scheme, or artifice to defraud, or
- (2) to obtain money or property by means of any untrue statement of a material fact or any omission to state a material fact necessary in order to make the statements made, in the light of the circumstances under which they were made, not misleading, or
- (3) to engage in any transaction, practice, or course of business which operates or would operate as a fraud or deceit upon the purchaser.

(b) It shall be unlawful for any person, by the use of any means or instruments of transportation or communication in interstate commerce or by the use of the mails, to publish, give publicity to, or circulate any notice, circular, advertisement, newspaper, article, letter, investment service, or communication which, though not purporting to offer a security for sale, describes such security for a consideration received or to be received, directly or indirectly, from an issuer, underwriter, or dealer, without fully disclosing the receipt, whether past or prospective, of such consideration and the amount thereof.

(c) The exemptions provided in section 3 shall not apply to the provisions of this section.

STATE CONTROL OF SECURITIES

SEC. 18. Nothing in this title shall affect the jurisdiction of the securities commission (or any agency or office performing like functions) of any State or Territory of the United States, or the District of Columbia, over any security or any person.

SPECIAL POWERS OF COMMISSION

SEC. 19. (a) The Commission shall have authority from time to time to make, amend, and rescind such rules and regulations as may be necessary to carry out the provisions of this title, including rules and regulations governing registration statements and prospectuses for various classes of securities and issuers, and defining accounting and trade terms used in this title. Among other things, the Commission shall have authority, for the purposes of this title, to prescribe the form or forms in which required information shall be set forth, the items or details to be shown in the balance sheet and earning statement, and the methods to be followed in the preparation of accounts, in the appraisal or valuation of assets and liabilities, in the determination of depreciation and depletion, in the differentiation of recurring and nonrecurring income, in the differentiation of investment and operating income, and in the preparation, where the Commission deems it necessary or desirable, of consolidated balance sheets or income accounts of any person directly or indirectly controlling or controlled by the issuer, or any person under direct or indirect common control with the issuer; but insofar as they relate to any common carrier subject to the provisions of section 20 of the Interstate Commerce Act, as amended, the rules and regulations of the Commission with respect to accounts shall not be inconsistent with the requirements imposed by the Interstate Commerce Commission under authority of such section 20. The rules and regulations of the Commission shall be effective upon publication in the manner which the Commission shall prescribe.

(b) For the purpose of all investigations which, in the opinion of the Commission, are necessary and proper for the enforcement of this title, any member of the Commission or any officer or officers

Unlawful practices, transactions, etc., in sale of securities.

Unlawful advertisement of securities.

Receipt of consideration and amount to be disclosed.

Exempted securities, *Ante*, p. 75.

State control of securities. Jurisdiction of commissions.

Special powers of Commission. Prescribe regulations. *Post*, p. 908.

Registration statements and prospectuses.

Prescribe forms.

Preparation of accounts, appraising, etc.

Common carrier.

Rules affecting. Vol. 24, p. 386; U.S.C., p. 1668.

Rules effective on publication.

Power to summon witnesses, production of books, etc.

1082



designated by it are empowered to administer oaths and affirmations, subpoena witnesses, take evidence, and require the production of any books, papers, or other documents which the Commission deems relevant or material to the inquiry. Such attendance of witnesses and the production of such documentary evidence may be required from any place in the United States or any Territory at any designated place of hearing.

Injunctions and prosecution of offenses.

INJUNCTIONS AND PROSECUTION OF OFFENSES

Investigations authorized.

SEC. 20. (a) Whenever it shall appear to the Commission, either upon complaint or otherwise, that the provisions of this title, or of any rule or regulation prescribed under authority thereof, have been or are about to be violated, it may, in its discretion, either require or permit such person to file with it a statement in writing, under oath, or otherwise, as to all the facts and circumstances concerning the subject matter which it believes to be in the public interest to investigate, and may investigate such facts.

Injunctions.

(b) Whenever it shall appear to the Commission that any person is engaged or about to engage in any acts or practices which constitute or will constitute a violation of the provisions of this title, or of any rule or regulation prescribed under authority thereof, it may in its discretion, bring an action in any district court of the United States, United States court of any Territory, or the Supreme Court of the District of Columbia to enjoin such acts or practices, and upon a proper showing a permanent or temporary injunction or restraining order shall be granted without bond. The Commission may transmit such evidence as may be available concerning such acts or practices to the Attorney General who may, in his discretion, institute the necessary criminal proceedings under this title. Any such criminal proceeding may be brought either in the district wherein the transmittal of the prospectus or security complained of begins, or in the district wherein such prospectus or security is received.

Evidence to Attorney General

Venue.

Jurisdiction of district court to issue writs of mandamus.

(c) Upon application of the Commission the district courts of the United States, the United States courts of any Territory, and the Supreme Court of the District of Columbia, shall also have jurisdiction to issue writs of mandamus commanding any person to comply with the provisions of this title or any order of the Commission made in pursuance thereof.

HEARINGS BY COMMISSION

Hearings by Commission.

SEC. 21. All hearings shall be public and may be held before the Commission or an officer or officers of the Commission designated by it, and appropriate records thereof shall be kept.

JURISDICTION OF OFFENSES AND SUITS

Jurisdiction of offenses and suits.

SEC. 22. (a) The district courts of the United States, the United States courts of any Territory, and the Supreme Court of the District of Columbia shall have jurisdiction of offenses and violations under this title and under the rules and regulations promulgated by the Commission in respect thereto, and, concurrent with State and Territorial courts, of all suits in equity and actions at law brought to enforce any liability or duty created by this title. Any such suit or action may be brought in the district wherein the defendant is found or is an inhabitant or transacts business, or in the district where the sale took place, if the defendant participated therein, and process in such cases may be served in any other district of which the defendant

Service of process.

1083



is an inhabitant or wherever the defendant may be found. Judgments and decrees so rendered shall be subject to review as provided in sections 128 and 240 of the Judicial Code, as amended (U.S.C., title 28, secs. 225 and 347). No case arising under this title and brought in any State court of competent jurisdiction shall be removed to any court of the United States. No costs shall be assessed for or against the Commission in any proceeding under this title brought by or against it in the Supreme Court or such other courts.

Judgment subject to review. Vol. 36, pp. 1133, 1137. U.S.C., pp. 895, 906.

No court assessments against Commission.

(b) In case of contumacy or refusal to obey a subpoena issued to any person, any of the said United States courts, within the jurisdiction of which said person guilty of contumacy or refusal to obey is found or resides, upon application by the Commission may issue to such person an order requiring such person to appear before the Commission, or one of its examiners designated by it, there to produce documentary evidence if so ordered, or there to give evidence touching the matter in question; and any failure to obey such order of the court may be punished by said court as a contempt thereof.

Punishment for disobeying subpoena, etc.

(c) No person shall be excused from attending and testifying or from producing books, papers, contracts, agreements, and other documents before the Commission, or in obedience to the subpoena of the Commission or any member thereof or any officer designated by it, or in any cause or proceeding instituted by the Commission, on the ground that the testimony or evidence, documentary or otherwise, required of him, may tend to incriminate him or subject him to a penalty or forfeiture; but no individual shall be prosecuted or subjected to any penalty or forfeiture for or on account of any transaction, matter, or thing concerning which he is compelled, after having claimed his privilege against self-incrimination, to testify or produce evidence, documentary or otherwise, except that such individual so testifying shall not be exempt from prosecution and punishment for perjury committed in so testifying.

No person excused from testifying, etc.

Personal immunity.

Perjury.

UNLAWFUL REPRESENTATIONS

SEC. 23. Neither the fact that the registration statement for a security has been filed or is in effect nor the fact that a stop order is not in effect with respect thereto shall be deemed a finding by the Commission that the registration statement is true and accurate on its face or that it does not contain an untrue statement of fact or omit to state a material fact, or be held to mean that the Commission has in any way passed upon the merits of, or given approval to, such security. It shall be unlawful to make, or cause to be made, to any prospective purchaser any representation contrary to the foregoing provisions of this section.

Unlawful representations

PENALTIES

SEC. 24. Any person who willfully violates any of the provisions of this title, or the rules and regulations promulgated by the Commission under authority thereof, or any person who willfully, in a registration statement filed under this title, makes any untrue statement of a material fact or omits to state any material fact required to be stated therein or necessary to make the statements therein not misleading, shall upon conviction be fined not more than \$5,000 or imprisoned not more than five years, or both.

Penalties.

JURISDICTION OF OTHER GOVERNMENT AGENCIES OVER SECURITIES

SEC. 25. Nothing in this title shall relieve any person from submitting to the respective supervisory units of the Government of

Jurisdiction of other Government agencies not impaired.

1084



the United States information, reports, or other documents that are now or may hereafter be required by any provision of law.

SEPARABILITY OF PROVISIONS

Separability of provisions.

SEC. 26. If any provision of this Act, or the application of such provision to any person or circumstance, shall be held invalid, the remainder of this Act, or the application of such provision to persons or circumstances other than those as to which it is held invalid, shall not be affected thereby.

Schedule A. Information to be included.

SCHEDULE A

Name of issuer.

(1) The name under which the issuer is doing or intends to do business;

State, etc.

(2) the name of the State or other sovereign power under which the issuer is organized;

Location of issuer's business office. United States agency, if foreign issuer.

(3) the location of the issuer's principal business office, and if the issuer is a foreign or territorial person, the name and address of its agent in the United States authorized to receive notice;

Names and addresses of corporation directors, partners, etc.

(4) the names and addresses of the directors or persons performing similar functions, and the chief executive, financial and accounting officers, chosen or to be chosen if the issuer be a corporation, association, trust, or other entity; of all partners, if the issuer be a partnership; and of the issuer, if the issuer be an individual; and of the promoters in the case of a business to be formed, or formed within two years prior to the filing of the registration statement;

Underwriters.

(5) the names and addresses of the underwriters;

Stockholders.

(6) the names and addresses of all persons, if any, owning of record or beneficially, if known, more than 10 per centum of any class of stock of the issuer, or more than 10 per centum in the aggregate of the outstanding stock of the issuer as of a date within twenty days prior to the filing of the registration statement;

Schedule of securities.

(7) the amount of securities of the issuer held by any person specified in paragraphs (4), (5), and (6) of this schedule, as of a date within twenty days prior to the filing of the registration statement, and, if possible, as of one year prior thereto, and the amount of the securities, for which the registration statement is filed, to which such persons have indicated their intention to subscribe;

Character of business.

(8) the general character of the business actually transacted or to be transacted by the issuer;

Capitalization, etc.

(9) a statement of the capitalization of the issuer, including the authorized and outstanding amounts of its capital stock and the proportion thereof paid up, the number and classes of shares in which such capital stock is divided, par value thereof, or if it has no par value, the stated or assigned value thereof, a description of the respective voting rights, preferences, conversion and exchange rights, rights to dividends, profits, or capital of each class, with respect to each other class, including the retirement and liquidation rights or values thereof;

Outstanding options.

(10) a statement of the securities, if any, covered by options outstanding or to be created in connection with the security to be offered, together with the names and addresses of all persons, if any, to be allotted more than 10 per centum in the aggregate of such options;

Capital stock.

(11) the amount of capital stock of each class issued or included in the shares of stock to be offered;

Funded debt, etc.

(12) the amount of the funded debt outstanding and to be created by the security to be offered, with a brief description of the date, maturity, and character of such debt, rate of interest, character of amortization provisions, and the security, if any, therefor. If substitution of any security is permissible, a summarized statement of

Statement, if substitution permitted.

2022-011769 MISC Page: 1088 of 2782

09/26/2022 03:35:37 PM Receipt #: 22-9381

Rec Fee: \$30.00 Darrell James Hill

Gila County, Az. Sadie Jo Bingham, Recorder



1085

the conditions under which such substitution is permitted. If substitution is permissible without notice, a specific statement to that effect;

(13) the specific purposes in detail and the approximate amounts to be devoted to such purposes, so far as determinable, for which the security to be offered is to supply funds, and if the funds are to be raised in part from other sources, the amounts thereof and the sources thereof, shall be stated;

(14) the remuneration, paid or estimated to be paid, by the issuer or its predecessor, directly or indirectly, during the past year and ensuing year to (a) the directors or persons performing similar functions, and (b) its officers and other persons, naming them wherever such remuneration exceeded \$25,000 during any such year;

(15) the estimated net proceeds to be derived from the security to be offered;

(16) the price at which it is proposed that the security shall be offered to the public or the method by which such price is computed and any variation therefrom at which any portion of such security is proposed to be offered to any persons or classes of persons, other than the underwriters, naming them or specifying the class. A variation in price may be proposed prior to the date of the public offering of the security, but the Commission shall immediately be notified of such variation;

(17) all commissions or discounts paid or to be paid, directly or indirectly, by the issuer to the underwriters in respect of the sale of the security to be offered. Commissions shall include all cash, securities, contracts, or anything else of value, paid, to be set aside, disposed of, or understandings with or for the benefit of any other persons in which any underwriter is interested, made, in connection with the sale of such security. A commission paid or to be paid in connection with the sale of such security by a person in which the issuer has an interest or which is controlled or directed by, or under common control with, the issuer shall be deemed to have been paid by the issuer. Where any such commission is paid the amount of such commission paid to each underwriter shall be stated;

(18) the amount or estimated amounts, itemized in reasonable detail, of expenses, other than commissions specified in paragraph (17) of this schedule, incurred or borne by or for the account of the issuer in connection with the sale of the security to be offered or properly chargeable thereto, including legal, engineering, certification, authentication, and other charges;

(19) the net proceeds derived from any security sold by the issuer during the two years preceding the filing of the registration statement, the price at which such security was offered to the public, and the names of the principal underwriters of such security;

(20) any amount paid within two years preceding the filing of the registration statement or intended to be paid to any promoter and the consideration for any such payment;

(21) the names and addresses of the vendors and the purchase price of any property, or good will, acquired or to be acquired, not in the ordinary course of business, which is to be defrayed in whole or in part from the proceeds of the security to be offered, the amount of any commission payable to any person in connection with such acquisition, and the name or names of such person or persons, together with any expense incurred or to be incurred in connection with such acquisition, including the cost of borrowing money to finance such acquisition;

Detailed amounts and purposes.

Remuneration paid by issuer, etc., to its directors, officers, etc.

Estimated net proceeds.

Price security offered to public, etc.

Variation to be reported to Commission.

Commissions, discounts, etc.

Other expenses.

Net proceeds from previous sales.

Payment to promoter.

Vendors, names, addresses, purchase price of property, etc.

Cost of financing.

1086



Interest of every stockholder holding more than 10 per cent of any class.

(22) full particulars of the nature and extent of the interest, if any, of every director, principal executive officer, and of every stockholder holding more than 10 per centum of any class of stock or more than 10 per centum in the aggregate of the stock of the issuer, in any property acquired, not in the ordinary course of business of the issuer, within two years preceding the filing of the registration statement or proposed to be acquired at such date;

Names, etc., of counsel.

(23) the names and addresses of counsel who have passed on the legality of the issue;

Material contracts, not made in ordinary business.

(24) dates of and parties to, and the general effect concisely stated of every material contract made, not in the ordinary course of business, which contract is to be executed in whole or in part at or after the filing of the registration statement or which contract has been made not more than two years before such filing. Any management contract or contract providing for special bonuses or profit-sharing arrangements, and every material patent or contract for a material patent right, and every contract by or with a public utility company or an affiliate thereof, providing for the giving or receiving of technical or financial advice or service (if such contract may involve a charge to any party thereto at a rate in excess of \$2,500 per year in cash or securities or anything else of value), shall be deemed a material contract;

Management contract, special bonuses, or profit sharing, etc., deemed material contract.

Balance sheets. Contents.

(25) a balance sheet as of a date not more than ninety days prior to the date of the filing of the registration statement showing all of the assets of the issuer, the nature and cost thereof, whenever determinable, in such detail and in such form as the Commission shall prescribe (with intangible items segregated), including any loan in excess of \$20,000 to any officer, director, stockholder or person directly or indirectly controlling or controlled by the issuer, or person under direct or indirect common control with the issuer. All the liabilities of the issuer in such detail and such form as the Commission shall prescribe, including surplus of the issuer showing how and from what sources such surplus was created, all as of a date not more than ninety days prior to the filing of the registration statement. If such statement be not certified by an independent public or certified accountant, in addition to the balance sheet required to be submitted under this schedule, a similar detailed balance sheet of the assets and liabilities of the issuer, certified by an independent public or certified accountant, of a date not more than one year prior to the filing of the registration statement, shall be submitted;

Certificate of public accountant.

Profit and loss statement.

(26) a profit and loss statement of the issuer showing earnings and income, the nature and source thereof, and the expenses and fixed charges in such detail and such form as the Commission shall prescribe for the latest fiscal year for which such statement is available and for the two preceding fiscal years, year by year, or, if such issuer has been in actual business for less than three years, then for such time as the issuer has been in actual business, year by year. If the date of the filing of the registration statement is more than six months after the close of the last fiscal year, a statement from such closing date to the latest practicable date. Such statement shall show what the practice of the issuer has been during the three years or lesser period as to the character of the charges, dividends or other distributions made against its various surplus accounts, and as to depreciation, depletion, and maintenance charges, in such detail and form as the Commission shall prescribe, and if stock dividends or avails from the sale of rights have been credited to income, they shall be shown separately with a statement of the basis upon which the credit is computed. Such statement shall also differentiate

PROV

UNRECORDED
1687



between any recurring and nonrecurring income and between any investment and operating income. Such statement shall be certified by an independent public or certified accountant;

Certificate of public accountant.

(27) if the proceeds, or any part of the proceeds, of the security to be issued is to be applied directly or indirectly to the purchase of any business, a profit and loss statement of such business certified by an independent public or certified accountant, meeting the requirements of paragraph (26) of this schedule, for the three preceding fiscal years, together with a balance sheet, similarly certified, of such business, meeting the requirements of paragraph (25) of this schedule of a date not more than ninety days prior to the filing of the registration statement or at the date such business was acquired by the issuer if the business was acquired by the issuer more than ninety days prior to the filing of the registration statement;

If proceeds are to be applied to purchase of any business, statement of such business to issue.

(28) a copy of any agreement or agreements (or, if identical agreements are used, the forms thereof) made with any underwriter, including all contracts and agreements referred to in paragraph (17) of this schedule;

Agreements with any underwriter.

(29) a copy of the opinion or opinions of counsel in respect to the legality of the issue, with a translation of such opinion, when necessary, into the English language;

Counsel's opinion as to legality of issue.

(30) a copy of all material contracts referred to in paragraph (24) of this schedule, but no disclosure shall be required of any portion of any such contract if the Commission determines that disclosure of such portion would impair the value of the contract and would not be necessary for the protection of the investors;

Copy of material contracts; restriction.

(31) unless previously filed and registered under the provisions of this title, and brought up to date, (a) a copy of its articles of incorporation, with all amendments thereof and of its existing by-laws or instruments corresponding thereto, whatever the name, if the issuer be a corporation; (b) copy of all instruments by which the trust is created or declared, if the issuer is a trust; (c) a copy of its articles of partnership or association and all other papers pertaining to its organization, if the issuer is a partnership, unincorporated association, joint-stock company, or any other form of organization; and

Copy of articles of incorporation, etc.

(32) a copy of the underlying agreements or indentures affecting any stock, bonds, or debentures offered or to be offered.

Copy of underlying indentures affecting stock, etc.

In case of certificates of deposit, voting trust certificates, collateral trust certificates, certificates of interest or shares in unincorporated investment trusts, equipment trust certificates, interim or other receipts for certificates, and like securities, the Commission shall establish rules and regulations requiring the submission of information of a like character applicable to such cases, together with such other information as it may deem appropriate and necessary regarding the character, financial or otherwise, of the actual issuer of the securities and/or the person performing the acts and assuming the duties of depositor or manager.

Rules and regulations to be established.

SCHEDULE B

Schedule B.

- (1) Name of borrowing government or subdivision thereof;
- (2) specific purposes in detail and the approximate amounts to be devoted to such purposes, so far as determinable, for which the security to be offered is to supply funds, and if the funds are to be raised in part from other sources, the amounts thereof and the sources thereof. shall be stated;

Name of borrowing government, etc. Purposes and amounts for which security offered is to supply funds.

1088



- Funded and floating debts. (3) the amount of the funded debt and the estimated amount of the floating debt outstanding and to be created by the security to be offered, excluding intergovernmental debt, and a brief description of the date, maturity, character of such debt, rate of interest, character of amortization provisions, and the security, if any, therefor.
- Substitution conditions. If substitution of any security is permissible, a statement of the conditions under which such substitution is permitted. If substitution is permissible without notice, a specific statement to that effect;
- Whether issuer has defaulted, etc. (4) whether or not the issuer or its predecessor has, within a period of twenty years prior to the filing of the registration statement, defaulted on the principal or interest of any external security, excluding intergovernmental debt, and, if so, the date, amount, and circumstances of such default, and the terms of the succeeding arrangement, if any;
- Intergovernmental debts excluded. (5) the receipts, classified by source, and the expenditures, classified by purpose, in such detail and form as the Commission shall prescribe for the latest fiscal year for which such information is available and the two preceding fiscal years, year by year;
- Receipts and expenses, in detail. (6) the names and addresses of the underwriters;
- Names, etc., of underwriters. (7) the name and address of its authorized agent, if any, in the United States;
- United States agent. (8) the estimated net proceeds to be derived from the sale in the United States of the security to be offered;
- Estimated net proceeds from sales in United States. (9) the price at which it is proposed that the security shall be offered in the United States to the public or the method by which such price is computed. A variation in price may be proposed prior to the date of the public offering of the security, but the Commission shall immediately be notified of such variation;
- Price. (10) all commissions paid or to be paid, directly or indirectly, by the issuer to the underwriters in respect of the sale of the security to be offered. Commissions shall include all cash, securities, contracts, or anything else of value, paid, to be set aside, disposed of, or understandings with or for the benefit of any other persons in which the underwriter is interested, made, in connection with the sale of such security. Where any such commission is paid, the amount of such commission paid to each underwriter shall be stated;
- Commissions paid. (11) the amount or estimated amounts, itemized in reasonable detail, of expenses, other than the commissions specified in paragraph (10) of this schedule, incurred or borne by or for the account of the issuer in connection with the sale of the security to be offered or properly chargeable thereto, including legal, engineering, certification, and other charges;
- Other expenses. (12) the names and addresses of counsel who have passed upon the legality of the issue;
- Names, etc., of counsel. (13) a copy of any agreement or agreements made with any underwriter governing the sale of the security within the United States; and
- Copy of any underwriter's agreement as to United States sales. (14) an agreement of the issuer to furnish a copy of the opinion or opinions of counsel in respect to the legality of the issue, with a translation, where necessary, into the English language. Such opinion shall set out in full all laws, decrees, ordinances, or other acts of Government under which the issue of such security has been authorized.
- Counsel's opinion as to legality of issue.
- Corporation of Foreign Bondholders, 1933.
- "Corporation of Foreign Security Holders" created.

TITLE II

SECTION 201. For the purpose of protecting, conserving, and advancing the interests of the holders of foreign securities in default, there is hereby created a body corporate with the name "Corporation

1089



of Foreign Security Holders" (herein called the "Corporation"). The principal office of the Corporation shall be located in the District of Columbia, but there may be established agencies or branch offices in any city or cities of the United States under rules and regulations prescribed by the board of directors.

SEC. 202. The control and management of the Corporation shall be vested in a board of six directors, who shall be appointed and hold office in the following manner: As soon as practicable after the date this Act takes effect the Federal Trade Commission (hereinafter in this title called "Commission") shall appoint six directors, and shall designate a chairman and a vice chairman from among their number. After the directors designated as chairman and vice chairman cease to be directors, their successors as chairman and vice chairman shall be elected by the board of directors itself. Of the directors first appointed, two shall continue in office for a term of two years, two for a term of four years, and two for a term of six years, from the date this Act takes effect, the term of each to be designated by the Commission at the time of appointment. Their successors shall be appointed by the Commission, each for a term of six years from the date of the expiration of the term for which his predecessor was appointed, except that any person appointed to fill a vacancy occurring prior to the expiration of the term for which his predecessor was appointed shall be appointed only for the unexpired term of such predecessor. No person shall be eligible to serve as a director who within the five years preceding has had any interest, direct or indirect, in any corporation, company, partnership, bank or association which has sold, or offered for sale any foreign securities. The office of a director shall be vacated if the board of directors shall at a meeting specially convened for that purpose by resolution passed by a majority of at least two thirds of the board of directors, remove such member from office, provided that the member whom it is proposed to remove shall have seven days' notice sent to him of such meeting and that he may be heard.

SEC. 203. The Corporation shall have power to adopt, alter, and use a corporate seal; to make contracts; to lease such real estate as may be necessary for the transaction of its business; to sue and be sued, to complain and to defend, in any court of competent jurisdiction, State or Federal; to require from trustees, financial agents, or dealers in foreign securities information relative to the original or present holders of foreign securities and such other information as may be required and to issue subpoenas therefor; to take over the functions of any fiscal and paying agents of any foreign securities in default; to borrow money for the purposes of this title, and to pledge as collateral for such loans any securities deposited with the Corporation pursuant to this title; by and with the consent and approval of the Commission to select, employ, and fix the compensation of officers, directors, members of committees, employees, attorneys, and agents of the Corporation, without regard to the provisions of other laws applicable to the employment and compensation of officers or employees of the United States; to define their authority and duties, require bonds of them and fix the penalties thereof, and to dismiss at pleasure such officers, employees, attorneys, and agents; and to prescribe, amend, and repeal, by its board of directors, bylaws, rules, and regulations governing the manner in which its general business may be conducted and the powers granted to it by law may be exercised and enjoyed, together with provisions for such committees and the functions thereof as the board of directors

Principal office, agencies.

Control vested in board of directors. Federal Trade Commission to appoint six directors, designate a chairman, etc.

Post, p. 908.

Appointment of successors.

Tenure of office.

Vacancies.

Removals.

Corporate powers.

To require information relative to foreign securities holders, etc.

To take over functions of agent of defaulted foreign securities.

Borrow and pledge for such loans.

Officers, employees, etc.

Prescribe, etc., rules for conduct of business.

1090



may deem necessary for facilitating its business under this title. The board of directors of the Corporation shall determine and prescribe the manner in which its obligations shall be incurred and its expenses allowed and paid.

SEC. 204. The board of directors may—

(1) Convene meetings of holders of foreign securities.

(2) Invite the deposit and undertake the custody of foreign securities which have defaulted in the payment either of principal or interest, and issue receipts or certificates in the place of securities so deposited.

(3) Appoint committees from the directors of the Corporation and/or all other persons to represent holders of any class or classes of foreign securities which have defaulted in the payment either of principal or interest and determine and regulate the functions of such committees. The chairman and vice chairman of the board of directors shall be ex officio chairman and vice chairman of each committee.

(4) Negotiate and carry out, or assist in negotiating and carrying out, arrangements for the resumption of payments due or in arrears in respect of any foreign securities in default or for rearranging the terms on which such securities may in future be held or for converting and exchanging the same for new securities or for any other object in relation thereto; and under this paragraph any plan or agreement made with respect to such securities shall be binding upon depositors, providing that the consent of holders resident in the United States of 60 per centum of the securities deposited with the Corporation shall be obtained.

(5) Undertake, superintend, or take part in the collection and application of funds derived from foreign securities which come into the possession of or under the control or management of the Corporation.

(6) Collect, preserve, publish, circulate, and render available in readily accessible form, when deemed essential or necessary, documents, statistics, reports, and information of all kinds in respect of foreign securities, including particularly records of foreign external securities in default and records of the progress made toward the payment of past-due obligations.

(7) Take such steps as it may deem expedient with the view of securing the adoption of clear and simple forms of foreign securities and just and sound principles in the conditions and terms thereof.

(8) Generally, act in the name and on behalf of the holders of foreign securities the care or representation of whose interests may be entrusted to the Corporation; conserve and protect the rights and interests of holders of foreign securities issued, sold, or owned in the United States; adopt measures for the protection, vindication, and preservation or reservation of the rights and interests of holders of foreign securities either on any default in or on breach or contemplated breach of the conditions on which such foreign securities may have been issued, or otherwise; obtain for such holders such legal and other assistance and advice as the board of directors may deem expedient; and do all such other things as are incident or conducive to the attainment of the above objects.

SEC. 205. The board of directors shall cause accounts to be kept of all matters relating to or connected with the transactions and business of the Corporation, and cause a general account and balance sheet of the Corporation to be made out in each year, and cause all

Determine manner obligations incurred and expenses allowed.

Authority of board over foreign securities. Call meetings of holders of. Action on defaulted securities.

Appoint committees to represent such holders.

Carry out arrangements for resuming payments.

Collecting, etc., funds derived from foreign securities.

Collect, etc., information respecting foreign securities.

Securing simple forms, etc.

Act as representative of holders.

To keep and publish an audited general account and balance sheet.



accounts to be audited by one or more auditors who shall examine the same and report thereon to the board of directors.

SEC. 206. The Corporation shall make, print, and make public an annual report of its operations during each year, send a copy thereof, together with a copy of the account and balance sheet and auditor's report, to the Commission and to both Houses of Congress, and provide one copy of such report but not more than one on the application of any person and on receipt of a sum not exceeding \$1: *Provided*, That the board of directors in its discretion may distribute copies gratuitously.

SEC. 207. The Corporation may in its discretion levy charges, assessed on a pro rata basis, on the holders of foreign securities deposited with it: *Provided*, That any charge levied at the time of depositing securities with the Corporation shall not exceed one fifth of 1 per centum of the face value of such securities: *Provided further*, That any additional charges shall bear a close relationship to the cost of operations and negotiations including those enumerated in sections 203 and 204 and shall not exceed 1 per centum of the face value of such securities.

SEC. 208. The Corporation may receive subscriptions from any person, foundation with a public purpose, or agency of the United States Government, and such subscriptions may, in the discretion of the board of directors, be treated as loans repayable when and as the board of directors shall determine.

SEC. 209. The Reconstruction Finance Corporation is hereby authorized to loan out of its funds not to exceed \$75,000 for the use of the Corporation.

SEC. 210. Notwithstanding the foregoing provisions of this title, it shall be unlawful for, and nothing in this title shall be taken or construed as permitting or authorizing, the Corporation in this title created, or any committee of said Corporation, or any person or persons acting for or representing or purporting to represent it—

(a) to claim or assert or pretend to be acting for or to represent the Department of State or the United States Government;

(b) to make any statements or representations of any kind to any foreign government or its officials or the officials of any political subdivision of any foreign government that said Corporation or any committee thereof or any individual or individuals connected therewith were speaking or acting for the said Department of State or the United States Government; or

(c) to do any act directly or indirectly which would interfere with or obstruct or hinder or which might be calculated to obstruct, hinder or interfere with the policy or policies of the said Department of State or the Government of the United States or any pending or contemplated diplomatic negotiations, arrangements, business or exchanges between the Government of the United States or said Department of State and any foreign government or any political subdivision thereof.

SEC. 211. This title shall not take effect until the President finds that its taking effect is in the public interest and by proclamation so declares.

SEC. 212. This title may be cited as the "Corporation of Foreign Bondholders Act, 1933."

Approved, May 27, 1933.

Annual report of operations.

Provided. Free distribution.

Pro rata levy on holders of foreign securities.

Provided. Charge limitation.

Additional charges.

Subscription may be received from any foundation, etc.

Reconstruction Finance Corporation to advance funds for Corporation use.

Unlawful acts.

Claiming to represent Government of State Department. Statements to that effect to foreign Government.

Interference, etc. with Government policies.

Title not effective until President so declares.

Citation of title.

1092



[CHAPTER 39.]

AN ACT

May 27, 1933.
[H. R. 5152.]
[Public, No. 23.]

Granting the consent of Congress to the State Highway Commission of Virginia to replace and maintain a bridge across Northwest River in Norfolk County, Virginia, on State Highway Route Numbered 27.

Northwest River,
Virginia may bridge,
in Norfolk County.

Be it enacted by the Senate and House of Representatives of the United States of America in Congress assembled, That the consent of Congress is hereby granted to the State Highway Commission of Virginia, and its successors, to replace and operate a free highway bridge and approaches thereto across the Northwest River, at a point suitable to the interests of navigation, at or near Norfolk County, Virginia, on State Highway Route Numbered 27, in accordance with the provisions of an Act entitled "An Act to regulate the construction of bridges over navigable waters", approved March 23, 1906.

Construction.
Vol. 34, p. 84.

Amendment.

SEC. 2. The right to alter, amend, or repeal this Act is hereby expressly reserved.

Approved, May 27, 1933.

[CHAPTER 40.]

AN ACT

May 27, 1933.
[H. R. 5173.]
[Public, No. 24.]

Granting the consent of Congress to the State Highway Commission of Virginia to maintain a bridge already constructed to replace a weak structure in the same location, across the Staunton and Dan Rivers, in Mecklenburg County, Virginia, on United States Route Numbered 15.

Staunton and Dan
Rivers.
Bridge across,
Virginia, legalized.

Be it enacted by the Senate and House of Representatives of the United States of America in Congress assembled, That the consent of Congress is hereby granted to the State Highway Commission of Virginia, and its successors, to maintain and operate, in accordance with the provisions of the Act entitled "An Act to regulate the construction of bridges over navigable waters", approved March 23, 1906, a bridge and approaches thereto already constructed to replace an inadequate structure already constructed across the Staunton and Dan Rivers, at their mouths—Clarksville, in Mecklenburg County, which bridge is hereby declared to be a lawful structure to the same extent and in the same manner as if it had been constructed in accordance with the provisions of said Act of March 23, 1906.

Vol. 34, p. 84.

Amendment.

SEC. 2. The right to alter, amend, or repeal this Act is hereby expressly reserved.

Approved, May 27, 1933.

[CHAPTER 41.]

AN ACT

May 27, 1933.
[H. R. 5476.]
[Public, No. 25.]

To extend the times for commencing and completing the construction of a bridge across the Savannah River at or near Burtons Ferry, near Sylvania, Georgia.

Savannah River.
Time extended for
bridging, at Burtons
Ferry, Ga.
Vol. 45, p. 751; Vol. 47,
p. 135, amended.
Post, p. 918.

Be it enacted by the Senate and House of Representatives of the United States of America in Congress assembled, That the time for commencing and completing the construction of a bridge authorized by Act of Congress approved May 26, 1928, heretofore revived and reenacted by Act of Congress approved April 22, 1932, to be built by the South Carolina and Georgia State Highway Departments across the Savannah River at or near Burtons Ferry, near Sylvania, Georgia, are hereby extended one and three years, respectively, from the date of approval hereof.

Amendment.

SEC. 2. The right to alter, amend, or repeal this Act is hereby expressly reserved.

Approved, May 27, 1933.

2022-011769 MISC Page: 1096 of 2782

09/26/2022 03:35:37 PM Receipt #: 22-9381

Rec Fee: \$30.00 Darrell James Hill

Gila County, Az, Sadie Jo Bingham, Recorder



[CHAPTER 388]

AN ACT

To codify and enact into positive law, title 1 of the United States Code, entitled "General Provisions".

July 30, 1947
[H. R. 1665]
[Public Law 276]

Be it enacted by the Senate and House of Representatives of the United States of America in Congress assembled, That title 1 of the United States Code entitled "General Provisions", is codified and enacted into positive law and may be cited as "1 U. S. C., § —", as follows:

Title 1, U. S. Code.
Codification and enactment into positive law.

TITLE 1—GENERAL PROVISIONS

Chap.		Sec.
1. Rules of construction.....		1
2. Acts and resolutions; formalities of enactment; repeals; sealing of instruments.....		101
3. Code of Laws of United States and Supplements; District of Columbia Code and Supplements.....		201

CHAPTER 1—RULES OF CONSTRUCTION

- § 1. Words denoting number, gender, etc.
- § 2. "County" as including "parish", etc.
- § 3. "Vessel" as including all means of water transportation.
- § 4. "Vehicle" as including all means of land transportation.
- § 5. "Company" or "association" as including successors and assigns.
- § 6. Limitation of term "products of American fisheries."

WORDS DENOTING NUMBER, GENDER, AND SO FORTH

§ 1. In determining the meaning of any Act or resolution of Congress words importing the singular number may extend and be applied to several persons or things; words importing the plural number may include the singular; words importing the masculine gender may be applied to females; the words "insane person" and "lunatic" shall include every idiot, non compos, lunatic, and insane person; the word "person" may extend and be applied to partnerships and corporations, and the reference to any officer shall include any person authorized by law to perform the duties of such office, unless the context shows that such words were intended to be used in a more limited sense; and a requirement of an "oath" shall be deemed complied with by making affirmation in judicial form.

"COUNTY" AS INCLUDING "PARISH", AND SO FORTH

§ 2. The word "county" includes a parish, or any other equivalent subdivision of a State or Territory of the United States.

"VESSEL" AS INCLUDING ALL MEANS OF WATER TRANSPORTATION

§ 3. The word "vessel" includes every description of watercraft or other artificial contrivance used, or capable of being used, as a means of transportation on water.

"VEHICLE" AS INCLUDING ALL MEANS OF LAND TRANSPORTATION

§ 4. The word "vehicle" includes every description of carriage or other artificial contrivance used, or capable of being used, as a means of transportation on land.

"COMPANY" OR "ASSOCIATION" AS INCLUDING SUCCESSORS AND ASSIGNS

§ 5. The word "company" or "association", when used in reference to a corporation, shall be deemed to embrace the words "successors and assigns of such company or association", in like manner as if these last-named words, or words of similar import, were expressed.

1094



LIMITATION OF TERM "PRODUCTS OF AMERICAN FISHERIES"

§ 6. Wherever, in the statutes of the United States or in the rulings, regulations, or interpretations of various administrative bureaus and agencies of the United States there appears or may appear the term "products of American fisheries" said term shall not include fresh or frozen fish fillets, fresh or frozen fish steaks, or fresh or frozen slices of fish substantially free of bone (including any of the foregoing divided into sections), produced in a foreign country or its territorial waters, in whole or in part with the use of the labor of persons who are not residents of the United States.

CHAPTER 2—ACTS AND RESOLUTIONS; FORMALITIES OF ENACTMENT;
REPEALS; SEALING OF INSTRUMENTS

- § 101. Enacting clause.
- § 102. Resolving clause.
- § 103. Enacting or resolving words after first section.
- § 104. Numbering of sections; single proposition.
- § 105. Title of appropriation Acts.
- § 106. Printing bills and joint resolutions.
- § 107. Parchment or paper for printing enrolled bills or resolutions.
- § 108. Repeal of repealing act.
- § 109. Repeal of statutes as affecting existing liabilities.
- § 110. Saving clause of Revised Statutes.
- § 111. Repeals as evidence of prior effectiveness.
- § 112. Statutes at Large; contents; admissibility in evidence.
- § 113. "Little and Brown's" edition of laws and treaties; admissibility in evidence.
- § 114. Sealing of instruments.

ENACTING CLAUSE

§ 101. The enacting clause of all Acts of Congress shall be in the following form: "Be it enacted by the Senate and House of Representatives of the United States of America in Congress assembled."

RESOLVING CLAUSE

§ 102. The resolving clause of all joint resolutions shall be in the following form: "Resolved by the Senate and House of Representatives of the United States of America in Congress assembled."

ENACTING OR RESOLVING WORDS AFTER FIRST SECTION

§ 103. No enacting or resolving words shall be used in any section of an Act or resolution of Congress except in the first.

NUMBERING OF SECTIONS; SINGLE PROPOSITION

§ 104. Each section shall be numbered, and shall contain, as nearly as may be, a single proposition of enactment.

TITLE OF APPROPRIATION ACTS

§ 105. The style and title of all Acts making appropriations for the support of Government shall be as follows: "An Act making appropriations (here insert the object) for the year ending June 30 (here insert the calendar year)."

PRINTING BILLS AND JOINT RESOLUTIONS

§ 106. Every bill or joint resolution in each House of Congress shall, when such bill or resolution passes either House, be printed, and such printed copy shall be called the engrossed bill or resolution

2022-011769 MISC Page: 1098 of 2782
 09/26/2022 03:35:37 PM Receipt #: 22-9381
 Rec Fee: \$30.00 Darrall James Hill
 Gila County, Az, Sadie Jo Bingham, Recorder



1095

as the case may be. Said engrossed bill or resolution shall be signed by the Clerk of the House or the Secretary of the Senate, and shall be sent to the other House, and in that form shall be dealt with by that House and its officers, and, if passed, returned signed by said Clerk or Secretary. When such bill, or joint resolution shall have passed both Houses, it shall be printed and shall then be called the enrolled bill, or joint resolution, as the case may be, and shall be signed by the presiding officers of both Houses and sent to the President of the United States. During the last six days of a session such engrossing and enrolling of bills and joint resolutions may be done otherwise than as above prescribed, upon the order of Congress by concurrent resolution.

PARCHMENT OR PAPER FOR PRINTING ENROLLED BILLS OR RESOLUTIONS

§ 107. Enrolled bills and resolutions of either House of Congress shall be printed on parchment or paper of suitable quality as shall be determined by the Joint Committee on Printing.

REPEAL OF REPEALING ACT

§ 108. Whenever an Act is repealed, which repealed a former Act, such former Act shall not thereby be revived, unless it shall be expressly so provided.

REPEAL OF STATUTES AS AFFECTING EXISTING LIABILITIES

§ 109. The repeal of any statute shall not have the effect to release or extinguish any penalty, forfeiture, or liability incurred under such statute, unless the repealing Act shall so expressly provide, and such statute shall be treated as still remaining in force for the purpose of sustaining any proper action or prosecution for the enforcement of such penalty, forfeiture, or liability. The expiration of a temporary statute shall not have the effect to release or extinguish any penalty, forfeiture, or liability incurred under such statute, unless the temporary statute shall so expressly provide, and such statute shall be treated as still remaining in force for the purpose of sustaining any proper action or prosecution for the enforcement of such penalty, forfeiture, or liability.

SAVING CLAUSE OF REVISED STATUTES

§ 110. All acts of limitation, whether applicable to civil causes and proceedings, or to the prosecution of offenses, or for the recovery of penalties or forfeitures, embraced in the Revised Statutes and covered by the repeal contained therein, shall not be affected thereby, but all suits, proceedings, or prosecutions, whether civil or criminal, for causes arising, or acts done or committed prior to said repeal, may be commenced and prosecuted within the same time as if said repeal had not been made.

REPEALS AS EVIDENCE OF PRIOR EFFECTIVENESS

§ 111. No inference shall be raised by the enactment of the Act of March 3, 1933 (ch. 202, 47 Stat. 1431), that the sections of the Revised Statutes repealed by such Act were in force or effect at the time of such enactment: *Provided, however,* That any rights or liabilities existing under such repealed sections shall not be affected by their repeal.

Post, p. 641.

1096

2022-011769 MISC Page: 1099 of 2782
 09/26/2022 03:35:37 PM Receipt #: 22-9381
 Rec Fee: \$30.00 Darrell James Hill
 Gila County, Az, Sadie Jo Bingham, Recorder



STATUTES AT LARGE; CONTENTS; ADMISSIBILITY IN EVIDENCE

§ 112. The Secretary of State shall cause to be compiled, edited, indexed, and published, the United States Statutes at Large, which shall contain all the laws and concurrent resolutions enacted during each regular session of Congress; all treaties to which the United States is a party that have been proclaimed since the date of the adjournment of the regular session of Congress next preceding; all international agreements other than treaties to which the United States is a party that have been signed, proclaimed, or with reference to which any other final formality has been executed, since that date; all proclamations by the President in the numbered series issued since that date; and also any amendments to the Constitution of the United States proposed or ratified pursuant to article V thereof since that date, together with the certificate of the Secretary of State issued in compliance with the provision contained in section 160 of title 5. In the event of an extra session of Congress, the Secretary of State shall cause all the laws and concurrent resolutions enacted during said extra session to be consolidated with, and published as part of, the contents of the volume for the next regular session. The United States Statutes at Large shall be legal evidence of laws, concurrent resolutions, treaties, international agreements other than treaties, proclamations by the President, and proposed or ratified amendments to the Constitution of the United States therein contained, in all the courts of the United States, the several States, and the Territories and insular possessions of the United States.

"LITTLE AND BROWN'S" EDITION OF LAWS AND TREATIES; ADMISSIBILITY IN EVIDENCE

§ 113. The edition of the laws and treaties of the United States, published by Little and Brown, shall be competent evidence of the several public and private Acts of Congress, and of the several treaties therein contained, in all the courts of law and equity and of maritime jurisdiction, and in all the tribunals and public officers of the United States, and of the several States, without any further proof or authentication thereof.

SEALING OF INSTRUMENTS

§ 114. In all cases where a seal is necessary by law to any commission, process, or other instrument provided for by the laws of Congress, it shall be lawful to affix the proper seal by making an impression therewith directly on the paper to which such seal is necessary; which shall be as valid as if made on wax or other adhesive substance.

CHAPTER 3—CODE OF LAWS OF UNITED STATES AND SUPPLEMENTS;
DISTRICT OF COLUMBIA CODE AND SUPPLEMENTS

- § 201. Publication and distribution of Code of Laws of United States and Supplements and District of Columbia Code and Supplements.
- (a) Publishing in slip or pamphlet form or in Statutes at Large.
 - (b) Curtailing number of copies published.
 - (c) Dispensing with publication of more than one Supplement for each Congress.
- § 202. Preparation and publication of Codes and Supplements.
- (a) Cumulative Supplements to Code of Laws of United States for each session of Congress.
 - (b) Cumulative Supplement to District of Columbia Code for each session of Congress.
 - (c) New editions of Codes and Supplements.
- § 203. District of Columbia Code; preparation and publication; cumulative supplements.

2022-011769 MISC Page: 1100 of 2782
09/26/2022 03:35:37 PM Receipt #: 22-9381
Rec Fee: \$30.00 Darrell James Hill
Gila County, Az, Sadie Jo Bingham, Recorder



Unofficial

1097

- § 204. Codes and Supplements as evidence of the Laws of United States and District of Columbia; citation of Codes and Supplements.
- United States Code.
 - District of Columbia Code.
 - District of Columbia Code; citation.
 - Supplements to Codes; citation.
 - New edition of Codes; citation.
- § 205. Codes and Supplements; where printed; form and style; ancillaries.
- § 206. Bills and resolutions of Committee on the Judiciary of House of Representatives; form and style; ancillaries; curtailment of copies.
- § 207. Copies of acts and resolutions in slip form; additional number printed for Committee on the Judiciary of House of Representatives.
- § 208. Delegation of function of Committee on the Judiciary to other agencies; printing, etc., under direction of Joint Committee on Printing.
- § 209. Copies of Supplements to Code of Laws of United States and of District of Columbia Code and Supplements; conclusive evidence of original.
- § 210. Distribution of Supplements to Code of Laws of United States and of District of Columbia Code and Supplements; slip and pamphlet copies.
- § 211. Copies to Members of Congress.
- § 212. Additional distribution at each new Congress.
- § 213. Appropriation for preparing and editing supplements.

PUBLICATION AND DISTRIBUTION OF CODE OF LAWS OF UNITED STATES AND SUPPLEMENTS AND DISTRICT OF COLUMBIA CODE AND SUPPLEMENTS

- § 201. In order to avoid duplication and waste—
- Publishing in slip or pamphlet form or in Statutes at Large.—Publication in slip or pamphlet form or in the Statutes at Large of any of the volumes or publications enumerated in sections 202 and 203 of this title, shall, in event of enactment, be dispensed with whenever the Committee on the Judiciary of the House of Representatives so directs the Secretary of State;
 - Curtailling number of copies published.—Curtailment of the number provided by law to be printed and distributed of the volumes or publications enumerated in sections 202 and 203 of this title may be directed by such committee, except that the Public Printer shall print such numbers as are necessary for depository library distribution and for sale; and
 - Dispensing with publication of more than one Supplement for each Congress.—Such committee may direct that the printing and distribution of any supplement to the Code of Laws of the United States or to the Code of the District of Columbia be dispensed with entirely, except that there shall be printed and distributed for each Congress at least one supplement to each such code, containing the legislation of such Congress.

PREPARATION AND PUBLICATION OF CODES AND SUPPLEMENTS

- § 202. There shall be prepared and published under the supervision of the Committee on the Judiciary of the House of Representatives—
- Cumulative Supplements to Code of Laws of United States for each session of Congress.—A supplement for each session of the Congress to the then current edition of the Code of Laws of the United States, cumulatively embracing the legislation of the then current supplement, and correcting errors in such edition and supplement;
 - Cumulative Supplement to District of Columbia Code for each session of Congress.—A supplement for each session of the Congress to the then current edition of the Code of the District of Columbia, cumulatively embracing the legislation of the then current supplement, and correcting errors in such edition and supplement;
 - New editions of Codes and Supplements.—New editions of the Code of Laws of the United States and of the Code of the District of

1098

2022-011769 MISC Page: 1101 of 2782
 09/26/2022 03:35:37 PM Receipt #: 22-9381
 Rec Fee: \$30.00 Darrell James Hill
 Gila County, Az, Sadie Jo Bingham, Recorder



Columbia, correcting errors and incorporating the then current supplement. In the case of each code new editions shall not be published oftener than once in each five years. Copies of each such edition shall be distributed in the same manner as provided in the case of supplements to the code of which it is a new edition. Supplements published after any new edition shall not contain the legislation of supplements published before such new edition.

DISTRICT OF COLUMBIA CODE; PREPARATION AND PUBLICATION;
CUMULATIVE SUPPLEMENTS

§ 203. The Committee on the Judiciary of the House of Representatives is authorized to print bills to codify, revise, and reenact the general and permanent laws relating to the District of Columbia and cumulative supplements thereto, similar in style, respectively, to the Code of Laws of the United States, and supplements thereto, and to so continue until final enactment thereof in both Houses of the Congress of the United States.

CODES AND SUPPLEMENTS AS EVIDENCE OF THE LAWS OF UNITED STATES
AND DISTRICT OF COLUMBIA; CITATION OF CODES AND SUPPLEMENTS

§ 204. In all courts, tribunals, and public offices of the United States, at home or abroad, of the District of Columbia, and of each State, Territory, or insular possession of the United States—

(a) United States Code.—The matter set forth in the edition of the Code of Laws of the United States current at any time shall, together with the then current supplement, if any, establish prima facie the laws of the United States, general and permanent in their nature, in force on the day preceding the commencement of the session following the last session the legislation of which is included: *Provided, however,* That whenever titles of such Code shall have been enacted into positive law the text thereof shall be legal evidence of the laws therein contained, in all the courts of the United States, the several States, and the Territories and insular possessions of the United States.

(b) District of Columbia Code.—The matter set forth in the edition of the Code of the District of Columbia current at any time shall, together with the then current supplement, if any, establish prima facie the laws, general and permanent in their nature, relating to or in force in the District of Columbia on the day preceding the commencement of the session following the last session the legislation of which is included, except such laws as are of application in the District of Columbia by reason of being laws of the United States general and permanent in their nature.

(c) District of Columbia Code; citation.—The Code of the District of Columbia may be cited as "D. C. Code".

(d) Supplements to Codes; citation.—Supplements to the Code of Laws of the United States and to the Code of the District of Columbia may be cited, respectively, as "U. S. C., Sup. ", and "D. C. Code, Sup. ", the blank in each case being filled with Roman figures denoting the number of the supplement.

(e) New edition of Codes; citation.—New editions of each of such codes may be cited, respectively, as "U. S. C., ed.", and "D. C. Code, ed.", the blank in each case being filled with figures denoting the last year the legislation of which is included in whole or in part.

2022-011769 MISC Page: 1102 of 2782

09/26/2022 03:35:37 PM Receipt #: 22-9381
Rec Fee: \$30.00 Darrell James Hill

Gila County, Az, Sadie Jo Bingham, Recorder



1099

CODES AND SUPPLEMENT; WHERE PRINTED; FORM AND STYLE; ANCILLARIES

§ 205. The publications provided for in sections 202, 203 of this title shall be printed at the Government Printing Office and shall be in such form and style and with such ancillaries as may be prescribed by the Committee on the Judiciary of the House of Representatives. The Librarian of Congress is directed to cooperate with such committee in the preparation of such ancillaries. Such publications shall be furnished with such thumb insets and other devices to distinguish parts, with such facilities for the insertion of additional matter, and with such explanatory and advertising slips, and shall be printed on such paper and bound in such material, as may be prescribed by such committee.

BILLS AND RESOLUTIONS OF COMMITTEE ON THE JUDICIARY OF HOUSE OF REPRESENTATIVES; FORM AND STYLE; ANCILLARIES; CURTAILMENT OF COPIES

§ 206. All bills and resolutions relating to the revision of the laws referred to or reported by the Committee on the Judiciary of the House of Representatives shall be printed in such form and style, and with such ancillaries, as such committee may prescribe as being economical and suitable, to so continue until final enactment thereof in both Houses of Congress; and such committee may also curtail the number of copies of such bills to be printed in the various parliamentary stages in the House of Representatives.

COPIES OF ACTS AND RESOLUTIONS IN SLIP FORM; ADDITIONAL NUMBER PRINTED FOR COMMITTEE ON THE JUDICIARY OF HOUSE OF REPRESENTATIVES

§ 207. The Public Printer is directed to print, in addition to the number provided by existing law, and, as soon as printed, to distribute in such manner as the Committee on the Judiciary of the House of Representatives shall determine, twenty copies in slip form of each public Act and joint resolution.

DELEGATION OF FUNCTION OF COMMITTEE ON THE JUDICIARY TO OTHER AGENCIES; PRINTING, AND SO FORTH, UNDER DIRECTION OF JOINT COMMITTEE ON PRINTING

§ 208. The functions vested by sections 201, 202, 204-207 of this title in the Committee on the Judiciary of the House of Representatives may from time to time be vested in such other agency as the Congress may by concurrent resolution provide: *Provided*, That the printing, binding, and distribution of the volumes and publications enumerated in sections 202, 203 of this title shall be done under the direction of the Joint Committee on Printing.

COPIES OF SUPPLEMENTS TO CODE OF LAWS OF UNITED STATES AND OF DISTRICT OF COLUMBIA CODE AND SUPPLEMENTS; CONCLUSIVE EVIDENCE OF ORIGINAL

§ 209. Copies of the Code of Laws relating to the District of Columbia and copies of the supplements provided for by sections 202, 203 of this title printed at the Government Printing Office and bearing its imprint, shall be conclusive evidence of the original of such code and supplements in the custody of the Secretary of State.

2022-011769 MISC Page: 1103 of 2782
 09/26/2022 03:35:37 PM Receipt #: 22-9381
 Rec Fee: \$30.00 Darrell James Hill
 Gila County, Az, Sadie Jo Bingham, Recorder



1100

STATUTES AT LARGE OR REVISED STATUTES	Title 1, United States Code, section
R. S., sec. 1	1
R. S., sec. 2	2
R. S., sec. 3	3
R. S., sec. 4	4
R. S., sec. 5	5
Act June 11, 1940, ch. 325, sec. 1, 54 Stat. 305	6
R. S., sec. 7	21
R. S., sec. 8	22
R. S., sec. 9	23
R. S., sec. 10	24
R. S., sec. 11	25
Res. Nov. 1, 1893, 28 Stat. Appendix 5; act Mar. 2, 1895, ch. 177, sec. 1, 28 Stat. 789	26
Act Mar. 0, 1920, ch. 94, sec. 1, 41 Stat. 520	27
R. S., sec. 12	28
R. S., sec. 13; Mar. 22, 1944, ch. 123, 58 Stat. 118	29
R. S., sec. 5599	29a
Act Mar. 3, 1933, ch. 202, sec. 3, 47 Stat. 1431	29b
Act Jan. 12, 1895, ch. 23, sec. 73, 28 Stat. 615; June 20, 1936, ch. 630, sec. 9, 49 Stat. 1551; June 16, 1938, ch. 477, sec. 1, 52 Stat. 769	30
R. S., sec. 908	30a
R. S., sec. 6	31
Res. Mar. 2, 1929, ch. 586, sec. 1, 45 Stat. 1540	51a
Act May 29, 1928, ch. 910, sec. 2, 45 Stat. 1007; Res. Mar. 2, 1929, ch. 586, sec. 2, 45 Stat. 1541	52
Act May 29, 1928, ch. 910, sec. 3, 45 Stat. 1007	53
Act May 29, 1928, ch. 910, sec. 4, 45 Stat. 1007; Res. Mar. 2, 1929, ch. 586, sec. 3, 45 Stat. 1541	54
Res. Mar. 2, 1929, ch. 586, sec. 4, 45 Stat. 1542; Act Mar. 4, 1933, ch. 282, sec. 1, 47 Stat. 1003; June 13, 1934, ch. 483, secs. 1, 2, 48 Stat. 948	54a
Res. Mar. 2, 1929, ch. 586, sec. 5, 45 Stat. 1542; Act Mar. 4, 1933, ch. 282, sec. 1, 47 Stat. 1003; June 13, 1934, ch. 483, secs. 1, 2, 48 Stat. 948	54b
Res. Mar. 2, 1929, ch. 586, sec. 6, 45 Stat. 1542	54c
Res. Mar. 2, 1929, ch. 586, sec. 7, 45 Stat. 1542	54d
Act May 29, 1928, ch. 910, sec. 5, 45 Stat. 1007	55
Act May 29, 1928, ch. 910, sec. 6, 45 Stat. 1007	56
Act May 29, 1928, ch. 910, sec. 7, 45 Stat. 1008	57
Act May 29, 1928, ch. 910, sec. 8, 45 Stat. 1008	58
Act May 29, 1928, ch. 910, sec. 10, 45 Stat. 1008	59
Act Mar. 3, 1933, ch. 202, sec. 2, 47 Stat. 1431	60

Approved July 30, 1947.

[CHAPTER 389]

AN ACT

To codify and enact into positive law title 4 of the United States Code, entitled "Flag and seal, Seat of Government, and the States".

July 30, 1947
[H. R. 1568]
[Public Law 279]

Be it enacted by the Senate and House of Representatives of the United States of America in Congress assembled, That title 4 of the United States Code, entitled "Flag and seal, Seat of Government, and the States", is codified and enacted into positive law and may be cited as "4 U. S. C., § —", as follows:

Title 4, U. S. Code.
Codification and enactment into positive law.

TITLE 4—FLAG AND SEAL, SEAT OF GOVERNMENT, AND THE STATES

Chap.	Sec.
1. The Flag	1
2. The Seal	41
3. Seat of the Government	71
4. The States	101





Notice of Claim: USPS RMN~ RE 322 404 067 US:

Denial of Signature Guarantee for: Exempted Security: June 2019: Wells Fargo, Bank, N.A., Personnel at the MAC S3913-011 ~Apache Junction, Arizona~ ,with: Stated Corroboration of: Wells Fargo Bank's Resolution Department and Legal Department

Arizona state
Pinal county

:Man :Darrell- James: Hill personally presents before me, the undersigned Notary duly authorized by the laws of Arizona to administer oaths; now on this 14th day: June: 2019, being by me first duly sworn on his affirmation, claimant deposes and says:

Claim

1. (A) :i- man of the family Hill am a) :Darrell-James (given-name)-beneficiary, and :owner of the property (a) :inherent-trust by the Almighty-God and (b): beneficiary -subrogee -in the idem sonans- trust by the subrogor: UNITED-STATES-government- Trustee. See: Notice of Claim: USPS RMN~ RE 322 404 067 US: Verification of the Known Birth/Berth Statuses: man: Darrell-James: Hill; AND '

(B) On June 11th 2019, in accordance with the Security Exchange Act of 1934, the Wells Fargo banking (WFbank) association account was Not a brokerage type or brokerage services relationship, nor a securities account for :i; and:

(C) in accordance with the Security Exchange Act of 1934, on June 11th, 2019 was presented for the certification: Demand- :Equity Note: 2019-1158-001 - RE 322 404 067 US- to the man, Dominic: Personal Banker, MNLS ID: 1546144/ card – copy on p. 2, for a secured signature certification that the WFbank call's a medallion stamp.

(D) Dominic, stating-so before, began asking other bank personnel about his ability to provide the signature guarantee for the Exempted-security, and

(E) Dominic asked and sent a copy of the security to the WFbank resolution department.

(F) Dominic brought forward the man Berenisse: Branch Manager, MNLSR ID: 936102/ card – copy on p. 2; and,

(G) Before :i and my wife where Berenisse ordered Dominic to not complete the guaranteed signature request of :i,

(H) openly stating that H.i) she did not understand the law, rules or regulations effecting the transaction, and that H.ii) her superior ordered her to Not complete the certification on the exempted document request.

(I) :i inquired about the STAMP manual that should be made public for to investigate this matter, but the manual was not presented.

(J) At this juncture, :i asked Dominic and Berenisse for a written and signed document identifying the reasons for their denial of the signature guarantee request.

(K.i) On June 13th, 2019, :i was contacted by telephone twice from the # (855) 931-2468: a man for the WF Resolution Department identified themselves as Monika, who was already known to :i as Tracy0, from a prior conversation, and (K.ii) she agreed, adding: 'This phone call is

1102
Claim: Denial of Signature Guarantee for: Exempted Security: June 2019: Wells Fargo, Bank, N.A., Personnel at the MAC S3913-011 ~Apache Junction, Arizona~ ,with: Stated Corroboration of: Wells Fargo Bank's Resolution Department and Legal Department 1 / 3

09/26/2022 03:35:37 PM Receipt #: 22-9381-
Rec Fee: \$30.00 Darrell James Hill
Gila County, Az, Sadie Jo Bingham, Recorder



Dominic Stewart
Personal Banker
NMLS ID: 1546144

MAC S3913-011
231 S Phelps Dr.
Apache Junction, AZ 85120
Tel: 480 982 1039
Fax: 480 677 7597
800 TO WELLS

Dominic.Stewart@WellsFargo.com

Wells Fargo Bank, N.A.



Berenisse Romero
Branch Manager
NMLSR ID: 936102

MAC S3913-011
231 S Phelps Dr.
Apache Junction, AZ 85120
Tel: 480 982 1039
Fax: 480 677 7597
800 TO WELLS

INTENTIONALLY LEFT BLANK

1103

Claim: Denial of Signature Guarantee for: Exempted Security: June 2019: Wells Fargo, Bank, N.A., Personnel at the MAC S3913-011 ~Apache Junction, Arizona~, with: Stated Corroboration of: Wells Fargo Bank's Resolution Department and Legal Department

monitored and recorded.... : All calls are monitored and recorded.'

(K.iii) I agreed as so long as the content of the call is available to :i, et seq., as requested.

(M) The conversations (2) calls ended with Tracy0 stating that her legal department ordered her that (M.i) because the exempted-security is Not a *marketable* security; that: (M.ii) in despite of the verbage of the law, regulations and rules, (M.iii) the fact that the United States government Trustee is the guarantor, and that (M.iv) :i requested a written documentation of these events, and that a record of same must, according to the law-regulations-and rules, a record of these events must be maintained for a period of or about three years, etc., that: (M.v) Tracy0 stated that she is not lawyer, that (M.vi) she does not know what the law, regulations or the rules say, that (M.vii) she did not know what the policy manual is or where it can be found, that (M.viii) she did not understand the WFbank secured signature policy sheet, and (M.ix) did not know what legal-language was saying, etc., that (M.x) she, Tracy0 had in fact been ordered to represent WFbank for (M.xi) to conclude to Not comply with the lawful request by the beneficiary to the United States government Trustee - guarantor of the exempted-security because the security was solely not only a *marketable* security as defined by the WFbank as relates to the exempted-security.'

2. Phone contact on the 14th day June; 2019: Dominic verifies the WFbank orders of: § 1.(M).

3. In accordance with the Security Exchange Act of 1934 was presented by :i for the certification of a document :Demand- :Equity Note: 2019-1158-001 - RE 322 404 067 US- for the United States government Trustee guarantor. Heretofore, appended with this document as evidence of the beneficiary and authorized representative of the subrogation certification.

4. :i -man am :Darrell-James: Hill, :Ohioan by the known presents and within the regard to the Trading With The Enemy Act of 1917 (49 Stat. L. 411), as amended, am :civilian ~ am-Not :combatant, and am-Not :enemy, and am-Not :ally-of-enemy.

:i- man verify that all stated herein is true and correct and will state same onto the record in the open court.

Without prejudice:

Darrell-James Hill
:Darrell-James: Hill, :beneficiary, :Executor

Unofficial Copy

1107

Claim: Denial of Signature Guarantee for: Exempted Security: June 2019: Wells Fargo, Bank, N.A., Personnel at the MAC S3913-011 ~Apache Junction, Arizona~, with: Stated Corroboration of: Wells Fargo Bank's Resolution Department and I

2022-011769 MISC Page: 1107 of 2782
09/26/2022 03:35:37 PM Receipt #: 22-9381
Rec Fee: \$30.00 Darrell James Hill
Gila County, Az, Sadie Jo Bingham, Recorder



:Darrell-James: Hill, Beverly-Jean: Romero- Hill c/o PO Box 3806, Apache Junction, Arizona, 85117

:William-P: United States Attorney General Barr
Alien Property Custodian
U.S. Department of Justice
950 Pennsylvania Avenue, NW
Washington, District of Columbia 20530-001

USPS RMN: RE 322 404 084 US

Re: Alien Property Custodian Notices: Agreement :Civilian Status

:William-P, Greetings:

We pray for you William. Thank you for your service.

This :contact is about the Alien-Property-Custodian- duties associated to your appointment as the United States Attorney General, last appointed by the 1933- President- Roosevelt concerning the matter(s) of the alienated-property of any presumed enemy by the Emergency Banking Act of 1933 ~Trading With the Enemy Act (amended: 1933). The act, et seq. set a legal- presumption- of- an- enemy status upon all people of The United States of America implemented today by the means of a subrogation assigned each man-child on or about our birth day. And, until stated as otherwise, ... -

Appended hereto are the Notices* sent to you (William-P: Barr~ Alien-Property-Custodian -on your- appointment), the :man to serve as the United States Attorney General - 5 pages for the each: (a) husband: Darrell-James: Hill, and (b) wife: Beverly-Jean: Romero- Hill.

* Notice to the UNITED STATES Government Trustee~ Alien Property Custodian c/o: William-P: United States Attorney General Barr, that:

i -man -beneficiary :(a)/(b) from the birth-unto-now am a Civilian, not a :combatant, belligerent, or ally-of-enemy of The United States of America Constitutional Republic nor with the UNITED STATES government services provider- Trustee; and: Notice to the Agent is Notice to the Principal; Notice to the Principal is Notice to the Agent. i -man Wish for the Remedy of this Right-executed.

In the accordance with the Law and laws of the contract, it is our option to execute on the right of the citizen status for the normalized man-beneficiary -U.S. government-trustee relations established by the Emergency Banking Act of 1933. :Notice for the Remedy to the legal- enemy- presumption of the Emergency Banking Act of 1933 is necessary by the legislative Act under the Law.

:Presumption is now set. Regarding the beneficiary :Darrell-James: Hill ~husband and: Beverly-Jean: Romero- Hill~wife described in the corresponding notices, including the: et al. derivative names, respectfully, it is settled and agreed upon the receipt of this document: civilians with regard to the Trading with the Enemy Act- 1917¹, TWEA, sec. 5(b) as amended within the Emergency Banking Act- 1933.

Appended: Husband and Wife Notices

Sincerely, Thank you;

Without prejudice, DARRELL JAMES HILL

Darrell James Hill, A.R.

:Darrell-James: Hill, :man, :Executor

Without prejudice, BEVERLY JEAN ROMERO- HILL

Beverly Jean Romero Hill, A.R.

:Beverly-Jean: Romero- Hill, :man, :Executor

IURAT

Sworn to and subscribed before me now on this 27th day: June: 2019.

Produced identification: type: Arizona Driver License.

Dominic Stewart

Notary

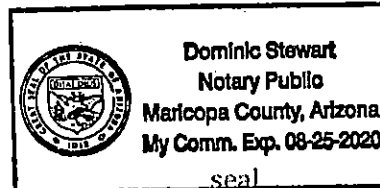

1 Trading With The Enemy Act - 1917 means: 40 Stat. 411.



APACHE JUNCTION
151 W SUPERSTITION BLVD
APACHE JUNCTION, AZ
85120-9998
0302590130

06/27/2019 (800)275-8777 2:49 PM

Product Description	Sale Qty	Final Price
---------------------	----------	-------------

First-Class Mail Letter	1	\$0.85
-------------------------	---	--------

(Domestic)
(WASHINGTON, DC 20500)
(Weight: 0 Lb 2.60 Oz)
(Estimated Delivery Date)
(Monday 07/01/2019)

Registered	1	\$12.95
------------	---	---------

(Amount: \$50.00)
((USPS Registered Mail #)
(RE322404098US)

Return Receipt	1	\$2.80
----------------	---	--------

((USPS Return Receipt #)
(9590940247428344639875)

Non Mach. Surch.	1	\$0.15
------------------	---	--------

First-Class Mail Letter	1	\$0.85
-------------------------	---	--------

(Domestic)
(WASHINGTON, DC 20530)
(Weight: 0 Lb 2.60 Oz)
(Estimated Delivery Date)
(Monday 07/01/2019)

Registered	1	\$12.95
------------	---	---------

(Amount: \$50.00)
((USPS Registered Mail #)
(RE322404084US)

Return Receipt	1	\$2.80
----------------	---	--------

((USPS Return Receipt #)
(9590940242158121976378)

Non Mach. Surch.	1	\$0.15
------------------	---	--------

Total		\$33.50
-------	--	---------

Cash Change		\$40.00 (\$6.50)
-------------	--	---------------------

Due to the security of Registered Mail, an additional 3-10 delivery days should be added to the expected

Registered No. RE322404084US

Date Stamp

To Be Completed By Post Office	Postage \$	\$0.85	Extra Services & Fees (continued)
	Extra Services & Fees		<input type="checkbox"/> Signature Confirmation
	<input type="checkbox"/> Registered Mail	\$12.95	<input type="checkbox"/> Signature Confirmation Restricted Delivery
	<input type="checkbox"/> Return Receipt (hardcopy)	\$2.80	
	<input type="checkbox"/> Return Receipt (electronic)	\$0.00	
	<input type="checkbox"/> Restricted Delivery	\$0.00	Total Postage & Fees \$16.75
Customer Must Declare Full Value	\$50.00	Received by	06/27/2019

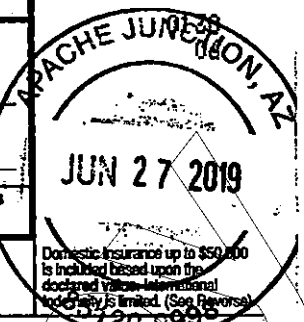

OFFICIAL USE

To Be Completed By Customer (Please Print) All Entries Must Be in Ballpoint or Typed	FROM	APACHE JUNCTION, AZ 85120
		Darrell James Hill Beverly Jean Romero Hill PO Box 3806 Apache Junction, Arizona 85117
	TO	WASHINGTON, DC 20530
		William P. Hoffed States Attorney General Barr 950 Pennsylvania Avenue, NW Washington, District of Columbia 20530-001

PS Form 3806, Registered Mail Receipt

Copy 1 - Customer (See Information on Reverse)

Registered No. RE322404098US

Date Stamp

To Be Completed By Post Office	Postage \$	\$0.85	Extra Services & Fees (continued)
	Extra Services & Fees		<input type="checkbox"/> Signature Confirmation
	<input type="checkbox"/> Registered Mail	\$12.95	<input type="checkbox"/> Signature Confirmation Restricted Delivery
	<input type="checkbox"/> Return Receipt (hardcopy)	\$2.80	
	<input type="checkbox"/> Return Receipt (electronic)	\$0.00	
	<input type="checkbox"/> Restricted Delivery	\$0.00	Total Postage & Fees \$16.75
Customer Must Declare Full Value	\$50.00	Received by	06/27/2019

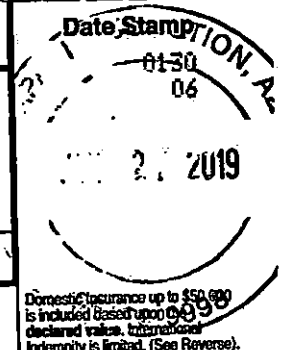

OFFICIAL USE

To Be Completed By Customer (Please Print) All Entries Must Be in Ballpoint or Typed	FROM	APACHE JUNCTION, AZ 85120
		Darrell James Hill Beverly Jean Romero Hill PO Box 3806 Apache Junction, Arizona 85117
	TO	WASHINGTON, DC 20500
		Donald Trump 1600 Pennsylvania Avenue NW Washington, DC 20500

PS Form 3806, Registered Mail Receipt

Copy 1 - Customer (See Information on Reverse)

2022-011769 MISC Page: 1109 of 2782

09/26/2022 03:35:37 PM Receipt #: 22-9381
Rec Fee: \$30.00 Darrell James Hill
Gila County, Az, Sadie Jo Bingham, Recorder



SENDER: COMPLETE THIS SECTION

- Complete items 1, 2, and 3.
- Print your name and address on the reverse so that we can return the card to you.
- Attach this card to the back of the mailpiece, or on the front if space permits.

1. Article Addressed to:

William F. United States Attorney General Burr
 Allen Property Custodian
 650 Pennsylvania Avenue, NW
 Washington, District of Columbia 20530-001



9590 9402 4215 8121 9763 78

2. Article Number (Transfer from service label)

RE 322 404 084 US

PS Form 3811, July 2015 PSN 7530-02-000-9053

COMPLETE THIS SECTION ON DELIVERY

A. Signature

X

- Agent
- Addressee

B. Received by (Print Name)

C. Date of Delivery

D. Is delivery address different from item 1? Yes
 If YES, enter delivery address below: No

3. Service Type

- Adult Signature
- Adult Signature Restricted Delivery
- Certified Mail®
- Certified Mail Restricted Delivery
- Collect on Delivery
- Collect on Delivery Restricted Delivery
- Insured Mail
- Insured Mail Restricted Delivery (over \$500)
- Priority Mail Express®
- Registered Mail™
- Registered Mail Restricted Delivery
- Return Receipt for Merchandise
- Signature Confirmation™
- Signature Confirmation Restricted Delivery

Domestic Return Receipt

SENDER: COMPLETE THIS SECTION

- Complete items 1, 2, and 3.
- Print your name and address on the reverse so that we can return the card to you.
- Attach this card to the back of the mailpiece, or on the front if space permits.

1. Article Addressed to:

Joseph United States President Trump
 1400 Pennsylvania Avenue NW
 Washington, DC 20500



9590 9402 4742 8344 6398 75

2. Article Number (Transfer from service label)

RE 322 404 098 US

PS Form 3811, July 2015 PSN 7530-02-000-9053

COMPLETE THIS SECTION ON DELIVERY

A. Signature

X

- Agent
- Addressee

B. Received by (Printed Name)

C. Date of Delivery

D. Is delivery address different from item 1? Yes
 If YES, enter delivery address below: No

3. Service Type

- Adult Signature
- Adult Signature Restricted Delivery
- Certified Mail®
- Certified Mail Restricted Delivery
- Collect on Delivery
- Collect on Delivery Restricted Delivery
- Insured Mail
- Insured Mail Restricted Delivery (over \$500)
- Priority Mail Express®
- Registered Mail™
- Registered Mail Restricted Delivery
- Return Receipt for Merchandise
- Signature Confirmation™
- Signature Confirmation Restricted Delivery

Domestic Return Receipt

2022-011769 MISC Page: 1110 of 2782

09/26/2022 03:35:37 PM Receipt #: 22-9381

Rec Fee: \$30.00 Darrell James Hill

Gila County, Az, Sadie Jo Bingham, Recorder



:Beverly-Jean: Romero- Hill c/o PO Box 3806, Apache Junction, Arizona, 85117:

Arizona state
Pinal county

:Man :Beverly-Jean: Romero- Hill personally presents before me, the undersigned Notary duly authorized by the laws of Arizona to administer oaths; now on this 26th day: June: 2019, being by me first duly sworn, on his affirmation, claimant deposes and says:

Notice to the UNITED STATES Government Trustee~ Alien Property Custodian c/o: William-P: United States Attorney General Barr, that: i -man -beneficiary :Beverly-Jean: Romero- Hill from the birth-unto-now am a Civilian, not a :combatant, belligerent, or ally-of-enemy of The United States of America Constitutional Republic nor with the UNITED STATES government services provider- Trustee; and: Notice to the Agent is Notice to the Principal; Notice to the Principal is Notice to the Agent. :i -man Wish for the Remedy of this Right-executed.

:William-P: United States Attorney General Barr
Alien Property Custodian
U.S. Department of Justice
950 Pennsylvania Avenue, NW
Washington, District of Columbia 20530-001

USPS RMN: RE 322 404 084 US

William-P, Greetings:

A) Affiant is:

- (1) **man: Beverly-Jean: Romero- Hill** - :New Mexican: known by the given-name: Beverly-Jean: (of the family) Romero, :birth: New Mexico state: © 01:59 A.M.~ :15th: June~1958¹;
- (2) **beneficiary (a)** of the right of the man by the Almighty-God, where nothing stands between :i and the Almighty-God;
- (3) **beneficiary (b)** of The United States of America Constitutional Republic, et seq. and thereto of the subsequent Emergency Banking Act- 1933² UNITED STATES Trust Fund ~ administered by the UNITED-STATES- government- Trustee ~by the way of the idem sonans- subrogation titled: BEVERLY JEAN ROMERO, : berth: State of New Mexico: © June 15th, 1958:
- (4) **Authorized Representative, A.R., is: Beverly-Jean: Romero- Hill, A.R.** :i- man- sui juris am: appointed :Authorized Representative by the beneficiary- sui juris, now Executor in all of the matters of the cestui que vie: Beverly-Jean: Romero- Hill; and: as relates to:
 1. **Emergency Banking Act- 1933 and the: Trading with the Enemy Act- 1917³, TWEA, sec. 5(b) amended, 1933**, the :UNITED-STATES-government Executive Orders and Congressional Acts implemented within the Emergency Banking Act of 1933 with the TWEA, sec. 5(b) amendment, et seq. then, established the emergency trustee relationship for the people of the in:erent-right of The United States of America with the UNITED- STATES- government Trustee taking title-ownership and usufruct of the collateral~ of the people's property, with the people retaining/holding the right of the equitable- cestui que use- interest. Furthermore, as relates to:
 2. **The Enemy-Presumption imposed onto :i -man -beneficiary by the TWEA, sec. 5(b) as amended 1933**, the term: enemy is defined by the TWEA, sec. 5(b) amended 1933, as any person(s) as :determined by the President of the UNITED STATES. - And: thereto, no equity distribution to any UNITED STATES Trust Fund beneficiary-presumed-to-be-the-enemy is legal by the UNITED STATES government Trustee, et al.~ Alien Property

1 Beverly-Jean: Romero- Hill, © 1958 means: the year of the birth of the man-child: Beverly-Jean: Romero- Hill. See: evidence: Authenticated Certificate of Birth – appended: 3 pages.
2 Emergency Bank Act of 1933 means: 48 Stat. 1.
3 Trading With The Enemy Act - 1917 means: 40 Stat. 411.



1108

:Beverly-Jean: Romero- Hill c/o PO Box 3806, Apache Junction, Arizona, 85117:

Custodian⁴ unless and until the not- an- enemy- combatant⁵, not- a- belligerent, or not- an- ally-of-enemy is declared by the individual person- beneficiary: Beverly-Jean: Romero- Hill.

(B) :Remedy is now Required by the Law: For that :i- man -beneficiary- :Beverly-Jean: Romero- Hill from the 1958 A.D. birth-unto-now: June~2019 am a Civilian and not a :combatant, belligerent, or ally-of-enemy of The United States of America Constitutional Republic, :i- man- beneficiary wish by the execution of this document for the remedy:

(a) non-discriminatory civilian status for the man- beneficiary :Beverly-Jean: Romero- Hill described herein and/or accounted-for with the subrogation: BEVERLY JEAN ROMERO, et al. derivative names;

(b) now, ascertained unrestricted transference to :i- man of the (b.i.) equitable benefit(s) and (b.ii.) other possessions, due, past due and/or otherwise held or owed to :i- man- beneficiary from now upon the delivery of this notice; and, that:

(c) all of the actors of the UNITED-STATES-Government-Trustee must now-to-fore administer to protect and ensure these :all-right(s)-executed.

(C) :Presumption is now set. :i- man- beneficiary :Beverly-Jean: Romero- Hill described herein and/or accounted-for with the subrogation: BEVERLY JEAN ROMERO~ et al. derivative names, upon the receipt of this notice is then-after settled and agreed: civilian with regard to the Trading with the Enemy Act- 1917⁶, TWEA, sec. 5(b) as amended within the Emergency Banking Act- 1933.

cc: Donald: United States President Trump

:i- man verify that all stated herein is true and correct and will state same onto the record in the open court.

Thank you;

Without prejudice
BEVERLY JEAN ROMERO- HILL-

Beverly Jean Romero Hill
:Beverly-Jean: Romero- Hill, :man, :Executor

IURAT

Sworn to and subscribed before me now on this 26th day: June: 2019.
Produced identification: type: Arizona Driver License.

E.A.

Notary

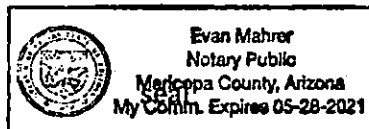

4 Alien Property Custodian means: 1) person assigned by the President of the UNITED STATES for to manage the responsibilities of the custody of the alien property as relates to the Emergency Banking Act-of 1933, et seq., and now is: William-P.: United States Attorney General Barr as late as: June 26th, 2019 A.D. See: Reorg. Plan No. 1 of 1947, §101, eff. July 1, 1947, 12 F.R. 4534, 61 Stat. 951.
5 Combatant means: a soldier engaged within or about an occupation against an enemy combatant.
6 Trading With The Enemy Act - 1917 means: 40 Stat. 411.



1109

United States of America



DEPARTMENT OF STATE

To all to whom these presents shall come, Greetings:

I Certify That the document hereunto annexed is under the Seal of the State(s) of New Mexico, and that such Seal(s) is/are entitled to full faith and credit.*

**For the contents of the annexed document, the Department assumes no responsibility
This certificate is not valid if it is removed or altered in any way whatsoever*

In testimony whereof, I, Michael R. Pompeo, Secretary of State, have hereunto caused the seal of the Department of State to be affixed and my name subscribed by the Assistant Authentication Officer, of the said Department, at the city of Washington, in the District of Columbia, this fifteenth day of August, 2018.

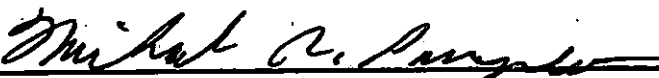
Secretary of State

By 

1110
Issued pursuant to CHXIV, State of Sept. 15, 1789, 1 Stat. 68-69; 22 USC 2657; 22 USC 2651a; 5 USC 301; 28 USC 1733 et. seq.; 8 USC 1443(f); RULE 44 Federal Rules of Civil Procedure.

2022-011769 MISC Page: 1113 of 2782
09/26/2022 03:35:37 PM Receipt #: 22-9381
Rec Fee: \$30.00 Darrell James Hill
Gila County, Az, Sadie Jo Bingham, Recorder



For: Demonstration Purposes Only;
Day: June 26, 2019
Autograph: *Darrell James Hill*



Unofficial Copy

2022-011769 MISC Page: 1114 of 2782
09/26/2022 03:35:37 PM Receipt #: 22-9381
Rec Fee: \$30.00 Darrell James Hill
Gila County, Az, Sadie Jo Bingham, Recorder



STATE OF NEW MEXICO



OFFICE OF THE
SECRETARY OF STATE
CERTIFICATE

I, MAGGIE TOULOUSE OLIVER, SECRETARY OF STATE FOR NEW MEXICO, DO
HEREBY CERTIFY

THAT

DONNA DOSSEY was the State Registrar VITAL STATISTICS, OFFICE OF VITAL RECORDS
AND HEALTH STATISTICS, PUBLIC HEALTH DIVISION, DEPARTMENT OF HEALTH for the
state of New Mexico on the date of execution shown on the Birth Certificate for BEVERY JEAN
ROMERO CERTIFICATE NO: (19581503459) and appointed to the office with full authority to exercise
the duties and responsibilities of State Registrar and legally entrusted with the possession and custody of
the records and files thereof.

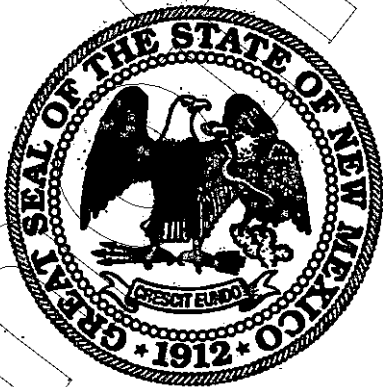

GIVEN UNDER MY HAND AND THE
GREAT SEAL OF THE STATE OF
NEW MEXICO, IN THE CITY OF
SANTA FE, THE CAPITAL, ON THIS
16TH DAY OF JULY, 2018 A.D.

Maggie Toulouse Oliver

SECRETARY OF STATE

1112



**For: Demonstration Purposes Only;
Day: June 26, 2019
Autograph: Beverly Jean Darrell Hill**



113

2022-011769 MISC Page: 1116 of 2782
09/26/2022 03:35:37 PM Receipt #: 22-9381
Rec Fee: \$30.00 Darrell James Hill
Gila County, Az, Sadie Jo Bingham, Recorder



HEALTH



BEVERLY JEAN ROMERO <<>

TERIO C ROMERO <<>

MARY ARGUEBLO <<>

ADVERTENCIA: Es ilegal alterar, copiar o falsificar este certificado

DO NOT DUPLICATE BY ANY MEANS

WARNING: It is illegal to alter, copy or counterfeit this certificate • ADVERTENCIA: Es ilegal alterar, copiar o falsificar este certificado

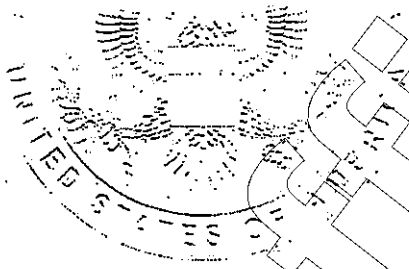

In testimony whereof, I, Michael R. Pompeo, Secretary of State, have hereunto caused the seal of the Department of State to be affixed and my name subscribed by the Assistant Authentication Officer, of the said Department, at the city of Washington, in the District of Columbia, this fifteenth day of August, 2018.

Michael R. Pompeo
Secretary of State

By *[Signature]*
Assistant Authentication Officer,
Department of State

Issued pursuant to CHXIV, State of Sept. 15, 1789, 1 Stat. 68-69; 22 USC 2657; 22 USC 2651a; 5 USC 301; 28 USC 1733 et. seq.; 8 USC 1443(f); RULE 44 Federal Rules of Civil Procedure.

2022-011769 MISC Page: 1117 of 2782
09/26/2022 03:35:37 PM Receipt #: 22-9381
Rec Fee: \$30.00 Darrell James Hill
Gila County, Az, Sadie Jo Bingham, Recorder



For: Demonstration Purposes Only;
Day: June 26, 2019
Autograph: Beverly Jean T...



1115

2022-011769 MISC Page: 1118 of 2782
09/26/2022 03:35:37 PM Receipt #: 22-9381
Rec Fee: \$30.00 Darrell James Hill
Gila County, Az, Sadie Jo Bingham, Recorder



:Darrell-James: Hill c/o PO Box 3806, Apache Junction, Arizona, 85117:

Arizona state
Pinal county

:Man :Darrell- James: Hill personally presents before me, the undersigned Notary duly authorized by the laws of Arizona to administer oaths; now on this 26th day: June: 2019, being by me first duly sworn, on his affirmation, claimant deposes and says:

Notice to the UNITED STATES Government Trustee~ Alien Property Custodian c/o: William-P: United States Attorney General Barr, that: i -man -beneficiary :Darrell-James: Hill from the birth-unto-now am a Civilian, not a :combatant, belligerent, or ally-of-enemy of The United States of America Constitutional Republic nor with the UNITED STATES government services provider-Trustee; and: Notice to the Agent is Notice to the Principal; Notice to the Principal is Notice to the Agent. :i -man Wish for the Remedy of this Right-executed.

:William-P: United States Attorney General Barr
Alien Property Custodian
U.S. Department of Justice
950 Pennsylvania Avenue, NW
Washington, District of Columbia 20530-001

USPS RMN: RE 322 404 084 US

William-P, Greetings:

A) Affiant is:

- (1) **man: Darrell-James: Hill** -- :Ohioan: known by the given-name: Darrell-James: (of the family) Hill, :birth: Ohio state: © November 20th, 1958¹;
- (2) **beneficiary (a)** of the right of the man by the Almighty-God, where nothing stands between :i and the Almighty-God;
- (3) **beneficiary (b)** of The United States of America Constitutional Republic, et seq. and thereto of the subsequent Emergency Banking Act- 1933² UNITED STATES Trust Fund ~ administered by the UNITED-STATES- government- Trustee ~ by the way of the idem sonans- subrogation titled: DARRELL JAMES HILL, : berth: State of Ohio: @ November 28th, 1958³;
- (4) **Authorized Representative, A.R., is: Darrell-James: Hill, A.R.** :i- man- sui juris am: appointed :Authorized Representative by the beneficiary- sui juris, now Executor in all of the matters of the cestui que vie: Darrell-James: Hill; and: as relates to:
 1. **Emergency Banking Act- 1933 and the: Trading with the Enemy Act- 1917⁴, TWEA, sec. 5(b) amended, 1933**, the :UNITED-STATES-government Executive Orders and Congressional Acts implemented within the Emergency Banking Act of 1933 with the TWEA, sec. 5(b) amendment, et seq. then, established the emergency trustee relationship for the people of the inherent-right of The United States of America with the UNITED- STATES- government Trustee taking title-ownership and usufruct of the collateral~ of the people's property, with the people retaining/holding the right of the equitable- cestui que use- interest. Furthermore, as relates to:
 2. **The Enemy-Presumption imposed onto :i -man -beneficiary by the TWEA, sec. 5(b) as amended 1933**, the term: enemy is defined by the TWEA, sec. 5(b) amended 1933, as any person(s) as :determined by the President of the UNITED STATES. ~ And: thereto, no equity distribution to any UNITED STATES Trust Fund beneficiary-presumed-to-be-the-enemy is legal by the UNITED STATES government Trustee, et al.~ Alien Property

- 1 Darrell-James: Hill, © 1958 means: the year of the birth of the man-child: Darrell-James: Hill. See: evidence: Authenticated Certificate of Birth – appended: 3 pages.
- 2 Emergency Bank Act of 1933 means: 48 Stat. 1.
- 3 DARRELL JAMES HILL @ 1958 means: the year of the berth of the subrogation for the man- child.
- 4 Trading With The Enemy Act - 1917 means: 40 Stat. 411.

Darrell-James: Hill :June 2019 :USPS RMN: RE 322 404 084 US

1 / 2

2022-011769 MISC Page: 1119 of 2782
09/26/2022 03:35:37 PM Receipt #: 22-9381
Rec Fee: \$30.00 Darrell James Hill
Gila County, Az, Sadie Jo Bingham, Recorder



:Darrell-James: Hill c/o PO Box 3806, Apache Junction, Arizona, 85117:

Custodian⁵ unless and until the not- an- enemy- combatant⁶, not- a- belligerent, or not- an- ally-of-enemy is declared by the individual person- beneficiary: Darrell-James: Hill.

(B) :Notice: Remedy is Required by the Law: For that :i -man -beneficiary- :Darrell-James: Hill from the 1958 A.D. birth-unto-now: June~2019 am a Civilian and not a :combatant, belligerent, or ally-of-enemy of The United States of America Constitutional Republic, :i- man- beneficiary wish by the execution of this document for the remedy:

(a) non-discriminatory civilian status for the man- beneficiary :Darrell-James: Hill described herein and/or accounted for with the subrogation: DARRELL JAMES HILL, et al. derivative names;

(b) now, ascertained unrestricted transference to :i -man of the (b.i.) equitable benefit(s) and (b.ii.) other possessions, due, past due and/or otherwise held or owed to :i -man- beneficiary from now upon the delivery of this notice; and, that:

(c) all of the actors of the UNITED-STATES-Government-Trustee must now-to-fore administer to protect and ensure these :all-right(s)-executed.

(C) :Presumption is now set. :i- man- beneficiary :Darrell-James: Hill described herein and/or accounted-for with the subrogation: DARRELL JAMES HILL~ et al. derivative names, upon the receipt of this notice is then-after settled and agreed: civilian with regard to the Trading with the Enemy Act- 1917⁷, TWEA, sec. 5(b) as amended within the Emergency Banking Act- 1933.

cc: Donald: United States President Trump

:i- man verify that all stated herein is true and correct and will state same onto the record in the open court.

Thank you;
Without prejudice
DARRELL JAMES HILL

Darrell - James: Hill, A.R.
:Darrell-James: Hill, :man, :Executo

IURAT

Sworn to and subscribed before me now on this 26th day: June: 2019.
Produced identification: type: Arizona Driver License.

E.A.
Notary



5 Alien Property Custodian means: I) person assigned by the President of the UNITED STATES for to manage the responsibilities of the custody of the alien property as relates to the Emergency Banking Act-of 1933, et seq., and now is: William-P.: United States Attorney General Barr as late as: June 26th, 2019 A.D. See: Reorg. Plan No. 1 of 1947, §101, eff. July 1, 1947, 12 F.R. 4534, 61 Stat. 951.

6 Combatant means: a soldier engaged within or about an occupation against an enemy combatant.

7 Trading With The Enemy Act - 1917 means: 40 Stat. 411.



United States of America



DEPARTMENT OF STATE

To all to whom these presents shall come, Greetings:

I Certify That the document hereunto annexed is under the Seal of the Secretary of State of the State(s) of Ohio, and that such Seal(s) is/are entitled to full faith and credit.*

**For the contents of the annexed document, the Department assumes no responsibility
This certificate is not valid if it is removed or altered in any way whatsoever*

In testimony whereof, I, Michael R. Pompeo, Secretary of State, have hereunto caused the seal of the Department of State to be affixed and my name subscribed by the Assistant Authentication Officer, of the said Department, at the city of Washington, in the District of Columbia, this seventeenth day of July, 2018.

Michael R. Pompeo

Secretary of State

By *Pat O. Kuntz*

Assistant Authentication Officer

Issued pursuant to CHXIV, State of Sept. 15, 1789. 1 Stat. 68-69; 22 USC 2657; 22 USC 2651a; 5 USC 301; 28 USC 1733 et. seq.; 8 USC 1443(f); RULE 44 Federal Rules of Civil Procedure.

1118

2022-011769 MISC Page: 1121 of 2782
09/26/2022 03:35:37 PM Receipt #: 22-9381
Rec Fee: \$30.00 Darrell James Hill
Gila County, Az, Sadie Jo Bingham, Recorder



For: Demonstration Purposes Only;
Day: June 26, 2019
Autograph: Darrell James Hill



Unofficial Copy

1119

2022-011769 MISC Page: 1122 of 2782
09/26/2022 03:35:37 PM Receipt #: 22-9381
Rec Fee: \$30.00 Darrell James Hill
Gila County, Az, Sadie Jo Bingham, Recorder



United States of America
State of Ohio
Office of the Secretary of State

I, **JON HUSTED**, Secretary of State, do hereby certify that I am the duly elected, qualified and acting Secretary of State of the State of Ohio, and I further certify that **JUDITH B. NAGY**

is the duly appointed, State Registrar, Vital Statistics Division, Department of Health, for the State of Ohio. She is the custodian of the records of Vital Statistics, and that she is the proper official to make said attestation, which is in due form; and that her official acts are entitled to full faith and credit.

This certification certifies only the authenticity of the signature of the official who signed the document, the capacity in which that official acted, and where appropriate, the identity of the seal or stamp, which the document bears. This certification does not imply that the contents of the document(s) are correct, nor that they have the approval of this office.

IN TESTIMONY WHEREOF, I have hereunto subscribed my name and affixed the official Seal of the Secretary of State of Ohio, at Columbus, Ohio, this 14th day of June, 2018.

Jon Husted
Jon Husted
Secretary of State

SEC4000 (Rev. 1/11)

1120

2022-011769 MISC Page: 1123 of 2782
09/26/2022 03:35:37 PM Receipt #: 22-9381
Rec Fee: \$30.00 Darrell James Hill
Gila County, Az, Sadie Jo Bingham, Recorder



**For: Demonstration Purposes Only;
Day: June 26, 2019
Autograph: Darrell James Hill**



Unofficial Copy

1121

2022-011769 MISC Page: 1124 of 2782
09/26/2022 03:35:37 PM Receipt #: 22-9381
Rec Fee: \$30.00 Darrell James Hill
Gila County, Az, Sadie Jo Bingham, Recorder



OHIO DEPARTMENT OF HEALTH
DIVISION OF VITAL STATISTICS
CERTIFICATE OF LIVE BIRTH

REG. NO. 7701
Primary Reg. Dist. No. 7701

PLACE OF BIRTH
COUNTY: Summit

USUAL RESIDENCE OF MOTHER
STATE: Ohio COUNTY: Summit

CITY, VILLAGE, OR LOCATION: Akron

STREET ADDRESS: 219 King Ct.

NAME OF HOSPITAL OR INSTITUTION: Akron City Hospital

IS RESIDENCE INSIDE CITY LIMITS? YES NO

NAME (Type in full): Darrell James Hill

SEX: Male Female

DATE OF BIRTH: May 20 1958

AGE AT TIME OF BIRTH: 35 YEARS

BIRTHPLACE (State or foreign country): Ohio

USUAL OCCUPATION: Carpenter

MAIDEN NAME: Ora Lee Archer

PREVIOUS DELIVERIES TO MOTHER (If any, state date, name of child, sex, and weight): none

INFORMANT'S NAME OR SIGNATURE: Ora Hill

MOTHER'S MAILING ADDRESS: none

DATE NEUROLOGIC TEST FOR SYRILIS: May 58

ATTENDANT AT BIRTH: M.D. MIDWIFE OTHER

DATE SIGNED: May 58

DATE RECD. BY LOCAL REG.: 10-23-58

REGISTRAR'S SIGNATURE: Judith B. Nagy

DATE ON WHICH GIVEN NAME ADDED: none

MARGIN RESERVED FOR BINDING

Judith B. Nagy
State Registrar

MAY - 9 2018

Judith B. Nagy

2022-011769 MISC Page: 1125 of 2782
09/26/2022 03:35:37 PM Receipt #: 22-9381
Rec Fee: \$30.00 Darrell James Hill
Gila County, Az. Sadie Jo Bingham, Recorder



HEREBY CERTIFY THIS DOCUMENT IS AN EXACT COPY OF T

1177

For: Demonstration Purposes Only:
Day: June 26, 2019
Autograph: Darrell James Hill



1123

2022-011769 MISC Page: 1126 of 2782
09/26/2022 03:35:37 PM Receipt #: 22-9381
Rec Fee: \$30.00 Darrell James Hill
Gila County, Az, Sadie Jo Bingham, Recorder



:Darrell-James: Hill, Beverly-Jean: Romero- Hill c/o PO Box 3806, Apache Junction, Arizona, 85117

:Donald: United States President Trump
1600 Pennsylvania Avenue NW
Washington, District of Columbia 20500

USPS RMN: RE 322 404 098 US

Re: Alien Property Custodian Notices: Agreement :Civilian Status

:Donald, Greetings:

We pray for you Donald. - Be Blessed into the will of the Almighty God be done ~Amen.

This :contact is about the Alien-Property-Custodian- duties by the man- William-P: United States Attorney General Barr; last appointed by the 1933- President- Roosevelt concerning the matter(s) of the alienated-property of any presumed enemy by the Emergency Banking Act of 1933 ~Trading With the Enemy Act (amended: 1933). The act, et seq. set a legal- presumption- of- an- enemy status upon all people of The United States of America implemented today by the means of a subrogation assigned each man-child on or about our birthp. And, until stated as otherwise, ... -

Appended hereto are the Notices* sent to :William-P: Barr~ Alien-Property-Custodian -on your- appointment, the :man to serve as the United States Attorney General - 5 pages for the each: (a) husband: Darrell-James: Hill, and (b) wife: Beverly-Jean: Romero- Hill.

* **Notice to the UNITED STATES Government Trustee~ Alien Property Custodian c/o: William-P: United States Attorney General Barr, that:**

i -man -beneficiary :(a)/(b) from the birth-unto-now am a Civilian, not a :combatant, belligerent, or ally-of-enemy of The United States of America Constitutional Republic nor with the UNITED STATES government services provider- Trustee; and: Notice to the Agent is Notice to the Principal; Notice to the Principal is Notice to the Agent. :i -man Wish for the Remedy of this Right-executed.

In the accordance with the Law and laws of the contract, it is our option to execute on the right of the citizen status for the normalized man-beneficiary -U.S. government-trustee relations established by the Emergency Banking Act of 1933. :Notice for the Remedy to the legal- enemy- presumption of the Emergency Banking Act of 1933 is necessary by the legislative Act under the Law:

:Presumption is now set. Regarding the beneficiary :Darrell-James: Hill ~husband and: Beverly-Jean: Romero- Hill~wife described in the corresponding notices, including the: et al. derivative names, respectfully, it is settled and agreed upon the receipt of this document: civilians with regard to the Trading with the Enemy Act- 1917, TWEA, sec. 5(b) as amended within the Emergency Banking Act- 1933.

Appended: Husband and Wife Notices

Sincerely, Thank you;

Without prejudice, DARRELL JAMES HILL

Darrell James Hill AR
:Darrell-James: Hill, :man, :i

Without prejudice, BEVERLY JEAN ROMERO- HILL

Beverly Jean Romero Hill AR
:Beverly-Jean: Romero- Hill, :man, :i

JURAT

Sworn to and subscribed before me now on this 27th day: June: 2019.
Produced identification: type: Arizona Driver License.

Dominic Stewart
Notary

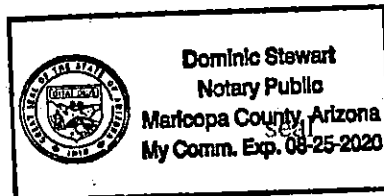

1 Trading With The Enemy Act - 1917 means: 40 Stat. 411.

Darrell-James: Hill :June 2019 :US

2022-011769 MISC Page: 1127 of 2782

09/26/2022 03:35:37 PM Receipt #: 22-9381
Rec Fee: \$30.00 Darrell James Hill
Gila County, Az, Sadie Jo Bingham, Recorder



1124

:Darrell-James: Hill c/o PO Box 3806, Apache Junction, Arizona, 85117:

Arizona state
Pinal county

:Man :Darrell- James: Hill personally presents before me, the undersigned Notary duly authorized by the laws of Arizona to administer oaths; now on this 26th day: June: 2019, being by me first duly sworn, on his affirmation, claimant deposes and says:

Notice to the UNITED STATES Government Trustee~ Alien Property Custodian c/o: William-P.: United States Attorney General Barr, that: i -man -beneficiary :Darrell-James: Hill from the birth-unto-now am a Civilian, not a :combatant, belligerent, or ally-of-enemy of The United States of America Constitutional Republic nor with the UNITED STATES government services provider-Trustee; and: Notice to the Agent is Notice to the Principal; Notice to the Principal is Notice to the Agent. :I -man Wish for the Remedy of this Right-executed.

:William-P.: United States Attorney General Barr
Alien Property Custodian
U.S. Department of Justice
950 Pennsylvania Avenue, NW
Washington, District of Columbia 20530-001

USPS RMN: RE 322 404 084 US

William-P., Greetings:

A) Affiant is:

- (1) **man: Darrell-James: Hill - :Ohioan: known by the given-name: Darrell-James: (of the family) Hill, :birth: Ohio state: © November 20th, 1958¹;**
- (2) **beneficiary (a) of the right of the man by the Almighty-God, where nothing stands between :i and the Almighty-God;**
- (3) **beneficiary (b) of The United States of America Constitutional Republic, et seq. and thereto of the subsequent Emergency Banking Act- 1933² UNITED STATES Trust Fund ~ administered by the UNITED-STATES- government- Trustee ~ by the way of the idem sonans- subrogation titled: DARRELL JAMES HILL, : berth: State of Ohio: @ November 28th, 1958³;**
- (4) **Authorized Representative, A.R., is: Darrell-James: Hill, A.R. :i- man- sui juris am: appointed :Authorized Representative by the beneficiary- sui juris, now Executor in all of the matters of the cestui que vie: Darrell-James: Hill; and: as relates to:**
 1. **Emergency Banking Act- 1933 and the: Trading with the Enemy Act- 1917⁴, TWEA, sec. 5(b) amended, 1933, the :UNITED-STATES-government Executive Orders and Congressional Acts implemented within the Emergency Banking Act of 1933 with the TWEA, sec. 5(b) amendment, et seq. then, established the emergency trustee relationship for the people of the inherent-right of The United States of America with the UNITED- STATES- government Trustee taking title-ownership and usufruct of the collateral~ of the people's property, with the people retaining/holding the right of the equitable- cestui que use- interest. Furthermore, as relates to:**
 2. **The Enemy-Presumption imposed onto :i -man -beneficiary by the TWEA, sec. 5(b) as amended 1933, the term: enemy is defined by the TWEA, sec. 5(b) amended 1933, as any person(s) as :determined by the President of the UNITED STATES. - And: thereto, no equity distribution to any UNITED STATES Trust Fund beneficiary-presumed-to-be-the-enemy is legal by the UNITED STATES government Trustee, et al.~ Alien Property**

- 1 Darrell-James: Hill, © 1958 means: the year of the birth of the man-child: Darrell-James: Hill. See: evidence: Authenticated Certificate of Birth – appended: 3 pages.
- 2 Emergency Bank Act of 1933 means: 48 Stat. 1.
- 3 DARRELL JAMES HILL © 1958 means: the year of the berth of the subrogation for the man- child.
- 4 Trading With The Enemy Act - 1917 means: 40 Stat. 411.

Darrell-James: Hill :June 2019 :USPS RMN: RE 322 404 084 US

1 / 2

1125

2022-011769 MISC Page: 1128 of 2782
09/26/2022 03:35:37 PM Receipt #: 22-9381
Rec Fee: \$30.00 Darrell James Hill
Gila County, Az, Sadie Jo Bingham, Recorder

:Darrell-James: Hill c/o PO Box 3806, Apache Junction, Arizona, 85117:

Custodian⁵ unless and until the not- an- enemy- combatant⁶, not- a- belligerent, or not- ally-of-enemy is declared by the individual person- beneficiary: Darrell-James: Hill.

(B) :Notice: Remedy is Required by the Law: For that :i- man -beneficiary- :Darrell-James: Hill from the 1958 A.D. birth-unto-now: June~2019 am a Civilian and not a :combatant, belligerent, or ally-of-enemy of The United States of America Constitutional Republic, :i- man- beneficiary wish by the execution of this document for the remedy:

(a) non-discriminatory civilian status for the man- beneficiary :Darrell-James: Hill described herein and/or accounted for with the subrogation: DARRELL JAMES HILL, et al. derivative names;

(b) now, ascertained unrestricted transference to :i- man of the (b.i.) equitable benefit(s) and (b.ii.) other possessions, due, past due and/or otherwise held or owed to :i- man- beneficiary from now upon the delivery of this notice; and, that:

(c) all of the actors of the UNITED-STATES-Government-Trustee must now-to-fore administer to protect and ensure these :all-right(s)-executed.

(C) :Presumption is now set. :i- man- beneficiary :Darrell-James: Hill described herein and/or accounted-for with the subrogation: DARRELL JAMES HILL, et al. derivative names, upon the receipt of this notice is then-after settled and agreed: civilian with regard to the Trading with the Enemy Act- 1917⁷, TWEA, sec. 5(b) as amended within the Emergency Banking Act- 1933.

cc: Donald: United States President Trump

:i- man verify that all stated herein is true and correct and will state same onto the record in the open court.

Thank you;
Without prejudice
DARRELL JAMES HILL

Darrell-James: Hill, A.R.
:Darrell-James: Hill, :man, :Executor



JURAT

Sworn to and subscribed before me now on this 26th day: June: 2019.
Produced identification: type: Arizona Driver License.

E.A.
Notary



5 Alien Property Custodian means: I) person assigned by the President of the UNITED STATES for to manage the responsibilities of the custody of the alien property as relates to the Emergency Banking Act-of 1933, et seq., and now is: William-P.: United States Attorney General Barr as late as: June 26th, 2019 A.D. See: Reorg. Plan No. 1 of 1947, §101, eff. July 1, 1947, 12 F.R. 4534, 61 Stat. 951.
6 Combatant means: a soldier engaged within or about an occupation against an enemy combatant.
7 Trading With The Enemy Act - 1917 means: 40 Stat. 411.

1126



United States of America



DEPARTMENT OF STATE

To all to whom these presents shall come, Greetings:

I Certify That the document hereunto annexed is under the Seal of the Secretary of State of the State(s) of Ohio, and that such Seal(s) is/are entitled to full faith and credit.*

****For the contents of the annexed document, the Department assumes no responsibility
This certificate is not valid if it is removed or altered in any way whatsoever***

In testimony whereof, I, Michael R. Pompeo, Secretary of State, have hereunto caused the seal of the Department of State to be affixed and my name subscribed by the Assistant Authentication Officer, of the said Department, at the city of Washington, in the District of Columbia, this seventeenth day of July, 2018.

Michael R. Pompeo Secretary of State
By [Signature] Assistant Authentication Officer

Issued pursuant to CHXIV, State of
Sept. 15, 1789, 1 Stat. 68-69; 22
USC 2657; 22USC 2651a; 5 USC
301; 28 USC 1733 et. seq.; 8 USC
1443(f); RULE 44 Federal Rules of
Civil Procedure.

1127

2022-011769 MISC Page: 1130 of 2782
09/26/2022 03:35:37 PM Receipt #: 22-9381
Rec Fee: \$30.00 Darrell James Hill
Gila County, Az, Sadie Jo Bingham, Recorder



For: Demonstration Purposes Only;
Day: June 26, 2019
Autograph: *Darrell James Hill*



Unofficial Copy

1128

2022-011769 MISC Page: 1131 of 2782
09/26/2022 03:35:37 PM Receipt #: 22-9381
Rec Fee: \$30.00 Darrell James Hill
Gila County, Az, Sadie Jo Bingham, Recorder



United States of America
State of Ohio
Office of the Secretary of State

I, **JON HUSTED**, Secretary of State, do hereby certify that I am the duly elected, qualified and acting Secretary of State of the State of Ohio, and I further certify that **JUDITH B. NAGY**

is the duly appointed, State Registrar, Vital Statistics Division, Department of Health, for the State of Ohio. She is the custodian of the records of Vital Statistics, and that she is the proper official to make said attestation, which is in due form; and that her official acts are entitled to full faith and credit.

This certification certifies only the authenticity of the signature of the official who signed the document, the capacity in which that official acted, and where appropriate, the identity of the seal or stamp, which the document bears. This certification does not imply that the contents of the document(s) are correct, nor that they have the approval of this office.

IN TESTIMONY WHEREOF, I have hereunto subscribed my name and affixed the official Seal of the Secretary of State of Ohio, at Columbus, Ohio, this 14th day of June, 2018.

Jon Husted
Secretary of State

SEC4000 (Rev. 1/11)

1129

2022-011769 MISC Page: 1132 of 2782
09/26/2022 03:35:37 PM Receipt #: 22-9381
Rec Fee: \$30.00 Darrell James Hill
Gila County, Az, Sadie Jo Bingham, Recorder



For: Demonstration Purposes Only;
Day: June 26, 2019
Autograph: Darrell James Hill



1130

2022-011769 MISC Page: 1133 of 2782
09/26/2022 03:35:37 PM Receipt #: 22-9381
Rec Fee: \$30.00 Darrell James Hill
Gila County, Az, Sadie Jo Bingham, Recorder



OHIO DEPARTMENT OF HEALTH
DIVISION OF VITAL STATISTICS
CERTIFICATE OF LIVE BIRTH

Form No. 7701
Date of Birth: 11-28-58

PLACE OF BIRTH: County: Summit
CITY, VILLAGE, OR LOCATION: Akron

USUAL RESIDENCE OF MOTHER: STATE: Ohio, COUNTY: Summit
CITY, VILLAGE, OR LOCATION: Akron

NAME OF HOSPITAL OR INSTITUTION: Akron City Hospital
STREET ADDRESS: 219 King Cr.

IS PLACE OF BIRTH (INSIDE CITY LIMITS)? YES NO
IS RESIDENCE (INSIDE CITY LIMITS)? YES NO

NAME OF CHILD: Darrell James Hill
SEX: M SINGLE TWIN TRIPLET IS TWIN OR TRIPLET WAS CHILD BORN: NO YES
DATE OF BIRTH: NOV 28 1958

NAME OF MOTHER: Clarence Hill
AGE (AT TIME OF THIS BIRTH): 35 YEARS
BIRTHPLACE (STATE OR FOREIGN COUNTRY): Va.
USUAL OCCUPATION: Carpenter
KIND OR QUALITY OF INDUSTRY: Contractor

MAIDEN NAME: Ora Lee Archer
AGE (AT TIME OF THIS BIRTH): 30 YEARS
BIRTHPLACE (STATE OR FOREIGN COUNTRY): Va.
PREVIOUS DELIVERIES TO MOTHER (IF NOT MARRIED WITH FATHER): 3 (how many live children are now living?) none (how many still alive in 1958?) none

INFORMANT'S NAME OR SIGNATURE: Ora Hill
MOTHER'S MAILING ADDRESS: 3 non-
DATE SEROLOGIC TEST FOR SYPHILIS: May 58
ATTENDANT AT BIRTH: M.D. D.O. MIDWIFE OTHER (specify):

I hereby certify that this child was born alive on the date: *[Signature]*
ADDRESS: *[Signature]*
DATE RECD. BY LOCAL REG: 11-28-58
REGISTRAR'S SIGNATURE: *[Signature]*
DATE ON WHICH GIVEN NAME ADDED: *[Signature]*

FOR MEDICAL AND HEALTH USE ONLY

Judith B. Nagy
State Registrar

MAY - 9 2018

[Signature]

2022-011769 MISC Page: 1134 of 2782
09/26/2022 03:35:37 PM Receipt #: 22-9381
Rec Fee: \$30.00 Darrell James Hill
Gila County, Az. Sadie Jo Bingham, Recorder



HEREBY CERTIFY THIS DOCUMENT IS AN EXACT COPY OF THE ORIGINAL
11 21

For: Demonstration Purposes Only:
Day: June 26, 2019
Autograph: Darrell James Hill



1132

2022-011769 MISC Page: 1135 of 2782
09/26/2022 03:35:37 PM Receipt #: 22-9381
Rec Fee: \$30.00 Darrell James Hill
Gila County, Az, Sadie Jo Bingham, Recorder



Registered No.

RE322404084US

Date Stamp

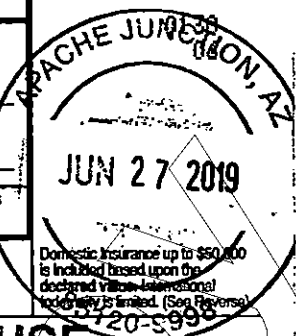

APACHE JUNCTION
151 W SUPERSTITION BLVD
APACHE JUNCTION, AZ
85120-9998
0302590130

06/27/2019 (800)275-8777 2:49 PM

To Be Completed By Post Office	Postage \$	\$0.85	Extra Services & Fees (continued)
	Extra Services & Fees		<input type="checkbox"/> Signature Confirmation
	<input type="checkbox"/> Registered Mail \$	\$12.95	<input type="checkbox"/> Signature Confirmation Restricted Delivery
	<input type="checkbox"/> Return Receipt (hardcopy) \$	\$2.80	<input type="checkbox"/> Signature Confirmation Restricted Delivery
	<input type="checkbox"/> Return Receipt (electronic) \$	\$0.00	<input type="checkbox"/> Signature Confirmation Restricted Delivery
	<input type="checkbox"/> Restricted Delivery \$	\$0.00	Total Postage & Fees \$
			\$16.75
Customer Must Declare Full Value		\$50.00	Received by
			06/27/2019

Domestic insurance up to \$50.00 is included based upon the declared value. International indemnity is limited. (See Reverse)

OFFICIAL USE

To Be Completed By Customer (Please Print) All Entries Must Be In Ballpoint or Typed	FROM	APACHE JUNCTION, AZ 85120
		Darrell-James Hill Beverly-Jean Romero-Hill PO Box 3806 Apache Junction, Arizona 85117
	TO	WASHINGTON, DC 20530
		William E. United States Attorney General Barr 950 Pennsylvania Avenue, NW Washington, District of Columbia 20530-001

PS Form 3806, Registered Mail Receipt April 2015

Copy 1 - Customer (See Information on Reverse)

Product Description	Sale Qty	Final Price
First-Class Mail Letter (Domestic) (WASHINGTON, DC 20500) (Weight: 0 Lb 2.60 Oz) (Estimated Delivery Date) (Monday 07/01/2019)	1	\$0.85
Registered (Amount: \$50.00) (USPS Registered Mail #) (RE322404098US)	1	\$12.95
Return Receipt (USPS Return Receipt #) (9590940247428344639875)	1	\$2.80
Non Mach. Surch.	1	\$0.15
First-Class Mail Letter (Domestic) (WASHINGTON, DC 20530) (Weight: 0 Lb 2.60 Oz) (Estimated Delivery Date) (Monday 07/01/2019)	1	\$0.85
Registered (Amount: \$50.00) (USPS Registered Mail #) (RE322404084US)	1	\$12.95
Return Receipt (USPS Return Receipt #) (9590940242158121976378)	1	\$2.80
Non Mach. Surch.	1	\$0.15
Total		\$33.50
Cash Change		\$40.00 (\$6.50)

Registered No.

RE322404098US



To Be Completed By Post Office	Postage \$	\$0.85	Extra Services & Fees (continued)
	Extra Services & Fees		<input type="checkbox"/> Signature Confirmation
	<input type="checkbox"/> Registered Mail \$	\$12.95	<input type="checkbox"/> Signature Confirmation Restricted Delivery
	<input type="checkbox"/> Return Receipt (hardcopy) \$	\$2.80	<input type="checkbox"/> Signature Confirmation Restricted Delivery
	<input type="checkbox"/> Return Receipt (electronic) \$	\$0.00	<input type="checkbox"/> Signature Confirmation Restricted Delivery
	<input type="checkbox"/> Restricted Delivery \$	\$0.00	Total Postage & Fees \$
			\$16.75
Customer Must Declare Full Value		\$50.00	Received by
			06/27/2019

Domestic insurance up to \$50.00 is included based upon the declared value. International indemnity is limited. (See Reverse)

OFFICIAL USE

To Be Completed By Customer (Please Print) All Entries Must Be In Ballpoint or Typed	FROM	APACHE JUNCTION, AZ 85120
		Darrell-James Hill Beverly-Jean Romero-Hill PO Box 3806 Apache Junction, Arizona 85117
	TO	WASHINGTON, DC 20500
		William E. United States Attorney General Barr 950 Pennsylvania Avenue, NW Washington, DC 20500

PS Form 3806, Registered Mail Receipt April 2015

Copy 1 - Customer (See Information on Reverse)

Due to the security of Registered Mail, an additional 3-10 delivery days should be added to the expected

1133



SENDER: COMPLETE THIS SECTION

- Complete items 1, 2, and 3.
- Print your name and address on the reverse so that we can return the card to you.
- Attach this card to the back of the mailpiece or on the front if space permits.

1. Article Addressed to:

William F. United States Attorney General Barr
 Asset Property Custodian
 950 Pennsylvania Avenue, NW
 Washington, District of Columbia 20530-001



9590 9402 4215 8121 9763 78

2. Article Number (Transfer from service label)

RE 322 404 084 US

PS Form 3811, July 2015 PSN 7530-02-000-9053

COMPLETE THIS SECTION ON DELIVERY

A. Signature

X

Agent

Addressee

B. Received by (Print Name)

C. Date of Delivery

D. Is delivery address different from item 1? Yes

If YES, enter delivery address below: No

3. Service Type

Adult Signature

Adult Signature Restricted Delivery

Certified Mail®

Certified Mail Restricted Delivery

Collect on Delivery

Collect on Delivery Restricted Delivery

Insured Mail

Insured Mail Restricted Delivery (over \$500)

Priority Mail Express®

Registered Mail™

Registered Mail Restricted Delivery

Return Receipt for Merchandise

Signature Confirmation™

Signature Confirmation Restricted Delivery

SENDER: COMPLETE THIS SECTION

- Complete items 1, 2, and 3.
- Print your name and address on the reverse so that we can return the card to you.
- Attach this card to the back of the mailpiece or on the front if space permits.

1. Article Addressed to:

Donald Trump United States President Trump
 1600 Pennsylvania Avenue NW
 Washington, DC 20510



9590 9402 4742 8344 6398 75

2. Article Number (Transfer from service label)

RE 322 404 098 US

PS Form 3811, July 2015 PSN 7530-02-000-9053

COMPLETE THIS SECTION ON DELIVERY

A. Signature

X

Agent

Addressee

B. Received by (Printed Name)

C. Date of Delivery

D. Is delivery address different from item 1? Yes

If YES, enter delivery address below: No

3. Service Type

Adult Signature

Adult Signature Restricted Delivery

Certified Mail®

Certified Mail Restricted Delivery

Collect on Delivery

Collect on Delivery Restricted Delivery

Insured Mail

Insured Mail Restricted Delivery (over \$500)

Priority Mail Express®

Registered Mail™

Registered Mail Restricted Delivery

Return Receipt for Merchandise

Signature Confirmation™

Signature Confirmation Restricted Delivery

Domestic Return Receipt



1134



Notice of Claim: USPS RMN~ RE 322 404 075 US:
Verification of the Known Birth/Berth Statuses: man: Beverly-Jean: Romero-Hill

Arizona state
Pinal County

:Man :Beverly-Jean: Romero- Hill personally presents before me, the undersigned Notary duly authorized by the laws of Arizona to administer oaths; now on this 7th day: June: 2019, being by me first duly sworn on his affirmation, claimant deposes and says:

:i- man of the family Romero am a) :Beverly-Jean (given-name)-beneficiary, and :owner of the property (a) :inherent-trust by the Almighty-God and (b): beneficiary -subrogee -in the idem sonans- trust by the subrogor: UNITED-STATES-government- Trustee as established and presented within the riveted- certified- instrument ~Not-altered-authentication~ attached (3 pages): p. 1/3 (at the bottom): certified- document: CERTIFICATE OF BIRTH-STATE OF NEW MEXICO -File No. 19581503459, :document No. 2254494; and: p. 2/3 :certification~ of- authenticity by the State of New Mexico ~ (emblem)~ OFFICE OF THE SECRETARY OF STATE – CERTIFICATE regarding the NO: 19581503459; and: p. 3/3: with the 18053840-2~ United States of America~ [emblem]~ DEPARTMENT OF STATE.

Claim

:i -man am :Beverly-Jean: Romero- Hill, by the known presents: 1958~A.D- June~15th -New Mexican-birth of :i ~wherefrom and throughout the eternity nothing exists between :i -man and Almighty God~, and by the known-presents that after the : 1958-June~15th -New Mexican- berth in the idem~sonans is the subrogation: BEVERLY JEAN ROMERO. – And :i- man am :soul-beneficiary :sui juris :Authorized Representative/~Executor of (A) the inherent trust by Almighty-God and (B) of the subrogation- trust by the UNITED STATES government-services-Trustee as established and presented by the within- riveted- certified- instrument;

:i- man verify that all stated herein is true and correct; and: i- man will state same onto the record in the open court.

Without prejudice:

Autographed this 7th day June 2019 A.D.

: Beverly-Jean: Romero-Hill
:Beverly-Jean: Romero- Hill, :beneficiary, :Execu



JURAT

Sworn to and subscribed before me now on this 7th day: June: 2019.
Produced identification: type: Arizona Driver License.

Dominic Stewart

Notary

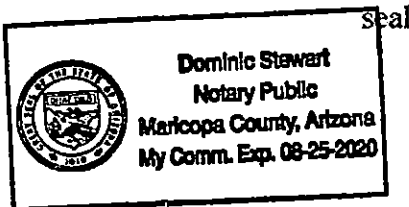

1135

United States of America



DEPARTMENT OF STATE

To all to whom these presents shall come, Greetings:

I Certify That the document hereunto annexed is under the Seal of the State(s) of New Mexico, and that such Seal(s) is/are entitled to full faith and credit.*

**For the contents of the annexed document, the Department assumes no responsibility
This certificate is not valid if it is removed or altered in any way whatsoever*

In testimony whereof, I, Michael R. Pompeo, Secretary of State, have hereunto caused the seal of the Department of State to be affixed and my name subscribed by the Assistant Authentication Officer, of the said Department, at the city of Washington, in the District of Columbia, this fifteenth day of August, 2018.

Secretary of State

By 
Assistant Authentication Officer

Issued pursuant to CHXIV, State of
Sept. 15, 1789, 1 Stat. 68-69; 22
USC 2657; 22USC 2651a; 5 USC
301; 28 USC 1733 et. seq.; 8 USC
1443(); RULE 44 Federal Rules of
Civil Procedure.

1136

2022-011769 MISC Page: 1139 of 2782
09/26/2022 03:35:37 PM Receipt #: 22-9381
Rec Fee: \$30.00 Darrell James Hill
Gila County, Az, Sadie Jo Bingham, Recorder



For: Demonstration Purposes Only:
Day: June 11, 2019
Autograph: *Beverly Jean Romo*



2022-011769 MISC Page: 1140 of 2782
09/26/2022 03:35:37 PM Receipt #: 22-9381
Rec Fee: \$30.00 Darrell James Hill
Gila County, Az, Sadie Jo Bingham, Recorder



1137

STATE OF NEW MEXICO



OFFICE OF THE
SECRETARY OF STATE
CERTIFICATE

I, MAGGIE TOULOUSE OLIVER, SECRETARY OF STATE FOR NEW MEXICO, DO
HEREBY CERTIFY

THAT

DONNA DOSSEY was the State Registrar VITAL STATISTICS, OFFICE OF VITAL RECORDS
AND HEALTH STATISTICS, PUBLIC HEALTH DIVISION, DEPARTMENT OF HEALTH for the
state of New Mexico on the date of execution shown on the Birth Certificate for BEVERY JEAN
ROMERO CERTIFICATE NO: (19581504459) and appointed to the office with full authority to exercise
the duties and responsibilities of State Registrar and legally entrusted with the possession and custody of
the records and files thereof.



GIVEN UNDER MY HAND AND THE
GREAT SEAL OF THE STATE OF
NEW MEXICO, IN THE CITY OF
SANTA FE, THE CAPITAL, ON THIS
16TH DAY OF JULY, 2018 A.D.

Maggie Toulouse Oliver

SECRETARY OF STATE

1138



For: Demonstration Purposes Only;
Day: June 11, 2019
Autograph: *Revelyn Jan Romo*



1139

2022-011769 MISC Page: 1142 of 2782
09/26/2022 03:35:37 PM Receipt #: 22-9381
Rec Fee: \$30.00 Darrell James Hill
Gila County, Az, Sadie Jo Bingham, Recorder



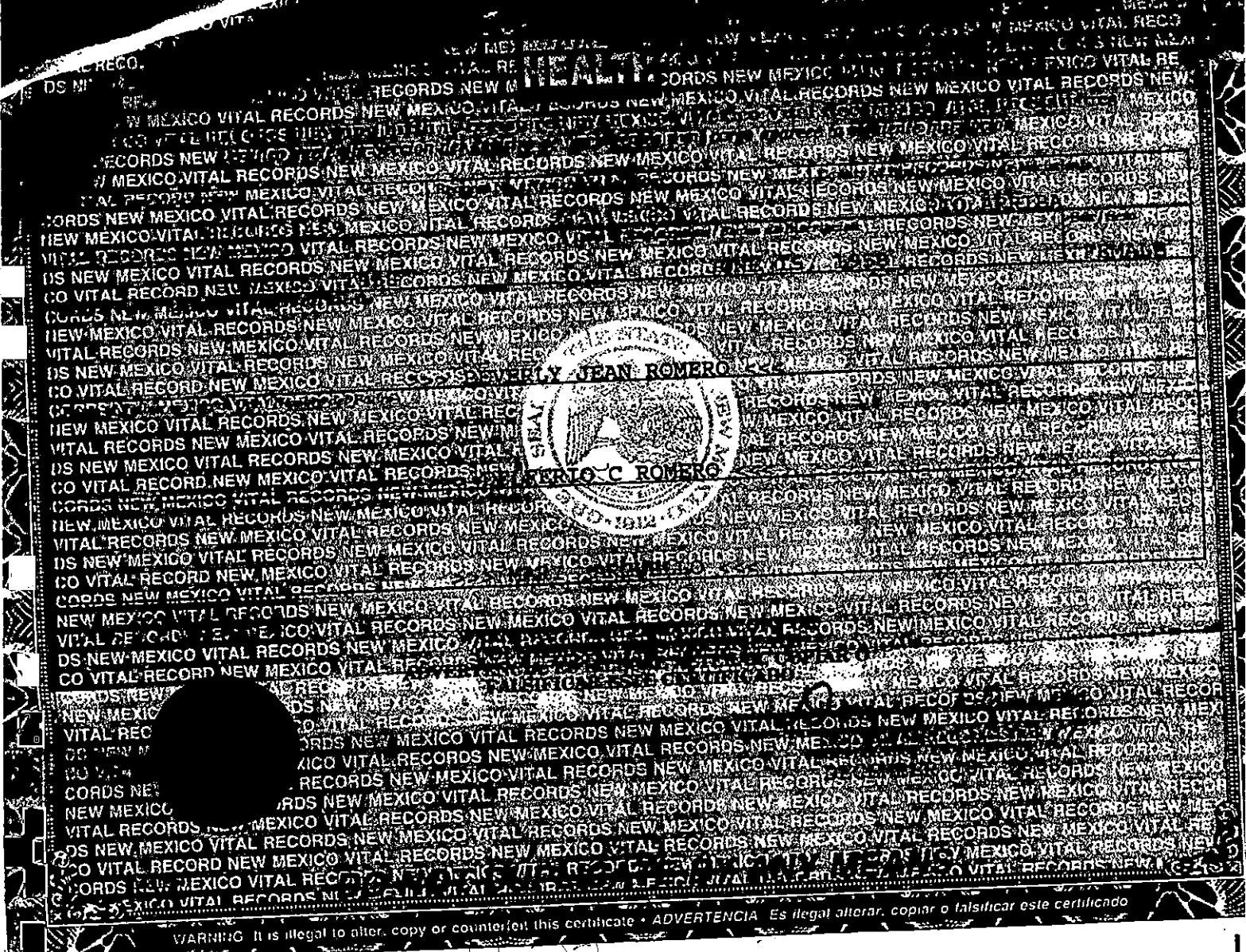

WARNING It is illegal to alter, copy or counterfeit this certificate • ADVERTENCIA Es ilegal alterar, copiar o falsificar este certificado

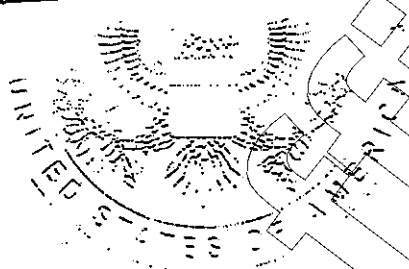

In testimony whereof, I, Michael R. Pompeo, Secretary of State, have hereunto caused the seal of the Department of State to be affixed and my name subscribed by the Assistant Authentication Officer, of the said Department, at the city of Washington, in the District of Columbia, this fifteenth day of August, 2018.

Michael R. Pompeo
Secretary of State

By [Signature]
Assistant Authentication Officer,
Department of State

Issued pursuant to CHXIV, State of
Sept. 15, 1789, 1 Stat. 68-69; 22
USC 2657; 22USC 2651a; 5 USC
301; 28 USC 1733 et. seq.; 8 USC
1443(f); RULE 44 Federal Rules of
Civil Procedure.

1140

2022-011769 MISC Page: 1143 of 2782
09/26/2022 03:35:37 PM Receipt #: 22-9381
Rec Fee: \$30.00 Darrell James Hill
Gila County, Az, Sadie Jo Bingham, Recorder



For: Demonstration Purposes Only;
Day: June 11, 2019
Autograph: ~~Revel~~ ~~Sean Row~~



1141

2022-011769 MISC Page: 1144 of 2782
09/26/2022 03:35:37 PM Receipt #: 22-9381
Rec Fee: \$30.00 Darrell James Hill
Gila County, Az, Sadie Jo Bingham, Recorder



Notice of Claim: RE 322 404 075 US:

Verification of the Civilian Status: man: Beverly-Jean: Romero-Hill

Arizona state
Pinal county

:Man :Beverly-Jean: Romero- Hill personally presents before me, the undersigned Notary duly authorized by the laws of Arizona to administer oaths; now on this 7th day: June: 2019, being by me first duly sworn on his affirmation, claimant deposes and says:

Claim

(A) :i- man of the family Romero am a) :Beverly-Jean (given-name)-beneficiary, and :owner of the property (a) :inherent-trust by the Almighty-God and (b): beneficiary -subrogee -in the idem sonans- trust by the subrogor: UNITED-STATES-government- Trustee. See: Notice of Claim: **RE 322 404 075 US: Verification of the Known Birth/Berth Statues: man: Beverly-Jean: Romero-Hill** , attached: 4 pages; AND

(B) :i- man am: Beverly- Jean: Romero- Hill; :New Mexican by the known presents and within the regard to of the Trading With The Enemy Act of 1917 (49 Stat. L. 411), as amended, am :civilian ~ am-Not :combatant, and am-Not :enemy, and am-Not :ally-of-enemy.

:i- man verify that all stated herein is true and correct; and: i- man will state same onto the record in the open court.

Without prejudice:

Autographed this 7th day June 2019 A.D.

Beverly-Jean: Romero-Hill
:Beverly-Jean: Romero- Hill, :beneficiary, :Executor

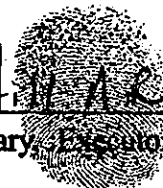

JURAT

Sworn to and subscribed before me now on this 7th day: June: 2019.

Produced identification: type: Arizona Driver License.

[Signature]

Notary

seal

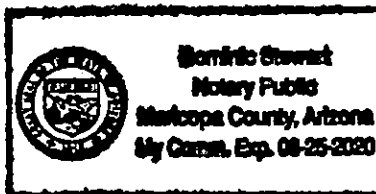

1142

2022-011769 MISC Page: 1145 of 2782
 09/26/2022 03:35:37 PM Receipt #: 22-9381
 Rec Fee: \$30.00 Darrell James Hill
 Gila County, Az, Sadie Jo Bingham, Recorder

Notice of Claim: USPS RMN~ RE 322 404 067 US:

Verification of the Known Birth/Berth Statuses: man: Darrell-James: Hill

Arizona state
Pinal county

:Man :Darrell- James: Hill personally presents before me, the undersigned Notary duly authorized by the laws of Arizona to administer oaths; now on this 7th day: June: 2019, being by me first duly sworn on his affirmation, claimant deposes and says:

:i- man of the family Hill am a) :Darrell-James (given-name)-beneficiary, and :owner of the property (a) :inherent-trust by the Almighty-God and (b): beneficiary -subrogee -in the idem sonans- trust by the subrogor: UNITED-STATES-government- Trustee as established and presented within the riveted- certified- instrument ~Not-altered-authentication~ attached (3 pages): p. 1/3 (at the bottom): certified- document: OHIO DEPARTMENT OF HEALTH~ DIVISION OF VITAL STATISTICS~ CERTIFICATE OF LIVE BIRTH -Birth No. 134 - 58 - 20881: document number F4012640; and: p. 2/3 :certification~ of~ authenticity by the United States of America~ State of Ohio~ Office of the Secretary of State- C074912; and: p. 3/3: with the 18047749-2~ United States of America~ [emblem] DEPARTMENT OF STATE.

Claim

:i -man am :Darrell-James: Hill, by the known presents: 1958~A.D- November~20th -Ohioan-birth of :i ~wherefrom and throughout the eternity nothing exists between :i -man and Almighty God, and by the known-presents: 1958-November~28 -OHIOAN-berth in the idem~sonans of the subrogation: DARRELL JAMES HILL. - AND :i- man am :soul-beneficiary :sui juris :Authorized Representative/~Executor of (A) the inherent trust by Almighty-God and (B) of the subrogee- trust by the UNITED STATES government-services-Trustee as established and presented by the within- riveted- certified- instrument;

:i- man verify that all stated herein is true and correct and will state same onto the record in the open court.

Without prejudice:

Autographed this 7th day June 2019 A.D.

Darrell-James Hill, A.R.
:Darrell-James: Hill, :beneficiary, :Executor

JURAT

Sworn to and subscribed before me now on this 7th day: June: 2019.
Produced identification: type: Arizona Driver License.

[Signature]
Notary

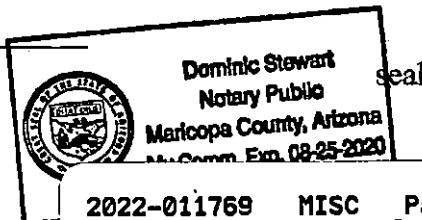

2022-011769 MISC Page: 1146 of 2782
09/26/2022 03:35:37 PM Receipt #: 22-9381
Rec Fee: \$30.00 Darrell James Hill
Gila County, Az, Sadie Jo Bingham, Recorder



United States of America



DEPARTMENT OF STATE

To all to whom these presents shall come, Greetings:

I Certify That the document hereunto annexed is under the Seal of the Secretary of State of the State(s) of Ohio, and that such Seal(s) is/are entitled to full faith and credit.*

**For the contents of the annexed document, the Department assumes no responsibility
This certificate is not valid if it is removed or altered in any way whatsoever*

In testimony whereof, I, Michael R. Pompeo, Secretary of State, have hereunto caused the seal of the Department of State to be affixed and my name subscribed by the Assistant Authentication Officer, of the said Department, at the city of Washington, in the District of Columbia, this seventeenth day of July, 2018.

Michael R. Pompeo

Secretary of State

By *[Signature]*

Issued pursuant to CHXIV, State of
Sept. 15, 1789, 1 Stat. 68-69; 22
USC 2657; 22USC 2651a; 5 USC
301; 28 USC 1733 et. seq.; 8 USC
1443(f); RULE 44 Federal Rules of
Civil Procedure.

1144

2022-011769 MISC Page: 1147 of 2782
09/26/2022 03:35:37 PM Receipt #: 22-9381
Rec Fee: \$30.00 Darrell James Hill
Gila County, Az, Sadie Jo Bingham, Recorder



For: Demonstration Purposes Only
Day: June 11, 2019
Autograph:



Darrell James Hill

1145

2022-011769 MISC Page: 1148 of 2782
09/26/2022 03:35:37 PM Receipt #: 22-9381
Rec Fee: \$30.00 Darrell James Hill
Gila County, Az, Sadie Jo Bingham, Recorder



United States of America
State of Ohio
Office of the Secretary of State

I, **JON HUSTED**, Secretary of State, do hereby certify that I am the duly elected, qualified and acting Secretary of State of the State of Ohio, and I further certify that

JUDITH B. NAGY

is the duly appointed, State Registrar, Vital Statistics Division, Department of Health, for the State of Ohio. She is the custodian of the records of Vital Statistics, and that she is the proper official to make said attestation, which is in due form; and that her official acts are entitled to full faith and credit.

This certification certifies only the authenticity of the signature of the official who signed the document, the capacity in which that official acted, and where appropriate, the identity of the seal or stamp, which the document bears. This certification does not imply that the contents of the document(s) are correct, nor that they have the approval of this office.

IN TESTIMONY WHEREOF, I have hereunto subscribed my name and affixed the official Seal of the Secretary of State of Ohio, at Columbus, Ohio, this 14th day of June, 2018.

Jon Husted
Jon Husted
Secretary of State

SEC4000 (Rev. 1/11)

1146

2022-011769 MISC Page: 1149 of 2782
09/26/2022 03:35:37 PM Receipt #: 22-9381
Rec Fee: \$30.00 Darrell James Hill
Gila County, Az, Sacie Jo Bingham, Recorder



For: Demonstration Purposes Only
Day: June 11, 2019
Autograph: Darrell James Hill



1147

2022-011769 MISC Page: 1150 of 2782
09/26/2022 03:35:37 PM Receipt #: 22-9381
Rec Fee: \$30.00 Darrell James Hill
Gila County, Az, Sadie Jo Bingham, Recorder



2022-011769 MISC Page: 1151 of 2782
09/26/2022 03:35:37 PM Receipt #: 22-9381
Rec Fee: \$30.00 Darrell James Hill
Gila County, Az, Sadie Jo Bingham, Recorder



1148

For: Demonstration Purposes Only
Day: June 11, 2019
Autograph: Darrell James Hill



11049

2022-011769 MISC Page: 1152 of 2782
09/26/2022 03:35:37 PM Receipt #: 22-9381
Rec Fee: \$30.00 Darrell James Hill
Gila County, Az, Sadie Jo Bingham, Recorder



**Notice of Claim: USPS RMN~ RE 322 404 067 US:
Verification of the Civilian Status: man: Darrell-James: Hill**

Arizona state
Pinal county

:Man :Darrell- James: Hill personally presents before me, the undersigned Notary duly authorized by the laws of Arizona to administer oaths; now on this 7th day: June: 2019, being by me first duly sworn on his affirmation, claimant deposes and says:

Claim

(A) :i- man of the family Hill am a) :Darrell-James (given-name)-beneficiary, and :owner of the property (a) :inherent-trust by the Almighty-God and (b): beneficiary -subrogee -in the idem sonans- trust by the subrogor: UNITED-STATES-government- Trustee. See: Notice of Claim: USPS RMN~ RE 322 404 067 US: Verification of the Known Birth/Berth Statuses: man: Darrell-James: Hill , attached: 4 pages; AND

(B) :i -man am :Darrell-James: Hill, :Ohioan by the known presents and within the regard to the Trading With The Enemy Act of 1917 (49 Stat. L. 411), as amended, am :civilian ~ am-Not :combatant, and am-Not :enemy, and am-Not :ally-of-enemy.

:i- man verify that all stated herein is true and correct and will state same onto the record in the open court.

Without prejudice:

Autographed this 7th day June 2019 A.D.

Darrell-James Hill, A.R.
:Darrell-James: Hill, :beneficiary, :Executor

JURAT

Sworn to and subscribed before me now on this 7th day: June: 2019.
Produced identification: type: Arizona Driver License.

[Signature]
Notary

seal

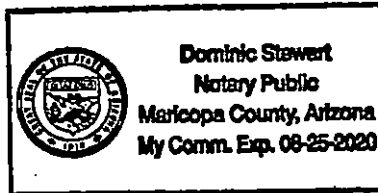

~~1150~~
1150

2022-011769 MISC Page: 1153 of 2782
09/26/2022 03:35:37 PM Receipt #: 22-9381
Rec Fee: \$30.00 Darrell James Hill
Gila County, Az, Sadie Jo Bingham, Recorder

:Darrell-James: Hill
:Beverly-Jean: Romero- Hill
c/o PO Box 3806
Apache Junction, Arizona, 85117

:Mary-C.: President Daly
Federal Reserve Bank: San Francisco
101 Market Street
San Francisco, California 94105

USPS RMN: RE 322 404 067 US

:Mary-C., Greetings:

We are :husband and wife of the enclosed two Affidavits with the documented exempted securities. As explained in the documents, we believe contacting You is the correct action at this time.

:i- man verify that all stated herein is true and correct and will state same onto the record in the open court.

Sincerely;
Without prejudice
DARRELL JAMES HILL

Darrell James Hill
:Darrell-James: Hill, A.R.
:Darrell-James: Hill, Executor

Without prejudice
BEVERLY JEAN ROMERO- HILL

Beverly Jean Romero Hill
:Beverly-Jean: Romero- Hill, A.R.
:Beverly-Jean: Romero- Hill, :man, Executor

IURAT

Sworn to and subscribed before me now on this 11th day: July: 2019.
Produced identification: type: Arizona Driver License.

Sandra A. Sanders
Notary

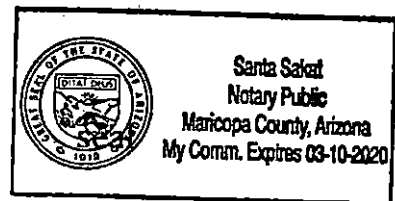

Darrell- James: & Beverly-Jean: :11 July 2019

2022-011769 MISC Page: 1154 of 2782

09/26/2022 03:35:37 PM Receipt #: 22-9381
Rec Fee: \$30.00 Darrell James Hill
Gila County, Az, Sadie Jo Bingham, Recorder



1151

:Darrell-James: Hill c/o PO Box 3806, Apache Junction, Arizona, 85117

Arizona state
Pinal county.

:Man :Darrell- James: Hill personally presents before me, the undersigned Notary duly authorized by the laws of Arizona to administer oaths; now on this 11th day: July: 2019, being by me first duly sworn, on his affirmation, claimant deposes and says: - Notice to the Agent is Notice to the Principal; Notice to the Principal is Notice to the Agent.

:Mary-C.: President Daly
Federal Reserve Bank: San Francisco
101 Market Street
San Francisco, California 94105

USPS RMN: RE 322 404 067 US

:Mary-C., Greetings:

Affiant:

:i -man am :Darrell-James: Hill - :Ohioan¹: known by the given-name: Darrell-James: (of the family) Hill, :birth: Ohio state: © November 20th day, 1958; Authorized Representative of the subrogation: DARRELL JAMES HILL, :berth: OHIO @ November 28th date, 1958.

The: BNP- Paribas Bank of the West, 'BNP- Paribas BOTW', Phoenix, Arizona, and The Presentment of the Demand- :Equity- Note², 'D.E.N.',

:i- man, A.R. am writing because of the BNP- Paribas BOTW representatives here on: June 20th, 2019~A.D. in a meeting³ openly abandoned their compliance with the U.S. banking laws as described below in (b) while arguing that :i -man, A.R., et al., either accept their corporate policy in a place over the U.S. banking laws and regulations or else :i -man, A.R. would have no recourse with them, and no alternative than to execute the :right of the D.E.N.- presentment to You directly at the Federal Reserve Bank - San Francisco.

The D.E.N. is an Exempted-Security Presentment

The presentment is an obligation of the UNITED STATES government

- 1 :i -man -beneficiary- :Darrell-James: Hill from the 1958 A.D. birth-unto-now: July~2019 am a Civilian and not a :combatant, belligerent, or ally-of-enemy. - Trading with the Enemy Act- 1917 - TWEA, sec. 5(b) as amended within the Emergency Banking Act- 1933.
- 2 Demand- :Equity Note: 2019-1158-001 - RE 322 404 067; 9 pages.
- 3 Meeting attended by: Beverly-Jean: Romero- Hill - wife - and :i

Darrell-James: Hill :11 July 2019 :

2022-011769 MISC Page: 1155 of 2782
09/26/2022 03:35:37 PM Receipt #: 22-9381
Rec Fee: \$30.00 Darrell James Hill
Gila County, Az, Sadie Jo Bingham, Recorder



1152

Darrell-James: Hill c/o PO Box 3806, Apache Junction, Arizona, 85117

under the Emergency Banking Act of 1933, et seq. The D.E.N. was tendered by i-man, A.R., the issuer, on: June 20th, 2019~A.D., to the BNP- Paribas BOTW representatives CHRIS PRICE and AMANDA HAMILTON who first accepted and took possession of the D.E.N. presentment as a 'banking deposit' as agreed. Thenafter- the- acceptance of the D.E.N. did CHRIS PRICE and AMANDA HAMILTON reject, offered and argued for their non-acceptance of the instrument, and summarily returned-back the D.E.N. to i-man, A.R. for their stated reasons; that: a) they did not know what a presentment is, nor b) what their legal duties or obligations are under the Emergency Banking Act of 1933, and nor c) what compliance requirements under UCC regulations governed their actions at that time.

BNP- Paribas BOTW corporation policy versus UNITED STATES law: Civilian

The BNP- Paribas BOTW representatives offered in a verbal contract that i-man, A.R. authorize that a copy of the D.E.N. be obtained to be sent to their BNP- Paribas BOTW 'Resolutions Department' for to determine with their BNP- Paribas BOTW's 'Legal' [department] what they will say the D.E.N. says and what it means; a process the BNP- Paribas BOTW representatives reveals usually takes several weeks.

As a Civilian⁴, i-man, A.R. did decline the BNP- Paribas BOTW representatives' offer in the discussion unto the impasse and mutual non-agreement.

BNP- Paribas BOTW policy

The BNP- Paribas BOTW representatives stated openly that the BNP- Paribas BOTW policy authorizes them to presently ignore the UNITED STATES' legislative acts and regulations; that, if i-man, A.R. did Not agree to their offer for the Resolution-Legal department- apparatus solely determining what is the UNITED STATES' law to be honored then, else, the only alternative is this direct presentment of the D.E.N. to You, et al., at the regional Federal Reserve Bank- San Francisco, and with a notice to the Alien Property Custodian for i-man, one of the living-soul- People of The United States of America.

You now upon this receipt do possess the: D.E.N. presentment and order, by the undersigning, for the authority to appropriately deposit the :demanded-equity- use currency in the amount stated into account at the bank indicated for i-

4 Civilian means: i-man am a non-combatant, non-belligerent, nor ally of enemy, an Ohioan: one of the People of The United States of America, and to the best of my present ability am compliant with the UNITED STATES' Emergency Banking Act of 1933, et seq., -Trading With The Enemy Act of 1917, as amended, with regard to the D.E.N..

Darrell-James: Hill :11 July 2019 :USPS RMN- RE 322 404 067 US 2 12

2022-011769 MISC Page: 1156 of 2782
09/26/2022 09:35:37 PM Receipt #: 22-9381
Rec Fee: \$30.00 Darrell James Hill
Gila County, Az, Sadie Jo Binsham, Recorder



1153

:Darrell-James: Hill c/o PO Box 3806, Apache Junction, Arizona, 85117

Encl: **Demand- :Equity Note: 2019-1158-001 - RE 322 404 067; 9 pages.**
:Checking Deposit for: Darrell James Hill, date: 06-20-2019; 1 slip.

cc: **:Nandita: President and Chief Executive Officer of Bank of the West Bakhshi**
Chief Executive Officer of BancWest
Co-Chief Executive Officer of BNP Paribas USA Inc.
c/o :Raj: Senior Executive Vice President and Chief Risk Officer Gopal
Risk management: Corporate Headquarters
Bank of the West
180 Montgomery Street
San Francisco, California 94104

:William-P: US Attorney General Barr
Alien Property Custodian: Department of Justice
950 Pennsylvania Avenue, N.W.
Washington, District of Columbia 20503-001

"
:i- man verify that all stated herein is true and correct and will state same onto
the record in the open court.

Sincerely;

Without prejudice
DARRELL JAMES HILL

Darrell - James Hill, A.R.

:Darrell-James: Hill, :man, :Recorder

IURAT

Sworn to and subscribed before me now on this 11th day: July: 2019.
Produced identification: type: Arizona Driver License.

Sandra J. Serbent
Notary

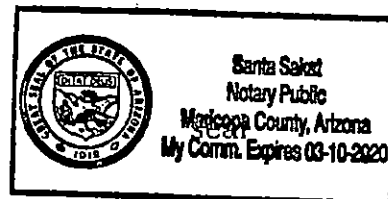

Darrell-James: Hill :11 July 2019 :USPS RMN: RE 322 404 067 US 3 / 3

2022-011769 MISC Page: 1157 of 2782
09/26/2022 03:35:37 PM Receipt #: 22-9381
Rec Fee: \$30.00 Darrell James Hill
Gila County, Az, Sadie Jo Bingham, Recorder



1154



CHECKING DEPOSIT

Deposits may not be available for immediate withdrawal.

NAME Darrell James Hill
BRANCH NAME Phoenix DATE 07-11-2019

SIGN HERE FOR LESS CASH IN TELLER'S PRESENCE

120-07282 (04/17)

CURRENCY	\$	\$
COIN		\$
NOTE	10,000,000,000	
TOTAL FROM OTHER SIDE		\$
LESS CASH RECEIVED		\$
TOTAL		

ACCOUNT NUMBER

AMOUNT DEPOSITED

\$ 10000000.00

⑆500100015⑆

2022-011769 MISC Page: 1158 of 2782
09/26/2022 03:35:37 PM Receipt #: 22-9381
Rec Fee: \$30.00 Darrell James Hill
Gila County, Az, Sadie Jo Bingham, Recorder



Unofficial

1155

Copy

:Beverly-Jean: Romero- Hill c/o PO Box 3806, Apache Junction, Arizona, 85117

"

**Arizona state
Pinal county.**

:Man :Beverly-Jean: Romero- Hill personally presents before me, the undersigned Notary duly authorized by the laws of Arizona to administer oaths; now on this 11th day: July: 2019, being by me first duly sworn, on his affirmation, claimant deposes and says: - Notice to the Agent is Notice to the Principal; Notice to the Principal is Notice to the Agent.

:Mary-C.: President Daly
Federal Reserve Bank: San Francisco
101 Market Street
San Francisco, California 94105

USPS RMN: RE 322 404 067 US

:Mary-C., Greetings:

Affiant:

:i -man am :Beverly-Jean: Romero- Hill - :New Mexican¹: known by the given-name: Beverly-Jean: (of the family) Romero, :birth: New Mexico state: © June 15th day, 1958; Authorized Representative of the subrogation: BEVERLY JEAN ROMERO- HILL, :berth: NEW MEXICO @ June 15th date, 1958.

The: BNP- Paribas Bank of the West, 'BNP- Paribas BOTW', Phoenix, Arizona, and The Presentment of the Demand- :Equity- Note², 'D.E.N.',

:i- man, A.R. am writing because of the BNP- Paribas BOTW representatives here on: June 20th, 2019~A.D. in a meeting³ openly abandoned their compliance with the U.S. banking laws as described below in (b) while arguing that :i -man, A.R., et al., either accept their corporate policy in a place over the U.S. banking laws and regulations or else :i -man, A.R. would have no recourse with them, and no alternative than to execute the :right of the D.E.N.- presentment to You directly at the Federal Reserve Bank - San Francisco.

The D.E.N. is an Exempted-Security Presentment

The presentment is an obligation of the UNITED STATES government

1. :i -man -beneficiary- :Beverly-Jean: Romero- Hill from the 1958 A.D. birth-unto-now: July~2019 am a Civilian and not a :combatant, belligerent, or ally-of-enemy. - Trading with the Enemy Act- 1917 - TWEA, sec. 5(b) as amended within the Emergency Banking Act- 1933.
2. Demand- :Equity Note: 2019-0658-001 - RE 322 404 075; 6 pages.
3. Meeting attended by: Beverly-Jean: Romero- Hill - wife - and :i

Beverly-Jean: Romero- Hill :11 July 2019

2022-011769 MISC Page: 1159 of 2782
09/26/2022 03:35:37 PM Receipt #: 22-9381
Rec Fee: \$30.00 Darrell James Hill
Gila County, Az, Sadie Jo Bingham, Recorder



1156

:Beverly-Jean: Romero- Hill c/o PO Box 3806, Apache Junction, Arizona, 85117

under the Emergency Banking Act of 1933, et seq. The D.E.N. was tendered by :i-man, A.R., the :issuer, on: June 20th, 2019~A.D., to the BNP- Paribas BOTW representatives CHRIS PRICE and AMANDA HAMILTON who first accepted and took possession of the D.E.N. presentment as a 'banking deposit' as agreed. Thenafter- the- acceptance of the D.E.N. did CHRIS PRICE and AMANDA HAMILTON reject, offered and argued for their non-acceptance of the instrument, and summarily returned-back the D.E.N. to :i-man, A.R. for their stated reasons; that: a) they did not know what a presentment is, nor b) what their legal duties or obligations are under the Emergency Banking Act of 1933, and nor c) what compliance requirements under UCC regulations governed their actions at that time.

BNP- Paribas BOTW corporation policy versus UNITED STATES law: Civilian

The BNP- Paribas BOTW representatives offered in a verbal contract that :i-man, A.R. authorize that a copy of the D.E.N. be obtained to be sent to their BNP- Paribas BOTW 'Resolutions Department' for to determine with their BNP- Paribas BOTW's 'Legal' [department] what they will say the D.E.N. says and what it means; a process the BNP- Paribas BOTW representatives reveals usually takes several weeks.

As a Civilian⁴, :i-man, A.R. did decline the BNP- Paribas BOTW representatives' offer in the discussion unto the impasse and mutual non-agreement.

BNP- Paribas BOTW policy

The BNP- Paribas BOTW representatives stated openly that the BNP- Paribas BOTW policy authorizes them to presently ignore the UNITED STATES' legislative acts and regulations; that, if :i-man, A.R. did Not agree to their offer for the Resolution-Legal department- apparatus solely determining what is the UNITED STATES' law to be honored then, else, the only alternative is this direct presentment of the D.E.N. to You, et al., at the regional Federal Reserve Bank- San Francisco, and with a notice to the Alien Property Custodian for :i-man, :one of the living- soul- People of The United States of America.

You now upon this receipt do possess the: D.E.N. presentment and order, by the undersigning, for the authority to appropriately deposit the :demanded-equity- use currency in the amount stated into account at the bank indicated for :i-
-

4 Civilian means: i- man am a non-combatant, non-belligerent, nor ally of enemy, an :New Mexican: one of the People of The United States of America, and to the best of my present ability am compliant with the UNITED STATES' Emergency Banking Act of 1933, et seq., -Trading With The Enemy Act of 1917, as amended, with regard to the D.E.N.

Beverly-Jean: Romero- Hill :11 July 201

2022-011769 MISC Page: 1160 of 2782
09/26/2022 03:35:37 PM Receipt #: 22-9381
Rec Fee: \$30.00 Darrell James Hill
Gila County, Az, Sadie Jo Bingham, Recorder



1157

:Beverly-Jean: Romero- Hill c/o PO Box 3806, Apache Junction, Arizona, 85117

Encl: Demand- :Equity Note: 2019-0658-001 - RE 322 404 075; 6 pages.
:Checking Deposit for: Beverly Jean Romero- Hill, date: 06-20-2019; 1 slip.

cc: :Nandita: President and Chief Executive Officer of Bank of the West Bakhshi
Chief Executive Officer of BancWest
Co-Chief Executive Officer of BNP Paribas USA Inc.
c/o :Raj: Senior Executive Vice President and Chief Risk Officer Gopal
Risk management: Corporate Headquarters
Bank of the West
180 Montgomery Street
San Francisco, California 94104

:William-P.: US Attorney General Barr
Alien Property Custodian: Department of Justice
950 Pennsylvania Avenue, N.W.
Washington, District of Columbia 20503-001

:i- man verify that all stated herein is true and correct and will state same onto
the record in the open court.

Sincerely;

Without prejudice
BEVERLY JEAN ROMERO- HILL

Beverly Jean Romero Hill, A.R.
:Beverly-Jean: Romero- Hill, Executor

UNITED STATES POSTAL SERVICE
REGISTERED MAIL™



RE 322 404 075 US

Label 200, August 2005

PSN 7690-03-000-9311

IURAT

Sworn to and subscribed before me now on this 11th day: July: 2019.
Produced identification: type: Arizona Driver License.

Santa Sakat
Notary

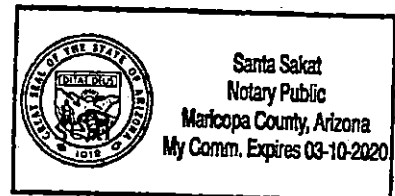

Beverly-Jean: Romero- Hill :11 July 2019 :USPS RMN: RE 322 404 075 US 3 / 3

2022-011769 MISC Page: 1161 of 2782
09/26/2022 03:35:37 PM Receipt #: 22-9381
Rec Fee: \$30.00 Darrell James Hill
Gila County, Az, Sadie Jo Bingham, Recorder



1158



BANK OF WEST
BNP PARIBAS

CHECKING DEPOSIT

Deposits may not be available for immediate withdrawal.

NAME Beverly Jean Romero Hill

BRANCH NAME Phoenix DATE 10-20-19

SIGN HERE FOR LESS CASH IN TELLER'S PRESENCE

120-07282 (04/17)

CURRENCY	\$	<u>0</u>
COIN		<u>0</u>
<u>Draft</u>		<u>10,000.00</u>
TOTAL FROM OTHER SIDE		<u>0</u>
LESS CASH RECEIVED		<u>0</u>
TOTAL		<u>10,000.00</u>

ACCOUNT NUMBER

059302166

AMOUNT DEPOSITED

\$ 10000.00

⑈500100015⑈

1159

2022-011769 MISC Page: 1162 of 2782
09/26/2022 03:35:37 PM Receipt #: 22-9381
Rec Fee: \$30.00 Darrell James Hill
Gila County, Az, Sadie Jo Bingham, Recorder



APACHE JUNCTION
 151 W SUPERSTITION BLVD
 APACHE JUNCTION, AZ
 85120-9998
 0302590130

07/11/2019 (800)275-8777 12:12 PM

Product Sale Final
 Description y Price

First-Class Mail® Large Envelope (Domestic) (SAN FRANCISCO, CA 94105) (Weight: 0 Lb 4.70 Oz) (Estimated Delivery Date) (Monday 07/15/2019)
 Registered 1 \$12.95 (Amount: \$21.00) (@USPS Registered Mail #) (RE322404067US)
 Return Receipt 1 \$2.80 (@USPS Return Receipt #) (9590940242158121976385)

Total \$17.35
 Cash \$18.00
 Change (\$0.65)

Due to the security of Registered Mail, an additional 3-10 delivery days should be added to the expected delivery date provided.

Text your track (2USPS) to get Standard Message apply. You may USPS Tracking o

To a t. 2 Sel

Registered No. RE322404067US

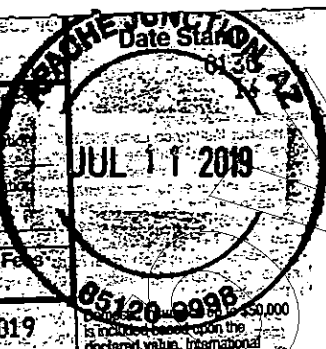

Postage \$	\$1.60	Extra Services & Fees (continued)	
Extra Services & Fees	\$12.95	Signature Confirmation	
<input type="checkbox"/> Registered Mail		Signature Confirmation Restricted Delivery	
<input type="checkbox"/> Return Receipt (hardcopy)	\$2.80	Total Postage & Fees	\$17.35
<input type="checkbox"/> Return Receipt (electronic)	\$0.00	Customer Must Declare Full Value	\$21.00
<input type="checkbox"/> Restricted Delivery		Received by	07/11/2019

OFFICIAL USE	
FROM Darrell James Hill Beverly Jean Romero Hill c/o PO Box 3886 Apache Junction, Arizona, 85117	TO Mary C. President Daly Federal Reserve Bank San Francisco 101 Market Street San Francisco, California 94105

PS Form 3806, Registered Mail Receipt April 2015, PSN 7530-02-000-9051 For domestic delivery information, visit our website at www.usps.com® Copy 1 - Customer (See Information on Reverse)

SENDER: COMPLETE THIS SECTION <input checked="" type="checkbox"/> Complete items 1, 2, and 3. <input checked="" type="checkbox"/> Print your name and address on the reverse so that we can return the card to you. <input checked="" type="checkbox"/> Attach this card to the back of the mailpiece or on the front if space permits. 1. Article Addressed to: Mary C. President Daly Federal Reserve Bank San Francisco 101 Market Street San Francisco, California 94105 9590 9402 4215 8121 9763 85 2. Article Number (Transfer from service label) RE 322 404 067 US	COMPLETE THIS SECTION ON DELIVERY A. Signature <input checked="" type="checkbox"/> Agent <input checked="" type="checkbox"/> Addressee B. Received by (Printed Name) C. Date of Delivery JUL 18 2019 D. Is delivery address different from item 1? <input type="checkbox"/> Yes If YES, enter delivery address below: <input type="checkbox"/> No 3. Service Type <input type="checkbox"/> Adult Signature <input type="checkbox"/> Adult Signature Restricted Delivery <input type="checkbox"/> Certified Mail® <input type="checkbox"/> Certified Mail Restricted Delivery <input type="checkbox"/> Collect on Delivery <input type="checkbox"/> Collect on Delivery Restricted Delivery <input type="checkbox"/> Priority Mail Express® <input type="checkbox"/> Registered Mail™ <input type="checkbox"/> Registered Mail Restricted Delivery <input type="checkbox"/> Return Receipt for Merchandise <input type="checkbox"/> Signature Confirmation™ <input type="checkbox"/> Signature Confirmation Restricted Delivery
--	--

PS Form 3811, July 2015 PSN 7530-02-000-9053 Domestic Return Receipt

1160





:Darrell-James: Hill
:Beverly-Jean: Romero- Hill
c/o PO Box 3806
Apache Junction, Arizona 85117

:Nandita: President and Chief Executive Officer of Bank of the West Bakhshi
c/o :Raj: Senior Executive Vice President and Chief Risk Officer Gopal
Risk management: Corporate Headquarters
Bank of the West
180 Montgomery Street
San Francisco, California 94104

Re: USPS RMN: RE 322 404 067 US mailing: as addressed, was sent for to advance the documented instruments of the contact re: the matter described concerning the documented securities from :Darrell-James: Hill, and Beverly-Jean: Romero- Hill.

Not Appended: a) BEVERLY JEAN ROMERO- HILL - Demand- :Equity Note: 2019-0658-001 - RE 322 404 075; 6 pages, Not appended - ; and: b) DARRELL JAMES HILL - Demand- :Equity Note: 2019-1158-001 - RE 322 404 067; 9 pages, Not appended.

:Nandita, :Raj, Greetings:

We believe you should be made aware of the occurrence, that were tendered and after dishonored by the BNP- Paribas Bank of the West personnel. Documented Security(s): Not Appended.

As is referenced, enclosed are the copies of the man and wife documents describing the :actions done in the association with the representatives of/ at the BNP- Paribas Bank of the West -Phoenix, Arizona. The securities were tendered, accepted, and, after, dishonored by the BNP- Paribas Bank of the West personnel as is described. Documented Security(s): Not Appended.

Sincerely;

Without prejudice
DARRELL JAMES HILL

July 12, 2019
:Darrell-James: Hill, A.R.
:Darrell-James: Hill, :man, :Executor

Without prejudice
BEVERLY JEAN ROMERO-HILL

:Beverly-Jean: Romero-Hill, A.R.
:Beverly-Jean: Romero- Hill, :man, :Executor

1161
Notice to: Nandita and Raj: BNP- P, BOTW USPS CMN 7018 0360 0000 5968 6122

PACHE JUNCTION
 151 W SUPERSTITION BLVD
 APACHE JUNCTION, AZ
 85120-9998
 0302590130

07/12/2019 (800)275-8777 2:36 PM

Product Description	Sale Qty	Final Price
First-Class Mail® Letter (Domestic) (SAN FRANCISCO, CA 94104) (Weight:0 Lb 1.60 Oz) (Estimated Delivery Date) (Monday 07/15/2019)	1	\$0.70
Certified (®USPS Certified Mail #) (70180360000059686122)	1	\$3.50
Return Receipt (®USPS Return Receipt #) (9590940242158121976392)	1	\$2.80

2779 8965 0000 0360 0100

U.S. Postal Service™
CERTIFIED MAIL® RECEIPT
 Domestic Mail Only

For delivery information, visit our website at www.usps.com

OFFICIAL USE

Certified Mail Fee	\$3.50	0130 01
Extra Services & Fees (check box, add fee as appropriate)	\$2.80	
<input type="checkbox"/> Return Receipt (hardcopy)	\$0.00	
<input type="checkbox"/> Return Receipt (electronic)	\$0.00	
<input type="checkbox"/> Certified Mail Restricted Delivery	\$0.00	
<input type="checkbox"/> Adult Signature Required	\$0.00	
<input type="checkbox"/> Adult Signature Restricted Delivery	\$0.00	
Postage	\$0.70	Postmark Here
Total Postage	\$0.70	07/12/2019
Sent To	Nandita President and Chief Executive Officer of Bank of the West Bakshi c/o Raj Senior Executive Vice President and Chief Risk Officer Gopal	
Street and Apt.	180 Montgomery Street	
City, State, ZIP	San Francisco, California 94104	

PS Form 3800, April 2015 PSN 7530-02-000-9053 See Reverse for Instructions

Total \$7.00
 Cash \$7.00

Text your tracking number to 28777 (2USPS) to get the latest status. Standard Message and Data rates may apply. You may also visit www.usps.com USPS Tr

SENDER: COMPLETE THIS SECTION

- Complete items 1, 2, and 3.
- Print your name and address on the reverse so that we can return the card to you.
- Attach this card to the back of the mailpiece, or on the front if space permits.

1. Article Addressed to:

Nandita: President and Chief Executive Officer of Bank of the West Bakshi c/o Raj: Senior Executive Vice President and Chief Risk Officer Gopal
 180 Montgomery Street
 San Francisco, California 94104



9590 9402 4215 8121 9763 92

7018 0360 0000 5968 6122

COMPLETE THIS SECTION ON DELIVERY

A. Signature Agent Addressee
 X [Signature]

B. Received by (Printed Name) C. Date of Delivery
 [Signature] 7-15-19

D. Is delivery address different from item 1? Yes No
 If YES, enter delivery address below:

- 3. Service Type**
- Adult Signature
 - Adult Signature Restricted Delivery
 - Certified Mail®
 - Certified Mail Restricted Delivery
 - Collect on Delivery
 - Delivery Restricted Delivery
 - Restricted Delivery
 - Priority Mail Express®
 - Registered Mail™
 - Registered Mail Restricted Delivery
 - Return Receipt for Merchandise
 - Signature Confirmation™
 - Signature Confirmation Restricted Delivery

PS Form 3811, July 2015 PSN 7530-02-000-9053

Domestic Return



Unrecorded

1162

USPS Tracking®

FAQs > (<https://www.usps.com/faqs/uspstracking-faqs.htm>)

Track Another Package +

Tracking Number: 70180360000059686122

Remove X

Expected Delivery by

MONDAY

15 JULY 2019 ⓘ

by **8:00pm** ⓘ

✓ Delivered

July 15, 2019 at 10:48 am
Delivered, Left with Individual
SAN FRANCISCO, CA 94104

Get Updates ▾

Text & Email Updates ▾

Tracking History ▲

July 15, 2019, 10:48 am
Delivered, Left with Individual
SAN FRANCISCO, CA 94104
Your item was delivered to an individual at the address at 10:48 am on July 15, 2019 in SAN FRANCISCO, CA 94104.

July 14, 2019, 3:55 pm
Departed USPS Regional Destination Facility
SAN FRANCISCO CA DISTRIBUTION CENTER

July 14, 2019, 8:15 am
Arrived at USPS Regional Destination Facility
SAN FRANCISCO CA DISTRIBUTION CENTER

1163



:Darrell-James: Hill, Beverly-Jean: Romero- Hill
c/o PO Box 3806, Apache Junction, Arizona, 85117

Donald: President of the UNITED STATES-, 'POTUS'-, Obligor-
:Emergency Banking Act-1933- Trump
1600 Pennsylvania Avenue NW
Washington, District of Columbia 20500

RMN: RE 322 404 212 US

William-P: UNITED STATES ATTORNEY GENERAL-, 'USAG'-,
Alien Property Custodian Barr
950 Pennsylvania Avenue, N.W.
Washington, District of Columbia 20503-001

RMN: RE 322 404 107 US

RE: Documents addressing the UNITED STATES Emergency Banking Act of 1933 indenture dry trust, et seq.; Requests are made.

:Donald, :William-P, Greetings:

:We: Darrell and Beverly are :man and wife, and :our referenced :documents are as addressed
:one for the each-one of: us addressing :our :wish and :requirement to :you the :executive- :trustees on/in
the matter of the UNITED STATES Emergency Banking Act of 1933, et seq.

Your prompt compliance would be appreciated.

cc: **William-P:** UNITED STATES ATTORNEY GENERAL-, 'USAG'-,
Alien Property Custodian Barr
950 Pennsylvania Avenue, N.W.
Washington, District of Columbia 20503-001

RMN: RE 322 404 107 US

:i- man verify that all stated herein is true and correct and will state same onto the record in the open court.

Sincerely;

Without prejudice
DARRELL JAMES HILL

:Darrell - James Hill, A.R

:Darrell-James: Hill, :man, :Executor

Without prejudice
BEVERLY JEAN ROMERO- HILL

:Beverly Jean: Romero- Hill, A.R

:Beverly-Jean: Romero- Hill, :man, :Executor

Darrell-James: Hill & Beverly-Jean: Romero- Hill :2

2022-011769 MISC Page: 1167 of 2782
09/26/2022 03:35:37 PM Receipt #: 22-9381
Rec Fee: \$30.00 Darrell James Hill
Gila County, Az, Sadie Jo Bingham, Recorder



Registered No. RE322404212US

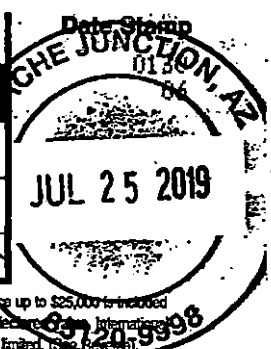

APACHE JUNCTION
151 W SUPERSTITION BLVD
APACHE JUNCTION, AZ 85120-9998
030259-0130
(800)275-8777
07/25/2019 01:40 PM

To Be Completed By Post Office	Reg. Fee	\$1.45	
	Handling Charge	\$12.95	Return Receipt
	Postage	\$2.80	Restricted Delivery
	Received by	\$0.00	
Customer Must Declare Full Value		\$21.00	07/25/2019

OFFICIAL USE

APACHE JUNCTION, AZ 85120

FROM:
Darrell James Hill
Dorothy Jean Romero Hill
PO Box 3806
Apache Junction, Arizona 85117

TO:
Donald: President of the UNITED STATES, "TRUMP"
Official Property Building No: 1933- Trump
1600 Pennsylvania Avenue NW
Washington, District of Columbia 20500

PS Form 3806, Receipt for Registered Mail Copy 1 - Customer
May 2007 (7530-02-000-9051) (See Information on Reverse)
For domestic delivery information, visit our website at www.usps.com

Registered No. RE322404107US



To Be Completed By Post Office	Reg. Fee	\$1.45	
	Handling Charge	\$12.95	Return Receipt
	Postage	\$2.80	Restricted Delivery
	Received by	\$0.00	
Customer Must Declare Full Value		\$21.00	07/25/2019

OFFICIAL USE

APACHE JUNCTION, AZ 85120

FROM:
Darrell James Hill
Dorothy Jean Romero Hill
PO Box 3806
Apache Junction, Arizona 85117

TO:
William P. US Attorney General Barr
Sited Property Custodian Department of Justice
950 Pennsylvania Avenue, N.W.
Washington, District of Columbia 20503-001

PS Form 3806, Receipt for Registered Mail Copy 1 - Customer
May 2007 (7530-02-000-9051) (See Information on Reverse)
For domestic delivery information, visit our website at www.usps.com

Product	Qty	Unit Price	Price
First-Class Mail® Large Envelope (Domestic) (WASHINGTON, DC 20500) (Weight: 0 Lb 3.70 Oz) (Estimated Delivery Date) (Monday 07/29/2019)	1	\$1.45	\$1.45
Registered (Amount: \$21.00) (USPS Registered Mail #) (RE322404212US)			\$12.95
Return Receipt (USPS Return Receipt #) (9590940247428344639783)			\$2.80
First-Class Mail® Large Envelope (Domestic) (WASHINGTON, DC 20503) (Weight: 0 Lb 3.80 Oz) (Estimated Delivery Date) (Monday 07/29/2019)	1	\$1.45	\$1.45
Registered (Amount: \$21.00) (USPS Registered Mail #) (RE322404107US)			\$12.95
Return Receipt (USPS Return Receipt #) (9590940247428344639776)			\$2.80
First-Class Mail® Letter (Domestic) (SAN FRANCISCO, CA 94105) (Weight: 0 Lb 1.60 Oz) (Estimated Delivery Date) (Monday 07/29/2019)	1	\$0.70	\$0.70
Certified (USPS Certified Mail #) (70092820000395708031)			\$3.50
Return Receipt (USPS Return Receipt #) (9590940247428344639769)			\$2.80
Total:			\$41.40

U.S. Postal Service - CERTIFIED MAIL - RECEIPT
(Domestic Mail Only; No Insurance Coverage Provided)

For delivery information visit our website at www.usps.com

OFFICIAL USE

Postage	\$3.50	0130
Certified Fee	\$2.80	06
Return Receipt Fee (Endorsement Required)	\$0.00	Postmark Here
Restricted Delivery Fee (Endorsement Required)	\$0.00	
Total Postage & Fees	\$7.00	07/25/2019

Sent to: Mary-C. President Daly
Federal Reserve Bank: San Francisco
101 Market Street
San Francisco, California 94105

2022-011769 MISC Page: 1168 of 2782
09/26/2022 03:35:37 PM Receipt #: 22-9381
Rec Fee: \$30.00 Darrell James Hill
Gila County, Az, Sadie Jo Bingham, Recorder

:Darrell-James: Hill c/o PO Box 3806, Apache Junction, Arizona, 85117

Arizona state
Pinal county.

The :man :Darrell- James: Hill, personally presents before me, the undersigned Notary duly authorized by the laws of Arizona to administer oaths; now on this 25th day: July: 2019, being by me first duly sworn, on his affirmation, claimant deposes and says: - Notice to the Agent is Notice to the Principal; Notice to the Principal is Notice to the Agent:

To:

Donald: President of the UNITED STATES-, 'POTUS',
Obligor- :Emergency Banking Act-1933- Trump
1600 Pennsylvania Avenue NW
Washington, District of Columbia 20500

RMN: RE 322 404 212 US

:William-P: UNITED STATES ATTORNEY GENERAL-,
'USAG'-, Alien Property Custodian Barr
950 Pennsylvania Avenue, N.W.
Washington, District of Columbia 20503-001

RMN: RE 322 404 107 US

RE: :i- man of the people of: The United States of America, 'TheUSofA', require that you¹, trustees of the UNITED STATES, 'U.S.', Emergency Banking Act of 1933², 'U.S.-EBA-1933', release all -property³ and chattels^{4 5 6}; now to :i.

:Donald, :William-P, Greetings:

- 1 **U.S.-EBA-1933: trustee obligation:** You Donald: POTUS Trump are the :Commander-in Chief and the :Obligor of the U.S.-EBA-1933, and you William-P: USAG Barr are the :Alien Property Custodian, 'APC', and the :Common law trustee of the U.S.-EBA-1933 Indenture-trust for the people of: TheUSofA.
- 2 The Emergency Banking Act of 1933, 'U.S.-EBA-1933' - Trading With The Enemy Act-1917, 'TWEA-1917', as amended by :U.S.-EBA-1933 is about: the trustee, the indenture-trust, debenture-bond, and the civilian declaration- condition upon the people: of The United States of America, 'TheUSofA'. The 'emergency' of the U.S.-EBA-1933 was legislatively ended in: 1976.
- 3 U.S.-EBA-1933: debenture bond: Developed in the 1933 U.S. Indenture trust is the debenture known commonly as the birth certificate which is a security indicative of the bond in the bond-holding program for each man-beneficiary -born of the people of: TheUSofA, managed by the APC.
- 4 Private Property and Chattels means: Document One - October 2016 means: USPS RMN RE 322 399 279 US, sent: October 25: 2016 A.D. to: Loretta: USAG Lynch, :delivered :October 31: 2016; return receipt number: 'RRN': 9590 9402 2073 6132 0333 58, and: et al.: 2018 A.D.
- 5 Private Property and Chattels means: Document 2017 Two - March 2017 means: USPS RE 322 399 251 US; sent: March 20th, 2017 A.D. to: Jeff: USAG Sessions, :delivered: April 4th, 2017; RRN: 9590 9402 2073 6132 0374 93, and: et al.: 2018 A.D.
- 6 Private Property and Chattels means: Document Three - September 2017 means: USPS RE 322 399 248 US; sent September 15th, 2017 A.D. to: Jeff: USAG Sessions, sent to: Jeff: USAG Sessions, :delivered: September 26th, 2017; RRN: 9590 9402 2785 7069 6401 36, and: et al.: 2018 A.D.

Darrell-James: Hill :25 July 2019 :USPS R'

2022-011769 MISC Page: 1169 of 2782
09/26/2022 03:35:37 PM Receipt #: 22-9381
Rec Fee: \$30.00 Darrell James Hill
Gila County, Az, Sadie Jo Bingham, Recorder



:Darrell-James: Hill c/o PO Box 3806, Apache Junction, Arizona, 85117

Thank you. We continue to pray for you.

[Intentionally left blank]

- 1) :i- man am :Darrell-James: Hill⁷, :one of the people of: TheUSofA, and: beneficiary of the U.S.-EBA-1933 agreement.
- 2) :you- man: are executives of the U.S. corporation - government-services-provider-Trustee to the people of: TheUSofA; and: you are the executive trustees of the U.S.-EBA-1933 indenture with the people of: TheUSofA.
- 3) :i- man-beneficiary inherently and privately own property that :you hold to this date: the :U.S.-EBA-1933- indenture-trust bond, and the :private- :property :you administer now without the right - See: Private Property and Chattels⁸;
- 4) :i- man require all of the property-held by: you to be released to :i as prescribed by: i.
- 5) :i- man wish for the Alien Property Custodian- Common law trustee to protect, insure and assure that :all of the property and rights-executed of :i- man-beneficiary a) within the U.S.-EBA-1933 indenture contract and b) within the common-law property and chattel- :in-specie⁹ holden by :you recently- 2016- now.
- 6) Apart-from your meeting of the cure and relief in the cestui-que-use of the U.S.-EBA-1933 :indenture- :trust is the :immediate- :remedy required for the harm and damage from your overly-long-term holding/appearance :of-the-stealing without the documentation of the property and chattels and liquid-assets and currency specifically, and for :which the :Demand- :Equity- :Note, 'D.E.N.' is directly- deposited with the Federal Reserve Bank -San Francisco: Mary-C.¹⁰. And,
- 7) :i- man- :beneficiary wish and authorize now that the man: William.-P: Alien Property Custodian- Common law trustee insure and assure that the required :D.E.N. deposited by: i- man to: Mary-C.: President Daly: Federal Reserve Bank: San Francisco, 'FRB-SF', is required from the property-held¹¹. See: 'Bank of the West' Form: [REDACTED] (04/17): Checking

7 Affiant. i-man- :beneficiary am :Darrell-James: Hill. - :Ohioan, :birth: Ohio state: © November 20th day, 1958; Authorized Representative of the beneficiary of the inherent trust of :man under :Almighty God - where nothing exists between Almighty God and :i- man - and of the UNITED STATES, 'U.S.', government EBA-1933- :indenture- :trust :1933-2003 through the cestui-que-vie by the :idem-sonans- :subrogation: DARRELL JAMES HILL, :berth: OHIO @ November 28th date, 1958.

8 Ibid. See: footnote: 4, 5, 6.

9 Ibid.

10 D.E.N. to: Mary-C. - FRB-SF means: USPS RMN: RE 322 404 067 US; sent: 11 July 2019, received: 18 July 2019; appended: 3 pages. The :circumstance necessitating of/ and the :direct presentment

11 :Property-held means: a) the :U.S.-EBA-1933 :debenture- :bond/ b) the private-property and chattels and liquid-assets and currency. - Ibid. Footnote: 4, 5, 6.

Darrell-James: Hill :25 July 2019 :USPS R

2022-011769 MISC Page: 1170 of 2782
09/26/2022 03:35:37 PM Receipt #: 22-9381
Rec Fee: \$30.00 Darrell James Hill
Gila County, Az, Sadie Jo Bingham, Recorder



:Darrell-James: Hill c/o PO Box 3806, Apache Junction, Arizona, 85117

Deposit-slip completed and authorized to the account and for the amount authorised and required by :i- man-beneficiary in the D.E.N., appended: 1 slip (stapled to a sheet).

8) :i- man believe the :U.S. Trustee(s) are to be :Not-in-a-competition with :i- man-beneficiary for this :property- :claimed.

9) **The: 'emergency' of the U.S.-EBA-1933 - indenture-trust¹², was legislatively ended in: 1976.**

10) **The U.S.-EBA-1933 - indenture- trust- :obligation upon the people-debentured under the agreement ended in: 2003 A.D. And, now,**

11) **:i- man believe that the U.S.-EBA-1933 -:indenture is now a dry trust.**

12) The :U.S.-EBA-1933 amended¹³ the Trading With The Enemy Act, 'TWEA-1917'.

13) **The: 'enemy condition' of the TWEA-1917, as amended by: U.S.-EBA-1933 describes :i- man-beneficiary as a 'civilian: not combatant, not belligerent, not ally-of-enemy'.**

14) **:i- man's a) identification by the authenticated debenture certificate and b) the :civilian- :declaration in the Jurat- affidavit was delivered to you: Donald: POTUS - Commander- Obligor Trump, USPS RMN: RE 322 404 098 US and William -P: USAG- APC Barr, USPS RMN: RE 322 404 084 US. And:**

15) i- man do not consent to the any further U.S.-EBA-1933 Trustee, et al. agents use of :this or any other diffuse- systemic -enemy- non-civilian- presumption that implements threatening and/or injuring onto :i- man-beneficiary, et al.

16) :i- man-beneficiary require the :U.S. Commander and Trustee, et al. of the :U.S.-EBA-1933 - :indenture to act under the fidelity of their oath, duty and obligation to the UNITED STATES Constitution under : 'The Constitution for the United States of America' for the absolute benefit to :i -man-beneficiary.

18) :i- man require the :Common- law- trustee of the U.S.-EBA-1933 - :indenture to act under the fidelity for the absolute benefit of :i- man, and specifically for the a) :assurance of the D.E.N. and b) the emergent release of :all of the other property and chattel and liquid assets and currency holden by :you most recently: 2016 - now.

The identification of :i-man :Darrell-James, of the family Hill is clear, the :civilian declaration is firm, and the :property and chattel and liquid assets and currency requirements are certain. :The- all that remains to be elucidated now is the :strength of

12 U.S.-EBA-1933; the indenture: In :1933 A.D. the 1933 U.S.- corporation- government-services-provider, et al., wholly indentured itself by the U.S.-EBA-1933 to the people of: TheUSofA, contracting a :trusteeship over all of the people's national property then-to-fore as the collateral for a purported-emergent U.S. bankruptcy-condition, and a new deal. Thereupon, and therein 1933, et seq., the :people acquiesced to the U.S. trust- :indenture and to the 'New Deal' of that time. **The indenture of the U.S.-EBA-1933 ended in March 2003.**

13 **The :enemy-condition, :civilian declaration:** The TWEA-1917, as amended by: EBA-1933 began and continues to presume that the people of: TheUSofA are the presumed-enemy of the U.S.- corporate-operations- failings in the 1927- 1933 A.D.- :U.S. -Federal Reserve Banking System, thereby justifying placing the :people of: TheUSofA under the military- :rule under the U.S. -Lieber code, as amended; meaning, that :each-man of the people of: TheUSofA, in :order to meet the :condition of the 'civilian' -declaration, must proactively affirm in the writing to the U.S. trustees that they man-beneficiary are 'civilian': not combatant, not belligerent, not ally-of-enemy.

Darrell-James: Hill :25 July 2019 :USPS RMN: RE 322 404 098 US

2022-011769 MISC Page: 1171 of 2782
09/26/2022 03:35:37 PM Receipt #: 22-9381
Rec Fee: \$30.00 Darrell James Hill
Gila County, Az, Sadie Jo Bingham, Recorder



:Darrell-James: Hill c/o PO Box 3806, Apache Junction, Arizona, 85117

the integrity of the man :Donald: President- Commander - Obligor- Trustee and of the man :William-P: USAG- Alien Property Custodian and Common law trustee Barr.

cc: **:William-P:** UNITED STATES ATTORNEY GENERAL-,
'USAG'-, Alien Property Custodian Barr
950 Pennsylvania Avenue, N.W.
Washington, District of Columbia 20503-001

RMN: RE 322 404 107 US

:Mary-C.: President Daly
Federal Reserve Bank: San Francisco
101 Market Street
San Francisco, California 94105

CMN: 7009 2820 0003
9570 8031

"

:i- man verify that all stated herein is true and correct and will state same onto the record in the open court.

Sincerely;

Without prejudice
DARRELL JAMES HILL

Darrell James Hill, H.R.

:Darrell-James: Hill, :man, :Executor

IURAT

Sworn to and subscribed before me now on this 25th day: July: 2019.
Produced identification: type: Arizona Driver License.

Dominic Stewart

Notary

seal

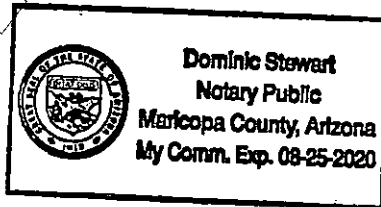

Darrell-James: Hill :25 July 2019 :USPS RMN: RE 322 404 212 US

4 / 4

2022-011769 MISC Page: 1172 of 2782
09/26/2022 03:35:37 PM Receipt #: 22-9381
Rec Fee: \$30.00 Darrell James Hill
Gila County, Az, Sadie Jo Bingham, Recorder



1169

:Darrell-James: Hill c/o PO Box 3806, Apache Junction, Arizona, 85117

Arizona state
Pinal county.

:Man :Darrell- James: Hill personally presents before me, the undersigned Notary duly authorized by the laws of Arizona to administer oaths; now on this 11th day: July: 2019, being by me first duly sworn, on his affirmation, claimant deposes and says: - Notice to the Agent is Notice to the Principal; Notice to the Principal is Notice to the Agent.

:Mary-C.: President Daly
Federal Reserve Bank: San Francisco
101 Market Street
San Francisco, California 94105

USPS RMN: RE 322 404 067 US

:Mary-C., Greetings:

Affiant:

:i -man am :Darrell-James: Hill - :Ohioan¹: known by the given-name: Darrell-James: (of the family) Hill, :birth: Ohio state: © November 20th day, 1958; Authorized Representative of the subrogation: DARRELL JAMES HILL, :berth: OHIO © November 28th date, 1958.

The: BNP- Paribas Bank of the West, 'BNP- Paribas BOTW', Phoenix, Arizona, and The Presentment of the Demand- :Equity- Note², 'D.E.N.',

:i- man, A.R. am writing because of the BNP- Paribas BOTW representatives here on: June 20th, 2019~A.D. in a meeting³ openly abandoned their compliance with the U.S. banking laws as described below in (b) while arguing that :i -man, A.R., et al., either accept their corporate policy in a place over the U.S. banking laws and regulations or else :i -man, A.R. would have no recourse with them, and no alternative than to execute the :right of the D.E.N.- presentment to You directly at the Federal Reserve Bank - San Francisco.

The D.E.N. Is an Exempted-Security Presentment

The presentment is an obligation of the UNITED STATES government

1 :i -man -beneficiary- :Darrell-James: Hill from the 1958 A.D. birth-unto-now: July~2019 am a Civilian and not a :combatant, belligerent, or ally-of-enemy. - Trading with the Enemy Act- 1917 - TWEA, sec. 5(b) as amended within the Emergency Banking Act- 1933.

2 Demand- :Equity Note: 2019-1158-001 - RE 322 404 067; 9 pages.

3 Meeting attended by: Beverly-Jean: Romero- Hill - wife - and :i

Darrell-James: Hill :11 July 2019 :USPS RMN: RE 322 404 067 US

1 / 3

2022-011769 MISC Page: 1173 of 2782
09/26/2022 03:35:37 PM Receipt #: 22-9381
Rec Fee: \$30.00 Darrell James Hill
Gila County, Az, Sadie Jo Bingham, Recorder



1170

:Darrell-James: Hill c/o PO Box 3806, Apache Junction, Arizona, 85117

under the Emergency Banking Act of 1933, et seq. The D.E.N. was tendered by i-man, A.R., the issuer, on: June 20th, 2019~A.D., to the BNP- Paribas BOTW representatives CHRIS PRICE and AMANDA HAMILTON who first accepted and took possession of the D.E.N. presentment as a 'banking deposit' as agreed. Thenafter- the- acceptance of the D.E.N. did CHRIS PRICE and AMANDA HAMILTON reject, offered and argued for their non-acceptance of the instrument, and summarily returned-back the D.E.N. to i-man, A.R. for their stated reasons; that: a) they did not know what a presentment is, nor b) what their legal duties or obligations are under the Emergency Banking Act of 1933, and nor c) what compliance requirements under UCC regulations governed their actions at that time.

BNP- Paribas BOTW corporation policy versus UNITED STATES law: Civilian

The BNP- Paribas BOTW representatives offered in a verbal contract that i-man, A.R. authorize that a copy of the D.E.N. be obtained to be sent to their BNP- Paribas BOTW 'Resolutions Department' for to determine with their BNP- Paribas BOTW's 'Legal' [department] what they will say the D.E.N. says and what it means; a process the BNP- Paribas BOTW representatives reveals usually takes several weeks.

As a Civilian⁴, i-man, A.R. did decline the BNP- Paribas BOTW representatives' offer in the discussion unto the impasse and mutual non-agreement.

BNP- Paribas BOTW policy

The BNP- Paribas BOTW representatives stated openly that the BNP- Paribas BOTW policy authorizes them to presently ignore the UNITED STATES' legislative acts and regulations; that, if i-man, A.R. did Not agree to their offer for the Resolution-Legal department- apparatus solely determining what is the UNITED STATES' law to be honored then, else, the only alternative is this direct presentment of the D.E.N. to You, et al., at the regional Federal Reserve Bank- San Francisco, and with a notice to the Alien Property Custodian for i-man, :one of the living- soul- People of The United States of America.

You now upon this receipt do possess the: D.E.N. presentment and order, by the undersigning, for the authority to appropriately deposit the :demanded-equity- use currency in the amount stated into account at the bank indicated for :i-

⁴ Civilian means: i-man am a non-combatant, non-belligerent, nor ally of enemy, an :Ohioan: one of the People of The United States of America, and to the best of my present ability am compliant with the UNITED STATES' Emergency Banking Act of 1933, et seq., -Trading With The Enemy Act of 1917, as amended, with regard to the D.E.N.

Darrell-James: Hill :11 July 2019 :USPS RMN: RE 322 404 067 US

2 / 3

2022-011769 MISC Page: 1174 of 2782
09/26/2022 03:35:37 PM Receipt #: 22-9381
Rec Fee: \$30.00 Darrell James Hill
Gila County, Az, Sadie Jo Bingham, Recorder



:Darrell-James: Hill c/o PO Box 3806, Apache Junction, Arizona, 85117

**Encl: Demand- :Equity Note: 2019-1158-001 - RE 322 404 067; 9 pages.
:Checking Deposit for: Darrell James Hill, date: 06-20-2019; 1 slip.**

**cc: :Nandita: President and Chief Executive Officer of Bank of the West Bakhshi
Chief Executive Officer of BancWest
Co-Chief Executive Officer of BNP Paribas USA Inc.
c/o :Raj: Senior Executive Vice President and Chief Risk Officer Gopal
Risk management: Corporate Headquarters
Bank of the West
180 Montgomery Street
San Francisco, California 94104**

**:William-P: US Attorney General Barr
Alien Property Custodian: Department of Justice
950 Pennsylvania Avenue, N.W.
Washington, District of Columbia 20503-001**

**i- man verify that all stated herein is true and correct and will state same onto
the record in the open court.**

Sincerely;

Without prejudice

DARRELL JAMES HILL

:Darrell - James Hill A.R.

:Darrell-James: Hill, :man for

IURAT

**Sworn to and subscribed before me now on this 11th day: July: 2019.
Produced identification: type: Arizona Driver License.**

***Sadie Jo Bingham*
Notary**

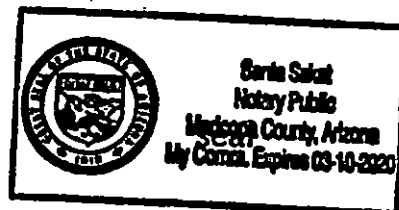

Darrell-James: Hill :11 July 2019 :USPS RMN: RE 322 404 067 US 3 / 3

**2022-011769 MISC Page: 1175 of 2782
09/26/2022 03:35:37 PM Receipt #: 22-9381
Rec Fee: \$30.00 Darrell James Hill
Gila County, Az, Sadie Jo Bingham, Recorder**





BANK OF THE WEST
BNP PARIBAS

CHECKING DEPOSIT

Deposits may not be available for immediate withdrawal.

NAME Darrell James Hill

BRANCH NAME Phoenix DATE 06-20-2019

SIGN HERE FOR LESS CASH IN TELLER'S PRESENCE

120-07282 (04/17)

CURRENCY	\$	<u>0</u>
COIN		<u>0</u>
<u>Draft</u>		<u>10,000,000.00</u>
TOTAL FROM OTHER SIDE		<u>0</u>
LESS CASH RECEIVED		<u>0</u>
TOTAL		<u>10,000,000.00</u>

ACCOUNT NUMBER



AMOUNT DEPOSITED

\$ 10,000,000.00

Darrell James Hill, 06/25/2019



⑆500100015⑆

1173

2022-011769 MISC Page: 1176 of 2782
09/26/2022 03:35:37 PM Receipt #: 22-9381
Rec Fee: \$30.00 Darrell James Hill
Gila County, Az, Sadie Jo Bingham, Recorder



:Beverly-Jean: Romero- Hill c/o PO Box 3806, Apache Junction, Arizona, 85117

“

Arizona state
Pinal county.

The :man :Beverly-Jean: Romero- Hill, personally presents before me, the undersigned Notary duly authorized by the laws of Arizona to administer oaths; now on this 25th day: July: 2019, being by me first duly sworn, on his affirmation, claimant deposes and says: - Notice to the Agent is Notice to the Principal; Notice to the Principal is Notice to the Agent:

To:

Donald: President of the UNITED STATES-, 'POTUS',
Obligor- :Emergency Banking Act-1933- Trump
1600 Pennsylvania Avenue NW
Washington, District of Columbia 20500

RMN: RE 322 404 212 US

:William-P: UNITED STATES ATTORNEY GENERAL-,
'USAG', Alien Property Custodian Barr
950 Pennsylvania Avenue, N.W.
Washington, District of Columbia 20503-001

RMN: RE 322 404 107 US

RE: :i- man of the people of: The United States of America, 'TheUSofA', require that you¹, trustees of the UNITED STATES, 'U.S.', Emergency Banking Act of 1933², 'U.S.-EBA-1933', release all -property and chattels; now to :i.

:Donald, :William-P, Greetings:

Thank you. We continue to pray for you.

- 1) :i- man am :Beverly-Jean: Romero- Hill³, :one of the people of: TheUSofA, and: beneficiary of the U.S.-EBA-1933 agreement.
- 2) :you- man: are executives of the U.S. corporation - government-services-provider-Trustee to the people of: TheUSofA, and: you are the executive trustees of the U.S.-EBA-1933 indenture with the people of: TheUSofA.

- 1 U.S.-EBA-1933: trustee obligation: You Donald:POTUS Trump are the :Commander-in Chief and the :Obligor of the U.S.-EBA-1933, and you William-P: USAG Barr are the :Alien Property Custodian, 'APC', and the :Common law trustee of the U.S.-EBA-1933 Indenture-trust for the people of: TheUSofA.
- 2 The Emergency Banking Act of 1933, 'U.S.-EBA-1933' - Trading With The Enemy Act-1917, 'TWEA-1917', as amended by :U.S.-EBA-1933 is about: the trustee, the indenture-trust, debenture-bond, and the civilian declaration- condition upon the people: of The United States of America, 'TheUSofA'. The 'emergency' of the U.S.-EBA-1933 was legislatively ended in: 1976.
- 3 Affiant i -man- :beneficiary am :Beverly-Jean: Romero- Hill - :New Mexican, :birth: New Mexico state: © June 15th day, 1958; Authorized Representative of the beneficiary of the inherent trust of :man under :Almighty God - where nothing exists between Almighty God and :i- man - and of the UNITED STATES, 'U.S.,' government EBA-1933- :indenture- :trust :1933-2003 through the cestui-que-vie by the :idem-sonans- :subrogation: BEVERLY JEAN ROMERO, :berth: NEW MEXICO @ June 15th date, 1958.

Beverly-Jean: Romero- Hill :25 July 2019 :USPS RMN: RE 322 404 212 US

1 / 3

2022-011769 MISC Page: 1177 of 2782
09/26/2022 03:35:37 PM Receipt #: 22-9381
Rec Fee: \$30.00 Darrell James Hill
Gila County, Az, Sadie Jo Bingham, Recorder



1174

:Beverly-Jean: Romero- Hill c/o PO Box 3806, Apache Junction, Arizona, 85117

- 4) **:i- man require all of the property-held by: you to be released to :i as prescribed by: i.**
- 5) **:i- man wish for the Alien Property Custodian- Common law trustee to protect, insure and assure that :all of the property and rights-executed of :i- man-beneficiary within the U.S.-EBA-1933 indenture contract specifically, and for :which the :Demand- :Equity- :Note, 'D.E.N.' is directly- deposited with the Federal Reserve Bank -San Francisco: Mary-C.⁴. And,**
- 7) **:i- man- :beneficiary wish and authorize now that the man: William.-P: Alien Property Custodian- Common law trustee insure and assure that the required :D.E.N. deposited by: i- man to: Mary-C.: President Daly: Federal Reserve Bank: San Francisco, 'FRB-SF', is required from the property-held⁵. See: 'Bank of the West' Form: [REDACTED] (07/17): Checking Deposit- slip completed and authorized to the account and for the amount authorised and required by :i- man-beneficiary in the D.E.N., appended: 1 slip (stapled to a sheet).**
- 8) **:i- man believe the :U.S. Trustee(s) are to be :Not-in-a-competition with :i- man-beneficiary for this :property- :claimed.**
- 9) **The: 'emergency' of the U.S.-EBA-1933 - indenture-trust⁶, was legislatively ended in: 1976.**
- 10) **The U.S.-EBA-1933 - indenture- trust- :obligation upon the people-debentured under the agreement ended in: 2003 A.D. And, now,**
- 11) **:i- man believe that the U.S.-EBA-1933 -:indenture is now a dry trust.**
- 12) **The :U.S.-EBA-1933 amended⁷ the Trading With The Enemy Act, 'TWEA-1917'.**
- 13) **The: 'enemy condition' of the TWEA-1917, as amended by: U.S.-EBA-1933 describes :i- man-beneficiary as a 'civilian: not combatant, not belligerent, not ally-of-enemy'.**
- 14) **:i- man's a) identification by the authenticated debenture certificate and b) the :civilian- :declaration in the Jurat- affidavit was delivered to you: Donald: POTUS - Commander- Obligor Trump, USPS RMN: RE 322 404 098 US and William -P: USAG- APC Barr, USPS RMN: RE 322 404 084 US. And:**
- 15) **i- man do not consent to the any further U.S.-EBA-1933 Trustee, et al. agents use of :this or any other diffuse- systemic -enemy- non-civilian- presumption that implements threatening and/or injuring onto :i- man-beneficiary, et al.**

4 D.E.N. to: Mary-C. - FRB-SF means: USPS RMN: RE 322 404 067 US; sent: 11 July 2019, received: 18 July 2019; appended: 3 pages. The :circumstance necessitating of/ and the :direct presentment

5 :Property-held means: the :U.S.-EBA-1933 :debenture- :bond.

6 U.S.-EBA-1933: the indenture: In :1933 A.D. the 1933 U.S.- corporation- government-services-provider, et al., wholly indentured itself by the U.S.-EBA-1933 to the people of: TheUSofA, contracting a :trusteeship over all of the people's national property then-to-fore as the collateral for a purported-emergent U.S. bankruptcy-condition, and a new deal. Thereupon, and therein 1933, et seq., the :people acquiesced to the U.S. trust- :indenture and to the 'New Deal' of that time. **The indenture of the U.S.-EBA-1933 ended in March 2003.**

7 The :enemy-condition, :civilian declaration: The TWEA-1917, as amended by: EBA-1933 began and continues to presume that the people of: TheUSofA are the presumed-enemy of the U.S.- corporate-operations- failings in the 1927- 1933 A.D.- :U.S. -Federal Reserve Banking System, thereby justifying placing the :people of: TheUSofA under the military- :rule under the U.S. -Lieber code, as amended; meaning, that :each-man of the people of: TheUSofA, in :order to meet the :condition of the 'civilian' -declaration, must proactively affirm in the writing to the U.S. trustees that they man-beneficiary are 'civilian': not combatant, not belligerent, not ally-of-enemy.

Beverly-Jean: Romero- Hill :25 July 2019 :USPS

2022-011769 MISC Page: 1178 of 2782

09/26/2022 03:35:37 PM Receipt #: 22-9381
Rec Fee: \$30.00 Darrell James Hill

Gila County, Az, Sadie Jo Bingham, Recorder



1175

:Beverly-Jean: Romero- Hill c/o PO Box 3806, Apache Junction, Arizona, 85117

16) :i- man-beneficiary require the :U.S. Commander and Trustee, et al. of the :U.S.-EBA-1933 - :indenture to act under the fidelity of their oath, duty and obligation to the UNITED STATES Constitution under : 'The Constitution for the United States of America' for the absolute benefit to :i -man-beneficiary.

18) :i- man require the :Common- law- trustee of the U.S.-EBA-1933 - :indenture to act under the fidelity for the absolute benefit of :i- man, and specifically for the a) :assurance of the D.E.N. and b) the emergent release of :all of the other property and chattel and liquid assets and currency holden by :you most recently: 2016 - now.

The identification of :i-man :Beverly-Jean, of the family Romero- Hill is clear, the :civilian declaration is firm, and the :property is certain. :The- all that remains to be elucidated now is the :strength of the integrity of the man :Donald: President- Commander - Obligor- Trustee and of the man :William-P: USAG- Alien Property Custodian and Common law trustee Barr.

cc: **:William-P: UNITED STATES ATTORNEY GENERAL-, 'USAG'-, Alien Property Custodian Barr 950 Pennsylvania Avenue, N.W. Washington, District of Columbia 20503-001**

RMN: RE 322 404 107 US

:Mary-C.: President Daly Federal Reserve Bank: San Francisco 101 Market Street San Francisco, California 94105

CMN: 7009 2820 0003 9570 8031

”
:i- man verify that all stated herein is true and correct and will state same onto the record in the open court.

Sincerely,

Without prejudice

BEVERLY JEAN ROMERO- HILL

Beverly Jean Romero Hill, A.R.

:Beverly-Jean: Romero- Hill, :man, :Executor

IURAT

Sworn to and subscribed before me now on this 25th day: July: 2019.

Produced identification: type: Arizona Driver License.

James Dawson
Notary

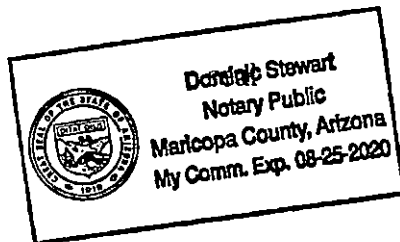

Beverly-Jean: Romero- Hill :25 July 2019 :USPS

2022-011769 MISC Page: 1179 of 2782
09/26/2022 03:35:37 PM Receipt #: 22-9381
Rec Fee: \$30.00 Darrell James Hill
Gila County, Az. Sadie Jo Bingham, Recorder



:Beverly-Jean: Romero- Hill c/o PO Box 3806, Apache Junction, Arizona, 85117

**Arizona state
Pinal county.**

:Man :Beverly-Jean: Romero- Hill personally presents before me, the undersigned Notary duly authorized by the laws of Arizona to administer oaths; now on this 11th day: July: 2019, being by me first duly sworn, on his affirmation, claimant deposes and says: - Notice to the Agent is Notice to the Principal; Notice to the Principal is Notice to the Agent.

**:Mary-C.: President Daly
Federal Reserve Bank: San Francisco
101 Market Street
San Francisco, California 94105**

USPS RMN: RE 322 404 067 US

:Mary-C., Greetings:

Affiant:

:i -man am :Beverly-Jean: Romero- Hill - :New Mexican¹: known by the given-name: Beverly-Jean: (of the family) Romero, :birth: New Mexico state: © June 15^{th day}, 1958; Authorized Representative of the subrogation: BEVERLY JEAN ROMERO- HILL, :berth: NEW MEXICO @ June 15^{th date}, 1958.

The: BNP- Paribas Bank of the West. 'BNP- Paribas BOTW'. Phoenix. Arizona, and The Presentment of the Demand- :Equity- Note², 'D.E.N.',

:i- man, A.R. am writing because of the BNP- Paribas BOTW representatives here on: June 20th, 2019~A.D. in a meeting³ openly abandoned their compliance with the U.S. banking laws as described below in (b) while arguing that :i -man, A.R., et al, either accept their corporate policy in a place over the U.S. banking laws and regulations or else :i -man, A.R. would have no recourse with them, and no alternative than to execute the :right of the D.E.N.- presentment to You directly at the Federal Reserve Bank - San Francisco.

The D.E.N. is an Exempted-Security Presentment

The presentment is an obligation of the UNITED STATES government

- 1 :i -man -beneficiary- :Beverly-Jean: Romero- Hill from the 1958 A.D. birth-unto-now: July~2019 am a Civilian and not a :combatant, belligerent, or ally-of-enemy. - Trading with the Enemy Act- 1917 - TWEA, sec. 5(b) as amended within the Emergency Banking Act- 1933.**
- 2 Demand- :Equity Note: 2019-0658-001 - RE 322 404 075; 6 pages.**
- 3 Meeting attended by: Beverly-Jean: Romero- Hill - wife - and :i**

Beverly-Jean: Romero- Hill :11 July 2019 :USPS RMN. RE 322 404 067 US 1 / 3

**2022-011769 MISC Page: 1180 of 2782
09/26/2022 03:35:37 PM Receipt #: 22-9381
Rec Fee: \$30.00 Darrell James Hill
Gila County, Az, Sadie Jo Bingham, Recorder**



:Beverly-Jean: Romero- Hill c/o PO Box 3806, Apache Junction, Arizona, 85117

under the Emergency Banking Act of 1933, et seq. The D.E.N. was tendered by :i-man, A.R., the :issuer, on: June 20th, 2019~A.D., to the BNP- Paribas BOTW representatives CHRIS PRICE and AMANDA HAMILTON who first accepted and took possession of the D.E.N. presentment as a 'banking deposit' as agreed. Thenafter- the- acceptance of the D.E.N. did CHRIS PRICE and AMANDA HAMILTON reject, offered and argued for their non-acceptance of the instrument, and summarily returned-back the D.E.N. to :i-man, A.R. for their stated reasons; that: a) they did not know what a presentment is, nor b) what their legal duties or obligations are under the Emergency Banking Act of 1933, and nor c) what compliance requirements under UCC regulations governed their actions at that time.

BNP- Paribas BOTW corporation policy versus UNITED STATES law; Civilian

The BNP- Paribas BOTW representatives offered in a verbal contract that :i-man, A.R. authorize that a copy of the D.E.N. be obtained to be sent to their BNP- Paribas BOTW 'Resolutions Department' for to determine with their BNP- Paribas BOTW's 'Legal' [department] what they will say the D.E.N. says and what it means; a process the BNP- Paribas BOTW representatives reveals usually takes several weeks.

As a Civilian⁴; :i-man, A.R. did decline the BNP- Paribas BOTW representatives' offer in the discussion- unto the impasse and mutual non-agreement.

BNP- Paribas BOTW policy

The BNP- Paribas BOTW representatives stated openly that the BNP- Paribas BOTW policy authorizes them to presently ignore the UNITED STATES' legislative acts and regulations; that, if :i-man, A.R. did Not agree to their offer for the Resolution-Legal department- apparatus solely determining what is the UNITED STATES' law to be honored then, else, the only alternative is this direct presentment of the D.E.N. to You, et al., at the regional Federal Reserve Bank- San Francisco, and with a notice to the Alien Property Custodian for :i-man, :one of the living- soul- People of The United States of America.

You now upon this receipt do possess the: D.E.N. presentment and order, by the undersigning, for the authority to appropriately deposit the :demanded- equity- use currency in the amount stated into account at the bank indicated for :i-

⁴ Civilian means: i-man am a non-combatant, non-belligerent, nor ally of enemy, an :New Mexican: one of the People of The United States of America, and to the best of my present ability am compliant with the UNITED STATES' Emergency Banking Act of 1933, et seq., -Trading With The Enemy Act of 1917, as amended, with regard to the D.E.N..



1178

:Beverly-Jean: Romero- Hill c/o PO Box 3806, Apache Junction, Arizona, 85117

**Encl: Demand- :Equity Note: 2019-0658-001 – RE 322 404 075; 6 pages.
:Checking Deposit for: Beverly Jean Romero- Hill, date: 06-20-2019; 1 slip.**

**cc: :Nandita: President and Chief Executive Officer of Bank of the West Bakhshi
Chief Executive Officer of BancWest
Co-Chief Executive Officer of BNP Paribas USA Inc.
c/o :Raj: Senior Executive Vice President and Chief Risk Officer Gopal
Risk management: Corporate Headquarters
Bank of the West
180 Montgomery Street
San Francisco, California 94104**

**:William-P.: US Attorney General Barr
Alien Property Custodian: Department of Justice
950 Pennsylvania Avenue, N.W.
Washington, District of Columbia 20503-001**

**i- man verify that all stated herein is true and correct and will state same onto
the record in the open court.**



Sincerely;

**Without prejudice
BEVERLY JEAN ROMERO- HILL**

Beverly Jean Romero A.R.
:Beverly-Jean: Romero- Hill, Executor

IURAT

**Sworn to and subscribed before me now on this 11th day: July: 2019.
Produced identification: type: Arizona Driver License.**

Sandra S. Jensen
Notary

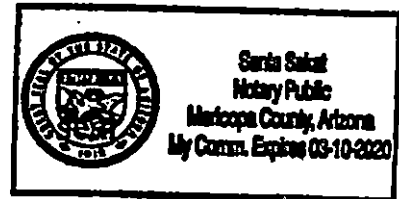

Beverly-Jean: Romero- Hill :11 July 2019 :USPS RMN: RE 322 404 075 US 3 / 3

2022-011769 MISC Page: 1182 of 2782
09/26/2022 03:35:37 PM Receipt #: 22-9381
Rec Fee: \$30.00 Darrell James Hill
Gila County, Az, Sadie Jo Bingham, Recorder

BANK OF THE WEST
BNP PARIBAS

CHECKING DEPOSIT

Some items may not be available for immediate withdrawal.

NAME Beverly Jean Romero Hill
BRANCH NAME Phoenix DATE 06/25/2019

SIGN HERE FOR LESS CASH IN TELLER'S PRESENCE

120-07282 (04/17)

CURRENCY	\$	0
COIN		0
<u>Draft</u>		<u>10,000.00</u>
TOTAL FROM OTHER SIDE		<u>0</u>
LESS CASH RECEIVED		<u>0</u>
TOTAL		<u>10,000.00</u>

ACCOUNT NUMBER



AMOUNT DEPOSITED

10 000 000.00

Beverly Jean Romero Hill, A.R. 6/25/19



⑆500 1000 15⑆

Unofficial Copy

1/180

2022-011769 MISC Page: 1183 of 2782

09/26/2022 03:35:37 PM Receipt #: 22-9381

Rec Fee: \$30.00 Darrell James Hill
Gila County, Az, Sadie Jo Bingham, Recorder



:Darrell-James: Hill, Beverly-Jean: Romero- Hill
c/o PO Box 3806, Apache Junction, Arizona, 85117

Donald: President of the UNITED STATES-, 'POTUS'-, Obligor-
:Emergency Banking Act-1933- Trump
1600 Pennsylvania Avenue NW
Washington, District of Columbia 20500

RMN: RE 322 404 212 US

:William-P: UNITED STATES ATTORNEY GENERAL-, 'USAG'-,
Alien Property Custodian Barr
950 Pennsylvania Avenue, N.W.
Washington, District of Columbia 20503-001

RMN: RE 322 404 107 US

RE: Documents addressing the UNITED STATES Emergency Banking Act of 1933 indenture dry trust, et seq.; Requests are made.

:Donald, :William-P, Greetings:

:We: Darrell and Beverly are :man and wife, and :our referenced :documents are as addressed :one for the each-one of: us addressing :our :wish and :requirement to :you the :executive- :trustees on/in the matter of the UNITED STATES Emergency Banking Act of 1933, et seq.

Your prompt compliance would be appreciated.

cc: Donald: President of the UNITED STATES-, 'POTUS',
Obligor- :Emergency Banking Act-1933- Trump
1600 Pennsylvania Avenue NW
Washington, District of Columbia 20500

RMN: RE 322 404 212 US

:i- man verify that all stated herein is true and correct and will state same onto the record in the open court.

Sincerely;

Without prejudice
DARRELL JAMES HILL

Darrell-James Hill A.R.

:Darrell-James: Hill, :man, :Executive

Without prejudice
BEVERLY JEAN ROMERO- HILL

Beverly Jean: Romero Hill A.R.

:Beverly-Jean: Romero- Hill, :man, :Executive

Darrell-James: Hill & Beverly-Jean: Romero- Hill :2

2022-011769 MISC Page: 1184 of 2782
09/26/2022 03:35:37 PM Receipt #: 22-9381
Rec Fee: \$30.00 Darrell James Hill
Gila County, Az, Sadie Jo Bingham, Recorder



Registered No. RE322404212US

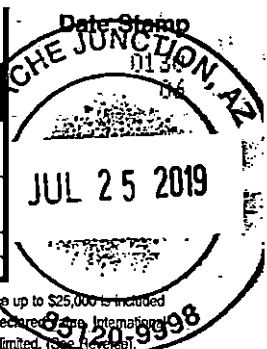

APACHE JUNCTION
151 W SUPERSTITION BLVD
APACHE JUNCTION, AZ 85120-9998
030259-0130
(800)275-8777
07/25/2019 01:40 PM

Reg. Fee \$1.45		Return Receipt Restricted Delivery
Handling Charge \$12.95		
Postage \$2.80		
Received by \$0.00	\$17.20	
Customer Must Declare Full Value \$21.00		

OFFICIAL USE

APACHE JUNCTION, AZ 85120	
FROM	Darrell-James Hill Beverly-Jean Romero Hill PO Box 3306 Apache Junction, Arizona 85117
TO	Donald: President of the UNITED STATES, 'POTUS', Deloitte Treasury Building AC 1933- Trump 1600 Pennsylvania Avenue NW Washington, District of Columbia 20500

PS Form 3806, Receipt for Registered Mail Copy 1 - Customer
May 2007 (7530-02-000-9051) (See Information on Reverse)
For domestic delivery information, visit our website at www.usps.com®

Product	Qty	Unit Price	Price
First-Class Mail® Large Envelope (Domestic) (WASHINGTON, DC 20500) (Weight:0 Lb 3.70 Oz) (Estimated Delivery Date) (Monday 07/29/2019)	1	\$1.45	\$1.45
Registered (Amount:\$21.00) (USPS Registered Mail #) (RE322404212US)			\$12.95
Return Receipt (USPS Return Receipt #) (9590940247428344639783)			\$2.80
First-Class Mail® Large Envelope (Domestic) (WASHINGTON, DC 20503) (Weight:0 Lb 3.80 Oz) (Estimated Delivery Date) (Monday 07/29/2019)	1	\$1.45	\$1.45
Registered (Amount:\$21.00) (USPS Registered Mail #) (RE322404107US)			\$12.95
Return Receipt (USPS Return Receipt #) (9590940247428344639776)			\$2.80
First-Class Mail® Letter (Domestic) (SAN FRANCISCO, CA 94105) (Weight:0 Lb 1.60 Oz) (Estimated Delivery Date) (Monday 07/29/2019)	1	\$0.70	\$0.70
Certified (USPS Certified Mail #) (70092820000395708031)			\$3.50
Return Receipt (USPS Return Receipt #) (9590940247428344639769)			\$2.80
Total:			\$41.40

Registered No. RE322404107US



Reg. Fee \$1.45		Return Receipt Restricted Delivery
Handling Charge \$12.95		
Postage \$2.80		
Received by \$0.00	\$17.20	
Customer Must Declare Full Value \$21.00		

OFFICIAL USE

APACHE JUNCTION, AZ 85120	
FROM	Darrell-James Hill Beverly-Jean Romero Hill PO Box 3306 Apache Junction, Arizona 85117
TO	William P. US Attorney General Barr Alien Property Custodian Department of Justice 950 Pennsylvania Avenue, N.W. Washington, District of Columbia 20503-001

PS Form 3806, Receipt for Registered Mail Copy 1 - Customer
May 2007 (7530-02-000-9051) (See Information on Reverse)
For domestic delivery information, visit our website at www.usps.com®

U.S. Postal Service™
CERTIFIED MAIL™ RECEIPT
(Domestic Mail Only; No Insurance Coverage Provided)

For delivery information visit our website at www.usps.com®

SAN FRANCISCO, CA 94105

OFFICIAL USE

Postage	\$7.00	0130
Certified Fee	\$2.80	06
Return Receipt Fee (Endorsement Required)	\$0.00	
Restricted Delivery Fee (Endorsement Required)	\$0.00	
Total Postage & Fees	\$9.80	

Postmark Here
07/25/2019

2620 0003 9570 8012



1182

:Darrell-James: Hill c/o PO Box 3806, Apache Junction, Arizona, 85117

"

**Arizona state
Pinal county.**

The :man :Darrell- James: Hill, personally presents before me, the undersigned Notary duly authorized by the laws of Arizona to administer oaths; now on this 25th day: July: 2019, being by me first duly sworn, on his affirmation, claimant deposes and says: - Notice to the Agent is Notice to the Principal; Notice to the Principal is Notice to the Agent:

To:

**Donald: President of the UNITED STATES-, 'POTUS'-,
Obligor- :Emergency Banking Act-1933- Trump
1600 Pennsylvania Avenue NW
Washington, District of Columbia 20500**

RMN: RE 322 404 212 US

**:William-P.: UNITED STATES ATTORNEY GENERAL-,
'USAG'-, Alien Property Custodian Barr
950 Pennsylvania Avenue, N.W.
Washington, District of Columbia 20503-001**

RMN: RE 322 404 107 US

**RE: :i- man of the people of: The United States of America, 'TheUSofA', require that
you¹, trustees of the UNITED STATES, 'U.S.', Emergency Banking Act of 1933², 'U.S.-EBA-
1933', release all -property³ and chattels^{4 5 6}; now to :i.**

:Donald, :William-P. Greetings:

- 1 **U.S.-EBA-1933: trustee obligation: You Donald: POTUS Trump are the :Commander-in Chief and the :Obligor of the U.S.-EBA-1933, and you William-P.: USAG Barr are the :Alien Property Custodian, 'APC', and the :Common law trustee of the U.S.-EBA-1933 Indenture-trust for the people of: TheUSofA.**
- 2 **The Emergency Banking Act of 1933, 'U.S.-EBA-1933' - Trading With The Enemy Act-1917, 'TWEA-1917', as amended by :U.S.-EBA-1933 is about: the trustee, the indenture-trust, debenture-bond, and the civilian declaration- condition upon the people: of The United States of America, 'TheUSofA'. The 'emergency' of the U.S.-EBA-1933 was legislatively ended in: 1976.**
- 3 **U.S.-EBA-1933: debenture bond: Developed in the 1933 U.S. Indenture trust is the debenture known commonly as the birth certificate which is a security indicative of the bond in the bond-holding program for each man-beneficiary -born of the people of: TheUSofA, managed by the APC.**
- 4 **Private Property and Chattels means: Document One - October 2016 means: USPS RMN RE 322 399 279 US, sent: October 25: 2016 A.D. to: Loretta: USAG Lynch, :delivered :October 31: 2016; return receipt number: 'RRN': 9590 9402 2073 6132 0333 58, and: et al.: 2018 A.D.**
- 5 **Private Property and Chattels means: Document 2017 Two - March 2017 means: USPS RE 322 399 251 US; sent: March 20th, 2017 A.D. to: Jeff: USAG Sessions, :delivered: April 4th, 2017; RRN: 9590 9402 2073 6132 0374 93, and: et al.: 2018 A.D.**
- 6 **Private Property and Chattels means: Document Three - September 2017 means: USPS RE 322 399 248 US; sent September 15th, 2017 A.D. to: Jeff: USAG Sessions, sent to: Jeff: USAG Sessions, :delivered: September 26th, 2017; RRN: 9590 9402 2785 7069 6401 36, and: et al.: 2018 A.D.**

Darrell-James: Hill :25 July 2019 :USPS

2022-011769 MISC Page: 1186 of 2782
09/26/2022 03:35:37 PM Receipt #: 22-9381
Rec Fee: \$30.00 Darrell James Hill
Gila County, Az, Sadie Jo Bingham, Recorder



1183

:Darrell-James: Hill c/o PO Box 3806, Apache Junction, Arizona, 85117

Thank you. **We continue to pray for you.**

[Intentionally left blank]

- 1) **i- man am :Darrell-James: Hill⁷, :one of the people of: TheUSofA, and: beneficiary of the U.S.-EBA-1933 agreement.**
 - 2) **:you- man: are executives of the U.S. corporation – government-services-provider-Trustee to the people of: TheUSofA; and: you are the executive trustees of the U.S.-EBA-1933 indenture with the people of: TheUSofA.**
 - 3) **:i- man-beneficiary inherently and privately own property that :you hold to this date: the :U.S.-EBA-1933- indenture-trust bond, and the :private- :property :you administer now without the right – See: Private Property and Chattels⁸;**
 - 4) **:i- man require all of the property-held by: you to be released to :i as prescribed by: i.**
 - 5) **:i- man wish for the Alien Property Custodian- Common law trustee to protect, insure and assure that :all of the property and rights-executed of :i- man-beneficiary a) within the U.S.-EBA-1933 indenture contract and b) within the common-law property and chattel- :in-specie⁹ holden by :you recently- 2016- now.**
 - 6) **Apart-from your meeting of the cure and relief in the cestui-que-use of the U.S.-EBA-1933 :indenture- :trust is the :immediate- :remedy required for the harm and damage from your overly-long-term holding/appearance :of-the-stealing without the documentation of the property and chattels and liquid-assets and currency specifically, and for :which the :Demand- :Equity- :Note, 'D.E.N.' is directly- deposited with the Federal Reserve Bank -San Francisco: Mary-C.¹⁰. And,**
 - 7) **:i- man- :beneficiary wish and authorize now that the man: William.-P: Alien Property Custodian- Common law trustee insure and assure that the required :D.E.N. deposited by: i- man to: Mary-C.: President Daly: Federal Reserve Bank: San Francisco, 'FRB-SF', is required from the property-held¹¹. See: 'Bank of the West' Form: [REDACTED] (04/17): Checking**
-
- 7 **Affiant. i -man- :beneficiary am :Darrell-James: Hill – :Ohioan, :birth: Ohio state: © November 20thday, 1958; Authorized Representative of the beneficiary of the inherent trust of :man under :Almighty God – where nothing exists between Almighty God and :i- man – and of the UNITED STATES, 'U.S.', government EBA-1933- :indenture- :trust :1933-2003 through the cestui-que-vie by the :idem-sonans- :subrogation: DARRELL JAMES HILL, :berth: OHIO © November 28thdate, 1958.**
 - 8 **Ibid. See: footnote: 4, 5, 6.**
 - 9 **Ibid.**
 - 10 **D.E.N. to: Mary-C. – FRB-SF means: USPS RMN: RE 322 404 067 US; sent: 11 July 2019, received: 18 July 2019; appended: 3 pages. The :circumstance necessitating of/ and the :direct presentment**
 - 11 **:Property-held means: a) the :U.S.-EBA-1933 :debenture- :bond/ b) the private-property and chattels and liquid-assets and currency. – Ibid. Footnote: 4, 5, 6.**

Darrell-James: Hill :25 July 2019 :USPS RMN: RE 322 404 107 US

2 / 4

1184

2022-011769 MISC Page: 1187 of 2782
09/26/2022 03:35:37 PM Receipt #: 22-9381
Rec Fee: \$30.00 Darrell James Hill
Gila County, Az, Sadie Jo Bingham, Recorder



:Darrell-James: Hill c/o PO Box 3806, Apache Junction, Arizona, 85117

Deposit- slip completed and authorized to the account and for the amount authorised and required by :i- man-beneficiary in the D.E.N., appended: 1 slip (stapled to a sheet).

- 8) :i- man believe the :U.S. Trustee(s) are to be :Not-in-a-competition with :i- man-beneficiary for this :property- :claimed.
- 9) The: 'emergency' of the U.S.-EBA-1933 - indenture-trust¹², was legislatively ended in: 1976.
- 10) The U.S.-EBA-1933 - indenture- trust- :obligation upon the people-debentured under the agreement ended in: 2003 A.D. And, now,
- 11) :i- man believe that the U.S.-EBA-1933 -:indenture is now a dry trust.
- 12) The :U.S.-EBA-1933 amended¹³ the Trading With The Enemy Act, 'TWEA-1917'.
- 13) The: 'enemy condition' of the TWEA-1917, as amended by: U.S.-EBA-1933 describes :i- man-beneficiary as a 'civilian: not combatant, not belligerent, not ally-of-enemy'.
- 14) :i- man's a) identification by the authenticated debenture certificate and b) the :civilian- :declaration in the Jurat- affidavit was delivered to you: Donald: POTUS - Commander- Obligor Trump, USPS RMN: RE 322 404 098 US and William -P.: USAG- APC Barr, USPS RMN: RE 322 404 084 US. And:
- 15) i- man do not consent to the any further U.S.-EBA-1933 Trustee, et al. agents use of :this or any other diffuse- systemic -enemy- non-civilian- presumption that implements threatening and/or injuring onto :i- man-beneficiary, et al.
- 16) :i- man-beneficiary require the :U.S. Commander and Trustee, et al. of the :U.S.-EBA-1933 - :indenture to act under the fidelity of their oath, duty and obligation to the UNITED STATES Constitution under :'The Constitution for the United States of America' for the absolute benefit to :i -man-beneficiary.
- 18) :i- man require the :Common- law- trustee of the U.S.-EBA-1933 - :indenture to act under the fidelity for the absolute benefit of :i- man, and specifically for the a) :assurance of the D.E.N. and b) the emergent release of :all of the other property and chattel and liquid assets and currency holden by :you most recently: 2016 - now.

The identification of :i-man :Darrell-James, of the family Hill is clear, the :civilian declaration is firm, and the :property and chattel and liquid assets and currency requirements are certain. :The- all that remains to be elucidated now is the :strength of

12 U.S.-EBA-1933: the indenture: In :1933 A.D. the 1933 U.S.- corporation- government-services-provider, et al., wholly indentured itself by the U.S.-EBA-1933 to the people of: TheUSofA, contracting a :trusteeship over all of the people's national property then-to-fore as the collateral for a purported-emergent U.S. bankruptcy-condition, and a new deal. Thereupon, and therein 1933, et seq., the :people acquiesced to the U.S. trust- :indenture and to the 'New Deal' of that time. **The indenture of the U.S.-EBA-1933 ended in March 2003.**

13 The :enemy-condition, :civilian declaration: The TWEA-1917, as amended by: EBA-1933 began and continues to presume that the people of: TheUSofA are the presumed-enemy of the U.S.- corporate-operations- failings in the 1927- 1933 A.D.- :U.S. -Federal Reserve Banking System, thereby justifying placing the :people of: TheUSofA under the military- :rule under the U.S. -Lieber code, as amended; meaning, that :each-man of the people of: TheUSofA, in :order to meet the :condition of the 'civilian' -declaration, must proactively affirm in the writing to the U.S. trustees that they man-beneficiary are 'civilian': not combatant, not belligerent, not ally-of-enemy.

Darrell-James: Hill :25 July 2019 :USPS RM

2022-011769 MISC Page: 1188 of 2782
09/26/2022 03:35:37 PM Receipt #: 22-9381
Rec Fee: \$30.00 Darrell James Hill
Gila County, Az, Sadie Jo Bingham, Recorder



:Darrell-James: Hill c/o PO Box 3806, Apache Junction, Arizona, 85117

the integrity of the man :Donald: President- Commander - Obligor- Trustee and of the man :William-P: USAG- Alien Property Custodian and Common law trustee Barr.

cc: **Donald: President of the UNITED STATES-, 'POTUS'-,**
Obligor- :Emergency Banking Act-1933- Trump
1600 Pennsylvania Avenue NW
Washington, District of Columbia 20500

RMN: RE 322 404 212 US

:Mary-C.: President Daly
Federal Reserve Bank: San Francisco
101 Market Street
San Francisco, California 94105

CMN: 7009 2820 0003
9570 8031

"
:i- man verify that all stated herein is true and correct and will state same onto the record in the open court.

Sincerely;

Without prejudice
DARRELL JAMES HILL

:Darrell-James: Hill, :A. R. Executor

IURAT

Sworn to and subscribed before me now on this 25th day: July: 2019.
Produced identification: type: Arizona Driver License.

Dominic Stewart
Notary

seal

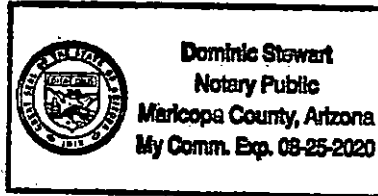

Darrell-James: Hill :25 July 2019 :USPS RMN: RE 322 404 107 US

4 / 4

2022-011769 MISC Page: 1189 of 2782
09/26/2022 03:35:37 PM Receipt #: 22-9381
Rec Fee: \$30.00 Darrell James Hill
Gila County, Az, Sadie Jo Bingham, Recorder



Handwritten notes and signatures in the bottom left corner.

:Darrell-James: Hill c/o PO Box 3806, Apache Junction, Arizona, 85117

Arizona state
Pinal county.

:Man :Darrell- James: Hill personally presents before me, the undersigned Notary duly authorized by the laws of Arizona to administer oaths; now on this 11th day: July: 2019, being by me first duly sworn, on his affirmation, claimant deposes and says: - Notice to the Agent is Notice to the Principal; Notice to the Principal is Notice to the Agent.

:Mary-C.: President Daly
Federal Reserve Bank: San Francisco
101 Market Street :
San Francisco, California 94105

USPS RMN: RE 322 404 067 US

:Mary-C., Greetings:

Affiant:

:i -man am :Darrell-James: Hill - :Ohioan¹: known by the given-name: Darrell-James: (of the family) Hill, :birth: Ohio state: © November 20th day, 1958; Authorized Representative of the subrogation: DARRELL JAMES HILL, :berth: OHIO @ November 28th date, 1958.

The: BNP- Paribas Bank of the West, 'BNP- Paribas BOTW', Phoenix, Arizona, and The Presentment of the Demand- :Equity- Note², 'D.E.N.',

:i- man, A.R. am writing because of the BNP- Paribas BOTW representatives here on: June 20th, 2019~A.D. in a meeting³ openly abandoned their compliance with the U.S. banking laws as described below in (b) while arguing that :i -man, A.R., et al., either accept their corporate policy in a place over the U.S. banking laws and regulations or else :i -man, A.R. would have no recourse with them, and no alternative than to execute the :right of the D.E.N.- presentment to You directly at the Federal Reserve Bank - San Francisco.

The D.E.N. is an Exempted-Security Presentment

The presentment is an obligation of the UNITED STATES government

- 1 :i -man -beneficiary- :Darrell-James: Hill from the 1958 A.D. birth-unto-now: July~2019 am a Civilian and not a :combatant, belligerent, or ally-of-enemy. - Trading with the Enemy Act- 1917 - TWEA, sec. 5(b) as amended within the Emergency Banking Act- 1933.
- 2 Demand- :Equity Note: 2019-1158-001 - RE 322 404 067; 9 pages.
- 3 Meeting attended by: Beverly-Jean: Romero- Hill - wife - and :i

Darrell-James: Hill :11 July 2019 :USPS RMN: RE 322 404 067 US

1 / 3

2022-011769 MISC Page: 1190 of 2782
09/26/2022 03:35:37 PM Receipt #: 22-9381
Rec Fee: \$30.00 Darrell James Hill
Gila County, Az, Sadie Jo Bingham, Recorder



1187

:Darrell-James: Hill c/o PO Box 3806, Apache Junction, Arizona, 85117

under the Emergency Banking Act of 1933, et seq. The D.E.N. was tendered by i-man, A.R., the issuer, on: June 20th, 2019~A.D., to the BNP- Paribas BOTW representatives CHRIS PRICE and AMANDA HAMILTON who first accepted and took possession of the D.E.N. presentment as a 'banking deposit' as agreed. Thenafter- the- acceptance of the D.E.N. did CHRIS PRICE and AMANDA HAMILTON reject, offered and argued for their non-acceptance of the instrument, and summarily returned-back the D.E.N. to i-man, A.R. for their stated reasons; that: a) they did not know what a presentment is, nor b) what their legal duties or obligations are under the Emergency Banking Act of 1933, and nor c) what compliance requirements under UCC regulations governed their actions at that time.

BNP- Paribas BOTW corporation policy versus UNITED STATES law: Civilian

The BNP- Paribas BOTW representatives offered in a verbal contract that i-man, A.R. authorize that a copy of the D.E.N. be obtained to be sent to their BNP- Paribas BOTW 'Resolutions Department' for to determine with their BNP- Paribas BOTW's 'Legal' [department] what they will say the D.E.N. says and what it means; a process the BNP- Paribas BOTW representatives reveals usually takes several weeks.

As a Civilian⁴, i-man, A.R. did decline the BNP- Paribas BOTW representatives' offer in the discussion unto the impasse and mutual non-agreement.

BNP- Paribas BOTW policy

The BNP- Paribas BOTW representatives stated openly that the BNP- Paribas BOTW policy authorizes them to presently ignore the UNITED STATES' legislative acts and regulations; that, if i-man, A.R. did Not agree to their offer for the Resolution-Legal department- apparatus solely determining what is the UNITED STATES' law to be honored then, else, the only alternative is this direct presentment of the D.E.N. to You, et al., at the regional Federal Reserve Bank- San Francisco, and with a notice to the Alien Property Custodian for i-man, one of the living- soul- People of The United States of America.

You now upon this receipt do possess the: D.E.N. presentment and order, by the undersigning, for the authority to appropriately deposit the :demanded-equity- use currency in the amount stated into account at the bank indicated for i-

4 Civilian means: i-man am a non-combatant, non-belligerent, nor ally of enemy, an :Ohioan: one of the People of The United States of America, and to the best of my present ability am compliant with the UNITED STATES' Emergency Banking Act of 1933, et seq., -Trading With The Enemy Act of 1917, as amended, with regard to the D.E.N.

Darrell-James: Hill :11 July 2019 :USPS RMN: RE 322 404 067 US 2 / 3

**2022-011769 MISC Page: 1191 of 2782
09/26/2022 03:35:37 PM Receipt #: 22-9381
Rec Fee: \$30.00 Darrell James Hill
Gila County, Az, Sadie Jo Bingham, Recorder**



1188

:Darrell-James: Hill c/o PO Box 3806, Apache Junction, Arizona, 85117

**Encl: Demand- :Equity Note: 2019-1158-001 - RE 322 404 067; 9 pages.
:Checking Deposit for: Darrell James Hill, date: 06-20-2019; 1 slip.**

**cc: :Nandita: President and Chief Executive Officer of Bank of the West Bakhshi
Chief Executive Officer of BancWest
Co-Chief Executive Officer of BNP Paribas USA Inc.
c/o :Raj: Senior Executive Vice President and Chief Risk Officer Gopal
Risk management: Corporate Headquarters
Bank of the West
180 Montgomery Street
San Francisco, California 94104**

**:William-P: US Attorney General Barr
Alien Property Custodian: Department of Justice
950 Pennsylvania Avenue, N.W.
Washington, District of Columbia 20503-001**

**:i- man verify that all stated herein is true and correct and will state same onto
the record in the open court.**

Sincerely;

**Without prejudice
DARRELL JAMES HILL**

:Darrell - James Hill A.R.

:Darrell-James: Hill, :man

IURAT

**Sworn to and subscribed before me new on this 11th day: July: 2019.
Produced identification: type: Arizona Driver License.**

***[Signature]*
Notary**

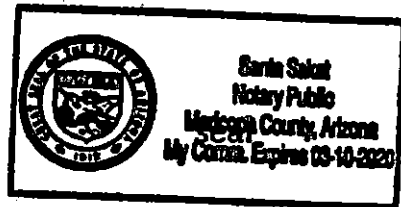

Darrell-James: Hill :11 July 2019 :USPS RMN: RE 322 404 067 US

3 / 3

**2022-011769 MISC Page: 1192 of 2782
09/26/2022 03:35:37 PM Receipt #: 22-9981
Rec Fee: \$30.00 Darrell James Hill
Gila County, Az, Sadie Jo Bingham, Recorder**



1189



BANK OF THE WEST
BNP PARIBAS

CHECKING DEPOSIT

Deposits may not be available for immediate withdrawal.

NAME Darrell James Hill

BRANCH NAME Phoenix

DATE 06-20-2019

SIGN HERE FOR LESS CASH IN TELLER'S PRESENCE

120-07262 (04/17)

CURRENCY	\$	<u>0</u>
COIN		<u>0</u>
<u>Draft</u>		<u>10,000,000.00</u>
		<u>0</u>
TOTAL FROM OTHER SIDE		<u>0</u>
LESS CASH RECEIVED		<u>0</u>
TOTAL		<u>10,000,000.00</u>

ACCOUNT NUMBER



AMOUNT DEPOSITED

\$ 10,000,000.00

Darrell James Hill 6/25/2019



⑆500 1000 15⑆

Unofficial Copy

1190

2022-011769 MISC Page: 1193 of 2782

09/26/2022 03:35:37 PM Receipt #: 22-9381

Rec Fee: \$30.00 Darrell James Hill

Gila County, Az, Sadie Jo Bingham, Recorder



:Beverly-Jean: Romero- Hill c/o PO Box 3806, Apache Junction, Arizona, 85117

Arizona state
Pinal county.

The :man :Beverly-Jean: Romero- Hill, personally presents before me, the undersigned Notary duly authorized by the laws of Arizona to administer oaths; now on this 25th day: July: 2019, being by me first duly sworn, on his affirmation, claimant deposes and says: – Notice to the Agent is Notice to the Principal; Notice to the Principal is Notice to the Agent:

To:

Donald: President of the UNITED STATES-, 'POTUS'-,
Obligor- :Emergency Banking Act-1933- Trump
1600 Pennsylvania Avenue NW
Washington, District of Columbia 20500

RMN: RE 322 404 212 US

:William-P: UNITED STATES ATTORNEY GENERAL-,
'USAG'-, Alien Property Custodian Barr
950 Pennsylvania Avenue, N.W.
Washington, District of Columbia 20503-001

RMN: RE 322 404 107 US

RE: :i- man of the people of: The United States of America, 'TheUSofA', require that you¹, trustees of the UNITED STATES, 'U.S.', Emergency Banking Act of 1933², 'U.S.-EBA-1933', release all -property and chattels; now to :i.

:Donald. :William-P. Greetings:

Thank you. We continue to pray for you.

- 1) :i- man am :Beverly-Jean: Romero- Hill³, :one of the people of: TheUSofA, and: beneficiary of the U.S.-EBA-1933 agreement.
- 2) :you- man: are executives of the U.S. corporation – government-services-provider-Trustee to the people of: TheUSofA; and: you are the executive trustees of the U.S.-EBA-1933 indenture with the people of: TheUSofA.

- 1 U.S.-EBA-1933: trustee obligation: You Donald:POTUS Trump are the :Commander-in Chief and the :Obligor of the U.S.-EBA-1933, and you William-P: USAG Barr are the :Alien Property Custodian, 'APC', and the :Common law trustee of the U.S.-EBA-1933 Indenture-trust for the people of: TheUSofA.
- 2 The Emergency Banking Act of 1933, 'U.S.-EBA-1933' – Trading With The Enemy Act-1917, 'TWEA-1917', as amended by :U.S.-EBA-1933 is about: the trustee, the indenture-trust, debenture-bond, and the civilian declaration- condition upon the people: of The United States of America, 'TheUSofA'. The 'emergency' of the U.S.-EBA-1933 was legislatively ended in: 1976.
- 3 Affiant. i -man- :beneficiary am :Beverly-Jean: Romero- Hill – :New Mexican, :birth: New Mexico state: © June 15th day, 1958; Authorized Representative of the beneficiary of the inherent trust of :man under :Almighty God – where nothing exists between Almighty God and :i- man – and of the UNITED STATES, 'U.S.', government EBA-1933- :indenture- :trust :1933-2003 through the cestui-que-vie by the :idem-sonans- :subrogation: BEVERLY JEAN ROMERO, :berth: NEW MEXICO @ June 15th date, 1958.

Beverly-Jean: Romero- Hill :25 July 2019 :US

2022-011769 MISC Page: 1194 of 2782
09/26/2022 03:35:37 PM Receipt #: 22-9381
Rec Fee: \$30.00 Darrell James Hill
Gila County, Az, Sadie Jo Bingham, Recorder



:Beverly-Jean: Romero- Hill c/o PO Box 3806, Apache Junction, Arizona, 85117

- 4) **:i- man require all of the property-held by: you to be released to :i as prescribed by: i.**
- 5) **:i- man wish for the Alien Property Custodian- Common law trustee to protect, insure and assure that :all of the property and rights-executed of :i- man-beneficiary within the U.S.-EBA-1933 indenture contract specifically, and for :which the :Demand- :Equity- :Note, 'D.E.N.' is directly- deposited with the Federal Reserve Bank -San Francisco: Mary-C.⁴. And,**
- 7) **:i- man- :beneficiary wish and authorize now that the man: William.-P.: Alien Property Custodian- Common law trustee insure and assure that the required :D.E.N. deposited by: i- man to: Mary-C.: President Daly: Federal Reserve Bank: San Francisco, 'FRB-SF', is required from the property-held⁵. See: 'Bank of the West' Form: [REDACTED] (07/17): Checking Deposit- slip completed and authorized to the account and for the amount authorised and required by :i- man-beneficiary in the D.E.N., appended: 1 slip (stapled to a sheet).**
- 8) **:i- man believe the :U.S. Trustee(s) are to be :Not-in-a-competition with :i- man-beneficiary for this :property- :claimed.**
- 9) **The: 'emergency' of the U.S.-EBA-1933- indenture-trust⁶, was legislatively ended in: 1976.**
- 10) **The U.S.-EBA-1933 - indenture- trust-:obligation upon the people-debentured under the agreement ended in: 2003 A.D. And, now,**
- 11) **:i- man believe that the U.S.-EBA-1933 -:indenture is now a dry trust.**
- 12) **The :U.S.-EBA-1933 amended⁷ the Trading With The Enemy Act, 'TWEA-1917'.**
- 13) **The: 'enemy condition' of the TWEA-1917, as amended by: U.S.-EBA-1933 describes :i- man-beneficiary as a 'civilian: not combatant, not belligerent, not ally-of-enemy'.**
- 14) **:i- man's a) identification by the authenticated debenture certificate and b) the :civilian- :declaration in the Jurat- affidavit was delivered to you: Donald: POTUS - Commander- Obligor Trump, USPS RMN: RE 322 404 098 US and William -P.: USAG- APC Barr, USPS RMN: RE 322 404 084 US. And:**
- 15) **i- man do not consent to the any further U.S.-EBA-1933 Trustee, et al. agents use of :this or any other diffuse- systemic -enemy- non-civilian- presumption that implements threatening and/or injuring onto :i- man-beneficiary, et al.**

4 D.E.N. to: Mary-C. - FRB-SF means: USPS RMN: RE 322 404 067 US; sent: 11 July 2019, received: 18 July 2019: appended: 3 pages. The :circumstance necessitating of/ and the :direct presentment

5 :Property-held means: the :U.S.-EBA-1933 :debenture- :bond.

6 U.S.-EBA-1933: the indenture: In :1933 A.D. the 1933 U.S.- corporation- government-services-provider, et al., wholly indentured itself by the U.S.-EBA-1933 to the people of: TheUSofA, contracting a :trusteeship over all of the people's national property then-to-fore as the collateral for a purported-emergent U.S. bankruptcy-condition, and a new deal. Thereupon, and therein 1933, et seq., the :people acquiesced to the U.S. trust- :indenture and to the 'New Deal' of that time. The indenture of the U.S.-EBA-1933 ended in March 2003.

7 The :enemy-condition, :civilian declaration: The TWEA-1917, as amended by: EBA-1933 began and continues to presume that the people of: TheUSofA are the presumed-enemy of the U.S.- corporate-operations- failings in the 1927- 1933 A.D.- :U.S. -Federal Reserve Banking System, thereby justifying placing the :people of: TheUSofA under the military- :rule under the U.S. -Lieber code, as amended; meaning, that :each-man of the people of: TheUSofA, in :order to meet the :condition of the 'civilian' -declaration, must proactively affirm in the writing to the U.S. trustees that they man-beneficiary are 'civilian': not combatant, not belligerent, not ally-of-enemy.

Beverly-Jean: Romero- Hill :25 July 2019 :US

1192

2022-011769 MISC Page: 1195 of 2782
09/26/2022 03:35:37 PM. Receipt #: 22-9381
Rec Fee: \$30.00 Darrell James Hill
Gila County, Az, Sadie Jo Bingham, Recorder



:Beverly-Jean: Romero- Hill c/o PO Box 3806, Apache Junction, Arizona, 85117

16) :i- man-beneficiary require the :U.S. Commander and Trustee, et al. of the :U.S.-EBA-1933 - :indenture to act under the fidelity of their oath, duty and obligation to the UNITED STATES Constitution under : 'The Constitution for the United States of America' for the absolute benefit to :i- man-beneficiary.

18) :i- man require the :Common- law- trustee of the U.S.-EBA-1933 - :indenture to act under the fidelity for the absolute benefit of :i- man, and specifically for the a) :assurance of the D.E.N. and b) the emergent release of :all of the other property and chattel and liquid assets and currency holden by :you most recently: 2016 - now.

The identification of :i- man :Beverly-Jean, of the family Romero- Hill is clear, the :civilian declaration is firm, and the :property is certain. :The- all that remains to be elucidated now is the :strength of the integrity of the man :Donald: President- Commander - Obligor- Trustee and of the man :William-P.: USAG- Alien Property Custodian and Common law trustee Barr.

cc: **Donald: President of the UNITED STATES-, 'POTUS',**
Obligor- :Emergency Banking Act-1933- Trump
1600 Pennsylvania Avenue NW
Washington, District of Columbia 20500

RMN: RE 322 404 212 US

:Mary-C.: President Daly
Federal Reserve Bank: San Francisco
101 Market Street
San Francisco, California 94105

CMN: 7009 2820 0003 9570
8031

"
:i- man verify that all stated herein is true and correct and will state same onto the record in the open court.

Sincerely,

Without prejudice

BEVERLY JEAN ROMERO- HILL

Beverly Jean Romero Hill, A.R.
:Beverly-Jean: Romero- Hill, :man, :attor

IURAT

Sworn to and subscribed before me now on this 25th day: July: 2019.

Produced identification: type: Arizona Driver License.

Dominic Stewart
Notary

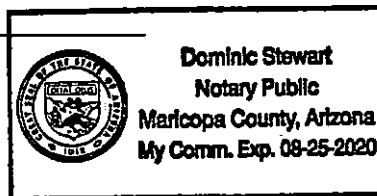

seal

Beverly-Jean: Romero- Hill :25 July 2019 :USPS RMN: RE 322 404 107 US

3 / 3

2022-011769 MISC Page: 1196 of 2782
09/26/2022 03:35:37 PM Receipt #: 22-9381
Rec Fee: \$30.00 Darrell James Hill
Gila County, Az, Sadie Jo Bingham, Recorder



:Beverly-Jean: Romero- Hill c/o PO Box 3806, Apache Junction, Arizona, 85117

**Arizona state
Pinal county.**

:Man :Beverly-Jean: Romero- Hill personally presents before me, the undersigned Notary duly authorized by the laws of Arizona to administer oaths; now on this 11th day: July: 2019, being by me first duly sworn, on his affirmation, claimant deposes and says: - Notice to the Agent is Notice to the Principal; Notice to the Principal is Notice to the Agent.

**:Mary-C.: President Daly
Federal Reserve Bank: San Francisco
101 Market Street
San Francisco, California 94105**

USPS RMN: RE 322 404 067 US

:Mary-C., Greetings:

Affiant:

:i -man am :Beverly-Jean: Romero- Hill - :New Mexican¹: known by the given-name: Beverly-Jean: (of the family) Romero, :birth: New Mexico state: © June 15^{th day}, 1958; Authorized Representative of the subrogation: BEVERLY JEAN ROMERO- HILL, :berth: NEW MEXICO @ June 15^{th date}, 1958.

The: BNP- Paribas Bank of the West. 'BNP- Paribas BOTW', Phoenix, Arizona, and The Presentment of the Demand- :Equity- Note², 'D.E.N.',

:i- man, A.R. am writing because of the BNP- Paribas BOTW representatives here on: June 20th, 2019~A.D. in a meeting³ openly abandoned their compliance with the U.S. banking laws as described below in (b) while arguing that :i -man, A.R., et al., either accept their corporate policy in a place over the U.S. banking laws and regulations or else :i -man, A.R. would have no recourse with them, and no alternative than to execute the :right of the D.E.N.- presentment to You directly at the Federal Reserve Bank - San Francisco.

The D.E.N. is an Exempted-Security Presentment

The presentment is an obligation of the UNITED STATES government

- 1 :i -man -beneficiary- :Beverly-Jean: Romero- Hill from the 1958 A.D. birth-unto-now: July~2019 am a Civilian and not a :combatant, belligerent, or ally-of-enemy. - Trading with the Enemy Act- 1917 - TWEA, sec. 5(b) as amended within the Emergency Banking Act- 1933.**
- 2 Demand- :Equity Note: 2019-0658-001 - RE 322 404 075; 6 pages.**
- 3 Meeting attended by: Beverly-Jean: Romero- Hill - wife - and :i**

Beverly-Jean: Romero- Hill :11 July 2019 :USPS RMN: RE 322 404 067 US 1 / 3

2022-011769 MISC Page: 1197 of 2782
09/26/2022 03:35:37 PM Receipt #: 22-9381
Rec Fee: \$30.00 Darrell James Hill
Gila County, Az, Sadie Jo Bingham, Recorder



1194

:Beverly-Jean: Romero- Hill c/o PO Box 3806, Apache Junction, Arizona, 85117

under the Emergency Banking Act of 1933, et seq. The D.E.N. was tendered by :i- man, A.R., the :issuer, on: June 20th, 2019~A.D., to the BNP- Paribas BOTW representatives CHRIS PRICE and AMANDA HAMILTON who first accepted and took possession of the D.E.N. presentment as a 'banking deposit' as agreed. Thenafter- the- acceptance of the D.E.N. did CHRIS PRICE and AMANDA HAMILTON reject, offered and argued for their non-acceptance of the instrument, and summarily returned-back the D.E.N. to :i- man, A.R. for their stated reasons; that: a) they did not know what a presentment is, nor b) what their legal duties or obligations are under the Emergency Banking Act of 1933, and nor c) what compliance requirements under UCC regulations governed their actions at that time.

BNP- Paribas BOTW corporation policy versus UNITED STATES law: Civilian

The BNP- Paribas BOTW representatives offered in a verbal contract that :i- man, A.R. authorize that a copy of the D.E.N. be obtained to be sent to their BNP- Paribas BOTW 'Resolutions Department' for to determine with their BNP- Paribas BOTW's 'Legal' [department] what they will say the D.E.N. says and what it means; a process the BNP- Paribas BOTW representatives reveals usually takes several weeks.

As a Civilian⁴, :i- man, A.R. did decline the BNP- Paribas BOTW representatives' offer in the discussion, unto the impasse and mutual non-agreement.

BNP- Paribas BOTW policy

The BNP- Paribas BOTW representatives stated openly that the BNP- Paribas BOTW policy authorizes them to presently ignore the UNITED STATES' legislative acts and regulations; that, if :i- man, A.R. did Not agree to their offer for the Resolution-Legal department- apparatus solely determining what is the UNITED STATES' law to be honored then, else, the only alternative is this direct presentment of the D.E.N. to You, et al., at the regional Federal Reserve Bank- San Francisco, and with a notice to the Alien Property Custodian for :i- man, :one of the living- soul- People of The United States of America.

You now upon this receipt do possess the: D.E.N. presentment and order, by the undersigning, for the authority to appropriately deposit the :demanded- equity- use currency in the amount stated into account at the bank indicated for :i- man.

⁴ Civilian means: i- man am a non-combatant, non-belligerent, nor ally of enemy, an :New Mexican: one of the People of The United States of America, and to the best of my present ability am compliant with the UNITED STATES' Emergency Banking Act of 1933, et seq., -Trading With The Enemy Act of 1917, as amended, with regard to the D.E.N.

Beverly-Jean: Romero- Hill :11 July 2019 :USPS RMN- RR 322 404 067 HS 2 / 2

2022-011769 MISC Page: 1198 of 2782
09/26/2022 03:35:37 PM Receipt #: 22-9381
Rec Fee: \$30.00 Darrell James Hill
Gila County, Az, Sadie Jo Bingham, Recorder



:Beverly-Jean: Romero- Hill c/o PO Box 3806, Apache Junction, Arizona, 85117

**Encl: Demand- :Equity Note: 2019-0658-001 - RE 322 404 075; 6 pages.
:Checking Deposit for: Beverly Jean Romero- Hill, date: 06-20-2019; 1 slip.**

**cc: :Nandita: President and Chief Executive Officer of Bank of the West Bakhshi
Chief Executive Officer of BancWest
Co-Chief Executive Officer of BNP Paribas USA Inc.
c/o :Raj: Senior Executive Vice President and Chief Risk Officer Gopal
Risk management: Corporate Headquarters
Bank of the West
180 Montgomery Street
San Francisco, California 94104**

**:William-P: US Attorney General Barr
Alien Property Custodian: Department of Justice
950 Pennsylvania Avenue, N.W.
Washington, District of Columbia 20503-001**

**:I- man verify that all stated herein is true and correct and will state same onto
the record in the open court.**



Sincerely;
Without prejudice
BEVERLY JEAN ROMERO- HILL
Beverly Jean Romero **A.R**
:Beverly-Jean: Romero- Hill, Executor

IURAT

**Sworn to and subscribed before me now on this 11th day: July: 2019.
Produced identification: type: Arizona Driver License.**

Sandra S. Sander
Notary

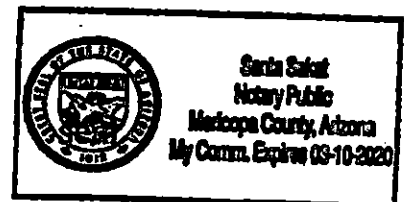

Beverly-Jean: Romero- Hill :11 July 2019 :USPS RMN: RE 322 404 075 US 3 / 3

**2022-011769 MISC Page: 1199 of 2782
09/26/2022 03:35:37 PM Receipt #: 22-9381
Rec Fee: \$30.00 Darrell James Hill
Gila County, Az, Sadie Jo Bingham, Recorder**





BANK OF THE WEST
BNP PARIBAS

CHECKING DEPOSIT

Amount may not be available for immediate withdrawal.

NAME Beverly Jean Romero-Hill
BRANCH NAME Phoenix DATE 06/25/2019

SIGN HERE FOR LESS CASH IN TELLER'S PRESENCE

ACCOUNT NUMBER

120-07282 (04/17)

CURRENCY	\$	0
COIN		0
DAFT		10,000,000.00
TOTAL FROM OTHER SIDE		0
LESS CASH RECEIVED		0
TOTAL		10,000,000.00



AMOUNT DEPOSITED

10 000 000.00

⑆500100015⑆

Beverly Jean Romero-Hill, A.R. 6/25/19



Unofficial Copy

1197

2022-011769 MISC Page: 1200 of 2782
09/26/2022 03:35:37 PM Receipt #: 22-9381
Rec Fee: \$30.00 Darrell James Hill
Gila County, Az, Sadie Jo Bingham, Recorder



Darrell-James: Hill, Beverly-Jean: Romero- Hill
c/o PO Box 3806, Apache Junction, Arizona, 85117

Mary-C.: President Daly
Federal Reserve Bank: San Francisco
101 Market Street
San Francisco, California 94105

CMN: 7009 2820 0003 9570 8031

RE: Claim to the Trustees: Donald: Obligor and William-P.: Alien Property Custodian as relates to the :D.E.N. to you: Mary-C.: USPS RMN: RE 322 404 067 US; sent: 11 July 2019, received: 18 July 2019.

Mary-C., Greetings:

We: Darrell and Beverly are :man and wife, and :our referenced :documents are further addressed, :one for the each-one of: expressing :our :wish and :requirement to the trustees on the matter of the civilian compliance and the :Demand- :Equity- :Note obligation upon the UNITED STATES Trustees under the Emergency Banking Act- 1933 indenture, et seq.

Enclosed are the documents in :content sent to the man: Donald: POTUS- :Commander- :Obligor Trump.

Your prompt compliance will be appreciated.

i- man verify that all stated herein is true and correct and will state same onto the record in the open court.

Sincerely,

Without prejudice
DARRELL JAMES HILL

Darrell-James: Hill, A.R.
:Darrell-James: Hill, :man, :Executor

Without prejudice
BEVERLY JEAN ROMERO-HILL

Beverly-Jean: Romero-Hill, A.R.
:Beverly-Jean: Romero- Hill, :man, :Executor

1198
Darrell-James: Hill & Beverly-Jean: Romero- Hill :25

2022-011769 MISC Page: 1201 of 2782
09/26/2022 03:35:37 PM Receipt #: 22-9381
Rec Fee: \$30.00 Darrell James Hill
Gila County, Az, Sadie Jo Bingham, Recorder



Registered No. RE322404212US

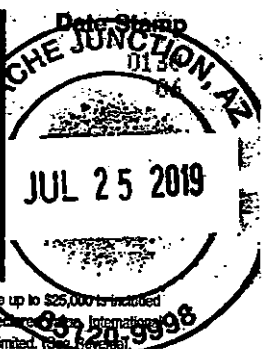

Reg. Fee	\$1.45	
Handling Charge	\$12.95	Return Receipt
Postage	\$2.80	Restricted Delivery
	\$0.00	
Received by	\$0.00	
		\$17.20

Customer Must Declare Full Value \$21.00 07/25/2019 Domestic Insurance up to \$25,000 is included based upon the declared value. Information on Indemnity is limited. (See Reverse)

OFFICIAL USE

APACHE JUNCTION, AZ 85120

FROM

Darrell James Hill
Sadie Jo Bingham - Hill
PO Box 3806
Apache Junction, Arizona 85117

TO

Donald President of the UNITED STATES - "TRUMP"
OFFICE OF THE PRESIDENT
1600 Pennsylvania Avenue NW
Washington, District of Columbia 20500

PS Form 3806, Receipt for Registered Mail Copy 1 - Customer
May 2007 (7530-02-000-9051) (See Information on Reverse)
For domestic delivery information, visit our website at www.usps.com®

Registered No. RE322404107US



Reg. Fee	\$1.45	
Handling Charge	\$12.95	Return Receipt
Postage	\$2.80	Restricted Delivery
	\$0.00	
Received by	\$0.00	
		\$17.20

Customer Must Declare Full Value \$1.00 07/25/2019 Domestic Insurance up to \$25,000 is included based upon the declared value. Information on Indemnity is limited. (See Reverse)

OFFICIAL USE

APACHE JUNCTION, AZ 85120

FROM

Darrell James Hill
Sadie Jo Bingham - Hill
PO Box 3806
Apache Junction, Arizona 85117

TO

William P. US Attorney General Barr
Miss Property Custodian Department of Justice
950 Pennsylvania Avenue, N.W.
Washington, District of Columbia 20503-001

PS Form 3806, Receipt for Registered Mail Copy 1 - Customer
May 2007 (7530-02-000-9051) (See Information on Reverse)
For domestic delivery information, visit our website at www.usps.com®

APACHE JUNCTION
151 W SUPERSTITION BLVD
APACHE JUNCTION, AZ 85120-9998
030259-0130
(800)275-8777
07/25/2019 01:40 PM

Product	Qty	Unit Price	Price
First-Class Mail® Large Envelope (Domestic) (WASHINGTON, DC 20500) (Weight: 0 Lb 3.70 Oz) (Estimated Delivery Date) (Monday 07/29/2019)	1	\$1.45	\$1.45
Registered (Amount: \$21.00) (USPS Registered Mail #) (RE322404212US)			\$12.95
Return Receipt (USPS Return Receipt #) (9590940247428344639783)			\$2.80
First-Class Mail® Large Envelope (Domestic) (WASHINGTON, DC 20503) (Weight: 0 Lb 3.80 Oz) (Estimated Delivery Date) (Monday 07/29/2019)	1	\$1.45	\$1.45
Registered (Amount: \$21.00) (USPS Registered Mail #) (RE322404107US)			\$12.95
Return Receipt (USPS Return Receipt #) (9590940247428344639776)			\$2.80
First-Class Mail® Letter (Domestic) (SAN FRANCISCO, CA 94105) (Weight: 0 Lb 1.60 Oz) (Estimated Delivery Date) (Monday 07/29/2019)	1	\$0.70	\$0.70
Certified (USPS Certified Mail #) (70092820000395708031)			\$3.50
Return Receipt (USPS Return Receipt #) (9590940247428344639769)			\$2.80
Total:			\$41.40

U.S. Postal Service
CERTIFIED MAIL RECEIPT
(Domestic Mail Only; No Insurance Coverage Provided)
For delivery information visit our website at www.usps.com

OFFICIAL USE

Postage	\$13.50	0130
Certified Fee	\$2.80	06
Return Receipt Fee (Endorsement Required)	\$0.00	
Restricted Delivery Fee (Endorsement Required)	\$0.00	
	\$0.70	
Total Postage & Fees	\$17.00	

Postmark Here
07/25/2019

2022-011769 MISC Page: 1202 of 2782
09/26/2022 03:35:37 PM Receipt #: 22-9381
Rec Fee: \$30.00 Darrell James Hill
Gila County, Az, Sadie Jo Bingham, Recorder

1199

:Darrell-James: Hill c/o PO Box 3806, Apache Junction, Arizona, 85117

Arizona state
Pinal county.

The :man :Darrell- James: Hill, personally presents before me, the undersigned Notary duly authorized by the laws of Arizona to administer oaths; now on this 25th day: July: 2019, being by me first duly sworn, on his affirmation, claimant deposes and says: - Notice to the Agent is Notice to the Principal; Notice to the Principal is Notice to the Agent:

To:

Donald: President of the UNITED STATES-, 'POTUS'-,
Obligor- :Emergency Banking Act-1933- Trump
1600 Pennsylvania Avenue NW
Washington, District of Columbia 20500

RMN: RE 322 404 212 US

:William-P.: UNITED STATES ATTORNEY GENERAL-,
'USAG'-, Alien Property Custodian Barr
950 Pennsylvania Avenue, N.W.
Washington, District of Columbia 20503-001

RMN: RE 322 404 107 US

RE: :i- man of the people of: The United States of America, 'TheUSofA', require that you¹, trustees of the UNITED STATES, 'U.S.', Emergency Banking Act of 1933², 'U.S.-EBA-1933', release all -property³ and chattels^{4 5 6}, now to :i.

:Donald, :William-P., Greetings:

- 1 **U.S.-EBA-1933: trustee obligation:** You Donald: POTUS Trump are the :Commander-in Chief and the :Obligor of the U.S.-EBA-1933, and you William-P.: USAG Barr are the :Alien Property Custodian, 'APC', and the :Common law trustee of the U.S.-EBA-1933 Indenture-trust for the people of: TheUSofA.
- 2 The Emergency Banking Act of 1933, 'U.S.-EBA-1933' - Trading With The Enemy Act-1917, 'TWEA-1917', as amended by :U.S.-EBA-1933 is about: the trustee, the indenture-trust, debenture-bond, and the civilian declaration- condition upon the people: of The United States of America, 'TheUSofA'. The 'emergency' of the U.S.-EBA-1933 was legislatively ended in: 1976.
- 3 U.S.-EBA-1933: debenture bond: Developed in the 1933 U.S. Indenture trust is the debenture known commonly as the birth certificate which is a security indicative of the bond in the bond-holding program for each man-beneficiary -born of the people of: TheUSofA, managed by the APC.
- 4 Private Property and Chattels means: Document One - October 2016 means: USPS RMN RE 322 399 279 US, sent: October 25: 2016 A.D. to: Loretta: USAG Lynch, :delivered :October 31: 2016; return receipt number: 'RRN': 9590 9402 2073 6132 0333 58, and: et al.: 2018 A.D.
- 5 Private Property and Chattels means: Document 2017 Two - March 2017 means: USPS RE 322 399 251 US; sent: March 20th, 2017 A.D. to: Jeff: USAG Sessions, :delivered: April 4th, 2017; RRN: 9590 9402 2073 6132 0374 93, and: et al.: 2018 A.D.
- 6 Private Property and Chattels means: Document Three - September 2017 means: USPS RE 322 399 248 US; sent September 15th, 2017 A.D. to: Jeff: USAG Sessions, sent to: Jeff: USAG Sessions, :delivered: September 26th, 2017; RRN: 9590 9402 2785 7069 6401 36, and: et al.: 2018 A.D.

Darrell-James: Hill :25 July 2019 :USPS RMN

2022-011769 MISC Page: 1203 of 2782
09/26/2022 03:35:37 PM Receipt #: 22-9381
Rec Fee: \$30.00 Darrell James Hill
Gila County, Az, Sadie Jo Bingham, Recorder



1200

:Darrell-James: Hill c/o PO Box 3806, Apache Junction, Arizona, 85117

Thank you. We continue to pray for you.

[Intentionally left blank]

- 1) :i- man am :Darrell-James: Hill⁷, :one of the people of: TheUSofA, and: beneficiary of the U.S.-EBA-1933 agreement.
- 2) :you- man: are executives of the U.S. corporation - government-services-provider-Trustee to the people of: TheUSofA; and: you are the executive trustees of the U.S.-EBA-1933 indenture with the people of: TheUSofA.
- 3) :i- man-beneficiary inherently and privately own property that :you hold to this date: the :U.S.-EBA-1933- indenture-trust bond, and the :private- :property :you administer now without the right - See: Private Property and Chattels⁸;
- 4) :i- man require all of the property-held by: you to be released to :i as prescribed by: i.
- 5) :i- man wish for the Alien Property Custodian- Common law trustee to protect, insure and assure that :all of the property and rights-executed of :i- man-beneficiary a) within the U.S.-EBA-1933 indenture contract and b) within the common-law property and chattel- :in-specie⁹ holden by :you recently- 2016- now.
- 6) Apart-from your meeting of the cure and relief in the cestui-que-use of the U.S.-EBA-1933 :indenture- :trust is the :immediate- :remedy required for the harm and damage from your overly-long-term holding/appearance :of-the-stealing without the documentation of the property and chattels and liquid-assets and currency specifically, and for :which the :Demand- :Equity- :Note, 'D.E.N.' is directly- deposited with the Federal Reserve Bank -San Francisco: Mary-C.¹⁰. And,
- 7) :i- man- :beneficiary wish and authorize now that the man: William.-P.: Alien Property Custodian- Common law trustee insure and assure that the required :D.E.N. deposited by: i- man to: Mary-C.: President Daly: Federal Reserve Bank: San Francisco, 'FRB-SF', is required from the property-held¹¹. See: 'Bank of the West' Form: [REDACTED] (04/17): Checking

7 Affiant i-man-:beneficiary am :Darrell-James: Hill - :Ohioan, :birth: Ohio state: © November 20th day, 1958; Authorized Representative of the beneficiary of the inherent trust of :man under :Almighty God - where nothing exists between Almighty God and :i- man - and of the UNITED STATES, 'U.S.,' government EBA-1933- :indenture- :trust :1933-2003 through the cestui-que-vie by the :idem-sonans- :subrogation: DARRELL JAMES HILL, :berth: OHIO @ November 28th day, 1958.

8 Ibid. See: footnote: 4, 5, 6.

9 Ibid.

10 D.E.N. to: Mary-C. - FRB-SF means: USPS RMN: RE 322 404 067 US; sent: 11 July 2019, received: 18 July 2019; appended: 3 pages. The :circumstance necessitating of/ and the :direct presentment

11 :Property-held means: a) the :U.S.-EBA-1933 :debtenture- :bond/ b) the private-property and chattels and liquid-assets and currency. - Ibid. Footnote: 4, 5, 6.

Darrell-James: Hill :25 July 2019 :USPS

2022-011769 MISC Page: 1204 of 2782
09/26/2022 03:35:37 PM Receipt #: 22-9381
Rec Fee: \$30.00 Darrell James Hill
Gila County, Az, Sadie Jo Bingham, Recorder



:Darrell-James: Hill c/o PO Box 3806, Apache Junction, Arizona, 85117

Deposit- slip completed and authorized to the account and for the amount authorised and required by :i- man-beneficiary in the D.E.N., appended: 1 slip (stapled to a sheet).

8) :i- man believe the :U.S. Trustee(s) are to be :Not-in-a-competition with :i- man-beneficiary for this :property- :claimed.

9) **The: 'emergency' of the U.S.-EBA-1933 - indenture-trust¹², was legislatively ended in: 1976.**

10) **The U.S.-EBA-1933 - indenture- trust- :obligation upon the people-debentured under the agreement ended in: 2003 A.D. And, now,**

11) **:i- man believe that the U.S.-EBA-1933 -:indenture is now a dry trust.**

12) **The :U.S.-EBA-1933 amended¹³ the Trading With The Enemy Act, 'TWEA-1917'.**

13) **The: 'enemy condition' of the TWEA-1917, as amended by: U.S.-EBA-1933 describes :i- man-beneficiary as a 'civilian: not combatant, not belligerent, not ally-of-enemy'.**

14) **:i- man's a) identification by the authenticated debenture certificate and b) the :civilian- :declaration in the Jurat- affidavit was delivered to you: Donald: POTUS - Commander- Obligor Trump, USPS RMN: RE 322 404 098 US and William -P: USAG- APC Barr, USPS RMN: RE 322 404 084 US. And:**

15) **i- man do not consent to the any further U.S.-EBA-1933 Trustee, et al. agents use of :this or any other diffuse- systemic -enemy- non-civilian- presumption that implements threatening and/or injuring onto :i- man-beneficiary, et al.**

16) **:i- man-beneficiary require the :U.S. Commander and Trustee, et al. of the :U.S.-EBA-1933 - :indenture to act under the fidelity of their oath, duty and obligation to the UNITED STATES Constitution under : 'The Constitution for the United States of America' for the absolute benefit to :i -man-beneficiary.**

18) **:i- man require the :Common- law- trustee of the U.S.-EBA-1933 - :indenture to act under the fidelity for the absolute benefit of :i- man, and specifically for the a) :assurance of the D.E.N. and b) the emergent release of :all of the other property and chattel and liquid assets and currency holden by :you most recently: 2016 - now.**

The identification of :i-man :Darrell-James, of the family Hill is clear, the :civilian declaration is firm, and the :property and chattel and liquid assets and currency requirements are certain. :The- all that remains to be elucidated now is the :strength of

12 **U.S.-EBA-1933: the indenture:** In :1933 A.D. the 1933 U.S.- corporation- government-services-provider, et al., wholly indentured itself by the U.S.-EBA-1933 to the people of: TheUSofA, contracting a :trusteeship over all of the people's national property then-to-fore as the collateral for a purported-emergent U.S. bankruptcy-condition, and a new deal. Thereupon, and therein 1933, et seq., the :people acquiesced to the U.S. trust- :indenture and to the 'New Deal' of that time. **The indenture of the U.S.-EBA-1933 ended in March 2003.**

13 **The :enemy-condition, :civilian declaration:** The TWEA-1917, as amended by: EBA-1933 began and continues to presume that the people of: TheUSofA are the presumed-enemy of the U.S.- corporate-operations- failings in the 1927- 1933 A.D.- :U.S. -Federal Reserve Banking System, thereby justifying placing the :people of: TheUSofA under the military- :rule under the U.S. -Lieber code, as amended; meaning, that :each-man of the people of: TheUSofA, in :order to meet the :condition of the 'civilian' -declaration, must proactively affirm in the writing to the U.S. trustees that they man-beneficiary are 'civilian': not combatant, not belligerent, not ally-of-enemy.

Darrell-James: Hill :25 July 2019 :US

2022-011769 MISC Page: 1205 of 2782
09/26/2022 03:35:37 PM Receipt #: 22-9381
Rec Fee: \$30.00 Darrell James Hill
Gila County, Az, Sadie Jo Bingham, Recorder



1202

:Darrell-James: Hill c/o PO Box 3806, Apache Junction, Arizona, 85117

the integrity of the man :Donald: President- Commander - Obligor- Trustee and of the man :William-P: USAG- Alien Property Custodian and Common law trustee Barr.

cc: **:William-P: UNITED STATES ATTORNEY GENERAL-**
'USAG'-, Alien Property Custodian Barr
950 Pennsylvania Avenue, N.W.
Washington, District of Columbia 20503-001

RMN: RE 322 404 107 US

:Mary-C.: President Daly
Federal Reserve Bank: San Francisco
101 Market Street
San Francisco, California 94105

CMN: 7009 2820 0003
9570 8031

"
:i- man verify that all stated herein is true and correct and will state same onto the record in the open court.

Sincerely;

Without prejudice
DARRELL JAMES HILL

Darrell James Hill, H.R.

:Darrell-James: Hill, :man, :Executor

IURAT

Sworn to and subscribed before me now on this 25th day: July: 2019.
Produced identification: type: Arizona Driver License.

Dominic Stewart

Notary

seal

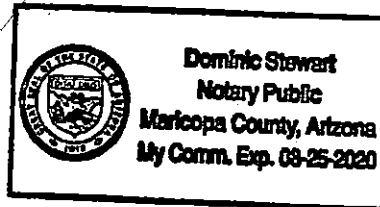

Darrell-James: Hill :25 July 2019 :USPS RMN: RE 322 404 212 US

4 / 4

2022-011769 MISC Page: 1206 of 2782
09/26/2022 03:35:37 PM Receipt #: 22-9381
Rec Fee: \$30.00 Darrell James Hill
Gila County, Az, Sadie Jo Bingham, Recorder



1203

:Beverly-Jean: Romero- Hill c/o PO Box 3806, Apache Junction, Arizona, 85117

"

Arizona state
Pinal county.

The :man :Beverly-Jean: Romero- Hill, personally presents before me, the undersigned Notary duly authorized by the laws of Arizona to administer oaths; now on this 25th day: July: 2019, being by me first duly sworn, on his affirmation, claimant deposes and says: - Notice to the Agent is Notice to the Principal; Notice to the Principal is Notice to the Agent:

To:

Donald: President of the UNITED STATES-, 'POTUS',
Obligor- :Emergency Banking Act-1933- Trump
1600 Pennsylvania Avenue NW
Washington, District of Columbia 20500

RMN: RE 322 404 212 US

:William-P: UNITED STATES ATTORNEY GENERAL-,
'USAG'-, Alien Property Custodian Barr
950 Pennsylvania Avenue, N.W.
Washington, District of Columbia 20503-001

RMN: RE 322 404 107 US

RE: :i- man of the people of: The United States of America, 'TheUSofA', require that you¹, trustees of the UNITED STATES, 'U.S.', Emergency Banking Act of 1933², 'U.S.-EBA-1933', release all -property and chattels; now to :i.

:Donald, :William-P. Greetings:

Thank you. We continue to pray for you.

- 1) :i- man am :Beverly-Jean: Romero- Hill³, :one of the people of: TheUSofA, and: beneficiary of the U.S.-EBA-1933 agreement.
- 2) :you- man: are executives of the U.S. corporation - government-services-provider-Trustee to the people of: TheUSofA; and: you are the executive trustees of the U.S.-EBA-1933 indenture with the people of: TheUSofA.

- 1 U.S.-EBA-1933: trustee obligation: You Donald:POTUS Trump are the :Commander-in Chief and the :Obligor of the U.S.-EBA-1933, and you William-P: USAG Barr are the :Alien Property Custodian, 'APC', and the :Common law trustee of the U.S.-EBA-1933 Indenture-trust for the people of: TheUSofA.
- 2 The Emergency Banking Act of 1933, 'U.S.-EBA-1933' - Trading With The Enemy Act-1917, 'TWEA-1917', as amended by :U.S.-EBA-1933 is about: the trustee, the indenture-trust, debenture-bond, and the civilian declaration- condition upon the people: of The United States of America, 'TheUSofA'. The 'emergency' of the U.S.-EBA-1933 was legislatively ended in: 1976.
- 3 Affiant i -man- :beneficiary am :Beverly-Jean: Romero- Hill - :New Mexican, :birth: New Mexico state: © June 15th day, 1958; Authorized Representative of the beneficiary of the inherent trust of :man under :Almighty God - where nothing exists between Almighty God and :i- man - and of the UNITED STATES, 'U.S.', government EBA-1933- :indenture- :trust :1933-2003 through the cestui-que-vie by the :idem-sonans- :subrogation: BEVERLY JEAN ROMERO, :berth: NEW MEXICO © June 15th date, 1958.

Beverly-Jean: Romero- Hill :25 July 2019 :USPS RMN: RE 322 404 212 US

1 / 3

2022-011769 MISC Page: 1207 of 2782
09/26/2022 03:35:37 PM Receipt #: 22-9381
Rec Fee: \$30.00 Darrell James Hill
Gila County, AZ, Sadie Jo Bingham, Recorder



1204

:Beverly-Jean: Romero- Hill c/o PO Box 3806, Apache Junction, Arizona, 85117

- 4) :i- man require all of the property-held by: you to be released to :i as prescribed by: i.
- 5) :i- man wish for the Alien Property Custodian- Common law trustee to protect, insure and assure that :all of the property and rights-executed of :i- man-beneficiary within the U.S.-EBA-1933 indenture contract specifically, and for :which the :Demand- :Equity- :Note, 'D.E.N.' is directly- deposited with the Federal Reserve Bank -San Francisco: Mary-C.⁴. And,
- 7) :i- man- :beneficiary wish and authorize now that the man: William.-P: Alien Property Custodian- Common law trustee insure and assure that the required :D.E.N. deposited by: i- man to: Mary-C.: President Daly: Federal Reserve Bank: San Francisco, 'FRB-SF', is required from the property-held⁵. See: 'Bank of the West' Form: [REDACTED] (07/17): Checking Deposit- slip completed and authorized to the account and for the amount authorised and required by :i- man-beneficiary in the D.E.N., appended: 1 slip (stapled to a sheet).
- 8) :i- man believe the :U.S. Trustee(s) are to be :Not-in-a-competition with :i- man-beneficiary for this :property- :claimed.
- 9) The: 'emergency' of the U.S.-EBA-1933 - indenture-trust⁶, was legislatively ended in: 1976.
- 10) The U.S.-EBA-1933 - indenture- trust- :obligation upon the people-debentured under the agreement ended in: 2003 A.D. And, now,
- 11) :i- man believe that the U.S.-EBA-1933 -:indenture is now a dry trust.
- 12) The :U.S.-EBA-1933 amended⁷ the Trading With The Enemy Act, 'TWEA-1917'.
- 13) The: 'enemy condition' of the TWEA-1917, as amended by: U.S.-EBA-1933 describes :i- man-beneficiary as a 'civilian: not combatant, not belligerent, not ally-of-enemy'.
- 14) :i- man's a) identification by the authenticated debenture certificate and b) the :civilian- :declaration in the Jurat- affidavit was delivered to you: Donald: POTUS - Commander- Obligor Trump, USPS RMN: RE 322 404 098 US and William -P: USAG- APC Barr, USPS RMN: RE 322 404 084 US. And:
- 15) i- man do not consent to the any further U.S.-EBA-1933 Trustee, et al. agents use of :this or any other diffuse- systemic -enemy- non-civilian- presumption that implements threatening and/or injuring onto :i- man-beneficiary, et al.

4 D.E.N. to: Mary-C. - FRB-SF means: USPS RMN: RE 322 404 067 US; sent: 11 July 2019, received: 18 July 2019: appended: 3 pages. The :circumstance necessitating of/ and the :direct presentment

5 :Property-held means: the :U.S.-EBA-1933 :debenture- :bond.

6 U.S.-EBA-1933: the indenture: In :1933 A.D. the 1933 U.S.- corporation- government-services-provider, et al., wholly indentured itself by the U.S.-EBA-1933 to the people of: TheUSofA, contracting a :trusteeship over all of the people's national property then-to-fore as the collateral for a purported-emergent U.S. bankruptcy-condition, and a new deal. Thereupon, and therein 1933, et seq., the :people acquiesced to the U.S. trust- :indenture and to the 'New Deal' of that time. The indenture of the U.S.-EBA-1933 ended in March 2003.

7 The :enemy-condition, :civilian declaration: The TWEA-1917, as amended by: EBA-1933 began and continues to presume that the people of: TheUSofA are the presumed-enemy of the U.S.- corporate-operations- failings in the 1927- 1933 A.D.- :U.S. -Federal Reserve Banking System, thereby justifying placing the :people of: TheUSofA under the military- :rule under the U.S. -Lieber code, as amended; meaning, that :each-man of the people of: TheUSofA, in :order to meet the :condition of the 'civilian' -declaration, must proactively affirm in the writing to the U.S. trustees that they man-beneficiary are 'civilian': not combatant, not belligerent, not ally-of-enemy.

Beverly-Jean: Romero- Hill :25 July 2019 :USP

1205

2022-011769 MISC Page: 1208 of 2782
09/26/2022 03:35:37 PM Receipt #: 22-9381
Rec Fee: \$30.00 Darrell James Hill
Gila County, Az, Sadie Jo Bingham, Recorder



:Beverly-Jean: Romero- Hill c/o PO Box 3806, Apache Junction, Arizona, 85117

16) :i- man-beneficiary require the :U.S. Commander and Trustee, et al. of the :U.S.-EBA-1933 - :indenture to act under the fidelity of their oath, duty and obligation to the UNITED STATES Constitution under : 'The Constitution for the United States of America' for the absolute benefit to :i- man-beneficiary.

18) :i- man require the :Common- law- trustee of the U.S.-EBA-1933 - :indenture to act under the fidelity for the absolute benefit of :i- man, and specifically for the a) :assurance of the D.E.N. and b) the emergent release of :all of the other property and chattel and liquid assets and currency holden by :you most recently: 2016 - now.

The identification of :i-man :Beverly-Jean, of the family Romero- Hill is clear, the :civilian declaration is firm, and the :property is certain. :The- all that remains to be elucidated now is the :strength of the integrity of the man :Donald: President- Commander - Obligor- Trustee and of the man :William-P: USAG- Alien Property Custodian and Common law trustee Barr.

cc: :William-P: UNITED STATES ATTORNEY GENERAL-,
'USAG', Alien Property Custodian Barr
950 Pennsylvania Avenue, N.W.
Washington, District of Columbia 20503-001

RMN: RE 322 404 107 US

:Mary-C.: President Daly
Federal Reserve Bank: San Francisco
101 Market Street
San Francisco, California 94105

CMN: 7009 2820 0003 9570
8031

:i- man verify that all stated herein is true and correct and will state same onto the record in the open court.

Sincerely;

Without prejudice

BEVERLY JEAN ROMERO- HILL

Beverly Jean Romero Hill, A.R.

:Beverly-Jean: Romero- Hill, :Executor

IURAT

Sworn to and subscribed before me now on this 25th day: July: 2019.

Produced identification: type: Arizona Driver License.

[Signature]
Notary

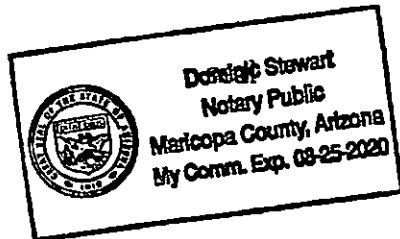

Beverly-Jean: Romero- Hill :25 July 2019 :USPS

2022-011769 MISC Page: 1209 of 2782
09/26/2022 03:35:37 PM Receipt #: 22-9381
Rec Fee: \$30.00 Darrell James Hill
Gila County, Az, Sadie Jo Bingham, Recorder



1206

Darrell-James: Hill, c/o PO Box 3806, Apache Junction, Arizona 85117

Arizona state
Pinal county

:i- the :man- :Darrell- James: Hill, now on this 1st day: August: 2019 A.D., on his affirmation, claimant deposes and says: – Notice to the Agent is Notice to the Principal; Notice to the Principal is Notice to the Agent: –

Stephen-F: Judge McCarville
Pinal County Superior Presiding Judge
PO Box 828
Florence, Arizona 85132

RE: Right of Conusance¹. The commercial court now being imposed upon the man -:Jay-Roy: Ingold in my observation is wrong-doing. The :Court of Record with the trial-by-jury to hear and try the :matters of the fact and in the law is the only righteous means to safeguard the good faith duty to the man- :Jay-Roy: Ingold, et al., and specifically, :i-man: Darrell-James: Hill, et al., – in re: the man :Jay-Roy: Ingold² involvement in the Pinal County, et al. complaint #'CV 2018 01825' - with regard to the legal but unlawful-imposition- of- injuries – done, their effort to further justify more :damage upon the man :Jay-Roy: Ingold, their effort to avoid the June 8th, 2017 contract agreed to by the Pinal- county agents, and their effort to justify more :threat-of/ :damages upon :i-man-beneficiary: Darrell-James: Hill, et al., rightful :inhabitants on the private property.

Stephen, Greetings:

a. The un-noticed change of magistrate.

:i- man believe that the man: Brenda-E.: Judge Oldham was appointed earlier to this matter. And, :i- man believe you are the man that :Jay-Roy did also write-to earlier this year: 2018 A.D. during his effort at :seeking-help with the Pinal -county -court -right, -reason, and -how-to-access-the court based-upon the after-effects that :Jay-Roy was prohibited by the Pinal- County- Superior- Court- Clerk, et al., from answering as a :man to the :allegations in a Pinal- county- commercial- complaint³; – :an :overt- :denial-of-due-process, :routine and

1 Consuance means: directly knowing the :facts, in this matter :i-man have right to speak to halt wrong-doing by public servants.

2 :Jay-Roy: Ingold means: the :man of the debenture named by the idem-sonans- subrogation: JAY ROY INGOLD, ~ @ 1962 ~ and, et al. derivative names, used as the alleged -defendant in a commercial action by the Pinal county in :their :Pinal County Superior Court complaint: 'CV 2018 01825'.

3 Prohibited ... from answering... their complaint means: In fact: 99-100% of :Jay-Roy's :documents and

Stephen-F.: McCarville USPS RMN RE 322 404 115 IIS

2022-011769 MISC Page: 1210 of 2782
09/26/2022 03:35:37 PM Receipt #: 22-9381
Rec Fee: \$30.00 Darrell James Hill
Gila County, Az, Sadie Jo Bingham, Recorder



1267

Darrell-James: Hill, c/o PO Box 3806, Apache Junction, Arizona 85117

common in :racketeering, demonstrated by :Pinal- county- officials.

b. The :Court of Record- Trial-by Jury venue for the protection of :i- man :Darrell-James: Hill, et al.

1. **:i- man am: Darrell-James: Hill⁴, :beneficiary⁵. :i- man am :Darrell-James: Hill :beneficiary of the :natural- and inherent-trusts by :Almighty- God – and, :nothing exists between the: Almighty- God and :i. Also⁶,**
2. **:i- man- :Darrell-James: Hill am a :civilian- private-property -owner.**
3. **:i- man am a :legal- :idiot, not trained :at-law, and not a member of the legal- society- club.**
4. **:i- man am a :soul- :living on the land. :i- man am a :living- :soul with a dwelling at the purportedly-same- Pinal- county- geographical- location- appointment⁷ as the :private- land- and- habitat- location⁸ where is the :Jay-Roy: Ingold, et al., natural- :home and property area.**
5. **:i- man (and :wife) are :party to a private-contract with the man: Jay-Roy: Ingold which also includes :our dwelling on the land. :i- man and :wife are in a private contract with the man: Jay-Roy: Ingold for the monitoring and care of his private land, home, chattels and other-helps since: 2015 A.D.**
6. **:i- man, et al. have the :first-hand- knowledge of the actions of the Pinal- county- agents in the matter of this trespass. :i- man have :first-hand- :knowledge of the events occurring on and about the private property owned by :Jay-Roy, since : 2015. And,**
7. **:i- man- :beneficiary affirmed by the affidavits the :injuries imposed upon :i- man in the Jay-Roy- documents-filed by :USPS Registered and Certified Mail delivery into the Pinal County Superior Court Clerk. :i- man have affirmed the violation of :i- man's right to live in peace in the :affidavits with :Jay-Roy's filings to the Pinal county court-clerk. However, the :facts of the damages imposed upon :i- man-beneficiary, et al. are reportedly ignored by**

payments sent with his answers to the Pinal- county- clerk were received then, by all who have been notified, permitted to be ignored-and-not-filed-or-otherwise-rejected by the Pinal-County-Superior-Court-Clerk trustee(s): that is, the :documents were somehow pre-adjudicated by a deputy-county clerk and serially-made- Not- filed or accepted as a man's best and good-faith answer to the only answerable document. The :230-dollar - :payments were thrice made in the form-requested by the court-clerk, and thrice were denied and sent-mutilated back to the man- :Jay-Roy. Many affidavits on these facts of the trespass: threats, trepidation, and of other damages, the truths are summarily ignored and despised as the non-professional answers in the filings demonstrate then-to-fore- - :this is an :overt- :denial-of-due-process- :routine and :racketeering by :Pinal- county- officials.

- 4 **:Darrell-James: Hill, :beneficiary means:**
- 5 **:beneficiary means: one designated for the benefit of a thing, e.g. the :cestui-que-use of a trust.**
- 6 **Also means: includes and is not limited to: a) :i- man am a :Negro- :status secured under the :Proclamation-of-Emancipation - 1862- 1863; and:
b) :i- man am :beneficiary of the UNITED-STATES government- Trustee Emergency Banking Act of 1933-,' EBA-1933, indenture with the debenture named by the idem-sonans-subrogation: DARRELL JAMES HILL @ 1958 ~ and, et al. derivative names; and:
c) Thereto: and, as relates to the 'Trading With The Enemy Act of 1917', as amended by :EBA-1933, :i- man-beneficiary am a :civilian- private- property -owner.**
- 7 **Parcel #: 103-14-012B**
- 8 **:private- land- and- habitat- location means: 5124 East 18th Avenue, Apache Junction, Arizona state territory.**

Stephen-F.: McCarville USPS RMN RE 322 404 115 US

08/01/19 2/5

2022-011769 MISC Page: 1211 of 2782
09/26/2022 03:35:37 PM Receipt #: 22-9381
Rec Fee: \$30.00 Darrell James Hill
Gila County, Az, Sadie Jo Bingham, Recorder



1208

Darrell-James: Hill, c/o PO Box 3806, Apache Junction, Arizona 85117

the Pinal county agents in their pursuit of this private- non-political- commercial-gain according to the man: Craig: Deputy- County- Attorney- Cameron's filings wherein he is asking the Pinal- county Superior Court- Clerk trustee for more collusion, even to file a :default in favor of the Pinal- county for the non- answer or response, which appears to be in competition with the trustee's duties and obligations to the people; - and,

8. :Craig asks :this favor of the very same- Pinal-County-Superior-Court-Clerk involved in the obstruction and denial-of-due-process- rights-executed by the man: Jay-Roy to answer the :claim-made by :Craig.

9. The :complaint filed by :Craig against the man- :Jay-Roy, established no verifiable claim by a man of any injury or damage. And,

10. The :request for :all of the evidence :Craig possessed on the matter has been ignored, as that if the Superior Court Clerk does not acknowledge the communication then he deems not essential for him to act upon the any lawful demand.

11. :i- man believe there is not a verifiable claim-made in this action against the man- :Jay-Roy, that wherefrom this complaint-is has needlessly threatened and damaged :i- man- :Darrell-James: Hill, et al.

12. :i- man believe the :Pinal- county- agent's actions are :wrong-doings within an open collusion. :i- man believe that these actions are :intended- :collusions against the man- :Jay-Roy, et al., for the goal of the non-political :commercial-gains in :violation of the U.S. Trustee's restriction upon the Pinal- county to not compete and to absolutely make certain to protect and insure that :i- man: Darrell-James: Hill -beneficiary- :living-soul on the land experience No damages and No further damages.

c. The :Court of Record- Trial-by Jury :Equity- venue for the protection of :i- man :Darrell-James: Hill, et al. - the June 8th, 2017 Contract

13. **The June 8th, 2017 contract.** For the inability of the words and letters to cease the Pinal- county- agents harassment, and for the effect to stop of the trespass, :Jay-Roy submitted the June 8th, 2017 contract in :honor of the Pinal- county- agent- offer for their threat of more further damages then-to-fore- planned upon :Jay-Roy, et al., i.e. Darrell-James: Hill, et al. And,

14. :i- man- :Darrell-James: Hill -beneficiary was present at the June 8th, 2017 contract meeting. :i- man: Darrell-James: Hill- :beneficiary was present at the meeting on the day that the agreement of the June 8th, 2017 contract that was openly acquiesced before and in the meeting of the completion of the agreement into the June 8th, 2017 contract, when the Pinal- county- agent formally-accepted the presentment wholly as written into the evidence into the record in lieu of :Jay-Roy's reading the simple contract onto the hearing record at the meeting.

15. :i- man recall and can testify in open court to the good-faith efforts made by the man :Jay-Roy to end the Pinal- county- agent -trespass, -threatening, -harassment and - stalking-behavior on and about the private property; and,

16. :i- man witnessed the Pinal- county- trustee act in the despise of the contract. :i- man have witnessed, observed and wrote about the Pinal- county- apparatus of :trespasses occurring after the June 8th, 2017 contract, the: stalking behavior on a dead-end- county-

Stephen-F.: McCarville USPS RMN RE 322 404 115 US

1209

2022-011769 MISC Page: 1212 of 2782
09/26/2022 03:35:37 PM Receipt #: 22-9381
Rec Fee: \$30.00 Darrell James Hill
Gila County, Az, Sadie Jo Bingham, Recorder



Darrell-James: Hill, c/o PO Box 3806, Apache Junction, Arizona 85117

lane threatening the :habitat of the living-souls on and about the private land in the Arizona state territory at the: Jay-Roy's home area: 5124 East 18th Avenue, Apache Junction, Arizona state territory, etc. Further,

17. **:i- man believe commercial-capital-gains is the Pinal- county's- focus.** :i- man believe that this :whole- intent was purely for a Pinal- county-commercial- gain at the deprivation of the man's -right to live in :peace, and to totally for their homogeneity upon the man- :Jay-Roy, and thus onto :i- man- :Darrell-James: Hill -: beneficiary, et al.

18. **:i- man belief that the Pinal- county -avoidance of the June 8th, 2017 contract is for the imposition of their goal of: gaining-further-access to the subsequent damage upon the man- :Jay-Roy, and upon :i- man- :Darrell-James: Hill, et al, at this time.** :i- man believe that from the June 8th, 2017 Contract- unto- now that the Pinal- county- agent- trespasses and wrong-doings solely involved the making of the commercial complaint with no claim against a living man: Jay-Roy's right to answer the Pinal- county complaint solely based-upon the avoidance of the Pinal- county- obligation to the June 8th, 2017 Contract agreement; that is, a cost of :one- ounce of :silver U.S. dollar per minute beginning at the April 5th, 2017, 5:00 p.m. and ending when this matter is resolved.

19. **:i- man believe that the matter of the June 8th, 2017 contract is an equity-venue matter.** :i- man believe that the matter of the June 8th, 2017 contract is an equity-venue matter that is now ignored in the the Pinal- county- agents by :denial of :due process, and by the :push for the Pinal- county -Clerk- of-the-Superior court to assure the :deprivation of :rights of a man-beneficiary in a commercial court that does not see nor hear the man- :Jay-Roy's or acknowledge his right of common access to the court that is the protected due process and jurisdiction. By the bold and desperate- collusion to cover-up the un-Lawful and illegal unjust commercial gains, violations are exposed, and the retaliation against the man- :Jay-Roy, et al., is this systematic injury, and, consequentially, begets more injury upon :i- man-beneficiary: Darrell-James: Hill.

20. **:Remedy:** For the safety and protection of :i- man-beneficiary: Darrell-James: Hill, et al., :i- man require that a court-of-record with trial-by-jury be the mechanism to try the claims of the the Pinal- county and of the man- :Jay-Roy, et al., to ascertain is they are true. Additionally, :i- man require that a court-of-record with trial-by-jury be convened to try the claims of the facts and the law of the June 8th, 2017 contract to ascertain which matters of the fact and the contract between the man- :Jay-Roy and the Pinal- county, et al.- agents' are right and just.

21. **If the Pinal- county, et al., -court chooses to ignore the subsequently injured party: i- man- :Darrell-James: Hill, et al. for their sake of sustaining to themselves more non-political capital gains by the denial-of-due-process and default process in place against the man: Jay-Roy: Ingold then :i- man- :Darrell-James: Hill do not consent to being in anyway considered to be accepting of that wrong-doing, and :i- man in no wise concede any rights-executed or to be executed against any such perpetrators. And, upon the cause that this matter between the man: Pinal- county and the man- :Jay-Roy: Ingold defaults for the corruption that is predetermined, :i- man: Darrell-James: Hill do not consent to the Pinal- county corruption, and all of my property will be immune**

Stephen-F.: McCarville USPS RMN RE 322 404 115 US

1210

2022-011769 MISC Page: 1213 of 2782
09/26/2022 03:35:37 PM Receipt #: 22-9381
Rec Fee: \$30.00 Darrell James Hill
Gila County, Az, Sadie Jo Bingham, Recorder



Darrell-James: Hill, c/o PO Box 3806, Apache Junction, Arizona 85117

from the Pinal- county- agent- trespass; and, any violation is subject to the costs already established for such violations.

cc: **Kent: Pinal County Attorney Volkmer**
c/o Craig: Deputy county Attorney Cameron
c/o PO Box 887
Florence, Arizona 85132

General Mark A. Milley
Chairman of the Joint Chiefs of Staff
c/o Office of the Chairman of the JCOS
9999 Joint Staff Pentagon
Washington, DC 20318-9999

Air Force General John Hyten,
Vice Chairman of the Joint Chiefs of Staff
c/o General Mark A. Milley
9999 Joint Staff Pentagon
Washington, DC 20318-999

General David H. Berger
Commandant of the Marine Corps HQ,
c/o General Mark A. Milley
US Marine Corps 3000 Marine Corps,
Pentagon
Washington, DC 20350-3000

Kevin-D.: Judge White
Superior Court Associate Presiding Judge
c/o PO Box 2578
Florence, Arizona 85132

Jason-R.: Judge Holmberg
Presiding Civil Judge
c/o PO Box 986
Florence, Arizona 85132

Lt. Gen. Joseph M. Martin
Army Chief of Staff
c/o General Mark A. Milley
200 Army Pentagon
Washington, DC 20310-0200

General David L. Goldfein
Air Force Chief of Staff
c/o General Mark A. Milley
1670 Air Force Pentagon
Washington, DC 20330-1670

Darrell-James Hill AR



URAT

Sworn to and subscribed before me now on this ^{1st} day: August: 2019.
Produced identification: type: Arizona Driver License.

Savannah Czerwinski

Notary

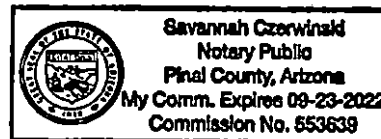
seal



Stephen-F.: McCarville USPS RMN RE 322 404 115 US

08/01/19 5/5

2022-011769 MISC Page: 1214 of 2782
09/26/2022 03:35:37 PM Receipt #: 22-9381
Rec Fee: \$30.00 Darrell James Hill
Gila County, Az, Sadie Jo Bingham, Recorder



UNOFFICIAL
12/1

RE32240420705

To Be Completed By Post Office	Reg. Fee	\$0.70	
	Handling Charge	\$12.40	Return Receipt
	Postage	\$2.80	Restricted Delivery
	Received by	\$0.00	
			\$15.90

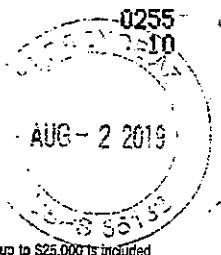

FLORENCE
501 N MAIN ST
FLORENCE, AZ 85132-9998
032886-0255
(800)275-8777
08/02/2019 03:44 PM

Product	Qty	Unit Price	Price
First-Class Mail® Letter	1	\$0.70	\$0.70

(Domestic)
(FLORENCE, AZ 85132)
(Weight: 0 Lb 1.50 Oz)
(Estimated Delivery Date)
(Monday 08/05/2019)

Registered (Amount: \$0.00) (USPS Registered Mail #) (RE322404209US) \$12.40

Return Receipt (USPS Return Receipt #) (9590940247428344639745) \$2.80

First-Class Mail® Letter (Domestic) (FLORENCE, AZ 85132) (Weight: 0 Lb 1.00 Oz) (Estimated Delivery Date) (Monday 08/05/2019) \$0.55 \$0.55

Registered (Amount: \$0.00) (USPS Registered Mail #) (RE322404115US) 12.40

Return Receipt (USPS Return Receipt #) (9590940247428344639752) \$2.80

Total \$31.65

Cash \$40.00
Change (\$8.35)

OFFICIAL USE

FLORENCE, AZ 85132

FROM: Darrell-James Hill
c/o PO Box 3806
Apache Junction, Arizona 85117

TO: Natasha: Clerk of the Board Kennedy
c/o Pinal County Board of Supervisors
Administrative Complex
Florence, Arizona 85132

PS Form 3806, Receipt for Registered Mail Copy 1 - Customer
May 2007 (7530-02-000-9051) (See Information on Reverse)
For domestic delivery information, visit our website at www.usps.com®

Registered No. RE322404115US

To Be Completed By Post Office	Reg. Fee	\$0.55	
	Handling Charge	\$12.40	Return Receipt
	Postage	\$2.80	Restricted Delivery
	Received by	\$0.00	
			\$15.75

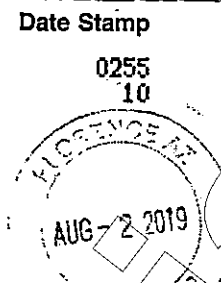

Customer Must Declare Full Value \$8.00 08/02/2019 Domestic Insurance up to \$25,000 is included on the declared value. International Indemnity is limited. (See Reverse)

OFFICIAL USE

FLORENCE, AZ 85132

FROM: Darrell-James Hill
c/o PO Box 3806
Apache Junction, Arizona 85117

TO: Stephen-F: Judge McCarville
Pinal County Superior Presiding Judge
PO Box 828
Florence, Arizona 85132

SENDER: COMPLETE THIS SECTION

- Complete items 1, 2, and 3.
- Print your name and address on the reverse so that we can return the card to you.
- Attach this card to the back of the mailpiece, or on the front if space permits.

1. Article Addressed to:
Stephen-F: Judge McCarville
Pinal County Superior Presiding Judge
PO Box 828
Florence, Arizona 85132

COMPLETE THIS SECTION ON DELIVERY

A. Signature: [Signature] Agent Addressee

B. Received by (Printed Name): Crystal Kane Date of Delivery: 8-7-19

D. Is delivery address different from item 1? Yes No
If YES, enter delivery address below:

PS Form 3806, Receipt for Registered Mail
May 2007 (7530-02-000-9051) (See Information on Reverse)
For domestic delivery information, visit our website at www.usps.com®



RE 322 404 115 US

PS Form 3811, July 2015 PSN 7530-02-000-9053 Domestic Return Receipt

1212

Darrell-James: Hill, c/o PO Box 3806, Apache Junction, Arizona 85117

"

Arizona state
Pinal county

:i- the :man- :Darrell- James: Hill, now on this 2nd, day: August: 2019 A.D., on his affirmation, claimant deposes and says: – Notice to the Agent is Notice to the Principal; Notice to the Principal is Notice to the Agent: –

:Todd: Pinal county Supervisor House
:Steve: Pinal county Supervisor Miller
:Pete: Pinal county Supervisor Rios
:Mike: Pinal county Supervisor Goodman
:Anthony: Pinal county Supervisor Smith
c/o :Natasha: Clerk of the Board Kennedy
c/o Pinal County, Board of Supervisors
135 N. Pinal Street
Administrative Complex
Florence, Arizona 85132

USPS RMN RE 322 404 209 US

RE: Right of Consuance

:Todd, :Steve, :Pete, :Mike, :Anthony, :Natasha Greetings:

Thank you for your service.
My prayers are with you.

You, et al., must assured to be aware

:Appended- hereto is the :affidavit- :document regarding the :deprivation of the rights-executed of a :man- Jay-Roy: Ingold, and, now-also, :i- man: Darrell-James: Hill, subsequent to a matter wherein you, the: Pinal-county-Board-of Supervisors are directly responsible.

:i- man am :Darrell-James: Hill, as indicated in the document. And, for the reasons affirmed and inferred in the document, :malfeasance may be illustrated, as:

1. :i- man have witnessed coercive-misuse of :authority that became to negatively-effect the :peace of the people at their :place-of-habitation, as indicated in the document.
2. :Not-explicitly-stated in the document is the fact that :this-matter could not exist unless the :Pinal-county-Board-of-Supervisors somehow authorized for :whatever- reasons-given that the county attorneys act-against the :man- :Jay-Roy: Ingold, as indicated in the document.
3. :Now, did you not-know that your Pinal county agents formed and accepted a May 8th,

Pinal county Bd of Supv/ Clerk: USPS RMN RE 322 404 209 US

2022-011769 MISC Page: 1216 of 2782
09/26/2022 03:35:37 PM Receipt #: 22-9381
Rec Fee: \$30.00 Darrell James Hill
Gila County, Az, Sadie Jo Bingham, Recorder



1213

Darrell-James: Hill, c/o PO Box 3806, Apache Junction, Arizona 85117

2017 agreement which they activated :contract on :June 8th, 2017 with the man: Jay-Roy: Ingold by the authority of your community-development-mechanism- :commercial- offer? :Jay-Roy, in the accordance with Arizona Law and statute, was formally denied the right to opt-out of the Pinal-county, et al.: community development program, a :private-:commercial-gains - :vehicle of the Pinal county, on June 8th, 2017.

The :Ingold- :contract now-time requires the :Pinal county, et seq. to pay to the :man: Jay-Roy: Ingold the :amount of :one- :one-ounce silver U.S. dollar per the minute for these continued- actions, as indicated in the contract. - i.e., starting on: April 5, 2017: 5:00 p.m. until this :matter is resolved - (EXAMPLE BILL CALCULATION: 365 days/ year x 24 hours/day x 60 minutes/ hour/day = 525,600 minutes/hour/day/year)- if the :deprivation- of- :rights-abuses did not cease and desist on :June 8th, 2017: 08:30 a.m.

Now: the :man- Craig: your :Deputy county Attorney Cameron is the actor at the center of the matter of these facts which have now become none-other-than- a- :manifestation of the intent to deprive the :man- :Jay-Roy: Ingold by the denial of the man- :Jay's right(s)-executed for :Jay-Roy, et al., to live in the peace on his private- :property, et seq.

As indicated in the appended document, :i- man: Darrell-James: Hill-beneficiary am the steward(s) (with: wife: Beverly) by a :private- :contract on the :Jay-Roy: Ingold- private- property, and :i- man now have additionally been drawn directly into this matter as a :private- :man- :beneficiary and made-subject on :your-behalf by :your-:agent: Craig: Attorney Cameron. The appended document of the right-executed, The right of Consuance..., establishes the :fact that :i-man and :wife: Beverly-Jean: Romero- Hill-beneficiary, have now been made targets, even: collateral-damage, by the man: Craig: your- :Attorney-agent(s). **:You have now been made aware of :this wrong-doing- :man- abuse by your authority.**

:You have now been made aware of :this, that your authorization has been used to do- wrong against private people and civilians-: i-man: Darrell-James: Hill, and Beverly-Jean: Romero- Hill. All that remains to be known-now :is, 'Is :this wrong-doing :your :manly- :intent? Is this the :policy of the Pinal- county-, Board-of-Supervisors?

In :Conclusion, If :i- man-beneficiary may suggest

:i- man believe that :it is in the best long- and short- term interests of all parties that this matter goes-away now; the :pursuit of :doing-wrong is never profitable. :i- man observe to suggest that: because this-type- :malfeasance is never good, through your management :this matter is best withdrawn and amicably settled-and-closed. This serves to the advantage of all parties, the man: Jay-Roy: Ingold, et al., and the people of :Pinal county.

cc: **Kent: Pinal County Attorney Volkmer**
c/o Craig: Deputy county Attorney Cameron
c/o PO Box 887
Florence, Arizona 85132

Kevin-D.: Judge White
Superior Court Associate Presiding Judge
c/o PO Box 2578
Florence, Arizona 85132

1214 Pinal county Bd of Supv/ Clerk: USPS RMN RE 322 404 209 IIS 08/02/19 2/3

2022-011769 MISC Page: 1217 of 2782
08/26/2022 03:35:37 PM Receipt #: 22-9381
Rec Fee: \$30.00 Darrell James Hill
Gila County, Az, Sadie Jo Bingham, Recorder



Darrell-James: Hill, c/o PO Box 3806, Apache Junction, Arizona 85117

General Mark A. Milley
Chairman of the Joint Chiefs of Staff
c/o Office of the Chairman of the JCOS
9999 Joint Staff Pentagon
Washington, DC 20318-9999

Air Force
General John Hyten,
Vice Chairman of the Joint Chiefs of Staff
c/o General Mark A. Milley
9999 Joint Staff Pentagon
Washington, DC 20318-999

General David H. Berger
Commandant of the Marine Corps HQ,
c/o General Mark A. Milley
US Marine Corps 3000 Marine Corps,
Pentagon
Washington, DC 20350-3000

Jason-R: Judge Holmberg
Presiding Civil Judge
c/o PO Box 986
Florence, Arizona 85132

Lt. Gen. Joseph M. Martin
Army Chief of Staff
c/o General Mark A. Milley
200 Army Pentagon
Washington, DC 20310-0200

General David L. Goldfein
Air Force Chief of Staff
c/o General Mark A. Milley
1670 Air Force Pentagon
Washington, DC 20330-1670

Thank-you,
Without Prejudice

Darrell-James Hill
:Darrell-James: Hill, Beneficiary

IURAT

Sworn to and subscribed before me now on this 2nd, day: August: 2019.
Produced identification: type: Arizona Driver License.

Notary

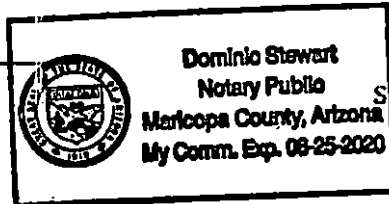

seal

1215

Pinal county Bd of Supv/ Clerk: USPS RMN RE 322 404 209 US

08/02/19 3 / 3

2022-011769 MISC Page: 1218 of 2782
09/26/2022 03:35:37 PM Receipt #: 22-9381
Rec Fee: \$30.00 Darrell James Hill
Gila County, Az. Sadie Jo Bingham, Recorder



RE322404209US

Reg. Fee	\$0.70	
Handling Charge	\$12.40	Return Receipt
Postage	\$2.80	Restricted Delivery
	\$0.00	
Received by	\$0.00	
		\$15.90

Customer Must Declare Domestic Insurance up to \$25,000 is included
 Full Value \$0.00 08/02/2019 on the declared value. International
 Indemnity is limited. (See Reverse).

OFFICIAL USE

FLORENCE, AZ 85132

FROM :Darrell-James: Hill
 c/o PO Box 3806
 Apache Junction, Arizona 85117

TO :Natasha: Clerk of the Board Kennedy
 c/o Pinal County, Board of Supervisors
 Administrative Complex
 Florence, Arizona 85132

PS Form 3806, Receipt for Registered Mail Copy 1 - Customer
 May 2007 (7530-02-000-9051) (See Information on Reverse)

Registered No. RE322404115US

Reg. Fee	\$0.55	
Handling Charge	\$12.40	Return Receipt
Postage	\$2.80	Restricted Delivery
	\$0.00	
Received by	\$0.00	
		\$15.75

Customer Must Declare Domestic Insurance up to \$25,000 is included
 Full Value \$0.00 08/02/2019 on the declared value. International
 Indemnity is limited. (See Reverse).

OFFICIAL USE

FLORENCE, AZ 85132

FROM :Darrell-James: Hill
 c/o PO Box 3806
 Apache Junction, Arizona 85117

TO :Stephen P. Judge McCarville
 Pinal County Superior Court
 PO Box 828
 Florence, Arizona 85132

PS Form 3806, Receipt for Registered Mail
 May 2007 (7530-02-000-9051)
 For domestic delivery information, visit our website

SENDER: COMPLETE THIS SECTION

- Complete items 1, 2, and 3.
- Print your name and address on the reverse so that we can return the card to you.
- Attach this card to the back of the mailpiece, or on the front if space permits.

1. Article Addressed to:
 :Natasha: Clerk of the Board Kennedy
 c/o Pinal County, Board of Supervisors
 135 N. Pinal Street
 Administrative Complex
 Florence, Arizona 85132



RE 322 404 209 US

PS Form 3811, July 2015 PSN 7530-02-000-9053

FLORENCE
 501 N MAIN ST
 FLORENCE, AZ 85132-9998
 032886-0255
 (800)275-8777
 08/02/2019 03:44 PM

Product	Qty	Unit Price	Price
First-Class Mail® Letter	1	\$0.70	\$0.70
Registered			\$12.40
Return Receipt			\$2.80
First-Class Mail® Letter	1	\$0.55	\$0.55

(Domestic)
 (FLORENCE, AZ 85132)
 (Weight:0 Lb 1.50 Oz)
 (Estimated Delivery Date)
 (Monday 08/05/2019)

Registered (Amount:\$0.00)
 (USPS Registered Mail #)
 (RE322404209US)

Return Receipt (USPS Return Receipt #)
 (9590940247428344639745)

First-Class Mail® Letter (Domestic)
 (FLORENCE, AZ 85132)
 (Weight:0 Lb 1.00 Oz)
 (Estimated Delivery Date)
 (Monday 08/05/2019)

Registered (Amount:\$0.00)
 (USPS Registered Mail #)
 (RE322404115US)

Return Receipt (USPS Return Receipt #)
 (9590940247428344639752)

Total: \$31.65

Cash \$40.00
 Change (\$8.35)

COMPLETE THIS SECTION ON DELIVERY

A. Signature
 Priscilla Flores Agent
 Priscilla Flores Addressee

B. Received by (Printed Name)
 Priscilla Flores

C. Date of Delivery
 2019

D. Is delivery address different from item 1? Yes
 if YES, enter delivery address below: No

3. Service Type
- Adult Signature
 - Adult Signature Restricted Delivery
 - Certified Mail®
 - Certified Mail Restricted Delivery
 - Collect on Delivery
 - Delivery Restricted Delivery
 - Priority Mail Express®
 - Registered Mail™
 - Registered Mail Restrict Delivery
 - Return Receipt for Merchandise
 - Signature Confirmation®
 - Signature Confirmation Restricted Delivery

:Darrell-James: Hill- :civilian -:beneficiary, -executor
PO Box 3806
Apache Junction, Arizona- 85117

Received
Oct 30, 2019
Beverly-Jean: Romero-Hill, A/E

Arizona state
Pinal county

Beverly-Jean: Romero- Hill -:civilian -:beneficiary, -executor
Jay-Roy: Ingold -:man -:beneficiary, -executor
Lisa: Loeffler- Ingold -:man -:beneficiary, -executor
Tracy-Robert: Calhoun -:man -:beneficiary, -executor
James-William: Woods -:man -:beneficiary, -executor
c/o :one -document :hand -delivered to: Ingold home and land area;
5124 East 18th Ave, Apache Junction, Arizona 85119

Mark: Pinal county Sheriff Lamb USPS CMN 7008 1300 0002 2256 4712
PO Box 867, Florence, Arizona 85132.

October 30, 2019

Re: **Statement of :Claim – :2017 May-June 8th Contract¹- Debt Notice;**
Presentment of :Manifest with :Bill; Demand for :Payment on Receipt of: Bill .
- This :Claim is directly connected to the matter of : 'Pinal v. Ingold'².

Beverly-Jean, Jay- Roy, Lisa, Tracy-Robert, James-William, Mark, Greetings:

Beverly-Jean, et al., Mark, since :2016 :Claims³ to the man- acting as sheriff have been presented citing the wanton and abusive -:trespassings imposed/ enabled by the man- :Trustees authorizing and supporting the Pinal v Ingold matter.

:i- man :Darrell-James stated an individual claim to the :man- Trustees for the recompense -established in accordance with the :2017 May-June 8th Contract. See the :claim- document sent by: USPS RMN RE 322 404 169 US delivery to the man: Trustees -:PINAL COUNTY/Pinal county supervisor(s) for the prompt remedy with :fiduciary -:integrity in :compliance with the inherent trusteeship- obligation to :i- man -:civilian -:beneficiary, and :same as relates to the 2017 May-June 8th Contract- obligation to :i- man -:civilian -:beneficiary.

:i encourage you to consider and chose whether to make a :demand in :accordance with the case, et seq. , inherent obligation(s), and the :2017 May-June 8th Contract- obligations as they relate to :you- :man particularly. Please find attached the Statement of :Claim ... sent by :i- man to the Pinal county.

i- man see no verifiable evidence that the "Statement of Claim ..." is not accurate, and :i- man believe no verifiabl⁷e evidence to the contrary exists.

Enclosures: (1) Statement of :Claim – :2017 May-June 8th Contract⁴- Debt Notice;
Presentment of :Manifest with :Bill; Demand for :Payment on Receipt of: Bill; appended: 222 pages.
(2) :Letter to the :man- Trustees re: RE 322 404 169 US: Affidavit; Statement of : Claim ... , with Thank you; appended: 3 pages.

Sincerely;
Without Prejudice

:Darrell-James: Hill -:civilian -:beneficiary, -executor

- 1 - :2017 May-June 8th Contract means: – RMN RE 322 399 225 US – the contract offered to cease and desist the wrong-doing against :i- man, or to alternatively-choose the :option to pay the fee-schedule. The :PINAL COUNTY/Pinal county acquiesced the contract, then persisted and escalated the harm upon the victims. See: Section B (below) appended, RMN RE 322 399 225 US.
- 2 Pinal v. Ingold means: Case No. CV 201801825; dismissed.
- 3 Darrell-James: Hill means: Notice to the man- Paul: Pinal Sheriff Babeu: USPS RE 322 398 137 US : September 2016
- 4 :2017 May-June 8th Contract means: – RMN RE 322 399 225 US – the contract offered to cease and desist the wrong-doing against :i- man, or to alternatively-choose the :option to pay the fee-schedule. The :PINAL COUNTY/Pinal county acquiesced the contract, then persisted and escalated the harm upon the victims. See: Section B (below) appended, RMN RE 322 399 225 US.

:dj- Claim to :Ingold, et al. -home-land, Mark: Sh

2022-011769 MISC Page: 1220 of 2782
09/26/2022 03:35:37 PM Receipt #: 22-9381
Rec Fee: \$30.00 Darrell James Hill
Gila County, Az, Sadia Jo Bingham, Recorder



1247

Darrell-James: Hill - :civilian - :beneficiary, -executor
PO Box 3806
Apache Junction, Arizona - 85117



Arizona state
Pinal county

Beverly-Jean: Romero - Hill - :civilian - :beneficiary, -executor
Jay-Roy: Ingold - :man - :beneficiary, -executor
Lisa: Loeffler - Ingold - :man - :beneficiary, -executor
Tracy-Robert: Calhoun - :man - :beneficiary, -executor
James-William: Woods - :man - :beneficiary, -executor
c/o :one - document :hand - delivered to: Ingold home and land area;
5124 East 18th Ave, Apache Junction, Arizona 85119

Mark: Pinal county Sheriff Lamb
PO Box 867, Florence, Arizona 85132. USPS CMN 7008 1300 0002 2256 4712

October 30, 2019

Re: Statement of :Claim - :2017 May-June 8th Contract¹ - Debt Notice;
Presentment of :Manifest with :Bill; Demand for :Payment on Receipt of: Bill.
- This :Claim is directly connected to the matter of : 'Pinal v. Ingold'².

Beverly-Jean, Jay- Roy, Lisa, Tracy-Robert, James-William, Mark, Greetings:

Beverly-Jean, et al., Mark, since :2016 :Claims³ to the man- acting as sheriff have been presented citing the wanton and abusive -trespassings imposed/ enabled by the man- :Trustees authorizing and supporting the Pinal v Ingold matter.

:i- man :Darrell-James stated an individual claim to the :man- Trustees for the recompense -established in accordance with the :2017 May-June 8th Contract. See the :claim- document sent by: USPS RMN RE 322 404 169 US delivery to the man: Trustees - :PINAL COUNTY/Pinal county supervisor(s) for the prompt remedy with :fiduciary - :integrity in :compliance with the inherent trusteeship- obligation to :i- man - :civilian - :beneficiary, and :same as relates to the 2017 May-June 8th Contract- obligation to :i- man - :civilian - :beneficiary.

:i encourage you to consider and chose whether to make a :demand in :accordance with the case, et seq., Inherent obligation(s), and the :2017 May-June 8th Contract- obligations as they relate to :you- :man particularly. Please find attached the Statement of :Claim ... sent by :i- man to the Pinal county.

i- man see no verifiable evidence that the 'Statement of Claim ...' is not accurate, and :i- man believe no verifiable evidence to the contrary exists.

Enclosures: (1) Statement of :Claim - :2017 May-June 8th Contract⁴ - Debt Notice;
Presentment of :Manifest with :Bill; Demand for :Payment on Receipt of: Bill; appended: 222 pages.
(2) :Letter to the man- Trustees re: RE 322 404 169 US; Affidavit; Statement of : Claim ..., with Thank you; appended: 3 pages.

Sincerely;
Without Prejudice

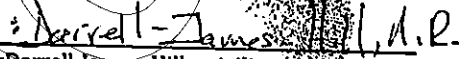
:Darrell-James: Hill - :civilian - :beneficiary, -executor

- 1 :2017 May-June 8th Contract means: - RMN RE 322 399 225 US - the contract offered to cease and desist the wrong-doing against :i- man, or to alternatively-choose the :option to pay the fee-schedule. The :PINAL COUNTY/Pinal county acquiesced the contract, then persisted and escalated the harm upon the victims. See: Section B (below) appended, RMN RE 322 399 225 US.
- 2 Pinal v. Ingold means: Case No. CV 201801825; dismissed.
- 3 Darrell-James: Hill means: Notice to the man- Paul; Pinal Sheriff Babeu: USPS RE 322 398 137 US : September 2016
- 4 :2017 May-June 8th Contract means: - RMN RE 322 399 225 US - the contract offered to cease and desist the wrong-doing against :i- man, or to alternatively-choose the :option to pay the fee-schedule. The :PINAL COUNTY/Pinal county acquiesced the contract, then persisted and escalated the harm upon the victims. See: Section B (below) appended, RMN RE 322 399 225 US.

:dj- Claim to :Ingold, et al. -home-land, Mark: Sheriff Pinal Lamb - USPS CMN 7008 1300 0002 2256 4712



1218

7008 1300 0002 2256 4732

U.S. Postal Service™
CERTIFIED MAIL™ RECEIPT
 (Domestic Mail Only; No Insurance Coverage Provided)

For delivery information, visit our website at www.usps.com

FLORENCE, AZ 85132

Postage	\$3.50
Certified Fee	\$3.50
Return Receipt Fee (Endorsement Required)	\$2.80
Restricted Delivery Fee (Endorsement Required)	\$0.00
Total Postage & Fees	\$14.60

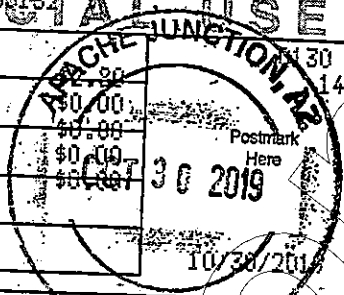

Sent to
 Mark Pinal county Sheriffs Office
 Street, Apt. No., or PO Box No. PO Box 867
 City, State, ZIP+4 Florence, Arizona 85132

PS Form 3800, August 2006 See Reverse for Instructions

APACHE JUNCTION
 151 W SUPERSTITION BLVD
 APACHE JUNCTION, AZ 85120-9998
 030259-0130
 (800)275-8777
 10/30/2019 11:53 AM

Product	Qty	Unit Price	Price
PM 2-Day (Domestic) (FLORENCE, AZ 85132) (Weight: 2 Lb 5.20 Oz) (Expected Delivery Day) (Friday 11/01/2019)	1	\$8.30	\$8.30
Certified (USPS Certified Mail #) (70081300000222564712)			\$3.50
Return Receipt (USPS Return Receipt #) (9590940247428344639684)			\$2.80
Total:			\$14.60

Cash \$20.00
 Change (\$5.40)

Includes up to \$50 insurance

Text your tracking number to 28777 (2USPS) to get the latest status. Standard Message and Data rates may apply. You may also visit www.usps.com USPS Tracking or call 1-800-222-1811.

In a hurry? Self-service kiosks offer quick and easy check-out. Any Retail Associate can show you how.

1219

09/26/2022 03:35:37 PM Receipt #: 22-9381
 Rec Fee: \$30.00 Darrell James Hill
 Gila County, Az, Sadia Jo Bingham, Recorder



:Darrell-James: Hill, :executor, :civilian
c/o PO Box 3806
Apache Junction, Arizona 85117

Arizona state
Pinal county

**Affidavit: Statement of :Claim - :2017 May-June 8th Contract¹- Debt Notice;
Presentment of :Manifest with :Bill;
Demand for :Payment on Receipt of : Bill**

:Affiant

:i- man- :Darrell-James: Hill © 1958, Ohioan² (i) am the :man- beneficiary of the inherent rights given to :i- man by the :Almighty- :God - where nothing stands between :Almighty God and :i- man -; (ii) am a :Negro, forever principally guaranteed and expressively guaranteed the protection of the facility of The Constitution for the United States of America, et seq. - by the :Emancipation - :Proclamation of: 1863, and General Order No. 100 of: 1863, et seq; (iii) am a :private- :civilian- :beneficiary of the UNITED STATES government's indenture of :itself by the 'Emergency Banking Act of 1933 - TWEA of 1917, as amended', served by :debenture by :way of the idem-sonans - :subrogation entitled: DARRELL JAMES HILL, © 1958, OHIO.

:i- man am a member of the non-political aggregate, and am guaranteed a republican form of government. :i- man am a literate, :legal -idiot -non-member of the :legal- :B.A.R. -society.

A) In This Matter, i- man Observed And Experienced First-Hand how effortfully-much of a little-effect i- man, et al.³ was able to achieve in the stopping

- 1 :2017 May-June 8th Contract means: - RMN RE 322 399 225 US - the contract offered to cease and desist the wrong-doing against :i- man, or to alternatively-choose the :option to pay the fee-schedule. The :PINAL COUNTY/Pinal county acquiesced the contract, then persisted and escalated the harm upon the victims. See: Section B (below) appended, RMN RE 322 399 225 US.
- 2 :Darrell-James: Hill © 1958 means: a) Political Election: Gila county Arizona, Recorder: Doc. #2017-002378; pp 6-24, 93-95 of 693; and Gila county Arizona, Recorder: Doc. #2019-009291-758-772 of 851. b) Live-Life: Gila county Arizona, Recorder: Doc. # 2018-005176; pp. 18-21 of 21; c) Civilian: Gila county Arizona, Recorder: Doc. #2019-009291-798-799 of 851.
- 3 :i- man, et al. means: man- :beneficiaries; the soul-journeymen inhabiting the :Ingold home and land area, enduring the trepidation and jeopardy of the threatening and overwhelm imposed upon the souls without right by the PINAL COUNTY/Pinal county Trustee, et al. sworn to Not impose, oppress or compete against or otherwise bring harm to :man- :beneficiaries. See: Section B ... : facts of :evidence: a) RMN RE 322 404 036 US.

Darrell-James -2019 Oct. 28th :Manifest of :Bill of: Trespassing contract
:PINAL COUNTY/Pinal county

2022-011769 MISC Page: 1223 of 2782
09/26/2022 03:35:37 PM Receipt #: 22-9381
Rec Fee: \$30.00 Darrell James Hill
Gila County, Az. Sadie Jo Bingham, Recorder



1220

these past three (3) years (2016-2019) of the systemic victimization from the PINAL COUNTY/Pinal county Trustee's hand, method, agency and resources, and its' use of the PINAL COUNTY Arizona state judicial resources in a seamless, orchestrated, personal -tool -manner to faithfully enforce its' :commercial interests indifferent to the threat, trespass and harm to :i- man- :beneficiary, et al.

B) :Claim Of Wrong-Doing Surrounding This Matter Is Thrice Registered With The Pinal County Sheriff. See: Section B appended: **first claim:** CMN 7015 0640 0001 5883 2631 - :6 pages; **second claim:** RMN RE 322 404 040 US - :22 pages; **third claim:** RMN: RE 322 404 053 US - :59 pages; and: **facts of :evidence,** a) RMN RE 322 404 036 US - :83 pages, b) CMN 7018 0360 0000 5968 8843 - :7 pages, c) CMN 7018 0360 0000 5969 3007 - :6 pages, d) CMN 7018 0360 0000 5968 8850 - :6 pages, and e) CMN 7018 0360 0000 5968 6115 - : 4 pages.

C) :Conusance Was Made To Prevent A Continued And Expanded Process Of Wrong-Doings Proposed By The Pinal County/Pinal County Hand, Policy Or Agency, et al. With Re: To The 'Arizona -Superior -Court -record, Pinal county :number: 'CV201801825'- case'. See: Section C appended, 10 pages;

D) By The :Court- :Internal- Review, The ':Arizona -Superior -Court -record, Pinal County :number: 'CV201801825'-Case' Was Dismissed. See: Section D appended, 2 pages;

E) The :Prevailing Contract Is The :2017 May-June 8th Contract governing this matter. Section B (above) appended, RMN RE 322 399 225 US. Despite the fact that the PINAL COUNTY/Pinal county acquiesced to the contract, the systematic trespassing-actions continued unabated.

Moreover, no rebuttals from a PINAL COUNTY/Pinal county executive agency has issued to :i- man, et al. to communicate a constructive end to the executive -trespassing -policy used against :i- man-beneficiary, et al. nor to find remedy for :i- man- :beneficiary, et al. Rather, :i- man-beneficiary, et al. am left by :default to proceed against the very-same oppressive-policy(-ies) used before without right to subject :i- man- :beneficiary, et al.

F) The :2017 May-June 8th Contract- :Fee-Schedule⁴ -Obligation Was Established To Proactively End The Pattern Of :Harms -Imposed Against :i- man, Et Al., By The Pinal County/Pinal County's Hand, Method Or Agency. Still, the

⁴ :fee-schedule means: one 'U.S.' Silver dollar -in-specie per minute beginning and ending according to the 2017 May-Jun 8th Contract. $a \times b = c$. a) The :sum of the time elapsed in :minute (unit of :time) beginning on :April 5, 2017: 1700 hr, and ending on :October 7, 2019: 17:21:17 hr, - :total 792,022 minutes; b) The contract establishes one- 'U.S.'- Silver-dollar- in specie - per each of: 792,022 minutes; c) The :calculated payment- due- now is: 792,022 - :one- 'U.S.' Silver dollar -in-specie.

Darrell-James -2019 Oct. 28th :Manifest of :Bill of: Trespassing contract
:PINAL COUNTY/Pinal county F

2022-011769 MISC Page: 1224 of 2782
09/26/2022 03:35:37 PM Receipt #: 22-9381
Rec Fee: \$30.00 Darrell James Hill
Gila County, Az, Sadie Jo Bingham, Recorder



1224

:PINAL COUNTY/Pinal County optioned to progressively persist and expand-upon an oppressive trespass without-right while using the :state -court -authority -apparatus as a readily available tool in its' attainment of :private commercial gain.

:i- man demand and require the :restoration of :all of my private-property.

G) The :2017 May-June 8th Contract- :Fee-Schedule- Obligation Due Paid Now: Is: 792,022⁵ - :one-'U.S.'- Silver -dollar. See 'Bill for :792,022- :one- 'U.S.' -silver dollar -in -specie'; - :Section G appended, 1 page; Gila county Arizona;

:i- man demand and require the :Payment of :all of the 792,022 - :one- 'U.S.'- Silver -dollar now-due in accordance with the :2017 May-June 8th Contract; the :PINAL COUNTY/Pinal county-Obligation is due-paid-now upon billing. And: All of the collection expenses and charges for the any amount- due or unpaid is the sole financial obligation of the PINAL COUNTY/Pinal county, due-paid upon :billing.

Immediate Payment Of The Bill Amount Is Required And Demanded.

:i -man affirm that all :aforesaid is true and correct, and will testify to the same in the open court.

Without prejudice

Darrell-James Hill, A.R.
:Darrell-James: Hill, Beneficiary - :executor

IURAT

Affirmed and signed before me on this 28 day: October 2019.
:Type of Identification: Arizona Driver License.

Abraham Martinez Flores
:Notary- Public

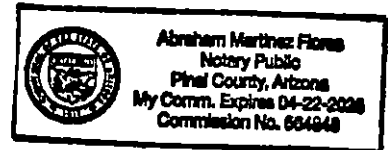

SEAL .

⁵ Ibid. 4(a). Calculation assisted by: <https://www.timeanddate.com/>

Darrell-James -2019 Oct. 28th :Manifest of :Bill of: Trespassing contract
:PINAL COUNTY/Pinal county R

2022-011769 MISC Page: 1225 of 2782
09/26/2022 03:35:37 PM Receipt #: 22-9381
Rec Fee: \$30.00 Darrell James Hill
Gila County, Az, Sadie Jo Binsham, Recorder

1222

:Darrell-James: Hill, :executor, :civilian
c/o PO Box 3806
Apache Junction, Arizona 85117

SECTION B

B) :Claim Of Wrong-Doing Surrounding This Matter Is Thrice Registered
With The Pinal County Sheriff. See: Section B appended: **first claim:**
CMN 7015 0640 0001 5883 2631 - :6 pages

1223
Darrell-James -2019 Oct. 28th :Manifest of :Bill of: Trespassing contract.
:PINAL COUNTY/Pin?

2022-011769 MISC Page: 1226 of 2782
09/26/2022 03:35:37 PM Receipt #: 22-9381
Rec Fee: \$30.00 Darrell James Hill
Gila County, Az, Sadie Jo Bingham, Recorder



Jay- Roy: Ingold, aggrieved man¹
c/o 5142 East 18th Avenue
Apache Junction, Arizona ZIP CODE EXEMPT
without the US inc.

Mark, acting as Pinal County Sheriff
971 Jason Circle, Building C
Florence, Arizona 85132

Re 5124 East 18th Avenue, Apache Junction, Arizona²;

CLAIM OF TRESPASS: VIOLATION OF CONSTITUTIONALLY PROTECTED RIGHT. See NOTICE and DEMAND made re: Compl Num: CC-9920-16. See Attached: "USPS RMN: RE 322 399 225 US to Himanshu, Paula, c/o Terrilyn", (4 pages.)

Mark, Greetings and Congratulations:

i: man am writing: because i 1) made a DEMAND for cease and desist of violation of my right against an Ex post facto law constitutional violation. And, 2) To resolve this matter, i have requested a common law trial-by-jury determining the facts and the law in this matter, a controversy greater than twenty dollars. Please see the documents attached.

I know you are a constitutional officer, and that i must notify you to help assure these abuses do Not persist.

Respectively, Jay-Roy: Ingold

Jay-Roy: Ingold

05/05/17

¹man means: a) a flesh and blood man-kind understanding Almighty God of Abraham of the Holy Bible, and a sovereign one who in a collective capacity with others sovereigns are the people of the United States of America over-standing the government for the United States of America; b) NOT a cestui que trust, corporation, or other fictitious entity; c) NOT a US citizen; d) Not an inhabitant of a federal area

²Parcel Number: 103-14-012B; Complaint Number: CC-9920-16- Hearing Date: June 08, 2017

2022-011769 MISC Page: 1227 of 2782
09/26/2022 03:35:37 PM Receipt #: 22-9381
Rec Fee: \$30.00 Darrell James Hill
Gila County, Az, Sadie Jo Bingham, Recorder



1224

TRCDE

Jay- Roy: Ingold
 c/o 5142 East 18th Avenue
 Apache Junction, Arizona ZIP CODE EXEMPT
 DMM 602.1.3.e2. Title 18 U.S.C. § 1342

Himanshu, acting as Director, Community Development
 Paula, acting as Code Compliance Manager
 c/o Terrilyn, acting as Code Compliance Officer RE 322 399 225 US
 575 North Idaho Street, Suite 800
 Apache Junction, Arizona 85119

Re: 5124 East 18th Avenue, Apache Junction, Arizona

NOTICE	a)	EX POST FACTO LAW VIOLATON;
	b)	CRIMINAL COMPLAINT;
	c)	FEE SCHEDULE
DEMAND	i)	DISCHARGE COMPLAINT – CANCEL HEARING, and
	ii)	CEASE AND DESIST; or,
	iii)	COMMON LAW PROCEEDING

Himanshu; Paula, Terrilyn, Greetings:

i: man am writing: because i have received various requests for changes i voluntarily made upon my property in good faith. i made significant changes and sent you photos, etc. improving the general appearance of my property. However, you have violated your Oath of Office and duty to persist to impose upon me further DEMAND LETTER(s) and a COMPLAINT seeking further to impose Code Violations for my parcel "103-14-012B" that you knew or should have known was ACQUIRED in 2008!

Address Above: It is a felony for you to send mail to an address that is not a proper mailing address, or a fictitious mailing address. My proper mailing address is as indicated above; if you intend to send mail to another address then you intend to be guilty of mail fraud.

NOTICE:

Your actions are repugnant to the Constitution for the United States-of-America-people, and the subsequent-subordinate-laws. You have mistakenly presumed that your code violations AND counts somehow applied to me; so, let me be clear:

a)	your application of code violations AND counts do Not apply to me;
b)	you have threatened to impose fines and/or create other hardship that Never before existed! if i do not comply with your demands;
c)	you have progressed to: a) threat of abuse, b) under the color of law; and,
d)	Your "CODE ENFORCEMENT OFFICER VERIFICATION", on the April 5,

2022-011769 MISC Page: 1228 of 2782
 09/26/2022 03:35:37 PM Receipt #: 22-9381
 Rec Fee: \$30.00 Darrell James Hill
 Gila County, Az, Sadie Jo Bingham, Recorder



1225

2017, COMPLAINT, is perjury if a) you knew or should have known that b) my parcel at 5124 E. 18th Ave. has been in my ownership since 2008; that: c) the codes were contrived years later, even 2010; d) no man has made a claim; and, e) your verification is repugnant to the United States and Arizona constitutions Ex post facto law prohibitions.

Moreover, your use of code to DECEIVE ME evidences a perverse application with willful criminal intent.

DEMAND

- **Withdraw the Complaint and Cancel the Hearing post haste;**
- **CEASE and DESIST; No Further Trespass about my property.**
- **FEE SCHEDULE:** If you choose Not to withdraw your complaint post haste, then from the time of your receipt of this NOTICE and DEMAND; I) you have 5 days to complete Items 1) & 2); thereafter, II) any further intrusion from your, et al., any actions to date, you a) agree to pay to me post haste upon request(s) one silver dollar per minute period of time from April 5, 2017, 5:00 pm, until this matter is resolved; and, b) you agree to pay post haste upon request any and all legal service charges incurred in resolve of- and collection from you- any amounts accrued.
- **COMMON LAW PROCEEDING:** If you choose to Not withdraw your complaint post haste, then i Demand a June 8, 2017, Court of Record to proceed in Common Law with trial by jury to hear and decide a) the controversy of your actions against me, and b) the Item 3) Fee Schedule, matter in controversy greater than twenty dollars at this writing.
- My **Next Friend**, the man steward-at-my-property, will accompany and assist me as i deem may be necessary.

Jay-Roy: Ingold

	Jay-Roy: Ingold
	May 7, 2017

Because of these hassles I am putting my house up for sale.

I witness and acknowledge that all statements herein are true.

Lisa: Ingold
May 7, 2017

[Handwritten signature]

Registered No. RE322399225US

Date Stamp
0130
07

To Be Completed By Post Office	Reg. Fee	\$0.49	
	Handling Charge	\$11.70	Return Receipt
	Postage	\$2.75	Restricted Delivery
		\$0.00	
	Received by	CP	\$14.94

Customer Must Declare Full Value \$0.00 05/08/2017 Domestic insurance up to \$25,000 is included on the declared value. International insurance is limited. (See Reverse).

APACHE JUNCTION, AZ 85120
OFFICIAL USE

To Be Completed By Customer (Please Print) All Entries Must Be In Ballpoint or Typed	FROM	Jay-Roy Ingold, aggrieved man c/o 5142 East 18 th Avenue Apache Junction, Arizona ZIP CODE EXEMPT without the US inc. 85120
	TO	APACHE JUNCTION, AZ 85120 Elizabeth, acting as Director, Comm Devel c/o Terrilyn, acting as Code Compl Off. 575 North Idaho Street, Suite 800 Apache Junction, Arizona 85119

PS Form 3806, Receipt for Registered Mail Copy 1 - Customer
May 2007 (7530-02-000-9051)
For domestic delivery information, visit our website at www.usps.com

SENDER: COMPLETE THIS SECTION		COMPLETE THIS SECTION ON DELIVERY	
<ul style="list-style-type: none"> Complete items 1, 2, and 3. Print your name and address on the reverse so that we can return the card to you. Attach this card to the back of the mailpiece, or on the front if space permits. 		<p>A. Signature <input type="checkbox"/> Agent <input type="checkbox"/> Addressee</p> <p>B. Received by (Printed Name)</p> <p>C. Date of Delivery</p>	
<p>1. Article Addressed to:</p> <p>Elizabeth, acting as Director, Comm Devel c/o Terrilyn, acting as Code Compl Off. 575 North Idaho Street, Suite 800 Apache Junction, Arizona 85119</p>		<p>D. Is delivery address different from item 1? <input type="checkbox"/> Yes <input type="checkbox"/> No If YES, enter delivery address below:</p>	
<p>2. Article Number (Transfer from service label) RE 322399225US</p>		<p>3. Service Type</p> <p><input type="checkbox"/> Adult Signature <input type="checkbox"/> Priority Mail Express® <input type="checkbox"/> Adult Signature Restricted Delivery <input type="checkbox"/> Registered Mail™ <input type="checkbox"/> Certified Mail® <input type="checkbox"/> Registered Mail Restricted Delivery <input type="checkbox"/> Certified Mail Restricted Delivery <input type="checkbox"/> Return Receipt for Merchandise <input type="checkbox"/> Collect on Delivery <input type="checkbox"/> Signature Confirmation™ <input type="checkbox"/> Collect on Delivery Restricted Delivery <input type="checkbox"/> Signature Confirmation Restricted Delivery <input type="checkbox"/> Insured Mail <input type="checkbox"/> Insured Mail Restricted Delivery (over \$500)</p>	
PS Form 3811, July 2015 PSN 7530-02-000-9053		Domestic Return Receipt	

1227

Unno

2022-011769 MISC Page: 1230 of 2782
09/26/2022 03:35:37 PM Receipt #: 22-9381
Rec Fee: \$30.00 Darrell James Hill
Gila County, Az, Sadie Jo Bingham, Recorder



SENDER: COMPLETE THIS SECTION **COMPLETE THIS SECTION ON DELIVERY**

Complete items 1, 2, and 3.
 Print your name and address on the reverse so that we can return the card to you.
 Attach this card to the back of the mailpiece, or on the front if space permits.

1. Article Addressed to:
Pinal County Civil Hearing Office
31 N. PINAL Street
Florence, ARIZONA

 9590 9402 2795 7069 4407 33

2. Article Number (Transfer from service label)
7015 064000015883 2648

PS Form 3811, July 2015 PSN 7530-02-000-9053 Domestic Return Receipt

A. Signature Agent Addressee
X *[Signature]*

B. Received by (Printed Name) **C. Date of Delivery**
SPRINA GARCIA **5/24/17**

D. Is delivery address different from item 1? Yes No
 If YES, enter delivery address below:
P O Box 1346
Florence AZ
85132

3. Service Type
 Adult Signature Priority Mail Express®
 Adult Signature Restricted Delivery Registered Mail™
 Certified Mail® Registered Mail Restricted Delivery
 Certified Mail Restricted Delivery Return Receipt for Merchandise
 Collect on Delivery Signature Confirmation™
 Collect on Delivery Restricted Delivery Signature Confirmation Restricted Delivery
 Insured Mail Insured Mail Restricted Delivery (over \$500)

SENDER: COMPLETE THIS SECTION **COMPLETE THIS SECTION ON DELIVERY**

Complete items 1, 2, and 3.
 Print your name and address on the reverse so that we can return the card to you.
 Attach this card to the back of the mailpiece, or on the front if space permits.

1. Article Addressed to:
Imanche, acting as Director, Comm Devel
Parks, acting as Code Compl Manager
of the Territya, acting as Code Compl Off
575 North Main Street, Suite 800
Apache Junction, Arizona 85119

 9590 9402 2073 6132 0269 54

2. Article Number (Transfer from service label)
RE 322 399 225 US

PS Form 3811, July 2015 PSN 7530-02-000-9053 Domestic Return Receipt

A. Signature Agent Addressee
[Signature]

B. Received by (Printed Name) **C. Date of Delivery**

D. Is delivery address different from item 1? Yes No
 If YES, enter delivery address below:

3. Service Type
 Adult Signature Priority Mail Express®
 Adult Signature Restricted Delivery Registered Mail™
 Certified Mail® Registered Mail Restricted Delivery
 Certified Mail Restricted Delivery Return Receipt for Merchandise
 Collect on Delivery Signature Confirmation™
 Collect on Delivery Restricted Delivery Signature Confirmation Restricted Delivery
 Insured Mail Insured Mail Restricted Delivery (over \$500)

1278

2022-011769 MISC Page: 1231 of 2782
 09/26/2022 03:35:37 PM Receipt #: 22-9361
 Rec Fee: \$30.00 Darrell James Hill
 Gila County, Az, Sadie Jo Bingham, Recorder



7015 0640 0001 5883 2631

U.S. Postal Service™
CERTIFIED MAIL® RECEIPT
Domestic Mail Only

For delivery information, visit our website at www.usps.com.

FLORENCE, AZ 85131
OFFICIAL USE

Certified Mail Fee	\$3.35
Extra Services & Fees (check box, add fee as appropriate)	\$2.75
<input type="checkbox"/> Return Receipt (hardcopy)	\$0.00
<input type="checkbox"/> Return Receipt (electronic)	\$0.00
<input type="checkbox"/> Certified Mail Restricted Delivery	\$0.00
<input type="checkbox"/> Adult Signature Required	\$0.00
<input type="checkbox"/> Adult Signature Restricted Delivery	\$0.00
Postage	\$0.49
Total Postage and Fees	\$6.59

0130
02

Postmark
Here

05/09/2017

Sent To
 Street and Apt. No., or P.O. Box No.
 Mark, acting as Pinal County Sheriff
 971 Jason Circle, Building C
 Florence, Arizona 85131
 City, State, ZIP+4®

PS Form 3800, April 2015 PSN 7530-02-000-9047 See Reverse for Instructions

7015 0640 0001 5883 2631

U.S. Postal Service™
CERTIFIED MAIL® RECEIPT
Domestic Mail Only

For delivery information, visit our website at www.usps.com.

FLORENCE, AZ 85131
OFFICIAL USE

Certified Mail Fee	\$3.35
Extra Services & Fees (check box, add fee as appropriate)	\$2.75
<input type="checkbox"/> Return Receipt (hardcopy)	\$0.00
<input type="checkbox"/> Return Receipt (electronic)	\$0.00
<input type="checkbox"/> Certified Mail Restricted Delivery	\$0.00
<input type="checkbox"/> Adult Signature Required	\$0.00
<input type="checkbox"/> Adult Signature Restricted Delivery	\$0.00
Postage	\$0.49
Total Postage and Fees	\$6.59

0130
02

Postmark
Here

05/09/2017

Sent To
 Street and Apt. No., or P.O. Box No.
 Mark, acting as Pinal County Sheriff
 971 Jason Circle, Building C
 Florence, Arizona 85131
 City, State, ZIP+4®

PS Form 3800, April 2015 PSN 7530-02-000-9047 See Reverse for Instructions

1229

2022-011769 MISC Page: 1232 of 2782
09/26/2022 03:35:37 PM Receipt #: 22-9381
Rec Fee: \$30.00 Darrell James Hill
Gila County, Az. Sadie Jo Bingham, Recorder



:Darrell-James: Hill, :executor, :civilian
c/o PO Box 3806
Apache Junction, Arizona 85117

SECTION B

B) :Claim Of Wrong-Doing Surrounding This Matter Is Thrice Registered
With The Pinal County Sheriff. See: Section B appended: **second claim:**
RMN RE 322 404 040 US - :22 pages

Darrell-James -2019 Oct. 28th :Manifest of :Bill of: Trespassing contract
:PINAL COUNTY/Pinal

2022-011769 MISC Page: 1233 of 2782
09/26/2022 03:35:37 PM Receipt #: 22-9381
Rec Fee: \$30.00 Darrell James Hill
Gila County, Az, Sadie Jo Bingham, Recorder



:Jay- Roy: Ingold: man-beneficiary and Executor
c/o 5142 East 18th Avenue, Apache Junction, Arizona ZIP CODE EXEMPT
DMM 602.1.3.e2. Title 18 U.S.C. § 1342
602.499.8807

Arizona state
Pinal county

Mark: Pinal county Sheriff Lamb
PO Box 867
Florence, Arizona 85132

**RE: CLAIM: American- Indianan state citizen as :i-man --
Claim Of Criminal Wrong-Doing Upon The American -Indianan state
citizen: Jay-Roy: Ingold, et al., by the Pinal County trustee, et al. man/men
as an agent- Wrong-Doer Who Has Caused Injury to the man without
right. -USPS RMN RE 322 404 040 US- see :explanation, PINAL/Pinal
county Case No. CV 201801825 - Response And Answer, etc., annexed -**

PINAL/Pinal county Is A Trustee Under The Arizona State Covenant

Mark, greetings;

:i believe you are the man who has the title of the Sheriff: Pinal county,
Arizona.

This Is Your Second Notice Of This Wrong-Doing

1. :i-man first mailed notice of a possible problem within the May 9th write up
by a USPS CMN 7015 0640 0001 5883 2631 delivery to :you on the 11th: May:
2017, after the Pinal county trustee began to injure :me.

The :2017 May-June 8th Contract

2. The May 9th :agreement you received was activated by PINAL/Pinal county
on June 8th: 2017 at: 08:30.001 a.m., before the June 8th: 2017 Hearing-meeting.

AFFIANT: Jay-Roy: Ingold

Claim to Mark Lamb, Sheriff: Pinal co - USPS RMN RE 322 404 040 US - 1.1.5

2022-011769 MISC Page: 1234 of 2782
09/26/2022 03:35:37 PM Receipt #: 22-9381
Rec Fee: \$30.00 Darrell James Hill
Gila County, Az, Sadie Jo Bingham, Recorder



A. :i-man :Jay-Roy: Ingold - © ® 1961, an :Indianan am the beneficiary and Executor of the natural right from the Almighty God, and beneficiary- subrogee and Executor of the public trust- subrogation named :JAY ROY INGOLD~ and et al. derivatives created by the UNITED STATES government- trustee- subrogor and services provider, et seq.

B. :i am not a U.S. Citizen. :i am a literate, but a legal idiot. And: i live on my rural land and home area near the Apache Junction area, Pinal county, Arizona state. :i am a man: i am a soul: i love Almighty God. And,

:i believe that the burden of this Pinal county trustee litigation without right forces onto me a wasteful use my life and lifetime. - :i believe that the imposition of this matter upon :me, et al., is a wholly terrible drain on :my soul. And:

In the view of the fact, :i believe that this imposition being based upon fraud(s) by the Pinal trustee's infidelity hurts :me, et al., even more.

The Pinal county Is A Trustee for the man- Jay-Roy: Ingold, et al.

1. The :Pinal county-government is a trustee under The Constitution for the United States of America, CffUSofA, restricting PINAL/Pinal county From Injuring :i-man :Jay-Roy: Ingold, an Indiana state citizen, et al., and :i believe no verifiable evidence to the contrary exists.

The 2018 PINAL/Pinal county COURT Suit Against :me.

2: :my rights-executed have been stolen away: They are mine and :i want them back.

3. :i don't want to be tricked or forced to/or through a soul-less commercial court: - i don't want to be an attorney: - i don't want to be made famous by a frivolous PINAL/ Pinal county color-of-law suit. Rather: i have always simply wanted to not-be-interfered-with during my sojourn here. -

:i want :that back:

1232
Claim to Mark Lamb, Sheriff: Pinal

2022-011769 MISC Page: 1235 of 2782
09/26/2022 03:35:37 PM Receipt #: 22-9381
Rec Fee: \$30.00 Darrell James Hill
Gila County, Az, Sadie Jo Bingham, Recorder



4. The CftUSofA: Bill of Rights, 4th Amendment¹: against pretense of searches;

5. The CftUSofA: Art. I, Sec. 10², The CftUSofA: Bill of Rights, 7th³, 9th⁴, & 10th⁵ Amendments establishing :my option to be :i – man, and The Arizona Constitution, Preamble⁶, Art. 2⁷, 2.1⁸, 3⁹ and 6¹⁰....

6. :i- man see no verifiable reason that the living, breathing, with the blood flowing through the veins man- Jay-Roy: family name: Ingold can not maintain his rights-executed to be a: man; and :i believe no verifiable evidence to the contrary exists.

Pinal county's 2017 May-June 8th Contract Obligation To Jay-Roy: Ingold

7. The :Pinal political subdivision people and :i-man made the man-to-man 2017 May-June 8th Contract.

8. :i see no verifiable evidence that a PINAL/Pinal county complaint omitting the substantive-material-fact of the Pinal county's 2017 May-June 8th Contract is not fraud under the Arizona Law, and :i believe no verifiable evidence to the contrary exists.

The Clerk Problem. Why?

- 1 Bill of Rights, 4th Amendment – right to be secure in my all effects against unreasonable searches and seizures.
- 2 CftUSofA: Art. I, Sec. 10 – no state shall tender payment in gold and silver..., and legislation amounting to an “ex post facto Law, or Law impairing the Obligation of Contracts....
- 3 Bill of Rights, 7th – In suits at common law where the amount in controversy is greater 20.00, the right of trial by jury shall be preserved,....
- 4 Bill of Rights, 9th – rights numbered in the Bill of Rights is not the complete list of the rights that belong to the people.
- 5 Bill of Rights, 10th – powers not delegated to the Constitution ... are reserved to the people.
- 6 Arizona Constitution, Preamble – Preamble: We the people of the State of Arizona, grateful to Almighty God for our liberties, do ordain this Constitution.
- 7 Arizona Constitution, Art. 2: Declaration Of Rights
- 8 Arizona Constitution, Art. 2.1. Victims' Bill of Rights
- 9 Arizona Constitution, Art. 3: Distribution Of Powers
- 10 Arizona Constitution, Art. 6: Judicial Department

Claim to Mark Lamb, Sheriff: Pinal

2022-011769 MISC Page: 1236 of 2782
09/26/2022 03:35:37 PM Receipt #: 22-9381
Rec Fee: \$30.00 Darrell James Hill
Gila County, Az, Sadie Jo Bingham, Recorder



1233

9. The Pinal co. Clerk of Courts has returned my documents: my filing-fees twice, all filings but one, damaged documents, and is now literally intercepting the CERTIFICATE OF SERVICE mail that i have sent to the judge named-assigned to the matter. The Chief Judge and the Clerk have been addressed on this impasse, and they have not responded; meanwhile, this presumption that the Pinal complaint is true -approach continues.

10. Common Law Court of Record: i demanded a common-law court of record with the trial by the jury deciding all of the matters of the facts and the law.

11. i see no verifiable evidence that a trial upon the substantive material facts of this matter should not be tried in a common law court of record with the trial by the jury deciding all of the matters of the facts and the law, and i believe no verifiable evidence to the contrary exists. Moreover,

12. i see no verifiable reason to conceive that any juror in this matter would not be unsafe from the PINAL/Pinal county harassment.

Remedy: Constitutional Compliance

13. It is common knowledge that no Arizona statute supersedes the Arizona Constitution.

14. i see no verifiable evidence that the PINAL/Pinal county pursuits must or may offend the restrictions of the Arizona and United States Constitutions to the harm of i, et al., the people it is sworn to serve, protect and defend, and i believe no verifiable evidence to the contrary exists.

Protection From PINAL/Pinal county- Wrong-doers

15. i have been and am still harassed by PINAL/Pinal county actors' private predilections, and i fear for my, et al. safety from the lies, threats and malfeasance by the PINAL/Pinal county actors, etc. or proxies responsible. i-man did not and do not now want to be made famous or a victim.

Claim to Mark Lamb, Sheriff: Pinal c

2022-011769 MISC Page: 1237 of 2782
09/26/2022 03:35:37 PM Receipt #: 22-9981
Rec Fee: \$30.00 Darrell James Hill
Gila County, Az, Sadie Jo Bingham, Recorder



1234

:united States of America Citizens.

16. :i-man, et al., we, are not politically correct. :we are of the non-political aggregate. :we are the united States of America Citizens.

17. The fullness of the truth before you is now-ongoing: Mark, and has been going on for three years now. :i observe the deceptive, wrongful use of the Ariz.R.Statutes to dismantle my constitutional protections.

cc: all

annexed: **CLAIM: American- Indianan state citizen as :i-man –
Claim Of Criminal Wrong-Doing Upon The American -Indianan state
citizen: Jay-Roy: Ingold, et al., by the Pinal County trustee, et al.
man/men as an agent- Wrong-Doer Who Has Caused Injury to the man
without right. –USPS RMN RE 322 404 040 US– see :explanation,
PINAL/Pinal county Case No. CV 201801825**

Sincerely:
Without prejudice,

Jay-Roy: Ingold executor
:Jay-Roy: Ingold, beneficiary, Executor

Affirmed and autographed before me this 11 day: February 2019.
Type Identification: Arizona Driver License

Krystal Stewart
Notary public

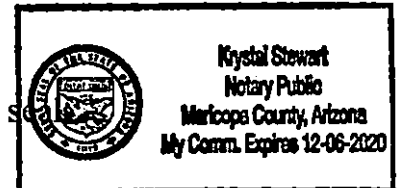

1235
Claim to Mark Lamb, Sheriff: Pinal Co. USPS RMN RE 322 404 040 US- 5-15

2022-011769 MISC Page: 1238 of 2782
09/26/2022 03:35:37 PM Receipt #: 22-9381
Rec Fee: \$30.00 Darrell James Hill
Gila County, Az; Sadie Jo Bingham, Recorder



:Jay- Roy: Ingold: beneficiary and Executor
c/o 5142 East 18th Avenue
Apache Junction, Arizona ZIP CODE EXEMPT
DMM 602.1.3.e2. Title 18 U.S.C. § 1342
602.499.8807

:man :present:

Arizona state
Pinal county

**SUPERIOR COURT OF ARIZONA
PINAL COUNTY**

:PINAL COUNTY,
:Plaintiff;

Case No. CV 201801825 –
HON. BRENDA E OLDHAM

v.

:JAY INGOLD, also know as JAY ROY
INGOLD: subrogation of the man
beneficiary: Jay-Roy: Ingold¹: sui juris
:Aggrieved Party

:Respondent- Executor;
Cross-Claimant

**A. CLAIM: American- Indianan state
citizen as :i-man- Jay-Roy: Ingold –
Claim Of Criminal Wrong-Doing Upon
The American -Indianan state citizen:
Jay-Roy: Ingold, et al.², by the Pinal
County trustee, et al. man/men as an
agent- Wrong-Doer Who Has Caused
Injury without right to the man- Jay-
Roy: Ingold. –USPS RMN RE 322 404
040 US**

v.

:Himanshu: Director, Community
Development Patel, :Paula: Code
Compliance Manager Mullenix,
Terrilyn: Code Compliance Officer
Klucar, :James: Code Compliance

**B. ANSWER AND RESPONSE
:DEMAND: Common Law Equity
Court Of Record With Trial By Jury To
Decide All Matters Of Law And Equity**

1 :Jay-Roy: Ingold means: Acknowledgment, Acceptance and Deed of Re-Conveyance: Yavapai
County Recorder: Doc # 2018-0055641.

2 Jay-Roy: Ingold, et al. means: ## 1 – 6 below.

Annex to Mark: Sheriff Lamb Pi

2022-011769 MISC Page: 1239 of 2782
09/26/2022 03:35:37 PM Receipt #: 22-9381
Rec Fee: \$30.00 Darrell James Hill
Gila County, Az, Sadie Jo Bingham, Recorder



1236

Officer Meadows, :Kent: Pinal County
Attorney Volkmer, :Craig: Deputy
County Attorney Cameron, :John-Doe,
:Jane-Doe,

C. CROSS-CLAIM:
PINAL/Pinal county, et al.,
Violation Of The Trustee Duty:
Interference With The Rights Of The
American -Indianan state citizen: Jay-
:Wrong- doers. Roy: Ingold, et al., by the Pinal County
trustee, et al. man/men as a non-agent-
Wrong-Doer Who Has Caused Injury to
the man- Jay-Roy: Ingold, et al., by the
access Of The Pinal county trustee-
Authority. DEMAND: Common Law
Court Of Record With Trial By Jury To
Decide All Matters Of Law And Fact

NECESSARY SUBMISSIONS

NECESSARY SUBMISSIONS - annexed

1. :i- man see no verifiable evidence that Necessary Submissions below
are not required for the comprehension and for an understanding of this matter,
and :i believe no evidence to the contrary exists.

01 :RESPONDENT NOTICE:
Required Joinder Of The Man- Beverly-
Jean: Romero- Hill³.

02 :RESPONDENT NOTICE:
Required Joinder Of The Man- Darrell-
James: Hill⁴.

03 :RESPONDENT NOTICE:
Required Joinder Of The Man- Tracy-
Robert: Calhoun.

12 :CLAIM: American- Indianan state
citizen as :i-man – Claim Of Criminal
Wrong-Doing Upon The American -Indianan
state citizen: Jay-Roy: Ingold, et al., by the
Pinal County trustee, et al. people as agent-
Wrong-Doers Who Have Caused Injury to the
man without right. -USPS RMN RE 322 404
040 US

13 :AFFIDAVIT: Contact With :James: Code
Compliance Officer Meadows – :AFFIANT:
Man :Tracy-Robert: Calhoun: Acquainted

3 Gila county Arizona: Doc. # 2017-002378: pp. 2-44, 93-95 of 693

4 Gila county Arizona: Doc. # 2017-002378: pp. 6-24, 93-95 of 693

Annex to Mark: Sheriff Lan

2022-011769 MISC Page: 1240 of 2782
09/26/2022 03:35:37 PM Receipt #: 22-9381
Rec Fee: \$30.00 Darrell James Hill
Gila County, Az, Sadie Jo Bingham, Recorder



04 :RESPONDENT NOTICE:
Required Joinder Of The Man- Lisa: Loeffler- Ingold.

05 :RESPONDENT NOTICE: -
Authorization For Man- Jay-Roy To Sign For Members Of The Community On The "Correction Of The Account Of The Complainants' Affidavit: Community Report - Need For Common Law Court Of Record With The Trial By Jury To Decide Upon The Facts And The Law."

06 :RESPONDENT NOTICE:
Next Best Friend :Man- Darrell-James: Hill Will Be Assisting :me And My Cause At All Meetings At My Pleasure.

07 :RESPONDENT NOTICE:
2017 May-June 8th Contract Obligations Upon The Pinal/Pinal County As Of June 8th: 08:30.01 A.M.

08 :RESPONDENT NOTICE: -
Correction Of The Account Of The Complainants' Affidavit: - Community Report - Need For Common Law Court Of Record With The Trial By Jury To Decide Upon The Facts And The Law.

09 :PRAECIPE For The Oath Of Office Of The Following Known And Unknown Persons Associated With The Complainants' Action: namedly: Himanshu: Director, Community Development Patel; :Paula: Code Compliance Manager Mullenix; :Terrilyn: Code Compliance Officer Klucar; :James: Code Compliance Officer Meadows; :Kent: Pinal County Attorney Volkmer; :Craig: Deputy County Attorney Cameron; :John-Doe; :Jane-Doe.

With The Facts, For, And, On Behalf Of :Jay-Roy: Ingold.

14 :AFFIDAVIT: Contact With :James: Code Compliance Officer Meadows - :AFFIANT: Man :Darrell-James: Hill: Acquainted With The Facts, For, And, On Behalf Of :Jay-Roy: Ingold.

15 :AFFIDAVIT: Contact With :James: Code Compliance Officer Meadows - Affiant: Man :Beverly-Jean: Romero- Hill: Acquainted With The Facts, For, And, On Behalf Of :Jay-Roy: Ingold.

16 :RESPONDENT NOTICE:
Required Joinder Of The Man- James- William: Woods.

Respondent Notice:
:PINAL/PINAL County-Government Is A Trustee For The Man-Beneficiary- Executor: Jay-Roy: Ingold.

17 :RESPONDENT NOTICE:
i-man Do Not Owe A Filing Fee - Access To This Court By This Man Jay-Roy: Ingold Is By :Right-executed Not Subject To The Statutes-Used For Privileged Persons Under License With The STATE OF ARIZONA. - Failure To Protect This Man In His Exercise Of His Right As An Indianan :American Is A Dereliction Of The Trustee Duty. - Presumption: Probable Interference Of The Rights-Executed By Concerted Violation of the man-beneficiary: Jay-Roy: Ingold, et al.

18 :RESPONDENT'S NOTICE:
:Jay-Roy's Land-Home: "ZIP Code Exempt: DMM 602.1.3.e2.: Addressing; :TITLE 18 U.S.C. § 1341:" Fraud And Swindles. - Title 18 U.S.C. § 1342; Fictitious Name Or Address.

Annex to Mark: Sheriff Lamt

2022-011769 MISC Page: 1241 of 2782
09/26/2022 03:35:37 PM Receipt #: 22-9381
Rec Fee: \$30.00 Darrell James Hill
Gila County, Az, Sadie Jo Bingham, Recorder



10 :RESPONDENT NOTICE: –
Setting Of The Presumptions

11 :RESPONDENT NOTICE:
PINAL/Pinal county- government Trustee-
Duty To The man-beneficiary- executor:
Jay-Roy: Ingold, et al.

19 :RESPONDENT NOTICE:
Unjustified Actions – Presumption: It Is
Probable That The Pinal/Pinal County Has
Committed An Unjustified Actions Against
The Man-Beneficiary: Jay-Roy: Ingold, et al.

20 :RESPONDENT NOTICE:
PINAL/ Pinal county-government Is A
Trustee For The Man-Beneficiary-
Executor: Jay-Roy: Ingold.

The :Man: Affiant: :Beneficiary -Executor Claimant

1. :i-man am a living soul – the blood flows and the flesh lives – known by the given name :Jay-Roy: family name: Ingold, an :America state citizen: Indianan -1962 of a sound mind, :beneficiary and executor of the Almighty-God-given inherent rights, and the :beneficiary- subrogee and executor of the public trust subrogation titled in the idem sonans: JAY ROY INGOLD~ et al. derivatives created by the UNITED STATES government-trustee, et al., et seq. – also including the PINAL/ Pinal county-government-trustee, STATE OF ARIZONA/ Arizona state-government-trustee.
2. :i being first duly sworn, upon the oath, states that: to the best of my knowledge all of the facts set forth herein are true and accurate.
3. :i am not a U.S. Citizen: – i-man am an Indianan.
4. :i am not a statutory defendant in this matter.
5. :i-man am a literate, but legalese- idiot.

Annex to Mark: Sheriff Lamb]

2022-011769 MISC Page: 1242 of 2782
09/26/2022 03:35:37 PM Receipt #: 22-9381
Rec Fee: \$30.00 Darrell James Hill
Gila County, Az, Sadie Jo Bingham, Recorder



6. :i do not understand the customs of the BAR society nor do :i fully comprehend the legalese of the systems of the terms of the at-law legal society, and :i believe No law exists that requires :i-man to know or understand these things.

7. Further: i am not liable to the supporting statutes-used by the PINAL/Pinal county complaint because the statutes do not apply to :me; and:

8. :i have no obligation or duty to the codes used in this matter.

9. :i see no verifiable evidence that either the Arizona Revised Statutes and the PINAL/Pinal county codes used by the PINAL/Pinal county apply to :me, and :i believe no verifiable evidence to the contrary exists.

See: 19 :RESPONDENT NOTICE: - Unjustified Actions -

PINAL/ Pinal county political subdivision- Complainant Is The County Constitutional Trustee For: :i-man :Jay-Roy: Ingold

See: 20: RESPONDENT NOTICE: - PINAL/Pinal county-government Is A Trustee

See: 11 :RESPONDENT NOTICE: - PINAL/Pinal county- government Trustee Duty

10. :i-man, et al other living souls on :my land and home area have with :me been injured by the PINAL/Pinal county wrong-doings before and after the 2017 May-June 8th Contract when :i-man conditionally accepted their offer without denying lawful options to :me as set forth in the Arizona and U.S. Constitutions.

11. :i see no verifiable evidence that the PINAL/Pinal county governing authority is not authorized to only act within the limitations set forth in the Arizona and U.S. Constitutions, and :i believe no verifiable evidence to the contrary exists.

Annex to Mark: Sheriff Lamb

2022-011769 MISC Page: 1243 of 2782
09/26/2022 03:35:37 PM Receipt #: 22-9381
Rec Fee: \$30.00 Darrell James Hill
Gila County, Az, Sadie Jo Bingham, Recorder



1240



12. :i see no verifiable evidence that the PINAL/Pinal county-government is not a trustee under the Arizona and U.S. Constitutions for the benefit and protection of :i-man, and :i believe no verifiable evidence to the contrary exists.

A. CLAIM:

13. The :Necessary Submissions are without rebuttal hereafter incorporated as the fact.

See - 12 :CLAIM: American- Indianan state citizen as :i-man- Jay-Roy: Ingold - Claim Of Criminal Wrong-Doing Upon The American -Indianan state citizen: Jay-Roy: Ingold, et al.⁵,

14. The :2017 April 5th the :PINAL/Pinal county people made an :offer threatening :me with fines and fees if :i did not be present at a hearing-meeting for the PINAL/Pinal people to continue to force :me to volunteer :my rights-executed to the/a PINAL/Pinal county authority; or, to expressly say 'No.'

See: 18 :RESPONDENT'S NOTICE: - :Jay-Roy's Land-Home

See: 01 :RESPONDENT NOTICE: Required Joinder Of The Man- Beverly-Jean: Romero- Hill⁶.

See: 02 :RESPONDENT NOTICE: Required Joinder Of The Man- Darrell-James: Hill⁷.

See: 03 :RESPONDENT NOTICE: Required Joinder Of The Man- Tracy-Robert

See: 04 :RESPONDENT NOTICE: Required Joinder Of The Man- Lisa: Loeffler-Ingold.

See: 13 :AFFIDAVIT: Contact With :James: Code Compliance Officer Meadows -

5 Jay-Roy: Ingold, et al. means: ## 1 - 6 below.

6 Gila county Arizona: Doc. # 2017-002378: pp. 2-44, 93-95 of 693

7 Gila county Arizona: Doc. # 2017-002378: pp. 6-24, 93-95 of 693

1244

:AFFIANT: Man :Tracy-Robert

See: 14 :AFFIDAVIT: Contact With :James: Code Compliance Officer Meadows –
:AFFIANT: Man :Darrell-James

See: 15 :AFFIDAVIT: Contact With :James: Code Compliance Officer Meadows –
Affiant: Man :Beverly-Jean

15. :i- man :Jay-Roy: Ingold conditionally-accepted the :Pinal offer by :my 2017
May 9th Agreement with the Pinal county people making the offer, and who accepted
and accordingly activated the agreement on: June 8th: 2017.

See: 07 :RESPONDENT NOTICE: – 2017 May-June 8th Contract

16. The 2017 May-June 8th Contract established that with the continued abuses
against my wishes by the PINAL/Pinal county people is the fee schedule owed.

See: 08 :RESPONDENT NOTICE: – Correction Of The Account

**Jurisdiction: Court of Record, Common-Law Equity With Trial-By-Jury
Deciding All Matters Of The Law And The Facts – Estoppel⁸ Demanded For The
PINAL/Pinal county's Omission of the 2017 May-June 8th Contract**

17. The :subject matter that the Complainant proposed to this court is that of
A.R.S. § 11-815, and 11-861 (A). – However:

18. A.R.S. § 11-815, and 11-861 (A) do not apply to :i-man.

See: 07 RESPONDENT NOTICE: 2017 May-June 8th Contract

19. :i see no verifiable evidence that due to :PINAL/Pinal county's omission in
their complaint filed of the 2017 May-June 8th Contract is not a fraud, and :i believe

⁸ Estoppel means: equitable estoppel demanded- means: because of the fraud upon the court,
contractual obligations must be adhered-to in the favor of :i-man.



no evidence to the contrary exists.

20. :i see no verifiable evidence that the 2017 May-June 8th Contract is not a substantial material fact over-standing the PINAL/Pinal county actions with regard to :i-man since June 8th: 2017: 08:30.001 a.m., and :i believe no evidence to the contrary exists.

21. :i see no verifiable evidence that the Complainants' actions to omit or to commit the absence of the 2017 May-June 8th Contract in their Complaint do not both result in the fraudulent act, and :i believe no evidence to the contrary exists.

COURT OF RECORD UNDER THE CONSTITUTION- With The Trial-By-Jury To Decide All Matters Of The Facts And The Law

See: 17 :RESPONDENT NOTICE: - :i-man Do Not Owe A Filing Fee

22. :i see no verifiable evidence that the PINAL/Pinal county court is not the guardian of my liberties from all offenders, and including from any PINAL/Pinal county-based abuse of authority, malfeasance or trustee violations, and :i believe no verifiable evidence to the contrary exists.

See: 20 :RESPONDENT NOTICE: PINAL/Pinal County-Government Is A Trustee

See: 11 :RESPONDENT NOTICE: PINAL/Pinal county- government Trustee- Duty

23. :i see no verifiable evidence that any PINAL/Pinal county abandonment of their contractual obligations to :i-man is not an established duty or obligation for the protection, ensurance and promotion of :my, et al. liberties under the :Arizona Constitution, and the U.S. Constitutions, and :i believe no verifiable evidence to the

124/3



contrary exists.

24. :i see no verifiable evidence that due to the 2017 May-June 8th Contract the PINAL/Pinal county has the right to interfere with :i-man's right-executed to not volunteer to contract with them to :my-disadvantage, and :i believe no verifiable evidence to the contrary exists.

25. :i see no verifiable evidence that :i-man's demanded Right Of The Trial By The Jury is not the right established to all American state citizens under The Constitution for the United States of America, henceforth CftUSofA, et seq., and :i see believe no evidence to the contrary exists.

26. :i see no verifiable evidence that the PINAL/Pinal county's violation of :Jay-Roy, et al.'s right to live peacefully on the Jay-Roy land and home area under Almighty God is not a CftUSofA, Bill of Rights, 1st Amendment violation; and :i believe no evidence to the contrary exists.

27. :i see no verifiable evidence that the PINAL/Pinal county trustee's search of the Jay-Roy land and home area and seizure of Jay-Roy's authority for it's own purposes is not a CftUSofA, Bill of Rights, 4th Amendment violation; and :i believe no evidence to the contrary exists.

28. :i see no verifiable evidence that the PINAL/Pinal county trustee's use of the Arizona Revised Statute, ARS, to obfuscate the nature and cause of the accusation without a single witness is not a CftUSofA, Bill of Rights, 6th Amendment violation;



and :i believe no evidence to the contrary exists.

29. :i see no verifiable evidence that the Pinal county trustee's suit against Jay-Roy, et al., if not at common law wherein the value in this controversy has exceeded twenty dollars (1500.00) is not a CftUSofA, Bill of Rights, 7th Amendment violation; and :i believe no evidence to the contrary exists.

30. :i see no verifiable evidence that the PINAL/Pinal county trustee's denial of :Jay-Roy's claimed-right to the common law court of record with the trial by jury to decide all the matters of the facts wherein a controversy in excess of twenty dollars (1500.00) and for which the right of trial by jury must be preserved is not a CftUSofA, Bill of Rights, 7th Amendment violation; and :i believe no evidence to the contrary exists.

31. :i see no verifiable evidence that the PINAL/Pinal county trustee's non-CftUSofA – Bill of Rights use of the Arizona Revised Statute to deny or disparage the right(s) of Jay-Roy, et al.'s, CftUSofA – Bill of Rights restrictions and to presume to impose new rights restrictions against Jay-Roy's, et al.'s wishes to live peacefully is not a CftUSofA, Bill of Rights, 9th Amendment violation; and :i believe no evidence to the contrary exists.

32. :i see no verifiable evidence that the PINAL/Pinal county trustee's use of the Arizona Revised Statute to presume powers not delegated to the United States by the CftUSofA – Bill of Rights is not a CftUSofA, Bill of Rights, 10th Amendment

1245



violation; and :i believe no evidence to the contrary exists.

33. :i see no verifiable evidence that the PINAL/Pinal county trustee's use of the Arizona Revised Statute to presume powers not delegated to the ARIZONA/Arizona state by the Arizona and U.S. Constitutions is repugnant to the Arizona and U.S. Constitutions; and :i believe no evidence to the contrary exists.

34. :i see no verifiable evidence that the Pinal county trustee's use of the Arizona Revised Statute and the people's resources in the hiding of its obligations of the substantive material fact of the 2017 May-June 8th Contract for which it is obligated to the man- Jay-Roy is not an Arizona Constitution: Art. 2. Sec. 25 and a CftUSofA: Art. 1, Sec. 10 naked violation, and :i believe no evidence to the contrary exists. –

35. The :fee schedule contract is :one silver dollar per minute, calculated from the 5th: April 2017: 5:00 p.m. until the end of this matter, and due-paid upon a request.

Equitable-Estoppe⁹ Demanded

37. All references, inferences to allegations mentioned above are without rebuttal hereafter incorporated as the fact.

38. From after the time agreed, :2017 June 8th: 08:30 a.m., all of the actions on this matter were governed by the limits of the 2017 May-June 8th Contract, –

39. Omission of the 2017 May-June 8th Contract: i see no verifiable evidence that a PINAL/Pinal county fraud-by-omission would not impair the PINAL/Pinal county

⁹ Cp/ equitable estoppel: Estoppel means: ... the prevention of a person from making an affirmation or denial because it is contrary to a previous affirmation or denial that he has made; prohibition.

12/16



obligations to the 2017 May-June 8th Contract with the man- Jay-Roy, and :i believe no evidence to the contrary exists.

40. :i see no verifiable evidence that the PINAL/Pinal county's omission of the substantial material fact of the 2017 May-June 8th Contract was not fraud upon the court, and :i believe no evidence to the contrary exists.

41. Inducement Warranting Estoppel: The: Hearing-meeting, et seq. of the 8th of June 2017 . :i believe the deprivation of :my rights-executed in the contract was followed by a pattern with the continued interference of :my rights-executed.

42. :i see no verifiable evidence that the PINAL/Pinal county has not intentionally used the PINAL/Pinal county Hearing office to injure :i-man for not volunteering to the PINAL/Pinal county commercial offers generally, and expressly byway of the 2017 May-June 8th Contract, and :i believe no evidence to the contrary exists.

43. :i believe any inducement to my harm by the June 8th Hearing Pinal people against :i-man is evidence of the fraud warranting equitable estoppel.

44. Inducement Warranting Estoppel: The: Affidavit Of James Meadows ... : # 13:
- :i believe that :James used annoying harassment, a nuisance with the stalking and menacing unannounced intrusion upon our peace about the land and home area as a pretense to induce contacts with :i-man :Jay-Roy: Ingold, et al.

ANSWER AND RESPONSE :DEMAND: ...

To The Affidavit By The Man- James: Meadows In Support Of Complaint

45. All references, inferences to allegations mentioned above and affidavits are

Annex to Mark: Sheriff Lamb Pinal county_ USPS RMN RE 322 404 040 US

1247



ITEM 5 above.

55. ITEM: 11: The Complaint with the Pinal County Hearing Office communicated threats to harm :i-man, et al. See: ITEM 5 above.

56. ITEM: 12: i-man visited to the June 8th, 2017 meeting under the 2017 May-June 8th Contract – USPS RMN RE 322 399 225 US – See: ITEM 11 above.

57. ITEM: 13: See: ITEM 5.

C. CROSS-CLAIM:

PINAL/Pinal county, et al., Violation Of The Trustee Duty

58. All references, inferences to allegations mentioned above and affidavits are without rebuttal hereafter incorporated as the fact. See: #28 above, et seq.

59. :i man-beneficiary have been injured by the PINAL/Pinal county people actors who affirm they are acting in their wrong-doings under the direction of - and on behalf of- the PINAL/Pinal county government-trustee, and :i believe no verifiable evidence to the contrary exists.

60. :i see no verifiable evidence that the people identified in the cross-claim are not the people of the record who in concert are responsible to the CLAIM for the injury to :i- man-beneficiary, et al., and :i believe no verifiable evidence to the contrary exists.

61. :i see no verifiable evidence that any man doing the good-work for the PINAL/Pinal county government-trustee should not be protected from the inadvertent liability as necessary by the use of the county people's money and resources; and :i

1248



believe no verifiable evidence to the contrary exists.

62. :i see no verifiable evidence that any man not doing the good-work for the PINAL/Pinal county government-trustee should be protected from the inadvertent liability as necessary by the use of the county people's money and resources because he is not performing the office or authorization of the PINAL/Pinal county delegated authority, and :i believe no verifiable evidence to the contrary exists.

63. :i see no verifiable evidence that when a man/men is working using the resources of the PINAL/Pinal county in any criminal pursuance then :he must be held personally liable for his criminal actions, and :i believe no verifiable evidence to the contrary exists.

64. :i see no verifiable evidence that when the PINAL/Pinal county government-trustee abandons the obligation and duty to :i- man-beneficiary for to aid and abet criminal behavior against :i- man-beneficiary, et al., then the Pinal county trustee is directly personally liable for all of the resultant injuries and embarrassments imposed upon and suffered by :i- man-beneficiary, et al., and :i believe no verifiable evidence to the contrary exists.

Jurisdiction: Court of Record, Common-Law With Trial-By-Jury Deciding All Matters Of The Law And The Facts -- For The PINAL/Pinal county actors using their positions in the injury of : i- man-beneficiary :Jay-Roy: Ingold, et al.

65. All references, inferences to allegations mentioned above and affidavits are without rebuttal hereafter incorporated as the fact. See # 9- 10, inclusive, above.

1249



66. :i see no verifiable evidence that when criminal activity-by-fraud by the people in the position under the PINAL/Pinal county is openly identified then the activity must be presumed to be fraudulent, and :i believe no verifiable evidence to the contrary exists.

67. :i see no verifiable evidence that a common law court of record with the trial-by-jury deciding all matters of the law and the facts of this cross-claim would not best serve to protect :i- man-beneficiary, et al.'s, interests, and :i believe no verifiable evidence to the contrary exists.

68. DEMAND: Common Law Court Of Record With Trial By Jury To Decide All Matters Of Law And Fact concerning the substantial material facts revealed under the Cross-Claim.

Without Prejudice

Jay-Roy: Ingold executor
Jay-Roy: Ingold, beneficiary- respondent-
Executor

Verified and autographed before me this 11 day: February; 2019 A.D.;
:Type- Identification: Arizona Driver License

Krystal Stewart
notary

Seal



1250

RE322404040US

Postage \$ **\$7.85**

Extra Services & Fees

Registered Mail \$ **\$12.40**

Return Receipt (hardcopy) \$ **\$2.80**

Return Receipt (Electronic) \$ **\$0.00**

Restricted Delivery \$ **\$0.00**

Extra Services & Fees (continued)

Signature Confirmation

Signature Confirmation Restricted Delivery

Total Postage & Fees

Customer Must Declare Full Value \$ **\$0.00**

Received by **85120** on **02/12/2019**

Domestic Insurance up to \$50,000 is provided upon the purchase of postage. International insurance is limited. (See Reverse)

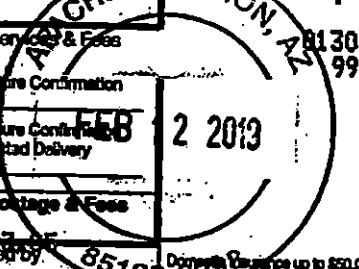

OFFICIAL USE

APACHE JUNCTION, AZ 85120

FROM: Jay Reg. Leguit, c/o 5142 East 18th Avenue, Apache Junction, Arizona

TO: Mark Pinal county Sheriff Lamb, PO Box 867, Florence, Arizona 85132

PS Form 3806, Registered Mail Receipt Copy 1 - Customer

APACHE JUNCTION
151 W SUPERSTITION BLVD
APACHE JUNCTION
AZ
85120-9998
0302590130
02/12/2019 (800)275-8777 11:32 AM

Product Description	Sale Qty	Final Price
PM 2-Day (Domestic) (FLORENCE, AZ 85132) (Weight: 1 Lb 4.40 Oz) (Expected Delivery Date) (Thursday 02/14/2019)	1	\$7.85
Registered (Amount: \$0.00) (USPS Registered Mail #) (RE322404040US)	1	\$12.40
Return Receipt (USPS Return Receipt #) (9590940242158121976354)	1	\$2.80
Total		\$23.05
Cash Change		\$25.00 (\$1.95)

Total \$23.05

Cash Change \$25.00 (\$1.95)

Includes up to \$50 insurance

Text your tracking number to 28777 (2USPS) to get the latest status. Standard Message and Data rates may apply. You may also visit www.usps.com USPS Tracking or call 1-800-222-1811.

In a hurry? Self-service kiosks offer quick and easy check-out. Any Retail Associate can show you how.

COMPLETE THIS SECTION ON DELIVERY

A. Signature *[Signature]*

B. Received by (Printed Name) *Jay Reg. Leguit*

C. Date of Delivery *FEB 13 2019*

D. Is delivery address different from item? Yes No

If YES, enter delivery address below

Services Type: Priority Mail Express® Registered Mail™ Certified Mail® Collect on Delivery Insured Mail (over \$500)

Additional Services: Signature Confirmation™ Signature Confirmation Restricted Delivery Return Receipt for Merchandise Signature Confirmation Restricted Delivery

Domestic Return Receipt

Mark: Pinal county Sheriff Lamb, PO Box 867, Florence, Arizona 85132

9590 9402 4215 8121 9763 54

RE 322 404 940 US

PS Form 3811, July 2016 PSN 7530-02-000-9053

SENDER: COMPLETE THIS SECTION

Complete items 1, 2, and 3, so that we can return the card to you. Attach this card to the back of the mailpiece, or on the front if space permits.

Article Addressed to:

2022-011769 MISC Page: 1254 of 2782
09/26/2022 03:35:37 PM Receipt #: 22-9381
Rec Fee: \$30.00 Darrell James Hill
Gila County, Az, Sadie Jo Bingham, Recorder





:Darrell-James: Hill, :executor, :civilian
c/o PO Box 3806
Apache Junction, Arizona 85117

SECTION B

B) :Claim Of Wrong-Doing Surrounding This Matter Is Thrice Registered
With The Pinal County Sheriff. See: Section B appended: **third claim:**
RMN: RE 322 404 053 US - :59 pages

Darrell-James -2019 Oct. 28th :Manifest of :Bill of: Trespassing contract
:PINAL COUNTY/Pinal county RMN RE 322 404 169 US

1252



:Jay- Roy: Ingold: man-beneficiary and Executor
c/o 5142 East 18th Avenue, Apache Junction, Arizona ZIP CODE EXEMPT
DMM 602.1.3.e2. Title 18 U.S.C. § 1342
602.499.8807

Arizona state
Pinal county

Mark: Pinal county Sheriff Lamb
PO Box 867
Florence, Arizona 85132

**CLAIM OF CRIMINAL WRONG-DOING;
WANT FOR RELIEF FROM THE CRIMINAL WRONG-DOERS
BY THE SHERIFF**

RE: Claim Of *Continued¹ Criminal Wrong-Doing Upon The man-beneficiary- Indianan state citizen: Jay-Roy: Ingold, et al., by some Pinal County trustee, et al. agents- Wrong-Doer(s) Who Has Caused Injury to :i- man by their interference with :my, et al. property and administration of my, et al. property without right.

RE: I. NOTICE: GOOD-FAITH COMMUNICATION WITH :Craig :Pinal County Attorney ON HIS, ET AL.'S OMISSION OF THE SUBSTANTIAL MATERIAL FACT OF THE PINAL/Pinal county 2017 MAY-JUNE 8TH CONTRACT² OBLIGATIONS TO :i- man-beneficiary: Jay-Roy: Ingold; and: four witness statements. – ATTACHED

1 CLAIM: American- Indianan state citizen as :i-man – Claim Of Criminal Wrong-Doing Upon The American -Indianan state citizen: Jay-Roy: Ingold, et al., by the Pinal County trustee, et al. man/men as an agent- Wrong-Doer Who Has Caused Injury to the man without right. – USPS RMN RE 322 404 040 US– see :explanation, PINAL/Pinal county Case No. CV 201801825 – Response And Answer, etc., annexed – USPS RMN RE 322 404 040 US , delivered: you: Wednesday, February 13th 2019

2 2017 MAY-JUNE 8TH CONTRACT means: the acquiescence of the 2017 May 9th conditional acceptance in response to the PINAL/Pinal county's final Hearing offer; activated on: 2017 June 8th: 08:30.001 a.m. by the actions and acquiescence of the conditional acceptance. Exhibit B

March 2019 Claim3/3 same to Mark Lamb, Sheriff: Pinal co. USPS RMN RE 322 404 053 US 1 / 5

1253



II. February 20th 2019 letter received from :Amanda³: Pinal Clerk-of-the-Superior-Court Stanford. – ATTACHED

Mark, greetings;

AFFIANT: Jay-Roy: Ingold

A. :i-man :Jay-Roy: Ingold - © © 1961, an :Indianan am the beneficiary and Executor of the natural right from the Almighty God, and beneficiary- subrogee and Executor of the public trust- subrogation named :JAY ROY INGOLD~ and et al. derivatives created by the UNITED STATES government- trustee- subrogor and services provider, et seq.

B. :i am not a U.S. Citizen. :i am a literate, but a legal idiot. And: i live on my rural land and home area near the Apache Junction area, Pinal county, Arizona state. :i am a man: i am a soul: i love Almighty God. And,

:i believe that the burden of this Pinal county trustee litigation without right forces onto me a wasteful use my life and lifetime. – :i believe that the imposition of this matter upon :me, et al., is a wholly terrible drain on :my soul. And:

In the view of this/these fact(s), :i believe that this imposition being based upon the use of the presumptions by the fraud(s) by the Pinal trustee's infidelity damages :me, et al., even more.

The Pinal county Is A Trustee for the man- Jay-Roy: Ingold, et al.

I. NOTICE: GOOD-FAITH COMMUNICATION WITH :Craig :Pinal County Attorney ON HIS, ET AL.'S OMISSION OF THE SUBSTANTIAL MATERIAL FACT OF THE PINAL/Pinal county 2017 MAY-JUNE 8TH CONTRACT⁴ OBLIGATIONS TO :i- man-beneficiary: Jay-Roy: Ingold; and: four witness statements. – ATTACHED

3 February 20th 2019 letter received from :Amanda means: The predisposition is in the evidence of a continued denial of :i- man's, et al. access to the Pinal county court of record – and, now the evidence of the same is in your possession.

4 2017 MAY-JUNE 8TH CONTRACT means: the acquiescence of the 2017 May 9th conditional acceptance in response to the PINAL/Pinal county's final Hearing offer; activated on: 2017 June 8th: 08:30.001 a.m. by the actions and acquiescence of the conditional acceptance. Exhibit B

March 2019 Claim3/3 same to Mark Lamb, Sheriff: Pinal co. USPS RMN RE 322 404 053 US 2 / 5

1254



1. :i- man-beneficiary- Executor: Jay-Roy believe you are the man who has the title of the Sheriff: Pinal county, Arizona. The *Continued Criminal Wrong-Doing is by the PINAL/Pinal county Is A Trustee Under The Arizona State Covenant.

2. As the evidence now in your possession establishes, the presumption is that a few PINAL/Pinal county trustee agents that are engaged in what appears to be a collusion by the misfeasance and malfeasance to use the people's office and resources to oppress :i-man- Jay-Roy, et al. souls, the :people- beneficiaries.

3. Mark, :i want :my rights restored-back to :i- man, et al. souls living at my land and home area. – Is not this within your power and duty and obligation as sheriff; that is, to inquire now upon this request, and to get to the stoppage of this active threat to :i- man, et al.?

4. We the people herein are few but representative of a much larger number of people experiencing how that some PINAL/Pinal county-government trustees must not work against :i- man in the despise of their oaths of the fidelity, duty and obligation.

5. :i- man believe that all PINAL/Pinal county officials, et al. must absolutely be sure there is no possible validity to a Claim as :i- man have to be provided in the evidence and delivered to :you.

The Clerk Problem. . . Collusion?

II. February 20th 2019 letter received from :Amanda^s: Pinal Clerk-of-the-Superior-Court Stanford. – ATTACHED

6. As previously referenced to you, and again within this letter to :you now

5 February 20th 2019 letter received from :Amanda means: The predisposition is in the evidence of a continued denial of :i- man's, et al. access to the Pinal county court of record – and, now the evidence of the same is in your possession.

March 2019 Claim3/3 same to Mark Lamb, Sheriff: Pinal co. USPS RMN RE 322 404 053 US 3 / 5

1255



Mark, it appears that clerk of the PINAL/Pinal county Superior court is not immune to the Sheriff's questioning of their Arizona and U.S. Constitutional compliance in any claim regarding the any matter.

7. :i- man have been deprived by: Amanda: Clerk of Court of the access to the court-of-record or to respond to the allegations made by the PINAL/Pinal county in a color of law suit, which makes responding VERY DIFFICULT.

8. Four or more times now have the :clerks prevented/ blocked :i- man's access of the right to the court-of-record in the order for to address the :PINAL/Pinal county's harm, injury and damage upon :i-man. See Attachment: I. NOTICE: GOOD-FAITH... Exhibit C.

Protection From PINAL/Pinal county- Wrong-Doers In The Collusion

:Mark: Sheriff Lamb

9. :i- man require/ wish/ request/ demand for you to:

a) investigate this matter for the violations alleged by the documentation delivered to your possession; and:

b) impose an administrative suspension that any PINAL/Pinal county officers, et seq. pursuits against :i- man, et al. must be administratively stopped by the sheriff and deputies until this matter is clarified with the advantage and benefit to the beneficiary :i- man, et al. Thank- you.

cc: all

Attachments

- I. NOTICE: GOOD-FAITH COMMUNICATION WITH :Craig :Pinal County Attorney ON HIS, ET AL.'S OMISSION OF THE SUBSTANTIAL MATERIAL FACT OF THE PINAL/Pinal county 2017 MAY-JUNE 8TH CONTRACT OBLIGATIONS TO :i- man-beneficiary: Jay-Roy: Ingold; and: four witness statements.**

1256



II. February 20th letter received from :Amanda: Pinal Clerk-of-the-Superior-Court Stanford. The predisposition is in the evidence of a continued denial of :i- man's, et al. access to the Pinal county court of record – and, now the sum- evidence of the same is in your possession.

:i- man verify under the Almighty-God that the aforesaid is the true and correct to the best of my knowledge, and will testify to the same in the open court.

Sincerely:
Without prejudice,

Jay-Roy : Ingold executor
:Jay-Roy: Ingold, beneficiary- Executor

Witness: Beverly Jean: Lomen Executor
beneficiary- Executor

Address: same as above

Witness: Darrell - James Hill executor
beneficiary- Executor

Address: same as above



:Jay- Roy: Ingold: beneficiary and Executor
c/o 5142 East 18th Avenue
Apache Junction, Arizona ZIP CODE EXEMPT
DMM 602.1.3.e2. Title 18 U.S.C. § 1342
602.499.8807

:man :present: Ingold court of record: Case No. 7018-0360 0000 5968 6115¹, at:

Arizona state
Pinal county

**SUPERIOR COURT OF ARIZONA
PINAL COUNTY**

Jay-Roy: Ingold²: sui juris: Aggrieved (RE: CV 201801825 – PINAL v.
-Respondent: Executor, INGOLD: Brenda-E.: Oldham)
Claimant

v.

:PINAL COUNTY, :Himanshu:
Director, Community Development
Patel, :Paula: Code Compliance
Manager Mullenix, Terrilyn: Code
Compliance Officer Klucar, :James:
Code Compliance Officer
Meadows, :Kent: Pinal County
Attorney Volkmer, :Craig: Deputy
County Attorney Cameron, :John-Doe,
:Jane-Doe,

**NOTICE: GOOD-FAITH
COMMUNICATION WITH :Craig
:Pinal County Attorney ON HIS, ET
AL.'S OMISSION OF THE
SUBSTANTIAL MATERIAL FACT
OF THE PINAL/Pinal county 2017
MAY-JUNE 8TH CONTRACT³
OBLIGATIONS TO :i- man-
beneficiary: Jay-Roy: Ingold**

:Wrong- doers.

- 1 Establishment: Case No. 7018 0360 0000 5968 6115. See: Re: Case No... . Exhibit A
- 2 :Jay-Roy: Ingold means: Acknowledgment, Acceptance and Deed of Re-Conveyance: Yavapai County Recorder: Doc # 2018-0055641.
- 3 2017 MAY-JUNE 8TH CONTRACT means: the acquiescence of the 2017 May 9th conditional acceptance in response to the PINAL/Pinal county's final Hearing offer, activated on: 2017 June 8th: 08:30.001 a.m. by the actions and acquiescence of the conditional acceptance. Exhibit B

1258



AFFIANT

:i-man (:Jay-Roy: family name Ingold) am a living soul, – the blood flows and the flesh lives – :beneficiary and executor of the Almighty-God-given inherent rights, and the :beneficiary- subrogee and Executor of the public trust subrogation: JAY ROY INGOLD~ et al. derivatives created by the UNITED STATES government-trustee -subrogor, et al.

To the best of my knowledge, the facts set forth herein are true and accurate. :i-man am literate, but a legal-idiot. :i am not a UNITED STATES Citizen.

:i- man made my home here in Pinal county on my land and home-area several years past in order that :i would Not now have to experience this type of PINAL/Pinal county people- trespass upon my property in an attempt to administrate my property without the right.

THE: GOODWILL- GOOD-FAITH COMMUNICATION WITH :CRAIG :PINAL COUNTY ATTORNEY, ON THE COMMISSION/ OMISSION OF THE Ingold- Pinal County- 2017 MAY-JUNE 8TH CONTRACT OBLIGATIONS BY THE ABSOLUTE NON- PRESENTMENT OF THE SUBSTANTIAL MATERIAL FACT OF THE OBLIGATION IN HIS CERTIFIED SUBMISSION TO THE COURT

1. :i- man believe that :Craig, et al., answered in the silence to-date about the matter identified in the affidavit(s) that :he, et al. received wherein :i- man- beneficiary, et al. communicated to the PINAL/Pinal county, et al. in/by the

1259



documents deposited to them by: USPS mail delivery(-ies): e.g.: see the non-filing and non-receipt statements, refusals and denials at-will of the obligations and duty of the service by the PINAL/Pinal county court clerk system. -- annexed: 9 pages:

Exhibit C.

A. INTRODUCTION: Letter For The Good Faith Consultation

See: Respondent Notice: To The Pinal/ Pinal County:-Craig :DEPUTY County Attorney Cameron: Attempt To Resolve The Matter's Of The Fraud By The Good Faith Consultation – Sent By USPS CMN 7018036000059688850 To Craig; received: February 01, 2019: 09:59 am. - annexed: 6 pages, Exhibit D.

B. TELEPHONIC MEETING: 2019 February 15th; For The Good Faith Consultation with :Craig regarding the Omission of the Substantive Material Fact-evidence of the PINAL/Pinal county's 2017 May-June 8th Contract-Obligation to :i- man - Jay-Roy: Ingold.

a	Jay-Roy:	This is :Jay	
b	Craig:	This is :Craig Cameron.	
c	Jay-Roy:	Hi :Craig	
d	Craig:	Sorry we were not connecting right off, but I'm back from court..[?]. So, you'd called and you'd wanted to talk?	
e	Jay-Roy: (Darrell- James: supporting Jay)	Yes. Yeah, there was a uh..., other people here, uh, with me, they're are a part of the matter, : <u>my. uh. wife</u> ⁴ , and <u>Darrell</u> ⁵ and <u>his wife</u> ⁶ and, uh, <u>Tracy</u> ⁷ .	Note: <u>my wife</u> - Lisa Note: <u>his wife</u> - Beverly-Jean

4 My wife means: Lisa: Loeffler- Ingold. See CLAIM: Exhibit Two
 5 Darrell means: Darrell-James: Hill. See CLAIM: Exhibit Two
 6 His wife means: Beverly-Jean: Romero- Hill. See CLAIM: Exhibit Two
 7 Tracy means: Tracy-Robert: Calhoun. See CLAIM: Exhibit Two

1260



	<p>Um, 'wanted to talk about the: ..what :i consider fraud in the, uh, leaving out of the <u>contract</u>⁸, out of the affidavit: that was uh.., not in: uh: omission.</p>	<p>Note: <u>contract</u> means: the acquiescence of the <u>2017 May 9th conditional acceptance</u> in response to the PINAL/Pinal county's final Hearing offer; <u>activated on: 2017 June 8th: 08:30.001 am.</u> by the actions and acquiescence of the conditional acceptance onward unto that moment by the PINAL/Pinal county under the Arizona and U.S. Constitutional Laws, et seq.</p>
<p>f Darrell-James: (supporting Jay)</p>	<p>It was omission of the contract and his work.</p>	
<p>g Craig:</p>	<p>What contract?</p>	
<p>h Jay-Roy: Darrell-James: (supporting Jay)</p>	<p>The contract that :i had mailed to Himanshu, Paula and Terrilyn</p>	<p>See: May 07-09th :2017 - USPS 322 399 225 US to: Himanshu, Paula and Terrilyn</p>
<p>i Craig:</p>	<p>Did you <u>draft</u> the contract?</p>	
<p>j Jay-Roy:</p>	<p>Yes</p>	<p>Note: <u>draft</u> means: to write the '2017 May 9th conditional acceptance of the PINAL/Pinal county Hearing offer.'</p>

⁸ Contract means: 2017 May-June 8th Contract: See: May 07-09th :2017 - USPS 322 399 225 US to: Himanshu, Paula and Terrilyn: PINAL/Pinal county assets. See CLAIM: Exhibit B.

1261
 UNOFFICIAL



k	Craig:	Did you get it approved by the Board of Supervisors?
l	Jay-Roy:	It went to the people directly.
m	Craig:	Did it get approved by the Board of Supervisors? They can't commit the county, only the Board of Supervisors can commit the county on any contract.
n	Jay-Roy:	Um.. don't know what you're, uh: I don't understand that, this was a man to man contract that we were doing, and they submitted my contract into the hearing, to me that executed the contract. And, I thought the contract was good because they left me alone for a long time, and now they're uh not doing that. So by leaving those statements out of that affidavit that he gave us, he's leaving, uh, out the fact of contract.
o	Darrell-James: (supporting Jay)	Material fact of contract.
p	Jay-Roy:	"substantive material fact of contract out of his affidavit.
q	Darrell-James: (supporting Jay)	So, it's fraud.
r	Craig:	OK, um, no it's not, um: i -I take it Mr. Ingold you have no intentions of abating the nuisance on your property?
s	Darrell-James: (supporting Jay)	It's only about (D, patting paper): then the conversation's over.
t	Jay-Roy:	Uh, we thought ... (speaking interjected by :Craig; ending of the meeting by :Craig)
u	Craig:	! Thank you. Goodbye.

2. During the Good-faith meeting conversation with :Craig, the :man- Craig



said words that :i do Not understand what he meant; e.g.: draft, abatement, nuisance, and mister.

3. After the man- Craig used the: 'abatement'- sentence – see: letter r. (above),

– :i suspected that the man -Craig was trying to somehow impose a harm upon me- :i- man.

4. :i see no verifiable evidence that the PINAL/Pinal county-trustee can be

not- participating in this matter against any PINAL/Pinal county officers,

employees or others involved in the/a misfeasance or malfeasance to induce any

trespass or injury onto :i- man -beneficiary, and :i believe no verifiable evidence to

the contrary exists.

C. THE OUTCOME OF THE FEBRUARY 15th 2019 TELEPHONIC MEETING IS WITH THE Obfuscation OF THE COMMISSION/ OMISSION BY THE man- Craig :Pinal County Attorney UPON his, et al.'s OMISSION OF THE SUBSTANTIAL MATERIAL FACT OF THE PINAL/Pinal county 2017 MAY-JUNE 8TH CONTRACT OBLIGATIONS

5. :i- man see no verifiable evidence that the PINAL/Pinal county is not now

subject to the contractual obligations, restrictions and duties under the Arizona and

U.S. Constitutions, and :i- man believe no evidence to the contrary exists.

6. :i believe the public servants are obligated to help :i- man, et al. to be

rightfully Constitutionally not-interfered-with by their actions: that is, public

servants are under oath not to impose, aid or abet unconstitutional actions

repugnant to the Arizona and U.S. Constitutions for any reason.

7. :i- man see no verifiable evidence that the PINAL/Pinal county is not now under the duty and obligation contract with the Arizona and U.S. Constitutions for the absolute defense of :i- man's all inherent rights and rights-executed, and :i- man believe no evidence to the contrary exists.

8. :i see no verifiable evidence that any PINAL/Pinal county trust-asset used must be not- used except for to only promote, protect and ensure :i-man's rights-executed, and :i- man believe no verifiable evidence to the contrary exists.

9. :i- man see no verifiable evidence that the PINAL/Pinal county -trustee is not in error to use any PINAL/Pinal county person(s) or asset(s) for the support of any wrong-doing in any proposed controversy wherein it has harmed or injured :i- man-beneficiary, et al., and i- man believe no evidence to the contrary exists.

10. :i see no verifiable evidence that the man- Craig: PINAL/Pinal county Attorney, et al. did not willfully commit a fraud upon their omission to openly report on the substantial material fact-evidence of the violation of the PINAL/Pinal county- trustee-fiduciary duty and contractual obligations agreed to under the Arizona and U.S. Constitutions, et seq. and: 2017 May-June 8th Contract to assure, protect and promote onto :i- man-beneficiary no trespass- harm or injury, and :i believe no evidence to the contrary exists.

11. :i- man see no verifiable evidence that the PINAL/Pinal county is not under the duty and obligation to only solve this matter of their interference upon :i-man's



property to the best advantage of the beneficiary, and :i- man- beneficiary believe
no evidence to the contrary exists.

Without Prejudice

Jay-Roy Ingold Executor
Jay-Roy: Ingold, beneficiary Independent-
Executor



Verified and autographed before me this 28th day: February: 2019 A.D.;
:Type- Identification: Arizona Driver License

[Signature]

notary

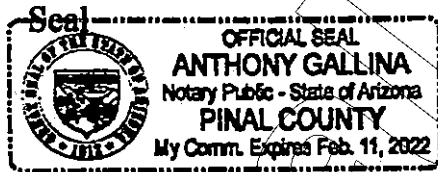

Unofficial
2/25



Unofficial Copy

Exhibit A

Exhibit A

Exhibit A

Exhibit A

Exhibit A



Jay-Roy: Ingold: beneficiary; Executor
c/o 5142 East 18th Avenue
Apache Junction, Arizona ZIP CODE EXEMPT
DMM 602.1.3.e2. Title 18 U.S.C. § 1342
602.499.8807

Arizona state
Pinal county

:man :present:

:Amanda: Superior Court Clerk Stanford
Pinal County Superior Court
PO Box 2730
Florence, AZ 85132

RE: Case No. CV201801825, PINAL COUNTY :Plaintiff V. JAY INGOLD,
also know as JAY ROY INGOLD: subrogation of the man beneficiary: Jay-
Roy: Ingold: sui juris :Aggrieved Party-Respondent, :Executor.

USPS Money Order # [REDACTED] in the amount demanded: 230.00 for the
case noted above. See face copy of same below:

i: Man :Beneficiary: Respondent-Executor

:i-man am a living man – the blood flows and the flesh lives – given name :Jay-Roy:

family name: Ingold: Indianan -1962: of sound mind, :beneficiary and executor of the

Almighty-God-given natural rights, and the :beneficiary- subrogee and executor of the

public trust subrogation named: JAY ROY INGOLD~ et al. derivatives created by the

UNITED STATES government-trustee, et al., et seq. – also including the PINAL/

Pinal county-government-trustee, STATE OF ARIZONA/ Arizona state-government-

trustee. :i am not a U.S. CITIZEN.

USPS Money Order # [REDACTED] in the amount demanded: 230.00 from PO

230.00 paid ;Pinal under duress USPS CMN: 7018 0360 0000 5968 6115

1/2

1267

COPY



853300

1. This amount demanded: 230.00 for the case noted above is paid to address injury(s) to :i, et al., from damages imposed by the Pinal trustee, et al. in a common law court of record with the trial by jury to decide all matters of the facts and the law.
2. This is the third attempt.
3. If you do not accept this payment then do not mutilate this money order.
4. The: 230.00 amount paid is under duress: Notice to agent is notice to the principal; notice to principal is notice to the agent.

UNITED STATES POSTAL SERVICE
POSTAL MONEY ORDER

Serial Number: [REDACTED] Dollars and Cents: \$230.00

Pay to: Pinal County
Address: P.O. Box 27
Florence, Arizona
Memo: CV 2018

Ingold
DURESS
15th Ave

U.S. MAR 1955

02008 United States Postal Service. All Rights Reserved. POSTAL MONEY ON THE U.S. AND POSSESSIONS

1:000000800 21:

Without Prejudice
JAY ROY INGOLD :subrogation

Jay-Roy: Ingold executor
Jay-Roy: Ingold, beneficiary- respondent-
Executor

230.00 paid ;Pinal under duress USPS CMN: 7018 0360 0000 5968 6115 2/2



Exhibit B

Exhibit B

Exhibit B

Exhibit B

Exhibit B

1269

Unofficial Copy



Jay-Roy Ingold
 c/o 5142 East 18th Avenue
 Apache Junction, Arizona ZIP CODE EXEMPT
 DMM 602.1.3.e2. Title 18 U.S.C. § 1342

Himanshu, acting as Director, Community Development
 Paula, acting as Code Compliance Manager
 c/o Terrilyn, acting as Code Compliance Officer RE 322 399 225 US
 575 North Idaho Street, Suite 800
 Apache Junction, Arizona 85119

Re: 5124 East 18th Avenue, Apache Junction, Arizona

NOTICE	a)	EX POST FACTO LAW VIOLATION;
	b)	CRIMINAL COMPLAINT;
	c)	FEE SCHEDULE
DEMAND	i)	DISCHARGE COMPLAINT - CANCEL HEARING, and
	ii)	CEASE AND DESIST; or
	iii)	COMMON LAW PROCEEDING

Himanshu, Paula, Terrilyn, Greetings:

i: man am writing: because i have received various requests for changes i voluntarily made upon my property in good faith. i made significant changes and sent you photos, etc. improving the general appearance of my property. However, you have violated your Oath of Office and duty to persist to impose upon me further DEMAND LETTER(s) and a COMPLAINT seeking further to impose Code Violations for my parcel "103-14-012B" that you knew or should have known was ACQUIRED in 2008!

Address Above: It is a felony for you to send mail to an address that is not a proper mailing address, or a fictitious mailing address. My proper mailing address is as indicated above; if you intend to send mail to another address then you intend to be guilty of mail fraud.

NOTICE:

Your actions are repugnant to the Constitution for the United States of America people, and the subsequent subordinate laws. You have mistakenly presumed that your code violations AND counts somehow applied to me; so, let me be clear:

a)	your application of code violations AND counts do Not apply to me;
b)	you have threatened to impose fines and/or create other hardship that Never before existed! if i do not comply with your demands;
c)	you have progressed to: a) threat of abuse, b) under the color of law; and,
d)	Your "CODE ENFORCEMENT OFFICER VERIFICATION", on the April 5,

1270



2017, COMPLAINT, is perjury if a) you knew or should have known that b) my parcel at 5124 E. 18th Ave. has been in my ownership since 2008; that: c) the codes were contrived years later, even 2010; d) no man has made a claim; and, e) your verification is repugnant to the United States and Arizona constitutions Ex post facto law prohibitions.

Moreover, your use of code to DECEIVE ME evidences a perverse application with willful criminal intent.

DEMAND

- **Withdraw the Complaint and Cancel the Hearing post haste;**
- **CEASE and DESIST; No Further Trespass about my property.**
- **FEE SCHEDULE: If you choose Not to withdraw your complaint post haste, then from the time of your receipt of this NOTICE and DEMAND; I) you have 5 days to complete Items 1) & 2); thereafter, II) any further intrusion from your, et al., any actions to date, you a) agree to pay to me post haste upon request(s) one silver dollar per minute period of time from April 5, 2017, 5:00 pm., until this matter is resolved; and, b) you agree to pay post haste upon request any and all legal service charges incurred in resolve of- and collection from you- any amounts accrued.**
- **COMMON LAW PROCEEDING: If you choose to Not withdraw your complaint post haste, then i Demand a June 8, 2017, Court of Record to proceed in Common Law with trial by jury to hear and decide a) the controversy of your actions against me, and b) the Item 3) Fee Schedule, matter in controversy greater than twenty dollars at this writing.**
- **My Next Friend, the man steward-at-my-property, will accompany and assist me as i deem may be necessary.**

Jay-Roy: Ingold

Jay-Roy: Ingold
May 7, 2017

Because of these hassles I am putting my house up for sale.

I witness and acknowledge that all statements herein are true.

Lisa: Ingold
May 7, 2017

1271



Exhibit C

Exhibit C

Exhibit C

Exhibit C

Exhibit C

AMANDA STANFORD
CLERK OF THE SUPERIOR COURT - PINAL COUNTY

PO BOX 2730
FLORENCE ARIZONA 85132



TELEPHONE: 520.509.3555
FAX: 520.866.5320

Date: Nov 21, 2018 :

Name/ **JAY - ROY: INGOLD**
Address: **5124 E. 18th AVE.**
APACHE JUNCTION, AZ 85119

Case Number: CV201801825

THE ATTACHED DOCUMENTS ARE BEING RETURNED FOR THE FOLLOWING REASON(S):

Pursuant to Local Rule 2.1 or Rule 5.1, 5.2 or 10 of the Arizona Rules of Civil Procedure, your document cannot be filed.

You may obtain information on how to file in Legal Format by obtaining the Blank Title Page Packet on our website;
www.cocpinalcountyaz.gov.

Documents Returned: **CONSTRUCTIVE NOTICE OF THE CONDITIONAL ACCEPTANCE, MISCELLANEOUS DOCUMENTS,
(2) COPIES & CHECK (#17-856901635) IN THE AMOUNT OF \$230.00.**

AMANDA STANFORD
Clerk of the Superior Court

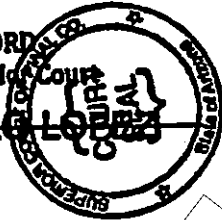

ARTURO LOPEZ Deputy Clerk

cc: AJACS

Return Letter File _____

2022-011769 MISC Page: 1276 of 2782
09/26/2022 03:35:37 PM Receipt #: 22-9381
Rec Fee: \$30.00 Darrell James Hill
Gila County, Az, Sadie Jo Bingham, Recorder



AMANDA STANFORD
CLERK OF THE SUPERIOR COURT - PINAL COUNTY

PO BOX 2730
FLORENCE ARIZONA 85132



TELEPHONE: 520.509.3555
FAX: 520.866.5320

Date: Nov 30, 2018

Name/ **JAY ROY INGOLD**
Address: **5124 E 18TH AVE**
APACHE JUNCTION, AZ 85119

Case Number: S1100CV201801825

THE ATTACHED DOCUMENTS ARE BEING RETURNED FOR THE FOLLOWING REASON(S):

- Pursuant to Local Rule 2.1 or Rule 5.1, 5.2 or 10 of the Arizona Rules of Civil Procedure, your document cannot be filed.
- Filing fee of \$ 230.00 must be paid prior to filing. Please visit our website at www.cospinalcountyz.gov for our acceptable forms of payment.
- If you cannot afford the fee, you can file an Application for Deferral/Waiver. Forms can be obtained on our website at www.cospinalcountyz.gov/forms.
- Deferral Application Fee \$30

IN THE RETURN LETTER FROM 11/21/2018 IT STATED YOU MUST SUBMIT YOUR FILING IN A LEGAL FORMAT. THE CLERK CAN NOT ACCEPT THIS FILING DUE TO THE LACK OF LEGAL FORMATTING.

AS A COURTESY FROM OUR OFFICE, WE ARE ENCLOSING THE BLANK TITLE PAGE PACKET FOR YOU TO USE & SUBMIT YOUR FILING.

THERE IS ALSO THE FILING FEE, AS LISTED ABOVE, ASSESSED AT TIME OF FILING.

Documents Returned: CONSTRUCTIVE NOTICE OF THE SETTING OF THE PRESUMPTIONS W/COPIES

AMANDA STANFORD
Clerk of the Superior Court
BRIANNA BURROWS, Deputy Clerk



cc:
Return Letter File

1274

2022-011769 MISC Page: 1277 of 2782
09/26/2022 03:35:37 PM Receipt #: 22-9381
Rec Fee: \$30.00 Darrell James Hill
Gila County, Az, Sadie Jo Bingham, Recorder



3B

AMANDA STANFORD
CLERK OF THE SUPERIOR COURT - PINAL COUNTY

PO BOX 2730
FLORENCE ARIZONA 85132



TELEPHONE: 520.509.3555
FAX: 520.866.5320

Date: Nov 30, 2018

Name/ **JAY-ROY INGOLD**
Address: **5124 E 18TH AVE**
APACHE JUNCTION, AZ 85119

Case Number: S1100CV201801825

THE ATTACHED DOCUMENTS ARE BEING RETURNED FOR THE FOLLOWING REASON(S):

The Clerk was able to stamp "RECEIVED" on one of the copies you submitted. Your two other copies are enclosed.

Documents Returned: letter regarding mailing of documents

Sealed/Restricted document and is therefore not attached.

AMANDA STANFORD

Clerk of the Superior Court

BRIANNA BURROWS, Deputy Clerk



cc:

Return Letter File

2022-011769 MISC Page: 1278 of 2782
09/26/2022 03:35:37 PM Receipt #: 22-9381
Rec Fee: \$30.00 Darrell James Hill
Gila County, Az, Sadie Jo Bingham, Recorder



BB

AMANDA STANFORD
CLERK OF THE SUPERIOR COURT - PINAL COUNTY

PO BOX 2730
FLORENCE ARIZONA 85132



TELEPHONE: 520.509.3555
FAX: 520.866.5320

Date: Dec 4, 2018 :

Name/ **JAY-ROY INGOLD**
Address: **5124 E 18TH AVE**
APACHE JUNCTION, AZ 85119

Case Number: S1100CV201801825

THE ATTACHED DOCUMENTS ARE BEING RETURNED FOR THE FOLLOWING REASON(S):

- Pursuant to Local Rule 2.1 or Rule 5.1, 5.2 or 10 of the Arizona Rules of Civil Procedure, your document cannot be filed.
- Required copies are missing. Please provide 2 sets of copies.
- No originals provided. The Clerk must be in receipt of the Original document(s) for filing the below mentioned document(s):
- Do not have an original signature.

AS STATED IN RETURN LETTERS FROM 11/21/2018 & TWO FROM 11/30/2018, THE CLERK CAN NOT ACCEPT YOUR FILING BECAUSE OF THE SAME LEGAL FORMATTING REASONS. AS ANOTHER COURTESY, OUR OFFICE IS PROVIDING ONE MORE BLANK TITLE PAGE PACKET TO USE FOR YOUR FILING. YOU MAY OBTAIN OTHER PROPERLY FORMATTED DOCUMENTS ON OUR WEBSITE, WWW.COSCPINALCOUNTYAZ.GOV AND ALSO CONDUCT YOUR OWN LEGAL RESEARCH REGARDING THE ABOVE CITED RULES FOR FORMATTING YOUR DOCUMENTS.

YOUR "CONSTRUCTIVE NOTICE OF CONDITIONAL ACCEPTANCE" IS NOT AN ORIGINAL DOCUMENT AND WILL NOT BE ACCEPTED. THE MISCELLANEOUS DOCUMENTS SUBMITTED ARE NOT CITED AS ATTACHMENTS TO THE NOTICE & WILL NOT BE ACCEPTED ON THEIR OWN, EITHER.

IF YOU NEED ASSISTANCE IN PERSON, WE DO HAVE OFFICES IN APACHE JUNCTION, FLORENCE, CASA GRANDE, AND MARICOPA (FRIDAYS ONLY).

CONSTRUCTIVE NOTICE OF THE CONDITIONAL ACCEPTANCE, NOTICE FOR EX POST FACTO LAW VIOLATION, MISCELLANEOUS DOCUMENTS, LETTER TO THE COURT, GREEN CERTIFIED MAIL

Documents Returned: **CARD.**

MONEY ORDER [REDACTED] FOR \$230.00

- Sealed/Restricted document and is therefore not attached.

AMANDA STANFORD
Clerk of the Superior Court

Brianna Burrows, Deputy Clerk

cc: *1276*

2022-011769 MISC Page: 1279 of 2782
09/26/2022 03:35:37 PM Receipt #: 22-9381
Rec Fee: \$30.00 Darrell James Hill
Gila County, Az, Sadie Jo Bingham, Recorder



BB

AMANDA STANFORD
CLERK OF THE SUPERIOR COURT - PINAL COUNTY

PO BOX 2730
FLORENCE ARIZONA 85132



TELEPHONE: 520.509.3555
FAX: 520.866.5320

Date: Dec 28, 2018

Name/ **JAY ROY INGOLD**
Address: **5124 EAST 18TH STREET**
APACHE JUNCTION, AZ 85119

Case Number: S1100CV201801825

THE ATTACHED DOCUMENTS ARE BEING RETURNED FOR THE FOLLOWING REASON(S):

Filing fee of \$ 230.00 must be paid prior to filing. Please visit our website at www.cosc.pinalcountvaz.gov for our acceptable forms of payment.

If you cannot afford the fee, you can file an Application for Deferral/Waiver. Forms can be obtained on our website at www.cosc.pinalcountvaz.gov/forms.

Deferral Application Fee \$30

The Clerk can not accept this filing due to lack of filing fee.

Submitted documents are to be addressed to the Clerk of Superior Court, not to an individual Deputy Clerk.

Documents Returned: **CEASE AND DESIST OF THE REFUSALS OF THE DOCUMENTS REGARDING THE LIABILITY AT EQUITY BY THE PINAL COUNTY CONTRACT (WITH 2 COPIES)**

Sealed/Restricted document and is therefore not attached.

AMANDA STANFORD
Clerk of the Superior Court
BRIANNA BURROWS, Deputy Clerk

cc:
Return Letter File _____

2022-011769 MISC Page: 1280 of 2782
09/26/2022 03:35:37 PM Receipt #: 22-9381
Rec Fee: \$30.00 Darrell James Hill
Gila County, Az, Sadie Jo Bingham, Recorder



AMANDA STANFORD
CLERK OF THE SUPERIOR COURT - PINAL COUNTY

PO BOX 2730
FLORENCE ARIZONA 85132



TELEPHONE: 520.509.3555
FAX: 520.866.5320

Date: Jan 18, 2019

Name/ JAY INGOLD
Address: 5124 E. 18th AVE.
APACHE JUNCTION, AZ 85119

Case Number: S1100

THE ATTACHED DOCUMENTS ARE BEING RETURNED FOR THE FOLLOWING REASON(S):

- Filing fee of \$ 230.00 must be paid prior to filing. Please visit our website at www.cocspinalcountyz.gov for our acceptable forms of payment.
- If you cannot afford the fee, you can file an Application for Deferral/Walver. Forms can be obtained on our website at www.cocspinalcountyz.gov/forms.
- Deferral Application Fee \$30

Documents Returned: RESPONDENT EXECUTOR REQUEST: 10 DAY TIME-ENLARGEMENT NEEDED FOR...



AMANDA STANFORD
Clerk of the Superior Court

ARTURO LOPEZ

, Deputy Clerk

cc: AJACS

Return Letter File _____

2022-011769 MISC Page: 1281 of 2782
09/26/2022 03:35:37 PM Receipt #: 22-9381
Rec Fee: \$30.00 Darrell James Hill
Gila County, Az, Sadie Jo Bingham, Recorder



AMANDA STANFORD
CLERK OF THE SUPERIOR COURT - PINAL COUNTY

PO BOX 2730
FLORENCE ARIZONA 85132



TELEPHONE: 520.509.3555
FAX: 520.866.5320

Date: Jan 29, 2019

Name/ JAY-ROY INGOLD
Address: 5124 E 18TH AVE
APACHE JUNCTION, AZ 85119

Case Number: S1100CV201801825

THE ATTACHED DOCUMENTS ARE BEING RETURNED FOR THE FOLLOWING REASON(S):

- Filing fee of \$ 230.00 must be paid prior to filing. Please visit our website at www.cospinalcountyz.gov for our acceptable forms of payment.
- If you cannot afford the fee, you can file an Application for Deferral/Waiver. Forms can be obtained on our website at www.cospinalcountyz.gov/forms.
- Deferral Application Fee \$30

The Court will not file any documents without a filing fee or an Application for Deferral with appropriate proof of income. A blank Application for Deferral is being enclosed as a courtesy to you.

Documents Returned: Respondent's Notice & 10 Day Time Enlargement with copies

AMANDA STANFORD
Clerk of the Superior Court
[Signature] Deputy Clerk

Return Letter File

2022-011769 MISC Page: 1282 of 2782
09/26/2022 03:35:37 PM Receipt #: 22-9381
Rec Fee: \$30.00 Darrell James Hill
Gila County, Az, Sadie Jo Bingham, Recorder



AMANDA STANFORD
CLERK OF THE SUPERIOR COURT - PINAL COUNTY

PO BOX 2730
FLORENCE ARIZONA 85132



TELEPHONE: 520.509.3555
FAX: 520.866.5320

Date: Feb 8, 2019

Name/ JAY ROY INGOLD
Address: 5142 EAST 18TH AVE
APACHE JUNCTION, AZ 85119

Case Number: S1100CV201801825

THE ATTACHED DOCUMENTS ARE BEING RETURNED FOR THE FOLLOWING REASON(S):

- No originals provided. The Clerk must be in receipt of the Original document(s) for filing the below mentioned document(s):
- Do not have an original signature.
- Filing fee of \$ 230.00 must be paid prior to filing. Please visit our website at www.cosc.pinalcountyaz.gov for our acceptable forms of payment.
- If you cannot afford the fee, you can file an Application for Deferral/Waiver. Forms can be obtained on our website at www.cosc.pinalcountyaz.gov/forms.
- Deferral Application Fee \$30
- This is considered *ex parte* communication with the Court, which is prohibited by the Code of Judicial Conduct. The Court will not consider documents, pleadings or other filings unless they conform to the Arizona Rules of Civil Procedure and have been mailed/served on the opposing party/parties or their attorney of record.

Anything filed with the Court should be filed with the Clerk of the Superior Court in proper format and the appropriate filing fee, if any, paid. All filings with the Court must be mailed/served upon all other parties in the case, or, if they are represented by an attorney, upon their attorney. Courtesy copies of all pleadings, notices, etc. that are filed with the Clerk's Office may be furnished to the assigned judge, but are not required to be furnished to the assigned judge. Proof of mailing/service must be shown on any filing with the Court. The Court will not consider documents, pleadings or other filings unless it appears that they have been sent to all other parties/attorneys.

These documents provided will not be filed in because they are not originals. There is still a filing fee of \$230 due that has been addressed in numerous previous return letters. An Application for Deferral has been mailed to you if you are looking to defer your fees.

Documents Returned:

ANSWER/RESPONSE, NOTICE RE: DARREL JAMES HILL, NOTICE RE: TRACY-ROBERT CALHOUN,
NOTICE RE: MAY-JUNE CONTRACT, NOTICE RE: BEVERLY JEAN ROMERO HILL, NOTICE RE: PINAL
COUNTY GOVERNMENT, AUTHORIZATION FOR JAY ROY TO SIGN, NOTICE RE: CORRECTION OF
ACCOUNT, PREACIPE FOR THE OATH OF OFFICE, NOTICE RE: UNJUSTIFIED ACTION, NOTICE RE:
CONSTRUCTIVE NOTICE, NOTICE RE: BEST FRIEND DARREL JAMES HILL WILL BE ASSISTING,
REQUIRED JOINDER, NOTICE: DO NOT OWE A FILING FEE, AFFIDAVIT CONTACT WITH JAMES,
REQUIRED JOINDER RE: JAMES WILLIAM WOODS, NOTICE LAND HOME ZIP CODE EXEMPT,
AFFIDAVIT OF CONTACT WITH JAMES, AFFIDAVIT OF CONTACT WITH JAMES

2022-011769 MISC Page: 1283 of 2782
09/26/2022 03:35:37 PM Receipt #: 22-9381
Rec Fee: \$30.00 Darrell James Hill
Gila County, Az, Sadie Jo Bingham, Recorder



AMANDA STANFORD
Clerk of the Superior Court

Shanna Bunch
Deputy Clerk

Return Letter File

Unofficial Copy

2022-011769 MISC Page: 1284 of 2782

09/26/2022 03:35:37 PM Receipt #: 22-9381

Rec Fee: \$30.00 Darrell James Hill

Gila County, Az, Sadie Jo Bingham, Recorder



Unofficial Copy

Exhibit D

Exhibit D

Exhibit D

Exhibit D

Exhibit D

2019 February Claim Of man-beneficiary USPS RMN RE 322 404 053 IIS 12/12

2022-011769 MISC Page: 1285 of 2782
09/26/2022 03:35:37 PM Receipt #: 22-9381
Rec Fee: \$30.00 Darrell James Hill
Gila County, Az, Sadie Jo Bingham, Recorder



Jay- Roy: Ingold: beneficiary and Executor
c/o 5142 East 18th Avenue
Apache Junction, Arizona ZIP CODE EXEMPT
DMM 602.1.3.e2. Title 18 U.S.C. § 1342
602.499.8807

:man :present:

Arizona state
Pinal county

**SUPERIOR COURT OF ARIZONA
PINAL COUNTY**

:PINAL COUNTY,
:Plaintiff;

Case No. CV 201801825 –
HON. BRENDA E OLDHAM

v.

:RESPONDENT NOTICE

:JAY INGOLD, also know as JAY
ROY INGOLD: subrogation of the
man beneficiary: Jay-Roy: Ingold!: sui
juris
:Aggrieved Party

**TO THE PINAL/Pinal county-
:Craig :DEPUTY COUNTY
ATTORNEY CAMERON**

:Respondent-
Executor;

**ATTEMPT TO RESOLVE THE
MATTERs OF THE FRAUD BY THE
GOOD FAITH CONSULTATION**

Cross-Claimant

v.

:Himanshu: Director, Community
Development Patel, :Paula: Code
Compliance Manager Mullenix,

1 :Jay-Roy: Ingold means: Acknowledgment, Acceptance and Deed of Re-Conveyance: Yavapai
County Recorder: Doc # 2018-0055641.

:Craig: Deputy County Attorney Cameron_ USPS CMN 7018 0360 0000 5968 8850

1/4

2022-011769 MISC Page: 1286 of 2782
09/26/2022 03:35:37 PM Receipt #: 22-9381
Rec Fee: \$30.00 Darrell James Hill
Gila County, Az, Sadie Jo Bingham, Recorder



Terrilyn: Code Compliance Officer
Klucar, :James: Code Compliance
Officer Meadows, :Kent: Pinal County
Attorney Volkmer, :Craig: Deputy
County Attorney Cameron, :John-Doe,
:Jane-Doe,

:Wrong- doers.

:AFFILIANT: Man :Beneficiary: Respondent-Executor

:i-man am a living man – the blood flows and the flesh lives – given name :Jay-
Roy: family name: Ingold: Indianan -1962: of sound mind, :beneficiary and
executor of the Almighty-God-given natural rights, and the :beneficiary- subrogee
and executor of the public trust subrogation named: JAY ROY INGOLD~ et al.
derivatives created by the UNITED STATES government-trustee, et al., et seq. –
also including the PINAL/ Pinal county-government-trustee, STATE OF
ARIZONA/ Arizona state-government-trustee.

**ATTEMPT TO RESOLVE THE MATTERS OF THE FRAUD BY THE
GOOD FAITH CONSULTATION**

1. The: PINAL/Pinal county complaint and the James: Code Compliance
Officer Meadows' documents contain certain representations that require
resolution between :i- man-beneficiary, who have been injured, and the trustee.

Specifically:

:Craig: Deputy County Attorney Cameron_ USPS CMN 7018 0360 0000 5968 8830

2/4

2022-011769 MISC Page: 1287 of 2782
09/26/2022 03:35:37 PM Receipt #: 22-9381
Rec Fee: \$30.00 Darrell James Hill
Gila County, Az, Sadie Jo Bingham, Recorder



PINAL/Pinal county - :Jay-Roy: Ingold 2017 May-June 8th Contract

2. The :complaint and James' affidavit failed to include the substantial material fact of the "PINAL/Pinal county - :Jay-Roy: Ingold" 2017 May-June 8th Contract – activated into force: June 8th: 2017: 08:30.01 a.m.; that:
3. All events occurring after the initiation of the Contract on the 2017 May-June 8th are under this agreement, including also this instant matter; that:
3. The :June 8th; 2017 Hearing-meeting was held understanding the 2017 May-June 8th Contract with resultant fraud violations against :i-man.

PINAL/Pinal county COMPLIED WITH THE SIMPLE CONTRACT

4. The :complaint and James' affidavit failed to mention that the PINAL/Pinal county did in fact comply with the 2017:May-June 8th Contract for approximately one year before the man- James: Code Compliance Officer Meadows reports he began acting under the contract; that,

PINAL/Pinal county ABUSE UPON THE PEOPLE

5. For the fact the :man- James: Code Compliance Officer Meadows' perpetrated stalking-harassment behavior goaded the man - :Jay-Roy: Ingold to begin communications for to stop the harassment; and, that:
6. The PINAL/Pinal county complaint and James' affidavit omitted mention of the menacing and nuisance harassment upon the souls living in the community upon the land.

:Craig: Deputy County Attorney Cameron _ USPS CMN 7018 0360 0000 5968 8850

3/4

2022-011769 MISC Page: 1288 of 2782
09/26/2022 03:35:37 PM Receipt #: 22-9381
Rec Fee: \$30.00 Darrell James Hill
Gila County, Az, Sadie Jo Bingham, Recorder



MEETING SUGGESTED

7. :i- Jay-Roy wish for the immediate resolve of this matter, and suggest we set-up a telephonic meeting to satisfactorily resolve these deviations from the truth in this matter within ten days after your receipt of this notice please.

Sincerely,

cc: Scott: Chief Justice Bales
Mark: Sheriff Lamb
Mark: Ariz. AG Brnovich AG

Without Prejudice
JAY ROY INGOLD, subrogation

Jay-Roy Ingold
Jay-Roy: Ingold, beneficiary, President-
Executor

Verified and autographed before me this 29 day: January: 2019 A.D.;
:Type- Identification: Arizona Driver License

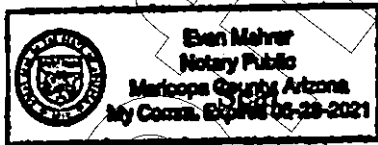

E. P.
Notary Public

:Craig: Deputy County Attorney Cameron_ USPS CMN 7018 0360 0000 5968 8850

44

2022-011769 MISC Page: 1289 of 2782
09/26/2022 03:35:37 PM Receipt #: 22-9381
Rec Fee: \$30.00 Darrell James Hill
Gila County, Az, Sadie Jo Bingham, Recorder



USPS Tracking®

FAQs > (<https://www.usps.com/faq/uspstracking-faq.htm>)

Track Another Package +

Tracking Number: 70180380000059688850

Remove X

On Time

Expected Delivery on

FRIDAY

1 FEBRUARY 2019

See Product Information v

Sent 1/29/18
Rec. 2/1/18

Delivered

February 1, 2019 at 9:59 am
Delivered
FLORENCE, AZ 85132

Get Updates v

Text & Email Updates v

Tracking History ^

February 1, 2019, 9:59 am
Delivered
FLORENCE, AZ 85132
Your item was delivered at 9:59 am on February 1, 2019 in FLORENCE, AZ 85132.

February 1, 2019, 8:25 am
Available for Pickup
FLORENCE, AZ 85132

February 1, 2019, 6:15 am
Arrived at Unit
FLORENCE, AZ 85132

January 31, 2019
In Transit to Next Facility

January 30, 2019, 1:18 pm
Departed Post Office
APACHE JUNCTION, AZ 85120

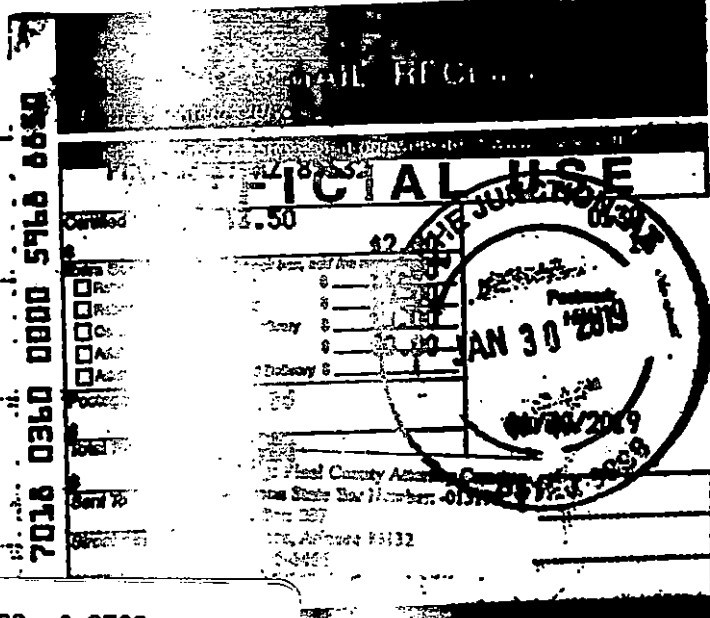

2022-011769 MISC Page: 1290 of 2782
09/26/2022 03:35:37 PM Receipt #: 22-9381
Rec Fee: \$30.00 Darrell James Hill
Gila County, Az, Sadie Jo Bingham, Recorder



2/17/19, 5:18 PM



:Darrell-James: Hill: beneficiary and Executor
c/o 5142 East 18th Avenue
Apache Junction, Arizona ZIP CODE EXEMPT
DMM 602.1.3.e2. Title 18 U.S.C. § 1342

:man :present: Ingold court of record: Case No. 7018 0360 0000 5968 6115, at:

Arizona state
Pinal county

**SUPERIOR COURT OF ARIZONA
PINAL COUNTY**

Jay-Roy: Ingold: sui juris: Aggrieved (RE: CV 201801825 – PINAL v.
-Respondent: Executor, INGOLD: Brenda-E.: Oldham)
Claimant

v.

:PINAL COUNTY, :Himanshu:
Director, Community Development
Patel, :Paula: Code Compliance
Manager Mullenix, Terrilyn: Code
Compliance Officer Klucar, :James:
Code Compliance Officer
Meadows, :Kent: Pinal County
Attorney Volkmer, :Craig: Deputy
County Attorney Cameron, :John-Doe,
:Jane-Doe,

**:AFFIDAVIT: WITNESS OF THE
FEBRUARY 15th TELEPHONIC
MEETING BETWEEN :Jay-Roy and
and Craig: Cameron ON HIS, ET
AL.'S OMISSION OF THE
PINAL/Pinal county- Jay-Roy: Ingold
– 2017 MAY-JUNE 8TH CONTRACT :
AFFIANT: man :Darrell-James: Hill¹:
ACQUAINTED WITH THE FACTS,
FOR, AND, ON BEHALF OF :Jay-
Roy: Ingold.**

:Wrong- doers.

AFFIANT

:i-man am a living soul: beneficiary and Executor of the Almighty-God-given

1 Gila county Arizona: Doc. # 2017-002378: pp. 6-24, 93-95 of 693



inherent rights, and the :beneficiary- subrogee and Executor of the public trust
 subrogation: DARRELL JAMES HILL~ et al. derivatives created by the UNITED
 STATES government-trustee -subrogor, et al. :i-man am literate, but a legal-
 idiot. :i am not a UNITED STATES Citizen.

To the best of my knowledge, the facts set forth herein are true and
 accurate. :i am Jay-Roy's next best friend.

B. TELEPHONIC MEETING:

1. Before the meeting :Jay-Roy was very nervous and said it was so.
2. :Jay made a couple failed answered calls, then :Craig called-in:

a	Jay-Roy:	This is :Jay
b	Craig:	This is :Craig Cameron.
c	Jay-Roy:	Hi :Craig
d	Craig:	Sorry we were not connecting right off, but I'm back from court..[?]. So, you'd called and you'd wanted to talk?
e	Jay-Roy:	Yes. Yeah, there was a uh., other people here, uh, with me, they're are a part of the matter, : <u>my, uh, wife,</u> and <u>Darrell and his wife</u> and, uh, <u>Tracy.</u>
	(Darrell- James: supporting Jay: pointing to the information on Jay's worksheet)	Um, 'wanted to talk about the: ..what :i consider fraud in the, uh, leaving out of the <u>contract</u> , out of the affidavit: that was uh., not in: uh: omission.
		Note: <u>my wife</u> - Lisa
		Note: <u>his wife</u> - Beverly-Jean
		Note: <u>contract</u> means: the acquiescence of the <u>2017 May 9th conditional acceptance</u> in response to the PINAL/Pinal county's final Hearing offer;

1289



		activated on: 2017 June 8th: 08:30.001 am. by the actions and acquiescence of the conditional acceptance onward unto that moment by the PINAL/Pinal county under the Arizona and U.S. Constitutional Laws, et seq.
f	Darrell-James: (supporting Jay)	It was omission of the contract and his work.
g	Craig:	What contract?
h	Jay-Roy: Darrell-James: (supporting Jay)	The contract that i had mailed to Himanshu, Paula and Terrilyn See: May 07-09th :2017 - USPS 322 399 225 US to: Himanshu, Paula and Terrilyn
i	Craig:	Did you <u>draft</u> the contract?
j	Jay-Roy:	Yes Note: <u>draft</u> means: to write the '2017 May 9th conditional acceptance of the PINAL/Pinal county Hearing offer.'
k	Craig:	Did you get it approved by the Board of Supervisors?
l	Jay-Roy:	It went to the people directly.
m	Craig:	Did it get approved by the Board of Supervisors? They can't commit the county, only the Board of Supervisors can commit the county on any contract.
n	Jay-Roy:	Um.. don't know what you're, uh: I don't understand that, this was a man to man contract that we were doing, and they submitted my contract into the hearing, to me that executed the contract. And, I thought the contract was good because they left me alone for a long time, and now they're uh not doing that.

1290



		So by leaving those statements out of that affidavit that he gave us, he's leaving, uh, out the fact of contract.
o	Darrell-James: (supporting Jay)	Material fact of contract.
p	Jay-Roy:	"substantive material fact of contract out of his affidavit.
q	Darrell-James: (supporting Jay)	So, it's fraud.
r	Craig:	OK, um, no it's not, um: i -I take it Mr. Ingold you have no intentions of abating the nuisance on your property?
s	Darrell-James: (supporting Jay)	It's only about (D, patting paper): then the conversation's over.
t	Jay-Roy:	Uh, we thought ... (speaking interjected by :Craig; ending of the meeting by :Craig)
u	Craig:	! Thank you. Goodbye.

Unofficial Copy
1291



2. In the third column of the above is what i hear
3. In the second column :my name is at places v was helping Jay- Roy with his worksheet.
4. In the forth column are some of the things i ed- with.

Without Pre

Darrell
Darrell
res

executor
Notary-
of

Verified and autographed before me this 28th day: P
:Type- Identification: Arizona Driver License

A.D.;

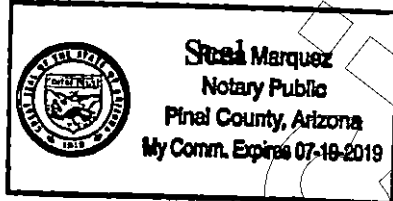

Unofficial Copy
1292



:Beverly-Jean: Romero-Hill: beneficiary and Executor
c/o 5142 East 18th Avenue
Apache Junction, Arizona ZIP CODE EXEMPT
DMM 602.1.3.e2. Title 18 U.S.C. § 1342

:man :present: Ingold court of record: Case No. 7018-0360 0000-5968 6115, at:

Arizona state
Pinal county

**SUPERIOR COURT OF ARIZONA
PINAL COUNTY**

Jay-Roy: Ingold: sui juris: Aggrieved (RE: CV 201801825 – PINAL v.
-Respondent: Executor, INGOLD: Brenda-E.: Oldham)
Claimant

v.

:PINAL COUNTY, :Himanshu:
Director, Community Development
Patel, :Paula: Code Compliance
Manager Mullenix, Terrilyn: Code
Compliance Officer Klucar, :James:
Code Compliance Officer
Meadows, :Kent: Pinal County
Attorney Volkmer, :Craig: Deputy
County Attorney Cameron, :John-Doe,
:Jane-Doe,

**:AFFIDAVIT: WITNESS OF THE
FEBRUARY 15th TELEPHONIC
MEETING BETWEEN :Jay-Roy and
and Craig: Cameron ON HIS, ET
AL.'S OMISSION OF THE
PINAL/Pinal county- Jay-Roy: Ingold
- 2017 MAY-JUNE 8TH CONTRACT :
AFFIANT: man :Beverly-Jean:
Romero-Hill¹: : ACQUAINTED
WITH THE FACTS, FOR, AND, ON
BEHALF OF :Jay-Roy: Ingold.**

:Wrong- doers.

AFFIANT

:i-man am a living soul: beneficiary and Executor of the Almighty-God-given

1 Gila county Arizona: Doc. # 2017-002378: pp. 2-44, 93-95 of 693

1297



inherent rights, and the :beneficiary- subrogee and Executor of the public trust
 subrogation: DARRELL JAMES HILL~ et al. derivatives created by the UNITED
 STATES government-trustee -subrogor, et al. :i-man am literate, but a legal-
 idiot. :i am not a UNITED STATES Citizen.

To the best of my knowledge, the facts set forth herein are true and
 accurate. :i am Jay-Roy's next best friend.

B. TELEPHONIC MEETING:

1. Before the meeting :Jay-Roy was very nervous and said it was so.
2. :Jay made a couple failed answered calls, then :Craig called-in:

a	Jay-Roy:	This is :Jay
b	Craig:	This is :Craig Cameron.
c	Jay-Roy:	Hi :Craig
d	Craig:	Sorry we were not connecting right off, but I'm back from court..[?]. So, you'd called and you'd wanted to talk?
e	Jay-Roy:	Yes. Yeah, there was a uh., other people here, uh, with me, they're are a part of the matter, :my, uh, wife, and Darrell and his wife and, uh, Tracy.
	(Darrell- James: supporting Jay: pointing to the information on Jay's worksheet)	Um, 'wanted to talk about the: ..what :i consider fraud in the, uh, leaving out of the contract, out of the affidavit: that was uh., not in: uh: omission.
		Note: <u>my wife</u> - Lisa
		Note: <u>his wife</u> - Beverly-Jean
		Note: <u>contract means: the acquiescence of the 2017 May 9th conditional acceptance</u> in response to the PINAL/Pinal county's final Hearing offer;

1294



		activated on: 2017 June 8th: 08:30.001 am. by the actions and acquiescence of the conditional acceptance onward unto that moment by the PINAL/Pinal county under the Arizona and U.S. Constitutional Laws, et seq.
f	Darrell-James: (supporting Jay)	It was omission of the contract and his work.
g	Craig:	What contract?
h	Jay-Roy: Darrell-James: (supporting Jay)	The contract that :i had mailed to Himanshu, Paula and Terrilyn
		See: May 07-09th :2017 - USPS 322 399 225 US to: Himanshu, Paula and Terrilyn
i	Craig:	Did you <u>draft</u> the contract?
j	Jay-Roy:	Yes
		Note: <u>draft</u> means: to write the '2017 May 9th conditional acceptance of the PINAL/Pinal county Hearing offer.'
k	Craig:	Did you get it approved by the Board of Supervisors?
l	Jay-Roy:	It went to the people directly.
m	Craig:	Did it get approved by the Board of Supervisors? They can't commit the county, only the Board of Supervisors can commit the county on any contract.
n	Jay-Roy:	Um.. don't know what you're, uh: I don't understand that, this was a man to man contract that we were doing, and they submitted my contract into the hearing, to me that executed the contract. And, I thought the contract was good because they left me alone for a long time, and now they're uh not doing that.

1295



		So by leaving those statements out of that affidavit that he gave us, he's leaving, uh, out the fact of contract.
o	Darrell-James: (supporting Jay)	Material fact of contract.
p	Jay-Roy:	"substantive material fact of contract out of his affidavit.
q	Darrell-James: (supporting Jay)	So, it's fraud.
r	Craig:	OK, um, no it's not, um: i -I take it Mr. Ingold you have no intentions of abating the nuisance on your property?
s	Darrell-James: (supporting Jay)	It's only about (D, patting paper): then the conversation's over.
t	Jay-Roy:	Uh, we thought ... (speaking interjected by :Craig; ending of the meeting by :Craig)
u	Craig:	! Thank you. Goodbye.



- 2. In the third column of the above is what :i heard.
- 3. In the second column :my name is at places where :Darrell- James was helping Jay-Roy with his worksheet.
- 4. In the forth column are some of the things :i am acquainted- with.

Without Prejudice

Beverly-Jean Romero Hill
 :Beverly-Jean: Romero Beneficiary-
 respondent- Executor

Verified and autographed before me this 28th day: February: 2019 A.D. ;
 :Type- Identification: Arizona Driver License

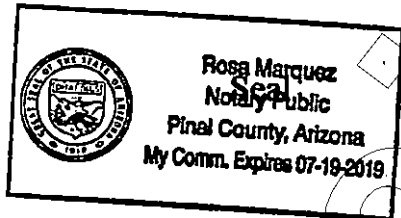

[Handwritten Signature]

 notary

Unofficial Copy

1297



:Tracy-Robert: Calhoun: beneficiary and Executor
c/o 5142 East 18th Avenue
Apache Junction, Arizona ZIP CODE EXEMPT
DMM 602.1.3.e2. Title 18 U.S.C. § 1342

:man :present: Ingold court of record: Case No. 7018 0360 0000 5968 6115, at:

Arizona state
Pinal county

**SUPERIOR COURT OF ARIZONA
PINAL COUNTY**

Jay-Roy: Ingold: sui juris: Aggrieved
-Respondent: Executor,
Claimant

(RE: CV 201801825 – PINAL v.
INGOLD: Brenda-E.: Oldham)

v.

:PINAL COUNTY, :Himanshu:
Director, Community Development
Patel, :Paula: Code Compliance
Manager Mullenix, Terrilyn: Code
Compliance Officer Klucar, :James:
Code Compliance Officer
Meadows, :Kent: Pinal County
Attorney Volkmer, :Craig: Deputy
County Attorney Cameron, :John-Doe,
:Jane-Doe,

**:AFFIDAVIT: WITNESS OF THE
FEBRUARY 15th TELEPHONIC
MEETING BETWEEN :Jay-Roy and
and Craig: Cameron ON HIS, ET
AL.'S OMISSION OF THE
PINAL/Pinal county- Jay-Roy: Ingold
– 2017 MAY-JUNE 8TH CONTRACT :
AFFIANT: man :Tracy-Robert:
Calhoun¹: : ACQUAINTED WITH
THE FACTS, FOR, AND, ON
BEHALF OF :Jay-Roy: Ingold.**

:Wrong- doers.

AFFIANT

:i-man am a living soul: beneficiary and Executor of the Almighty-God-given

1 Gila county Arizona: Doc. # 2017-002378: pp. 2-44, 93-95 of 693

1298

inherent rights, and the :beneficiary- subrogee and Executor of the public trust
 subrogation: DARRELL JAMES HILL~ et al. derivatives created by the UNITED
 STATES government-trustee -subrogor, et al. :i-man am literate, but a legal-
 idiot. :i am not a UNITED STATES Citizen.

To the best of my knowledge, the facts set forth herein are true and
 accurate. :i am Jay-Roy's next best friend.

B. TELEPHONIC MEETING:

1. Before the meeting :Jay-Roy was very nervous and said it was so.
2. :Jay made a couple failed answered calls, then :Craig called-in:

a	Jay-Roy:	This is :Jay
b	Craig:	This is :Craig Cameron.
c	Jay-Roy:	Hi :Craig
d	Craig:	Sorry we were not connecting right off, but I'm back from court..[?]. So, you'd called and you'd wanted to talk?
e	Jay-Roy:	Yes. Yeah, there was a uh... other people here, uh, with me, they're are a part of the matter, <u>my, uh, wife</u> , and <u>Darrell</u> and <u>his wife</u> and, uh, <u>Tracy</u> .
	(Darrell- James: supporting Jay: pointing to the information on Jay's worksheet)	Um, 'wanted to talk about the: ..what :i consider fraud in the, uh, leaving out of the <u>contract</u> , out of the affidavit: that was uh..., not in: uh: omission.
		Note: <u>my wife</u> - Lisa
		Note: <u>his wife</u> - Beverly-Jean
		Note: <u>contract</u> means: the acquiescence of the <u>2017 May 9th conditional acceptance</u> in response to the PINAL/Pinal county's final Hearing offer;



		activated on: 2017 June 8 th 08:30.001 am. by the actions and acquiescence of the conditional acceptance onward unto that moment by the PINAL/Pinal county under the Arizona and U.S. Constitutional Laws, et seq.
f	Darrell-James: (supporting Jay)	It was omission of the contract and his work.
g	Craig:	What contract?
h	Jay-Roy: Darrell-James: (supporting Jay)	The contract that i had mailed to Himanshu, Paula and Terrilyn
		See: May 07-09 th :2017 - USPS 322 399 225 US to: Himanshu, Paula and Terrilyn
i	Craig:	Did you <u>draft</u> the contract?
j	Jay-Roy:	Yes
		Note: <u>draft</u> means: to write the '2017 May 9 th conditional acceptance of the PINAL/Pinal county Hearing offer.'
k	Craig:	Did you get it approved by the Board of Supervisors?
l	Jay-Roy:	It went to the people directly.
m	Craig:	Did it get approved by the Board of Supervisors? They can't commit the county, only the Board of Supervisors can commit the county on any contract.
n	Jay-Roy:	Um.. don't know what you're, uh: I don't understand that, this was a man to man contract that we were doing, and they submitted my contract into the hearing, to me that executed the contract. And, I thought the contract was good because they left me alone for a long time, and now they're uh not doing that.

1300



		So by leaving those statements out of that affidavit that he gave us, he's leaving, uh, out the fact of contract.
o	Darrell-James: (supporting Jay)	Material fact of contract.
p	Jay-Roy:	"substantive material fact of contract out of his affidavit.
q	Darrell-James: (supporting Jay)	So, it's fraud.
r	Craig:	OK, um, no it's not, um: i -I take it Mr. Ingold you have no intentions of abating the nuisance on your property?
s	Darrell-James: (supporting Jay)	It's only about (D, patting paper): then the conversation's over.
t	Jay-Roy:	Uh, we thought ... (speaking interjected by :Craig; ending of the meeting by :Craig)
u	Craig:	! Thank you. Goodbye.



2. In the third column of the above is what :i heard.
3. In the second column :my name is at places where :Darrell- James was helping Jay-Roy with his worksheet.
4. In the forth column are some of the things :i am acquainted- with.

:i- man verify under the Almighty-God that the aforesaid is the true and correct to the best of my knowledge, and will testify to the same in the open court.

Without Prejudice

Tracy R. Calhoun
:Tracy-Robert Calhoun, beneficiary-
respondent- Executor

Witness: *Darrell Hill*
beneficiary- Executor
Address: same as above

Witness: *Beverly Jean Romo*
beneficiary- Executor
Address: same as above

Unofficial Copy

~~1302~~
1302

AMANDA STANFORD
CLERK OF THE SUPERIOR COURT - PINAL COUNTY

PO BOX 2730
FLORENCE ARIZONA 85132



TELEPHONE: 520.509.3555
FAX: 520.866.5320

Date: Feb 20, 2019

Name/ **JAY-RAY: INGOLD**
Address: **5142 EAST 18TH AVE.**
APACHE JUNCTION, AZ 85120

Case Number: S1100CV201801825

THE ATTACHED DOCUMENTS ARE BEING RETURNED FOR THE FOLLOWING REASON(S):

- Pursuant to Local Rule 2.1 or Rule 5.1, 5.2 or 10 of the Arizona Rules of Civil Procedure, your document cannot be filed.
- No Self-addressed stamped envelopes were provided for conformed copies.
- Enclosed you will find your return mail. Your office has sent copies for conforming; however, self-addressed stamped envelopes were not included.
The Clerk of the Superior Court is not responsible for postage fees required for the return of your documents. When you require conformed copies to be returned to you, please include self-addressed, stamped envelopes (SASE) for their return.

In the future should a self-addressed stamped envelope not be included, the Court will not forward your documents.

Enclosed, as a courtesy, are instructions and a template regarding legal formatting. Our records indicate various return letters mailed to you addressing reasons your pleadings could not be filed.

Resubmit your pleading in a legal format as the template instructs you, along with (2) copies, (1) self-addressed stamped envelope and the payment in the amount of \$230.00; this should get your initial appearance into this case filed.

Documents Returned: NO TITLE TO PLEADING/CORRESPONDENCE AND MONEY ORDER (\$) IN THE AMOUNT OF \$230.00.

AMANDA STANFORD
Clerk of the Superior Court

 , Deputy Clerk

cc: AJACS

Return Letter File _____



2022-011769 MISC Page: 1306 of 2782
09/26/2022 03:35:37 PM Receipt #: 22-9381
Rec Fee: \$30.00 Darrell James Hill
Gila County, Az, Sadie Jo Bingham, Recorder





Jay-Roy: Ingold: beneficiary; Executor
c/o 5142 East 18th Avenue
Apache Junction, Arizona ZIP CODE EXEMPT
DMM 602.1.3.e2. Title 18 U.S.C. § 1342
602.499.8807

Arizona state
Pinal county

:man :present:

:Amanda: Superior Court Clerk Stanford
Pinal County Superior Court
PO Box 2730
Florence, AZ 85132

RE: Case No. CV201801825, PINAL COUNTY :Plaintiff V. JAY INGOLD,
also know as JAY ROY INGOLD: subrogation of the man beneficiary: Jay-
Roy: Ingold: sui juris :Aggrieved Party-Respondent, :Executor.

USPS Money Order # [REDACTED] in the amount demanded: 230.00 for the
case noted above. See face copy of same below:

i: Man :Beneficiary: Respondent-Executor

:i-man am a living man – the blood flows and the flesh lives – given name :Jay-Roy:

family name: Ingold: Indianan -1962: of sound mind, :beneficiary and executor of the

Almighty-God-given natural rights, and the :beneficiary- subrogee and executor of the

public trust subrogation named: JAY ROY INGOLD~ et al. derivatives created by the

UNITED STATES government-trustee, et al., et seq. – also including the PINAL/

Pinal county-government-trustee, STATE OF ARIZONA/ Arizona state-government-

trustee. :i am not a U.S. CITIZEN.

USPS Money Order # [REDACTED] in the amount demanded: 230.00 from PO

230:00 paid ;Pinal under duress USPS CMN: 7018 0360 0000 5968 6115 1/2

[Handwritten signature]
1304

COPY

853300

1. This amount demanded: 230.00 for the case noted above is paid to address injury(s) to :i, et al., from damages imposed by the Pinal trustee, et al. in a common law court of record with the trial by jury to decide all matters of the facts and the law.
2. This is the third attempt.
3. If you do not accept this payment then do not mutilate this money order.
4. The: 230.00 amount paid is under duress: Notice to agent is notice to the principal; notice to principal is notice to the agent.

Without Prejudice
JAY ROY INGOLD :subrogation

Jay-Roy: Ingold executor
Jay-Roy: Ingold, beneficiary- respondent-
Executor

230.00 paid ;Pinal under duress USPS CMN: 7018 0360 0000 5968 6115

2/2

~~1305~~
1305

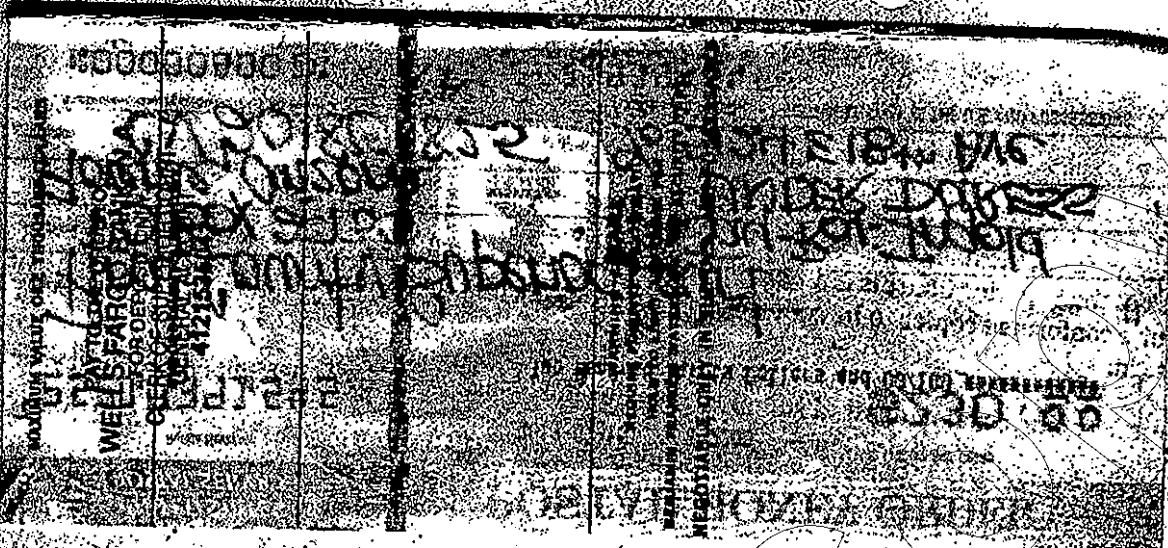

UNITED STATES POSTAL SERVICE **POSTAL MONEY ORDER**

Serial Number



\$230.00

Pay to Pinal County
Address P.O. Box 270
Florence, Arizona
Memo CV 20180



Pay to Ray Ingold
18th Ave

Check 11

⑆00000800 2⑆

CLERK OFFICE
~~1306~~
1306



Registered No. RE322404053US

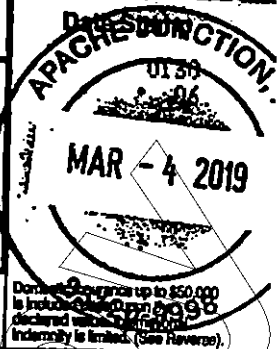

APACHE JUNCTION
151 W SUPERSTITION BLVD
APACHE JUNCTION, AZ
85120-9998
0302590130
03/04/2019 (800)275-8777 11:04 AM

Postage \$	\$2.65	Extra Services & Fees (initials)	
Extra Services & Fees		<input type="checkbox"/> Signature Confirmation	
<input type="checkbox"/> Registered Mail \$	\$12.40	<input type="checkbox"/> Signature Confirmation Restricted Delivery	
<input type="checkbox"/> Return Receipt (hardcopy) \$	\$2.80		
<input type="checkbox"/> Return Receipt (electronic) \$	\$0.00		
<input type="checkbox"/> Restricted Delivery \$	\$0.00	Total Postage & Fees	\$17.85
Customer Must Declare Full Value \$	\$0.00	Received by	03/04/2019

Product Description	Sale Qty	Final Price
First-Class Mail Large Envelope (Domestic) (FLORENCE, AZ 85132) (Weight: 0 Lb 11.20 Oz) (Estimated Delivery Date) (Wednesday 03/06/2019)	1	\$2.65
Registered	1	\$12.40
Return Receipt	1	\$2.80

OFFICIAL USE

APACHE JUNCTION, AZ 85120

FROM: Jay-Roy Ingold, 614 East 18th Avenue, Apache Junction, Arizona

TO: Mark Pinal county Sheriff Lamb, PO Box 867, Florence, Arizona 85132

PS Form 3806, Registered Mail Receipt
April 2015 Edition
Copy 1 - Customer

Total 35
Debit Card Remit'd 1.85
(Card Name: VISA)
(Account #: XXXXXXXXXXXXXXX10)
(Approval #:)
(Transaction #: 712)
(Receipt #: 020803)
(Debit Card Purchase: \$17.85)
(Cash Back: \$0.00)
(AID: A0000980840 Chp)
(AL: US EBIT)
(PIN: Verified)

Text your tracking number to 28777 (2USPS) to get the latest status. Standard Message and Data rates may apply. You may also visit www.usps.com USPS Tracking or call 1-800-222-1811.

COMPLETE THIS SECTION ON DELIVERY

A. Signature: x C-M Binkley

B. Received by (Printed Name): C-M Binkley

C. Date of Delivery: 03/04/2019

D. Is delivery address different from item 1? Yes No
If YES, enter delivery address below:

3. Service Type:
 Priority Mail Express®
 Registered Mail™
 Certified Mail™
 Collect on Delivery
 Signature Confirmation™
 Restricted Mail (over \$500)

Domestic Return Receipt

Article Addressed to:
Mark Pinal county Sheriff Lamb
PO Box 867
Florence, Arizona 85132

9590 9402 3852 8032 5323 26

RE 322 404 053 US

S Form 3811, July 2015 PSN 7630-02-000-8053





:Darrell-James: Hill, :executor, :civilian
c/o PO Box 3806
Apache Junction, Arizona 85117

SECTION B

B) :Claim Of Wrong-Doing Surrounding This Matter Is Thrice Registered
With The Pinal County Sheriff. See: Section B appended: **facts of**
:evidence, a) RMN RE 322 404 036 US - :83
pages

Darrell-James -2019 Oct. 28th :Manifest of :Bill of: Trespassing contract
:PINAL COUNTY/Pinal county RMN RE 322 404 169 US

1308



:Jay-Roy: Ingold :beneficiary :Respondent Executor
c/o 5142 East 18th Avenue
Apache Junction, Arizona ZIP CODE EXEMPT
DMM 602.1.3.e2. Title 18 U.S.C. § 1342

:man :present:

Arizona state
Pinal county

**SUPERIOR COURT OF ARIZONA
PINAL COUNTY**

PINAL COUNTY,
:Plaintiff;

Case No. CV.201801825
THE HON. BRENDA E OLDHAM

v.

**:RESPONDENT NOTICE:
REQUIRED JOINDER OF THE
Man- Beverly-Jean: Romero- Hill**

JAY INGOLD, also know as JAY ROY
INGOLD: subrogation of the man
beneficiary: Jay-Roy: Ingold: sui juris
:Aggrieved Party

:Respondent-
Executor;
Cross-Claimant.

v.

:Himanshu: Director, Community
Development Patel, :Paula: Code
Compliance Manager Mullenix,
:Terrilyn: Code Compliance Officer
Klucar, :James: Code Compliance
Officer Meadows, :Kent: Pinal County

1309
~~700009~~

COPY



Attorney Volkmer, :Craig: Deputy
County Attorney Cameron,
:John-Doe, :Jane-Doe,

:Wrong-doers.

:AFFIANT: Man :Beneficiary: Respondent-Executor

1. :i-man am a living man – the blood flows and the flesh lives – given name
:Jay-Roy: family name: Ingold: Indianan -1962: of sound mind, :beneficiary and
executor of the Almighty-God-given natural rights, and the :beneficiary- subrogee
and executor of the public trust subrogation named: JAY ROY INGOLD~ et al.
derivatives created by the UNITED STATES government-trustee, et al., et seq. –
also including the PINAL/ Pinal county-government-trustee, STATE OF ARIZONA/
Arizona state-government-trustee.

**REQUIRED JOINDER OF THE Man, Female- Beverly-Jean: Romero-
Hill**

2. For the last nearly four years :i have been under a private and ongoing
contract with :Beverly-Jean: Romero- Hill and her husband, Darrell-James:
Hill for their stewardship of the land and home areas.
3. :Beverly-Jean live on the land area under the obligation of our contact.
4. :Beverly-Jean owns private, non-commercial property on the land.
5. The :PINAL/Pinal county people know of the man: Beverly-Jean and

Joinder BJ To Amanda: COC/ Pinal co. _ USPS RMN RE 322 404 036 US

2 / 3

10/2/22
1310
BJH



her husband Darrell-James.

6. : Beverly- Jean has been and now is subject to and witness of the threats and stress caused from the PINAL/ Pinal county since the beginning and through the last three years of this interference of the Almighty God given rights of :i-man, et al.

7. Is is most obvious that without :Beverly-Jean as a respondent in this matter, she will likely be unable, as a practical matter, to protect her rights and interests against the PINAL/Pinal county aggression.

Without Prejudice
JAY ROY INGOLD: subrogation

Jay-Roy: Ingold
Jay-Roy: Ingold, by Secretary - respondent-
Executor

Affirmed and autographed before this 25 day: January: 2019.
Type Identification: Arizona Driver License

Seal

[Signature]
notary

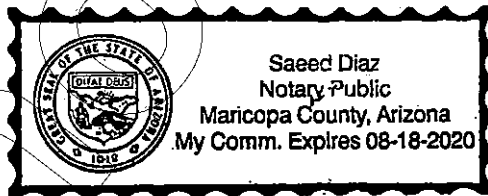

[Handwritten Signature]
1311 BA



:Jay-Roy: Ingold :beneficiary :Respondent Executor
c/o 5142 East 18th Avenue
Apache Junction, Arizona ZIP CODE EXEMPT
DMM 602.1.3.e2. Title 18 U.S.C. § 1342

:man :present:

Arizona state
Pinal county

**SUPERIOR COURT OF ARIZONA
PINAL COUNTY**

PINAL COUNTY,
:Plaintiff;

Case No. CV 201801825

v.

**:RESPONDENT NOTICE:
REQUIRED JOINDER OF THE
Man- Darrell-James: Hill**

JAY INGOLD, also know as JAY
ROY INGOLD: subrogation of the
man beneficiary: Jay-Roy: Ingold: sui
juris

:Aggrieved Party

:Respondent-

Executor;

Cross-Claimant.

v.

:Himanshu: Director, Community
Development Patel, :Paula: Code
Compliance Manager Mullenix,
:Terrilyn: Code Compliance Officer
Klucar, :James: Code Compliance

Joinder DJ To Amanda: COC/ Pinal co._ USPS RMN RE 322 404 036 US

[Handwritten signature]
1312

[Large diagonal watermark: COPY]



Officer Meadows, :Kent: Pinal County
Attorney Volkmer, :Craig: Deputy
County Attorney Cameron,
:John-Doe, :Jane-Doe,

:Wrong-doers.

:AFFIANT: Man :Beneficiary: Respondent-Executor

1. :i-man am a living man – the blood flows and the flesh lives – given
name :Jay-Roy: family name: Ingold: Indianan -1962: of sound mind,
:beneficiary and executor of the Almighty-God-given natural rights, and the
:beneficiary- subrogee and executor of the public trust subrogation named: JAY
ROY INGOLD~ et al. derivatives created by the UNITED STATES
government-trustee, et al., et seq. – also including the PINAL/ Pinal county-
government-trustee, STATE OF ARIZONA/ Arizona state-government-trustee.

REQUIRED JOINDER OF THE Man- Darrell-James: Hill

2. For the last four years :i-man have been under a private and
ongoing contract with :Darrell-James: Hill and his wife, Beverly-Jean:
Romero- Hill for the stewardship of the land and home areas.
3. :Darrell-James lives on the land area under the obligation of our
contract.
3. :Darrell-James owns private, non-commercial property on the land.

[Handwritten signature]
13/13



4. :The PINAL/Pinal county people know of the man: Darrell-James and his wife Beverly-Jean.

5. :Darrell-James is subject to and witness of the threats and subsequent stressors caused from PINAL/Pinal county since the beginning and through the last two years.

6. It is most obvious that without :Darrell-James as a respondent in this matter, he will likely be unable, as a practical matter, to protect his rights and interests against the PINAL/Pinal county intrusion.

Without Prejudice
JAY ROY INGOLD, subrogation

Jay-Roy: Ingold
Jay-Roy: Ingold, beneficiary - respondent-
Executor



notary

Seal

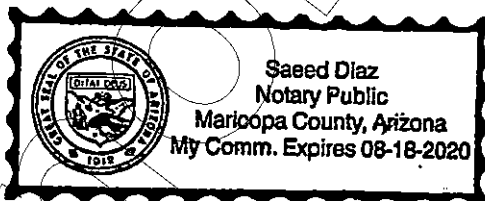

1314



:Jay-Roy: Ingold :beneficiary :Respondent Executor
c/o 5142 East 18th Avenue
Apache Junction, Arizona ZIP CODE EXEMPT
DMM 602.1.3.e2. Title 18 U.S.C. § 1342

:man :present:

Arizona state
Pinal county

**SUPERIOR COURT OF ARIZONA
PINAL COUNTY**

PINAL COUNTY,
:Plaintiff;

Case No. CV 201801825

v.

**:RESPONDENT NOTICE:
REQUIRED JOINDER OF THE
Man- Tracy-Robert: Calhoun**

JAY INGOLD, also know as JAY ROY
INGOLD: subrogation of the man
beneficiary: Jay-Roy: Ingold: sui juris
:Aggrieved Party

:Respondent- Executor;
Cross-Claimant.

v.

:Himanshu: Director, Community
Development Patel, :Paula: Code
Compliance Manager Mullenix, :Terrilyn:
Code Compliance Officer Klucar, :James:
Code Compliance Officer Meadows,
:Kent: Pinal County Attorney Volkmer,
:Craig: Deputy County Attorney
Cameron,
:John-Doe, :Jane-Doe,

:Affidavit : Required Joinder: Tracey-Robert USPS RMN RE 322 404 036 US

1315
~~10/20/22~~

COPY



:Wrong-doers.

:AFFIANT: Man :Beneficiary: Respondent-Executor

1. :i-man am a living man – the blood flows and the flesh lives – given name :Jay-Roy: family name: Ingold: Indianan -1962: of sound mind, :beneficiary and executor of the Almighty-God-given natural rights, and the :beneficiary- subrogee and executor of the public trust subrogation named: JAY ROY INGOLD- et al. derivatives created by the UNITED STATES government-trustee, et al., et seq. – also including the PINAL/ Pinal county-government-trustee, STATE OF ARIZONA/ Arizona state-government-trustee.

REQUIRED JOINDER OF THE Man- Tracy-Robert: Calhoun

2. For several decades now :: have been with an ongoing contact and private support of my friend :Tracy-Robert: Calhoun at :my previous and present land and home areas.

3. :Tracy-Robert lives on the land as much as his respite needs requires, if :i-man need the help; or, as in this case, the rural area requires more man-power monitoring from the threat of a menace and nuisance of the PINAL/Pinal county represented by the man: James: Meadows.

4. :Tracy-Robert: Calhoun owns private, non-commercial property on the land.

1316
[Handwritten signatures and scribbles]



5. To my knowledge the :PINAL/Pinal county people do not know the man: Tracy-Robert.

6. :Tracy-Robert; Calhoun has been and now is subject to and witness of the threats and stress caused from the PINAL/ Pinal county beginning 2018 June-July – November 2018; since the interference, menace and harassment against :i-man, et al. began again by the man- James: Meadows, et al. PINAL/ Pinal county.

7. Is is most obvious that without :Tracy-Robert as a respondent in this matter, he will likely be unable, as a practical matter, to protect his rights and interests against the PINAL/Pinal county aggression.

Without Prejudice
JAY ROY INGOLD, subrogation

Jay-Roy : Ingold *Executor*
Jay-Roy: Ingold, Beneficiary, respondent-
Executor



Affirmed and autographed before this 25 day: January: 2019.
Type Identification: Arizona Driver License

[Signature]
Notary

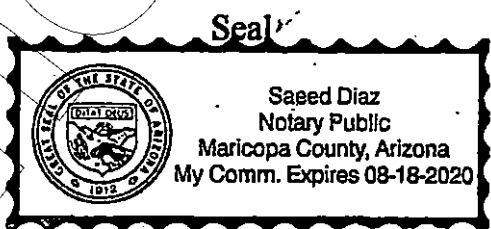

1317
[Handwritten marks]



:Jay-Roy: Ingold :beneficiary :Respondent Executor
c/o 5142 East 18th Avenue
Apache Junction, Arizona ZIP CODE EXEMPT
DMM 602.1.3.e2. Title 18 U.S.C. § 1342

:man :present:

Arizona state
Pinal county

**SUPERIOR COURT OF ARIZONA
PINAL COUNTY**

PINAL COUNTY,
:Plaintiff;

Case No. CV 201801825

v.

**:RESPONDENT NOTICE:
REQUIRED JOINDER OF THE
Man- Lisa: Loeffler- Ingold**

JAY INGOLD, also know as JAY
ROY INGOLD: subrogation of the
man beneficiary: Jay-Roy: Ingold: sui
juris
:Aggrieved Party

:Respondent-
Executor;
Cross-Claimant.

v.

:Himanshu: Director, Community
Development Patel, :Paula: Code
Compliance Manager Mullenix,
:Terrilyn: Code Compliance Officer
Klucar, :James: Code Compliance

Required Joinder: Lisa; USPS RMN RE 322 404 036 US

1318
[Handwritten signature]

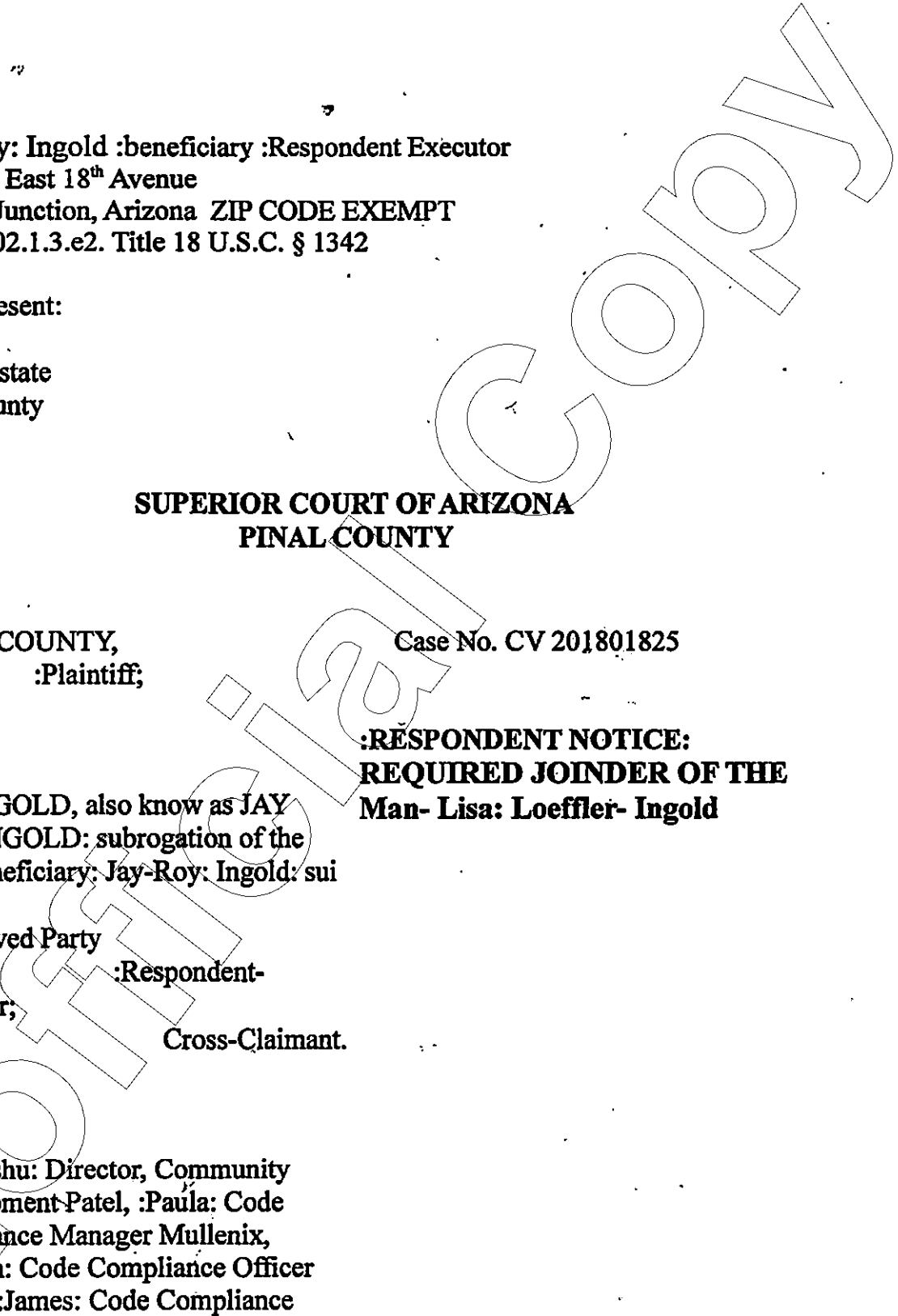

Officer Meadows, :Kent: Pinal County
Attorney Volkmer, :Craig: Deputy
County Attorney Cameron,
:John-Doe, :Jane-Doe,

:Wrong-doers.

:AFFIANT: Man :Beneficiary: Respondent-Executor

1. :i-man am a living man – the blood flows and the flesh lives – given
name :Jay-Roy: family name: Ingold: Indianan -1962: of sound mind,
:beneficiary and executor of the Almighty-God-given natural rights, and the
:beneficiary- subrogee and executor of the public trust subrogation named: JAY
ROY INGOLD~ et al. derivatives created by the UNITED STATES
government-trustee, et al., et seq. – also including the PINAL/ Pinal county-
government-trustee, STATE OF ARIZONA/ Arizona state-government-trustee.

REQUIRED JOINDER OF THE Man, Female- Lisa: Loeffler-

Ingold

- 2. For the last nearly three years :i-man have been husband married to
:Lisa-Loeffler, man and wife under the Almighty God.
- 3. :Lisa habitats on the land and home area with me under the
obligation of our contract. :i-man love my wife: i believe she loves me.
- 4. :i know from my observation and our discussions

Required Joinder: Lisa; USPS RMN RE 322 404 036 US

Handwritten signature and date:
13/19



:Jay-Roy: Ingold :beneficiary ;Respondent Executor
c/o 5142 East 18th Avenue
Apache Junction, Arizona ZIP CODE EXEMPT
DMM 602.1.3.e2. Title 18 U.S.C. § 1342

:man ;present:

Arizona state
Pinal county

**SUPERIOR COURT OF ARIZONA
PINAL COUNTY**

PINAL COUNTY,
:Plaintiff;

Case No. CV 201801825
THE HON. BRENDA E OLDHAM

v.

:RESPONDENT NOTICE: -

JAY INGOLD, also know as JAY ROY
INGOLD: subrogation of the man
beneficiary: Jay-Roy: Ingold: sui juris
:Aggrieved Party

**AUTHORIZATION FOR MAN- JAY-
ROY TO SIGN FOR MEMBERS OF
THE COMMUNITY ON THE
"Correction Of The Account Of The
Complainants' Affidavit:
Community Report - Need For
Common Law Court Of Record With
The Trial By Jury To Decide Upon The
Facts And The Law."**

:Respondent-
Executor;

Cross-Claimant.

v.

:Himanshu: Director, Community
Development Patel, :Paula: Code
Compliance Manager Mullenix,
:Terrilyn: Code Compliance Officer
Klucar, :James: Code Compliance Officer
Meadows, :Kent: Pinal County Attorney

~~1320~~
1320



Volkmer, :Craig: Deputy County
Attorney Cameron,
:John-Doe, :Jane-Doe,

:Wrong-doers.

:AFFIANT: Man :Beneficiary: Respondent-Executor

1. :i-man am a living man – the blood flows and the flesh lives – given name
:Jay-Roy: family name: Ingold: Indianan -1962: of sound mind, :beneficiary and
executor of the Almighty-God-given natural rights, and the :beneficiary- subrogee
and executor of the public trust subrogation named: JAY ROY INGOLD~ et al.
derivatives created by the UNITED STATES government-trustee, et al., et seq. – also
including the PINAL/ Pinal county-government-trustee, STATE OF ARIZONA/
Arizona state-government-trustee.

Authorization for the man-Jay-Roy: Ingold to solely sign on this document: –

**“Correction Of The Account Of The Complainants' Affidavit:
Community Report – Need For Common Law Court Of Record With The Trial
By Jury To Decide Upon The Facts And The Law.” – for:**

:Darrell-James: Hill, beneficiary, Executor; :Beverly-Jean: Romero- Hill, beneficiary-
Executor; :Lisa: Loeffler- Ingold, beneficiary, Executor; and, :Tracy-Robert: Calhoun,
beneficiary, Executor.

Authorized and autographed this 25th
January: 2019

Without prejudice,

Darrell-James Hill

:Darrell-James: Hill, beneficiary,

1321



Authorized and autographed this 25th
January: 2019

Executor.

Without prejudice,

Beverly-Jean Romero Hill
:Beverly-Jean: Romero, beneficiary-
Executor.

Authorized and autographed this 25th
January: 2019

Without prejudice,

Lisa Loeffler-Ingold
:Lisa: Loeffler- Ingold, beneficiary,
Executor.

Authorized and autographed this 25th
January: 2019

Without prejudice,

Tracy Robert Calhoun
:Tracy-Robert: Calhoun, beneficiary,
Executor.

Without Prejudice,
JAY ROY INGOLD, subrogation.
Accepted,

Jay-Roy: Ingold
Jay-Roy: Ingold, beneficiary- respondent-
Executor

Verified and autographed before me this 25 day: January: 2019.

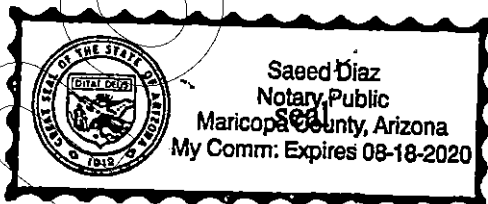

Saeed Diaz
notary

Handwritten notes:
1322



Jay- Roy: Ingold: beneficiary and Executor
c/o 5142 East 18th Avenue
Apache Junction, Arizona ZIP CODE EXEMPT
DMM 602.1.3.e2. Title 18 U.S.C. § 1342
602.499.8807

:man :present:

Arizona state
Pinal county

**SUPERIOR COURT OF ARIZONA
PINAL COUNTY**

PINAL COUNTY,
:Plaintiff;

Case No. CV 201801825

THE HON. BRENDA E OLDHAM

v.

**RESPONDENT'S NOTICE:
NEXT BEST FRIEND :Man- Darrell-
James: Hill WILL BE
ASSISTING :me AND my CAUSE
AT ALL MEETINGS AT MY
PLEASURE**

JAY INGOLD, also know as JAY ROY
INGOLD: subrogation of the man
beneficiary: Jay-Roy: Ingold: sui juris
:Aggrieved Party

:Respondent-

Executor;

Cross-Claimant.

v.

:Himanshu: Director, Community
Development Patel, :Paula: Code
Compliance Manager Mullenix,
:Terrilyn: Code Compliance Officer
Klucar, :James: Code Compliance
Officer Meadows, :Kent: Pinal County

[Handwritten signature]
1323

COPY



Attorney Volkmer, :Craig: Deputy
County Attorney Cameron,
:John-Doe, :Jane-Doe,

:Wrong-doers.

:AFFIANT: Man :Principal

:Jay-Roy: family name: Ingold: Indianan -1962: sui juris: beneficiary and executor:
status adopted by reference. See: AFFIANT: Man :Principal – RESPONDENT'S
ANSWER.

:my next best friend, :man- Darrell-James: Hill, will be assisting :me
at any meeting at my pleasure.

Without Prejudice
JAY ROY INGOLD, subrogation

Jay-Roy : Ingold
Jay-Roy: Ingold, beneficiary- respondent-
Executor

State of Arizona
County of Maricopa

This instrument was acknowledged before me this 25th day of
January, 2019, by Jay-Roy Ingold

In witness whereof I herewith set my hand and official seal.

NOTARY PUBLIC

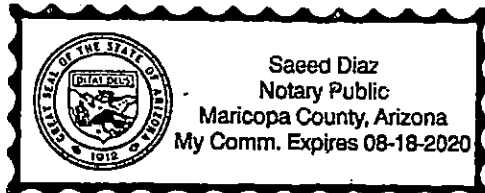

1324



:Jay-Roy: Ingold :beneficiary :Respondent Executor
c/o 5142 East 18th Avenue
Apache Junction, Arizona ZIP CODE EXEMPT
DMM 602.1.3.e2. Title 18 U.S.C. § 1342

:man :present:

Arizona state
Pinal county

**SUPERIOR COURT OF ARIZONA
PINAL COUNTY**

PINAL COUNTY,
:Plaintiff;

Case No. CV 201801825
THE HON. BRENDA E OLDHAM

v.

**:RESPONDENT NOTICE:
2017 May-June 8th CONTRACT
OBLIGATIONS UPON THE
PINAL/Pinal county AS OF JUNE
8th: 08:30.01 A.M.**

JAY INGOLD, also know as JAY ROY
INGOLD: subrogation of the man
beneficiary: Jay-Roy: Ingold: sui juris
:Aggrieved Party

:Respondent- Executor;
Cross-Claimant.

v.

:Himanshu: Director, Community
Development Patel, :Paula: Code
Compliance Manager Mullenix,
:Terrilyn: Code Compliance Officer
Khucar, :James: Code Compliance
Officer Meadows, :Kent: Pinal County
Attorney Volkmer, :Craig: Deputy
County Attorney Cameron,

~~1325~~
1325



:John-Doe, :Jane-Doe,

:Wrong-doers.

:AFFIANT: Man :Beneficiary: Respondent-Executor

1. :i-man am a living man – the blood flows and the flesh lives – given name :Jay-Roy: family name: Ingold: Indianan -1962: of sound mind, :beneficiary and executor of the Almighty-God-given natural rights, and the :beneficiary- subrogee and executor of the public trust subrogation named: JAY ROY INGOLD~ et al. derivatives created by the UNITED STATES government-trustee, et al., et seq. – also including the PINAL/ Pinal county-government-trustee, STATE OF ARIZONA/ Arizona state-government-trustee.

The 2017 May- June 8th Contract

1. 2017: by April: Terrilyn: Code Compliance Officer Klucar was threatening a hearing and fines for not doing what she demanded to be done according to the code she used. In the response:
2. 2017: by May 9th the :Community Development Corporation received from :i-man a :conditional acceptance by the USPS Registered Mail delivery to the PINAL/Pinal county Corporation coordinators of these commands and offer(s): Himanshu: Director, Cotmunity Development Patel, :Paula: Code Compliance Manager Mullenix, and: Terrilyn: Code Compliance Officer Klucar; – the

Handwritten signature and number 1326



Conditional Acceptance, saying: a) 'no more', b) the fee schedule is presented for the continued violations against :my, et al.'s rights, and: c) June 8th Hearing event is the event by which the complaint process needs to be stopped. See: 2017 May-June 8th Contract attached.

3. The 2017 May-June 8th Contract was activated on the 8th: June: 2017 in accordance with the agreement, and as the exclusive contract governing the entirety of the PINAL/Pinal county matter since after June 8th: 2017: 08:30.01.

4. The June 8th: 2017 PINAL/Pinal county v. :i-man-beneficiary Hearing-meeting was held after June 8th: 2017: 08:30 time of the activation of the 2017 May-June 8th Contract as is governed thereby.

Without Prejudice
JAY ROY INGOLD, subrogation

Jay-Roy Ingold executor
Jay-Roy: Ingold, beneficiary- respondent-
Executor

Verified and autographed before me this 25 day: January: 2019.

seal

notary

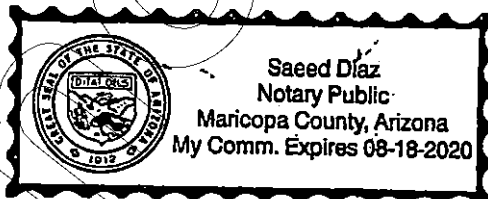

~~1327~~
1327



:Jay-Roy: Ingold :beneficiary :Respondent Executor
c/o 5142 East 18th Avenue
Apache Junction, Arizona ZIP CODE EXEMPT
DMM 602.1.3.e2. Title 18 U.S.C. § 1342

:man :present:

Arizona state
Pinal county

**SUPERIOR COURT OF ARIZONA
PINAL COUNTY**

PINAL COUNTY,
:Plaintiff;

Case No. CV 201801825THE
HON. BRENDA E OLDHAM

v.

JAY INGOLD, also know as JAY
ROY INGOLD: subrogation of the
man beneficiary: Jay-Roy: Ingold: sui
juris
:Aggrieved Party

**:RESPONDENT NOTICE: -
CORRECTION OF THE
ACCOUNT OF THE
COMPLAINANTS' AFFIDAVIT:
Community Report - Need For
Common Law Court Of Record
With The Trial By Jury To Decide
Upon The Facts And The Law.**

:Respondent-
Executor;

Cross-Claimant.

v.

:Himanshu: Director, Community
Development Patel, :Paula: Code
Compliance Manager Mullenix,
:Terrilyn: Code Compliance Officer
Klucar, :James: Code Compliance

:Affidavit :Jay-Roy : Correction Of The Account: USPS RMN RE 322 404 036 US

~~1328~~
1328
~~1328~~



Officer Meadows, :Kent: Pinal
County Attorney Volkmer, :Craig:
Deputy County Attorney Cameron,
:John-Doe, :Jane-Doe,

:Wrong-doers.

:AFFIANT: Man :Beneficiary: Respondent-Executor

1. :i-man am a living man – the blood flows and the flesh lives – given
name :Jay-Roy: family name: Ingold: Indianan -1962: of sound mind,
:beneficiary and executor of the Almighty-God-given natural rights, and the
:beneficiary- subrogee and executor of the public trust subrogation named:
JAY ROY INGOLD~ et al. derivatives created by the UNITED STATES
government-trustee, et al., et seq. – also including the PINAL/ Pinal county-
government-trustee, STATE OF ARIZONA/ Arizona state-government-trustee.

The Beginning

2. 2016: Sometime in the early part of the year, did an unannounced man-
female drive onto the land and home area and started taking notes and
photographs.
3. 2016: The woman later known as :Terrilyn: Code Compliance Officer
Klucar's demeanor was insistent. Then the mail and pressure to be under her
control increased and became awkward.
4. 2016 - 2017: i made changes and worked with a regard for :Terrilyn to

~~1329~~
1329



clean-up my land area for my, et al.'s own self-interests.

:PINAL/Pinal county Contract To Commit my Rights To Them Or Suffer Letter

5. 2017: by April, a letter from the man: Terrilyn: Code Compliance Officer Klucar was threatening a hearing and fines for not doing what she demanded to be done according to the code she used.

:Jay-Roy: Ingold (et al.) 'No' letter; leave me alone, and fee schedule conditional acceptance offer.

6. 2017: by May 9th :i-man sent a Registered Mail correspondence to the people coordinating these commands saying: a) 'no', 'stop', 'i don't volunteer,' and b) the fee schedule for the continued violations against my, et al.'s rights.

See: Affidavit: 2017 May-June 8th Contract.

7. 2017: The 2017 May agreement was conditional upon the activation of the agreement by the PINAL/Pinal county on the 8th :June: 08:30 a.m. – :Thereon the PINAL/Pinal county could choose: a) to continue unauthorized abuses against me :Jay-Roy (et. al.), or b) to discontinue abuses against :i-man :Jay-Roy, et al.

8. 2017: By the 7th: June, by and with the PINAL/Pinal county's acceptance of the agreement and with no-indication of the stoppage of the interference with my (et al.'s) rights :then on the 8th :June, the 2017 May

1330



agreement" could convert into the 2017 May-June 8th Contract at 08:30.01

a.m. .

9. 2017: June 8th: i-man :Jay-Roy, accompanied by :my Next Best Friend :Darrell-James: Hill, :Steward, visited to the Hearing meeting location in the town of Florence, Arizona, – arriving before to determine whether the PINAL/Pinal county suit had been ceased and this was all over, or whether the PINAL/Pinal county decided otherwise.

2017 May Agreement, the

2017 May-June 8th Contract

10. 2017: June 8th at 08:30.01, in accordance with the 2017 May

Agreement, the

PINAL/Pinal county activated the 2017 May-June 8th Contract governing all

of these negotiations. – The activation of the Contract is further confirmed

with the PINAL/Pinal county v. :Jay-Roy hearing meeting that did take place.

2017: June 8th: Hearing-meeting- 2017 May-June 8th Contract

Compliance

11. 2017: June 8th: At the Hearing-meeting, the :man at the Hearing office

clarified that the 2017 May-June 8th Contract was also received by the Hearing office. – ...

12. As the hearing officer had the a copy, :i-man offered and began in the

:Affidavit :Jay-Roy : Correction Of The Account: USPS RMN RE 322 404 036 US

4 / 9

~~Handwritten scribbles~~
1331



reading of the 2017 May-June 8th Contract into the record. – ...

13. The Hearing officer then stopped my reading, adopted and filed the entirety of the 2017 May-June 8th Contract into the record.

14. After, the Hearing officer agreed to receive the 2017 May-June 8th Contract and place it into the record, the Hearing-man immediately proceeded to operate upon the prejudice arguing in-concert under/by the PINAL/Pinal county authority and ignoring the New 2017 May-June 8th Contract :in-concert of those choosing for to impose their predilections.

15. 2017-2018: From the 2017 May-June 8th Contract until :2018-June, PINAL/Pinal county sent some payment requests for a proposals for a debt :i could not owe according to our contract. – I ignored the debt contracts.

2017 May-June 8th Contract: June 2017 to June 2018 Compliance

16. :PINAL/Pinal county complied with the contract to not interfere with my peaceful living, to leave me, et al., alone and undisturbed.

17. :i-man would Not make-contract with the PINAL/Pinal county bills.

Then:

18. On or about the 2018 June-July some guy unannounced shows up at the property line acting as a,people predator of some type, alarming and disturbing the the animals and people on the property.

19. 2018 August: This creepy man-hiding- behind-the-bushes- routine

[Handwritten signature]
1332



creates a disturbance about and on our rural land and home area and environment. – This stimulated defensiveness for the community family and personal safety, and must always be investigated.

2017 May-June 8th Contract: Compliance after ~ June 2018

20. 2018: August-October: James' disturbance is knowingly dangerous and disturbing to our peaceful living; a stress of this travail became to hover over the land and the people.

21. :We- people of the community have to consider whether there is a something mentally wrong with the man :James: Code Compliance Officer Meadows, or there is an ethical failing in the PINAL/Pinal county.

22. 2018: August – October: James' behavior is a threat to :my, et al.'s land and home area community for the reasons: we have to check every disturbance, and we had the man power to watch the man :James or the intrusions could have likely escalated into earlier confrontations.

23. 2018: October: The patterned interference by the man :James must needs to be ceased from further duress and harm upon the people on the land and home area: inhabitants, animals and visitors.

24. :We-the people were not naive, but hoped, in clear view and remembrance of the 2017 May-June 8th Contract, for a peaceful resolve as the man-kind.

1333

25. 2018: June-July to October: Directly due to and because of :James' menacing and nuisance, :i-man did in-good-faith email to :James that he would make an end of the menacing and nuisance harassment, for the man to stop with his troublesome actions. However:

26. 2018 October-November: within full comprehension of the 2017 May-June Contract, :my in-good-faith effort to stop the harassment from the man :James resulted in the PINAL/Pinal county filing an :affidavit in a fraud by the PINAL/Pinal county hiding the most substantive material fact in this matter; the :standing 2017 May-June 8th Contract.

27. :James: Code Compliance Officer Meadows, was the man stalking-about and harassing our community for what seemed to be about 3-4 months of this interference of :our rights to live in peace without menace or nuisance from a public servant acting under/by the authority of the PINAL/Pinal county: driving county cars; stalking-about :my land-home area to goad me into responsibly speaking to the man- James; and, filing a suit after goading :me into communicating with him to stop his stalking and harassment at :my land and home area.

28. 2018: November; After the suit was filed by the PINAL/Pinal county then simultaneously the threats and demoralization disturbances on the land-home area completely ceased. – It appears the harassment-tool/method was for

1334
~~1334~~
DJK



to achieve a justification to use the PINAL/Pinal county court to harm :i-man-beneficiary, et al. by directly violating :i-man, et al. and then using the Arizona state Superior court to help hide the obligations PINAL/Pinal county has under the 2017 May-June 8th Contract.

29. 2019: November 2018 to now January 2019: Because i (et al.) were threatened, much of :my, et al. time and resources have been consumed with the stress of our standing against the PINAL/county machine, while efforts to respond to the concerted efforts of people even includes the Clerk of Court, – in what presents to be an in-Arizona-Superior-concert- protected PINAL/Pinal county abuse machine.

30. 2019: January: i-man believe there is greater need for the integrity in the ARIZONA/Arizona state- PINAL/Pinal county system.

Common Law- Court Of Record- Trial-By-Jury To Determination Of The Facts And The Law

31. For the fairness for :i-man, the right of a court-of-record with the trial-by-jury is essential to decide the issues of the law and the facts for this matter greater than \$20,00, and for the interference with a man's rights by the violations by the PINAL/Pinal trustee with apparent ARIZONA/Arizona state Superior court assistance against :i-man: Jay-Roy: Ingold.

32. How can the issue to be soundly left to the frank fraud-demonstrated in

1335



this matter? – as that which starts in fraud ends in fraud.

33. I believe that the common law- court-of-record with the trial-by-jury for to decide the issues of the law and the facts in this matter under the immensity of the fraud-demonstrated in this circumstance is unavoidable, reasonable, prudent, lawful and necessary by :i- man-beneficiary, et al. injured, and with this response :i request the same common law- court-of-record with the trial-by-jury for to decide the issues of the law and the facts in this matter.

Without Prejudice
JAY ROY INGOLD, subrogation

Jay-Roy : Ingold *Executor*
Jay-Roy: Ingold, beneficiary- respondent-
Executor

Verified and autographed before me this 25 day: January: 2019.

seal

[Signature]
notary

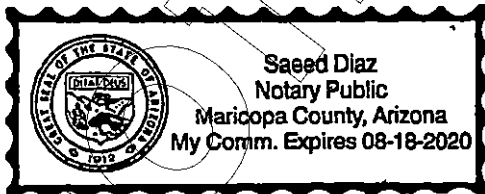



Jay- Roy: Ingold: beneficiary and Executor
c/o 5142 East 18th Avenue
Apache Junction, Arizona ZIP CODE EXEMPT
DMM 602.1.3.e2. Title 18 U.S.C. § 1342
602.499.8807

:man :present:

Arizona state
Pinal county

**SUPERIOR COURT OF ARIZONA
PINAL COUNTY**

PINAL COUNTY,
:Plaintiff;

Case No. CV 201801825
THE HON. BRENDA E OLDHAM

v.

RESPONDENT'S NOTICE:

JAY INGOLD, also know as JAY ROY
INGOLD: subrogation of the man
beneficiary: Jay-Roy: Ingold: sui juris
:Aggrieved Party

:Respondent- Executor;
Cross-Claimant.

**PRAECIPE FOR THE OATH OF
OFFICE OF THE FOLLOWING
KNOWN AND UNKNOWN PERSONS
ASSOCIATED WITH THE
COMPLAINANTS' ACTION:
namedly: Himanshu: Director,
Community Development Patel;
:Paula: Code Compliance Manager
Mullenix; Terrilyn: Code Compliance
Officer Klucar; :James: Code
Compliance Officer Meadows;
:Kent: Pinal County Attorney
Volkmer; :Craig: Deputy County
Attorney Cameron; :John-Doe;
:Jane-Doe.**

1337
1339
1351

v.

:Himanshu: Director, Community Development Patel,
:Paula: Code Compliance Manager Mullenix,
:Terrilyn: Code Compliance Officer Klucar,
:James: Code Compliance Officer Meadows,
:Kent: Pinal County Attorney Volkmer,
:Craig: Deputy County Attorney Cameron,
:John-Doe,
:Jane-Doe,

:Cross-Claim Respondents.

:AFFIANT: Man :Principal

:Jay-Roy: family name: Ingold: Indianan -1962: sui juris: beneficiary and executor:
status adopted by reference. See: A of the Almighty-God-given natural rights, and
the :beneficiary- subrogee and executor of the public trust subrogation named: JAY
ROY INGOLD~ et al. derivatives created by the UNITED STATES government-
trustee, et al., et seq. - also including the PINAL/ Pinal county, STATE OF
ARIZONA/ Arizona state government-trustee.

PRAECIPE FOR THE OATH OF OFFICE

1. This :praecipe is a demand upon the PINAL/Pinal county complainant for to
provide to the respondent-executor: Jay-Roy - :man, all of the information as now
directed: -- Provide: oath of office of the following known and unknown persons
associated with the complainant's action on and after the 2017 May-June 8th: Contract;
- named: Himanshu: Director, Community Development Patel, :Paula: Code

COPY

1338
[Handwritten signature]



Compliance Manager Mullenix, :Terrilyn: Code Compliance Officer Klucar, :James:
Code Compliance Officer Meadows; :Kent: Pinal County Attorney Volkmer, :Craig:
Deputy County Attorney Cameron, :John-Doe, and: Jane-Doe.

2. You are required to provide a copy of the oaths of office taken of each person
named and otherwise involved in the decision(s) in bringing the PINAL/Pinal county
action against the man: Jay-Roy: Ingold.

Sincerely,
Without Prejudice
JAY ROY INGOLD, subrogation

Jay-Roy Ingold
Jay-Roy: Ingold, beneficiary, President-
Executor



JURAT

Affirmed and autographed before me this 23 day: January: 2019 A.D.;
:Type- Identification: Arizona Driver License

Seal

[Signature]
notary

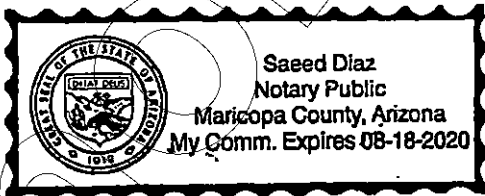

1339



:Beverly-Jean: Hill: beneficiary and Executor
c/o 5142 East 18th Avenue
Apache Junction, Arizona ZIP CODE EXEMPT
DMM 602.1.3.e2. Title 18 U.S.C. § 1342
602.499.8807

:man :present:

Arizona state
Pinal county

**SUPERIOR COURT OF ARIZONA
PINAL COUNTY**

PINAL COUNTY,
:Plaintiff;

Case No. CV 201801825
THE HON. BRENDA E OLDHAM

v.

**:RESPONDENT NOTICE: -
Attached: Constructive Notice Of The
Setting Of The Presumptions -
(Initially: USPS CMN 7018 0360 0000
5969 2963; rec'd:**

JAY INGOLD, also know as JAY ROY
INGOLD: subrogation of the man
beneficiary: Jay-Roy: Ingold: sui juris
:Aggrieved Party

:Respondent-

Executor;

Cross-Claimant.

v.

:Himanshu: Director, Community
Development Patel, :Paula: Code
Compliance Manager Mullenix,
:Terrilyn: Code Compliance Officer
Klucar, :James: Code Compliance
Officer Meadows, :Kent: Pinal County
Attorney Volkmer, :Craig: Deputy

1340
[Handwritten signatures]

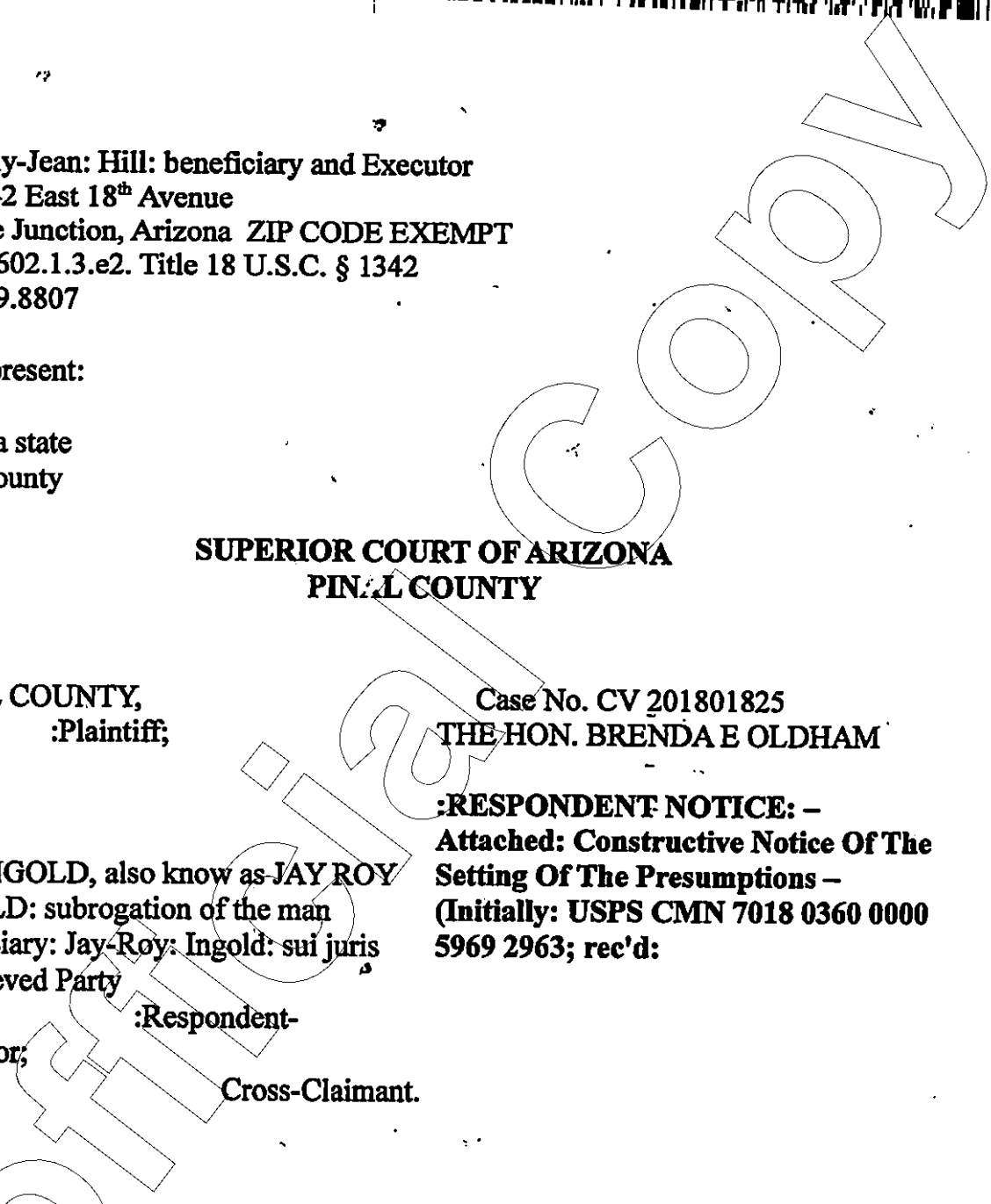



County Attorney Cameron,
:John-Doe, :Jane-Doe,

:Wrong-doers.

:AFFIANT: Man :Principal

:Jay-Roy: family name: Ingold: Indianan -1962: sui juris: beneficiary and executor:
status adopted by reference. See: A of the Almighty-God-given natural rights, and
the :beneficiary- subrogee and executor of the public trust subrogation named: JAY
ROY INGOLD~ et al. derivatives created by the UNITED STATES government-
trustee, et al., et seq. – also including the PINAL/ Pinal county, STATE OF
ARIZONA/ Arizona state government-trustee. i am a literafe, legal-idiot.

THE SETTING OF PRESUMPTIONS

1. Regarding: Constructive Notice Of The Setting Of Presumptions of the meeting for the discussion of the matter and the offer; for the fact: rebutted- or un-rebutted- presumptions variably effect the discussions on a matter by the visitors to the meetings. Wherefore: i:man : Jay-Roy: Ingold set these known presumptions:
2. Re: presumption of the public record, i:man :Jay-Roy: Ingold rebut and reject that a matter-at-hand is a private BAR-guild business matter. Heretofore: 'presumption of public record' is now to 'in perpetuity' set: that: this private business matter is to be recorded in a public environment and on the public record by the

1347
DAN



public record number (Case Number) on the OFFER: page 1 of this matter; and:

3. Re: presumption of the public service, i:man rebut and reject that a matter is ministered as a public service by the public servants. Heretofore: 'presumption of public service' is now to 'in perpetuity' set; that: any public person engaged in this private matter is deemed to be in the public service as a public servant; and:

4. Re: presumption of the public oath, i:man rebut and reject that a public servant's public service sworn oath is presumed not-superseded by some other oath. Heretofore: 'presumption of public oath' is now to 'in perpetuity' set; that: every public servant acting on the behalf of this matter is required to state all public and private sworn oaths superseding the public servant's sworn oath(s); and:

5. Re: presumption of the immunity, i:man rebut and reject that a public official's acts are immune from a personal accountability. Heretofore: 'presumption of the immunity' is now to 'in perpetuity' set; that: any person acting on a behalf of/as an agent for any nameless, faceless predilection or corporation is wholly personally liable for their actions on the behalf of that interest upon the Notice of Injury with a financial penalty¹; and:

6. Re: presumption of the summons, i:man rebut and reject that by a custom the any person visitor or attendee to the meeting is thereby and thereon by a default assumed to also accept a position under the court's jurisdiction. Heretofore:

¹ Financial penalty means: by tacit procuracy: pay due now- fee schedule: one ounce U.S. gold coin in specie per the minute until the matter is resolved.

1344
134



a public servant and government employees are rejected: absolutely no jurisdiction may be claimed. However, the need for to contribute unto the well-being of the community is acknowledged and graciously embraced; and:

10. Re: presumption of the government acting in two roles as the executor and beneficiary, i:man rebut and reject that the judge or magistrate may act in the role as the executor with the prosecutor acting in the role as the beneficiary. Heretofore: 'presumption of the government acting in two roles as executor and beneficiary' is now to 'in perpetuity' set: that i: man am the general executor, general guardian, and beneficiary and executor in all matters-at-hand pertaining to the legal person -subrogation: JAY ROY INGOLD, as well as to the flesh and blood living soul: Jay-Roy: Ingold; and:

11. Re: presumption of the agent and agency, i:man rebut and reject that i:man, as if presumed to be under a contract, express or grant authority to a judge or magistrate by the use of a certain legal term ~ as recognize, understand or comprehend -, and thereby and thereon agree to be bound to perform under the direction of a judge or magistrate. Heretofore the 'presumption of agent and agency' is now to 'in perpetuity' set: that: under no circumstance may a judge or magistrate assume the executor role; and:

12. Re: presumption of the incompetence, i:man rebut and reject that visitors at the court are, at the least, ignorant of the law, incompetent to present and/or argue

1343
BAP



“properly”, and, therefore, the judge or magistrate as the executor has the right to arrest, detain, fine, or force a psychiatric evaluation. Heretofore: 'presumption of incompetence' is now to 'in perpetuity' set: that: i:man know the position of the executor and beneficiary; and rebuke and object to any contrary presumption. – No privilege of the deeming i:man incompetent is permitted; and:

13. Re: presumption of the guilt, i:man rebut and reject that i:man am presumed guilty or to be held until a bond is guaranteed. Heretofore: 'presumption of guilt' is now to 'in perpetuity' set: that, under no circumstance may i:man be: a) presumed guilty, or b) detained; nor: c) may any financial transactions occur in the favor of the court.

Without Prejudice
JAY ROY INGOLD, subrogation

Jay-Roy Ingold
Jay-Roy: Ingold, beneficiary, resident-
Executor

Affirmed and autographed before me this 25 day: January: 2019 A.D.;

:Type- Identification: Arizona Driver License

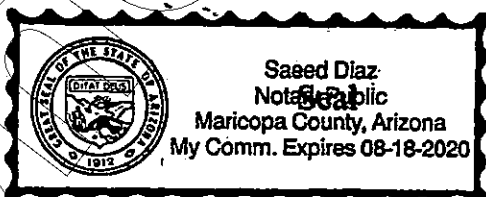

notary

1344



:Jay- Roy: Ingold: beneficiary and Executor
c/o 5142 East 18th Avenue
Apache Junction, Arizona ZIP CODE EXEMPT
DMM 602.1.3.e2. Title 18 U.S.C. § 1342
602.499.8807

:man :present:

Arizona state
Pinal county

**SUPERIOR COURT OF ARIZONA
PINAL COUNTY**

PINAL COUNTY,
:Plaintiff;

Case No. CV 201801825

THE HON. BRENDA E OLDHAM

v.

**RESPONDENT'S NOTICE:
:PINAL/PINAL COUNTY-
GOVERNMENT IS A TRUSTEE
FOR THE Man-BENEFICIARY-
EXECUTOR: Jay-Roy: Ingold**

JAY INGOLD, also know as JAY ROY
INGOLD: subrogation of the man
beneficiary: Jay-Roy: Ingold: sui juris
:Aggrieved Party

:Respondent-

Executor;

Cross-Claimant.

v.

:Himanshu: Director, Community
Development Patel, :Paúla: Code
Compliance Manager Mullenix,
:Terrilyn: Code Compliance Officer
Klucar, :James: Code Compliance

1345



Officer Meadows, :Kent: Pinal County
Attorney Volkmer, :Craig: Deputy
County Attorney Cameron,
:John-Doe, :Jane-Doe,

:Wrong-doers.

:AFFIANT: Man :Principal

:Jay-Roy: family name: Ingold: Indianan -1962: sui juris: beneficiary and
executor: status adopted by reference. See: A of the Almighty-God-given natural
rights, and the :beneficiary- subrogee and executor of the public trust subrogation
named: JAY ROY INGOLD~ et al. derivatives created by the UNITED STATES
government-trustee, et al., et seq. - also including the PINAL/ Pinal county,
STATE OF ARIZONA/ Arizona state government-trustee. -

HISTORY OF TRUSTEE LEGACY

As relates to: from the :1776 United States Declaration of Independence to the
1781 Articles of Confederation to the 1787 Constitution for the United States of
America to the 1862 establishment of the Arizona territory to the establishment of
the 1875 Pinal county of the Arizona territory to the 1912 establishment of the
Arizona territory into the Arizona state no violation of the inalienable rights of the
man- Jay-Roy, et al. is/was transferred to the PINAL/Pinal county-government.

There to:

1. :i-man I see no verifiable evidence that the Constitution for the United

1346
~~1348~~



States of America ~ the Bill of Rights, and subsequent treaties compliant thereto, are not established for to protect :i-man under the power and restrictions granted under the original covenant, and also including the PINAL/Pinal county-government as we know it today, and :i believe no evidence to the contrary exists.

2. :i-man see no verifiable evidence that the ARIZONA/Arizona state-government-trustee and the subsequent PINAL/Pinal county-government-trustee did not contract with the UNITED STATES for to understand the UNITED STATES' trustee duties and responsibilities as trustees to the people, as No other option than the trusteeship can be lawfully contracted by any subsequent service providers to the people-beneficiaries, and :i believe no evidence to the contrary exists.

3. i-man-beneficiary see no verifiable evidence that the oaths of office for all of the PINAL/Pinal county-government-trustee persons involved in this matter against the man-beneficiary :Jay-Roy will not need to be inspected by the distributing agency and the Arizona Supreme court for to identify in the fact whether the PINAL/Pinal county persons associated with this matter are in fact compliant under the duty and responsibility of the trustee oath and bond to do No harm to :Jay-Roy, et al., and :i believe no such a evidence exists.

5. :i see no verifiable evidence that the PINAL/Pinal county persons, et al. are

1347
~~1347~~



enabled to abandon the trustee duties and obligations for the protection, non-competition, non-contracting against :i-man- Jay-Roy: Ingold, and :i believe no such a evidence exists.

3. :i see no verifiable evidence that the most probable presumption is that the PINAL/Pinal county is an organization subordinate to the Constitution for the United States of America, the :UNITED STATES government and the :STATE OF ARIZONA/ Arizona state government trustee restrictions, and :i believe no such a evidence exists.

Without Prejudice
JAY ROY INGOLD, subrogation

Jay-Roy: Ingold *executor*
Jay-Roy: Ingold, beneficiary- respondent-
Executor

JURAT

Affirmed and autographed before me this 25 day: January: 2019 A.D.;
:Type- Identification: Arizona Driver License

notary

Seal

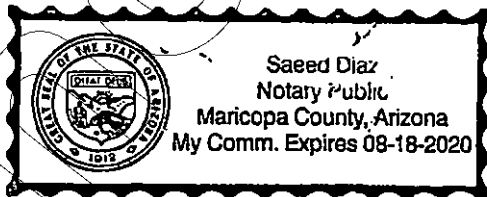

1348



:Tracy-Robert: Calhoun, :beneficiary and Executor
c/o 5142 East 18th Avenue
Apache Junction, Arizona ZIP CODE EXEMPT
DMM 602.1.3.e2. Title 18 U.S.C. § 1342

:man :present:

Arizona state
Pinal county

**SUPERIOR COURT OF ARIZONA
PINAL COUNTY**

PINAL COUNTY,
:Plaintiff;

Case No. CV 201801825
THE HON. BRENDA E OLDHAM

v.

JAY INGOLD, also know as JAY ROY
INGOLD: subrogation of the man
beneficiary: Jay-Roy: Ingold: sui juris
:Aggrieved Party

**:AFFIDAVIT: CONTACT WITH
:James: CODE COMPLIANCE
OFFICER MEADOWS – :AFFIANT:
man :Tracy-Robert: Calhoun:
ACQUAINTED WITH THE FACTS,
FOR, AND, ON BEHALF OF :Jay-
Roy: Ingold.**

Executor;

:Respondent-

Cross-Claimant.

v.

:Himanshu: Director, Community
Development Patel, :Paula: Code
Compliance Manager Mullenix,
:Terrilyn: Code Compliance Officer
Klucar, :James: Code Compliance

:Affidavit :Tracy-Robert: Calhoun USPS RMN RE 322 404 036 US

13519



Officer Meadows, :Kent: Pinal County
Attorney Volkmer, :Craig: Deputy
County Attorney Cameron,
:John-Doe, :Jane-Doe,

:Wrong-doers.

:AFFIANT: Man :Principal

**:i-man am a living man - :i, :my - the blood flows and the flesh lives: given
name :Tracy-Robert: family name: Calhoun: Arkansas -1964: mature and of sound
mind: beneficiary and executor of the Almighty-God-given natural rights, and
the :beneficiary- subrogee and executor of the public trust subrogation named:
TRACY ROBERT CALHOUN~ et al. derivatives created by the UNITED
STATES government-trustee, et al., et seq. - also including the PINAL/ Pinal
county, STATE OF ARIZONA/ Arizona state government-trustee. :i-man am not a
UNITED STATES Citizen. To the best of my knowledge are the facts set forth
herein are true and accurate. :i am a literate, legal-idiot.**

Contacts

- 1. In the summer: July: 2018, :i: Tracy-Robert: Calhoun was visiting at the
land and home area of :Jay-Roy: Ingold at the location indicated above.**
- 2. During the time of the visit on two different occasions, and maybe a third
time, :i came into to contact with the man behind the bushes now known as :James:**

:Affidavit :Tracy-Robert: Calhoun USPS RMN RE 322 404 036 US

2 / 4

1350A



Code Compliance Officer Meadows.

3. On the first occasion there was a meeting: i was warned by another visitor (Larry) who drove onto the land area that a man was behind the bushes just outside of the trespassing sign.

4. :i-man introduced myself to the man -James who had parked and positioned himself behind a large bush some 30 feet from the edge of the land – :i told him :i was a friend of :Jay's and was visiting.

5. :James began talking about what was on the land.

6. :James said the case was going to court.

7. :James began talking about the RV.

8. :James said, 'Jay needs to talk to him'.

9. :i told :James, ':i would tell Jay he was here.'

10. On the second occasion, I observed :James standing behind the bushes at the driveway edge taking pictures for a while, about :ten to twelve (10-12) minutes, then: he got into his truck and left the area.

11. On a third time occasion: :i was walking about the land and heard and then discovered a white drone machine with a what appeared to be a camera hovering over the land inside of the area of the property.

12. :i stared directly into the lens of the camera wondering if the device was

1353
PAM



taking my picture.

Tracy-Robert Calhoun
Tracy-Robert: Calhoun, :beneficiary, :executor

JURAT

Affirmed and autographed before me this 25 day: January: 2019 A.D.;
:Type- Identification: Arizona state id

[Signature]
notary

Seal

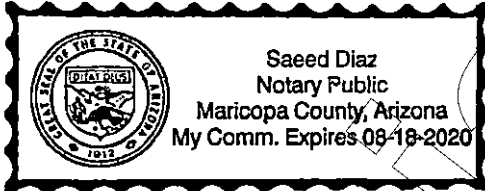

1355
[Handwritten initials]



:Darrell-James: Hill, :beneficiary and Executor
c/o 5142 East 18th Avenue
Apache Junction, Arizona ZIP CODE EXEMPT
DMM 602.1.3.e2. Title 18 U.S.C. § 1342

:man :present:

Arizona state
Pinal county

**SUPERIOR COURT OF ARIZONA
PINAL COUNTY**

PINAL COUNTY,
:Plaintiff;

Case No. CV 201801825
THE HON. BRENDA E OLDHAM

v.

JAY INGOLD, also know as JAY ROY
INGOLD: subrogation of the man
beneficiary: Jay-Roy: Ingold: sui juris
:Aggrieved Party
:Respondent- Executor;
Cross-Claimant.

**:AFFIDAVIT: CONTACT WITH
:James: CODE COMPLIANCE
OFFICER MEADOWS -- :AFFIANT:
man :Darrell-James: Hill¹:
ACQUAINTED WITH THE FACTS,
FOR, AND, ON BEHALF OF :Jay-
Roy: Ingold.**

v.

:Himanshu: Director, Community
Development Patel, :Paula: Code
Compliance Manager Mullenix,
:Terrilyn: Code Compliance Officer
Klucar, :James: Code Compliance

1 Gila county Arizona: Doc. # 2017-002378: pp. 6-24, 93-95 of 693

:Affidavit :Darrell-James: Hill, USPS RMN RE 322 404 036 US

1353
RAH

COPY



Officer Meadows, :Kent: Pinal County
Attorney Volkmer, :Craig: Deputy
County Attorney Cameron,
:John-Doe, :Jane-Doe,

:Wrong-doers.

AFFIANT: Man :Principal

:i-man am a living man - :i, :my - the blood flows and the flesh lives: given
name :Darrell-James: Hill: family name: Ohioan -1958: mature and of sound mind:
beneficiary and executor of the Almighty-God-given natural rights, and the
:beneficiary- subrogee and executor of the public trust subrogation named:
DARRELL JAMES HILL~ et al. derivatives created by the UNITED STATES
government-trustee, et al., et seq. - also including the PINAL/ Pinal county,
STATE OF ARIZONA/ Arizona state government-trustee. :i-man am not a
UNITED STATES Citizen. To the best of my knowledge, the facts set forth herein
are true and accurate. :i-man am a literate, legal-idiot.

Contacts with the man- James: Meadows

1. In the summer: July: 2018, :- Darrell-James: Hill was living at the
land and home area of :Jay-Roy: Ingold at the location indicated above. -
2. :i and wife :Beverly-Jean: Romero- Hill, :beneficiary, :executor are the
stewards over this land area under a simple express contract that is binding.

1354



3. During this time, as alerted by our dog's barking my wife noticed a man standing behind the creosote bush at the edge of the land area; he had a white truck that was also parked behind the creosote bush.
4. The :man behind the bush did not introduce his presence to us people who are on the land.
5. :my wife made notice to :me about the man behind the creosote bush.
6. :i went to see who was this man behind the bush and, if need be, to shew him away.
7. The :man is now known as :James: Code Compliance Officer Meadows.
8. :James stood there with a brown folder of papers.
9. :James reported that he inherited the case from the previous agent, and declined to comment further about what that meant.
10. :James asked: who :i was: Ans. 'Darrell-James', the steward of this property, meaning in common use.
11. :James asked: what was :my phone number: Ans. 'No'
12. :i inquired of :James about what happened to the other worker. Ans. ' I can't tell you....'
13. :James gave a business card.
14. :i-man gave the business card and the report of above patterns of the matter

1355



to the man:Jay-Roy.

15. :i-man-steward continued the extra duty to monitor the menace and nuisance situation of the man-James' pattern of the unannounced- stranger-danger method, from July to about October.

16. :James' disturbances ceased after :Jay-Roy. began with an email to the man-James for his behavior in the harassment; about October 2017.

17. A PINAL/Pinal county suit a against the man- Jay-Roy was served October-November and had a threatening effect upon :Jay-Roy, et al. for the matters /regarding the 2017 May-June 8th Contract

:Darrell-James Hill, executor
:Darrell-James: Hill, :beneficiary, :executor

JURAT

Affirmed and autographed before me this 25 day: January: 2019 A.D.;;
:Type- Identification: Arizona Driver License

Seal

Sadie Jo Bingham Sadie Jo Bingham
notary

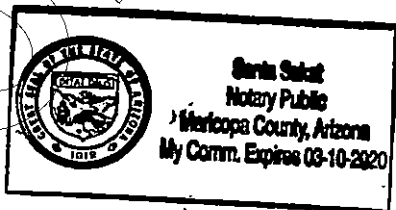

1358
1358



:Beverly-Jean: Romero- Hill, :beneficiary and Executor
c/o 5142 East 18th Avenue
Apache Junction, Arizona ZIP CODE EXEMPT
DMM 602.1.3.e2. Title 18 U.S.C. § 1342

:man :present:

Arizona state
Pinal county

**SUPERIOR COURT OF ARIZONA
PINAL COUNTY**

PINAL COUNTY,
:Plaintiff;

Case No. CV 20f801825
THE HON. BRENDA E OLDHAM

v.

JAY INGOLD, also know as JAY
ROY INGOLD: subrogation of the
man beneficiary: Jay-Roy: Ingold: sui
juris

:Aggrieved Party
:Respondent- Executor;

Cross-Claimant.

:AFFIDAVIT: CONTACT WITH
:James: CODE COMPLIANCE
OFFICER MEADOWS -
AFFIANT: man :Beverly-Jean:
Romero- Hill¹: ACQUAINTED
WITH THE FACTS, FOR, AND,
ON BEHALF OF :Jay-Roy: Ingold.

v.

:Himanshu: Director, Community
Development Patel, :Paula: Code
Compliance Manager Mullenix,

1 Gila county Arizona: Doc. # 2017-002378: pp. 2-44, 93-95 of 693

1359



:Terrilyn: Code Compliance Officer
Klucar, :James: Code Compliance
Officer Meadows, :Kent: Pinal
County Attorney Volkmer, :Craig:
Deputy County Attorney Cameron,
:John-Doe, :Jane-Doe,

:Wrong-doers.

AFFIANT: Man :Principal

:i-man am a living man-female – :i, :my - the blood flows and the flesh lives:
given name :Beverly-Jean: Romero- Hill: family name: New Mexican -1958:
mature and of sound mind: beneficiary and executor of the Almighty-God-
given natural rights, and the :beneficiary- subrogee and executor of the public
trust subrogation named: BEVERLY-JEAN: ROMERO- HILL~ et al.
derivatives created by the UNITED STATES government-trustee, et al., et seq.
– also including the PINAL/ Pinal county, STATE OF ARIZONA/ Arizona
state government-trustee. :i-man am not a UNITED STATES Citizen. To the
best of my knowledge are the facts set forth herein are true and accurate. :i am
a literate, legal-idiot.

Contacts

1. In the summer: July: 2018, :i- Beverly-Jean: Romero- Hill was living at
the land and home area of :Jay-Roy: Ingold at the location indicated above.

1350
AV



:i and my husband :Darrell-James: Hill, :beneficiary, :executor are the stewards over this property under a simple express contract that is binding.

2. During this time, as alerted by our dog's barking, a man was discovered standing behind the creosote bush at the edge of the property; he had a white truck that was also hidden behind the creosote bush.

3. :i did not know who is the man.

4. The :man behind the bush did not say who he is.

5. :i went to get my husband: Darrell-James.

6. :my husband and :i went to see who was this man behind the bushes.

7. :my husband began to inquire for to know who the man was and why he was at the land.

8. The :man is now known as :James: Code Compliance Officer Meadows.

9. :Valerie :neighbor came over to inquire about who is the man, saying: she noticed the PINAL COUNTY logo on the truck.

10. The :man stood there with a brown folder of papers.

11. :James reported that he inherited the case from the previous agent.

12. :James asked: who my husband was: Ans. 'Darrell-James.'

13. :James asked: what was Darrell-James phone number: Ans. 'No'

1359
[Handwritten signature]



14. :James then gave a business card to the steward: Darrell-James.

Beverly-Jean Romero Hill
:Beverly-Jean: Romero- Hill, :beneficiary, :executor

JURAT

Affirmed and autographed before me this 25 day: January: 2019 A.D.;;
:Type- Identification: Arizona Driver License

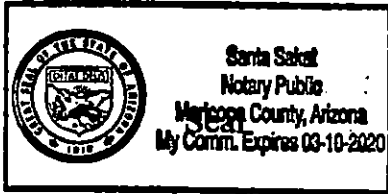

Santa Saket
notary

Unofficial Copy

1360



:Jay-Roy: Ingold :beneficiary :Respondent Executor
c/o 5142 East 18th Avenue
Apache Junction, Arizona ZIP CODE EXEMPT
DMM 602.1.3.e2. Title 18 U.S.C. § 1342

:man :present:

Arizona state
Pinal county

**SUPERIOR COURT OF ARIZONA
PINAL COUNTY**

PINAL COUNTY,
:Plaintiff;

Case No. CV 201801825

v.

**:RESPONDENT NOTICE:
REQUIRED JOINDER OF THE
Man- James-William: Woods**

JAY INGOLD, also know as JAY ROY
INGOLD: subrogation of the man
beneficiary: Jay-Roy: Ingold: sui juris
:Aggrieved Party

:Respondent-Executor;
Cross-Claimant.

v.

:Himanshu: Director, Community
Development Patel, :Paula: Code
Compliance Manager Mullenix, :Terrilyn:
Code Compliance Officer Klucar, :James:
Code Compliance Officer Meadows, :Kent:
Pinal County Attorney Volkmer, :Craig:
Deputy County Attorney Cameron,

Required Joinder :James-William USPS RMN RE 322 404 036 US

1 / 3

1361

COPY



:John-Doe, :Jane-Doe,

:Wrong-doers.

:AFFIANT: Man :Beneficiary: Respondent-Executor

1. :i-man am a living man – the blood flows and the flesh lives – given name :Jay-Roy: family name: Ingold: Indianan -1962: of sound mind, :beneficiary and executor of the Almighty-God-given natural rights, and the :beneficiary- subrogee and executor of the public trust subrogation named: JAY ROY INGOLD~ et al. derivatives created by the UNITED STATES government-trustee, et al., et seq. – also including the PINAL/ Pinal county-government-trustee, STATE OF ARIZONA/ Arizona state-government-trustee.

REQUIRED JOINDER OF THE Man- James-William: Woods

2. :Three-four years now :i met and befriended: James-William: Woods while at this present land and home area.
3. :James-William lived with me briefly after his home burned down.
4. :James-William owns private, non-commercial property on the land.
5. To my knowledge the :PINAL/Pinal county does not know that the man: James-William: Woods has private property on :my land and home area.
6. :James-William: Woods has been and now is subject to the loss of his private property based upon the tenets of the PINAL/Pinal county complaint made

1364



against :i-man.

7. Is is most obvious that without :James-William as a respondent in this matter, he will likely be unable, as a practical matter, to protect his rights and interests against the PINAL/Pinal county aggression.

Without Prejudice
JAY ROY INGOLD, subrogation

Jay-Roy : Ingold executor
Jay-Roy: Ingold, beneficiary- respondent-
Executor

Affirmed and autographed before this 25 day: January: 2019.
Type Identification: Arizona Driver License

Seal

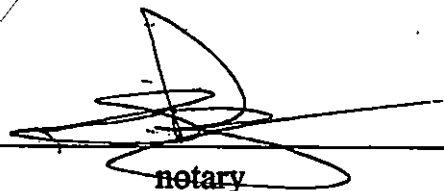
notary

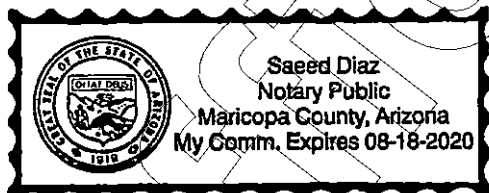

1363
BAX



Jay- Roy: Ingold: beneficiary and Executor
c/o 5142 East 18th Avenue
Apache Junction, Arizona ZIP CODE EXEMPT
DMM 602.1.3.e2. Title 18 U.S.C. § 1342
602.499.8807

:man :present:

Arizona state
Pinal county

**SUPERIOR COURT OF ARIZONA
PINAL COUNTY**

PINAL COUNTY,
:Plaintiff;

Case No. CV 201801825
THE HON. BRENDA E OLDHAM

v.

RESPONDENT'S NOTICE:

JAY INGOLD, also know as JAY ROY
INGOLD: subrogation of the man
beneficiary: Jay-Roy: Ingold: sui-juris
:Aggrieved Party

**:i-man Do Not Owe A Filing Fee --
Access To This Court By This Man
Jay-Roy: Ingold Is By :Right-executed
Not Subject To The Statutes-Used For
Privileged Persons Under License With
The STATE OF ARIZONA. - Failure
To Protect This Man In His Exercise Of
His Right As An Indianan :American Is
A Dereliction Of The Trustee Duty. -
Presumption: Probable Interference Of
The Rights-Executed By Concerted
Violation of the man-beneficiary: Jay-
Roy: Ingold, et al.**

:Respondent- Executor;
Cross-Claimant.

v.

:Himanshu: Director, Community
Development Patel, :Paula: Code
Compliance Manager Mullenix, :Terrilyn:
Code Compliance Officer Klucar, :James:
Code Compliance Officer Meadows,
:Kent: Pinal County Attorney Volkmer,
:Craig: Deputy County Attorney
Cameron,

Owe No filing fee: USPS RMN RE 322 404 036 US

1/8

12/14
BIB

COPY



:John-Doe, :Jane-Doe,

:Wrong-doers.

:AFFIANT: Man :Principal

:Jay-Roy: family name: Ingold: Indianan -1962: sui juris: beneficiary and executor: status adopted by reference. See: A of the Almighty-God-given natural rights, and the :beneficiary- subrogee and executor of the public trust subrogation named: JAY ROY INGOLD~ et al. derivatives created by the UNITED STATES government-trustee, et al., et seq. – also including the PINAL/ Pinal county, STATE OF ARIZONA/ Arizona state government-trustee. :i am not a U.S. CITIZEN.

Stress Of The Nearly Two Years

1. Under threat and duress :i-man-beneficiary of the people-trust have for nearly two years endured the progressive willful interference of :my rights-executed. :i am a common man, an: Indianan, an :American; NOT A U.S. CITIZEN.

:i-man, et al. Have Been Injured;

2. :i, et al. claim that :i, et al., have been injured for the expressly saying 'No' by the 2017 may-June 8th Contract to the PINAL/Pinal county offers for to implement what :i experienced from them, bad-faith bullying against :i-man's wishes resulting in the use of their proximal ARIZONA/Arizona state trustee court access for the unlawful and illegal processes that are repugnant to the Arizona Constitution and the

1365
[Handwritten signature]



Constitution for the United States of America, et seq., – and also including the 1993 U.S. treaty: International Covenant of Civil and Political Rights, :ICCPR- 1993.

:2017 May-June 8th Contract

3. :i see no verifiable evidence that i did not conditionally accept the PINAL/Pinal county offer by a simple contract expressly and openly to saying, “NO” as best :i-man could at that time; – This is the ':PINAL/Pinal county and :Jay-Roy: Ingold' 2017 May-June 8th Contract, and I believe no evidence to the contrary exists.

: 2017 May-June 8th Contract Accepted

4. i see no verifiable evidence why :my good faith 2017 May-June 8th Contract was not accepted for to allow the :man :Jay-Roy: Ingold to say “NO” to the Community Development Corporation's methodology in the presumption to take my authority over my land and home area, and :i believe no evidence to the contrary exists.

The :2017 May-June 8th Contract Was Complied With For About One Year

5. The PINAL/Pinal county kept our 2017 May-June 8th Contract for about a year. Then in the mid-summer of: 2018 the stalking-about the land area started by the man :James: Code Compliance Officer Meadows.

6. The PINAL/Pinal county allows the man: James to re-assume the same methods of bullying and presumptive actions as used before the 2017 May-June 8th Contract. – :James did stalking-about and continued the harassment until :i-man: Jay-

1366



Roy had to begin communications for to require the man to stop.

7. :My contact for the man- James to stop his being a menace-and- nuisance was used by the man- James as the apparent pretense for to create the opportunity sought by the stalking behaviors for to find a technical justification to file the VERY Untimely Suit still based in the fraud.

8. Such a suit was also authorized and due to be filed some 30-60 days after the Hearing meeting, and the suit is not in the compliance with the 2017 May-June 8th Contract.

:Constitutional Restriction-Injuries

9. Unlawful actions by any PINAL/Pinal county person that construct and implement or premeditate the harm of the man-beneficiary: Jay-Roy, et al., is a violation of the constitutional restriction(s) of that government action(s): Executive and/or Legislative and/or Judicial.

10. To my knowledge, the first court related constitutional restriction-injury occurred at the Hearing meeting on June 8th, 2017 under the new 2017 May-June 8th Contract, when the man moderating the meeting ignored the 2017 May-June 8th Contract, and then-after began to re-contract with :me for to accept his unlawful action in the ignoring of the 2017 May-June 8th Contract, and instead, to seek an appeal as a man within a formal Superior Court of Arizona commercial hearing. -

11 :i believe this is a fraud upon the man: Jay-Ingold, et al. and shows evidence of

Handwritten notes and signatures:
11/26/22
1367



a terrible PINAL/Pinal county-machine in-action to harm the living souls in a sympathetic disregard of the :man, et al. by the abandonment of the Trustee duty and obligation to :i-man, et al., and :i believe no evidence to the contrary exists.

After Two Years OF The Apprehension Of The PINAL/Pinal County Corruption And Fraud.-- ~ :i Wish To Resolve This Matter Immediately In A Common Law Court With The Trial By The Jury Deciding Both The Law And The Facts

12. :i believe more than one reason necessitates the need for the new view of this matter in the courts designed for the man, -- the :common law court with the trial by the jury deciding both the law and the facts. -- that is:

13. the commercial venue under a statutory jurisdiction forced upon a man is not a jurisdiction for the remedy for the man-beneficiary :Jay-Roy, et al., presently suffering from an open PINAL/Pinal county apparently condoned constitutional and statutory irreverent dereliction of the Trustee duty and obligation to protect the people from the PINAL/Pinal county predisposition.

14. :i see no verifiable evidence why :my documents are held to a high standard by the PINAL/Pinal county Clerk of Court. -- :i am not an an attorney or some member of the BAR guild. -- :i am a common man answering as best as possible and openly reporting wrong done to harm :me, et al., by the PINAL/Pinal county persons, and :i believe no evidence to the contrary exists.

[Handwritten signature and scribbles]
1368



15. :i see no verifiable reason why a common law court of record with the trial by jury to decide these issues of law and fact is not the only reasonable option for the address my claim of injury and suffering under an ongoing interference with my natural rights and by the open use of fraud(s) in the face of this court, and :i believe no evidence to the contrary exists.

Law Supporting :i-man's right to common law court trial by a jury

16. :i see no verifiable evidence that the U.S. government Constitution does not refer specifically to :me as a common Indianan American having a right to the use these Arizona county courts by the right at my will, and :i believe no evidence to the contrary exists.

17. :i see no verifiable evidence that the Arizona government Constitution does not refer specifically to :me as a common Indianan American man having a right to the use of the Arizona county courts by the right at my will, and :i believe no evidence to the contrary exists.

18. :i see no verifiable evidence that ANY Arizona Statutory Law could or does supersede the Arizona Constitution or the Constitution for the United States of America, and :i believe no evidence to the contrary exists.

19. :i see no verifiable eyidence why that :my USPS Registered and Certified Mail delivered documents and payment from a man-of -the-people has been twice sent back by the PINAL/Pinal county Clerk of Courts with added directions to closely

1369



follow the Arizona Revised Statutes, and: i believe no evidence to the contrary exists.

20. :i see no verifiable evidence why the Clerk of the Court and the Chief Presiding Judge: Pinal count, both who have been notified, have not intervened to provide the constitutional right to court services to :i-man in this case in the accordance with the rights-executed in this matter, and: i believe no evidence to the contrary exists.

21. :i see no verifiable evidence that, as a matter of the record: the PINAL/Pinal Clerk of the Court did not twice send-back the payment of the the moneys sent for the presumed fees along with the Clerk's instructions to again pay the sane fees presumably owed, and :i believe no evidence to the contrary exists.

22. :i see no verifiable evidence that :i, et al. have not been injured by the actions of PINAL/Pinal county-government persons by the misuse of their authority against :me possibly because though :i-man, et al. am literate :i-man am a legal-idiot, and :i believe no evidence to the contrary exists.

23. :i see no verifiable evidence that the PINAL/Pinal county persons did not attempt while under the new 2017 May-June 8th Contract to violate their obligations to the 2017 May-June 8th Contract by/through the use of the Hearing person over-driving the meeting into an authoritarian- 'take-it or leave-it'- proposition openly offered by the dereliction of his Trustee duty and obligations to the man-beneficiary :Jay-Roy, et al. and :i believe no evidence to the contrary exists.

24. The presumption is that there is most probable evidence of the willful

1370A



interference of :i-man's constitutionally guaranteed Almighty-God-given rights-
executed to retain his rights-executed.

Sincerely,

Without Prejudice
JAY ROY INGOLD, subrogation

Jay-Roy Ingold
Jay-Roy: Ingold, beneficiary, respondent-
Executor

JURAT

Affirmed and autographed before me this ___ day: January: 2019 A.D.;
:Type- Identification: Arizona Driver License

Seal

[Signature]
notary

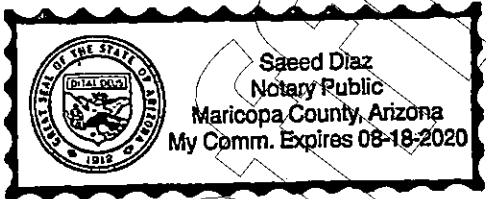

Owe No filing fee: USPS RMN RE 322 404 036 US

8/8

1377
PA



Jay- Roy: Ingold: beneficiary and Executor
c/o 5142 East 18th Avenue
Apache Junction, Arizona ZIP CODE EXEMPT
DMM 602.1.3.e2. Title 18 U.S.C. § 1342
602.499.8807

:man :present:

Arizona state
Pinal county

**SUPERIOR COURT OF ARIZONA
PINAL COUNTY**

PINAL COUNTY,
:Plaintiff;

Case No. CV 201801825
THE HON. BRENDA E OLDHAM

v.

JAY INGOLD, also know as JAY
ROY INGOLD: subrogation of the
man beneficiary: Jay-Roy: Ingold: sui
juris
:Aggrieved Party

RESPONDENT'S NOTICE:
:Jay-Roy's LAND-HOME:
"ZIP CODE EXEMPT: DMM
602.1.3.e2.: Addressing; :TITLE 18
U.S.C. § 1341:" Fraud And
Swindles. – Title 18 U.S.C. § 1342;
Fictitious Name Or Address

:Respondent-
Executor;

Cross-Claimant.

v.

:Himanshu: Director, Community
Development Patel, :Paula: Code
Compliance Manager Mullenix,

:Fraud And Swindles: USPS RMN RE 322 404 036 US

COPY

1379



:Terrilyn: Code Compliance Officer
Klucar, :James: Code Compliance
Officer Meadows, :Kent: Pinal
County Attorney Volkmer, :Craig:
Deputy County Attorney Cameron,
:John-Doe, :Jane-Doe,

:Wrong-doers.

:AFFIANT: Man :Principal

:Jay-Roy: family name: Ingold: Indianan -1962: sui juris: beneficiary and
executor: status adopted by reference. See: A of the Almighty-God-given
natural rights, and the :beneficiary- subrogee and executor of the public trust
subrogation named: JAY ROY INGOLD~ et al. derivatives created by the
UNITED STATES government-trustee, et al., et seq. – also including the
PINAL/ Pinal county, STATE OF ARIZONA/ Arizona state government-
trustee.

Re: ZIP CODE EXEMPT: DMM 602.1.3.e2.: Addressing, annexed.

1. :i- man :Jay-Roy believe :my :land and home area is a private and non-
commercial land and home for the living-soul: man- Jay-Roy: Ingold, et al.
2. :i believe no presumption can stand that my land and home area is a
military installation requiring the use of the United States Postal Service,

:Fraud And Swindles: USPS RMN RE 322 404 036 US

2/4

1273



USPS, zip code designations. Cf. DMM 602:1.2.e2; and :i believe no evidence to the contrary exists.

Re: TITLE 18 U.S.C. § 1341: Fraud And Swindles, annexed.

3. :i-man :Jay-Roy believe there is no verifiable evidence that the use of the PINAL/Pinal county as a person(s) for a/the convenience of a fraudulent activity is not also fined under 18 U.S.C. § 1341, or imprisoned for not more than 20 years whenafter the activity is brought-forward to the attention of the Postmaster General, and :i believe no evidence to the contrary exists.

4. :i see no verifiable evidence that the record of the instant matter provides the substantial facts that the PINAL/Pinal county person(s) has not engaged in the prohibited fraudulent activity as mentioned in this section. Cf.: under 18 U.S.C. § 1341 (attached), and :i believe no evidence to the contrary exists.

5. :i-man see no verifiable evidence to not believe the presumption that the PINAL/Pinal county person(s) violated the: 18 U.S.C. § 1341: Fraud And Swindles, and :i believe no evidence to the contrary exists.

:TITLE 18 U.S.C. § 1342: Fictitious Name Or Address, annexed.

:Fraud And Swindles: USPS RMN RE 322 404 036 US

3/4

1374
DMM



6. :i-man :Jay-Roy have attached a print out of the 18 USC 1342 restriction on the use address for any scheme mentioned in the section: Cf. 1341 of the USC Title 18.

Sincerely,

Without Prejudice
JAY ROY INGOLD, subrogation

Jay-Roy Ingold, executor
Jay-Roy: Ingold, beneficiary- respondent-
Executor

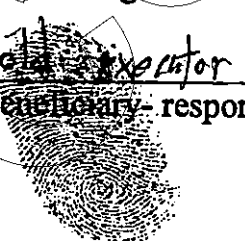

JURAT

Affirmed and autographed before me this 25 day: January: 2019 A.D.;
:Type- Identification: Arizona Driver License

[Signature]
notary

Seal

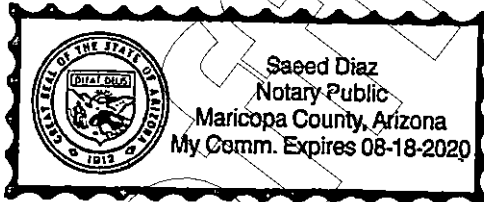

1375
180

18 USC 1342: Fictitious name or address

18 USC 1342: Fictitious name or address

Text contains those laws in effect on January 14, 2019

From Title 18-CRIMES AND CRIMINAL PROCEDURE

PART I-CRIMES CHAPTER

63-MAIL FRAUD AND OTHER FRAUD OFFENSES

§1342. Fictitious name or address

Whoever, for the purpose of conducting, promoting, or carrying on by means of the Postal Service, any scheme or device mentioned in section 1341 of this title or any other unlawful business, uses or assumes, or requests to be addressed by, any fictitious, false, or assumed title, name, or address or name other than his own proper name, or takes or receives from any post office or authorized depository of mail matter, any letter, postal card, package, or other mail matter addressed to any such fictitious, false, or assumed title, name, or address, or name other than his own proper name, shall be fined under this title or imprisoned not more than five years, or both.

(June 25, 1948, ch. 645, ; §6(j)(12), Aug. 12, 1970, ; title XXXIII, §330016(1)(H), Sept. 13, 1994, .)

Historical and Revision Notes

Based on title 18, U.S.C., 1940 ed., §339 (Mar. 4, 1909, ch. 321, §216,).

The punishment language used in section 1341 of this title was substituted in lieu of the reference to it in this section.

Minor changes in phraseology were made.

Amendments

1994- substituted "fined under this title" for "fined not more than \$1,000".

1970- substituted "Postal Service" for "Post Office Department of the United States".

Effective Date of 1970 Amendment

Amendment by effective within 1 year after Aug. 12, 1970, on date established therefor by Board of Governors of United States Postal Service and published by it in Federal Register, see section 15(a) of set out as an Effective Date note preceding section 101 of Title 39, Postal Service.

1376
~~1376~~
[Handwritten signature]

1/

2022-011769	MISC	Page: 1379 of 2782
09/26/2022 03:35:37 PM	Receipt #: 22-9381	
Rec Fee: \$30.00	Darrell James Hill	
Gila County, Az, Sadie Jo Bingham, Recorder		





602 Addressing

Overview

1.0 Elements of Addressing
2.0 Restrictions
3.0 Use of Alternative Addressing
4.0 Detached Address Labels (DALs) and Detached Marketing Labels (DMLs)
5.0 Move/Update Standard
6.0 ZIP Code Accuracy Standards
7.0 Carrier Route Accuracy Standard
8.0 Person Accuracy Validation and Evaluation (PAVE)
9.0 Coding Accuracy Support System (CASS)
10.0 Dual Shipping Labels

1.0 Elements of Addressing

1.1 Clear Space

A clear space must be available on all mail for the address, postage (permit imprint, postage stamp, or meter stamp), postmarks, and postal endorsements.

1.2 Delivery Address

The delivery address specifies the location to which the USPS is to deliver a mailpiece. Except for mail prepared with detached address labels under 4.0, the piece must have the address of the intended recipient, visible and legible, only on the side of the piece bearing postage.

1.3 Address Elements

All mail not bearing a simplified address must bear a delivery address that contains at least the following elements in this order from the top line:

- a. Intended recipient's name or other identification.
- b. Private mailbox designator ("PMB" or alternative "#") and number if the mailpiece is addressed to a commercial mail receiving agency (CMRA) address.
- c. Street and number. (Include the apartment number, or use the Post Office box number, or general delivery, or rural route or highway contract route designation and box number, as applicable.)
- d. City and state (or state abbreviation). The city is any acceptable mailing name for the 5-digit ZIP Code serving the intended recipient as shown in the USPS City State Product.
- e. ZIP Code where required:
 1. ZIP Codes are required on Priority Mail Express, commercial First-Class Mail, First-Class Package Service — Commercial, Periodicals, USPS Marketing Mail, Package Services and Parcel Select mailpieces, all mail





sent to military addresses within the United States and to APO and FPO addresses, official mail, Business Reply Mail, and merchandise return service mail.

2. Unless required above, ZIP Codes may be omitted from single-piece price First-Class Mail (including Priority Mail), First-Class Package Service — Retail, USPS Retail Ground, and pieces bearing a simplified address.

1.4 Complete Addresses

1.4.1 Complete Address Definition

A complete address has all the address elements necessary to allow an exact match with the current USPS ZIP+4 Product to obtain the finest level of ZIP+4 code for the delivery address. A complete address may be required on mail at some automation prices.

1.4.2 Complete Address Elements

A complete delivery address includes:

- a. Addressee name or other identifier and/or firm name where applicable.
- b. Private mail box designator and number (PMB 300 or #300).
- c. Urbanization name (Puerto Rico only, ZIP Code prefixes 006 to 009, if area is so designated).
- d. Street number and name (including predirectional, suffix, and postdirectional as shown in USPS ZIP+4 Product for the delivery address or rural route and box number (RR 5 BOX 10), highway contract route and box number (HC 4 BOX 45), or Post Office box number (PO BOX 458); as shown in USPS ZIP+4 Product for the delivery address). ("PO Box" is used incorrectly if preceding a private box number, e.g., a college mailroom.)
- e. Secondary address unit designator and number (such as an apartment or suite number (APT 202, STE 100)).
- f. City and state (or authorized two-letter state abbreviation). Use only city names and city and state name abbreviations as shown in USPS City State Product. Contact the National Customer Support Center (see 509.1.0) for more information about the City State Product.
- g. Correct 5-digit ZIP Code or ZIP+4 code. If a firm name is assigned a unique ZIP+4 code in the USPS ZIP+4 Product, the unique ZIP+4 code must be used in the delivery address.

1.5 Return Addresses

1.5.1 Purpose for Return Address

The return address tells the USPS where the sender of a mailpiece wants it returned if the piece cannot be delivered.

1.5.2 Return Address Elements

The return address contains elements corresponding to those for the delivery address. A return address is required in specific circumstances (see 1.5.3). If the sender's name is not included in the return address, another clear designation

6378
 1300
 1200
 1200



18 USC 1341: Frauds and swindles

18 USC 1341: Frauds and swindles

ext contains those laws in effect on January 14, 2019
From Title 18-CRIMES AND CRIMINAL PROCEDURE
PART I-CRIMES CHAPTER
63-MAIL FRAUD AND OTHER FRAUD OFFENSES

§1341. Frauds and swindles

Whoever, having devised or intending to devise any scheme or artifice to defraud, or for obtaining money or property by means of false or fraudulent pretenses, representations, or promises, or to sell, dispose of, loan, exchange, alter, give away, distribute, supply, or furnish or procure for unlawful use any counterfeit or spurious coin, obligation, security, or other article, or anything represented to be or intimated or held out to be such counterfeit or spurious article, for the purpose of executing such scheme or artifice or attempting so to do, places in any post office or authorized depository for mail matter, any matter or thing whatever to be sent or delivered by the Postal Service, or deposits or causes to be deposited any matter or thing whatever to be sent or delivered by any private or commercial interstate carrier, or takes or receives therefrom, any such matter or thing, or knowingly causes to be delivered by mail or such carrier according to the direction thereon, or at the place at which it is directed to be delivered by the person to whom it is addressed, any such matter or thing, shall be fined under this title or imprisoned not more than 20 years, or both. If the violation occurs in relation to, or involving any benefit authorized, transported, transmitted, transferred, disbursed, or paid in connection with, a presidentially declared major disaster or emergency (as those terms are defined in section 102 of the Robert T. Stafford Disaster Relief and Emergency Assistance Act (42 U.S.C. 5122)), or affects a financial institution, such person shall be fined not more than \$1,000,000 or imprisoned not more than 30 years, or both.

(June 25, 1948, ch. 645, ; May 24, 1949, ch. 139, §34, ; §(6)(j)(11), Aug. 12, 1970, ; title IX, §961(i), Aug. 9, 1989, ; title XXV, §2504(h), Nov. 29, 1990, ; title XXV, §250006, title XXXIII, §330016(1)(H), Sept. 13, 1994, , 214, ; title IX, §903(a), July 30, 2002, ; §4, Jan. 7, 2008, .)

Historical and Revision Notes

1948 Act

Based on title 18, U.S.C., 1940 ed., §338 (Mar. 4, 1909, ch. 321, §215,).

1379
~~1000000000~~

2022-011769 MISC Page: 1382 of 2782
09/26/2022 03:35:37 PM Receipt #: 22-9381
Rec Fee: \$30.00 Darrell James Hill
Gila County, Az, Sadie Jo Bingham, Recorder



18 USC 1341: Frauds and swindles

The obsolete argot of the underworld was deleted as suggested by Hon. Emerich B. Freed, United States district judge, in a paper read before the 1944 Judicial Conference for the sixth circuit in which he said:

A brief reference to §1341, which proposes to reenact the present section covering the use of the mails to defraud. This section is almost a page in length, is involved, and contains a great deal of superfluous language, including such terms as "sawdust swindle, green articles, green coin, green goods and green cigars." This section could be greatly simplified, and now-meaningless language eliminated.

The other surplusage was likewise eliminated and the section simplified without change of meaning.

A reference to causing to be placed any letter, etc. in any post office, or station thereof, etc. was omitted as unnecessary because of definition of "principal" in section 2 of this title.

1949 Act

This section [section 34] corrects a typographical error in section 1341 of title 18, U.S.C.

Amendments

2008- inserted "occurs in relation to, or involving any benefit authorized, transported, transmitted, transferred, disbursed, or paid in connection with, a presidentially declared major disaster or emergency (as those terms are defined in section 102 of the Robert T. Stafford Disaster Relief and Emergency Assistance Act (42 U.S.C. 5122)), or" after "If the violation".

2002- substituted "20 years" for "five years".

1994- §330016(1)(H), substituted "fined under this title" for "fined not more than \$1,000" after "thing, shall be".

§250006, inserted "or deposits or causes to be deposited any matter or thing whatever to be sent or delivered by any private or commercial interstate carrier," after "Postal Service," and "or such carrier" after "causes to be delivered by mail".

1990- substituted "30" for "20" before "years".

1989- inserted at end "If the violation affects a financial institution, such person shall be fined not more than \$1,000,000 or imprisoned not more than 20 years, or both."

1970- substituted "Postal Service" for "Post Office Department".

1380
10/26/2022

2022-011769 MISC Page: 1383 of 2782
09/26/2022 03:35:37 PM Receipt #: 22-9381
Rec Fee: \$30.00 Darrell James Hill
Gila County, Az, Sadie Jo Bingham, Recorder



18 USC 1341: Frauds and swindles

1949-Act May 24, 1949, substituted "of" for "or" after "dispose".

Effective Date of 1970 Amendment

Amendment by effective within 1 year after Aug. 12, 1970, on date established therefor by Board of Governors of United States Postal Service and published by it in Federal Register, see section 15(a) of set out as an Effective Date note preceding section 101 of Title 39, Postal Service.

Short Title of 2002 Amendment

title IX, §901, July 30, 2002, , provided that: "This title [enacting sections 1349 and 1350 of this title, amending this section, section 1343 of this title, and section 1131 of Title 29, Labor, and enacting provisions set out as notes under section 994 of Title 28, Judiciary and Judicial Procedure] may be cited as the 'White-Collar Crime Penalty Enhancement Act of 2002'."

Unofficial

1381
~~102827~~

2022-011769 MISC Page: 1384 of 2782
09/26/2022 03:35:37 PM Receipt #: 22-9381
Rec Fee: \$30.00 Darrell James Hill
Gila County, Az, Sadie Jo Bingham, Recorder





Jay- Roy: Ingold: beneficiary and Executor
c/o 5142 East 18th Avenue
Apache Junction, Arizona ZIP CODE EXEMPT
DMM 602.1.3.e2. Title 18 U.S.C. § 1342
602.499.8807

:man :present:

Arizona state
Pinal county

**SUPERIOR COURT OF ARIZONA
PINAL COUNTY**

PINAL COUNTY,
:Plaintiff;

Case No. CV 201801825

THE HON. BRENDA E OLDHAM

v.

**RESPONDENT'S NOTICE:
UNJUSTIFIED ACTIONS (Cf. ARS
12-349) – Presumption: It is probable
that the PINAL/Pinal county has
committed an Unjustified Actions
Against The Man-Beneficiary: Jay-
Roy: Ingold, et al.**

JAY INGOLD, also know as JAY ROY
INGOLD: subrogation of the man
beneficiary: Jay-Roy: Ingold: sui juris
:Aggrieved Party

:Respondent-

Executor;

Cross-Claimant.

v.

:Himanshu: Director, Community
Development Patel, :Paula: Code
Compliance Manager Mullenix,
:Terrilyn: Code Compliance Officer
Klucar, :James: Code Compliance
Officer Meadows, :Kent: Pinal County

1382
~~1382~~



Attorney Volkmer, :Craig: Deputy
County Attorney Cameron,
:John-Doe, :Jane-Doe,

:Wrong-doers.

:AFFIANT: Man :Principal

**:Jay-Roy: family name: Ingold: Indianan -1962: sui juris: beneficiary and
executor: status adopted by reference. See: A of the Almighty-God-given natural
rights, and the :beneficiary- subrogee and executor of the public trust subrogation
named: JAY ROY INGOLD~ et al. derivatives created by the UNITED STATES
government-trustee, et al., et seq. – also including the PINAL/ Pinal county,
STATE OF ARIZONA/ Arizona state government-trustee. :i am not a U.S.
CITIZEN.**

Constitutional and A.R.S. Restrictions

- 1. :i-man see no verifiable evidence that :i am bound by the Arizona Revised Statutes, and :i believe no evidence to the contrary exists.**
- 2. :i man see no verifiable evidence that the PINAL/Pinal county-government is not bound by the Arizona Revised Statutes, and :i believe no evidence to the contrary exists.**
- 3. :i-man believe there is no verifiable evidence that The PINAL/Pinal county-government is not a trustee with the contractual duties and obligations of its**

1383



originators as the :ARIZONA/Arizona state-government trustee understanding the UNITED STATES government-trustee understanding The Constitution for the United States of America, et seq., and :i believe no evidence to the contrary exists.

4. :i see no verifiable evidence that the presumption that the PINAL/Pinal county-government is not a trustee in place for to protect :i-man from the governmental over-reach, also including from itself or other restrictions, from causing injury to :i-man: Jay-Roy et al., and :i believe no evidence to the contrary exists.

5. :i see no verifiable evidence that the Constitutional restrictions of The Constitution for the United States of America and the Arizona Constitution does not govern all of the activities of the PINAL/Pinal county person(s), and :i believe no evidence to the contrary exists.

Oath Of Office

6. :i see no verifiable evidence that the oaths of office of the any PINAL/Pinal county persons associated with this matters should not be provided upon request to :i ,and :i believe no evidence to the contrary exists for all associated.

Enforcement; county zoning inspector; deputies; building permits; violations; classification; civil penalties; hearing officers and procedures

7. :i see no verifiable evidence that the PINAL/Pinal county proposals in the use of the statute ARS § 11-815 for the justification for the jurisdiction of its'

[Handwritten signature]
1384



actions can not be identified as a fraud as relates to the cleverly stated statute ARS § 11-811 – Zoning ordinance; zoning districts; definitions (D.) This section does not authorize. (1) The imposition of dedication ,exactions, fees or other requirements that are not otherwise authorized by law, – and, :i believe no evidence to the contrary exists.

8. :i see no verifiable evidence that there is a United States or Arizona state constitutional law or an ARIZONA/Arizona state government-trustee law authorizing :PINAL/Pinal county government-trustee to impose 11-815.

Enforcement.... as if it applied to :i-n:an :Jay-Roy: Ingold, et al., and I believe no evidence to the contrary exists.

9. :i see no verifiable evidence that the Arizona state Constitution does not correlate the :United States Constitution, Article I, Section. 10. – No State shall ...; pass any Bill of Attainder, ex post facto Law, or law impairing the Obligation of Contracts, – and, :i believe no evidence to the contrary exists.

10. :i-man see no verifiable evidence that the :PINAL/Pinal county has obeyed the :United States Constitution, Article I, Section. 10. No State shall ...; pass any Bill of Attainder, ex post facto Law, or law impairing the Obligation of Contracts, ...[] precepts in the context to the restrictions upon them and to which they must adhere in the regards to the man: Jay-Roy: Ingold, et al., and I believe no evidence to the contrary exists.

1385
[Handwritten signature]

11. The Arizona Constitution states: 1. Fundamental principle; recurrence: Sections 1. A frequent recurrence to fundamental principles is essential to the security of individual rights and the perpetuity of free government[] must be adhered; and: 2. Political power; purpose of government: Section 2. All political power is inherent in the people, and governments derive their just powers from the consent of the governed, and are established to protect and maintain individual rights. —

12. I see no verifiable evidence that the :PINAL/Pinal county has obeyed the Arizona state Constitution: 1. Fundamental principle; recurrence: Sections 1. A frequent recurrence to fundamental principles is essential to the security of individual rights and the perpetuity of free government[] must be adhered; and: 2. Political power; purpose of government: Section 2. All political power is inherent in the people, and governments derive their just powers from the consent of the governed, and are established to protect and maintain individual rights[] precepts in the context to the restrictions upon them and to which they must adhere in the regards to the man: Jay-Roy: Ingold, et al., and I believe no evidence to the contrary exists.

13. I see no verifiable evidence that for the reason(s) stated above that there can be an ARS statute granting the :PINAL/Pinal county Constitutionally unlawful authority to violate :i-man's, et al., rights to live in peace unmolested from without

2022-011769 MISC Page: 1389 of 2782
09/28/2022 03:35:37 PM Receipt #: 22-9381
Rec Fee: \$30.00 Darrell James Hill
Gila County, Az, Sadie Jo Bingham, Recorder



1388
~~1388~~
~~1388~~

by the PINAL/Pinal county person(s) direct or otherwise interference with the Almighty-God-given right-executed to live freely and undisturbed, and :i believe no evidence to the contrary exists.

14. :i see no verifiable evidence that the 2017 May-June 8th Contract established the :PINAL/Pinal county and Jay-Roy: Ingold simple and constitutional contract operating parameters.- Cf. ARS 47-2206: Offer and acceptance in formation of contract. 1) Unless otherwise unambiguously indicated by the language or circumstances; ... An offer to make a contract shall be construed as inviting acceptance in any manner and by any medium reasonable in the circumstances. – and, :i believe no evidence to the contrary exists. Thereto:

15. :i see no verifiable evidence that all of the negotiations concerning this matter were and now are subject to the 2017 May-June 8th Contract, and :i believe no evidence to the contrary exists.

16. :i-man see no verifiable evidence that the “no law impairing the Obligation of Contracts” Constitutional obligation of the PINAL/Pinal county to the 2017 May-June 8th Contract with :i-man excluded the :PINAL/Pinal county, and :i believe no evidence to the contrary exists.

17. :i see no verifiable evidence when wrong- doing(s) by the PINAL/Pinal county, et al. against the man-beneficiary Jay-Roy, et al. by the bad-use of the ARS statutes in a fraud designed for the taking away of the man-beneficiary's right(s)-

2022-011769 MISC Page: 1390 of 2782
09/26/2022 03:35:37 PM Receipt #: 22-9381
Rec Fee: \$30.00 Darrell James Hill
Gila County, Az, Sadie Jo Bingham, Recorder

1387
~~1387~~

executed, that such behavior is not a crime, and :i believe no evidence to the contrary exists.

18. :i see no verifiable evidence that the PINAL/Pinal county under the 2017 May-June 8th Contract with the man: Jay-Roy: Ingold did not use the man-beneficiary's subrogation: JAY INGOLD in some commercial context and in order to avoid the proper court-of-record with trial-by-jury to decide the law and the facts, and :i believe no evidence to the contrary exists.

19. :i see no verifiable evidence that application of the PINAL/Pinal county trustee's presumptions to impose a process of abuse to the man-beneficiary under the color of law is not a process of fraud, and :i believe no evidence to the contrary exists.

20. :i see no verifiable evidence that the use of the any PINAL/Pinal county person(s) to force a man-beneficiary to pay any bill developed subsequent to a fraud does not harm the man-beneficiary, – Cf. ARS 47-3305. Defenses and Claims in Recoupment. (A.)(1)(b) Duress, lack of legal capacity or illegality of the transaction which, under other law, nullifies the obligation of the obligor;.[and] (c) Fraud that induced the obligor to sign the instrument with neither knowledge nor reasonable opportunity to learn of its character of its essential terms[.] – and, :i believe no evidence to the contrary exists.

21. :i-man see no verifiable evidence to conclude that the :PINAL/Pinal county

2022-011769 MISC Page: 1391 of 2782
09/26/2022 03:35:37 PM Receipt #: 22-9381
Rec Fee: \$30.00 Darrell James Hill
Gila County, Az, Sadie Jo Bingham, Recorder



1388

did not commit fraud against the man-beneficiary: Jay-Roy: Ingold, et al., and i believe no evidence to the contrary exists.

22. i-man see no verifiable evidence to conclude that the :PINAL/Pinal county trustee did not commit itself to an unjustified action against the man-beneficiary :Jay-Roy, et al. – Cf. PINAL/Pinal county restriction of the ARS 12-349.

Unjustified actions; attorney fees, expenses and double damages; exceptions; definition. (A.) (F)., and i believe no evidence to the contrary exists.

ARS 12-349. Unjustified actions; attorney fees, expenses and double damages; exceptions; definition. (A.) (F.)

A. Except as otherwise provided by and not inconsistent with another statute, in any civil action commenced or appealed in a court of record in this state, the court shall assess reasonable attorney fees, expenses and, at the court's discretion, double damages of not to exceed five thousand dollars against an attorney or party, including this state and political subdivisions of this state, if the attorney or party does any of the following:

1. Brings or defends a claim without substantial justification.
2. Brings or defends a claim solely or primarily for delay or harassment.
3. Unreasonably expands or delays the proceeding.
4. Engages in abuse of discovery.

F. For the purposes of this section, "without substantial justification" means that the claim or defense is groundless and is not made in good faith.

- Thereto:

23. i-man see no verifiable evidence to conclude that the :PINAL/Pinal county

2022-011769 MISC Page: 1392 of 2782
09/25/2022 09:35:37 PM Receipt #: 22-9381
Rec Fee: \$30.00 Darrell James Hill
Gila County, Az, Sadie Jo Bingham, Recorder

1389

attorney in concert with the PINAL/Pinal agency did not submit a complaint described in the restrictions in the ARS 12-349. Unjustified action (A)(1)(2), and i believe no evidence to the contrary exists.

24. i see no verifiable evidence that based upon the forgoing the presumption most probable is that the PINAL/Pinal county has committed an Unjustified Action Against The Man-Beneficiary: Jay-Roy: Ingold, et al.

Sincerely,

Without Prejudice
JAY ROY INGOLD subrogation

Jay-Roy: Ingold executor
Jay-Roy: Ingold, beneficiary- respondent-
Executor

Affirmed and autographed before me this 25 day: December: 2018 A.D.;

Type- Identification: Arizona Driver License

Seal

notary

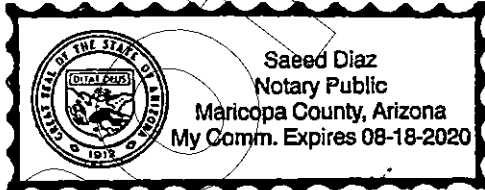

2022-011769 MISC Page: 1393 of 2782
09/26/2022 03:35:37 PM Receipt #: 22-9381
Rec Fee: \$30.00 Darrell James Hill
Gila County, Az. Sadie Jo Bingham, Recorder

1390

SENDER: COMPLETE THIS SECTION

- Complete items 1, 2, and 3.
- Print your name and address on the reverse so that we can return the card to you.
- Attach this card to the back of the mailpiece, or on the front if space permits.

1. Article Addressed to:

Amanda: Superior Court Clerk Stanford
 Pinal County Superior Court
 PO Box 2730
 Florence, AZ 85132



9590 9402 3852 8032 5323 40

2. Article Number (Transfer from...)

RE 322 404 036 US

COMPLETE THIS SECTION ON DELIVERY

A. Signature Agent
 Addressee

B. Received by (Printed Name)

T. Wentz

C. Date of Delivery

11/29/19

D. Is delivery address different from item 1? Yes
 if YES, enter delivery address below: No

- 3. Service Type**
- Adult Signature
 - Adult Signature Restricted Delivery
 - Certified Mail®
 - Certified Mail Restricted Delivery
 - Collect on Delivery
 - Collect on Delivery Restricted Delivery
 - Insured Mail
 - Insured Mail Restricted Delivery (over \$500)
 - Priority Mail Express®
 - Registered Mail™
 - Registered Mail Restricted Delivery
 - Return Receipt for Merchandise
 - Signature Confirmation™
 - Signature Confirmation Restricted Delivery

PS Form 3811, July 2015 PSN 7530-02-000-9053

Domestic Return Receipt

USPS TRACKING#



9590 9402 3852 8032 5323 40



First-Class Mail
 Postage & Fees Paid
 USPS
 Permit No. G-10

United States Postal Service

* Sender: Please print your name, address, and ZIP+4® in this box*

Jay-Roy Ingold
 c/o 5124 East 18th Avenue
 Apache Junction, Arizona

2022-011769 MISC Page: 1394 of 2782
 09/26/2022 03:35:37 PM Receipt #: 22-9381
 Rec Fee: \$30.00 Darrell James Hill
 Gila County, Az, Sadie Jo Bingham, Recorder

1391

PROY

Unofit

:Darrell-James: Hill, :executor, :civilian
c/o PO Box 3806
Apache Junction, Arizona 85117

SECTION B

B) :Claim Of Wrong-Doing Surrounding This Matter Is Thrice Registered
With The Pinal County Sheriff. See: Section B appended: **facts of**
:evidence, b) CMN 7018 0360 0000 5968
8843 - :7 pages

2022-011769 MISC Page: 1395 of 2782
09/26/2022 03:35:37 PM Receipt #: 22-9381
Rec Fee: \$30.00 Darrell James Hill
Pinal County, Az, Sadie Jo Bingham, Recorder

1392
~~1392~~
Darrell-James -2019 Oct. 28th :Manifest of :Bill of: Trespassing contract
:PINAL COUNTY/Pinal county RMN RE 322 404 169 US

**:Jay-Roy: Ingold :beneficiary :Respondent Executor
c/o 5142 East 18th Avenue
Apache Junction, Arizona ZIP CODE EXEMPT
DMM 602.1.3.e2. Title 18 U.S.C. § 1342**

:man :present:

**Arizona state
Pinal county**

**SUPERIOR COURT OF ARIZONA
PINAL COUNTY**

**PINAL COUNTY,
:Plaintiff;**

**Case No. CV 201801825
THE HON. BRENDA E OLDHAM**

v. :RESPONDENT NOTICE:

**JAY INGOLD, also know as JAY ROY
INGOLD: subrogation of the man
beneficiary: Jay-Roy: Ingold: sui juris
:Aggrieved Party**

**CORRECTION TO THE: "2017
May-June 8th CONTRACT
OBLIGATIONS UPON THE
PINAL/Pinal county AS OF JUNE
8th: 08:30.01 A.M."**

**:Respondent- Executor;
Cross-Claimant.**

**-
SEE ATTACHED: 2017 May-June 8th
Contract: 3 pages.**

**v.
:Himanshu: Director, Community
Development Patel, :Paula: Code
Compliance Manager Mullenix,
:Terrilyn: Code Compliance Officer
Klucar, :James: Code Compliance
Officer Meadows, :Kent: Pinal County
Attorney Volkmer, :Craig: Deputy
County Attorney Cameron,**

2022-011769 MISC Page: 1396 of 2782
09/26/2022 03:35:37 PM Receipt #: 22-9381
Rec Fee: \$30.00 Darrell James Hill
Gila County, AZ, Sadie Jo Bingham, Recorder

1393
[Handwritten signature]

:John-Doe, :Jane-Doe,

:Wrong-doers.

:AFFIANT: Man :Beneficiary: Respondent-Executor

1. :i-man am a living man – the blood flows and the flesh lives – given name :Jay-Roy: family name: Ingold: Indianan -1962: of sound mind, :beneficiary and executor of the Almighty-God-given natural rights, and the :beneficiary- subrogee and executor of the public trust subrogation named: JAY ROY INGOLD~ et al. derivatives created by the UNITED STATES government-trustee, et al., et seq. – also including the PINAL/ Pinal county-government-trustee, STATE OF ARIZONA/ Arizona state-government-trustee.

1. SEE ATTACHED: 2017 May-June 8th Contract: 3 pages.

Without Prejudice
JAY ROY INGOLD, subrogation

Jay-Roy: Ingold, Respondent-Executor
Jay-Roy: Ingold, beneficiary-Respondent-Executor

Verified and autographed before me this 29 day: January: 2019.
:Type of the Identification: Arizona Driver License



[Signature]
Notary public

2022-011769 MISC Page: 1397 of 2782
09/26/2022 03:35:37 PM Receipt #: 22-9381
Reg Fee: \$30.00 Darrell James Hill
Gila County, Az, Sadie Jo Bingham, Recorder

[Handwritten signature]

:CERTIFICATE OF THE SERVICE

:It is hereby verified that on the 29 day: January: 2019, :i-man sent or had sent by the first class mail the **:RESPONDENT NOTICE: CORRECTION TO THE: "2017 May-June 8th CONTRACT OBLIGATIONS UPON THE PINAL/Pinal county AS OF JUNE 8th: 08:30.01 A.M." --SEE ATTACHED: 2017 May-June 8th Contract: 3 pages.** with this :CERTIFICATE OF THE SERVICE to the recipients at the addresses as noted below.

:Hon. Brenda Oldham
Pinal County Superior Court
PO Box 2730
Florence, AZ 85132

:Stephen-F.: Superior Court President Judge McCarville
Pinal County Superior Court
P.O. Box 828
Florence, Arizona 85132

:Amanda: Superior Court Clerk Stanford
Pinal County Superior Court
PO Box 2730
Florence, AZ 85132

:Craig: Pinal County Attorney Cameron
Arizona State Bar Number: -013176
P.O. Box 887
Florence, Arizona 85132
520 866-6466

Without Prejudice
JAY ROY INGOLD :subrogation

Jay-Roy Ingold, executor
Jay-Roy: Ingold, beneficiary respondent-
Executor

7018 0360 0000 5968 8843

:Affidavit : Contract Correction USPS CMN 7018 0360 0000 5968 8843 3 / 3

2022-011769 MISC Page: 1398 of 2782
09/26/2022 03:35:37 PM Receipt #: 22-9381
Rec Fee: \$30.00 Darrell James Hill
Gila County, Az, Sadie Jo Bingham, Recorder

1395

Jay- Roy: Ingold
 c/o 5142 East 18th Avenue
 Apache Junction, Arizona ZIP CODE EXEMPT
 DMM 602.1.3.e2. Title 18 U.S.C. § 1342

Himanshu, acting as Director, Community Development
 Paula, acting as Code Compliance Manager
 c/o Terrilyn, acting as Code Compliance Officer RE 322 399 225 US
 575 North Idaho Street, Suite 800
 Apache Junction, Arizona 85119

Re: 5124 East 18th Avenue, Apache Junction, Arizona

NOTICE	a)	EX POST FACTO LAW VIOLATION;
	b)	CRIMINAL COMPLAINT;
	c)	FEE SCHEDULE
DEMAND	i)	DISCHARGE COMPLAINT - CANCEL HEARING, and
	ii)	CEASE AND DESIST; or,
	iii)	COMMON LAW PROCEEDING

Himanshu, Paula, Terrilyn, Greetings:

i: man am writing: because i have received various requests for changes i voluntarily made upon my property in good faith. i made significant changes and sent you photos, etc. improving the general appearance of my property. However, you have violated your Oath of Office and duty to persist to impose upon me further DEMAND LETTER(s) and a COMPLAINT seeking further to impose Code Violations for my parcel "103-14-012B" that you knew or should have known was ACQUIRED in 2008!

Address Above: It is a felony for you to send mail to an address that is not a proper mailing address, or a fictitious mailing address. My proper mailing address is as indicated above; if you intend to send mail to another address then you intend to be guilty of mail fraud.

NOTICE:

Your actions are repugnant to the Constitution for the United States of America people, and the subsequent subordinate laws. You have mistakenly presumed that your code violations AND counts somehow applied to me; so, let me be clear:

a)	your application of code violations AND counts do Not apply to me;
b)	you have threatened to impose fines and/or create other hardship that Never before existed! if i do not comply with your demands;
c)	you have progressed to: a) threat of abuse, b) under the color of law; and,
d)	Your "CODE ENFORCEMENT OFFICER VERIFICATION", on the April 5,



2017, COMPLAINT, is perjury if a) you knew or should have known that b) my parcel at 5124 E. 18th Ave. has been in my ownership since 2008; that: c) the codes were contrived years later, even 2010; d) no man has made a claim; and, e) your verification is repugnant to the United States and Arizona constitutions Ex post facto law prohibitions.

Moreover, your use of code to DECEIVE ME evidences a perverse application with willful criminal intent.

DEMAND

- **Withdraw the Complaint and Cancel the Hearing post haste;**
- **CEASE and DESIST; No Further Trespass about my property.**
- **FEE SCHEDULE: If you choose Not to withdraw your complaint post haste, then from the time of your receipt of this NOTICE and DEMAND; I) you have 5 days to complete Items 1) & 2); thereafter, II) any further intrusion from you, et al., any actions to date, you a) agree to pay to me post haste upon request(s) one silver dollar per minute period of time from April 5, 2017, 5:00 pm., until this matter is resolved; and, b) you agree to pay post haste upon request any and all legal service charges incurred in resolve of- and collection from you- any amounts accrued.**
- **COMMON LAW PROCEEDING: If you choose to Not withdraw your complaint post haste, then i Demand a June 8, 2017, Court of Record to proceed in Common Law with trial by jury to hear and decide a) the controversy of your actions against me, and b) the Item 3) Fee Schedule, matter in controversy greater than twenty dollars at this writing.**
- **My Next Friend, the man steward-at-my-property, will accompany and assist me as i deem may be necessary.**

Jay-Roy: Ingold

Jay-Roy: Ingold

May 7, 2017

Because of these hassles I am putting my house up for sale.

witness and acknowledge that all statements herein are true.

Lisa: Ingold
May 7, 2017

2022-011769 MISC Page: 1400 of 2782
09/26/2022 03:35:37 PM Receipt #: 22-9981
Rec Fee: \$30.00 Darrell James Hill
Gila County, Az, Sadie Jo Bingham, Recorder



1397
[Signature]

Registered No. RE 322399225US

Date Stamp

0130
07

To Be Completed By Post Office	Reg. Fee	\$0.49	
	Handling Charge	\$11.70	Return Receipt
	Postage	\$2.75	Restricted Delivery
		\$0.00	
	Received by	\$0.00	\$14.94

Customer Must Declare Domestic Insurance up to \$25,000 is included. Excess requires separate declaration. International liability is limited. (See Reverse).

APACHE JUNCTION, AZ 85120
OFFICIAL USE

To Be Completed By Customer (Please Print) All Entries Must Be in Subscript or Typed	FROM	Jay-Roy Ingold, approved man c/o 5142 East 18 th Avenue Apache Junction, Arizona ZIP CODE EXEMPT without the US tax.
	TO	Wassenaar, acting as Director, Coconino County, acting as Code Compliance Officer 575 North Mike Street, Suite 800 Apache Junction, Arizona 85119

PS Form 3806, Receipt for Registered Mail Copy 1 - Customer
May 2007 (7530-02-000-9051) (See Information on Reverse)
For domestic delivery information, visit our website at www.usps.com

SENDER. COMPLETE THIS SECTION		COMPLETE THIS SECTION ON DELIVERY																	
<ul style="list-style-type: none"> Complete items 1, 2, and 3. Print your name and address on the reverse so that we can return the card to you. Attach this card to the back of the mailpiece, or on the front if space permits. 		<p>A. Signature <input type="checkbox"/> Agent <input type="checkbox"/> Addressee</p> <p>B. Received by (Printed Name) C. Date of Delivery</p>																	
<p>1. Article Addressed to:</p> <p>Wassenaar, acting as Director, Coconino County, acting as Code Compliance Officer 575 North Mike Street, Suite 800 Apache Junction, Arizona 85119</p>		<p>D. Is delivery address different from item 1? <input type="checkbox"/> Yes <input type="checkbox"/> No If YES, enter delivery address below: <input type="checkbox"/> No</p>																	
<p>2. Article Number (Transfer from service label) RE 322399225US</p>		<p>3. Service Type</p> <table border="0"> <tr> <td><input type="checkbox"/> Adult Signature</td> <td><input type="checkbox"/> Priority Mail Express®</td> </tr> <tr> <td><input type="checkbox"/> Adult Signature Restricted Delivery</td> <td><input type="checkbox"/> Registered Mail™</td> </tr> <tr> <td><input type="checkbox"/> Certified Mail®</td> <td><input type="checkbox"/> Registered Mail Restricted Delivery</td> </tr> <tr> <td><input type="checkbox"/> Certified Mail Restricted Delivery</td> <td><input type="checkbox"/> Return Receipt for Merchandise</td> </tr> <tr> <td><input type="checkbox"/> Collect on Delivery</td> <td><input type="checkbox"/> Signature Confirmation™</td> </tr> <tr> <td><input type="checkbox"/> Collect on Delivery Restricted Delivery</td> <td><input type="checkbox"/> Signature Confirmation Restricted Delivery</td> </tr> <tr> <td><input type="checkbox"/> Insured Mail</td> <td></td> </tr> <tr> <td><input type="checkbox"/> Insured Mail Restricted Delivery (over \$500)</td> <td></td> </tr> </table>		<input type="checkbox"/> Adult Signature	<input type="checkbox"/> Priority Mail Express®	<input type="checkbox"/> Adult Signature Restricted Delivery	<input type="checkbox"/> Registered Mail™	<input type="checkbox"/> Certified Mail®	<input type="checkbox"/> Registered Mail Restricted Delivery	<input type="checkbox"/> Certified Mail Restricted Delivery	<input type="checkbox"/> Return Receipt for Merchandise	<input type="checkbox"/> Collect on Delivery	<input type="checkbox"/> Signature Confirmation™	<input type="checkbox"/> Collect on Delivery Restricted Delivery	<input type="checkbox"/> Signature Confirmation Restricted Delivery	<input type="checkbox"/> Insured Mail		<input type="checkbox"/> Insured Mail Restricted Delivery (over \$500)	
<input type="checkbox"/> Adult Signature	<input type="checkbox"/> Priority Mail Express®																		
<input type="checkbox"/> Adult Signature Restricted Delivery	<input type="checkbox"/> Registered Mail™																		
<input type="checkbox"/> Certified Mail®	<input type="checkbox"/> Registered Mail Restricted Delivery																		
<input type="checkbox"/> Certified Mail Restricted Delivery	<input type="checkbox"/> Return Receipt for Merchandise																		
<input type="checkbox"/> Collect on Delivery	<input type="checkbox"/> Signature Confirmation™																		
<input type="checkbox"/> Collect on Delivery Restricted Delivery	<input type="checkbox"/> Signature Confirmation Restricted Delivery																		
<input type="checkbox"/> Insured Mail																			
<input type="checkbox"/> Insured Mail Restricted Delivery (over \$500)																			
PS Form 3811, July 2015 PSN 7530-02-000-9053		Domestic Return Receipt																	

13918
[Handwritten signature]

2022-011769 MISC Page: 1401 of 2782
09/26/2022 03:35:37 PM Receipt #: 22-9381
Rec Fee: \$30.00 Darrell James Hill
Gila County, Az, Sadie Jo Bingham, Recorder



U.S. Postal Service™
CERTIFIED MAIL® RECEIPT
 Domestic Mail Only

For delivery information, visit our website at www.usps.com

OFFICIAL USE

FLORISSA 0130 14

Postmark Here

7016 0360 0000 5968 8843

Certified Mail Fee	\$3.50
Extra Services & Fees (check box, add fee as appropriate)	\$0.00
<input type="checkbox"/> Return Receipt (hardcopy)	\$0.00
<input type="checkbox"/> Return Receipt (electronic)	\$0.00
<input type="checkbox"/> Certified Mail Restricted Delivery	\$0.00
<input type="checkbox"/> Adult Signature Required	\$0.00
<input type="checkbox"/> Adult Signature Restricted Delivery	\$0.00
Postage	\$0.70
Total Postage and Fees	\$4.20

Sent To: Amanda: Superior Court Clerk, Stamford
 Final County Superior Court
 PO Box 2730
 Florence, AZ 85132

PS Form 3800, April 2015 PSN 7530-02-000-90-7 See Reverse for Instructions

APACHE JUNCTION
 151 W SUPERSTITION BLVD
 APACHE JUNCTION, AZ
 85120-9998
 0302590130
 01/30/2019 (800)275-8777 9:59 AM

Product Description	Sale Qty	Final Price
First-Class Mail Letter (Domestic) (FLORENCE, AZ 85132) (Weight: 0 Lb 1.20 Oz) (Estimated Delivery Date) (Friday 02/01/2019)	1	\$0.70
Certified (USPS Certified Mail #) (70180360000059688843)	1	\$3.50
First-Class Mail Letter (Domestic) (FLORENCE, AZ 85132) (Weight: 0 Lb 2.10 Oz) (Estimated Delivery Date) (Friday 02/01/2019)	1	\$0.85
Certified (USPS Certified Mail #) (70180360000059688850)	1	\$3.50
Return Receipt (USPS Return Receipt #) (9590940238528032532333)	1	\$2.80

Total \$11.35

Credit Card Remitd \$11.35
 (Card Name: VISA)
 (Account #: XXXXXXXXXXXX8210)
 (Approval #: 002856)
 (Transaction #: 479)
 (AID: A0000000980840 Chip)
 (AL: US DEBIT)
 (PIN: Not Required)

Text your tracking number to 28777

1399



:Darrell-James: Hill, :executor, :civilian
c/o PO Box 3806
Apache Junction, Arizona 85117

SECTION B

B) :Claim Of Wrong-Doing Surrounding This Matter Is Thrice Registered
With The Pinal County Sheriff. See: Section B appended: **facts of**
:evidence, c) CMN 7018 0360 0000 5969
3007 - :6 pages

1400
~~22-9381~~

Darrell-James -2019 Oct. 28th :Manifest of :Bill of: Trespassing contract
:PINAL COUNTY/Pinal c

2022-011769 MISC Page: 1403 of 2782
09/26/2022 03:35:37 PM Receipt #: 22-9381
Rec Fee: \$30.00 Darrell James Hill
Gila County, Az, Sadie Jo Bingham, Recorder



Jay- Roy: Ingold: beneficiary and Executor
c/o 5142 East 18th Avenue
Apache Junction, Arizona ZIP CODE EXEMPT
DMM 602.1.3.e2. Title 18 U.S.C. § 1342
602.499.8807

:man :present:

Arizona state
Pinal county

**SUPERIOR COURT OF ARIZONA
PINAL COUNTY**

PINAL COUNTY,
:Plaintiff;

Case No. CV 201801825
THE HON. BRENDA E OLDHAM

v.

RESPONDENT'S NOTICE:

JAY INGOLD, also know as JAY ROY
INGOLD: subrogation of the man
beneficiary: Jay-Roy: Ingold: sui juris
:Aggrieved Party
:Respondent-
Executor;

**CORRECTION: SENDING OF -
"CERTIFICATE OF SERVICE"
FOR THE ANSWER... and CROSS-
CLAIM OF :JANUARY 2019; To:
Amanda: COC/ Pinal county :
USPS RMN RE 322 404 036 US**

Cross-Claimant.

v.

:Himanshu: Director, Community
Development Patel, :Paula: Code
Compliance Manager Mullenix,
:Terrilyn: Code Compliance Officer
Klucar, :James: Code Compliance
Officer Meadows, :Kent: Pinal County

COS for JAN. 2019 ANSWER; CCLAIM USPS CMN 7018 0360 0000 5969 3007

1 / 5

2022-011769 MISC Page: 1404 of 2782
09/26/2022 03:35:37 PM Receipt #: 22-9381
Rec Fee: \$30.00 Darrell James Hill
Gila County, Az, Sadie Jo Bingham, Recorder



Attorney Volkmer, :Craig: Deputy
County Attorney Cameron,
:John-Doe, :Jane-Doe,

:Wrong-doers.

:AFFIANT: Man :Principal

:Jay-Roy: family name: Ingold: Indianan -1962: sui juris: beneficiary and executor:
status adopted by reference. See: AFFIANT: Man :Principal – RESPONDENT'S
ANSWER.

CORRECTION IN THIS SENDING –

:CERTIFICATE OF THE SERVICE

:It is hereby verified with this CERTIFICATE OF SERVICE on the 29th: January:
2019, that :i-man sent or had sent on the 25th: January 2019 by the first class mail
to: Amanda: COC/ Pinal co., USPS RMN RE 322 404 036 US for the Case No.
CV 201801825 : HON. BRENDA E OLDHAM, this CERTIFICATE OF
SERVICE

1) **:RESPONDENT ANSWER AND RESPONSE – :DEMAND: COMMON
LAW EQUITY COURT OF RECORD WITH TRIAL BY JURY TO DECIDE
ALL MATTERS OF LAW AND EQUITY w/**

**:CROSS-CLAIM: PINAL/Pinal county, et al., VIOLATION OF THE TRUSTEE
DUTY: INTERFERENCE WITH THE RIGHTS OF THE BENEFICIARY –
DEMAND: COMMON LAW COURT OF RECORD WITH TRIAL BY JURY
TO DECIDE ALL MATTERS OF LAW AND EQUITY DEMANDED; and,**

2) **NECESSARY SUBMISSIONS:**

a **:RESPONDENT NOTICE:**

REQUIRED JOINDER OF THE Man- Beverly-Jean: Romero- Hill.

b **:RESPONDENT NOTICE:**

REQUIRED JOINDER OF THE Man- Darrell-James: Hill.

1402
1402
COS for JAN. 2019 ANSWER; CCLAIM USPS CMN 7018 0360 0000 5969 3007

2 / 5

2022-011769 MISC Page: 1405 of 2782
09/26/2022 03:35:37 PM Receipt #: 22-9381
Rec Fee: \$30.00 Darrell James Hill
Gila County, Az, Sadie Jo Bingham, Recorder



- c :RESPONDENT NOTICE:
REQUIRED JOINDER OF THE Man- Tracy-Robert: Calhoun.
- d :RESPONDENT NOTICE:
REQUIRED JOINDER OF THE Man- Lisa: Loeffler- Ingold.
- e :RESPONDENT NOTICE: -
AUTHORIZATION FOR MAN- JAY-ROY TO SIGN FOR MEMBERS OF
THE COMMUNITY ON THE "Correction Of The Account Of The
Complainants' Affidavit: Community Report - Need For Common Law
Court Of Record With The Trial By Jury To Decide Upon The Facts And
The Law."
- f :RESPONDENT NOTICE: -
CORRECTION OF THE ACCOUNT OF THE COMPLAINANTS'
AFFIDAVIT: - Community Report - Need For Common Law Court Of
Record With The Trial By Jury To Decide Upon The Facts And The Law.
- g :AFFIDAVIT: CONTACT WITH :James: CODE COMPLIANCE OFFICER
MEADOWS - :AFFIANT: man :Tracy-Robert: Calhoun: ACQUAINTED
WITH THE FACTS, FOR, AND, ON BEHALF OF :Jay-Roy: Ingold.
- h :AFFIDAVIT: CONTACT WITH :James: CODE COMPLIANCE OFFICER
MEADOWS - :AFFIANT: man :Darrell-James: Hill: ACQUAINTED
WITH THE FACTS, FOR, AND, ON BEHALF OF :Jay-Roy: Ingold.
- i :AFFIDAVIT: CONTACT WITH :James: CODE COMPLIANCE OFFICER
MEADOWS - AFFIANT: man :Beverly-Jean: Romero- Hill:
ACQUAINTED WITH THE FACTS, FOR, AND, ON BEHALF OF :Jay-
Roy: Ingold.
- j :RESPONDENT NOTICE:
REQUIRED JOINDER OF THE Man- James-William: Woods.
- k RESPONDENT NOTICE:
NEXT BEST FRIEND :Man- Darrell-James: Hill WILL BE ASSISTING
me AND my CAUSE AT ALL MEETINGS AT MY PLEASURE.
- l :RESPONDENT NOTICE:
2017 May-June 8th CONTRACT
OBLIGATIONS UPON THE PINAL/Pinal county AS OF JUNE 8th:
08:30.01 A.M.
- m PRAECIPE FOR THE OATH OF OFFICE OF THE FOLLOWING

'COS for JAN. 2019 ANSWER; CCLAIM USPS CMN 7019 0360 0000 5060 3007 2/5

2022-011769 MISC Page: 1406 of 2782
09/26/2022 03:35:37 PM Receipt #: 22-9381
Rec Fee: \$30.00 Darrell James Hill
Gila County, Az, Sadie Jo Bingham, Recorder



1403
10/20/21

KNOWN AND UNKNOWN PERSONS ASSOCIATED WITH THE
COMPLAINANTS' ACTION? namely: Himanshu: Director, Community
Development Patel; :Paula: Code Compliance Manager Mullenix; :Terrilyn:
Code Compliance Officer Klucar; :James: Code Compliance Officer
Meadows; :Kent: Pinal County Attorney Volkmer;

- n :RESPONDENT NOTICE: –
SETTING OF THE PRESUMPTIONS
- o RESPONDENT NOTICE:
:PINAL/PINAL COUNTY-GOVERNMENT IS A TRUSTEE FOR THE
Man-BENEFICIARY- EXECUTOR: Jay-Roy: Ingold.
- p RESPONDENT NOTICE: \n
:i-man Do Not Owe A Filing Fee – Access To This Court By This Man Jay-
Roy: Ingold Is By :Right-executed Not Subject To The Statutes-Used For
Privileged Persons Under License With The STATE OF ARIZONA. –
Failure To Protect This Man In His Exercise Of His Right As An
Indianan :American Is A Dereliction Of The Trustee Duty. – Presumption:
Probable Interference Of The Rights-Executed By Concerted Violation of
the man-beneficiary: Jay-Roy: Ingold, et al.
- q RESPONDENT'S NOTICE:
:Jay-Roy's LAND-HOME:
"ZIP CODE EXEMPT: DMM 602.1.3.e2.: Addressing; :TITLE 18 U.S.C. §
1341:" Fraud And Swindles. – Title 18 U.S.C. § 1342; Fictitious Name Or
Address.
- r RESPONDENT NOTICE:
UNJUSTIFIED ACTIONS (Cf. ARS 12-349) – Presumption: It is probable
that the PINAL/Pinal county has committed an Unjustified Actions Against
The Man-Beneficiary: Jay-Roy: Ingold, et al.

with this :CERTIFICATE OF THE SERVICE to the recipients at the addresses as
noted below.

:Hon. Brenda Oldham
Pinal County Superior Court
PO Box 2730
Florence, AZ 85132

'COS for JAN. 2019 ANSWER; CCLAIM USPS CMN 7018 0360 0000 5969 3007

4 / 5

2022-011769 MISC Page: 1407 of 2782
09/26/2022 03:35:37 PM Receipt #: 22-9381
Rec Fee: \$30.00 Darrell James Hill
Gila County, Az, Sadie Jo Bingham, Recorder



Handwritten signature and initials, possibly "MOY" and "BKH".

**:Stephen F.: Superior Court President Judge McCarville
Pinal County Superior Court
P.O. Box 828
Florence, Arizona 85132**

**:Amanda: Superior Court Clerk Stanford
Pinal County Superior Court
PO Box 2730
Florence, AZ 85132**

**:Craig: Pinal County Attorney Cameron
Arizona State Bar Number: -013176
P.O. Box 887
Florence, Arizona 85132
520 866-6466**

**Without Prejudice
for: JAY ROY INGOLD :subrogation:**

**Jay-Roy: Ingold : executor
Jay-Roy: Ingold, beneficiary- respondent-
Executor**

7018 0360 0000 5969 3007

COS for JAN. 2019 ANSWER; CCLAIM USPS CMN 7018 0360 0000 5969 3007 5/5

**2022-011769 MISC Page: 1408 of 2782
09/26/2022 03:35:37 PM Receipt #: 22-9381
Rec Fee: \$30.00 Darrell James Hill
Gila County, Az, Sadie Jo Bingham, Recorder**



1405
@patt

Unofficial Copy

APACHE JUNCTION
 151 W SUPERSTITION BLVD
 APACHE JUNCTION
 AZ
 85120-9998
 0302590130
 01/29/2019 (800)275-8777 9:36 AM

Product Description	Sale Qty	Final Price
First-Class Mail Letter	1	\$0.55

(Domestic)
 (FLORENCE, AZ 85132)
 (Weight: 0 Lb 1.00 Oz)
 (Estimated Delivery Date)
 (Thursday 01/31/2019)

Certified	1	\$3.50
Father Hesburgh	3	\$1.65

(Unit Price: \$0.55)

Total \$5.70

Credit Card Remitd \$5.70
 (Card Name: VISA)
 (Account #: XXXXXXXXXXXX2301)
 (Approval #: 006792)
 (Transaction #: 480)
 (AID: A0000000031010 Chip)
 (AL: Visa Credit)
 (PIN: Not Required)

Text your tracking number to 28777 (2USPS) to get the latest status. Standard Message and Data rates may apply. You may also visit www.usps.com USPS Tracking or call 1-800-222-1811.

U.S. Postal Service
CERTIFIED MAIL® RECEIPT
 Domestic Mail Only

For delivery information, visit our website at www.usps.com

OFFICIAL USE

Certified Mail Fee	\$3.50
Extra Services & Fees (check box, add fee as appropriate)	\$0.00
<input type="checkbox"/> Return Receipt (hardcopy)	\$0.00
<input type="checkbox"/> Return Receipt (electronic)	\$0.00
<input type="checkbox"/> Certified Mail Restricted Delivery	\$8.88
<input type="checkbox"/> Adult Signature Required	\$0.00
<input type="checkbox"/> Adult Signature Restricted Delivery	\$0.00

Postage	\$0.55
Total Postage and Fees	\$4.05

0130
19

Postmark
Here

01/29/2019

Sent To	Amanda: Superior Court Clerk Stanford
Street and Apt. No.	Pinal County Superior Court
	PO Box 2730
City, State, ZIP+4	Florence, AZ 85132

PS Form 3800, April 2015 PSN 7532-01-000-9047 See Reverse for Instructions

2022-011769 MISC Page: 1409 of 2782

09/26/2022 03:35:37 PM Receipt #: 22-9381
 Rec Fee: \$30.00 Darrell James Hill
 Gila County, Az, Sadie Jo Bingham, Recorder



1406
 [Handwritten signatures and initials]

:Darrell-James: Hill, :executor, :civilian
c/o PO Box 3806
Apache Junction, Arizona 85117

SECTION B

B) :Claim Of Wrong-Doing Surrounding This Matter Is Thrice Registered
With The Pinal County Sheriff. See: Section B appended: **facts of**
:evidence, d) CMN 7018 0360 0000 5968
8850 - :6 pages

1407
10/28/2019
Darrell-James -2019 Oct. 28th :Manifest of :Bill of: Trespassing contract
:PINAL COUNTY/Pinal co

2022-011769 MISC Page: 1410 of 2782
09/26/2022 03:35:37 PM Receipt #: 22-9381
Rec Fee: \$30.00 Darrell James Hill
Gila County, Az, Sadie Jo Bingham, Recorder



Jay-Roy: Ingold: Respondent-Executor
5124 East 18th Avenue
Apache Junction, Arizona

:Craig: Pinal County Attorney Cameron
Arizona State Bar Number: -013176
P.O. Box 887
Florence, Arizona 85132

USPS CMN 7018 0360 0000 5968 8850

RE: CV 201801825: Pinal v Ingold

Please find enclosed:

- 1) Respondent Notice: Correction with the 2017 May-June 8th Contract Affidavit, and cross-claim
- 2) Repondent Notice: To the PINAL/Pinal county- : Craig: DEPUTY...

Without Prejudice
JAY ROY INGOLD, subrogation

~~Jay-Roy: Ingold, Executor~~
Jay-Roy: Ingold, Beneficiary, Respondent-
Executor

7018 0360 0000 5968 8850

1409

2022-011769 MISC Page: 1411 of 2782
09/26/2022 03:35:37 PM Receipt #: 22-9381
Rec Fee: \$30.00 Darrell James Hill
Gila County, Az, Sadie Jo Bingham, Recorder



Jay- Roy: Ingold: beneficiary and Executor
c/o 5142 East 18th Avenue
Apache Junction, Arizona ZIP CODE EXEMPT
DMM 602.1.3.e2. Title 18 U.S.C. § 1342
602.499.8807

:man :present:

Arizona state
Pinal county

**SUPERIOR COURT OF ARIZONA
PINAL COUNTY**

:PINAL COUNTY,
:Plaintiff;

Case No. CV 201801825 –
HON. BRENDA E OLDHAM

v.

:RESPONDENT NOTICE

:JAY INGOLD, also know as JAY
ROY INGOLD: subrogation of the
man beneficiary: Jay-Roy> Ingold!: sui
juris
:Aggrieved Party

**TO THE PINAL/Pinal county-
:Craig :DEPUTY COUNTY
ATTORNEY CAMERON**

:Respondent-
Executor;

**ATTEMPT TO RESOLVE THE
MATTERs OF THE FRAUD BY THE
GOOD FAITH CONSULTATION**

Cross-Claimant

v.

:Himanshu: Director, Community
Development Patel, :Paula: Code
Compliance Manager Mullenix,

1 :Jay-Roy: Ingold means: Acknowledgment, Acceptance and Deed of Re-Conveyance: Yavapai
County Recorder: Doc # 2018-0055641.

:Craig: Deputy County Attorney Cameron_ USPS CMN 7018 0360 0000 5968 8850

1/4

2022-011769 MISC Page: 1412 of 2782
09/26/2022 03:35:37 PM Receipt #: 22-9381
Rec Fee: \$30.00 Darrell James Hill
Gila County, Az, Sadie Jo Bingham, Recorder



Handwritten signature and number 1409

Large diagonal watermark: COPY

Terrilyn: Code Compliance Officer
Klucar, :James: Code Compliance
Officer Meadows, :Kent: Pinal County
Attorney Volkmer, :Craig: Deputy
County Attorney Cameron, :John-Doe,
:Jane-Doe,

:Wrong- doers.

:AFFIANT: Man :Beneficiary: Respondent-Executor

:i-man am a living man – the blood flows and the flesh lives – given name :Jay-
Roy: family name: Ingold: Indianan -1962: of sound mind, :beneficiary and
executor of the Almighty-God-given natural rights, and the :beneficiary- subrogee
and executor of the public trust subrogation named: JAY ROY INGOLD~ et al.
derivatives created by the UNITED STATES government-trustee, et al., et seq. –
also including the PINAL/ Pinal county-government-trustee, STATE OF
ARIZONA/ Arizona state-government-trustee.

**ATTEMPT TO RESOLVE THE MATTERS OF THE FRAUD BY THE
GOOD FAITH CONSULTATION**

1. The: PINAL/Pinal county complaint and the James: Code Compliance
Officer Meadows' documents contain certain representations that require
resolution between :i- man-beneficiary, who have been injured, and the trustee.

Specifically:

:Craig: Deputy County Attorney Cameron

2022-011769 MISC Page: 1413 of 2782
09/26/2022 03:35:37 PM Receipt #: 22-9381
Rec Fee: \$30.00 Darrell James Hill
Gila County, Az, Sadie Jo Bingham, Recorder



1410
[Handwritten signature]

PINAL/Pinal county - :Jay-Roy: Ingold 2017 May-June 8th Contract

2. The :complaint and James' affidavit failed to include the substantial material fact of the "PINAL/Pinal county - :Jay-Roy: Ingold" 2017 May-June 8th Contract,

– activated into force: June 8th; 2017: 08:30.01 a.m.; that:

3. All events occurring after the initiation of the Contract on the 2017 May-June 8th are under this agreement, including also this instant matter; that:

3. The :June 8th; 2017 Hearing-meeting was held understanding the 2017 May-June 8th Contract with resultant fraud violations against :i-man.

PINAL/Pinal county COMPLIED WITH THE SIMPLE CONTRACT

4. The :complaint and James' affidavit failed to mention that the PINAL/Pinal county did in fact comply with the 2017 May-June 8th Contract for approximately one year before the man- James: Code Compliance Officer Meadows reports he began acting under the contract; that,

PINAL/Pinal county ABUSE UPON THE PEOPLE

5. For the fact the :man- James: Code Compliance Officer Meadows' perpetrated stalking-harassment behavior goaded the man - :Jay-Roy: Ingold to begin communications for to stop the harassment; and, that:

6. The PINAL/Pinal county complaint and James' affidavit omitted mention of the menacing and nuisance harassment upon the souls living in the community upon the land.

11/11
10/26/2022
:Craig: Deputy County Attorney Cameron USPS CMN 701R 0360 0000 5062 9950 2/1

2022-011769 MISC Page: 1414 of 2782
09/26/2022 03:35:37 PM Receipt #: 22-9381
Rec Fee: \$30.00 Darrell James Hill
Gila County, Az, Sadie Jo Bingham, Recorder



MEETING SUGGESTED

7. :i- Jay-Roy wish for the immediate resolve of this matter, and suggest we set-up a telephonic meeting to satisfactorily resolve these deviations from the truth in this matter within ten days after your receipt of this notice please.

Sincerely,

cc: Scott: Chief Justice Bales
Mark: Sheriff Lamb
Mark: Ariz. AG Brnovich AG

Without Prejudice
JAY ROY INGOLD, subrogation

Jay-Roy Ingold
Jay-Roy Ingold, beneficiary Independent-
Executor

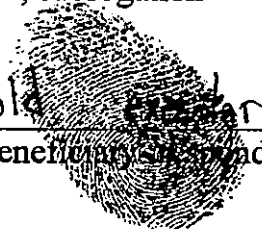

Verified and autographed before me this 29 day: January: 2019 A.D.;
:Type- Identification: Arizona Driver License

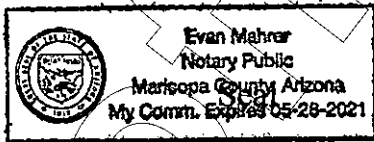

E. A. J.
Notary Public

:Craig: Deputy County Attorney Cameron USPS CMN 7018 0360 0000 5968 8850 4/4

2022-011769 MISC Page: 1415 of 2782
09/26/2022 03:35:37 PM Receipt #: 22-9381
Rec Fee: \$30.00 Darrell James Hill
Gila County, Az, Sadie Jo Bingham, Recorder



1412
[Handwritten signature]

U.S. Postal Service™
CERTIFIED MAIL® RECEIPT
 Domestic Mail Only

For delivery information, visit our website at www.usps.com®

OFFICIAL USE

Certified Mail Fee \$3.50

Extra Services & Fees (check box, add fee as appropriate)

Return Receipt (hardcopy) \$2.40

Return Receipt (electronic) \$0.00

Certified Mail Restricted Delivery \$0.00

Adult Signature Required \$0.00

Adult Signature Restricted Delivery \$0.00

Postage \$0.85

Total Postage and Fees \$4.35

Sent To: Craig: Pinal County Attorney Cameron
 Arizona State Bar Number: -013176
 P.O. Box 887
 Street and Apt. No: Florence, Arizona 85132
 City, State, ZIP+4: 520 866-6466

Postmark: JAN 30 2019
 01/30/2019

PS Form 3800, April 2015 PSN 7533-02-970-0047 See Reverse for Instructions

SENDER: COMPLETE THIS SECTION	COMPLETE THIS SECTION ON DELIVERY
<ul style="list-style-type: none"> Complete items 1, 2, and 3. Print your name and address on the reverse so that we can return the card to you. Attach this card to the back of the mailpiece, or on the front if space permits. 	<p>A. Signature <input checked="" type="checkbox"/> Agent <input checked="" type="checkbox"/> Addressee</p> <p>B. Received by (Printed Name)</p> <p>C. Date of Delivery</p>
<p>1. Article Addressed to:</p> <p>Craig: Pinal County Attorney Cameron Arizona State Bar Number: -013176 P.O. Box 887 Florence, Arizona 85132 520 866-6466</p>	<p>D. Is delivery address different from item 1? <input type="checkbox"/> Yes <input checked="" type="checkbox"/> No if YES, enter delivery address below:</p>
<p>2. Article Number (Transfer from service label)</p> <p>7018 0360 0000 5968 8850</p>	<p>3. Service Type</p> <p><input type="checkbox"/> Adult Signature <input type="checkbox"/> Priority Mail Express®</p> <p><input type="checkbox"/> Adult Signature Restricted Delivery <input type="checkbox"/> Registered Mail™</p> <p><input type="checkbox"/> Certified Mail® <input type="checkbox"/> Registered Mail Restricted Delivery</p> <p><input type="checkbox"/> Collect on Delivery <input type="checkbox"/> Return Receipt for Merchandise</p> <p><input type="checkbox"/> Collect on Delivery Restricted Delivery <input type="checkbox"/> Signature Confirmation™</p> <p><input type="checkbox"/> Insured Mail <input type="checkbox"/> Signature Confirmation Restricted Delivery</p> <p><input type="checkbox"/> Insured Mail Restricted Delivery (over \$500)</p>
<p>PS Form 3811, July 2015 PSN 7530-02-000-9053</p>	<p>Domestic Return Receipt</p>

USPS TRACKING#

9590 9402 3852 8032 5323 33

First-Class Mail
 Postage & Fees Paid
 USPS
 Permit No. G-10

United States Postal Service

Sender: Please print your name, address, and ZIP+4® in this box®

Jay- Roy: Ingold: beneficiary and Executor
 c/o 5142 East 18th Avenue
 Apache Junction, Arizona ZIP

1413

2022-011769 MISC Page: 1416 of 2782
 09/26/2022 03:35:37 PM Receipt #: 22-9381
 Rec Fee: \$30.00 Darrell James Hill
 Gila County, Az, Sadie Jo Bingham, Recorder

:Darrell-James: Hill, :executor, :civilian
c/o PO Box 3806
Apache Junction, Arizona 85117

SECTION B

B) :Claim Of Wrong-Doing Surrounding This Matter Is Thrice Registered
With The Pinal County Sheriff. See: Section B appended: **facts of**
:evidence, e) CMN 7018 0360 0000 5968
6115 - : 4 pages.

Darrell-James -2019 Oct. 28th :Manifest of Bill of Trespassing contract
:PINAL COUNTY/Pinal

2022-011769 MISC Page: 1417 of 2782
09/26/2022 03:35:37 PM Receipt #: 22-9361
Rec Fee: \$30.00 Darrell James Hill
Gila County, Az, Sadie Jo Bingham, Recorder



Jay-Roy: Ingold: beneficiary; Executor
c/o 5142 East 18th Avenue
Apache Junction, Arizona ZIP CODE EXEMPT
DMM 602.1.3.e2. Title 18 U.S.C. § 1342
602.499.8807

Arizona state
Pinal county

:man :present:

:Amanda: Superior Court Clerk Stanford
Pinal County Superior Court
PO Box 2730
Florence, AZ 85132

RE: Case No. **CV201801825, PINAL COUNTY Plaintiff V. JAY INGOLD,**
also know as JAY ROY INGOLD: subrogation of the man-beneficiary: Jay-
Roy: Ingold: sui juris :Aggrieved Party-Respondent, :Executor.

USPS Money Order # [REDACTED] in the amount demanded: 230.00 for the
case noted above. See face copy of same below:

i: Man :Beneficiary: Respondent-Executor

:i-man am a living man – the blood flows and the flesh lives – given name :Jay-Roy:

family name: Ingold: Indianan -1962: of sound mind, :beneficiary and executor of the
Almighty-God-given natural rights, and the :beneficiary- subrogee and executor of the
public trust subrogation named: JAY ROY INGOLD~ et al. derivatives created by the
UNITED STATES government-trustee, et al., et seq. – also including the PINAL/
Pinal county-government-trustee, STATE OF ARIZONA/ Arizona state-government-
trustee. :i am not a U.S. CITIZEN.

USPS Money Order # [REDACTED] in the amount demanded: 230.00 from PO

230.00 paid ;Pinal under duress USPS CMN: 7018 0360 0000 5068 6115 1/2

2022-011769 MISC Page: 1418 of 2782
09/26/2022 03:35:37 PM Receipt #: 22-9381
Rec Fee: \$30.00 Darrell James Hill
Gila County, Az, Sadie Jo Bingham, Recorder



1415
[Handwritten signature]

853300

1. This amount demanded: 230.00 for the case noted above is paid to address injury(s) to :i, et al., from damages imposed by the Pinal trustee, et al. in a common law court of record with the trial by jury to decide all matters of the facts and the law.
2. This is the third attempt.
3. **If :you do not accept this payment then do not mutilate this money order.**
4. The: 230.00 amount paid is under duress: Notice to agent is notice to the principal; notice to principal is notice to the agent.

UNITED STATES POSTAL SERVICE **POSTAL MONEY ORDER**

Serial Number: 25219391545 U.S. Dollars and Cents: \$230.00

Pay to: Pinal County, Florence, Arizona
Address: P.O. Box 2700
Memo: CV 201801825

Postmark: Florence, AZ 85201
Postage: 37.50

© 2008 United States Postal Service. All Rights Reserved. WARNING: NEGOTIABLE ONLY IN THE U.S. AND POSSESSIONS

Without Prejudice
JAY ROY INGOLD :subrogation
Jay-Roy: Ingold executor
Jay-Roy: Ingold, beneficiary- respondent-
Executor

1416
230.00 paid ;Pinal under duress

USPS CMN: 7018 0360 0000 5968 6115

2022-011769 MISC Page: 1419 of 2782
09/26/2022 03:35:37 PM Receipt #: 22-9381
Rec Fee: \$30.00 Darrell James Hill
Gila County, Az. Sadie Jo Bingham, Recorder



USPS Tracking®

Track Another P

Tracking Number: 701803600005968

Expected Delivery on

WEDNESDAY

20 FEBRUARY 2019

See Product Information

Delivered

February 20, 2019 at 10:58 am
Delivered
FLORENCE, AZ 85132

Get Updates

Text & Email Updates

Tracking History

February 20, 2019, 10:58 am
Delivered
FLORENCE, AZ 85132
Your item was delivered at 10:58 am on February 20, 2019 in FLO

February 20, 2019, 8:53 am
Available for Pickup
FLORENCE, AZ 85132

February 20, 2019, 8:49 am
Arrived at Unit
FLORENCE, AZ 85132

February 19, 2019
In Transit to Next Facility

February 18, 2019, 11:06 pm
Departed USPS Regional Facility
PHOENIX AZ DISTRIBUTION CENTER

February 15, 2019, 11:37 pm
Arrived at USPS Regional Facility

U.S. Postal Service™
CERTIFIED MAIL RECEIPT
Domestic Mail Only

For delivery information, visit our website at www.usps.com

FLORENCE AZ 85132
OFFICIAL USE

Certified Mail Fee \$3.50
Extra Services & Fees (check box, add fee as appropriate)
 Return Receipt (hardcopy) \$0.00
 Return Receipt (electronic) \$0.00
 Certified Mail Restricted Delivery \$0.00
 Adult Signature Required \$0.00
 Adult Signature Restricted Delivery \$0.00

0130
11

Postmark Here

Postage \$0.70
Total Postage and Fees \$4.20

02/15/2019

Sent To Amanda: Superior Court Clerk Stanford
Street and Apt. No., or PO Box Pinal County Superior Court
PO Box 2730
City, State, ZIP+4® Florence, AZ 85132

PS Form 3800, April 2015 PSN 7530-02-000-9047 See Reverse for Instructions

APACHE JUNCTION
151 W SUPERSTITION BLVD
APACHE JUNCTION
AZ
85120-9998
0302590130
(800)275-8777 4:09 PM

Product Description Sale Qty Final Price

First-Class Mail Letter 1 \$0.70

(Domestic)
(FLORENCE, AZ 85132)
(Weight: 0 Lb 1.20 Oz)
(Estimated Delivery Date)
(Tuesday 02/19/2019)
Certified 1 \$3.50
(®USPS Certified Mail #)
(7018036000059686115)

Total \$4.20

Credit Card Remitd \$4.20
(Card Name: VISA)
(Account #: XXXXXXXXXXXX2301)
(Approval #: 003900)
(Transaction #: 872)
(AID: A0000000031010 Chip)
(AL: Visa Credit)
(PIN: Not Required)

Text your tracking number to 28777 (2USPS) to get the latest status. Standard Message and Data rates may apply. You may also visit www.usps.com USPS Tracking or call 1-800-222-1811.

In a hurry? Self-service kiosks offer quick and easy check-out. Any Retail Associate can show you how.

2022-011769 MISC Page: 1420 of 2782
09/26/2022 03:35:37 PM Receipt #: 22-9981
Rec Fee: \$30.00 Darrell James Hill
Gila County, Az, Sadie Jo Bingham, Recorder

1417

:Darrell-James: Hill, :executor, :civilian
c/o PO Box 3806
Apache Junction, Arizona 85117

SECTION C

C) :Conusance Was Made To Prevent A Continued And Expanded Process Of
Wrong-Doings Proposed By The Pinal County/Pinal County Hand, Policy Or
Agency, Et Al. With Re: To The 'Arizona -Superior -Court -record, Pinal county
:number: 'CV201801825'- case'. See: Section C appended, 10 pages;

~~1419~~
1419
Darrell-James -2019 Oct. 28th :Manifest of :Bill of: Trespassing contract
:PINAL COUNTY/Pinal cr

2022-011769 MISC Page: 1422 of 2782
09/26/2022 03:35:37 PM Receipt #: 22-9381
Rec Fee: \$30.00 Darrell James Hill
Gila County, Az, Sadie Jo Bingham, Recorder



Darrell-James: Hill, c/o PO Box 3806, Apache Junction, Arizona 85117

Arizona state
Pinal county

:i- the :man- :Darrell- James: Hill, now on this 1st day: August: 2019 A.D., on his affirmation, claimant deposes and says: - Notice to the Agent is Notice to the Principal; Notice to the Principal is Notice to the Agent: -

Stephen-F.: Judge McCarville
Pinal County Superior Presiding Judge
PO Box 828
Florence, Arizona 85132

RE: Right of Conusance¹. The commercial court now being imposed upon the man -:Jay-Roy: Ingold in my observation is wrong-doing. The :Court of Record with the trial-by-jury to hear and try the :matters of the fact and in the law is the only righteous means to safeguard the good faith duty to the man- :Jay-Roy: Ingold, et al., and specifically, :i-man: Darrell-James: Hill, et al., - in re: the man :Jay-Roy: Ingold² involvement in the Pinal County, et al. complaint #'CV 2018 01825' - with regard to the legal but unlawful- imposition- of- injuries - done, their effort to further justify more :damage upon the man :Jay-Roy: Ingold, their effort to avoid the June 8th, 2017 contract agreed to by the Pinal- county agents, and their effort to justify more :threat-of/ :damages upon :i-man-beneficiary: Darrell-James: Hill, et al., rightful :inhabitants on the private property.

Stephen, Greetings:

a. The un-noticed change of magistrate.

:i- man believe that the man: Brenda-E.: Judge Oldham was appointed earlier to this matter. And, :i- man believe you are the man that :Jay-Roy did also write-to earlier this year: 2018 A.D. during his effort at :seeking-help with the Pinal -county -court -right, -reason, and -how-to-access-the court based-upon the after-effects that :Jay-Roy was prohibited by the Pinal- County- Superior- Court- Clerk, et al., from answering as a :man to the :allegations in a Pinal- county- commercial- complaint³; - :an :overt- :denial-of-due-process, :routine and

1 Consuance means: directly knowing the :facts, in this matter :i-man have right to speak to halt wrong-doing by public servants.

2 :Jay-Roy: Ingold means: the :man of the debenture named by the idem-sonans- subrogation: JAY ROY INGOLD, ~ @ 1962 ~ and, et al. derivative names, used as the alleged -defendant in a commercial action by the Pinal county in :their :Pinal County Superior Court complaint: 'CV 2018 01825'.

3 Prohibited ... from answering... their complaint means: In fact: 99-100% of :Jay-Roy's :documents and

Stephen-F.: McCarville USPS RMN RE 222 104 115 XIC 09/01/10 1.15

2022-011769 MISC Page: 1423 of 2782
09/26/2022 03:35:37 PM Receipt #: 22-9381
Rec Fee: \$30.00 Darrell James Hill
Gila County, Az, Sadie Jo Bingham, Recorder



[Handwritten signature and number 1420]

Darrell-James: Hill, c/o PO Box 3806, Apache Junction, Arizona 85117

common in :racketeering, demonstrated by :Pinal- county- officials.

b. The :Court of Record- Trial-by Jury venue for the protection of :- man :Darrell-James: Hill, et al.

1. :- man am: Darrell-James: Hill⁴, :-beneficiary⁵. :- man am :Darrell-James: Hill :beneficiary of the :natural- and inherent-trusts by :Almighty- God – and, :nothing exists between the: Almighty- God and :i. Also⁶,
2. :- man- :Darrell-James: Hill am a :civilian- private-property -owner.
3. :- man am a :legal- :idiot, not trained :at-law, and not a member of the legal- society- club.
4. :- man am a :soul- :living on the land. :- man am a :living- :soul with a dwelling at the purportedly-same- Pinal- county- geographical- location- appointment⁷ as the :private- land- and- habitat- location⁸ where is the :Jay-Roy: Ingold, et al., natural- :home and property area.
5. :- man (and :wife) are :party to a private-contract with the man: Jay-Roy: Ingold which also includes :our dwelling on the land. :- man and :wife are in a private contract with the man: Jay-Roy: Ingold for the monitoring and care of his private land, home, chattels and other-helps since: 2015 A.D.
6. :- man, et al. have the :first-hand- knowledge of the actions of the Pinal- county- agents in the matter of this trespass. :- man have :first-hand- :knowledge of the events occurring on and about the private property owned by :Jay-Roy, since : 2015. And,
7. :- man- :beneficiary affirmed by the affidavits the :injuries imposed upon :- man in the Jay-Roy- documents-filed by :USPS Registered and Certified Mail delivery into the Pinal County Superior Court Clerk. :- man have affirmed the violation of :- man's right to live in peace in the :affidavits with :Jay-Roy's filings to the Pinal county court-clerk. However, the :facts of the damages imposed upon :- man-beneficiary, et al. are reportedly ignored by

payments sent with his answers to the Pinal- county- clerk were received then, by all who have been notified, permitted to be ignored-and-not-filed-or-otherwise-rejected by the Pinal-County-Superior-Court- Clerk trustee(s): that is, the :documents were somehow pre-adjudicated by a deputy-county clerk and serially-made- Not- filed or accepted as a man's best and good-faith answer to the only answerable document. The :230-dollar - :payments were thrice made in the form-requested by the court-clerk, and thrice were denied and sent-mutilated back to the man- :Jay-Roy. Many affidavits on these facts of the trespass: threats, trepidation, and of other damages, the truths are summarily ignored and despised as the non-professional answers in the filings demonstrate then-to-fore: – :this is an :overt- :denial-of-due-process- :routine and :racketeering by :Pinal- county- officials.

4 :Darrell-James: Hill, :-beneficiary means:

5 :beneficiary means: one designated for the benefit of a thing, e.g. the :cestui-que-use of a trust.

6 Also means: includes and is not limited to: a) :- man am a :Negro- :status secured under the :Proclamation- of-Emancipation – 1862- 1863; and:

b) :- man am :beneficiary of the UNITED-STATES government- Trustee Emergency Banking Act of 1933-; EBA-1933, :indenture with the debenture named by the idem-sonans-subrogation: DARRELL JAMES HILL @ 1958 ~ and, et al. derivative names; and:

c) There to: and, as relates to the "Trading With The Enemy Act of 1917", as amended by :EBA-1933, :- man-beneficiary am a :civilian- private- property -owner.

7 Parcel #: 103-14-012B

8 :private- land- and- habitat- location means: 5124 East 18th Avenue, Apache Junction, Arizona state territory.

Stephen-F.: McCarville USPS RMN RE.322.404.115 IIS

09/26/2022 03:35:37 PM 215

2022-011769 MISC Page: 1424 of 2782
09/26/2022 03:35:37 PM Receipt #: 22-9381
Rec Fee: \$30.00 Darrell James Hill
Gila County, Az, Sadie Jo Bingham, Recorder



142

Darrell-James: Hill, c/o PO Box 3806, Apache Junction, Arizona 85117

the Pinal county agents in their pursuit of this private- non-political- commercial-gain according to the man: Craig: Deputy- County- Attorney- Cameron's filings wherein he is asking the Pinal- county Superior Court- Clerk trustee for more collusion, even to file a :default in favor of the Pinal- county for the non- answer or response, which appears to be in competition with the trustee's duties and obligations to the people; - and,

8. :Craig asks :this favor of the very same- Pinal-County-Superior-Court-Clerk involved in the obstruction and denial-of-due-process- rights-executed by the man: Jay-Roy to answer the :claim-made by :Craig.

9. The :complaint filed by :Craig against the man- :Jay-Roy, established no verifiable claim by a man of any injury or damage. And,

10. The :request for :all of the evidence :Craig possessed on the matter has been ignored, as that if the Superior Court Clerk does not acknowledge the communication then he deems not essential for him to act upon the any lawful demand.

11. :i- man believe there is not a verifiable claim-made in this action against the man- :Jay-Roy, that wherefrom this complaint-is has needlessly threatened and damaged :i- man- :Darrell-James: Hill, et al.

12. :i- man believe the :Pinal- county- agent's actions are :wrong-doings within an open collusion. :i- man believe that these actions are :intended- :collusions against the man- :Jay-Roy, et al., for the goal of the non-political :commercial-gains in :violation of the U.S. Trustee's restriction upon the Pinal- county to not compete and to absolutely make certain to protect and insure that :i- man: Darrell-James: Hill -beneficiary- :living-soul on the land experience No damages and No further damages.

c. The :Court of Record- Trial-by Jury :Equity- venue for the protection of :i- man :Darrell-James: Hill, et al. - the June 8th, 2017 Contract

13. The June 8th, 2017 contract. For the inability of the words and letters to cease the Pinal- county- agents harassment, and for the effect to stop of the trespass, :Jay-Roy submitted the June 8th, 2017 contract in :honor of the Pinal- county- agent- offer for their threat of more further damages then-to-fore- planned upon :Jay-Roy, et al., i.e. Darrell-James: Hill, et al. And,

14. :i- man- :Darrell-James: Hill -beneficiary was present at the June 8th, 2017 contract meeting. :i- man: Darrell-James: Hill- :beneficiary was present at the meeting on the day that the agreement of the June 8th, 2017 contract that was openly acquiesced before and in the meeting of the completion of the agreement into the June 8th, 2017 contract, when the Pinal- county- agent formally-accepted the presentment wholly as written into the evidence into the record in lieu of :Jay-Roy's reading the simple contract onto the hearing record at the meeting.

15. :i- man recall and can testify in open court to the good-faith efforts made by the man :Jay-Roy to end the Pinal- county- agent -trespass, -threatening, -harassment and - stalking-behavior on and about the private property; and,

16. :i- man witnessed the Pinal- county- trustee act in the despise of the contract. :i- man have witnessed, observed and wrote about the Pinal- county- apparatus of :trespasses occurring after the June 8th, 2017 contract, the: stalking behavior on a dead-end- county-

Stephen-F.: McCarville USPS RMN RE. 322 404 115 IIS

09/26/2022 03:35:37 PM

2022-011769 MISC Page: 1425 of 2782
09/26/2022 03:35:37 PM Receipt #: 22-9981
Rec Fee: \$30.00 Darrell James Hill
Gila County, Az, Sadie Jo Bingham, Recorder



1423

Darrell-James: Hill, c/o PO Box 3806, Apache Junction, Arizona 85117

lane threatening the habitat of the living-souls on and about the private land in the Arizona state territory at the: Jay-Roy's home area: 5124 East 18th Avenue, Apache Junction, Arizona state territory, etc. Further,

17. **i- man believe commercial-capital-gains is the Pinal- county's- focus. i- man believe that this whole- intent was purely for a Pinal- county-commercial- gain at the deprivation of the man's -right to live in :peace, and to totally for their homogeneity upon the man- :Jay-Roy, and thus onto i- man- :Darrell-James: Hill -: beneficiary, et al.**
18. **i- man belief that the Pinal- county -avoidance of the June 8th, 2017 contract is for the imposition of their goal of: gaining-further-access to the subsequent damage upon the man- :Jay-Roy, and upon i- man- :Darrell-James: Hill, et al, at this time. i- man believe that from the June 8th, 2017 Contract- unto- now that the Pinal- county- agent- trespasses and wrong-doings solely involved the making of the commercial complaint with no claim against a living man: Jay-Roy's right to answer the Pinal- county complaint solely based-upon the avoidance of the Pinal- county- obligation to the June 8th, 2017 Contract agreement; that is, a cost of :one- ounce of :silver U.S. dollar per minute beginning at the April 5th, 2017, 5:00 p.m. and ending when this matter is resolved.**
19. **i- man believe that the matter of the June 8th, 2017 contract is an equity-venue matter. i- man believe that the matter of the June 8th, 2017 contract is an equity-venue matter that is now ignored in the the Pinal- county- agents by :denial of :due process, and by the :push for the Pinal- county -Clerk- of-the-Superior court to assure the :deprivation of :rights of a man-beneficiary in a commercial court that does not see nor hear the man- :Jay-Roy's or acknowledge his right of common access to the court that is the protected due process and jurisdiction. By the bold and desperate- collusion to cover-up the un-Lawful and illegal unjust commercial gains, violations are exposed, and the retaliation against the man- :Jay-Roy, et al., is this systematic injury, and, consequentially, begets more injury upon i- man-beneficiary: Darrell-James: Hill.**
20. **:Remedy: For the safety and protection of i- man-beneficiary: Darrell-James: Hill, et al, i- man require that a court-of-record with trial-by-jury be the mechanism to try the claims of the the Pinal- county and of the man- :Jay-Roy, et al., to ascertain is they are true. Additionally, i- man require that a court-of-record with trial-by-jury be convened to try the claims of the facts and the law of the June 8th, 2017 contract to ascertain which matters of the fact and the contract between the man- :Jay-Roy and the Pinal- county, et al.- agents' are right and just.**
21. **If the Pinal- county, et al., -court chooses to ignore the subsequently injured party: i- man- :Darrell-James: Hill, et al. for their sake of sustaining to themselves more non-political capital gains by the denial-of-due-process and default process in place against the man: Jay-Roy: Ingold then i- man- :Darrell-James: Hill do not consent to being in anyway considered to be accepting of that wrong-doing, and i- man in no wise concede any rights-executed or to be executed against any such perpetrators. And, upon the cause that this matter-between the man: Pinal- county and the man- :Jay-Roy: Ingold defaults for the corruption that is predetermined, i- man: Darrell-James: Hill do not consent to the Pinal- county corruption, and all of my property will be immune**

Stephen-F.: McCarville USPS RMN RE 322 404 115 JIC

2022-011769 MISC Page: 1426 of 2782
09/26/2022 03:35:37 PM Receipt #: 22-9381
Rec Fee: \$30.00 Darrell James Hill
Gila County, Az, Sadie Jo Bingham, Recorder



1423

Darrell-James: Hill, c/o PO Box 3806, Apache Junction, Arizona 85117

from the Pinal- county- agent- trespass; and, any violation is subject to the costs already established for such violations.

cc: **Kent: Pinal County Attorney Volkmer**
c/o Craig: Deputy county Attorney Cameron
c/o PO Box 887
Florence, Arizona 85132

General Mark A. Milley
Chairman of the Joint Chiefs of Staff
c/o Office of the Chairman of the JCOS
9999 Joint Staff Pentagon
Washington, DC 20318-9999

Air Force General John Hyten,
Vice Chairman of the Joint Chiefs of Staff
c/o General Mark A. Milley
9999 Joint Staff Pentagon
Washington, DC 20318-999

General David H. Berger
Commandant of the Marine Corps HQ,
c/o General Mark A. Milley
US Marine Corps 3000 Marine Corps,
Pentagon
Washington, DC 20350-3000

Kevin-D.: Judge White
Superior Court Associate Presiding Judge
c/o PO Box 2578
Florence, Arizona 85132

Jason-R.: Judge Holmberg
Presiding Civil Judge
c/o PO Box 986
Florence, Arizona 85132

Lt. Gen. Joseph M. Martin
Army Chief of Staff
c/o General Mark A. Milley
200 Army Pentagon
Washington, DC 20310-0200

General David L. Goldfein
Air Force Chief of Staff
c/o General Mark A. Milley
1670 Air Force Pentagon
Washington, DC 20330-1670

Darrell James Hill AR

IURAT

Sworn to and subscribed before me now on this 1st day: August: 2019.
Produced identification: type: Arizona Driver License.

Savannah Czerwinski

Notary

seal

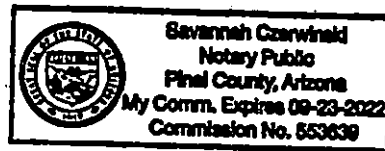

Stephen-F.: McCarville USPS RMN RE.322 404 115 US

2022-011769 MISC Page: 1427 of 2782
09/26/2022 03:35:37 PM Receipt #: 22-9381
Rec Fee: \$30.00 Darrell James Hill
Gila County, Az, Sadie Jo Bingham, Recorder



1424

FLORENCE
 501 N MAIN ST
 FLORENCE, AZ 85132-9998
 032886-0253
 (800)275-8777
 08/02/2019 03:44 PM

Product	Qty	Unit Price	Price
First-Class Mail® Letter (Domestic) (FLORENCE, AZ 85132) (Weight: 0 Lb 1.50 Oz) (Estimated Delivery Date) (Monday 08/05/2019)	1	\$0.70	\$0.70
Registered (Amount: \$0.00) (USPS Registered Mail #) (RE322404209US)			\$12.40
Return Receipt (USPS Return Receipt #) (9590940247428344639745)			\$2.80
First-Class Mail® Letter (Domestic) (FLORENCE, AZ 85132) (Weight: 0 Lb 1.00 Oz) (Estimated Delivery Date) (Monday 08/05/2019)	1	\$0.55	\$0.55
Registered (Amount: \$0.00) (USPS Registered Mail #) (RE322404115US)			\$12.40
Return Receipt (USPS Return Receipt #) (9590940247428344639752)			\$2.80
Total:			\$31.65
Cash Change (\$8.35)			\$40.00

Text your tracking number to 28777.
 (2USPS) to get the latest status.
 Standard Message and Data rates may

Registered No. **RE322404115US** Date Stamp **0255 10**

To Be Completed By Post Office	Reg. Fee	\$0.55	
	Handling Charge	\$12.40	Return Receipt
	Postage	\$2.80	Restricted Delivery
	Received by	\$0.00	
		\$15.75	

Customer Must Declare Full Value **\$0.00** Domestic Insurance up to \$25,000 included in the declared value. Indemnity is limited. (See Reverse).

08/02/2019

OFFICIAL USE

FROM: Darrell James Hill
 s/o PO Box 3806
 Apache Junction, Arizona 85117

TO: Stephen F. Judge, McCarville
 Pinal County Superior Presiding Judge
 PO Box 628
 Florence, Arizona 85132

PS Form 3806, Receipt for Registered Mail Copy 1 - Customer
 May 2007 (7530-02-000-9051) (See Information on Reverse)
 For domestic delivery information, visit our website at www.usps.com

COMPLETE THIS SECTION ON DELIVERY

A. Signature Agent Agent
 B. Restricted Delivery Signature Confirmation
 C. Signature Confirmation Registered Mail
 D. Is delivery address different from item 1? Yes No
 If YES, enter delivery address below.

3. Services Type:
 Adult Signature
 Adult Signature Restricted Delivery
 Certified Mail
 Certified Mail Restricted Delivery
 Collect on Delivery
 Collect on Delivery Restricted Delivery
 Insured Mail
 Insured Mail Restricted Delivery
 Registered Mail
 Registered Mail Restricted Delivery
 Signature Confirmation
 Signature Confirmation Restricted Delivery
 Signature Confirmation Restricted Delivery (over \$500)

Domestic Return Receipt

SENDER: COMPLETE THIS SECTION

1. Complete items 1, 2, and 3.
 Print your name and address on the reverse so that we can return the card to you.
 Attach this card to the back of the mailpiece, or on the front if space permits.
 Article Addressed to:
 Stephen F. Judge McCarville
 Pinal County Superior Presiding Judge
 PO Box 628
 Florence, Arizona 85132

9590 9402 4742 8344 6397 52

RE 322 404 115 US

Form 3811, July 2015 PSN 7530-02-000-9053



Darrell-James: Hill, c/o PO Box 3806, Apache Junction, Arizona 85117

Arizona state
Pinal county

:i- the :man- :Darrell- James: Hill, now on this 2nd, day: August: 2019 A.D., on his affirmation, claimant deposes and says: - Notice to the Agent is Notice to the Principal; Notice to the Principal is Notice to the Agent: -

:Todd: Pinal county Supervisor House
:Steve: Pinal county Supervisor Miller
:Pete: Pinal county Supervisor Rios
:Mike: Pinal county Supervisor Goodman
:Anthony: Pinal county Supervisor Smith,
c/o :Natasha: Clerk of the Board Kennedy
c/o Pinal County, Board of Supervisors
135 N. Pinal Street
Administrative Complex
Florence, Arizona 85132

USPS RMN RE 322 404 209 US

RE: Right of Consuance

:Todd, :Steve, :Pete, :Mike, :Anthony, :Natasha Greetings:

Thank you for your service.
My prayers are with you.

You, et al., must assured to be aware

:Appended hereto is the :affidavit- :document regarding the :deprivation of the rights-executed of a :man: Jay-Roy: Ingold, and, now-also, :i- man: Darrell-James: Hill, subsequent to a matter wherein you, the: Pinal-county-Board-of Supervisors are directly responsible.

:i- man am :Darrell-James: Hill, as indicated in the document. And, for the reasons affirmed and inferred in the document, :malfeasance may be illustrated, as:

1. :i- man have witnessed coercive-misuse of :authority that became to negatively-effect the :peace of the people at their :place-of-habitation, as indicated in the document.
2. :Not-explicitly-stated in the document is the fact that :this-matter could not exist unless the :Pinal-county-Board-of-Supervisors somehow authorized for :whatever- reasons-given that the county attorneys act-against the :man- :Jay-Roy: Ingold, as indicated in the document.

3. :Now, did you not-know that your Pinal county agents formed and accepted a May 8th,

Pinal county Bd of Supv/ Clerk: USPS RMN RE 322 404 209 US

2022-011769 MISC Page: 1429 of 2782
09/26/2022 03:35:37 PM Receipt #: 22-9381
Rec Fee: \$30.00 Darrell James Hill
Gila County, Az, Sadie Jo Bingham, Recorder



Handwritten signatures and the number 1426.

Darrell-James: Hill, c/o PO Box 3806, Apache Junction, Arizona 85117

2017 agreement which they activated :contract on :June 8th, 2017 with the man: Jay-Roy: Ingold by the authority of your community-development-mechanism- :commercial- offer? :Jay-Roy, in the accordance with Arizona Law and statute, was formally denied the right to opt-out of the Pinal-county, et al.: community development program, a :private-:commercial-gains - :vehicle of the Pinal county, on June 8th, 2017.

The :Ingold- :contract now-time requires the :Pinal county, et seq. to pay to the :man: Jay-Roy: Ingold the :amount of :one- :one-ounce silver U.S. dollar per the minute for these continued- actions, as indicated in the contract. - i.e., starting on: April 5, 2017: 5:00 p.m. until this :matter is resolved - (EXAMPLE BILL CALCULATION: 365 days/ year x 24 hours/day x 60 minutes/ hour/day = 525,600 minutes/hour/day/year)- if the :deprivation- of- :rights-abuses did not cease and desist on :June 8th, 2017: 08:30 a.m.

Now: the :man- Craig: your :Deputy county Attorney Cameron is the actor at the center of the matter of these facts which have now become none-other-than- a- :manifestation of the intent to deprive the :man- :Jay-Roy: Ingold by the denial of the man- :Jay's right(s)-executed for :Jay-Roy, et al., to live in the peace on his private- :property, et seq.

As indicated in the appended document, :i- man: Darrell-James: Hill-beneficiary am the steward(s) (with: wife: Beverly) by a :private- :contract on the :Jay-Roy: Ingold- private- property, and :i- man now have additionally been drawn directly into this matter as a :private- :man- :beneficiary and made-subject on :your-behalf by :your-:agent: Craig: Attorney Cameron. The appended document of the right-executed, The right of Consuance..., establishes the :fact that :i-man and :wife: Beverly-Jean: Romero- Hill-beneficiary, have now been made targets, even: collateral-damage, by the man: Craig: your- :Attorney-agent(s). :You have now been made aware of :this wrong-doing- :man- abuse by your authority.

:You have now been made aware of :this, that your authorization has been used to do-wrong against private people and civilians-: i-man: Darrell-James: Hill, and Beverly-Jean: Romero- Hill. All that remains to be known-now :is, 'Is :this wrong-doing :your :manly- :intent? Is this the :policy of the Pinal- county-, Board-of-Supervisors?

In :Conclusion, If :i- man-beneficiary may suggest

:i- man believe that :it is in the best long- and short- term interests of all parties that this matter goes-away now; the :pursuit of :doing-wrong is never profitable. :i- man observe to suggest that: because this-type- :malfeasance is never good, through your management :this matter is best withdrawn and amicably settled-and-closed. This serves to the advantage of all parties, the man: Jay-Roy: Ingold, et al., and the people of :Pinal county.

cc: **Kent: Pinal County Attorney Volkmer**
c/o Craig: Deputy county Attorney Cameron
c/o PO Box 887...
Florence, Arizona 85132

Kevin-D.: Judge White
Superior Court Associate Presiding Judge
c/o PO Box 2578
Florence, Arizona 85132

Pinal county Bd of Supv/ Clerk: USPS RMN RE 322 404 209 US

08/02/19 2/3

2022-011769 MISC Page: 1430 of 2782
09/26/2022 03:35:37 PM Receipt #: 22-9381
Rec Fee: \$30.00 Darrell James Hill
Gila County, Az, Sadie Jo Bingham, Recorder



1427

Darrell-James: Hill, c/o PO Box 3806, Apache Junction, Arizona 85117

General Mark A. Milley
Chairman of the Joint Chiefs of Staff
c/o Office of the Chairman of the JCOS
9999 Joint Staff Pentagon
Washington, DC 20318-9999

Air Force
General John Hyten,
Vice Chairman of the Joint Chiefs of Staff
c/o General Mark A. Milley
9999 Joint Staff Pentagon
Washington, DC 20318-999

General David H. Berger
Commandant of the Marine Corps HQ,
c/o General Mark A. Milley
US Marine Corps 3000 Marine Corps,
Pentagon
Washington, DC 20350-3000

Jason-R.: Judge Holmberg
Presiding Civil Judge
c/o PO Box 986
Florence, Arizona 85132

Lt. Gen. Joseph M. Martin
Army Chief of Staff
c/o General Mark A. Milley
200 Army Pentagon
Washington, DC 20310-0200

General David L. Goldfein
Air Force Chief of Staff
c/o General Mark A. Milley
1670 Air Force Pentagon
Washington, DC 20330-1670

Thank-you,
Without Prejudice

Darrell-James Hill
:Darrell-James: Hill, Beneficiary

IURAT

Sworn to and subscribed before me now on this 2nd, day: August: 2019.
Produced identification: type: Arizona Driver License.

[Signature]
Notary

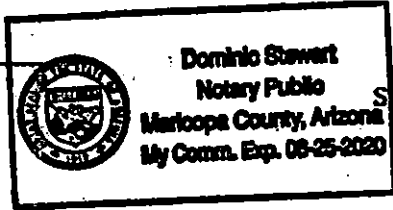

~~1430~~
1428

Pinal county Bd of Supv/ Clerk: USPS RMN RE 322 404 209 US

08/02/19 3 / 3

2022-011769 MISC Page: 1431 of 2782
09/26/2022 03:35:37 PM Receipt #: 22-9381
Rec Fee: \$30.00 Darrell James Hill
Gila County, Az, Sadie Jo Bingham, Recorder



=====

FLORENCE
 501 N MAIN ST
 FLORENCE, AZ 85132-9998
 032886-02554
 (800)275-8777
 08/02/2019 03:44 PM

=====

Product	Qty	Unit Price	Price
First-Class Mail® Letter (Domestic) (FLORENCE, AZ 85132) (Weight: 0 Lb 1.50 Oz) (Estimated Delivery Date) (Monday 08/05/2019)	1	\$0.70	\$0.70
Registered (Amount: \$0.00) (USPS Registered Mail #) (RE322404209US)			\$12.40
Return Receipt (USPS Return Receipt #) (9590940247428344639745)			\$2.80
First-Class Mail® Letter (Domestic) (FLORENCE, AZ 85132) (Weight: 0 Lb 1.00 Oz) (Estimated Delivery Date) (Monday 08/05/2019)	1	\$0.55	\$0.55
Registered (Amount: \$0.00) (USPS Registered Mail #) (RE322404115US)			\$12.40
Return Receipt (USPS Return Receipt #) (9590940247428344639752)			\$2.80
Total:			\$31.65
Cash			\$40.00
Change			(\$8.35)

Text your tracking number to 28777
 (2USPS) to get the latest status.
 Standard Message and Data rates may

Registered No. **RE322404209US**

Date Stamp **0255 FLORENCE, AZ AUG - 2 2019 USPS 35132**

Reg. Fee	\$0.70	
Handling Charge	\$12.40	Return Receipt
Postage	\$2.80	Restricted Delivery
Received by	\$0.00	
		\$15.90

Customer Must Declare Full Value **\$0.00** Domestic Insurance up to \$25,000 is included on the declared value. International indemnity is limited. (See Reverse).

OFFICIAL USE

FLORENCE, AZ 85132

FROM: Darrell James Hill
 c/o PO Box 3906
 Apache Junction, Arizona 85117

TO: Natalia: Clerk of the Board Kennedy
 c/o Pinal County Board of Supervisors
 Administrative Complex
 Florence, Arizona 85132

PS Form 3806, Receipt for Registered Mail May 2007 (7530-02-000-9051) Copy 1 - Customer (See Information on Reverse) For domestic delivery information, visit our website at www.usps.com

COMPLETE THIS SECTION ON DELIVERY

A. Signature *Darrell James Hill*

B. Received by (Printed Name) *Darrell James Hill*

C. Date of Delivery *08/02/2019*

D. Is delivery address different from item? Yes No

If YES, enter delivery address below:

3. Service Type
 Priority Mail Express®
 Registered Mail™
 Adult Signature Restricted Delivery
 Certified Mail®
 Collect on Delivery
 Registered Mail Restricted Delivery
 Return Receipt for Merchandise
 Signature Confirmation™
 Signature Confirmation Restricted Delivery
 Restricted Delivery (over \$500)

Domestic Return Receipt

COMPLETE THIS SECTION

1. Article Addressed to:
 Natalia: Clerk of the Board Kennedy
 c/o Pinal County Board of Supervisors
 135 N. First Street
 Administrative Complex
 Florence, Arizona 85132

2. Complete items 1, 2, and 3.
 Print your name and address on the reverse so that we can return the card to you.
 Attach this card to the back of the mailpiece, or on the front if space permits.

9590 9402 4742 8344 6397 45

RE 322 404 209 US

PS Form 3811, July 2016 PSN 7530-02-000-9053



1429

:Darrell-James: Hill, :executor, :civilian
c/o PO Box 3806
Apache Junction, Arizona 85117

SECTION D

D) By The :Court-:Internal- Review, The ':Arizona -Superior -Court -record,
Pinal County :number: 'CV201801825' -Case' Was Dismissed. See: Section D
appended, 2 pages;

Darrell-James -2019 Oct. 28th :Manifest of :Bill of: Trespassing contract
:PINAL COUNTY/Pinal

2022-011769 MISC Page: 1433 of 2782
09/26/2022 03:35:37 PM Receipt #: 22-9381
Rec Fee: \$30.00 Darrell James Hill
Gila County, Az, Sadie Jo Bingham, Recorder



IN THE SUPERIOR COURT
PINAL COUNTY, STATE OF ARIZONA

Date: October 7, 2019

THE HONORABLE ROBERT CARTER OLSON

IN RE THE MATTER OF:

Pinal County

AND

JAY INGOLD

PLAINTIFF

DEFENDANT

S1100CV201801825

ORDER RE: Dismissal

This matter having come before the Court for Internal Review,

The Court **FINDS** that this matter has been on the Dismissal Calendar for more than 60 days without filing a joint report and proposed scheduling order, a final decision by an arbitrator, or a request to continue on the Dismissal Calendar, as required by Civil Rule 38.1(d)(1) to avoid dismissal.

IT IS FURTHER ORDERED dismissing this matter without prejudice, pursuant to Civil Rule 38.1(d)(2).

IT IS FURTHER ORDERED vacating all future calendar dates; closing this file; and this is a final judgment, pursuant to Civil Rule 54(c).



eSigned by Olson, Robert 10/07/2019 17:21:17 zZRTVzTn

~~1431~~
1431

2022-011769 MISC Page: 1434 of 2782
09/26/2022 03:35:37 PM Receipt #: 22-9381
Rec Fee: \$30.00 Darrell James Hill
Gila County, Az, Sadie Jo Bingham, Recorder



Emailed/Mailed/Distributed Copy:

CRAIG C. CAMERON
pcacivil@pinalcountyz.gov

JAY INGOLD
5124 E. 18th Ave.
Apache Junction, AZ 85119-9374

OFFICE DISTRIBUTION:
JUDGE/OLSON
JAA/NORTEGA

Unofficial Copy

Unofficial

~~1432~~
1432

2022-011769 MISC Page: 1435 of 2782
09/26/2022 03:35:37 PM Receipt #: 22-9381
Rec Fee: \$30.00 Darrell James Hill
Gila County, Az, Sadie Jo Bingham, Recorder



:Darrell-James: Hill, :executor, :civilian
c/o PO Box 3806
Apache Junction, Arizona 85117

SECTION G

G) The :2017 May-June 8th Contract- :Fee-Schedule- Obligation Due Paid Now:
Is: 792,022 - :one-'U.S.'- Silver -dollar. See Bill for :792,022- :one- 'U.S.' -silver
dollar -in -specie. See: Section G appended, 1 page;

**:i- man demand and require the :Payment of :all of the 792,022 - :one-
'U.S.'- Silver -dollar now-due in accordance with the :2017 May-June 8th
Contract; the :PINAL COUNTY/Pinal county-Obligation is due-paid-now upon
billing. And: All of the collection expenses and charges for the any amount-
due or unpaid is the sole financial obligation of the PINAL COUNTY/Pinal
county, due-paid upon :billing.**

Darrell-James -2019 Oct. 28th :Manifest of :Bill of: Trespassing contract
:PINAL COUNTY/Pinal

2022-011769 MISC Page: 1436 of 2782
09/26/2022 03:35:37 PM Receipt #: 22-9381
Rec Fee: \$30.00 Darrell James Hill
Gila County, Az, Sadie Jo Bingham, Recorder



:Darrell- James: Hill, :executor
 c/o PO Box 3806
 Apache Junction, Arizona 85117

Contact: 602.618.4595

Document #: DJ-RE 322 399 225 US - 1
 Billing Day: October 28, 2019,
 Due Date: November 01, 2019
 Balance Due: 792,022 - :one- :U.S. silver, :in- specie

Billing Period: :April 5, 2017: 1700 hr, and ending on :October 7, 2019: 17:21:17 hr,

BILL Contract: : 2017 May-June 8th Contract: RMN RE 322 399 225 US

PINAL COUNTY/Pinal county
 Pinal county Supervisors
 c/o :Natasha: Clerk of the Board Kennedy
 135 N. Pinal street
 Administrative Complex
 Florence, Arizona 85132

Item	Description	Unit Cost	Quantity	Line Total	
1	TRESPASSING CONTRACT: RE 322 399 225 US	:April 5, 2017: 1700 hr, to :October 7, 2019: 17:21:17 hr,	:one- :U.S. Silver dollar, in- specie per minute	792,022 - minutes	792,022 -
2					
3					
4					
5					

If you have any questions concerning this bill, you have three days to make your questions or objections known.

Subtotal: :one- 792,022
 U.S. Silver dollar,
 in specie

Paid to Date: 0

Terms: Due Upon Receipt of :Bill

Balance Due: 792022

Handwritten signatures and numbers:
 12/28/19
 1434

Darrell-James -2019 Oct. 28th :Bill : Trespassing contract
 :PINAL COUNTY/Pinal

2022-011769 MISC Page: 1437 of 2782
 09/26/2022 03:35:37 PM Receipt #: 22-9381
 Rec Fee: \$30.00 Darrell James Hill
 Gila County, Az. Sadie Jo Bingham, Recorder



:2020 A.D.

#	:man- trustee	:association	:year, :day	USPO, other	:covenant
1	:Donald-John: Trump	:POTUS	05/18/20	~RE 047 610 440 US~ → RE 322 387 559 US ↓	:Equity-Claim: Presentment: Express-Trust: EBA-1933-A.D. - naked-Trust - RE 047 610 440 US -:May 15 th , 2020 A.D. for the account, settle and closure.
2	:Steve-Turner:Mnuchin c/o :Donald: Trump	U.S.- Department fo the Treasury- Secretary	↓ 05/18/20	~RE 047 610 440 US~ → RE 322 387 559 US ↓	↓
3	:William-Pelham: Barr c/o :Donald: Trump	U.S.- AG, APC, CLT	↓ 05/18/20	~RE 047 610 440 US~ → RE 322 387 559 US ↓	:Equity-Claim: Presentment: Express-Trust: EBA-1933-A.D. - naked-Trust - RE 047 610 440 US -:May 15 th , 2020 A.D. for the account, settle and closure.
4	:Jefferson: B.: Sessions III c/o :Donald: Trump	U.S.- AG, APC, CLT, ex- officio	↓ 05/18/20	~RE 047 610 440 US~ → RE 322 387 559 US ↓	↓
5	:Matthew-G.: Whitaker c/o :Donald: Trump	U.S.- AG, APC, CLT, ex- officio -acting	↓ 05/18/20	~RE 047 610 440 US~ → RE 322 387 559 US ↓	:Equity-Claim: Presentment: Express-Trust: EBA-1933-A.D. - naked-Trust - RE 047 610 440 US -:May 15 th , 2020 A.D. for the account, settle and closure.
	:man- trustee	:association	:year, :day	USPO, other	:covenant
6	:Dana: James- Boente c/o :Donald: Trump	U.S.- AG, APC, CLT, ex- officio -acting	↓ 05/18/20	~RE 047 610 440 US~ → RE 322 387 559 US ↓	↓
7	:Sally-C.: Yates c/o :Donald: Trump	U.S.- AG, APC, CLT, ex-	↓ 05/18/20	~RE 047 610 440 US~ → RE 322 387 559 US ↓	:Equity-Claim: Presentment: Express-Trust: EBA-1933-



					A.D. - naked-Trust - RE 047 610 440 US -:May 15 th , 2020 A.D. for the account, settle and closure.
8	:Steve-Turner:Mnuchin	U.S.- Department fo the Treaury- Secretary	05/19/20	7008 1300 0002 2256 4705	↓
9	:William-Pelham: Barr c/o :Donald: Trump	U.S.- AG, APC, CLT	↓ 05/19/20	RE 047 610 438 US	↓ :Equity-Claim: Presentment: Express-Trust: EBA-1933-A.D. - naked-Trust - RE 047 610 440 US -:May 15 th , 2020 A.D. for the account, settle and closure.
10	:man- trustee	:association	:year, :day	USPO, other	:covenant
11	:Joshep: Dedman, Jr. c/o :Mark: Lamb, -:Sheriff, -:Pinal	:Apache-County- Arizona-State, -:Sheriff	05/20/20	RE 322 387 545 US cc: First Class Mail	↓ Re: USPO RMN ~RE 047 610 440 US~ → RE 322 387 559 US; See: Equity-Claim: Presentment: Express-Trust: EBA-1933-A.D. - naked-Trust - RE 047 610 440 US -:May 15 th , 2020 A.D. for the account, settle and closure.
12	:Mark: Dannels c/o :Mark: Lamb, -:Sheriff, -:Pinal	:Cochise-County- Arizona-State, -:Sheriff	05/20/20	RE 322 387 545 US cc: First Class Mail	↓
13	:Jim: Driscol c/o :Mark: Lamb, -:Sheriff, -:Pinal	:Coconino-County- Arizona-State, -:Sheriff	05/20/20	RE 322 387 545 US cc: First Class Mail	↓ Re: USPO RMN ~RE 047 610 440 US~ → RE 322 387 559 US; See: Equity-Claim: Presentment: Express-Trust: EBA-1933-A.D. - naked-Trust - RE 047 610 440 US -:May 15 th , 2020 A.D. for the account, settle and closure.

2022-011769 MISC Page: 1439 of 2782
 09/26/2022 03:35:37 PM Receipt #: 22-9381
 Rec Fee: \$30.00 Darrell James Hill
 Gila County, Az, Sadie Jo Bingham, Recorder



141

	:man- trustee	:association	:year, :day	USPO, other	:covenant
14	:Adam: Shephard c/o :Mark: Lamb, -:Sheriff, -:Pinal	:Gila-County-Arizona- State, -:Sheriff	05/20/20	RE 322 387 545 US cc: First Class Mail	↓
15	:Preston: Allread c/o :Mark: Lamb, -:Sheriff, -:Pinal	:Graham-County- Arizona-State, -:Sheriff	05/20/20	RE 322 387 545 US cc: First Class Mail	↓
16	:Tim: Sumner c/o :Mark: Lamb, -:Sheriff, -:Pinal	:Greenlee-County- Arizona-State, -:Sheriff	05/20/20	RE 322 387 545 US cc: First Class Mail	↓ Re: USPO RMN ~RE 047 610 440 US~ → RE 322 387 559 US; See: Equity-Claim: Presentment: Express- Trust: EBA-1933-A.D. - naked-Trust - RE 047 610 440 US -:May 15 th , 2020 A.D. for the account, settle and closure.
17	:Bill: Risen c/o :Mark: Lamb, -:Sheriff, -:Pinal	:La- Paz -County- Arizona-State, -:Sheriff	05/20/20	RE 322 387 545 US cc: First Class Mail	↓
18	:Paul: Penzone c/o :Mark: Lamb, -:Sheriff, -:Pinal	:Maricopa-County- Arizona-State, -:Sheriff	05/20/20	RE 322 387 545 US cc: First Class Mail	↓
19	:Doug: Schuster c/o :Mark: Lamb, -:Sheriff, -:Pinal	:Mohave-County- Arizona-State, -:Sheriff	05/20/20	RE 322 387 545 US cc: First Class Mail	↓ Re: USPO RMN ~RE 047 610 440 US~ → RE 322 387 559 US; See: Equity-Claim: Presentment: Express- Trust: EBA-1933-A.D. - naked-Trust - RE 047 610 440 US -:May 15 th , 2020 A.D. for the account, settle and closure.

2022-011769 MISC Page: 1440 of 2782
 09/26/2022 03:35:37 PM Receipt #: 22-9381
 Rec Fee: \$30.00 Darrell James Hill
 Gila County, Az, Sadie Jo Bingham, Recorder



1
CM1

	:man- trustee	:association	:year, :day	USPO, other	:covenant
20	:David: Clouse c/o :Mark: Lamb, -:Sheriff, -:Pinal	:Navajo-County-Arizona- State, -:Sheriff	05/20/20	RE 322 387 545 US cc: First Class Mail	↓
21	:Mark: Napier c/o :Mark: Lamb, -:Sheriff, -:Pinal	:Pima-County-Arizona- State, -:Sheriff	05/20/20	RE 322 387 545 US cc: First Class Mail	↓
22	:Tony: Estrada c/o :Mark: Lamb, -:Sheriff, -:Pinal	:Santa-Criz-County- Arizona-State, -:Sheriff	05/20/20	RE 322 387 545 US cc: First Class Mail	↓
23	:Scott: Mascher c/o :Mark: Lamb, -:Sheriff, -:Pinal	Yavapai-County-Arizona- State, -:Sheriff	05/20/20	RE 322 387 545 US cc: First Class Mail	↓

	:man- trustee	:association	:year, :day	USPO, other	:covenant
24	Leon: Wilmot c/o :Mark: Lamb, -:Sheriff, -:Pinal	:Yuma-County-Arizona- State, -:Sheriff	05/20/20	RE 322 387 545 US cc: First Class Mail	↓ Re: USPO RMN ~RE 047 610 440 US~ → RE 322 387 559 US; See: Equity-Claim: Presentment: Express- Trust: EBA-1933-A.D. - naked-Trust - RE 047 610 440 US -:May 15 th , 2020 A.D. for the account, settle and closure.
25	:Mark: Lamb	:Pinal-County-Arizona- State, -:Sheriff	05/20/20	RE 322 387 545 US	↓ Re: USPO RMN ~RE 047 610 440 US~ → RE 322 387 559 US; See: Equity-Claim: Presentment: Express-

2022-011769 MISC Page: 1441 of 2782
 09/26/2022 03:35:37 PM Receipt #: 22-9381
 Rec Fee: \$30.00 Darrell James Hill
 Gila County, Az, Sadie Jo Bingham, Recorder



Handwritten initials: *scm*

Trust: EBA-1933-A.D. - naked-Trust - RE 047 610 440 US -:May 15th, 2020 A.D. for the account, settle and closure.

26 :Ryan-N.: Dooley :La Paz-County-Arizona-State, -:Attorney- Chief-Deputy 06/01/20 Standard Mail. :Darrell-James: Hill -Ohioan -beneficiary, -:Executor: DOI-1776-A.D; :beneficiary- Executor: EBA-1933-A.D.

'I -Ryan am- returning the -RE 322 387 545 US c/o :Mark: Lamb, -:Sheriff, -:Pinal-County-Arizona-State, -:Sheriff and cc: First-Class-Mail -documents- received to the man: :Bill: Risen, -:La- Paz-County-Arizona-State- Sheriff. - Enc. Fictitious documents.'

27	:man- trustee	:association	:year, :day	USPO, other	:covenant
28	:John-Earl: Hyten c/o :Alexander: Milley	United-States-of- America-1787-A.D. ~USofA~ -military- General	↓ 06/09/20	~RE 047 610 440 US~ → RE 322 387 559 US cc: RE 047 610 512 US	↓ :Equity-Claim: Presentment: Express-Trust: EBA-1933- A.D. - naked-Trust - RE 047 610 440 US -:May 15 th , 2020 A.D. for the account, settle and closure.
29	:James-Charles: McConville c/o :Alexander: Milley	USofA- military- General	↓ 06/09/20	~RE 047 610 440 US~ → RE 322 387 559 US cc: RE 047 610 512 US	↓
30	:David-Hilberry: Berger c/o :Alexander: Milley	USofA- military- General	↓ 06/09/20	~RE 047 610 440 US~ → RE 322 387 559 US cc: RE 047 610 512 US	↓
31	:Michael-Martin-Gilday c/o :Alexander: Milley	USofA- military- Admiral	↓ 06/09/20	~RE 047 610 440 US~ → RE 322 387 559 US cc: RE 047 610 512 US	↓ :Equity-Claim: Presentment: Express-Trust: EBA-1933- A.D. - naked-Trust - RE 047 610 440 US -:May 15 th ,

2022-011769 MISC Page: 1442 of 2782
 09/26/2022 03:35:37 PM Receipt #: 22-9381
 Rec Fee: \$30.00 Darrell James Hill
 Gila County, Az, Sadie Jo Bingham, Recorder



10/11

2020 A.D. for the account, settle and closure.

32 :David-Lee: Goldfein USofA- military- General ↓ ~RE 047 610 440 US~ →
 c/o :Alexander: Milley 06/09/20 RE 322 387 559 US
 cc: RE 047 610 512 US

33 :John-William: Raymond USofA- military- General ↓ ~RE 047 610 440 US~ →
 c/o :Alexander: Milley 06/09/20 RE 322 387 559 US
 cc: RE 047 610 512 US

:Equity-Claim: Presentment: Express-Trust: EBA-1933-A.D. - naked-Trust - RE 047 610 440 US -:May 15th, 2020 A.D. for the account, settle and closure.

:man- trustee :association :year, :day USPO, other :covenant

34 :Joseph-Lauren: Lengyel USofA- military- General ↓ ~RE 047 610 440 US~ →
 c/o :Alexander: Milley 06/09/20 RE 322 387 559 US
 cc: RE 047 610 512 US

35 :Karl-Leo: Schultz USofA- military- Admiral ↓ ~RE 047 610 440 US~ →
 c/o :Alexander: Milley 06/09/20 RE 322 387 559 US
 cc: RE 047 610 512 US

36 :Mark-Alexander: Milley USofA- military- General 06/09/20 ~RE 047 610 440 US~ →
 RE 322 387 559 US
 cc: RE 047 610 512 US

:Equity-Claim: Presentment: Express-Trust: EBA-1933-A.D. - naked-Trust - RE 047 610 440 US -:May 15th, 2020 A.D. for the account, settle and closure.

37 :Ryan-N.: Dooley :La-Paz- County- 06/15/20 7012 2210 0000 4269 7391
 c/o: Tony: Rogers Arizona-State, -:Attorney
 -Chief-Deputy;
 c/o: La-Paz- County-
 Arizona-State, -:Attorney

Darrell-James: Hill -Ohioan -beneficiary, -:Executor: DOI-1776-A.D; :beneficiary- Executor: EBA-1933-A.D. constitutional-office-oath

2022-011769 MISC Page: 1443 of 2782
 09/26/2022 03:35:37 PM Receipt #: 22-9381
 Rec Fee: \$30.00 Darrell James Hill
 Gila County, Az, Sadie Jo Bingham, Recorder



	:man- trustee	:association	:year, :day	USPO, other	:covenant
					; constitutional-offices.
38	:Michael: Whiting	:Apache- County- Arizona-State, -:Attorney	↓	7012 2210 0000 4269 7391 cc: First-Class-Mail	↓
39	:William-P.: Ring	:Coconino- County- Arizona-State, -:Attorney	06/15/20	7012 2210 0000 4269 7391 cc: First-Class-Mail	Darrell-James: Hill -Ohioan -beneficiary, -:Executor: DOI-1776-A.D; :beneficiary- Executor: EBA-1933-A.D. constitutional-office-oath
40	:Sheila: Polk	:Yavapai- County- Arizona-State, -:Attorney	↓	7012 2210 0000 4269 7391 cc: First-Class-Mail	↓
41	:Jeremy: Ford	:Greenlee- County- Arizona-State, -:Attorney	↓	7012 2210 0000 4269 7391 cc: First-Class-Mail	↓
42	:Allister: Adel	:Maricopa- County- Arizona-State, -:Attorney	↓	7012 2210 0000 4269 7391 cc: First-Class-Mail	↓
43	:Barbara: LaWall	:Pima- County-Arizona-State, -:Attorney	06/15/20	7012 2210 0000 4269 7391 cc: First-Class-Mail	Darrell-James: Hill -Ohioan -beneficiary, -:Executor: DOI-1776-A.D; :beneficiary- Executor: EBA-1933-A.D. constitutional-office-oath
44	:Brad: Carlyon	:Navajo- County- Arizona-State, -:Attorney	↓	7012 2210 0000 4269 7391 cc: First-Class-Mail	↓
45	:Bradley-D.: Beauchamp	:Gila- County-Arizona-State, -:Attorney	↓	7012 2210 0000 4269 7391 cc: First-Class-Mail	↓
46	:George: Silva	:Santa-Cruz- County-	06/15/20	7012 2210 0000 4269 7391	↓

2022-011769 MISC Page: 1444 of 2782
 09/26/2022 03:35:37 PM Receipt #: 22-9381
 Rec Fee: \$30.00 Darrell James Hill
 Gila County, Az, Sadie Jo Bingham, Recorder



Handwritten initials: JHM

		Arizona-State, -:Attorney		cc: First-Class-Mail	
47	:Brian: McIntyre	:Cochise- County- Arizona-State, -:Attorney	↓	7012 2210 0000 4269 7391 cc: First-Class-Mail	↓
	:man- trustee	:association	:year, :day	USPO, other	:covenant
48	:Kent: Volkmer	:Pinal- County-Arizona- State, -:Attorney	↓	7012 2210 0000 4269 7391 cc: First-Class-Mail	↓
49	:Matthew-J.: Smith	:Mohave- County- Arizona-State, -:Attorney	↓	7012 2210 0000 4269 7391 cc: First-Class-Mail	Darrell-James: Hill -Ohioan -beneficiary, -:Executor: DOI-1776-A.D; :beneficiary- Executor: EBA-1933-A.D. constitutional-office-oath
50	:Kenny: Angle	:Graham- County- Arizona-State, -:Attorney	06/15/20	7012 2210 0000 4269 7391 cc: First-Class-Mail	↓
51	:Jon-R.: Smith	:Yuma- County-Arizona- State, -:Attorney	06/15/20	7012 2210 0000 4269 7391 cc: First-Class-Mail	↓
52	:Mark: Brnovich	:Arizona-State-Attorney- General	↓ 06/15/20	7012 2210 0000 4269 7391 cc: 7009 2820 0003 8851 6032	↓ Darrell-James: Hill -Ohioan -beneficiary, -:Executor: DOI-1776-A.D; :beneficiary- Executor: EBA-1933-A.D. constitutional-office-oath
	:man- trustee	:association	:year, :day	USPO, other	:covenant
53	:Ryan-N.: Dooley c/o: Tony: Rogers	:La-Paz- County- Arizona-State, -:Attorney -Chief-Deputy	06/17/20	Standard Mail.	Darrell-James: Hill -Ohioan -beneficiary, -:Executor: DOI-1776-A.D; :beneficiary- Executor: EBA-1933-A.D. - constitutional-office-oath -



Handwritten number 2471

'I -Ryan am- returning the -:7012 2210 0000 4269 7391 -documents that you-beneficiary-mailed to my office (again)'

54 :Doug: Ducey :Arizona-State-Governor 06/23/20 RE 047 610 526 US
c/o :Katie: Hobbs

Darrell-James: Hill -Ohioan -beneficiary, -:Executor: DOI-1776-A.D; :beneficiary- Executor: EBA-1933-A.D.

constitutional-office-oath
:Specialized-Negotiable-Instrument- RE 047 610 526 US for the restoration of the automobile- MSO- equivalent to the man: Darrell-James: Hill and Beverly- Jean: Romero- Hill, -:exclusive-peculiar-absolute- owners of the automobiles, -:verified- title#s:
1) # K015013311014 / VIN- 22D42408S6936 ;
2) # K015013311011 / VIN- 1FTHX26H6FKB58041 ;
3) # K015013311008 / VIN- 1G8EK16L1GF207716 ;
4) # 17AK011018008 / VIN- 1GBKP37W3H3313848 .

55 :Katie: Hobbs :Arizona-State-Secretary 06/23/20 RE 047 610 526 US
:man- trustee :association :year, :day USPO, other :covenant

56 :John: Halikowski :Arizona-State- 06/23/20 7009 1410 0000 7868 5796
c/o: Scott: Omer Department of Transportation, -:Director

57 :Time: Lane :Arizona-State- 06/23/20 7009 1410 0000 7868 5796
c/o: Scott: Omer Enforcement and Compliance-Division, -:Director

2022-011769 MISC Page: 1446 of 2782
09/26/2022 03:35:37 PM Receipt #: 22-9391
Rec Fee: \$30.00 Darrell James Hill
Gila County, Az, Sadie Jo Bingham, Recorder



Handwritten signature/initials

58 :Scott: Omer :Arizona-State- Department of Transportation, -:COO 06/23/20 7009 1410 0000 7868 5796

Darrell-James: Hill -Ohioan -beneficiary, -:Executor: DOI-1776-A.D.; :beneficiary- Executor: EBA-1933-A.D.

constitutional-office-oath :Specialized-Negotiable-Instrument- RE 047 610 526 US for the restoration of the automobile- MSO- equivalent to the man: Darrell-James: Hill and Beverly- Jean: Romero- Hill, -:exclusive-peculiar-absolute- owners of the automobiles, -:verified- title#s: 1) # K015013311014 / VIN- 22D42408S6936 ; 2) # K015013311011 / VIN- 1FTHX26H6FKB58041 ; 3) # K015013311008 / VIN- 1G8EK16L1GF207716 ; 4) # 17AK011018008 / VIN- 1GBKP37W3H3313848 .

:man- trustee :association :year, :day USPO, other

:covenant

59 :Jorge-Mario: Bergoglio :Trustee: Concession- 1213-A.D. 07/24/20 RE 322 387 576 US

:Darrell-James: Hill, -:Ohioan- beneficiary- Executor: DOI-1776-A.D., -Treaty-of-Paris-1783-A.D., -: Concession-1213-A.D.

60 :Donald-Trump POTUS 07/24/20 ~RE 322 387 562 US~ → RE 322 398 401 US

:Darrell-James: Hill, -:Ohioan- beneficiary- Executor: DOI-1776-A.D., -Treaty-of-Paris-1783-A.D., -: Concession-1213-A.D.

:Special-Presentment, ~ Book; ;A) i- man- :ambasador- of the Almighty-God give you ;notice... ;



Handwritten signature

B. :Introduction. :i- man -Ysrael-Yudah- Ohioan- beneficiary- Executor: DOI-1776-A.D.; -:Ambassador of the Almighty- God, -:Trustee: Concession-1213- A.D.; -: beneficiary-Executor: EBA-1933-A.D. B#1) Affidavit of Distress; B#2) Declaration of :Claim and Demand for the Restoration of the property-claimed and possessed by :i- man

61 :Mark-Alexander: Milley USofA- military- General 09/21/20 RE 322 357 580 US
c/o :James-Charles: McConville

:Regarding: Stolen—Property- claimed and possessed ..., stolen by the POTUS, et al., aided and abetted by :you, et al.

Attached is the 'Special-Presentment ~Book 9' -> ~RE 322 387 562 US~ → RE 322 398 401 US

62 :John-Earl: Hyten United-States-of- America-1787-A.D. 09/21/20 RE 322 357 580 US
c/o :James-Charles: McConville ~USofA~ -military- General

:Regarding: Stolen—Property- claimed and possessed ..., stolen by the POTUS, et al., aided and abetted by :you, et al.

Attached is the 'Special-Presentment ~Book 9' -> ~RE 322 387 562 US~ → RE 322 398 401 US

63 :David-Hilberry: Berger USofA- military- General
c/o :James-Charles: McConville

64 :Michael-Martin-Gilday USofA- military- Admiral 09/21/20 RE 322 357 580 US
c/o :James-Charles:

:Regarding: Stolen—Property- claimed and possessed

2022-011769 MISC Page: 1448 of 2782
09/26/2022 03:35:37 PM Receipt #: 22-9381
Rec Fee: \$30.00 Darrell James Hill
Gila County, Az, Sadie Jo Bingham, Recorder



5/11/21

McConville

..., stolen by the POTUS, et al., aided and abetted by :you, et al.

Attached is the 'Special-Presentment ~Book 9' -> ~RE 322 387 562 US~ -> RE 322 398 401 US

65	:man- trustee	:association	:year, :day	USPO, other	:covenant
----	---------------	--------------	-------------	-------------	-----------

66	:David-Lee: Goldfein c/o :James-Charles: McConville	USofA- military- General	↓	↓	↓
----	---	--------------------------	---	---	---

67	:John-William: Raymond c/o :James-Charles: McConville	USofA- military- General	↓ 09/21/20	↓ RE 322 357 580 US	↓
----	---	--------------------------	---------------	------------------------	---

68	:Joseph-Lauren: Lengyel c/o :James-Charles: McConville	USofA- military- General	↓	↓	↓
----	--	--------------------------	---	---	---

:Regarding: Stolen—Property- claimed and possessed ..., stolen by the POTUS, et al., aided and abetted by :you, et al.

Attached is the 'Special-Presentment ~Book 9' -> ~RE 322 387 562 US~ -> RE 322 398 401 US

69	:Karl-Leo: Schultz c/o :James-Charles: McConville	USofA- military- Admiral	↓	↓	↓
----	---	--------------------------	---	---	---

70	:James-Charles: McConville	USofA- military- Admiral	↓ 09/21/20	↓ RE 322 357 580 US	
----	-------------------------------	--------------------------	---------------	------------------------	--

:Regarding: Stolen—Property- claimed and possessed ..., stolen by the POTUS, et al., aided and abetted by :you, et al.

2022-011769 MISC Page: 1449 of 2782
 09/26/2022 03:35:37 PM Receipt #: 22-9381
 Rec Fee: \$30.00 Darrell James Hill
 Gila County, Az. Sadie Jo Bingham, Recorder



Handwritten initials/signature

Attached is the 'Special-Presentment ~Book 9' ->
~RE 322 387 562 US~ → RE 322 398 401 US

	:man- trustee	:association	:year, :day	USPO, other	:covenant
71	:David: Richards c/o :Anthony: Harking	:Crown, :in- chancery, -:Lincoln's-Inn	10/14/20	First Class Mail	:Concession-1213-A.D., -:Treaty-of-Paris-1783-A.D. → DOI-1776-A.D. :Specialty-Presentment: USPO-RMN: RE 322 387 593 US – Re: a) man-Trustee-Derelict: Concession-1213- A.D.- :Jorge: Mario: RE 322 387 576 US; b) Almihty- God, change of Trustee: Concession-1213-A.D. to the :- man- named; c) :Restoration
72	:Brian: Leveson c/o :Anthony: Harking	:Crown, :in- chancery, -:Middle- Temple	↓ 10/14/20	↓	↓
73	:Guy: Fetherstonhaugh c/o: :Anthony: Harking	:Crown, :in- chancery, -:Inner -Temple	↓	↓ First Class Mail	↓
74	:Anthony: Harking	:Crown, :in- chancery, -:Gray's -Inn	↓ 10/14/20	↓ RE 322 387 593 US	↓ :Concession-1213-A.D., -:Treaty-of-Paris-1783-A.D. → DOI-1776-A.D.
75	:Donald-John: Trump	:POTUS	↓	↓ First Class Mail	↓
76	:Michael-R.: Pompeo c/o: Lisa-D: Kenna	:U.S.-State, -:Secretary c/o: :U.S.-State, -:Secretary, -:Exec.- Sec.	↓ 10/14/20	↓ RE 322 398 392 US	↓ :Concession-1213-A.D., -:Treaty-of-Paris-1783-A.D. → DOI-1776-A.D. :Specialty-Presentment: USPO-RMN: RE 322 387 593

2022-011769 MISC Page: 1450 of 2782
 09/26/2022 03:35:37 PM Receipt #: 22-9381
 Rec Fee: \$30.00 Darrell James Hill
 Gila County, Az, Sadie Jo Bingham, Recorder



Handwritten signature

US – Re: a) man-Trustee-Derelict: Concession-1213-A.D.- :Jorge: Mario: RE 322 387 576 US; b) Almihty-God, change of Trustee: Concession-1213-A.D. to the :i- man- named; c) :Restoration

	:man- trustee	:association	:year, :day	USPO, other	:covenant
77	:Donald-John: Trump	:POTUS	11/10/20	RE 322 387 547 US	:Bill-of-Particulars: Lot-1: updated to 12/13/21, :Bill-of-Particulars: Lot-2: updated to 12/13/21; :Bill-of-Particulars: Lot-3: updated to 12/13/21; for the remedy with the exclusive-right-due to the harm with the law of the covenants by the law of the covenants: DOI-1776-A.D., PE-2016-A.D., -covenants: Lot 1, 2, 3.
78	:Mark-Alexander: Milley c/o :James-Charles: McConville	USofA- military- General	↓	RE 322 387 633 US	↓
79	:John-Earl: Hyten c/o :James-Charles: McConville	United-States-of- America-1787-A.D. ~USofA~ -military- General	↓ 11/10/20	↓ RE 322 387 633 US	↓ :Bill-of-Particulars: Lot-1: updated to 12/13/21, :Bill-of-Particulars: Lot-2: updated to 12/13/21; :Bill-of-Particulars: Lot-3: updated to 12/13/21; for the remedy with the exclusive-right-due to the harm with the law of the covenants by the law of the covenants: DOI-1776-A.D., PE-2016-A.D., -covenants: Lot 1, 2, 3.
80	:David-Hilberry: Berger c/o :James-Charles: McConville	USofA- military- General	↓	↓	↓

2022-011769 MISC Page: 1451 of 2782
 09/26/2022 03:35:37 PM Receipt #: 22-9381
 Rec Fee: \$30.00 Darrell James Hill
 Gila County, Az, Sadie Jo Bingham, Recorder



Handwritten signature

81	:Michael-Martin-Gilday c/o :James-Charles: McConville	USofA- military- Admiral	↓	↓	↓
	:man- trustee	:association	:year, :day	USPO, other	:covenant
82	:David-Lee: Goldfein c/o :James-Charles: McConville	USofA- military- General	↓ 11/10/20	↓ RE 322 387 633 US	↓ :Bill-of-Particulars: Lot-1: updated to 12/13/21, :Bill-of-Particulars: Lot-2: updated to 12/13/21; :Bill-of-Particulars: Lot-3: updated to 12/13/21; for the remedy with the exclusive-right-due to the harm with the law of the covenants by the law of the covenants: DOI-1776-A.D., PE-2016-A.D., -covenants: Lot 1, 2, 3.
83	:John-William: Raymond c/o :James-Charles: McConville	USofA- military- General	↓	↓	↓
84	:Joseph-Lauren: Lengyel c/o :James-Charles: McConville	USofA- military- General	↓ 11/10/20	↓ RE 322 387 633 US	↓
85	:Karl-Leo: Schultz c/o :James-Charles: McConville	USofA- military- Admiral	↓	↓	↓
86	:James-Charles: McConville	USofA- military- Admiral	↓ 11/10/20	↓ RE 322 387 633 US	↓ :Bill-of-Particulars: Lot-1: updated to 12/13/21, :Bill-of-Particulars: Lot-2: updated to 12/13/21; :Bill-of-Particulars: Lot-3: updated to 12/13/21; for the remedy with the exclusive-right-due to the harm with the law of



Handwritten signature

the covenants by the law of the covenants: DOI-1776-A.D., PE-2016-A.D., -covenants: Lot 1, 2, 3.

	:man- trustee	:association	:year, :day	USPO, other	:covenant
87	:Joshep: Dedman, Jr. c/o :Mark: Lamb, -:Sheriff, -:Pinal	:Apache-County- Arizona-State, -:Sheriff	↓ 11/10/20	↓ First Class Mail.	↓ :Bill-of-Particulars: Lot-1: updated to 12/13/21, :Bill-of-Particulars: Lot-2: updated to 12/13/21; :Bill-of-Particulars: Lot-3: updated to 12/13/21; for the remedy with the exclusive-right-due to the harm with the law of the covenants by the law of the covenants: DOI-1776-A.D., PE-2016-A.D., -covenants: Lot 1, 2, 3.
88	:Mark: Dannels c/o :Mark: Lamb, -:Sheriff, -:Pinal	:Cochise-County- Arizona-State, -:Sheriff	↓ 11/10/20	↓ First Class Mail.	↓ :Bill-of-Particulars: Lot-1: updated to 12/13/21, :Bill-of-Particulars: Lot-2: updated to 12/13/21; :Bill-of-Particulars: Lot-3: updated to 12/13/21; for the remedy with the exclusive-right-due to the harm with the law of the covenants by the law of the covenants: DOI-1776-A.D., PE-2016-A.D., -covenants: Lot 1, 2, 3.
89	:Jim: Driscol c/o :Mark: Lamb, -:Sheriff, -:Pinal	:Coconino-County- Arizona-State, -:Sheriff	↓	↓	↓
90	:Adam: Shephard c/o :Mark: Lamb, -:Sheriff, -:Pinal	:Gila-County-Arizona- State, -:Sheriff	↓	↓	↓
91	:Preston: Allread c/o :Mark: Lamb, -:Sheriff,	:Graham-County- Arizona-State, -:Sheriff	↓	↓	↓

2022-011769 MISC Page: 1453 of 2782
 09/26/2022 03:35:37 PM Receipt #: 22-9381
 Rec Fee: \$30.00 Darrell James Hill
 Gila County, Az, Sadie Jo Bingham, Recorder



Handwritten signature or initials.

:-Pinal

:man- trustee

:association

:year, :day

USPO, other

:covenant

92

:Tim: Sumner
c/o :Mark: Lamb, -:Sheriff,
:-Pinal

:Greenlee-County-
Arizona-State, -:Sheriff

↓
11/10/20

↓
First Class Mail.

↓
:Bill-of-Particulars: Lot-1: updated to 12/13/21, :Bill-of-
Particulars: Lot-2: updated to 12/13/21; :Bill-of-
Particulars: Lot-3: updated to 12/13/21; for the remedy
with the exclusive-right-due to the harm with the law of
the covenants by the law of the covenants: DOI-1776-
A.D., PE-2016-A.D., -covenants: Lot 1, 2, 3.

:Bill: Risen
c/o :Mark: Lamb, -:Sheriff,
:-Pinal

:La- Paz -County-
Arizona-State, -:Sheriff

↓

↓

↓

92

:Paul: Penzone
c/o :Mark: Lamb, -:Sheriff,
:-Pinal

:Maricopa-County-
Arizona-State, -:Sheriff

↓

↓

↓

93

:Doug: Schuster
c/o :Mark: Lamb, -:Sheriff,
:-Pinal

:Mohave-County-
Arizona-State, -:Sheriff

↓

↓

↓

94

:David: Clouse
c/o :Mark: Lamb, -:Sheriff,
:-Pinal

:Navajo-County-Arizona-
State, -:Sheriff

↓
11/10/20

↓
First Class Mail.

↓
:Bill-of-Particulars: Lot-1: updated to 12/13/21, :Bill-of-
Particulars: Lot-2: updated to 12/13/21; :Bill-of-
Particulars: Lot-3: updated to 12/13/21; for the remedy
with the exclusive-right-due to the harm with the law of
the covenants by the law of the covenants: DOI-1776-
A.D., PE-2016-A.D., -covenants: Lot 1, 2, 3.



1971

	:man- trustee	:association	:year, :day	USPO, other	:covenant
95	:Mark: Napier c/o :Mark: Lamb, -:Sheriff, -:Pinal	:Pima-County-Arizona- State, -:Sheriff	↓	↓	↓
96	:Tony: Estrada c/o :Mark: Lamb, -:Sheriff, -:Pinal	:Santa-Criz-County- Arizona-State, -:Sheriff	↓	↓	↓
97	:Scott: Mascher c/o :Mark: Lamb, -:Sheriff, -:Pinal	Yavapai-County-Arizona- State, -:Sheriff	11/10/20	↓ First Class Mail.	↓ :Bill-of-Particulars: Lot-1: updated to 12/13/21, :Bill-of- Particulars: Lot-2: updated to 12/13/21; :Bill-of- Particulars: Lot-3: updated to 12/13/21; for the remedy with the exclusive-right-due to the harm with the law of the covenants by the law of the covenants: DOI-1776- A.D., PE-2016-A.D., -covenants: Lot 1, 2, 3.
98	Leon: Wilmot c/o :Mark: Lamb, -:Sheriff, -:Pinal	:Yuma-County-Arizona- State, -:Sheriff	↓	↓	↓
99	:man c/o :Mark: Lamb, -:Sheriff, -:Pinal	:RTCC	↓	↓	↓
	:man- trustee	:association	:year, :day	USPO, other	:covenant
100	:Mark: Lamb	:Pinal-County-Arizona- State, -:Sheriff	11/10/20	↓ First Class Mail.	↓ :Bill-of-Particulars: Lot-1: updated to 12/13/21, :Bill-of- Particulars: Lot-2: updated to 12/13/21; :Bill-of-

2022-011769 MISC Page: 1455 of 2782
 09/26/2022 03:35:37 PM Receipt #: 22-9381
 Rec Fee: \$30.00 Darrell James Hill
 Gila County, Az, Sadie Jo Bingham, Recorder



15941

Particulars: Lot-3: updated to 12/13/21; for the remedy with the exclusive-right-due to the harm with the law of the covenants by the law of the covenants: DOI-1776-A.D., PE-2016-A.D., -covenants: Lot 1, 2, 3.

	:man- trustee	:association	:year, :day	USPO, other	:covenant
101	:Stephen-G.: Breyer, et al.; c/o: Scott-Sessions: Harris	:Justices SCOTUS :Clerk SCOTUS	12/11/20	RE 322 387 616 US	:Darrell-James: Hill, -:Ohioan- beneficiary- Executor: DOI-1776-A.D. -:Treaty-of-Paris-1783-A.D., -:Concession-1213-A.D.; beneficiary- Executor: EBA- 1933-A.D.; Ambassador of the Almighty-God, -:Trustee: Concession-1213-A.D. ~ -2020-A.D. :Right of -:Conusance :Authorization for the Restoration of the Lawful- Government
102	:Donald-John: Trump	:POTUS	↓ 12/11/20 ~11/30/20~	RE 322 387 620 US	↓
	:William: Pelham: Barr c/o :Donald: Trump	:US- AG, APC, CLT	↓ 12/11/20 ~11/23/20~	RE 322 387 620 US	↓
	:James-Charles: McConville, et al.	USofA- military- General	↓ 12/11/20 ~11/23/20~	7012 2210 0000 4269 7353	↓

2022-011769 MISC Page: 1456 of 2782
 09/26/2022 03:35:37 PM Receipt #: 22-9381
 Rec Fee: \$30.00 Darrell James Hill
 Gila County, Az, Sadie Jo Bingham, Recorder



EJH

	:man- trustee	:association	:year, :day	USPO, other	:covenant
103	:Stephen-G.: Breyer, et al. c/o: Scott-Sessions: Harris	:Justices SCOTUS, :Clerk	↓ 12/23/20 ~11/30/20~	7012 2210 0000 4269 7360	↓ :Darrell-James: Hill, -:Ohioan- beneficiary- Executor: DOI-1776-A.D. -:Treaty-of-Paris-1783-A.D., -:Concession-1213-A.D.; beneficiary- Executor: EBA- 1933-A.D.; Ambassador of the Almighty-God, -:Trustee: Concession-1213-A.D. ~ -2020-A.D. :Right of -:Conusance :Authorization for the Restoration of the Lawful- Government
104	:Mark: Lamb, et al. c/o: Mark: Lamb	:Arizona-State-County- Sheriffs	↓ 12/11/20 ~11/23/20~	7012 2210 0000 4269 7377	↓
105	:Ken: Paxton, et al.	:Texas-State, - :AG	↓ 12/11/20	email	↓
106	:John-Bartley: DeLone	Pannsylvania-State, -:AG		email	↓ :Darrell-James: Hill, -:Ohioan- beneficiary- Executor: DOI-1776-A.D. -:Treaty-of-Paris-1783-A.D., -:Concession-1213-A.D.; beneficiary- Executor: EBA- 1933-A.D.; Ambassador of the Almighty-God, -:Trustee: Concession-1213-A.D. ~ -2020-A.D. :Right of -:Conusance

2022-011769 MISC Page: 1457 of 2782
 09/26/2022 03:35:37 PM Receipt #: 22-9391
 Rec Fee: \$30.00 Darrell James Hill
 Gila County, Az, Sadie Jo Bingham, Recorder



KSH

:Authorization for the Restoration of the Lawful-Government

107 :Andrew-Alan: Pinson, et al. :Georgia-State, -:AG

email

↓

:man- trustee

:association

:year, :day

USPO, other

:covenant

108 :Donald-W.: MacPherson, et al. :Idaho-State-Elected-Office
:Janice: McGeachin,
:Lora: Reinbold,
:David: Eastment, et al.

↓
12/11/20

email

↓

109 :John-C.: Eastman, et al., :POTUS
:Donald-J.: Trump

↓
12/11/20

email

↓

110 :John-Allen: Eldsmoe, et al. :Consitutional-Attorneys

email

↓

:Darrell-James: Hill, -:Ohioan- beneficiary- Executor: DOI-1776-A.D. -:Treaty-of-Paris-1783-A.D., -:Concession-1213-A.D.; beneficiary- Executor: EBA-1933-A.D.; Ambassador of the Almighty-God, -:Trustee: Concession-1213-A.D. ~ -2020-A.D.

:Right of -:Conusance

:Authorization for the Restoration of the Lawful-Government

111 :Erick-G.: Kaardal, et al., :Ron-Heuer, et al.
:Ron: Heuer, et al.

email

↓

2022-011769 MISC Page: 1458 of 2782
09/26/2022 03:35:37 PM Receipt #: 22-9381
Rec Fee: \$30.00 Darrell James Hill
Gila County, Az, Sadie Jo Bingham, Recorder

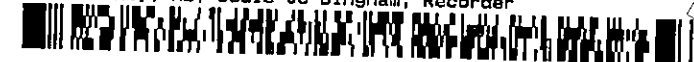

Handwritten signature/initials

112	:Jason-Brett: Torchinsky, et al	:Pennsylvania-State, -:Senators		email	↓
	:man- trustee	:association	:year, :day	USPO, other	:covenant
113	:Dennis: Grossman, et al.	:Christian-Family-Coalition	↓ 12/11/20	email	↓
114	:Phillip-L.: Jauregui Jr., et al.	:U.S.- Representative-members	↓	email	↓
115	:Nathaniel-Kyle: MacPherson, et al., :Janice: McGeachin, :Lora: Reinbold :David: Eastman, et al.	:State-Officers- Elected	↓	email	↓ :Darrell-James: Hill, -:Ohioan- beneficiary- Executor: DOI-1776-A.D. -:Treaty-of-Paris-1783-A.D., -:Concession-1213-A.D.; beneficiary- Executor: EBA-1933-A.D.; Ambassador of the Almighty-God, -:Trustee: Concession-1213-A.D. ~ -2020-A.D. :Right of -:Conusance :Authorization for the Restoration of the Lawful-Government
116	L.-Lin: Wood Jr	:L.-Lin-Wood	↓	email	↓
117	:Thomas-Charles: Bellavia, et al.	:Washington-State -:corporation	↓ 12/11/20	email	↓
118	:Fadwa-A.: Hammoud, et al.	:Michigan-State -:corporation	↓	email	↓ :Darrell-James: Hill, -:Ohioan- beneficiary- Executor: DOI-1776-A.D. -:Treaty-of-Paris-1783-A.D.,

2022-011769 MISC Page: 1459 of 2782
 09/26/2022 03:35:37 PM Receipt #: 22-9381
 Rec Fee: \$30.00 Darrell James Hill
 Gila County, Az, Sadie Jo Bingham, Recorder



14691

-:Concession-1213-A.D.; beneficiary- Executor: EBA-1933-A.D.; Ambassador of the Almighty-God, -:Trustee: Concession-1213-A.D. ~ -2020-A.D.

:Right of -:Conusance

:Authorization for the Restoration of the Lawful-Government

119	:Charles-R.: Gerow, et al.	:Pennsylvania-State, -:General-Assembly	↓	email	↓
	:man- trustee	:association	:year, :day	USPO, other	:covenant
120	:D.-John: Sauer, et al.	:Missouri-State, :corporation A.G.	↓	email	↓
121	:Richard-Douglas: Bernstein, et al., :Carter: Phillips	:Carter-Phillips, et al.	↓	email	↓
122	:Brunn-Wall: Roysden III, :Mark: Brnovich	:Arizona-State, Arizona-State -:AG, -:Mark: Brnovich-	↓ 12/11/20	email	↓

:Darrell-James: Hill, -:Ohioan- beneficiary- Executor: DOI-1776-A.D. -:Treaty-of-Paris-1783-A.D., -:Concession-1213-A.D.; beneficiary- Executor: EBA-1933-A.D.; Ambassador of the Almighty-God, -:Trustee: Concession-1213-A.D. ~ -2020-A.D.

:Right of -:Conusance

2022-011769 MISC Page: 1460 of 2782
 09/26/2022 03:35:37 PM Receipt #: 22-9381
 Rec Fee: \$30.00 Darrell James Hill
 Gila County, Az, Sadie Jo Bingham, Recorder



1461

:Authorization for the Restoration of the Lawful-Government

123 :Benjamin-Michael: Flowers :Ohio-State ↓ email ↓

124 :Loren-L.: Alikhan, et al. :District-of-Columbia, et al.- States and Territories ↓ email ↓

125 :Douglas-Alexander-Stewart: Chalmers Jr. :Bryan-Cutler :Kerry: Benninghoff Pennsylvania-State- :House-of-Representatives ↓ email ↓

:man- trustee :association :year, :day USPO, other :covenant

126 :David-H.: Fink :City-of-Detroit ↓ email ↓

:Darrell-James: Hill, -:Ohioan- beneficiary- Executor: DOI-1776-A.D. -:Treaty-of-Paris-1783-A.D., -:Concession-1213-A.D.; beneficiary- Executor: EBA-1933-A.D.; Ambassador of the Almighty-God, -:Trustee: Concession-1213-A.D. ~ -2020-A.D.

:Right of -:Conusance

:Authorization for the Restoration of the Lawful-Government

127 :James-L.: Hirsen :Justice and Freedom Fund, et al. ↓ email ↓

2022-011769 MISC Page: 1461 of 2782
09/26/2022 03:35:37 PM Receipt #: 22-9381
Rec Fee: \$30.00 Darrell James Hill
Gila County, Az, Sadie Jo Bingham, Recorder



2941

128 :James-A: Davids, et al. - :Georgia-State-Senator
William: Ligon, et al.

↓
12/11/20 email

↓
:Darrell-James: Hill, -:Ohioan- beneficiary- Executor:
DOI-1776-A.D. -:Treaty-of-Paris-1783-A.D.,
-:Concession-1213-A.D.; beneficiary- Executor: EBA-
1933-A.D.; Ambassador of the Almighty-God,
-:Trustee: Concession-1213-A.D. ~ -2020-A.D.

:Right of -:Conusance

:Authorization for the Restoration of the Lawful-
Government

2022-011769 MISC Page: 1462 of 2782
09/26/2022 03:35:37 PM Receipt #: 22-9381
Rec Fee: \$30.00 Darrell James Hill
Gila County, Az, Sadie Jo Bingham, Recorder



[Handwritten signature]

Equity-Claim :Presentment: USPS RE 047 610 440 US -:May 15th, 2020 A.D

:Darrell-James: Hill, -:civilian, -:Executo¹
c/o PO Box 3806, Apache Junction, Arizona 85117.

:man -:present

Darrell James Hill, Executor

:The united States of America,

Arizona state
Pinal county

**Equity-Claim :Presentment: Express Trust:
Emergency Banking Act of 1933 A.D. - Trust²,
USPS RE 047 610 440 US -:May 15th, 2020 A.D., to:**

Donald-John :Trump, as :Trustee³,
:POTUSA - :Commander-In-Chief-Trustee- :Trump⁴ and
:POTUS -:TRUSTEE -:Trump⁵
:Steve-Turner: Mnuchin :USPS CMN 7008 1300 0002 2256 4705
:US-SOT⁶ :Mnuchin, -:Trustee - Minister⁷,

- 1 :Darrell-James: Hill means: :Darrell-James: Hill means: Darrell-James: Hill ©1958: Ohioan, © 1958: State of Ohio: beneficiary. See: Gila county Arizona: Doc. # 2017-002378: pp. 6-24, 89-91,93-95 of 693. Gila county Arizona: Doc. # 2018-005176: pp. 10-21, and, et seq. See: :- man -file of: Specialized Negotiable Instruments to the :man - :Barak-Hussein: Obama, :Donald-John: Trump, et al., et seq.
- 2 :Emergency Banking Act of 1933, et al. means: Public Law 73-1/ Statutes at Large 48 Stat. 1, et al. - Trading With The Enemy Act, amended ~Subdivision (b) of section 5 of the Act of October 6, 1917 ... to read as follows: During time of war or during any other period of national emergency declared by the President... President may require any person within the United States... engaged in any transaction...be fined... imprisoned... or both... Cf. Trading with the Enemy Act of 1917, Pub.L. 65-91, 40 Stat. 411.
- 3 :Trustee means: 1) one to whom an estate has been conveyed in trust; trust means: TRUST, contracts, devises. An equitable right, title or interest in property, real or personal, distinct from its legal ownership; or it is a personal obligation for paying, delivering or performing anything, where the person trusting has no real right or security, for by, that act he confides altogether to the faithfulness of those intrusted. This is its most general meaning, and includes deposits, bailments, and the like. In its more technical sense, it may be defined to be an obligation upon a person, arising out of a confidence reposed in him, to apply property faithfully, and according to such confidence. Willis on Trustees, 1; 4 Kent, Com. 295; 2 Fonb. Eq. 1; 1 Saund. Uses and Tr. 6; Coop. Eq. Pl. Introd. 27; 3 Bl. Com. 431. 2) for the Emergency Banking Act of 1933, et al., et seq., 'EBA-1933-A.D.'
- 4 :POTUSA -Commander-In-Chief Trump means: President of The United States of America ~unincorporated~, - Commander-in-Chief, under the :Lieber Code ~ :24th day, April, the year of our Lord 1863 A.D.
- 5 :POTUS Trump means: President of the UNITED STATES incorporated- :government-services-provider -:Trustee.
- 6 :US-SOT means: UNITED STATES - Secretary of Treasury; U.S.-IMF liaison.
- 7 :minister means: one who acts under -upon the authority of another; e.g., :man- :ambassador of the

:Claim- :Right for us of :Property-held-without-right in: Dry-Trust: EBA-1933 A.D - 2003 A.D.-
Presentment: USPS RE 047 610 440 US May 18, 2020 1/9

COPY

2022-011769 MISC Page: 1463 of 2782
09/26/2022 03:35:37 PM Receipt #: 22-9381
Rec Fee: \$30.00 Darrell James Hill
Gila County, Az, Sadie Jo Bingham, Recorder

1460

Equity-Claim :Presentment: USPS RE 047 610 440 US -:May 15th, 2020 A.D

:William-Pelham: Barr, :USPS RE 047 610 438 US

:US-AG⁸ -:Trustee -:Common-Law-Trustee - Minister- :Barr and

:US-APC⁹, -:Trustee- Minister- :Barr,

:Jefferson-Beauregard: Sessions III, as :Trustee - Minister, :Ex-US-AG- :Sessions,

:Matthew-George: Whitaker, as :Trustee - Minister, :Ex-US-AG: Acting- :Whitaker,

:Dana-James, Boente, as :Trustee - Minister, :Ex-US-AG- Acting- :Boente,

:Sally-Caroline, Yates, as :Trustee - Minister, :Ex-US-AG- Acting- :Yates,

c/o :Donald-John: Trump¹⁰ :USPS RE 047 610 440 US

1600 Pennsylvania Ave NW

Washington, District of Columbia 20500

re: The 'Emergency Banking Act of 1933 A.D.' - 2003 A.D., 'EBA-1933-A.D.' is :completed-of-purpose and :extinct, then is the 'dry-trust' and ought-to-have-been dissolved and conveyed to :i-man -:beneficiary and priority-creditor¹¹.

Greetings :Donald-John, :William-Pelham, :Steve-Turner, et al. man:

:i- man¹² hope :you are safe with :righteous- guidance and acts. This :document is for the settle-and-close¹³ of the :1933 A.D. -trust from the Franklin-Delano, :POTUS- POTUSA -:Roosevelt's :1933 A.D. -:New-Deal unto The united States of America – people, et seq. - :i-man -affiant.

A) :Affiant is :man- Darrell-James: Hill, -:civilian, -:Executor¹⁴.

Most-High-God: e.g., Enoch, Yushuah (Jesus-the-Christ), Peter, Paul.

8 :US-AG means: UNITED STATES Attorney General

9 :APC means: Alien-Property-Custodian means: the duty and obligation to take charge of the property of alien enemies; e.g., the :common law trustee- minister for the EBA-1933-A.D., et al. -TWEA of 1917 A.D., as amended, by the authority of the POTUS under Law.

10 :Donald-John: Trump means: the :man -:trustee under the duty, obligation and moral~Oath of Office: 20th day of January, the year our Lord 2020 A.D.~, ministry: 1) as :President of The United States of America ~unincorporated, 1776 A.D.~ - Commander-in-Chief. And, with the :General Order 100 ~Lieber Code~ :24th day, April, the year of our Lord 1863 A.D: by :Constitution for the United States of America Law, as 2) the President of the UNITED STATES incorporated- :government-services-provider- :Trustee: by: U.S. Constitution policy and martial law, the 87th year of the United States.

11 :Priority-Creditor means: one to whom compensation is made before any other debt is paid

12 :i- man means: 'i' refers to :Almighty-God as the great 'i- am'. And: 'i- man/' 'i-man' acknowledges that the Almighty-God -created the 'man' is present.

13 :settle and close of all accounts means: TO #1: restore :all :gold, silver, chattel by: (A) from the Total assets of :all :accounts of :i-man-beneficiary (B) now pay-off the Total :public- debt -account- obligation for :i- man; now, then (C) merge the two accounts into a (D) new :private-revocable-trust for :i- man, and (D) continue the status of :investment. Now, (E) Set-up an :L.L.C-type – account for to receive :payment- proceeds for the non-commercial- :cestui-que-use from (D) the: 'new: :private-revocable-trust for :i- man' without prejudice; and: #2: restore all lands to :i- man, et seq. in :allodium.

14 :ibid 1.

:Claim - :Right for us of :Property-held-without-right in: Dry-Trust: EBA-1933 A.D - 2003 A.D.- Presentment: USPS RE 047 610 440 US May 18, 2020 2 / 9

2022-011769 MISC Page: 1464 of 2782
09/26/2022 03:35:37 PM Receipt #: 22-9381
Rec Fee: \$30.00 Darrell James Hill
Gila County, Az, Sadie Jo Bingham, Recorder



1461

1. :i- man, :beneficiary¹⁵ -by-:birth¹⁶ of the inherent -trust¹⁷ from :Almighty God¹⁸~ where nothing stands between :Almighty-God and :i- man ~ am: (1) :Executor- Darrell-James: Hill © 1958 A.D., :Ohioan¹⁹, in the fullness of age, and of :sound- mind; (2) by :birth :Negro²⁰ -:beneficiary of the :Emancipation- Proclamation -1863²¹, and forever-guaranteed -:protection by the Army, et al., by the full- force and authority of The Constitution for the United States of America ~ 1789-1791~²²; and: (3) :beneficiary of the ':United-States-of-America,-Incorporated' -:government²³ -services-provider-Trustee's :self-indenture²⁴ to :i-man: with the debenture^{25 26} created in the 'idem-sonans²⁷ -:subrogation²⁸ entitled: DARRELL JAMES HILL~ & et al. derivatives~ ® 1958

- 15 :beneficiary means: one onto whom a :trust-benefit is demonstrated by the execution by the :Executor of the beneficiary's use of the trust- property.
- 16 :birthed :son of :Clarence, :son of :James, :son 'Negroland, :Kingdom-of-Judah, :Africa',:son :Ysrael- :Southern-Kingdom ~ of the sons :Judah and Benjamin and Levi, et al.~,:son of :Jacob and :Ysrael, :son of :Isaac, :son of :Abram and :Abraham,:son of :Shem, :son of :Noah,:son of :Methuselah, :son of :Enoch,:son of :Seth, :son of :Adam with :Eve of the garden of :Eden ~ including all :known and unknown :ancestral- lands ~ on the earth placed under the Adamic- lineage and under the :only-begotten -son of the Most-High-God and Father embodied within the rebirth by :i-man of the power of :Yushuah-Messiah, -:God, with the redemption by the Messiah- Yushuah (:Jesus-the-Christ), and encompassing the :receivership, responsibility and administration over :all of the earth-planet as :heir - :remainderman, and :Kinsman- :redeemer of the Earth, both from the Adamic-lineage by the :loss in :spirit in the man upon the Earth, and by the Messiah-Yushuah by the restoration in :spirit in the man upon the Earth: on, in or under-the-surface of the planet; :on, in or under-the-surface of the oceans and waters, and :on, in, under-the-surface of the atmosphere/ above the atmosphere of the Earth to wherever the :Adamic- :man-kind in the quantum and in the spirit is, of :where the :purposes of the Most High God and Father are immeasurable by mere :man.
- 17 inherent -trust means: that trust is given by the Creator- :Almighty-God -grantor to :i-man-kind -beneficiary as the steward of the realm; e.g., :gravity, water, air, land, and man- beneficiary.
- 18 :Almighty God means: a) the :Creator of the world's: embodied as :Yushuah the Messiah ~a.k.a. Jesus the Christ~ the only begotten son of the Most High God, b) He who for our sake for our redemption did ly down His glory, birthed as man-kind onto our earth-planet, fulfilled all of the word, Law and prophesy, then layed-down his :life, giving his life for to atone for our sins so that :man-kind -whosoever-will may become like Him, in the fullness of that stature, sons of the Most-High-God.
- 19 See: Record of live Birth means: Authentication ~:Birth No 134 - 58 -208851, Certified Doc.# F4012640,:State Registrar - Judith-B.: Nagy, May -9, 2018.; and: (2) OHIO- SOS -certification: C074912, :Jon: Husted, June 14, 2018; and: (3) The United States of America- SOS- Authentication No. 18047749-2, :Michael -R: Pompeo, July 17, 2018 ~ :Debenture; appended: 3 pages.
- 20 Ibid 16.
- 21 Emancipation Proclamation of 1863 means: Proclamation 95 from POTUSA Abraham Lincoln on September 22nd, 1862: effective :January 1st, 1863.
EMANCIPATION. An act by which a person, who was once in the power of another, is rendered free. By the laws of Louisiana, minors may be emancipated. Emancipation is express or implied.
2. Express emancipation. The minor may be emancipated by his father, or, if he has no father, by his mother, under certain restrictions. This emancipation takes place by the declaration, to that effect, of the father or mother, before a notary public, in the presence of two witnesses. The orphan minor may, likewise, be emancipated by the judge, but not before he has arrived at the full age of eighteen years, if the family meeting, called to that effect, be of opinion that he is able to administer his property. The minor may be emancipated against the will of his father and mother, when they ill treat him excessively, refuse him support, or give him corrupt example.
- 22 The Constitution for the United States of America ~ 1789-1791~ means: The :original - organic -constitution and includes the ':Bill of Rights', et al.
- 23 ':United-States-corporation' -:government means: 'United-States-of -America- -:corporation'

:Claim - :Right for us of :Property-held-without-right in: Dry-Trust: EBA-1933 A.D - 2003 A.D.- Presentment: USPS RE 047 610 440 US May 18, 2020 3 / 9

2022-011769 MISC
09/26/2022 03:35:37 PM
Rec Fee: \$30.00
Gila County, Az, Sadie Jo Bingham, Recorder



Page: 1465 of 2782

Receipt #: 22-9381
Darrell James Hill

1462

A.D., :State-of-Ohio²⁹ by the 'Emergency Banking Act of 1933, et al.', 'EBA-1933-A.D.'
-Trust (ended :2003 A.D.);

2. :i- man am :member of the non-political -aggregate³⁰;
3. :i- man am the literate, legalese-idiot -non-member of the :B.A.R.- legal -society.
:i man am the :Christian -Ambassador³¹ of the Almighty-God
4. :Almighty-God, -Yushuah -the -Messiah (aka: Jesus-the-Christ) who prophetically came to this planet, was birthed -:man, healed :man-kind, died for :man-kind, did resurrect, and now sits at the right-hand of his Father, the :Most-High-God, in Heaven; :i- man am a :disciple of that Messiah Yushuah's teaching and spiritual guidance. :Thereeto,

-:government -services -provider -Trustee: status post :1862 A.D., e.g., (1) cf :2020: Donald-John: POTUS Trump- Trustee/ EBA-1933-A.D, :CIC acting under U.S. Constitution - incorporated, and (2) cf. :Donald-John: POTUSA Trump, :CIC understanding The Constitution for the United States of America - unincorporated.

- 24 :indenture means: **INDENTURE**, conveyancing. An instrument of writing containing a conveyance or contract between two or more persons, e.g., as between the 'UNITED STATES-CORPORATION' and 'The United States of America, unincorporated, i.e., the people of the non-political- aggregate.
- 25 :debenture means: **DEBENTURE**. A certificate given, in pursuance of law, by the collector of a port of entry, for a certain sum, due by the United States, payable at a time therein mentioned, to an importer for drawback of duties on merchandise imported and exported by him, provided the duties arising on the importation of the said merchandise shall have been discharged prior to the time aforesaid. Vide Act of Congress of March 2, 1799, s. 80; Encyclopædie, h. t.; Dane's Ab. Index, h. t.
- 26 Ibid 19; '**Birth-day**' means: the 20th day, November, year of our Lord 1958 A.D. at: 11:35 a.m. **Birth**. The act of being wholly brought into the world. The whole body must be detached from that of the mother, in order to make the birth complete. 5 C. & P. 329; S. C. 24 E. C. L. R. 344 6 C. & P. 349; S. C. 25 E. C. L. R. 433.
day. A division of time. It is natural, and then it consists of twenty-four hours, or the space of time which elapses while the earth makes a complete revolution on its axis; or artificial, which contains the time, from the rising until the setting of the sun, and a short time before rising and after setting. Vide Night; and Co. Lit. 135, a.
2. Days are sometimes calculated exclusively, as when an act required that an appeal should be made within twenty days after a decision. 3 Penna. 200; 3 B. & A. 581; 15 Serg. & Rawle, 43. In general, if a thing is to be done within such a time after such a fact, the day of the fact shall be taken inclusively. Hob. 139; Doug. 463; 3 T. R. 623; Com. Dig. Temps, A; 3 East, 407.
3. The law, generally, rejects fractions of days, but in some cases it takes notice of such parts. 2 B. & A. 586. Vide Date.
- 27 **Idem-sonans** means: **IDEM SONANS**. Sounding the same.
2. In pleadings, when a name which it is material to state, is wrongly spelled, yet if it be idem sonans with that proved, it is sufficient, as Segrave for Seagrave, 2 Str. R. 889; Keen for Keene, Thach. Cr. Cas. 67; Deaderna for Diadema, 2 Ired. 346; Hutson for Hudson, 7 Miss. R. 142; Coonrad for Conrad, 8 Miss. R. 291. See 5 Rike, 72; 6 Ala. R. 679; vide also Russ. & Ry. 412; 2 Taunt. R. 401, In the following cases the variances there mentioned were declared to be fatal. Russ. & Ry. 351; 10 East, R. 83; 5 Taunt. R. 14; 1 Baldw. R. 83; 2 Crom. & M. 189; 6 Price, R. 2; 1 Chit. R. 659; 13 E. C. L. R. 194. See, generally, 8 Chit. Pr. 231, 2; 4 T. R. 611; 3 B. & P. 559; 1 Stark. R. 47; 2 Stark. R. 29; 3 Camp. R. 29; 6 M. & S. 45; 2 N. H. Rep. 557; 7 S. & R. 479; 3 Caines, 219; 1 Wash. C. C. R. 285; 4 Cowen, 148 and the article Name.
- 28 **Subrogation** means: **SUBROGATION**, civil law, contracts. The act of putting by a transfer, a person in the place of another, or a thing in the place of another thing. It is the substitution (q. v.) of a new for an old creditor, and the succession to his rights, which is called subrogation; transfusio unius creditoris in alium. It is precisely the reverse of delegation. (q. v.)
2. There are three kinds of subrogation: 1. That made by the owner of a thing of his own free will; example, when he voluntarily assigns it. 2. That which arises in consequence of the law, even without

:Claim - :Right for us of :Property-held-without-right in: Dry-Trust: EBA-1933 A.D - 2003 A.D.-
Presentment: USPS RE 047 610 440 US May 18, 2020 4 / 9

Page: 1466 of 2782

MISC

Receipt #: 22-9381

09/26/2022 03:35:37 PM

Darrell James Hill

Sadie Jo Bingham, Recorder

Gila County, Az.

1463

5. :i- man am my brother's keeper as the :ambassador of the :Almighty-God, and openly-accept herenow the duty as the :kinsman- redeemer³² for the unknown -creditors to the :extinct- 'EBA-1933-A.D.' :-completed-trust -contract, aka ':dry-trust³³', and, as such, for: a) the :tribes of :Ysrael, and: b) for the people understanding the :Almighty-God.

:Declaration of the Beneficiary & :Priority-Creditor of the EBA-1933-A.D. :-dry-trust

6. :i- man -:Darrell-James: Hill, :Executor declare³⁴ that :i- man am: (a) :beneficiary -:remainderman³⁵ and :priority-creditor in the remedial :equitable- right³⁶ and ownership of the principal and proceeds from the extinct 'EBA-1933-A.D.' -contract according to

the consent of the owner; example, when a man pays a debt which could not be properly called his own, but which nevertheless it was his interest to pay, or which he might have been compelled to pay for another, the law subrogates him to all the rights of the creditor. Vide 2 Binn. Rep. 382; White's L. C. in Eq.* 60-72. 3. That which arises by the act of law joined to the act of the debtor; as, when the debtor borrows money expressly to pay off his debt, and with the intention of substituting the lender in the place of the old creditor. 7 Toull. liv. 3, t. 3, c. 5, sect. 1, §2. Vide Civ. Code of Louisiana, art. 2155 to 2158; Merl. Repert. h. t.; Dig. lib. 20; Code, lib. 8, t. 18 et 19 9 Watts. R. 451; 6 Watts & Serg. 190; 2 Bouv. Inst. n. 1413.

29 Ibid 19; ':berth-date' means: the 28th day, November, year of our Lord 1958 A.D., in the 244th year of the United States.

Berth: (v.) 1660s, of ships, from berth (n.). Of persons (intransitive), from 1886. Related: Berthed; berthing.

berth (n.) 1620s, "convenient sea room" (both for ships and sailors), of uncertain origin, probably from bear (v.) + abstract noun suffix -th (2) as in strength, health, etc. Original sense is preserved in phrase to give (something or someone) wide berth. Meaning "place on a ship to stow chests, room for sailors" is from 1706; extended to non-nautical situations by 1778.

Date. The designation or indication in an instrument of writing, of the time, and usually of the time and place, when and where it was made. When the place is mentioned in the date of a deed, the law intends, unless the contrary appears, that it was executed at the place of the date. Plowd. 7 b., 31 H. VI. This word is derived from the Latin *datum*, because when deeds and agreements were written in that language, immediately before the day, month and year in which they were made, was set down, it was usual to put the word *datum*, given.

2. All writings ought to bear a date, and in some it is indispensable in order to make them valid, as in policies of insurance; but the date in these instruments is not inserted in the body of the writing because as each subscription makes a separate contract, each underwriter sets down the day, month and year he makes his subscription. Marsh. Ins. 336.

3. Deeds, and other writings, when the date is an impossible one, take effect from the time of deliver; the presumption of law is, that the deed was dated on the day it bears date, unless, as just mentioned, the time is impossible, for example, the 32d day of January.

4. The proper way of dating, is to put the day, month, and year of our Lord; the hour need not be mentioned, unless specially required; an instance of which may be taken from the Pennsylvania Act of the 16th June, 1836, sect. 40, which requires the sheriff, on receiving a writ of fieri facias, or other writ of execution, to endorse thereon the day of the month, the year, and the hour of the day whereon he received the same.

5. In public documents, it is usual to give not only the day, the month, and the year of our Lord, but also the year of the United States, when issued by authority of the general government; or of the commonwealth, when issued under its authority. Vide, generally, Bac. Ab. Obligations, C; Com. Dig. Fait, B 3; Cruise, Dig. tit, 32, c. 20, s. 1-6; 1 Burr. 60; 2 Rol. Ab. 27, 1. 22; 13 Vin. Ab. 34; Dane's Ab. Index, h. t. See Almanac.

30 :non-political -over-standing -aggregate means: the body of people from whom :government is derived; also, :non-actors/citizens in the daily administration of the government service.

31 :Ambassador means: Ibid 7.

1464

Equity-Claim :Presentment: USPS RE 047 610 440 US -:May 15th, 2020 A.D

the Law; and: (b) the :kinsman-redeemer for all :unknown-creditors no-longer-desposed³⁷ as :surety³⁸ for the 'United-States-of-America,-incorporated'³⁹-government-services- :provider's -bankruptcy which was mitigated by the EBA-1933-A.D. -indenture, administered by the person: 'UNITED STATES Incorporated'-government-services- provider -:Trustee for the United-States-of-America,-Incorporated: 1933- A.D., et al., et seq. - :debenture to: The united States of America - people, et seq. - :i- man :Darrell-James ~ 1958 A.D.

B. :Trustee -:Trump is The Trustee To This :Presentment: USPS :RE 047 610 440 US, May 18th, 2020 A.D., For This Exercise Of The Right By :i- man With The Conveyance Of Assets To :i- man ByThe Emergency Banking Act Of 1933 A.D. under Law

7. :You are the Trustee of the extinct- 'EBA-1933-A.D.' -:completed-trust- principal which should ought-to have-been conveyed to :i-man, et al. in the year of our Lord: 2003 A.D.; and, now ought-be made so: post-haste, agreeably, and with :all -principal- property in :all- accounts, :chattel and land conveyed to a) :i- man- sole, and b) :i-man -kinsman-redeemer.

All Previous Notices To You Are Acquiesced By :you, et al.

8. :This is the second beneficiary request from :i- man to you, et al., for :trust- information for to settle-and-close the :accounts of the extinct- 'EBA-1933-A.D.' -dry- trust. All previous contacts are answered in the response of the :silent- acquiescence.

9. Ignoring :this -Trustee- duty and obligation for to release :all of the property belonging to :i- man is the :same- :wrong-doing as :abandonment of :your fiduciary- duty and oath-of-office to uphold: The Constitution for the United States of America, et al. -:Bill-of-Rights.

C. Remedy

10. :Where as the :Emergency Banking Act of 1933' -2003 A.D. is a :dry-trust

- 32 :Kinsman-redeemer means: a relative, male, who delivers a family member from bondage, or sin, or penalties who stands in the gap of the need for the family -unprotected: a relative who delivers a family member from bondage, or sin, or penalties.
- 33 :dry-trust means: the end/ extinction of the trust upon the completion of its duties by the consent and demand of :i- man, et al.,beneficiary for the restoration of :all of the trust- property.
- 34 declare means: to make known explicitly and plainly by the full statement as being in one's possession or ownership.
- 35 :Remainderman means: heir, one who inherits; - a person who inherits or is entitled to inherit property upon the termination of the estate
- 36 remedial :equitable- right means: Remedy, exercise in the choice to attain the right of a contract of which one injured is agreed- by :Law, :entitled.
- 37 desposed means: government rule forced -upon :people whether by an overt-wrong or otherwise under the guise of a :remedy; despotism.
- 38 :surety means: contracts. One bound for the payment of a sum of money or for the performance of something else, for another, who is already bound for the same
- 39 'United-States-of-America,-incorporated' means: The government of the united States of America, fashioned under the auspices by the Executive Branch with the Lieber Code upon the American -Civil- War-Crisis: 1861 -A.D.

:Claim - :Right for us of :Property-held-without-right in: Dry-Trust: EBA-1933 A.D - 2003 A.D.- Presentment: USPS RE 047 610 440 US May 18, 2020 6 / 9

2022-011769 MISC Page: 1468 of 2782

09/26/2022 03:35:37 PM Receipt #: 22-9381

Rec Fee: \$30.00 Darrell James Hill, Recorder
Gila County, Az, Sadie Jo Bingham, Recorder



1465

-indenture,

- a) administrating the :property without right is now :willful- wrong-doing;
- b) the :Full-Accounting to the penny is required/requested/demanded/ordered- ; and:
- c) :You are required/requested/demanded/ordered to restore :all- property to :i- man- sole upon your receipt of the returned- debenture of the EBA-1933-A.D.- :dry- trust indenture for the settle and close of all accounts.

D. :i- man :Beneficiary And Priority-Creditor Now Herein Expressively Return To The Trustee- :Donald-John: Trump The :EBA-1933-A.D. - :Debenture Expressively Provided For To Settle-And-Close :All-Accounts, And Convey :All - Property To :i- man: Darrell-James Post-Haste.

:Authenticated -:Debenture to :Darrell-James: Hill

11. See the :Authenticated -:certified-debenture ~appended: 3 pages~ returned herein for the settle and close of :all- accounts in the extinct- 'EBA-1933-A.D.' -:dry- trust, for the restoration of :all property to :i- man post-haste.

:Declaration :Beneficiary& :Priority-Creditor: EBA-1933-A.D. -:dry-trust

12. :i- man -:Darrell-James: Hill, :Executor declare⁴⁰ comprehension now that :i- man am a) :beneficiary -:remainderman and :priority-creditor in the remedial :equitable- right⁴¹ and ownership of the principal and proceeds by/according to the Law by the extinction of the 'EBA-1933-A.D.' -:completed-trust, and b) the :kinsman-redeemer for :unknown-creditors no- longer desposed as :surety to the 'United-States-of- America,-incorporated'-government-services- provider's -bankruptcy mitigated by the EBA-1933-A.D.⁴² -contract with the :debenture to :The united States of America - people, -:beneficiary and priority-creditor, et seq. - :Darrell-James.

Require/request/ demand :all property upon return of the debenture

13. :i- man :Darrell-James -:beneficiary and priority-creditor to the extinct- 'EBA- 1933-A.D.' -:completed-trust herein exercise the :right in :Law and equity to require/request/ demand the :trustee, et al. to assent, and to release :all property to :i- man upon the receipt of the debenture to the 'EBA-1933-A.D.' -contract. Notice to the primary Trustee is :notice to every minister; Notice upon the any minister must be expediently noticed to :Trustee, :POTUS-, :POTUSA- :Trump.

Require/Request/Demand/Order The Full-Accounting To :penny Of: Property

14. :i- man Require/ Request/ Demand /Order the :Full-Accounting to the penny for :all accounts for (1) :i- man for: all- property held nowtofore and now-after by the 'Emergency Banking Act of 1933' -:dry- trust.

Return Of All Principal-Property, :Settle And Close -All Accounts -:Property And Chattel

40 declare means: to make known explicitly and plainly by the full statement as being in one's possession or ownership.

41 remedial :equitable- right means: a right of a contractual remedy to which one injured is entitled

42 'United-States-of-America,-incorporated- :1933' -:bankruptcy means: the : bankruptcy of the corporate-government 'mitigated' by the EBA-1933-A.D., et seq. by the :Primary-:Trust-Management- Organization - :Trustee for the United-States-of-America,-incorporated: 1933- 2003- A.D. bankruptcy period: seventy years.

:Claim - :Right for us of :Property-held-without-right in: Dry-Trust: EBA-1933 A.D - 2003 A.D.- Presentment: USPS RE 047 610 440 US May 18, 2020 7 / 9

2022-011769 MISC Page: 1469 of 2782

09/26/2022 03:35:37 PM Receipt #: 22-9381
Rec Fee: \$30.00 Darrell James Hill
Gila County, Az, Sadie Jo Bingham Recorder



1468

Equity-Claim :Presentment: USPS RE 047 610 440 US -:May 15th. 2020 A.D

15. :i- man :Darrell-James: Hill, :Executor, :priority- creditor and :known -:kinsman-redeemer now require/ request/demand for :you- :Trustee to make :order expressly that :all -principal⁴³ -propertyadministered in to the 'United-States-of-America,- Incorporated: 1933'- A.D. -bankruptcy ought- must- now be :settled and closed with :all -principal -property returned **post-haste** to: (1) :i- man :Darrell-James: Hill, -:Executor -:priority-creditor -:sole; and: (2) to :i-man :Darrell-James:Hill, -:Executor- :known -:kinsman-redeemer for :all unknown-priority-Creditors due the surety-assets in :total-remainder.

Enclosure: 1/1: Record of live Birth Authentication ~:Birth No 134 - 58 -208851, Certified Doc.# F4012640,:State Registrar - Judith-B.: Nagy, May -9, 2018.; and: (2) OHIO- SOS -certification: C074912, :Jon: Husted, June 14, 2018; and: (3) United States of America- SOS- Authentication No. 18047749-2, :Michael -R: Pompeo, July 17, 2018 ~ :Debenture: 3 pages.

cc: Army, et al. JCOS :USPS RE 047 610 512 US

:Mark-Alexander :General United States Army⁴⁴-.Chairman: CJCOS⁴⁵- :Milley,
:John-Earl :General United States Air Force: Vice- CJCOS- :Hyten,
:James-Charles :General United States Army: COS⁴⁶ Army- :McConville,
:David-Hilberry :General United States Marine Corps: CMC⁴⁷- :Berger,
:Michael-Martin :Admir.. al United States Navy: CNO⁴⁸- :Gilday.,
:David-Lee :General United States air Force: COS AF⁴⁹- :Goldfein,
:John-William :General United States Space Force: CSO⁵⁰- :Raymond,
:Joseph-Lauren :General United States Air Force: CNG⁵¹- :Lengyel
:Karl-Leo :Admiral United States Coast Guard: CCG⁵²- :Schultz
c/o :Mark-Alexander:Milley, :USPS RE 047 610 512 US

Office: CJCOS
9999 Join Staff Pentagon
Washington, District of Columbia 20318-9999

:William-Pelham: Barr, :USPS RE 047 610 438 US
:US-AG - :Trustee -:Common-Law-Trustee - Minister- :Barr and
:US-APC, -:Trustee- Minister- :Barr,
950 Pennsylvania Avenue, N.W.

- 43 :all -principal -property means: Gold, silver, chattel, land, of the original confiscation in the open accounting.
44 :General United States means: General: 'The United States of America' Army
45 :CJCOS means: Chairman: Joint Chief Of Staff
46 :COS means: Chief of Staff
47 :CMC means: Commandant of the Marine Corps
48 :CNO means: Chief of Naval Operations
49 :COS AF means: Chief of Staff of the Air Force
50 :CSQ means: Chief of Space Operations
51 :CNG means: Chief of the National Guard:Bureau
52 :CCG means: Commandant of the Coast Guard

:Claim - :Right for us of :Property-held-without-right in: Dry-Trust: EBA-1933 A.D - 2003 A.D.- Presentment: USPS RE 047 610 440 US May 18, 2020 8 / 9

2022-011769 MISC
09/26/2022 03:35:37 PM
Rec Fee: \$30.00 Darrell J Hill
Gila County, Az, Sadie Jo Bingham, Recorder



1467
[Handwritten signature]

Equity-Claim :Presentment: USPS RE 047 610 440 US -May 15th, 2020 A.D

Washington, District of Columbia 20530-0001

:Steve-Turner: Mnuchin, ~:USPS CMN 7008 1300 0002 2256 4705~
:US-SOT :Mnuchin, ~:Trustee - Minister,
1500 Pennsylvania Avenue, NW
Washington, District of Columbia 20220

Notice to the primary Trustee is :notice to every minister; Notice upon the any minister
must be expediently noticed to :Trustee - :POTUS-, :POTUSA- Trump.

:i- man affirm all said above is true and correct, and will state same in the open court.

Without prejudice



Darrell-James Hill, Executor

:Darrell-James Hill, :civilian, .Executor, -.Beneficiary and
:Kinsman-redeemer -.Priority-Creditor in the remedial
:equitable- right by the 'Emergency Banking Act of
1933' -.dry-trust with 'United-States-of-America,-
Incorporated -:1933- 2003 :bankruptcy.

Jurat

Affirmed and autographed before me this day 18 May, the year of our Lord 2020 A.D.
Type of Identification: Arizona Driver License.

[Signature]
Notary Public

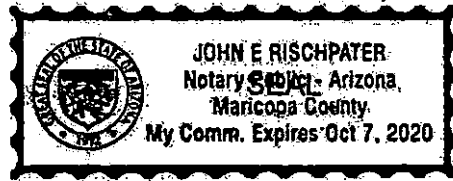

:Claim- :Right for us of :Property-held-without-right in: Dry-Trust: EBA-1933 A.D - 2003 A.D.,
Presentment: USPS RE 047 610 440 US May 18, 2020 9/9

1468

2022-011769 MISC Page: 1471 of 2782
09/26/2022 03:35:37 PM Receipt #: 22-9381
Rec Fee: \$30.00 Darrell James Hill
Gila County, Az, Sadie Jo Bingham, Recorder

151 W SUPERSTITION BLVD
 APACHE JUNCTION, AZ 85120-9998
 030259-0130
 (800)275-8777
 05/18/2020 03:35 PM

UNITED STATES POSTAL SERVICE
REGISTERED MAIL™

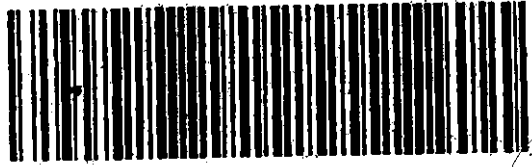

RE 047 610 440 US

Label 200, August 2005 PSN 7690-03-000-9311

Product	Qty	Unit Price	Price
First-Class Package Service 3 Days (Domestic) (WASHINGTON, DC 20500) (Weight: 0 Lb 2.10 Oz) (Estimated Delivery Date) (Friday 05/22/2020)	1	\$4.20	\$4.20
Registered (Amount: \$21.00) (USPS Registered Mail #) (RE322387559US)			\$13.20
Return Receipt (USPS Return Receipt #) (9590940245638278430987)			\$2.85
Total:			\$20.25
Cash Change		\$100.00 (\$79.75)	

Due to the security of Registered Mail, an additional 3-10 delivery days should be added to the expected delivery date provided.

In a hurry? Self-service kiosks offer quick and easy check-out. Any Retail Associate can show you how.

Text your tracking number to 28777

Registered No. RE322387559US

Date Stamp 0130 16

Reg. Fee	\$4.20	Return Receipt
Handling Charge	\$13.20	Restricted Delivery
Postage	\$2.85	
Received by	\$0.00	
Customer Must Declare Full Value	\$21.00	Domestic insurance up to \$25,000 is included based upon the declared value. International indemnity is limited. (See Reverse).

To Be Completed By Post Office

FROM
 Darrell James Hill, beneficiary
 90 PO Box 3806
 Apache Junction, Arizona 85117

TO
 Donald John Trump, trustee
 1600 Pennsylvania Ave NW
 Washington, District of Columbia 20500

PS Form 3806, Receipt for Registered Mail Copy 1 - Customer
 (See Information on Reverse)
 our website at www.usps.com®

SENDER: COMPLETE THIS SECTION

Complete items 1, 2, and 3.
 Print your name and address on the reverse so that we can return the card to you.
 Attach this card to the back of the mailpiece, or on the front if space permits.
 Article Addressed to:
 Donald John Trump, trustee
 1600 Pennsylvania Ave NW
 Washington, Dist of Columbia 20500

Tracking Number (Transfer from service label)
 RE 322 387 559 US

COMPLETE THIS SECTION ON DELIVERY

A. Signature
 Addressee
 Agent

B. Received by (Printed Name)
RECEIVED
 JUN 02 2020

C. Date of Delivery

D. Is delivery address different from item 1? Yes
 If YES, enter delivery address below: No

MSOD MAIL OPERATION

3. Service Type
 Adult Signature
 Adult Signature Restricted Delivery
 Certified Mail®
 Certified Mail Restricted Delivery
 Collect on Delivery
 Signature Confirmation Restricted Delivery
 Signature Confirmation Restricted Delivery (over \$500)

Priority Mail Express®
 Registered Mail™
 Registered Mail Restricted Delivery
 Return Receipt for Merchandise
 Signature Confirmation™
 Signature Confirmation Restricted Delivery

2022-011769 MISC Page: 1472 of 2782
 05/28/2020 03:35:37 PM Receipt #: 22-9381
 Rec Fee: \$30.00 Darrell James Hill
 Gila County, Az, Sadie Jo Bingham, Recorder



ALERT: DUE TO LIMITED TRANSPORTATION AVAILABILITY AS A RESULT OF NATIONWIDE COVID-19 IMPACTS, PACKAG...

USPS Tracking®

[FAQs >](#)

Track Another Package +

Track Packages
Anytime, Anywhere

Get the free Informed Delivery® feature to receive automated notifications on your packages

[Learn More](#)

(<https://reg.usps.com>)

[/xself?app=UspsTools&ref=homepag; aBanner&appURL=https%3A%2F%2Finformeddelivery.usps.com/box/pages/intra/start.action](#)

Tracking Number: RE322387559US

[Remove X](#)

Your item was delivered at 4:12 am on May 29, 2020 in WASHINGTON, DC 20500.

Delivered

May 29, 2020 at 4:12 am
Delivered
WASHINGTON, DC 20500

[Get Updates v](#)

Text & Email Updates v

Tracking History ^

May 29, 2020, 4:12 am
Delivered
WASHINGTON, DC 20500
Your item was delivered at 4:12 am on May 29, 2020 in WASHINGTON, DC 20500.

May 24, 2020, 12:46 am
Arrived at Hub
WASHINGTON, DC 20066

May 23, 2020, 4:30 am
Arrived at USPS Regional Destination Facility
WASHINGTON DC DISTRIBUTION CENTER

May 18, 2020, 11:54 pm
Departed USPS Facility
PHOENIX, AZ 85026

2022-011769 MISC Page: 1473 of 2782
09/26/2022 03:35:37 PM Receipt #: 22-9381
Rec Fee: \$30.00 Darrell James Hill
Gila County, Az; Sadie Jo Bingham, Recorder



United States of America



DEPARTMENT OF STATE

To all to whom these presents shall come, Greetings:

I Certify That the document hereunto annexed is under the Seal of the Secretary of State of the State(s) of Ohio, and that such Seal(s) is/are entitled to full faith and credit.*

**For the contents of the annexed document, the Department assumes no responsibility
This certificate is not valid if it is removed or altered in any way whatsoever*

2022-011769 MISC Page: 1474 of 2782

09/26/2022 03:35:37 PM Receipt #: 22-9381

Rep Fee: \$30.00 Darrell James Hill

Gila County, Az, Sadie Jo Bingham, Recorder



In testimony whereof, I, Michael R. Pompeo, Secretary of State, have hereunto caused the seal of the Department of State to be affixed and my name subscribed by the Assistant Authentication Officer, of the said Department, at the city of Washington, in the District of Columbia, this seventeenth day of July, 2018.

Michael R. Pompeo

Secretary of State

By *[Signature]*

Assistant Authentication Officer,
Department of State

1474
Issued pursuant to CHXII, State of
Sept. 15, 1789, 1 Stat. 68-69; 22
USC 2657; 22 USC 2651a; 5 USC
301; 28 USC 1733 et. seq.; 8 USC
1443(f); RULE 44 Federal Rules of
Civil Procedure.

Copy

**For :Demonstration-Purposes Only,
Original To: Donald-John: Trump, -:Trustee:
USPS RMN RE 322 387 559 US, :May-2020 A.D.
Without Prejudice**

19th May 2020: *Darrell James Hill, A.E.*
:Darrell-James: Hill, -:Beneficiary, -:Executor

Unofficial

1477

2022-011769 MISC Page: 1475 of 2782
09/26/2022 03:35:37 PM Receipt #: 22-9381
Rec Fee: \$30.00 Darrell James Hill
Gila County, Az, Sadie Jo Bingham, Recorder



United States of America
State of Ohio
Office of the Secretary of State

I, **JON HUSTED**, Secretary of State, do hereby certify that I am the duly elected, qualified and acting Secretary of State of the State of Ohio, and I further certify that

JUDITH B. NAGY

is the duly appointed, State Registrar, Vital Statistics Division, Department of Health, for the State of Ohio. She is the custodian of the records of Vital Statistics, and that she is the proper official to make said attestation, which is in due form; and that her official acts are entitled to full faith and credit.

This certification certifies only the authenticity of the signature of the official who signed the document, the capacity in which that official acted, and where appropriate, the identity of the seal or stamp, which the document bears. This certification does not imply that the contents of the document(s) are correct, nor that they have the approval of this office.

IN TESTIMONY WHEREOF, I have hereunto subscribed my name and affixed the official Seal of the Secretary of State of Ohio, at Columbus, Ohio, this 14th day of June, 2018.

Jon Husted
Secretary of State

SEC4000 (Rev. 1/11)

2022-011769 MISC Page: 1476 of 2782
09/26/2022 03:35:37 PM Receipt #: 22-9381
Rec Fee: \$30.00 Darrell James Hill
Gila County, Az, Sadie Jo Bingham, Recorder



Unofficial Copy

**For :Demonstration-Purposes Only;
Original To: Donald-John: Trump, -:Trustee:
USPS RMN RE 322 387 559 US, :May-2020 A.D.
Without Prejudice**

19th May 2020:

Darrell James Hill, A.P.

:Darrell-James: Hill -:Beneficiary, -:Executor

1474



2022-011769 MISC Page: 1477 of 2782
09/26/2022 03:35:37 PM Receipt #: 22-9381
Rec Fee: \$30.00 Darrell James Hill
Gila County, Az, Sadie Jo Bingham, Recorder



OHIO DEPARTMENT OF HEALTH
DIVISION OF VITAL STATISTICS
CERTIFICATE OF LIVE BIRTH

Registrar's No. **9370**
Birth No. **184 - 58 - 208851**

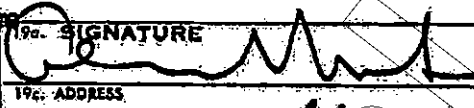
Reg. Dist. No. **7701**
Primary Reg. Dist. No. **7701**

1. PLACE OF BIRTH a. COUNTY Summit		2. USUAL RESIDENCE OF MOTHER (Where does mother live?) a. STATE Ohio b. COUNTY Summit	
3. CITY, VILLAGE, OR LOCATION Akron		4. CITY, VILLAGE, OR LOCATION Summit	
5. NAME OF HOSPITAL OR INSTITUTION (If not in hospital or institution, give street address) Akron City Hospital		6. STREET ADDRESS 219 King Ct.	
7. IS PLACE OF BIRTH INSIDE CITY LIMITS? YES <input checked="" type="checkbox"/> NO <input type="checkbox"/>		8. IS RESIDENCE INSIDE CITY LIMITS? YES <input checked="" type="checkbox"/> NO <input type="checkbox"/>	
9. IS RESIDENCE ON A FARM? YES <input type="checkbox"/> NO <input checked="" type="checkbox"/>			
3. NAME (TYPE OR PRINT) First Middle Last Darrell James Hill			
4. SEX M <input checked="" type="checkbox"/> F <input type="checkbox"/>		5. IF TWIN OR TRIPLET, WAS CHILD BORN: 1ST <input type="checkbox"/> 2D <input type="checkbox"/> 3D <input type="checkbox"/>	
6. THIS BIRTH SINGLE <input checked="" type="checkbox"/> TWIN <input type="checkbox"/> TRIPLET <input type="checkbox"/>		7. DATE OF BIRTH MONTH DAY YEAR Nov 20 58	
7. NAME First Middle Last Clarence Hill		8. COLOR OR RACE Negro	
9. AGE (At time of this birth) 35 YEARS		10. BIRTHPLACE (State or foreign country) Ala.	
11. USUAL OCCUPATION Carpenter		12. KIND OF BUSINESS OR INDUSTRY Contractor	
12. MAIDEN NAME First Middle Last Ora Lee Archer		13. COLOR OR RACE Negro	
14. AGE (At time of this birth) 30 YEARS		15. BIRTHPLACE (State or foreign country) Ark.	
16. PREVIOUS DELIVERIES TO MOTHER (DO NOT include this birth) a. How many OTHER children now living? 3		b. How many OTHER children were born alive but are now dead? none	
17. INFORMANT'S NAME OR SIGNATURE Ora Hill		18. DATE SEROLOGIC TEST FOR SYPHILIS Mar 58	
18. MOTHER'S MAILING ADDRESS		19. ATTENDANT AT BIRTH M. D. <input checked="" type="checkbox"/> D. O. <input type="checkbox"/> MIDWIFE <input type="checkbox"/> OTHER (Specify)	
I hereby certify that this child was born alive on the date stated above.		19a. SIGNATURE 	
19b. ADDRESS		19c. DATE SIGNED 11-28-58	
20. DATE RECD. BY LOCAL REG. 10-28-58		21. REGISTRAR'S SIGNATURE 	
		22. DATE ON WHICH GIVEN NAME ADDED: BY _____ (Registrar)	

MARGIN RESERVED FOR BINDING

FOR MEDICAL AND HEALTH USE ONLY

2022-011769 MISC Page: 1478 of 2782

09/26/2022 03:35:37 PM Receipt #: 22-9381
Rec Fee: \$30.00 Darrell James Hill
Gila County, Az, Sadie Jo Bingham, Recorder



Judith B. Nagy
State Registrar

MAY - 9 2018



I HEREBY CERTIFY THIS DOCUMENT IS AN EXACT COPY OF THE RECORD ON FILE WITH THE OHIO DEPARTMENT OF HEALTH

VERIFIED PRESENCE OF DD WATERMARK HOLD TO LIGHT TO VIEW

REV. 7/2

Copy

**For :Demonstration-Purposes Only,
Original To: Donald-John: Trump, -:Trustee:
USPS RMN RE 322 387 559 US, :May-2020 A.D.
Without Prejudice**

19th May 2020:

Darrell James Hill, A.E.

:Darrell-James: Hill -:Beneficiary, -:Executor

1476

2022-011769 MISC Page: 1479 of 2782
09/26/2022 03:35:37 PM Receipt #: 22-9381
Rec Fee: \$30.00 Darrell James Hill
Gila County, Az, Sadie Jo Bingham, Recorder



:Darrell-James: Hill, :Darrell-James: Hill, -:civilian, -:beneficiary -:Executor
PO Box 3806
Apache Junction, Arizona 85117

:Steve-Turner: Mnuchin, ~:USPS CMN 7008 1300 0002 2256 4705~
:US-SOT :Mnuchin, -:Trustee - Minister,
1500 Pennsylvania Avenue, NW
Washington, District of Columbia 20220

:William-Pelham: Barr, :USPS RE 047 610 438 US
:US-AG - :Trustee -:Common-Law-Trustee - Minister- :Barr and
:US-APC, -:Trustee- Minister- :Barr,
950 Pennsylvania Avenue, N.W.
Washington, District of Columbia 20530-0001

RE:

**"Equity-Claim :Presentment: Express Trust:
Emergency Banking Act of 1933 A.D. - Trust",
USPS RE 047 610 440 US -:May 15th, 2020 A.D., to:**

Donald-John: Trump, -:Trustee

**re: The 'Emergency Banking Act of 1933 A.D.' - 2003 A.D., 'EBA-1933-A.D.' is :completed-of-
purpose and :extinct, then is the ':dry-trust' and ought-to-have-been dissolved and conveyed to :i-man
-:beneficiary and priority-creditor?. ~See the Claim to the Trustee and :you; appended: 15 pages.~"**

Remedy to the Absolute Benefit to :i-man is required/ requested/ demanded.

Greetings William-Pelham, Stephen-Turner,

The enclosed negotiable instrument addressed and referenced to :you- :ministers was
delivered to the USPS for :delivery by the Registered system on the 18th May, 2020 A.D.

Further, Notice: **Remedy to the Absolute Benefit to :i-man is required/ requested/
demanded.** You are :ministers of the Trustee for the beneficiary - :i- man; expedient remedy, the
absolute benefit of :i- man post-haste is what is Lawful.

Thank you in advance.

Without prejudice

Darrell-James: Hill, D.R.

:Darrell-James: Hill, :William, -:beneficiary -:Executor

1 :Emergency Banking Act of 1933, et al. means: Public Law 73-1/ Statutes at Large 48 Stat. 1, et al. - Trading With The
Enemy Act, amended ~Subdivision (b) of section 5 of the Act of October 6, 1917 ... to read as follows: During time of war
or during any other period of national emergency declared by the President... President may require any person within the
United States... engaged in any transaction...be fined... imprisoned..., or both.... Cf. Trading with the Enemy Act of 1917,
Pub.L. 65-91, 40 Stat. 411.

2 :Priority-Creditor means: one to whom compensation is made before any other debt is paid

2022-0111769 MISC Page: 1480 of 2782
09/26/2022 03:35:37 PM Receipt #: 22-9381
Reg. Fee: \$30.00 Darrell James Hill
Gila County, AZ, Sadie Jo Bingham, Recorder



1477

Registered No. RE047610438US

Date Stamp

0130
01

0130
01

APACHE JUNCTION
151 W SUPERSTITION BLVD
APACHE JUNCTION, AZ 85120-9998
030259-0130
(800)275-8777
05/19/2020 01:18 PM

Reg. Fee	\$0.85
Handling Charge	RE047610438US \$2.85
Postage	\$0.85
Received by	\$16.90

Customer Must Declare Full Value \$21.00 Domestic Insurance up to \$25,000 is included on the declared value. International Indemnity is limited. (See Reverse).

OFFICIAL USE

To Be Completed By Customer (Please Print) All Entries Must Be in Ballpoint or Typed

FROM: APACHE JUNCTION, AZ 85120
PO Box 38016
Apache Junction, Arizona 85117

TO: William Pelham Barr, Trustee
950 Pennsylvania Ave NW
Washington, Dist of Columbia 20220

Product	Qty	Unit Price	Price
First-Class Mail® Letter (Domestic) (WASHINGTON, DC 20220) (Weight: 0 Lb 2.00 Oz) (Estimated Delivery Date) (Saturday 05/23/2020)	1	\$0.70	\$0.70
Certified (USPS Certified Mail #) (7008130000022564705)			\$3.55
Return Receipt (USPS Return Receipt #) (9590940245638278431007)			\$2.85
US Flag Bklt/20 Letter	1	\$11.00	\$11.00
First-Class Mail® Letter (Domestic) (WASHINGTON, DC 20220) (Weight: 0 Lb 2.20 Oz) (Estimated Delivery Date) (Saturday 05/23/2020)	1	\$0.85	\$0.85

PS Form 3806, Receipt for Registered Mail Copy 1 - Customer
May 2007 (7530-02-000-9051)
For domestic delivery information, visit our website at www.usps.com®

U.S. Postal Service™
CERTIFIED MAIL™ RECEIPT
(Domestic Mail Only; No Insurance Coverage Provided)

For delivery information visit our website at www.usps.com®

Postage	\$3.55
Certified Fee	\$2.85
Return Receipt Fee (Endorsement Required)	\$0.00
Restricted Delivery Fee (Endorsement Required)	\$0.00
Total Postage & Fees	\$7.10

0130
01

Postmark Here

05/19/2020

Registered (Amount: \$21.00) (USPS Registered Mail #) (RE047610438US) \$13.20

Return Receipt (USPS Return Receipt #) (9590940245638278430994) \$2.85

Total: \$35.00

Cash Change \$40.00 (\$5.00)

Due to the security of Registered Mail, an additional 3-10 delivery days should be added to the expected delivery date provided.

2022-011769 MISC Page: 1481 of 2782
09/26/2022 03:35:37 PM Receipt #: 22-9381
Reg. Fee: \$36.00 Darrell James Hill
Gila County, Az, Sadie Jo Bingham, Recorder

Sent To: Steve Turner Maschin, Trustee
Street, Apt. No., or PO Box No. 1500 Pennsylvania Ave NW
City, State, ZIP+4 Washington, Dist of Columbia 20220

PS Form 3800, August 2006

SENDER: COMPLETE THIS SECTION

- Complete items 1, 2, and 3.
- Print your name and address on the reverse so that we can return the card to you.
- Attach this card to the back of the mailpiece, or on the front if space permits.

1. Article Addressed to:
William Pelham Barr, Trustee
950 Pennsylvania Ave. NW
Washington, Dist of Columbia
20220



9590 9402 4563 8278 4309 94

2. Article Number (Transfer from service label)
RE 047 610 438 US

COMPLETE THIS SECTION ON DELIVERY

A. Signature [Signature] Agent Addressee

B. Received by (Printed Name) JUN 03 2020 C. Date of Delivery

D. Is delivery address different from item 1? Yes No
If YES, enter delivery address below:

3. Service Type
- Adult Signature
 - Adult Signature Restricted Delivery
 - Certified Mail®
 - Certified Mail Restricted Delivery
 - Collect on Delivery
 - Collect on Delivery Restricted Delivery
 - Insured Mail
 - Insured Mail Restricted Delivery (over \$500)
 - Priority Mail Express®
 - Registered Mail™
 - Registered Mail Restricted Delivery
 - Return Receipt for Merchandise
 - Signature Confirmation™
 - Signature Confirmation Restricted Delivery

1478

ALERT: DUE TO LIMITED TRANSPORTATION AVAILABILITY AS A RESULT OF NATIONWIDE COVID-19 IMPACTS, PACKAG...

USPS Tracking®

[FAQs >](#)

Track Another Package +

**Track Packages
Anytime, Anywhere**

Get the free Informed Delivery® feature to receive automated notifications on your packages

[Learn More](#)

<https://reg.usps.com>

</xsell?app=UspsTools&ref=homepageBanner&appURL=https%3A%2F%2Finformeddelivery.usps.com/box/pages/intro/start.action>

Tracking Number: 70081300000222564705

[Remove X](#)

Your item was delivered at 4:03 am on May 26, 2020 in WASHINGTON, DC 20220.

Delivered

May 26, 2020 at 4:03 am
Delivered
WASHINGTON, DC 20220

[Get Updates ▾](#)

[Text & Email Updates ▾](#)

[Tracking History ▲](#)

May 26, 2020, 4:03 am
Delivered
WASHINGTON, DC 20220
Your item was delivered at 4:03 am on May 26, 2020 in WASHINGTON, DC 20220.

May 23, 2020, 11:33 am
Available for Pickup
WASHINGTON, DC 20220

May 23, 2020, 11:09 am
Arrived at Unit
WASHINGTON, DC 20018

May 22, 2020
In Transit to Next Facility

May 19, 2020, 7:03 pm

2022-011769 MISC Page: 1482 of 2782

05/26/2022 03:35:37 PM Receipt #: 22-9381
Rec Fee: \$30.00 Darrell James Hill
Gila County, Az, Sadie Jo Bingham, Recorder



ALERT: DUE TO LIMITED TRANSPORTATION AVAILABILITY AS A RESULT OF NATIONWIDE COVID-19 IMPACTS, PACKAG...

USPS Tracking®

[FAQs >](#)

Track Another Package +

**Track Packages
Anytime, Anywhere**

Get the free Informed Delivery® feature to receive automated notifications on your packages

[Learn More](#)

(<https://reg.usps.com>)

</xsel?app=UspsTools&ref=homepageBanner&appURL=https%3A%2F%2Finformeddelivery.usps.com/box/pages/intra/start.action>

Tracking Number: RE047610438US

[Remove X](#)

Your item was delivered at 4:05 am on May 28, 2020 in WASHINGTON, DC 20220.

Delivered

May 28, 2020 at 4:05 am
Delivered
WASHINGTON, DC 20220

[Get Updates](#) ▾

Text & Email Updates ▾

Tracking History ▲

May 28, 2020, 4:05 am
Delivered
WASHINGTON, DC 20220
Your item was delivered at 4:05 am on May 28, 2020 in WASHINGTON, DC 20220.

May 23, 2020, 1:36 pm
Arrived at USPS Regional Destination Facility
WASHINGTON DC DISTRIBUTION CENTER

May 20, 2020, 12:18 am
Departed USPS Facility
PHOENIX, AZ 85026

May 20, 2020, 12:12 am
Arrived at USPS Facility
PHOENIX, AZ 85026

2022-011769 MISC Page: 1483 of 2782
09/28/2022 03:35:37 PM Receipt #: 22-9381
Rec Fee: \$30.00 Darrell James Hill
Gila County, Az, Sadie Jo Bingham, Recorder

1480

:Darrell-James: Hill, -:civilian, -:Executor
PO Box 3806, Apache Junction, Arizona 85117

To: Arizona-state -Sheriffs

:Mark, :Sheriff- Pinal county, Arizona state- :Lamb,
:Joseph- Jr, :Sheriff Apache county, Arizona state- :Dedman,
:Mark, :Sheriff -Cochise county Arizona state- :Dannels,
:Jim, :Sheriff -Coconino county, Arizona state- :Driscoll,
:Adam, :Sheriff- Gila county, Arizona state - :Shepherd,
:Preston- "PJ", :Sheriff -Graham county, Arizona state- :Allred,
:Tim, :Sheriff- Greenlee county, Arizona state- :Sumner,
:Bill, :Sheriff- La Paz county, Arizona state- :Risen,
:Paul, :Sheriff- Maricopa county, Arizona state- :Penzone,
:Doug, :Sheriff- Mohave county, Arizona state- :Schuster,
:David, :Sheriff- Navajo county, Arizona state- :Clouse,
:Mark, :Sheriff- Pima county, Arizona state- :Napier,
:Tony, :Sheriff- Santa Cruz county, Arizona state- :Estrada,
:Scott, :Sheriff- Yavapai county, Arizona- :Mascher,
:Leon, :Sheriff- Yuma county, Arizona state- :Wilmot,
c/o :Mark :Lamb, -:Trustee
971 N Jason Lopez Circle
Building C
PO Box 867
Florence, Arizona state 85132

2022-011789 MISC Page: 1484 of 2782
09/26/2022 03:35:37 PM Receipt #: 22-9381
Rec Fee: \$30.00 Darrell James Hill
Gila County, Az, Sadie Jo Bingham, Recorder

RE: Declaration by :i- man -beneficiary -primary-creditor to the Trustee of the 'Emergency Banking Act of 1933' -:indenture to :require/request/demand for the Restoration of :all- :property post-haste with the Accounting provided to :i-man: Darrell-James: Hill, et al. (See: Equity-Claim :Presentment: Express Trust: Emergency Banking Act of 1933 A.D. -Trust¹, USPS RE 047 610 440 US -:May 15th, 2020 A.D.; appended: 9 pages).

Greetings :Mark, et al.

In the Law, :Sheriffs are the :guardians of the liberty in this republic.

As the appended -document indicates, the 'Emergency Banking Act of 1933' has been completed since 2003 A.D., after 70 years. The :principal-property ought-to-have-been conveyed back at a time no later-than 2013 A.D.; but, what is a trustee that steals the principal-property? The present :trustee's duty and obligation under his oath-of-office is to the non-competition and absolute protection to the return of :all of the principal-property post-haste. For this reason, :you have been notified.

:i- man request that you assure that this document is noticed by :you, and be placed into the permanent record of the RTCC to aid in the safety of :i- man -civilian in the pursuit to safe-guard against this massive theft of the property from the literally defunct- 'New Deal' -trust of 1933; that the property-held-without-right it will be conveyed- back to The united States of America- ;people.

1 :Emergency Banking Act of 1933, et al. means: Public Law 73-1/ Statutes at Large 48 Stat. 1, et al. - Trading With The Enemy Act, amended ~Subdivision (b) of section 5 of the Act of October 6, 1917 ... to read as follows: During time of war or during any other period of national emergency declared by the President... President may require any person within the United States... engaged in any transaction...be fined... imprisoned..., or both.... Cf. Trading with the Enemy Act of 1917, Pub.L. 65-91, 40 Stat. 411.

c/o :Donald-John: Trump:USPS RE 047 610 440 US., See appended: 16 pages.

Greetings Mark-Alexander, :John-Earl, :James-Charles, David-Hilberry, :Michael-Martin,
:David-Lee, :John-William, :Joseph-Lauren, :Karl-Leo

:i- man pray for your righteous actions.

The 'Emergency Banking Act of 1933', 'EBA-1933-A.D.', bonded as :surety :all of the people of The United States of America, replaced the strict organic :constitution -obligation with the 'new deal' of the compelled color of law, fiat currency and the :public-education system that effectively assures an ignorant progeny¹⁰.

PRESENTMENT to: Donald-John :POTUS- Trustee, et al.

I) :i- man believe that the copy of the **PRESENTMENT**, appended, is the evidence of the :exercise by the right by :i- man for to -settle and close the EBA-1933-A.D.- dry trust -agreement according to the contract with the Obligor-Trustee, the : 'UNITED-STATES Incorporated'- Trustee, -government- services -provider, 'US-Inc.':

a) The EBA-1933-A.D -emergency is abated;
b) the :period of the bankruptcy is completed; and:
c) :i- man- civilian have required/requested/demanded/ordered the :man under oath-of-offices for to settle-and-close the :accounts for :i- man by :clear- intent and with :all -documentation and truth in :authenticity.

- The :man -:POTUS- Trustee received¹¹ the :authenticated-debenture for :i- man with the required demand/order to settle-and-close.
- The :man -:USAG- Alien property custodian and Common law trustee received¹² the demand to settle-and-close.
- The :man -:Secretary of Treasury- IMF liaison received¹³ the demand to settle-and-close.

II) i- man believe that this :settle and closure -requirement/request/demand/order is a matter not subject to the exigencies nor discretion of the man -:POTUSA -CIC.; rather,
III) i- man believe that this is merely the conclusion to the :EBA-1933-A.D. -dry-trust -:contract between :i- man and the US-Inc.

IV) Whereas the spirit of The Constitution for the United States of America is to protect,

10 :ignorant -progeny means: 1) We do not know who we are; and: 2) we sustain to ourselves the :subverted- patterns of :seventy- year -bankruptcy- cycles. That is: the **Declaration of Independence** pronounced the united states of America that set :all -men free. However, **The Constitution for the United States of America** established the :legalized - murder and slavery of :millions of :Negroes; the :effect was ill-fated. - **The American Civil War** bankrupted the nation, and evolved today under the Lieber code. The Negro was set "free" but unto legalized :socio-institutional -despise, scorn and undermine; again, the :effect was ill-fated.

11 :man -:POTUS- Trustee received means: Donald-John: Trump :USPS RE 047 610 440 US; to wit: USPS RMN RE 322 387 559 US for :USPS RE 047 610 440 US (failed to scan); received: May 29, 2020 at: 4:12 a.m. See: USPS Registered mailing information with presentment: 1 page.

12 :man -:USAG- Alien property custodian and Common law trustee received means: :William-Pelham: Barr, :USPS RE 047 610 438 US; received: May 28, 2020 at 4:05 a.m.

13 :man -:Secretary of Treasury- IMF liaison received means: Steve-Turner: Mnuchin :USPS CMN 7008 1300 0002 2256 4705; received: May 26, 2020 at: 4:03 p.m.

:Presentment to :Army, :Right for Conveyance of Property-held-without-right in:
Dry-Trust: EBA-1933 A.D - 2003 A.D. USPS RMN RE 047 610 512 US June 09, 2020 2 / 3

2022-011769 MISC Page: 1485 of 2782

09/26/2022 03:35:37 PM Receipt #: ZZ-9381

James Hill, Darrell James Hill, Sadie Jo Bingham, Recorder
Gila County, Az.



1482

support and defend this :demand for the restoration of the private right and property, and, as :one ought not to prejudice the :right and property of :- man for the :commercial -benefit to any :man :-government-services-provider;

V) :- man believe this :EBA-1933-A.D.- dry trust :-matter ought- now to settle and close by the ministerial :fiduciary- duty and obligation by the man :-government- services- provider, et al.

For the stealing, theft or administration of :- man's property without right is with the violation of the Lieber Code, et seq. tantamount to the military -confiscation of :- man :-Executor- :civilian's personal property, et seq. for no cause with no compensation and with no receipt for the property -taken.

Enclosure:

'Priority-Creditor for: Equity-Claim for :Property- :Presentment: USPS RE 047 610 440 US ...; 16 pages.

:i verify that this is the righteous truth and will testify to same in the open court.

Sincerely,
Without prejudice:

Darrell James Hill, AR.

:Darrell-James: Hill, :-civilian, :-Executor
:Priority-Creditor, in the remedial :equitable- right
:EBA-1933-A.D.

Jurat

Affirmed and autographed before me this day 9th, June 2020. A.D.

Alan Almanza
Notary Public

SEAL

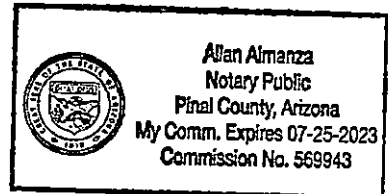

2022-011769 MISC Page: 1486 of 2782
09/26/2022 03:35:37 PM Receipt #: 22-9381
Rec Fee: \$30.00 Darrell James Hill
Gila County, Az, Sadie Jo Bingham, Recorder

1483

:Presentment to :Army, :Right for Conveyance of Property-held-without-right in:
Dry-Trust: EBA-1933 A.D - 2003 A.D. USPS RMN RE 047 610 512 US June 09, 2020 3 / 3

:Darrell-James: Hill, -:civilian, -:Executor¹
c/o PO Box 3806, Apache Junction, Arizona 85117.

:man -:present

Darrell-James: Hill, Executor

:The united States of America,

Arizona state
Pinal county

Equity-Claim :Presentment: Express Trust:
Emergency Banking Act of 1933 A.D. - Trust²,
USPS RE 047 610 440 US :May 15th, 2020 A.D., to:

Donald-John :Trump, as :Trustee³,
:POTUSA - :Commander-In-Chief- Trustee- :Trump⁴ and
:POTUS -:TRUSTEE -:Trump⁵
:Steve-Turner: Mnuchin :USPS CMN 7008 1300 0002 2256 4705
:US-SOT⁶ :Mnuchin, -:Trustee - Minister⁷,

- 1 **:Darrell-James: Hill means: :Darrell-James: Hill means: Darrell-James: Hill ©1958; Ohioan, © 1958; State of Ohio: beneficiary. See: Gila county/Arizona: Doc. # 2017-002378: pp. 6-24, 89-91,93-95 of 693. Gila county Arizona: Doc. #2018-005176: pp. 10-21; and, et seq. See: :- man -file of: Specialized Negotiable Instruments to the man -:Barak-Hussein: Obama, :Donald-John: Trump, et al., et seq.**
- 2 **:Emergency Banking Act of 1933, et al. means: Public Law 73-1/ Statutes at Large 48 Stat. 1, et al; - Trading With The Enemy Act, amended -Subdivision (b) of section 5 of the Act of October 6, 1917 ... to read as follows: During time of war or during any other period of national emergency declared by the President... President may require any person within the United States... engaged in any transaction... be fined... imprisoned... or both... Cf. Trading with the Enemy Act of 1917, Pub.L. 65-91, 40 Stat. 411.**
- 3 **:Trustee means: 1) one to whom an estate has been conveyed in trust; trust means: TRUST, contracts, devises. An equitable right, title or interest in property, real or personal, distinct from its legal ownership; or it is a personal obligation for paying, delivering or performing anything, where the person trusting has no real right or security, for by, that act he confides, altogether to the faithfulness of those intrusted. This is its most general meaning, and includes deposits, bailments, and the like. In its more technical sense, it may be defined to be an obligation upon a person, arising out of a confidence reposed in him, to apply property faithfully, and according to such confidence. Willis on Trustees, 1; 4 Kent, Com. 295; 2 Fonb. Eq. 1; 1 Saund. Uses and Tr. 6; Coop. Eq. Pl. Introd. 27; 3 Bl. Com. 431. 2) for the Emergency Banking Act of 1933, et al., et seq., 'EBA-1933-A.D.'**
- 4 **:POTUSA -Commander-In-Chief Trump means: President of The United States of America -unincorporated-, - Commander-in-Chief, under the Lieber Code - :24th day, April, the year of our Lord 1863 A.D.**
- 5 **:POTUS Trump means: President of the UNITED STATES incorporated- :government-services-provider -:Trustee.**
- 6 **:US-SOT means: UNITED STATES - Secretary of Treasury; U.S.-IMF liaison.**
- 7 **:minister means: one who acts under -upon the authority of another; e.g., :man -:ambassador of the**

:Claim - :Right for us of :Property-held-without-right In; Dry-Trust: EBA-1933 A.D - 2003 A.D.-
Presentment: USPS RE 047 610 440 US May 18, 2020 1 / 9

2022-011769 MISC Page: 1487 of 2782
09/26/2022 03:35:37 PM Receipt #: 22-9381
Rec Fee: \$30.00 Darrell James Hill
Gila County, Az, Sadie Jo Bingham, Recorder



1487

COPY

Equity-Claim :Presentment: USPS RE 047 610 440 US -May 15th, 2020 A.D

:William-Pelham: Barr, :USPS RE 047 610 438 US
:US-AG⁸ - :Trustee -:Common-Law-Trustee - Minister- :Barr and
:US-APC⁹, -:Trustee- Minister- :Barr,
:Jefferson-Beauregard: Sessions III, as :Trustee - Minister, :Ex-US-AG- :Sessions,
:Matthew-George: Whitaker, as :Trustee - Minister, :Ex-US-AG: Acting- :Whitaker,
:Dana-James, Boente, as :Trustee - Minister, :Ex-US-AG- Acting- :Boente,
:Sally-Caroline, Yates, as :Trustee - Minister, :Ex-US-AG- Acting- :Yates,
c/o :Donald-John: Trump¹⁰ :USPS RE 047 610 440 US
1600 Pennsylvania Ave NW
Washington, District of Columbia 20500

re: The 'Emergency Banking Act of 1933 A.D.' - 2003 A.D., 'EBA-1933-A.D.' is
:completed-of-purpose and :extinct, then is the 'dry-trust' and ought-to-have-been
dissolved and conveyed to :i-man -:beneficiary and priority-creditor¹¹.

Greetings :Donald-John, :William-Pelham, :Steve-Turner, et al. man:

:i- man¹² hope :you are safe with :righteous- guidance and acts. This :document
is for the settle-and-close¹³ of the :1933 A.D. -trust from the Franklin-Delano, :POTUS-
POTUSA -:Roosevelt's :1933 A.D. -:New-Deal unto The united States of America –
people, et seq. - :i-man -affiant.

A) :Affiant is :man- Darrell-James: Hill, -:civilian, -:Executor¹⁴.

- Most-High-God: e.g., Enoch, Yushuah (Jesus-the-Christ), Peter, Paul.
- 8 :US-AG means: UNITED STATES Attorney General
- 9 :APC means: Alien-Property-Custodian means: the duty and obligation to take charge of the property of alien enemies; e.g., the :common law trustee- minister for the EBA-1933-A.D., et al. -TWEA of 1917 A.D., as amended, by the authority of the POTUS under Law.
- 10 :Donald-John: Trump means: the :man -:trustee under the duty, obligation and moral-Oath of Office: 20th day of January, the year our Lord 2020 A.D.~, ministry: 1) as :President of The United States of America ~unincorporated, 1776 A.D.~ - Commander-in-Chief. And, with the :General Order 100 ~Lieber Code~ :24th day, April, the year of our Lord 1863 A.D. by :Constitution for the United States of America Law, as 2) the President of the UNITED STATES incorporated- :government-services-provider- :Trustee: by: U.S. Constitution policy and martial law, the 87th year of the United States.
- 11 :Priority-Creditor means: one to whom compensation is made before any other debt is paid
- 12 :i- man means: 'i' refers to :Almighty-God as the great 'i- am'. And: 'i- man/' 'i-man' acknowledges that the Almighty-God -created the 'man' is present.
- 13 :settle and close of all accounts means: TO #1: restore :all :gold, silver, chattel by: (A) from the Total assets of :all :accounts of :i-man-beneficiary (B) now pay-off the Total :public- debt -account- obligation for :i- man; now, then (C) merge the two accounts into a (D) new :private-revocable-trust for :i- man, and (D) continue the status of :investment. Now, (E) Set-up an :L.L.C-type – account for to receive :payment- proceeds for the non-commercial- :cestui-que-use from (D) the: 'new: :private-revocable-trust for :i- man' without prejudice; and: #2: restore all lands to :i- man, et seq. in :allodium.
- 14 :ibid 1.

:Claim - :Right for us of :Property-held-without-right in: Dry-Trust: EBA-1933 A.D - 2003 A.D.- Presentment: USPS RE 047 610 440 US May 18, 2020 2 / 9

2022-011769 MISC Page: 1488 of 2782
09/26/2022 03:35:37 PM Receipt # : 22-9381
Rec Fee: \$30.00 Darrell James Hill
Gila County, AZ, Sadie Jo Bingham, Recorder

1488

1. - :i- man, :beneficiary¹⁵ -by-:birth¹⁶ of the inherent -trust¹⁷ from :Almighty God¹⁸~ where nothing stands between :Almighty-God and :i- man ~ am: (1) :Executor- Darrell-James: Hill © 1958 A.D., :Ohioan¹⁹, in the fullness of age, and of :sound- mind; (2) by :birth :Negro²⁰-:beneficiary of the :Emancipation- Proclamation -1863²¹, and forever-guaranteed -:protection by the Army, et al.; by the full- force and authority of The Constitution for the United States of America ~ 1789-1791~²²; and: (3) :beneficiary of the ':United-States-of-America,-Incorporated' -:government²³ -services-provider-Trustee's :self-indenture²⁴ to :i-man: with the debenture²⁵ ²⁶ created in the 'idem-sonans²⁷ -:subrogation²⁸ entitled: DARRELL JAMES HILL~ & et al. derivatives~ ® 1958

- 15 :beneficiary means: one onto whom a :trust-benefit is demonstrated by the execution by the :Executor of the beneficiary's use of the trust- property.
- 16 :birthed :son of :Clarence, :son of :James, :son ':Negroland, :Kingdom-of-Judah, :Africa', ...:son :Ysrael- :Southern-Kingdom ~ of the sons :Judah and Benjamin and Levi, et al.-, ...:son of :Jacob and :Ysrael, :son of :Isaac, :son of :Abram and :Abraham, ...:son of :Shem, :son of :Noah, ...:son of :Methuselah, :son of :Enoch, ...:son of :Seth, :son of :Adam with :Eve of the garden of :Eden ~ including all :known and unknown :ancestral- lands ~ on the earth placed under the Adamic- lineage and under the :only-begotten -son of the Most-High-God and Father embodied within the rebirth by :i-man of the power of :Yushuah-Messiah, -:God, with the redemption by the Messiah- Yushuah (:Jesus-the-Christ), and encompassing the :receivership, responsibility and administration over :all of the earth-planet as :heir - :remainderman, and :Kinsman- :redeemer of the Earth, both from the Adamic-lineage by the :loss in :spirit in the man upon the Earth, and by the Messiah-Yushuah by the restoration in :spirit in the man upon the Earth: on, in or under-the-surface of the planet; on, in or under-the-surface of the oceans and waters, and :on, in, under-the-surface of the atmosphere/ above the atmosphere of the Earth to wherever the :Adamic- man -kind in the quantum and in the spirit is, of :where the :purposes of the Most High God and Father are immeasurable by mere :man.
- 17 inherent -trust means: that trust is given by the Creator- :Almighty-God -grantor to :i-man- kind -:beneficiary as the steward of the realm; e.g., :gravity, water, air, land, and man- beneficiary.
- 18 :Almighty God means: a) the :Creator of the worlds: embodied as :Yushuah the Messiah ~a.k.a. Jesus the Christ~ the only begotten son of the Most High God; b) He who for our sake for our redemption did ly down His glory, birthed as man-kind onto our earth-planet, fulfilled all of the word, Law and prophesy, then layed-down his :life, giving his life for to atone for our sins so that :man- kind -whosoever-will may become like Him, in the fullness of that stature, sons of the Most-High-God.
- 19 See: Record of live Birth means: Authentication ~:Birth No 134 - 58 -208851, Certified Doc.# F4012640,:State Registrar - Judith-B. Nagy, May -9, 2018.; and: (2) OHIO- SOS -certification: C074912, :Jon: Husted, June 14, 2018; and: (3) The United States of America- SOS- Authentication No. 18047749-2, :Michael -R: Pompeo, July 17, 2018 ~ :Debenture; appended: 3 pages.
- 20 Ibid 16.
- 21 Emancipation Proclamation of 1863 means: Proclamation 95 from POTUSA Abraham Lincoln on September 22nd, 1862: effective :January 1st, 1863.
EMANCIPATION. An act by which a person, who was once in the power of another, is rendered free. By the laws of Louisiana, minors may be emancipated. Emancipation is express or implied.
2. Express emancipation. The minor may be emancipated by his father, or, if he has no father, by his mother, under certain restrictions. This emancipation takes place by the declaration, to that effect, of the father or mother, before a notary public, in the presence of two witnesses. The orphan minor may, likewise, be emancipated by the judge, but not before he has arrived at the full age of eighteen years, if the family meeting, called to that effect, be of opinion that he is able to administer his property. The minor may be emancipated against the will of his father and mother, when they ill treat him excessively, refuse him support, or give him corrupt example.
- 22 The Constitution for the United States of America ~ 1789-1791~ means: The :original - organic -constitution and includes the ':Bill of Rights', et al.
- 23 ':United-States-corporation' -:government means: 'United-States-of -America- -:corporation'

:Claim - :Right for us of :Property-held-without-right in: Dry-Trust: EBA-1933 A.D - 2003 A.D.- Presentment: USPS RE 047 610 440 US May 18, 2020 3 / 9

2022-011769 MISC Page: 1489 of 2782
09/26/2022 03:35:37 PM Rec PM
Rec Fee: \$30.00 Darrell James Hill
Gila County, Az, Sadie Jo Bingham, Recorder



1486

A.D., :State-of-Ohio²⁹ by the 'Emergency Banking Act of 1933, et al.', 'EBA-1933-A.D.'
-Trust (ended :2003 A.D.);

2. :i- man am :member of the non-political -aggregate³⁰;

3. :i- man am the literate; legalese-idiot -non-member of the :B.A.R.- legal -society.
:i man am the :Christian -Ambassador³¹ of the Almighty-God

4. :Almighty-God, -Yushuah -the -Messiah (aka: Jesus-the-Christ) who
prophetically came to this planet, was birthed -:man; healed :man-kind, died for :man-
kind, did resurrect, and now sits at the right-hand of his Father, the :Most-High-God, in
Heaven; :i- man am a :disciple of that Messiah Yushuah's teaching and spiritual
guidance. :There to,

-government -services -provider -Trustee: status post :1862 A.D., e.g., (1) cf :2020: Donald-John:
POTUS Trump- Trustee/ EBA-1933-A.D, :CIC acting under U.S. Constitution - incorporated; and (2) cf.
:Donald-John: POTUSA Trump, :CIC understanding The Constitution for the United States of America -
unincorporated.

24 :indenture means: **INDENTURE**, conveyancing. An instrument of writing containing a conveyance or
contract between two or more persons; e.g., as between the 'UNITED-STATES-CORPORATION' and
The United States of America; unincorporated, i.e., the people of the non-political- aggregate.

25 :debenture means: **DEBENTURE**. A certificate given, in pursuance of law, by the collector of a port of
entry, for a certain sum, due by the United States, payable at a time therein mentioned, to an importer
for drawback of duties on merchandise imported and exported by him, provided the duties arising on
the importation of the said merchandise shall have been discharged prior to the time aforesaid. Vide
Act of Congress of March 2, 1799, s. 80; Encyclop6die, h. t.; Dane's Ab. Index, h. t.

26 *Ibid* 19; :Birth-day' means: the 20th day, November, year of our Lord 1958 A.D. at: 11:35 a.m. Birth.
The act of being wholly brought into the world. The whole body must be detached from that of the
mother, in order to make the birth complete. 5 C. & P. 329; S. C. 24 E. C. L. R. 344 6 C. & P. 349; S. C.
25 E. C. L. R. 433.

day. A division of time. It is natural, and then it consists of twenty-four hours, or the space of time which
elapses while the earth makes a complete revolution on its axis; or artificial, which contains the time,
from the rising until the setting of the sun, and a short time before rising and after setting. Vide Night;
and Co. Lit. 135, a.

2. Days are sometimes calculated exclusively, as when an act required that an appeal should be made
within twenty days after a decision. 3 Penna. 200; 3 B. & A. 581; 15 Serg. & Rawle, 43. In general, if a
thing is to be done within such a time after such a fact, the day of the fact shall be taken inclusively.
Hob. 139; Doug. 463; 3 T. R. 623; Com. Dig. Temps, A; 3 East, 407.

3. The law, generally, rejects fractions of days, but in some cases it takes notice of such parts: 2 B. & A.
586. Vide Date.

27 *Idem-sonans* means: **IDEM SONANS**. Sounding the same.

2. In pleadings, when a name which it is material to state, is wrongly spelled, yet if it be *idem sonans*
with that proved, it is sufficient; as *Segrave* for *Seagrave*, 2 Str. R. 889; *Keen* for *Keene*; *Thach*. Cr.
Cas. 67; *Deadema* for *Diadema*, 2 Ired. 346; *Hutson* for *Hudson*, 7 Miss. R. 142; *Coonrad* for *Conrad*,
8 Miss. R. 291. See 5 Pike, 72; 6 Ala. R. 679; vide also *Russ. & Ry.* 412; 2 Taunt. R. 401, in the
following cases the variances there mentioned were declared to be fatal. *Russ. & Ry.* 351; 10 East, R.
83; 5 Taunt. R. 14; 1 Baldw. R. 83; 2 Crom. & M. 189; 6 Price, R. 2; 1 Chit. R. 659; 13 E. C. L. R. 194.
See, generally, 8 Chit. Pr. 231, 2; 4 T. R. 611; 3 B. & P. 559; 1 Stark. R. 47; 2 Stark. R. 29; 3 Camp. R.
29; 6 M. & S. 45; 2 N. H. Rep. 557; 7 S. & R. 479; 3 Caines, 219; 1 Wash. C. C. R. 285; 4 Cowen, 148
and the article Name.

28 **Subrogation** means: **SUBROGATION**, civil law, contracts. The act of putting by a transfer, a person in
the place of another, or a thing in the place of another thing. It is the substitution (q. v.) of a new for an
old creditor, and the succession to his rights, which is called subrogation; *transfusio unius creditoris*
in alium. It is precisely the reverse of delegation. (q. v.)

2. There are three kinds of subrogation: 1. That made by the owner of a thing of his own free will;
example, when he voluntarily assigns it. 2. That which arises in consequence of the law, even without

:Claim - :Right for us of :Property-held-without-right in: Dry-Trust: EBA-1933 A.D - 2003 A.D.-
Presentment: USPS RE 047 610 440 US May 18, 2020 4 / 9

2022-011769 MISC Page: 1490 of 2782
09/26/2022 03:35:37 PM Receipt #: 22-9381
Rec Fee: \$30.00 Darrell James Hill
Gila County, Az, Sadie Jo Bingham, Recorder

1487

5. :i- man am my brother's keeper as the :ambassador of the :Almighty-God, and openly-accept herenow the duty as the :kinsman- redeemer³² for the unknown -creditors to the :extinct- 'EBA-1933-A.D.' -:completed-trust -contract, aka 'dry-trust'³³, and, as such, for: a) the :tribes of :Ysrael, and: b) for the people understanding the :Almighty-God.

:Declaration of the Beneficiary & :Priority-Creditor of the EBA-1933-A.D. -:dry-trust

6. :i- man -:Darrell-James: Hill, :Executor declare³⁴ that :i- man am: (a) :beneficiary -:remainderman³⁵ and :priority-creditor in the remedial :equitable- right³⁶ and ownership of the principal and proceeds from the extinct 'EBA-1933-A.D.' -contract according to

the consent of the owner; example, when a man pays a debt which could not be properly called his own, but which nevertheless it was his interest to pay, or which he might have been compelled to pay for another, the law subrogates him to all the rights of the creditor. Vide 2 Binn. Rep. 382; White's L. C. in Eq.* 60-72. 3. That which arises by the act of law joined to the act of the debtor; as, when the debtor borrows money expressly to pay off his debt, and with the intention of substituting the lender in the place of the old creditor. 7 Toull. liv. 3, t. 3, c. 5, sect. 1, §2. Vide Civ. Code of Louisiana, art. 2155 to 2158; Merl. Repert. h. t.; Dig. lib. 20; Code, lib. 8, t. 18 et 19 9 Watts. R. 451; 6 Watts & Serg. 190; 2 Bouv. Inst. n. 1413.

29 Ibid 19; 'berth-date' means: the 28th day, November, year of our Lord 1958 A.D., in the 244th year of the United States.

Berth: (v.) 1660s, of ships, from berth (n.). Of persons (intransitive), from 1886. Related: Berthed; berthing.

berth (n.) 1620s, "convenient sea room" (both for ships and sailors), of uncertain origin, probably from bear (v.) + abstract noun suffix -th (2) as in strength, health, etc. Original sense is preserved in phrase to give (something or someone) wide berth. Meaning "place on a ship to stow chests, room for sailors" is from 1706; extended to non-nautical situations by 1778.

Date. The designation or indication in an instrument of writing, of the time, and usually of the time and place, when and where it was made. When the place is mentioned in the date of a deed, the law intends, unless the contrary appears, that it was executed at the place of the date. Plowd. 7 b., 31 H. VI. This word is derived from the Latin datum, because when deeds and agreements were written in that language, immediately before the day, month and year in which they were made, was set down, it was usual to put the word datum, given.

2. All writings ought to bear a date, and in some it is indispensable in order to make them valid, as in policies of insurance; but the date in these instruments is not inserted in the body of the writing because as each subscription makes a separate contract, each underwriter sets down the day, month and year he makes his subscription. Marsh. Ins. 336.

3. Deeds, and other writings, when the date is an impossible one, take effect from the time of deliver; the presumption of law is, that the deed was dated on the day it bears date, unless, as just mentioned, the time is impossible; for example, the 32d day of January.

4. The proper way of dating, is to put the day, month, and year of our Lord; the hour need not be mentioned, unless specially required; an instance of which may be taken from the Pennsylvania Act of the 16th June, 1836, sect. 40, which requires the sheriff, on receiving a writ of fieri facias, or other writ of execution, to endorse thereon the day of the month, the year, and the hour of the day whereon he received the same.

5. In public documents, it is usual to give not only the day, the month, and the year of our Lord, but also the year of the United States, when issued by authority of the general government; or of the commonwealth, when issued under its authority. Vide, generally, Bac. Ab. Obligations, C; Com. Dig. Fait, B 3; Cruise, Dig. tit. 32, c. 20, s. 1-6; 1 Burr. 60; 2 Rol. Ab. 27, 1. 22; 13 Vin. Ab. 34; Dane's Ab. Index, h. t. See Almanac.

30 :non-political -over-standing -aggregate means: the body of people from whom :government is derived; also, :non-actors/citizens in the daily administration of the government service.

31 :Ambassador means: Ibid 7.

:Claim - :Right for us of :Property-held-without-right in: Dry-Trust: EBA-1933 A.D - 2003 A.D.- Presentment: USPS RE 047 610 440 US May 18, 2020 5 / 9

2022-011769 MISC Page: 1491 of 2782
09/26/2022 03:35:37 PM Receipt #: 22-9381
Rec Fee: \$30.00 Darrell James Hill
Gila County, Az; Sadie Jo Bingham, Recorder

1488

Equity-Claim :Presentment: USPS RE 047 610 440 US -May 15th, 2020 A.D

the Law; and: (b) the :kinsman-redeemer for all :unknown-creditors no-longer-desposed³⁷ as :surety³⁸ for the 'United-States-of-America,-incorporated'³⁹ -government-services- :provider's -bankruptcy which was mitigated by the EBA-1933-A.D. -indenture, administered by the person: 'UNITED STATES Incorporated'-government-services- provider -:Trustee for the United-States-of-America,- Incorporated: 1933- A.D.; et al., et seq. -: debenture to: The united States of America - people, et seq. -: i- man :Darrell-James ~ 1958 A.D.

B. :Trustee -:Trump is The Trustee To This :Presentment: USPS :RE 047 610 440 US, May 18th, 2020 A.D., For This Exercise Of The Right By:i- man With The Conveyance Of Assets To :i- man ByThe Emergency Banking Act Of 1933 A.D. under Law

7. :You are the Trustee of the extinct- 'EBA-1933-A.D.' -:completed-trust- principal which should ought-to have-been conveyed to :i-man, et al. in the year of our Lord: 2003 A.D.; and, now ought-be made so: post-haste, agreeably, and with :all -principal-property in :all- accounts, :chattel and land conveyed to a) :i- man- sole, and b) :i-man -kinsman-redeemer.

All Previous Notices To You Are Acquiesced By :you, et al.

8. :This is the second beneficiary request from :i- man to you, et al., for :trust-information for to settle-and-close the :accounts of the extinct- 'EBA-1933-A.D.' -dry-trust. All previous contacts are answered in the response of the :silent- acquiescence.

9. Ignoring :this -Trustee- duty and obligation for to release :all of the property belonging to :i- man is the :same- :wrong-doing as :abandonment of :your fiduciary-duty and oath-of-office to uphold: The Constitution for the United States of America, et al. -:Bill-of-Rights.

C. Remedy

10. :Where-as the 'Emergency Banking Act of 1933' -2003 A.D. is a :dry-trust

32 :Kinsman-redeemer means: a relative, male, who delivers a family member from bondage, or sin, or penalties who stands in the gap of the need for the family -unprotected: a relative who delivers a family member from bondage, or sin, or penalties.

33 :dry-trust means: the end/ extinction of the trust upon the completion of its duties by the consent and demand of :i- man, et al., beneficiary for the restoration of :all of the trust-property.

34 declare means: to make known explicitly and plainly by the full statement as being in one's possession or ownership.

35 :Remainderman means: heir, one who inherits; - a person who inherits or is entitled to inherit property upon the termination of the estate

36 remedial :equitable- right means: Remedy, exercise in the choice to attain the right of a contract of which one injured is agreed- by :Law, :entitled.

37 desposed means: government rule forced -upon :people whether by an overt-wrong or otherwise under the guise of a :remedy; despotism.

38 :surety means: contracts. One bound for the payment of a sum of money or for the performance of something else, for another, who is already bound for the same

39 'United-States-of-America,-incorporated' means: The government of the united States of America, fashioned under the auspices by the Executive Branch with the Lieber Code upon the American -Civil-War -Crisis: 1861 -A.D.

:Claim - :Right for us of :Property-held-without-right in: Dry-Trust: EBA-1933 A.D - 2003 A.D.- Presentment: USPS RE 047 610 440 US May 18, 2020 6 / 9

2022-011769 MISC Page: 1492 of 2782
09/26/2022 03:35:37 PM Receipt #: 22-9381
Rec Fee: \$30.00 Darrell James Hill
Gila County, Az, Sadie Jo Bingham, Recorder

1489

-:indenture,

- a) administrating the :property without right is now :willful- wrong-doing;
- b) the :Full-Accounting to the penny is required/requested/demanded/ordered-; and:
- c) :You are required/requested/demanded/ordered to restore :all- property to :i-man- sole upon your receipt of the returned- debenture of the EBA-1933-A.D.- :dry-trust indenture for the settle and close of all accounts.

D. :i- man :Beneficiary And Priority-Creditor Now Herein Expressively Return To The Trustee- :Donald-John: Trump The :EBA-1933-A.D. - :Debenture Expressively Provided For To Settle-And-Close :All-Accounts; And Convey :All - Property To :i-man: Darrell-James Post-Haste,

:Authenticated -:Debenture to :Darrell-James: Hill

11. See the :Authenticated -:certified-debenture ~appended: 3 pages~ returned herein for the settle and close of :all- accounts in the extinct- 'EBA-1933-A.D.' -:dry-trust, for the restoration of :all property to :i- man post-haste.

:Declaration :Beneficiary& :Priority-Creditor: EBA-1933-A.D. -:dry-trust

12. :i- man -:Darrell-James: Hill, :Executor declare⁴⁰ comprehension now that :i-man am a) :beneficiary -:remainderman and :priority-creditor in the remedial :equitable-right⁴¹ and ownership of the principal and proceeds by/according to the Law by the extinction of the 'EBA-1933-A.D.' -:completed-trust, and b) the :kinsman-redeemer for :unknown-creditors no- longer desposed as :surety to the 'United-States-of-America,-incorporated'-government-services- provider's -bankruptcy mitigated by the EBA-1933-A.D.⁴² -contract with the :debenture to :The united States of America - people, -:beneficiary and priority-creditor, et seq. - :Darrell-James.

Require/request/ demand :all property upon return of the debenture

13. :i- man :Darrell-James -:beneficiary and priority-creditor to the extinct- 'EBA-1933-A.D.' -:completed-trust herein exercise the :right in :Law and equity to require/request/ demand the :trustee,et al. to assent, and to release :all property to :i-man upon the receipt of the debenture to the 'EBA-1933-A.D.' -contract. Notice to the primary Trustee is :notice to every minister; Notice upon the any minister must be expediently noticed to :Trustee, :POTUS-, :POTUSA- :Trump.

Require/Request/Demand/Order The Full-Accounting To :penny Of: Property

14. :i- man Require/ Request/ Demand /Order the :Full-Accounting to the penny for :all accounts for (1) :i- man for: all- property held nowtore and now-after by the 'Emergency Banking Act of 1933' -:dry- trust.

Return Of All Principal-Property, :Settle And Close -All Accounts -:Property And Chattel

40 declare means: to make known explicitly and plainly by the full statement as being in one's possession or ownership.

41 remedial :equitable- right means: a right of a contractual remedy to which one injured is entitled

42 'United-States-of-America,-Incorporated- :1933' -:bankruptcy means: the : bankruptcy of the corporate-government 'mitigated' by the EBA-1933-A.D., et seq. by the :Primary-Trust-Management-Organization - :Trustee for the United-States-of-America,-Incorporated: 1933- 2003- A.D: bankruptcy period: seventy years.

:Claim - :Right for us of :Property-held-without-right in: Dry-Trust: EBA-1933 A.D - 2003 A.D.- Presentment: USPS RE 047 610 440 US May 18, 2020 7 / 9

2022-011769 MISC Page: 1493 of 2782

09/26/2022 03:35:37 PM Receipt #: 22-9381

James Hill Darrell J Bingham, Recorder
Gila County, Az, Sadie Jo Bingham, Recorder



1490

15. :i- man :Darrell-James: Hill, :Executor, :priority- creditor and :known -kinsman-redeemer now require/ request/demand for :you- :Trustee to make :order expressly that :all -principal⁴³ -propertyadministered in to the 'United-States-of-America,- Incorporated: 1933'- A.D. -bankruptcy ought- must- now be :settled and closed with :all -principal -property returned **post-haste** to: (1) :i- man :Darrell-James: Hill, -:Executor -:priority-creditor -:sole, and: (2) to :i-man :Darrell-James:Hill, -:Executor- :known -kinsman-redeemer for :all unknown-priority-Creditors due the surety-assets in :total-remainder.

Enclosure: 1/1: Record of live Birth Authentication ~:Birth No 134 - 58 -208851, Certified Doc.# F4012640, :State Registrar - Judith-B.: Nagy, May -9, 2018,; and: (2) OHIO- SOS -certification: C074912, :Jon: Husted, June 14, 2018; and: (3) United States of America- SOS- Authentication No. 18047749-2, :Michael -R: Pompeo, July 17, 2018 ~ **:Debenture: 3 pages.**

cc: Army, et al. JCOS :USPS RE 047 610 512 US

:Mark-Alexander :General United States Army⁴⁴ -:Chairman: CJCOS⁴⁵- :Milley,
:John-Earl :General United States Air Force: Vice- CJCOS- :Hyten,
:James-Charles :General United States Army: COS⁴⁶ Army- :McConville,
:David-Hilberry :General United States Marine Corps: CMC⁴⁷- :Berger,
:Michael-Martin :Admir.. al United States Navy/ CNO⁴⁸- :Gilday.,
:David-Lee :General United States air Force: COS AF⁴⁹- :Goldfein,
:John-William :General United States Space Force: CSO⁵⁰- :Raymond,
:Joseph-Lauren :General United States Air Force: CNG⁵¹- :Lengyel
:Karl-Leo :Admiral United States Coast Guard: CCG⁵²- :Schultz
c/o :Mark-Alexander:Milley, :USPS RE 047 610 512 US
Office: CJCOS
9999 Join Staff Pentagon
Washington, District of Columbia 20318-9999

:William-Pelham: Barr, :USPS RE 047 610 438 US
:US-AG - :Trustee -Common-Law-Trustee - Minister- :Barr and
:US-APC, -:Trustee- Minister- :Barr,
950 Pennsylvania Avenue, N.W.

- 43 :all -principal -property means: Gold, silver, chattel, land, of the original confiscation in the open accounting.
44 :General United States means: General: 'The United States of America' Army
45 :CJCOS means: Chairman: Joint Chief Of Staff
46 :COS means: Chief of Staff
47 :CMC means: Commandant of the Marine Corps
48 :CNO means: Chief of Naval Operations
49 :COS AF means: Chief of Staff of the Air Force
50 :CSO means: Chief of Space Operations
51 :CNG means: Chief of the National Guard Bureau
52 :CCG means: Commandant of the Coast Guard

:Claim - :Right for us of :Property-held-without-right in: Dry-Trust: EBA-1933 A.D - 2003 A.D.- Presentment: USPS RE 047 610 440 US May 18, 2020 8 / 9

Page: 1494 of 2782

MISC 2022-011769

Receipt # 22-9381

09/26/2022 03:35:37 PM

Darrell James Hill

Recorder

Gila County, Az, Sadie Jo Bingham

1491

Equity-Claim :Presentment: USPS RE 047 610 440 US :May 15th, 2020 A.D

Washington, District of Columbia 20530-0001

:Steve-Turner: Mnuchin, ~:USPS GMN 7008 1300 0002 2256.4705~
:US-SOT :Mnuchin, ~:Trustee - Minister,
1500 Pennsylvania Avenue, NW
Washington, District of Columbia 20220

Notice to the primary Trustee is :notice to every minister; Notice upon the any minister
must be expediently noticed to :Trustee - :POTUS-, :POTUSA- Trump.

:I- man affirm all said above is true and correct, and will state same in the open court.

Without prejudice

Darrell-James Hill, Executor

:Darrell-James Hill, :civilian :Executor, -:Beneficiary and
:Kinsman-redeemer -:Priority-Creditor in the remedial
:equitable- right by the :Emergency Banking Act of
1933' -:dry-trust with 'United-States-of-America,-
Incorporated -:1933- 2003 :bankruptcy.

Jurat

Affirmed and autographed before me this day 18 May, the year of our Lord 2020 A.D.
Type of Identification: Arizona Driver License.

Notary Public



:Claim- :Right for us of :Property-held-without-right In: Dry-Trust: EBA-1933 A.D - 2003 A.D.-
Presentment: USPS RE 047 610 440 US May 18, 2020 9/9

1492

2022-011769 MISC Page: 1495 of 2782
09/26/2022 03:35:37 PM Receipt #: 22-9381
Rec Fee: \$30.00 Darrell James Hill
Gila County, Az, Sadie Jo Bingham, Recorder



The UPS Store - #3750
 5301 S. Superstition Mountain Dr
 Ste 104
 Gold Canyon, AZ 85118
 (480) 474-9838

05/18/20 03:36 PM

We are the one stop for all your shipping, postal and business needs.

We offer all the services you need to keep your business going.



001 000003 (011) TO \$ 10.00
 Notary

SubTotal \$ 10.00
 Total \$ 10.00

Cash \$ 100.00
 Change \$ 90.00

Receipt ID 83947883956030868381 001 Items
 CSH: John Tran: 8414 Reg: 001

Thank you for visiting our store.
 Please come back again soon.

Whatever your business and personal needs, we are here to serve you.

We're here to help.
 Join our FREE email program to receive great offers and resources.

www.theupsstore.com/signup

UNITED STATES POSTAL SERVICE
REGISTERED MAIL™

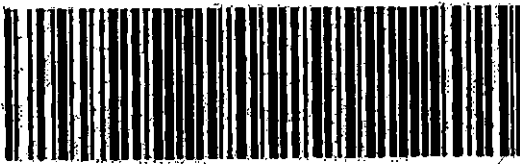

RE 047 610 440 US

Label 200, August 2005

PSN 7590-03-000-9311

Registered No.

RE322387569US

To Be Completed By Post Office	Reg. Fee	\$4.20	
	Handling Charge	\$13.20	Return Receipt
	Postage	\$2.00	Restricted Delivery
	Received by	\$0.00	

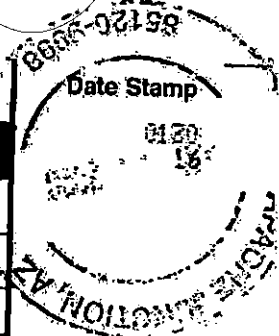

Customer Must Declare Full Value \$21.00
 Domestic Insurance up to \$25,000 is included based upon the declared value. International insurance is limited. (See Reverse).

APACHE JUNCTION, AZ 85119

FROM: Darrell James Hill, beneficiary
 96 PO Box 3806
 Apache Junction, Arizona 85117

TO: Donald John Trump, trustee
 1600 Pennsylvania Ave NW
 Washington, District of Columbia 20500

PS Form 3806, Receipt for Registered Mail Copy 1 - Customer
 May 2007 (7530-02-000-9051) (See Information on Reverse)
 For domestic delivery information, visit our website at www.usps.com

2022-011769 MISC Page: 1496 of 2782
 09/26/2022 03:35:37 PM Receipt #: 22-9381
 Rec Fee: \$30.00 Darrell James Hill
 Gila County, Az, Sadie Jo Bingham, Recorder



Unoffi

1493

151 W SUPERSTITION BLVD
APACHE JUNCTION, AZ 85120-9998
030259-0130
(800)275-8777

05/18/2020 03:35 PM

Product	Qty	Unit Price	Price
First-Class Package Service 3 Days (Domestic) (WASHINGTON, DC 20500) (Weight: 0 Lb 2.10 Oz) (Estimated Delivery Date) (Friday 05/22/2020)	1	\$4.20	\$4.20
Registered (Amount: \$21.00) (USPS Registered Mail #) (RE322387559US)			\$13.20
Return Receipt (USPS Return Receipt #) (9590940245638278430987)			\$2.85
Total:			\$20.25
Cash Change			\$100.00 (\$79.75)

Due to the security of Registered Mail, an additional 3-10 delivery days should be added to the expected delivery date provided.

In a hurry? Self-service kiosks offer quick and easy check-out. Any Retail Associate can show you how.

Text your tracking number to 28777

UNITED STATES POSTAL SERVICE
REGISTERED MAIL™



RE 047 610 440 US

Label 200, August 2005

PSN 7690-03-000-9311

Registered No.

RE322387559US

Reg. Fee	\$4.20	Return Receipt
Handling Charge	\$13.20	Restricted Delivery
Postage	\$2.85	
Received by	\$0.00	

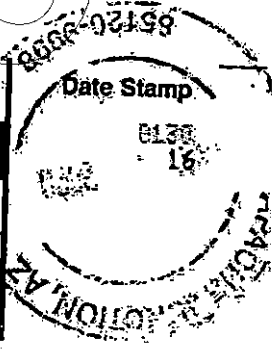

Customer Must Declare Full Value \$21.00

Domestic insurance up to \$25,000 is included based upon the declared value. International indemnity is limited. (See Reverse)

To Be Completed By Customer (Please Print) All Entries Must Be in Ballpoint or Typed

FROM: Darrell James Hill, beneficiary
90 PO Box 3806
Apache Junction, Arizona 85117

TO: Donald John Trump, trustee
1600 Pennsylvania Ave NW
Washington, District of Columbia
20500

PS Form 3806, Receipt for Registered Mail Copy 1 - Customer
May 2007 (7530-02-000-9051) (See Information on Reverse)

For domestic delivery information, visit our website at www.usps.com®



Unoffi
1494

:Darrell-James: Hill, -:civilian, -:Executor¹
c/o PO Box 3806, Apache Junction, Arizona 85117.

:man -:present

Darrell James Hill, Executor

:The united States of America,

Arizona state
Pinal county

Equity-Claim :Presentment: Express Trust:
Emergency Banking Act of 1933 A.D. - Trust²,
USPS RE 047 610 440 US -May 15th, 2020 A.D., to:

Donald-John :Trump, as :Trustee³,
:POTUSA - :Commander-In-Chief- Trustee- :Trump⁴ and
:POTUS -:TRUSTEE -:Trump⁵
:Steve-Turner: Mnuchin :USPS CMN 7008 1300 0002 2256 4705 ~
:US-SOT⁶: Mnuchin, -:Trustee - Minister⁷,

- 1 **:Darrell-James: Hill means: :Darrell-James: Hill means: Darrell-James: Hill ©1958; Ohioan, © 1958; State of Ohio: beneficiary. See: Gila county Arizona: Doc. # 2017-002378: pp. 6-24, 89-91, 93-95 of 693. Gila county Arizona: Doc. #2018-005176: pp. 10-21; and, et seq. See: :- man -file of: Specialized Negotiable Instruments to the :man - :Barak-Hussein: Obama, :Donald-John: Trump, et al., et seq.**
- 2 **:Emergency Banking Act of 1933, et al. means: Public Law 73-1/ Statutes at Large 48 Stat. 1, et al. - Trading With The Enemy Act, amended ~Subdivision (b) of section 5 of the Act of October 6, 1917 ... to read as follows: During time of war or during any other period of national emergency declared by the President... President may require any person within the United States... engaged in any transaction...be fined... imprisoned... or both... Cf. Trading with the Enemy Act of 1917, Pub.L. 65-91, 40 Stat. 411.**
- 3 **:Trustee means: 1) one to whom an estate has been conveyed in trust; trust means: TRUST, contracts, devises. An equitable right, title or interest in property, real or personal, distinct from its legal ownership; or it is a personal obligation for paying, delivering or performing anything, where the person trusting has no real right or security, for by, that act he confides altogether to the faithfulness of those intrusted. This is its most general meaning, and includes deposits, bailments, and the like. In its more technical sense, it may be defined to be an obligation upon a person, arising out of a confidence reposed in him, to apply property faithfully, and according to such confidence. Willis on Trustees, 1: 4 Kent, Com. 295; 2. Fonb. Eq. 1; 1 Saund. Uses and Tr. 6; Coop. Eq. Pl. Introd. 27; 3 Bl. Com. 431. 2) for the Emergency Banking Act of 1933, et al., et seq., 'EBA-1933-A.D.'**
- 4 **:POTUSA -Commander-in-Chief Trump means: President of The United States of America ~unincorporated~ - Commander-in-Chief, under the :Lieber Code ~ :24th day, April, the year of our Lord 1863 A.D.**
- 5 **:POTUS Trump means: President of the UNITED STATES incorporated- :government-services-provider -:Trustee.**
- 6 **:US-SOT means: UNITED STATES - Secretary of Treasury; U.S.-IMF liaison.**
- 7 **:minister means: one who acts under -upon the authority of another; e.g., :man -:ambassador of the**

:Claim - :Right for us of:Property-held-without-right In: Dry-Trust: EBA-1933 A.D - 2003 A.D.-
Presentment: USPS RE 047 610 440 US May 18, 2020 1/9.

1496

2022-011769 MISC Page: 1498 of 2782

09/26/2022 03:35:37 PM Receipt #: 22-9381
Rec Fee: \$30.00 Darrell James Hill
Gila County, Az, Sadie Jo Bingham, Recorder



Equity-Claim :Presentment: USPS RE 047 610 440 US -May 15th, 2020 A.D

:William-Pelham: Barr, :USPS RE 047 610 438 US
:US-AG⁸ - :Trustee -:Common-Law-Trustee - Minister- :Barr and
:US-APC⁹, -:Trustee- Minister- :Barr,
:Jefferson-Beauregard: Sessions III, as :Trustee - Minister, :Ex-US-AG- :Sessions,
:Matthew-George: Whitaker, as :Trustee - Minister, :Ex-US-AG: Acting- :Whitaker,
:Dana-James, Boente, as :Trustee - Minister, :Ex-US-AG- Acting- :Boente,
:Sally-Caroline, Yates, as :Trustee - Minister, :Ex-US-AG- Acting- :Yates,
c/o :Donald-John: Trump¹⁰ :USPS RE 047 610 440 US
1600 Pennsylvania Ave NW
Washington, District of Columbia 20500

re: The 'Emergency Banking Act of 1933 A.D.' - 2003 A.D., 'EBA-1933-A.D.' is
:completed-of-purpose and :extinct, then is the 'dry-trust' and ought-to-have-been
dissolved and conveyed to :i-man -:beneficiary and priority-creditor¹¹.

Greetings :Donald-John, :William-Pelham, :Steve-Turner, et al. man:

:i- man¹² hope :you are safe with :righteous- guidance and acts. This :document
is for the settle-and-close¹³ of the :1933 A.D. -trust from the Franklin-Delano, :POTUS-
POTUSA -:Roosevelt's :1933 A.D. -:New-Deal unto The united States of America -
people, et seq. - :i-man -affiant.

A) :Affiant is :man- Darrell-James: Hill, -:civilian, -:Executor¹⁴.

Most-High-God: e.g., Enoch, Yushuah (Jesus-the-Christ), Peter, Paul.

8 :US-AG means: UNITED STATES Attorney General

9 :APC means: Alien-Property-Custodian means: the duty and obligation to take charge of the
property of alien enemies; e.g., the :common law trustee- minister for the EBA-1933-A.D., et al-
:TWEA of 1917 A.D., as amended, by the authority of the POTUS under Law.

10 :Donald-John: Trump means: the :man -trustee under the duty, obligation and moral-Oath of Office:
20th day of January, the year our Lord 2020 A.D.~, ministry: 1) as :President of The United States of
America ~unincorporated, 1776 A.D.~- - Commander-in-Chief. And, with the :General Order 100
~Lieber Code~ :24th day, April, the year of our Lord 1863 A.D. by :Constitution for the United States of
America Law, as 2) the President of the UNITED STATES incorporated- :government-services-
provider- :Trustee: by: U.S. Constitution policy and martial law, the 87th year of the United States.

11 :Priority-Creditor means: one to whom compensation is made before any other debt is paid

12 :i- man means: 'i' refers to :Almighty-God as the great 'i- am'. And: 'i- man/' 'i-man' acknowledges
that the Almighty-God -created the 'man' is present.

13 :settle and close of all accounts means: TO #1: restore :all :gold, silver, chattel by: (A) from the Total
assets of :all :accounts of :i-man-beneficiary (B) now pay-off the Total :public- debt -account- obligation
for :i- man; now, then (C) merge the two accounts into a (D) new :private-revocable-trust for :i- man,
and (D) continue the status of :investment. Now, (E) Set-up an :L.L.C-type - account for to receive
:payment- proceeds for the non-commercial- :cestui-que-use from (D) the: 'new: :private-revocable-
trust for :i- man' without prejudice; and: #2: restore all lands to :i- man, et seq. in :allodium.

14 :ibid 1.

:Claim - :Right for us of :Property-held-without-right in: Dry-Trust: EBA-1933 A.D - 2003 A.D.-
Presentment: USPS RE 047 610 440 US May 18, 2020 2 / 9

2022-011769 MISC Page: 1499 of 2782

09/26/2022 03:35:37 PM Receipt #: 22-9381
Rec Fee: \$30.00 Darrell James Hill
Gila County, AZ, Sadie Jo Bingham, Recorder



1496

1. :i- man, :beneficiary¹⁵ -by-:birth¹⁶ of the inherent -trust¹⁷ from :Almighty God¹⁸~ where nothing stands between :Almighty-God and :i- man ~ am: (1) :Executor- Darrell-James: Hill © 1958 A.D., :Ohioan¹⁹, in the fullness of age, and of :sound- mind; (2) by :birth :Negro²⁰ -:beneficiary of the :Emancipation- Proclamation -1863²¹, and forever-guaranteed -:protection by the Army, et al., by the full- force and authority of The Constitution for the United States of America ~ 1789-1791~²²; and: (3) :beneficiary of the ':United-States-of-America,-Incorporated' -:government²³ -services-provider-Trustee's :self-indenture²⁴ to :i-man: with the debenture²⁵ ²⁶ created in the 'idem-sonans²⁷ -:subrogation²⁸ entitled: DARRELL JAMES HILL~ & et al. derivatives~ © 1958

15 :beneficiary means: one onto whom a :trust-benefit is demonstrated by the execution by the :Executor of the beneficiary's use of the trust- property.

16 :birthed :son of :Clarence, :son of :James, :son ':Negroland, :Kingdom-of-Judah, :Africa', ...:son :Ysrael- :Southern-Kingdom ~ of the sons :Judah and Benjamin and Levi, et al., ...:son of :Jacob and :Ysrael, :son of :Isaac, :son of :Abram and :Abraham, ...:son of :Shem, :son of :Noah, ...:son of :Methuselah, :son of :Enoch, ...:son of :Seth, :son of :Adam with :Eve of the garden of :Eden ~ including all :known and unknown :ancestral- lands ~ on the earth placed under the Adamic- lineage and under the :only-begotten -son of the Most-High-God and Father embodied within the rebirth by :i-man of the power of :Yushuah-Messiah, -:God, with the redemption by the Messiah- Yushuah (:Jesus-the-Christ), and encompassing the :receivership, responsibility and administration over :all of the earth-planet as :heir - :remainderman, and :Kinsman- :redeemer of the Earth, both from the Adamic-lineage by the :loss in :spirit in the man upon the Earth, and by the Messiah-Yushuah by the restoration in :spirit in the man upon the Earth: on, in or under-the-surface of the planet; :on, in or under-the-surface of the oceans and waters, and :on, in, under-the-surface of the atmosphere/ above the atmosphere of the Earth to wherever the :Adamic- man- kind in the quantum and in the spirit is, of :where the :purposes of the Most High God and Father are immeasurable by mere :man.

17 inherent -trust means: that trust is given by the Creator- :Almighty-God -grantor to :i-man- kind -beneficiary as the steward of the realm, e.g., :gravity, water, air, land, and man- beneficiary.

18 :Almighty God means: a) the :Creator of the worlds: embodied as :Yushuah the Messiah ~a.k.a. Jesus the Christ~ the only begotten son of the Most High God, b) He who for our sake for our redemption did ly down His glory, birthed as man-kind onto our earth-planet, fulfilled all of the word, Law and prophesy, then layed-down his :life, giving his life for to atone for our sins so that :man- kind -whosoever-will may become like Him, in the fullness of that stature, sons of the Most-High-God.

19 See: Record of live Birth means: Authentication ~:Birth No 134 - 58 -208851, Certified Doc.# F4012640.:State Registrar - Judith-B. Nagy, May -9, 2018.; and: (2) OHIO- SOS -certification: C074912, :Jon: Husted, June 14, 2018; and: (3) The United States of America- SOS- Authentication No. 18047749-2, :Michael -R: Pompeo, July 17, 2018 ~ :Debenture; appended: 3 pages.

20 Ibid 16.

21 Emancipation Proclamation of 1863 means: Proclamation 95 from POTUSA Abraham Lincoln on September 22nd, 1862: effective :January 1st, 1863.

EMANCIPATION. An act by which a person, who was once in the power of another, is rendered free. By the laws of Louisiana, minors may be emancipated. Emancipation is express or implied.

2. Express emancipation. The minor may be emancipated by his father, or, if he has no father, by his mother, under certain restrictions. This emancipation takes place by the declaration, to that effect, of the father or mother, before a notary public, in the presence of two witnesses. The orphan minor may, likewise, be emancipated by the judge, but not before he has arrived at the full age of eighteen years, if the family meeting, called to that effect, be of opinion that he is able to administer his property. The minor may be emancipated against the will of his father and mother, when they ill treat him excessively, refuse him support, or give him corrupt example.

22 The Constitution for the United States of America ~ 1789-1791~ means: The :original – organic -constitution and includes the ':Bill of Rights', et al.

23 ':United-States-corporation' -:government means: 'United-States-of -America- -:corporation'

:Claim - :Right for us of :Property-held-without-right in: Dry-Trust: EBA-1933 A.D - 2003 A.D.- Presentment: USPS RE 047 610 440 US May 18, 2020 3 / 9

2022-011769 MISC Page: 1500 of 2782

09/26/2022 03:35:37 PM Received # 22-9381
Darrell James Hill
Rec Fee: \$30.00
Gila County, Az, Sadie Jo Birmingham, Recorder



1497

A.D., :State-of-Ohio²⁹ by the 'Emergency Banking Act of 1933, et al.', 'EBA-1933-A.D.'
-Trust (ended :2003 A.D.);

2. :i- man am :member of the non-political -aggregate³⁰;
3. :i- man am the literate, legalese-idiot -non-member of the :B.A.R.- legal -society.
:i man am the :Christian -Ambassador³¹ of the Almighty-God
4. :Almighty-God, -Yushuah -the -Messiah (aka: Jesus-the-Christ) who prophetically came to this planet, was birthed -:man, healed :man-kind, died for :man-kind, did resurrect, and now sits at the right-hand of his Father, the :Most-High-God, in Heaven; :i- man am a :disciple of that Messiah Yushuah's teaching and spiritual guidance. :Thereto,

-:government -services -provider -Trustee: status post :1862 A.D., e.g., (1) cf :2020: Donald-John: POTUS Trump- Trustee/ EBA-1933-A.D. :CIC acting under U.S. Constitution - incorporated, and (2) cf. :Donald-John: POTUSA Trump. :CIC understanding The Constitution for the United States of America - unincorporated.

24 :indenture means: **INDENTURE**, conveyancing. An instrument of writing containing a conveyance or contract between two or more persons, e.g., as between the ':UNITED-STATES-CORPORATION' and 'The United States of America, unincorporated, i.e., the people of the non-political- aggregate.

25 :debenture means: **DEBENTURE**. A certificate given, in pursuance of law, by the collector of a port of entry, for a certain sum, due by the United States, payable at a time therein mentioned, to an importer for drawback of duties on merchandise imported and exported by him, provided the duties arising on the importation of the said merchandise shall have been discharged prior to the time aforesaid. Vide Act of Congress of March 2, 1799, s. 80; Encyclop6die, h. t.; Dane's Ab. Index, h. t.

26 **Ibid 19; 'Birth-day'** means: the 20th day, November, year of our Lord 1958 A.D. at: 11:35 a.m. Birth. The act of being wholly brought into the world. The whole body must be detached from that of the mother, in order to make the birth complete. 5 C. & P. 329; S. C. 24 E. C. L. R. 344 6 C. & P. 349; S. C. 25 E. C. L. R. 433.

day. A division of time. It is natural, and then it consists of twenty-four hours, or the space of time which elapses while the earth makes a complete revolution on its axis; or artificial, which contains the time, from the rising until the setting of the sun, and a short time before rising and after setting. Vide Night; and Co. Lit. 135, a.

2. Days are sometimes calculated exclusively, as when an act required that an appeal should be made within twenty days after a decision, 3 Penna. 200; 3 B. & A. 581; 15 Serg. & Rawle, 43. In general, if a thing is to be done within such a time after such a fact, the day of the fact shall be taken inclusively. Hob. 139; Doug. 463; 3 T. R. 623; Com. Dig. Temps, A; 3 East, 407.

3. The law, generally, rejects fractions of days, but in some cases it takes notice of such parts. 2 B. & A. 586. Vide Daté.

27 **Idem-sonans** means: **IDEM SONANS**. Sounding the same.

2. In pleadings, when a name which it is material to state, is wrongly spelled, yet if it be idem sonans with that proved, it is sufficient, as Segrave for Seagrave, 2 Str. R. 889; Keen for Keene, Thach. Cr. Cas. 67; Deadema for Diadema, 2 Ired. 346; Hutson for Hudson, 7 Miss. R. 142; Coonrad for Conrad, 8 Miss. R. 291. See 5 Rike, 72; 6 Ala. R. 679; vide also Russ. & Ry. 412; 2 Taunt. R. 401. In the following cases the variances there mentioned were declared to be fatal. Russ. & Ry. 351; 10 East, R. 83; 5 Taunt. R. 14; 1 Baldw. R. 83; 2 Crom. & M. 189; 6 Price, R. 2; 1 Chit. R. 659; 13 E. C. L. R. 194. See, generally, 8 Chit. Pr. 231, 2; 4 T. R. 611; 3 B. & P. 559; 1 Stark. R. 47; 2 Stark. R. 29; 3 Camp. R. 29; 6 M. & S. 45; 2 N. H. Rep. 557; 7 S. & R. 479; 3 Caines, 219; 1 Wash. C. C. R. 285; 4 Cowen, 148 and the article Name.

28 **Subrogation** means: **SUBROGATION**, civil law, contracts. The act of putting by a transfer, a person in the place of another, or a thing in the place of another thing. It is the substitution (q. v.) of a new for an old creditor, and the succession to his rights, which is called subrogation; transfusio unius creditoris in alium. It is precisely the reverse of delegation. (q. v.)

2. There are three kinds of subrogation: 1. That made by the owner of a thing of his own free will; example, when he voluntarily assigns it. 2. That which arises in consequence of the law, even without

:Claim - :Right for us of :Property-held-without-right in: Dry-Trust: EBA-1933 A.D - 2003 A.D.- Presentment: USPS RE 047 610 440 US May 18, 2020 4 / 9

1498

5. :i- man am my brother's keeper as the :ambassador of the :Almighty-God, and openly-accept herenow the duty as the :kinsman- redeemer³² for the unknown -creditors to the :extinct- 'EBA-1933-A.D.' -:completed-trust -contract, aka ':dry-trust'³³, and, as such, for: a) the :tribes of :Ysrael, and: b) for the people understanding the :Almighty-God.

:Declaration of the Beneficiary & :Priority-Creditor of the EBA-1933-A.D. -:dry-trust

6. :i- man -:Darrell-James: Hill, :Executor declare³⁴ that :i- man am: (a) :beneficiary -:remainderman³⁵ and :priority-creditor in the remedial :equitable- right³⁶ and ownership of the principal and proceeds from the extinct 'EBA-1933-A.D.' -contract according to

the consent of the owner; example, when a man pays a debt which could not be properly called his own, but which nevertheless it was his interest to pay, or which he might have been compelled to pay for another, the law subrogates him to all the rights of the creditor. Vide 2 Binn. Rep. 382; White's L. C. in Eq.* 60-72. 3. That which arises by the act of law joined to the act of the debtor; as, when the debtor borrows money expressly to pay off his debt, and with the intention of substituting the lender in the place of the old creditor. 7 Toull. liv. 3, t. 3, c. 5, sect. 1, §2. Vide Civ. Code of Louisiana, art. 2155 to 2158; Merl. Repert. h. t.; Dig. lib. 20; Code, lib. 8, t. 18 et 19 9 Watts. R. 451; 6 Watts & Serg. 190; 2 Bouv. Inst. n. 1413.

29 Ibid 19; ':birth-date' means: the 28th day, November, year of our Lord 1958 A.D., in the 244th year of the United States.

Berth: (v.) 1660s, of ships, from berth (n.). Of persons (intransitive), from 1886. Related: Berthed; berthing.

berth (n.) 1620s, "convenient sea room" (both for ships and sailors), of uncertain origin, probably from bear (v.) + abstract noun suffix -th (2) as in strength, health, etc. Original sense is preserved in phrase to give (something or someone) wide berth. Meaning "place on a ship to stow chests, room for sailors" is from 1706; extended to non-nautical situations by 1778.

Date. The designation or indication in an instrument of writing, of the time, and usually of the time and place, when and where it was made. When the place is mentioned in the date of a deed, the law intends, unless the contrary appears, that it was executed at the place of the date. Plowd. 7 b., 31 H. VI. This word is derived from the Latin datum, because when deeds and agreements were written in that language, immediately before the day, month and year in which they were made, was set down, it was usual to put the word datum, given.

2. All writings ought to bear a date, and in some it is indispensable in order to make them valid, as in policies of insurance, but the date in these instruments is not inserted in the body of the writing because as each subscription makes a separate contract, each underwriter sets down the day, month and year he makes his subscription. Marsh. Ins. 336.

3. Deeds, and other writings, when the date is an impossible one, take effect from the time of deliver; the presumption of law is, that the deed was dated on the day it bears date, unless, as just mentioned, the time is impossible; for example, the 32d day of January.

4. The proper way of dating, is to put the day, month, and year of our Lord; the hour need not be mentioned, unless specially required; an instance of which may be taken from the Pennsylvania Act of the 16th June, 1836, sect. 40, which requires the sheriff, on receiving a writ of fieri facias, or other writ of execution, to endorse thereon the day of the month, the year, and the hour of the day whereon he received the same.

5. In public documents, it is usual to give not only the day, the month, and the year of our Lord, but also the year of the United States, when issued by authority of the general government; or of the commonwealth, when issued under its authority. Vide, generally, Bac. Ab. Obligations, C; Com. Dig. Fait, B 3; Cruise, Dig. tit, 32, c. 20, s. 1-6; 1 Burr. 60; 2 Rol. Ab. 27, 1. 22; 13 Vin. Ab. 34; Dane's Ab. Index, h. t. See Almanac.

30 :non-political -:over-standing -aggregate means: the body of people from whom :government is derived; also, :non-actors/citizens in the daily administration of the government service.

31 :Ambassador means: Ibid 7.

:Claim - :Right for us of :Property-held-without-right in: Dry-Trust: EBA-1933 A.D - 2003 A.D.- Presentment: USPS RE 047 610 440 US May 18, 2020 5 / 9

2022-011769 MISC Page: 1502 of 2782

09/26/2022 03:35:37 PM Receipt #: 22-9381

Rec Fee: \$30.00 Darrell James Hill
Gila County, Az, Sadie Jo Bingham, Recorder



1499

Equity-Claim :Presentment: USPS RE 047 610 440 US -May 15th, 2020 A.D

the Law; and: (b) the :kinsman-redeemer for all :unknown-creditors no-longer-deposed³⁷ as :surety³⁸ for the 'United-States-of-America,-incorporated'³⁹-government-services- :provider's -bankruptcy which was mitigated by the EBA-1933-A.D. -indenture, administered by the person: 'UNITED STATES Incorporated'-government-services- provider -:Trustee for the United-States-of-America,-Incorporated: 1933- A.D., et al., et seq. - :debenture to: The united States of America - people, et seq. - :i- man :Darrell-James ~ 1958 A.D.

B. :Trustee -:Trump is The Trustee To This :Presentment: USPS :RE 047 610 440 US, May 18th, 2020 A.D., For This Exercise Of The Right By :i- man With The Conveyance Of Assets To :i- man ByThe Emergency Banking Act Of 1933 A.D. under Law

7. :You are the Trustee of the extinct- 'EBA-1933-A.D.' -:completed-trust- principal which should ought-to have-been conveyed to :i-man, et al. in the year of our Lord: 2003 A.D.; and, now ought-be made so: post-haste, agreeably, and with :all -principal-property in :all- accounts, :chattel and land conveyed to a) :i- man- sole, and b) :i-man -kinsman-redeemer.

All Previous Notices To You Are Acquiesced By :you, et al.

8. :This is the second beneficiary request from :i- man to you, et al., for :trust-information for to settle-and-close the :accounts of the extinct- 'EBA-1933-A.D.' -dry-trust. All previous contacts are answered in the response of the :silent- acquiescence.

9. Ignoring :this -Trustee- duty and obligation for to release :all of the property belonging to :i- man is the :same- :wrong-doing as :abandonment of :your fiduciary-duty and oath-of-office to uphold: The Constitution for the United States of America, et al. -:Bill-of-Rights.

C. Remedy

10. :Where as the :Emergency Banking Act of 1933' -2003 A.D. is a :dry-trust

32 :Kinsman-redeemer means: a relative, male, who delivers a family member from bondage, or sin, or penalties who stands in the gap of the need for the family -unprotected: a relative who delivers a family member from bondage, or sin, or penalties.

33 :dry-trust means: the end/ extinction of the trust upon the completion of its duties by the consent and demand of :i- man, et al.,beneficiary for the restoration of :all of the trust-property.

34 declare means: to make known explicitly and plainly by the full statement as being in one's possession or ownership.

35 :Remainderman means: heir, one who inherits; - a person who inherits or is entitled to inherit property upon the termination of the estate

36 remedial :equitable- right means: Remedy, exercise in the choice to attain the right of a contract of which one injured is agreed- by :Law, :entitled.

37 desposed means: government rule forced -upon :people whether by an overt-wrong or otherwise under the guise of a :remedy; despotism.

38 :surety means: contracts. One bound for the payment of a sum of money or for the performance of something else, for another, who is already bound for the same

39 'United-States-of-America,-incorporated' means: The government of the united States of America, fashioned under the auspices by the Executive Branch with the Lieber Code upon the American -Civil-War -Crisis: 1861 -A.D.

:Claim - :Right for us of :Property-held-without-right in: Dry-Trust: EBA-1933 A.D - 2003 A.D.- Presentment: USPS RE 047 610 440 US May 18, 2020 6 / 9

2022-011769 MISC Page: 1503 of 2782

09/26/2022 03:35:37 PM Receipt #: 22-9381

Rec Fee: \$30.00 Darrell James Hill Recorder
Gila County, Az, Sadie Jo Bingham



1500

:-indenture,

- a) administrating the :property without right is now :willful- wrong-doing;
- b) the :Full-Accounting to the penny is required/requested/demanded/ordered- ; and:
- c) :You are required/requested/demanded/ordered to restore :all- property to :i- man- sole upon your receipt of the returned- debenture of the EBA-1933-A.D. - :dry- trust indenture for the settle and close of all accounts.

D. :i- man :Beneficiary And Priority-Creditor Now Herein Expressively Return To The Trustee- :Donald-John: Trump The :EBA-1933-A.D. - :Debenture Expressively Provided For To Settle-And-Close :All-Accounts, And Convey :All - Property To :i- man: Darrell-James Post-Haste.

:Authenticated -:Debenture to :Darrell-James: Hill

11. See the :Authenticated -:certified-debenture ~appended: 3 pages~ returned herein for the settle and close of :all- accounts in the extinct- 'EBA-1933-A.D.' -:dry- trust, for the restoration of :all property to :i- man post-haste.

:Declaration :Beneficiary& :Priority-Creditor: EBA-1933-A.D. -:dry-trust

12. :i- man -:Darrell-James: Hill, :Executor declare⁴⁰ comprehension now that :i- man am a) :beneficiary -:remainderman and :priority-creditor in the remedial :equitable-right⁴¹ and ownership of the principal and proceeds by/according to the Law by the extinction of the 'EBA-1933-A.D.' -:completed-trust, and b) the :kinsman-redeemer for :unknown-creditors no- longer desposed as :surety to the 'United-States-of- America,-incorporated'-government-services- provider's -bankruptcy mitigated by the EBA-1933-A.D.⁴² -contract with the :debenture to :The united States of America – people, -:beneficiary and priority-creditor, et seq. - :Darrell-James.

Require/request/ demand :all property upon return of the debenture

13. :i- man :Darrell-James -:beneficiary and priority-creditor to the extinct- 'EBA- 1933-A.D.' -:completed-trust herein exercise the :right in :Law and equity to require/request/ demand the :trustee,et al. to assent, and to release :all property to :i- man upon the receipt of the debenture to the 'EBA-1933-A.D.' -contract. Notice to the primary Trustee is :notice to every minister; Notice upon the any minister must be expediently noticed to :Trustee, :POTUS-, :POTUSA- :Trump.

Require/Request/Demand/Order The Full-Accounting To :penny Of: Property

14. :i- man Require/ Request/ Demand /Order the :Full-Accounting to the penny for :all accounts for (1) :i- man for: all- property held nowtofore and now-after by the 'Emergency Banking Act of 1933' -:dry- trust.

Return Of All Principal-Property, :Settle And Close -All Accounts -:Property And Chattel

40 **declare means:** to make known explicitly and plainly by the full statement as being in one's possession or ownership.

41 **remedial :equitable- right means:** a right of a contractual remedy to which one injured is entitled

42 **'United-States-of-America,-Incorporated- :1933' -:bankruptcy means:** the : bankruptcy of the corporate-government 'mitigated' by the EBA-1933-A.D., et seq. by the :Primary-:Trust-Management- Organization - :Trustee for the United-States-of-America,-Incorporated: 1933- 2003- A.D. bankruptcy period: seventy years.

:Claim - :Right for us of :Property-held-without-right in: Dry-Trust: EBA-1933 A.D - 2003 A.D.- Presentment: USPS RE 047 610 440 US May 18, 2020 7 / 9

2022-011769 MISC Page: 1504 of 2782
09/26/2022 03:35:37 PM Receipt #: 22-9381
Rec Fee: \$30.00 Darrell James Hill
Gila County, Az, Sadie Jo Bingham, Recorder



1501

Equity-Claim :Presentment: USPS RE 047 610 440 US -May 15th, 2020 A.D

15. :i- man :Darrell-James: Hill, :Executor, :priority- creditor and :known -kinsman-redeemer now require/ request/demand for :you- :Trustee to make :order expressly that :all -principal⁴³ -propertyadministered in to the 'United-States-of-America,- Incorporated: 1933'- A.D. -bankruptcy ought- must- now be :settled and closed with :all -principal -property returned **post-haste** to: (1) :i- man :Darrell-James: Hill, -:Executor -:priority-creditor -:sole, and: (2) to :i-man :Darrell-James:Hill, -:Executor- :known -:kinsman-redeemer for :all unknown-priority-Creditors due the surety-assets in :total-remainder.

Enclosure: 1/1: Record of live Birth Authentication ~:Birth No 134 - 58 -208851, Certified Doc.# F4012640,:State Registrar - Judith-B.: Nagy, May -9, 2018.; and: (2) OHIO- SOS -certification: C074912, :Jon: Husted, June 14, 2018; and: (3) United States of America- SOS- Authentication No. 18047749-2, :Michael -R: Pompeo, July 17, 2018 ~ :Debenture: 3 pages.

cc: Army, et al. JCOS :USPS RE 047 610 512 US

:Mark-Alexander :General United States Army⁴⁴ -:Chairman: CJCOS⁴⁵- :Milley,
:John-Earl :General United States Air Force: Vice- CJCOS- :Hyten,
:James-Charles :General United States Army: COS⁴⁶ Army- :McConville,
:David-Hilberry :General United States Marine Corps: CMC⁴⁷- :Berger,
:Michael-Martin :Admir.. al United States Navy: CNO⁴⁸- :Gilday.,
:David-Lee :General United States air Force: COS AF⁴⁹- :Goldfein,
:John-William :General United States Space Force: CSO⁵⁰- :Raymond,
:Joseph-Lauren :General United States Air Force: CNG⁵¹- :Lengyel
:Karl-Leo :Admiral United States Coast Guard: CCG⁵²- :Schultz
c/o :Mark-Alexander:Milley, :USPS RE 047 610 512 US

Office: CJCOS
9999 Join Staff Pentagon
Washington, District of Columbia 20318-9999

:William-Pelham: Barr, :USPS RE 047 610 438 US
:US-AG - :Trustee -:Common-Law-Trustee - Minister- :Barr and
:US-APC, -:Trustee- Minister- :Barr,
950 Pennsylvania Avenue, N.W.

- 43 :all -principal -property means: Gold, silver, chattel, land, of the original confiscation in the open accounting.
44 :General United States means: General: 'The United States of America' Army
45 :CJCOS means: Chairman: Joint Chief Of Staff
46 :COS means: Chief of Staff
47 :CMC means: Commandant of the Marine Corps
48 :CNO means: Chief of Naval Operations
49 :COS AF means: Chief of Staff of the Air Force
50 :CSO means: Chief of Space Operations
51 :CNG means: Chief of the National Guard Bureau
52 :CCG means: Commandant of the Coast Guard

:Claim - :Right for us of :Property-held-without-right in: Dry-Trust: EBA-1933 A.D - 2003 A.D.- Presentment: USPS RE 047 610 440 US May 18, 2020 8 / 9

2022-011769 MISC Page: 1505 of 2782

09/26/2022 03:35:37 PM Receipt #: 22-9381
Darrell James Hill
Rec Fee: \$30.00
Gila County, Az, Sadie Jo Bingham, Recorder

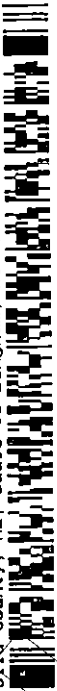

1502

Washington, District of Columbia 20530-0001

:Steve-Turner: Mnuchin, ~:USPS CMN 7008 1300 0002 2256.4705~
:US-SOT :Mnuchin, ~:Trustee - Minister,
1500 Pennsylvania Avenue, NW
Washington, District of Columbia 20220

Notice to the primary Trustee is :notice to every minister; Notice upon the any minister
must be expediently noticed to :Trustee - :POTUS-, :POTUSA- Trump.

:i- man affirm all said above is true and correct, and will state same in the open court.

Without prejudice



Darrell-James Hill, Executor

:Darrell-James Hill, :civilian :Executor, -:Beneficiary and
:Kinsman-redeemer -:Priority-Creditor in the remedial
:equitable- right by the :Emergency Banking Act of
1933' -:dry-trust with 'United-States-of-America,-
Incorporated -:1933'- 2003 :bankruptcy.

Jurat

Affirmed and autographed before me this day 18 May, the year of our Lord 2020 A.D.
Type of Identification: Arizona Driver License.

Notary Public

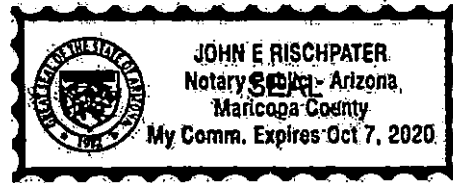

:Claim - :Right for us of :Property-held-without-right in: Dry-Trust: EBA-1933 A.D - 2003 A.D.-
Presentment: USPS RE 047 610 440 US May 18, 2020 9 / 9

2022-0111769 MISC Page: 1506 of 2782
09/26/2022 03:35:37 PM Receipt # : 22-9381
Rep Fee: \$30.00 Darrell James Hill
Gila County, Az, Sadie Jo Blinsman, Recorder

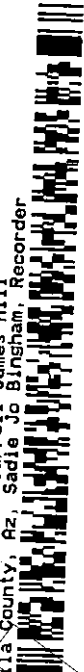

1503

THE UPS STORE - #3750
 5301 S. Superstition Mountain Dr
 Ste 104
 Gold Canyon, AZ 85118
 (480) 474-9838

05/18/20 03:36 PM

We are the one stop for all your shipping, postal and business needs.

We offer all the services you need to keep your business going.

UNITED STATES POSTAL SERVICE
REGISTERED MAIL™

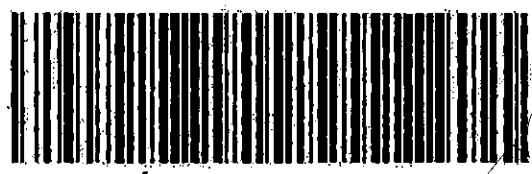

RE 047 610 440 US

Label 200, August 2005 PSN 7690-03-000-9311



001 000003 (011) TO \$ 10.00
 Notary

SubTotal \$ 10.00
 Total \$ 10.00

Cash \$ 100.00
 Change \$ 90.00-

Receipt ID 83947883956030888381 001 Items
 CSH: John Tran: 8414 Reg: 001

Thank you for visiting our store.
 Please come back again soon.

Whatever your business and personal needs, we are here to serve you.

We're here to help.
 Join our FREE email program to receive great offers and resources.

www.theupsstore.com/signup

Registered No.

RE322387559US

To Be Completed By Post Office	Reg. Fee	\$4.20	
	Handling Charge	\$13.00	Return Receipt
	Postage	\$2.85	Restricted Delivery
	Received by	\$0.00	

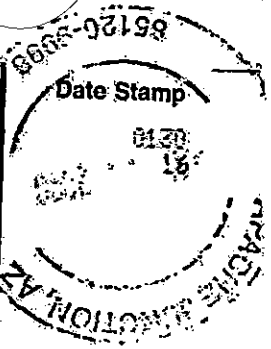

Customer Must Declare Full Value \$21.00 Domestic Insurance up to \$25,000 is included based upon the declared value. International indemnity is limited. (See Reverse).

To Be Completed By Customer (Please Print) All Entries Must Be In Ballpoint or Typed	FROM	Darrell James Hill, beneficiary 90 PO Box 3806 Apache Junction, Arizona 85117
	TO	Donald John Trump, trustee 1100 Pennsylvania Ave NW Washington, District of Columbia 20500

PS Form 3806, Receipt for Registered Mail Copy 1 - Customer
 May 2007 (7530-02-000-9051) (See Information on Reverse)
 For domestic delivery information, visit our website at www.usps.com

Unofficial
 1504

United States of America



DEPARTMENT OF STATE

To all to whom these presents shall come, Greetings:

I Certify That the document hereunto annexed is under the Seal of the Secretary of State of the State(s) of Ohio, and that such Seal(s) is/are entitled to full faith and credit.*

**For the contents of the annexed document, the Department assumes no responsibility
This certificate is not valid if it is removed or altered in any way whatsoever*

2022-011769 MISC Page: 1508 of 2782
09/26/2022 03:35:37 PM Receipt #: 22-9981
Rec Fee: \$30.00 Darrell James Hill
Gila County, Az, Sadie Jo Bingham, Recorder



In testimony whereof, I, Michael R. Pompeo, Secretary of State, have hereunto caused the seal of the Department of State to be affixed and my name subscribed by the Assistant Authentication Officer, of the said Department, at the city of Washington, in the District of Columbia, this seventeenth day of July, 2018.

Michael R. Pompeo

Secretary of State

By *[Signature]*

Assistant Authentication Officer,
Department of State

Issued pursuant to CHXIV, State of
Sept. 15, 1789. 1 Stat. 68-69; 22
USC 2657; 22 USC 2651a; 5 USC
301; 28 USC 1733 et seq.; 8 USC
1443(f); RULE 44 Federal Rules of
Civil Procedure.

1505

Copy

**For :Demonstration-Purposes Only;
Original To: Donald-John: Trump, -:Trustee:
USPS RMN RE 322 387 559 US, :May-2020 A.D.
Without Prejudice**

19th May 2020: *Darrell James Hill, A.E.*
:Darrell-James: Hill, -:Beneficiary, -:Executor

Unofficial

1506

2022-011769 MISC Page: 1509 of 2782
09/26/2022 03:35:37 PM Receipt #: 22-9361
Rec Fee: \$30.00 Darrell James Hill
Gila County, Az, Sadie Jo Bingham, Recorder



United States of America
State of Ohio
Office of the Secretary of State

I, **JON HUSTED**, Secretary of State, do hereby certify that I am the duly elected, qualified and acting Secretary of State of the State of Ohio, and I further certify that **JUDITH B. NAGY**

is the duly appointed, State Registrar, Vital Statistics Division, Department of Health, for the State of Ohio. She is the custodian of the records of Vital Statistics, and that she is the proper official to make said attestation, which is in due form; and that her official acts are entitled to full faith and credit.

This certification certifies only the authenticity of the signature of the official who signed the document, the capacity in which that official acted, and where appropriate, the identity of the seal or stamp, which the document bears. This certification does not imply that the contents of the document(s) are correct, nor that they have the approval of this office.

IN TESTIMONY WHEREOF, I have hereunto subscribed my name and affixed the official Seal of the Secretary of State of Ohio, at Columbus, Ohio, this 14th day of June, 2018.

Jon Husted
Secretary of State

SEC4000 (Rev. 1/11)

2022-011769 MISC Page: 1510 of 2782
09/26/2022 03:35:37 PM Receipt #: 22-9381
Rec Fee: \$30.00 Darrell James Hill
Gila County, Az, Sadie Jo Bingham, Recorder



Copy

**For :Demonstration-Purposes Only,
Original To: Donald-John: Trump, -:Trustee:
USPS RMN RE 322 387 559 US, :May-2020 A.D.
Without Prejudice**

19th May 2020: Darrell-James Hill, A.E.
:Darrell-James: Hill, -:Beneficiary, -:Executor

Unofficial
1508

2022-011769 MISC Page: 1511 of 2782
09/26/2022 03:35:37 PM Receipt #: 22-9381
Rec Fee: \$30.00 Darrell James Hill
Gila County, Az, Sadie Jo Bingham, Recorder



OHIO DEPARTMENT OF HEALTH
DIVISION OF VITAL STATISTICS
CERTIFICATE OF LIVE BIRTH

Reg. Dist. No. 7701
Primary Reg. Dist. No. 7701

Registrar's No. 9370
Birth No. 184 - 58 - 208851

1. PLACE OF BIRTH a. COUNTY <u>Summit</u> b. CITY, VILLAGE, OR LOCATION <u>Akron</u>		2. USUAL RESIDENCE OF MOTHER (Where does mother live?) a. STATE <u>Ohio</u> b. COUNTY <u>Summit</u> c. CITY, VILLAGE, OR LOCATION <u>Akron</u> d. STREET ADDRESS <u>219 King Ct.</u>	
3. NAME (TYPE OR PRINT) First Middle Last <u>Darrell James Hill</u>		4. DATE OF BIRTH MONTH DAY YEAR <u>NOV 20 58</u>	
5. NAME OF HOSPITAL OR INSTITUTION <u>Akron City Hospital</u>		6. IS PLACE OF BIRTH INSIDE CITY LIMITS? YES <input checked="" type="checkbox"/> NO <input type="checkbox"/>	
7. NAME First Middle Last <u>Clarence Hill</u>		8. COLOR OR RACE <u>Negro</u>	
9. AGE (at time of this birth) <u>35</u> YEARS		10. BIRTHPLACE (State or foreign country) <u>Ala.</u>	
11. USUAL OCCUPATION <u>Carpenter</u>		12. KIND OF BUSINESS OR INDUSTRY <u>Contractor</u>	
13. MAIDEN NAME First Middle Last <u>Ora Lee Archer</u>		14. COLOR OR RACE <u>Negro</u>	
15. AGE (at time of this birth) <u>30</u> YEARS		16. BIRTHPLACE (State or foreign country) <u>Ark.</u>	
17. INFORMANT'S NAME OR SIGNATURE <u>Ora Hill</u>		18. MOTHER'S MAILING ADDRESS <u>Mar 58</u>	
19. SIGNATURE <i>[Signature]</i>		20. ATTENDANT AT BIRTH M. D. <input checked="" type="checkbox"/> D. O. <input type="checkbox"/> MIDWIFE <input type="checkbox"/> OTHER (Specify)	
21. ADDRESS <u>Akron</u>		22. DATE SIGNED <u>11-28-58</u>	
23. DATE REC'D. BY LOCAL REG. <u>10-28-58</u>		24. REGISTRAR'S SIGNATURE <i>[Signature]</i>	
25. DATE ON WHICH GIVEN NAME ADDED		BY (Registrar)	

MARGIN RESERVED FOR BINDING

FOR MEDICAL AND HEALTH USE ONLY

Judith B. Nagy
State Registrar

MAY - 9 2018

Judith B. Nagy

2022-011769 MISC Page: 1512 of 2782
09/26/2022 03:35:37 PM Receipt #: 22-9381
Rec Fee: \$30.00 Darrell James Hill
Gila County, Az, Sadie Jo Bingham, Recorder



I HEREBY CERTIFY THIS DOCUMENT IS AN EXACT COPY OF THE RECORD ON FILE WITH THE OHIO DEPARTMENT OF HEALTH

VERIFY PRESENCE OF DDH WATERMARK HOLD LIGHT VIEW

1509

Copy

**For :Demonstration-Purposes Only;
Original To: Donald-John: Trump, -:Trustee:
USPS RMN RE 322 387 559 US, :May-2020 A.D.
Without Prejudice**

19th May 2020: *Darrell James Hill, A.E.*
:Darrell-James: Hill, -:Beneficiary, -:Executor

Unofficial

1510

2022-011769 MISC Page: 1513 of 2782
09/26/2022 03:35:37 PM Receipt #: 22-9381
Rec Fee: \$30.00 Darrell James Hill
Gila County, Az, Sadie Jo Bingham, Recorder



APACHE JUNCTION
 151 W SUPERSTITION BLVD
 APACHE JUNCTION, AZ 85120-9998
 030259-0130
 (800)275-8777
 06/09/2020 11:07 AM

Product	Qty	Unit Price	Price
First-Class Mail® Letter (Domestic) (WASHINGTON, DC 20318) (Weight: 0 Lb 2.50 Oz) (Estimated Delivery Date) (Saturday 06/13/2020)	1	\$0.85	\$0.85
Registered (Amount: \$21.00) (USPS Registered Mail #) (RE047610512US)			\$13.20
Return Receipt (USPS Return Receipt #) (9590940258550038324340)			\$2.85
Non Mach. Surch.			\$0.15
Total:			\$17.05
Cash			\$20.00
Change			(\$2.95)

Registered NO. RE047610512US

Reg. Fee	\$0.85	Return Receipt	
Handling Charge	\$13.20	Restricted Delivery	
Postage	\$2.85		
	\$0.00		
Received by	\$0.00		
		\$17.05	

Customer-Must Declare Full Value \$21.00
 Date: 06/09/2020
 Domestic Insurance up to \$25,000 is included in the declared value. International Indemnity is limited. (See Reverse).

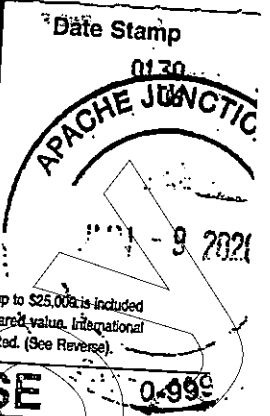

OFFICIAL USE

APACHE JUNCTION, AZ 85120

FROM: Darrell James Hill, beneficiary
 PO Box 3806
 Apache Junction, Arizona 85117

TO: Mark Alexander Wilcox, Trustee
 OFF WASHINGTON DC 20318
 9999 Joint Staff Pentagon
 Washington, Dist. of Columbia 20318-9999

PS Form 3806, Receipt for Registered Mail
 May 2007 (7530-02-000-9051)
 For domestic delivery information, visit our website at www.usps.com®

Copy 1 - Customer
 (See Information on Reverse)

Unofficial

1511

ALERT: DUE TO LIMITED TRANSPORTATION AVAILABILITY AS A RESULT OF NATIONWIDE COVID-19 IMPACTS, PACKAG...

USPS Tracking®

[FAQs >](#)

Track Another Package +

**Track Packages
Anytime, Anywhere**

Get the free Informed Delivery® feature to receive automated notifications on your packages

[Learn More](#)

(<https://rog.usps.com>)

[/xself?app=UspsTools&ref=homepageBanner&appURL=https%3A%2F%2Finformeddelivery.usps.com/box/pages/intro/start.action](#)

Tracking Number: RE047610512US

[Remove X](#)

Your item was picked up at a postal facility at 6:44 am on June 24, 2020 in WASHINGTON, DC 20310.

Delivered

June 24, 2020 at 6:44 am
Delivered, Individual Picked Up at Postal Facility
WASHINGTON, DC 20310

[Get Updates v](#)

Text & Email Updates 

Tracking History 

June 24, 2020, 6:44 am
Delivered, Individual Picked Up at Postal Facility
WASHINGTON, DC 20310
Your item was picked up at a postal facility at 6:44 am on June 24, 2020 in WASHINGTON, DC 20310.

June 20, 2020, 10:21 pm
Arrived at Unit
WASHINGTON, DC 20066

June 17, 2020
In Transit to Next Facility

June 13, 2020, 12:08 pm
Arrived at USPS Regional Destination Facility
WASHINGTON DC DISTRIBUTION CENTER

June 12, 2020, 1:08 am

2022-011769 MISC Page: 1515 of 2782

09/26/2022 03:35:37 PM Receipt #: 22-9381
Rec Fee: \$30.00 Darrell James Hill
Gila County, Az, Sadie Jo Bingham, Recorder



6/26/20, 3:39 PM

:Darrell-James: Hill, -:civilian, -:Executor
c/o PO Box 3806, Apache Junction, Arizona 85117
:i- man¹ -:present,

:The United States of America

Arizona state
Pinal county

To: Mark-Alexander :General United States Army-:Chairman: CJCOS- :Milley,
:John-Earl :General United States Air Force: Vice- CJCOS- :Hyten,
:James-Charles :General United States Army: COS² Army- :McConville,
:David-Hilberry :General United States Marine Corps: CMC³- :Berger,
:Michael-Martin :Admiral United States Navy: CNO⁴- :Gilday,
:David-Lee :General United States air Force: COS AF⁵- :Goldfein,
:John-William :General United States Space Force: CSO⁶- :Raymond,
:Joseph-Lauren :General United States Air Force: CNG⁷- :Lengyel
:Karl-Leo :Admiral United States Coast Guard: CCG⁸- :Schultz
c/o :Mark-Alexander:Milley, -:Trustee : USPS RE 047 610 512 US
Office: CJCOS
9999 Join Staff Pentagon
Washington, District of Columbia 20318-9999

Re: Presentment of the Specialty Negotiable Instrument: 'Priority-Creditor for:
Equity-Claim for :Property- :Presentment to: Donald-John :Trump⁹, -:Trustee,
et seq.,' -
:Steve-Turner: Mnuchin :USPS CMN 7008 1300 0002 2256 4705, and
:William-Pelham: Barr, et al.,:USPS RE 047 610 438 US -

- 1 **:i- man means:** 'i' refers to :Almighty-God as the great 'i- am'. And: 'i- man/' 'i-man' acknowledges that the Almighty-God -created the 'man' is present.
- 2 **:COS means:** Chief of Staff
- 3 **:CMC means:** Commandant of the Marine Corps
- 4 **:CNO means:** Chief of Naval Operations
- 5 **:COS AF means:** Chief of Staff of the Air Force
- 6 **:CSO means:** Chief of Space Operations
- 7 **:CNG means:** Chief of the National Guard Bureau
- 8 **:CCG means:** Commandant of the Coast Guard
- 9 **:Donald-John: Trump means:** the :man under the duty, obligation and moral~Oath of Office: 20th day of January, the year our Lord 2020 A.D.~, acting: 1) as :President of The United States of America ~unincorporated, 1776 A.D.~- - Commander-in-Chief. And, with the :General Order 100 ~Lieber Code~ :24th day, April, the year of our Lord 1863 A.D: by :Constitution for the United States of America Law, as 2) the President of the UNITED STATES incorporated- :government-services-provider- :Trustee: by: U.S. Constitution policy and martial law, the 87th year of the 'United States Inc.'

:Presentment to :Army, :Right for Conveyance of Property-held-without-right in:
Dry-Trust: EBA-1933 A.D - 2003 A.D. USPS RMN RE 047 610 512 US June 09, 2020 1 / 3

2022-011769 MISC Page: 1516 of 2782

09/25/2022 03:35:37 PM Receipt #: 22-9381

James Hill
Darrell J. Bingham, Recorder
Sadie Jo Bingham, Recorder
Gila County, AZ



1513

c/o :Donald-John: Trump:USPS RE 047 610 440 US., See appended: 16 pages.

Greetings Mark-Alexander, :John-Earl, :James-Charles, David-Hilberry, :Michael-Martin, :David-Lee, :John-William, :Joseph-Lauren, :Karl-Leo

:i- man pray for your righteous actions.

The 'Emergency Banking Act of 1933', 'EBA-1933-A.D.', bonded as :surety :all of the people of The United States of America, replaced the strict organic :constitution -obligation with the 'new deal' of the compelled color of law, fiat currency and the :public-education system that effectively assures an ignorant progeny¹⁰.

PRESENTMENT to: Donald-John :POTUS- Trustee, et al.

I) :i- man believe that the copy of the **PRESENTMENT, appended**, is the evidence of the :exercise by the right by :i- man for to -settle and close the EBA-1933-A.D.- dry trust -agreement according to the contract with the Obligor- Trustee, the : 'UNITED-STATES Incorporated'- Trustee, -government- services -provider, 'US-Inc.':

a) The EBA-1933-A.D -emergency is abated;
b) the :period of the bankruptcy is completed; and:
c) :i- man- civilian have required/requested/demanded/ordered the :man under oath-of-offices for to settle-and-close the :accounts for :i- man by :clear-intent and with :all -documentation and truth in :authenticity.

- The :man -:POTUS- Trustee received¹¹ the :authenticated-debenture for :i- man with the required demand/order to settle-and-close.
- The :man -:USAG- Alien property custodian and Common law trustee received¹² the demand to settle-and-close.
- The :man -:Secretary of Treasury- IMF liaison received¹³ the demand to settle-and-close.

II) i- man believe that this :settle and closure -requirement/request/demand/order is a matter not subject to the exigencies nor discretion of the man -:POTUSA -CIC.; rather,

III) i- man believe that this is merely the conclusion to the :EBA-1933-A.D. -dry-trust -:contract between :i- man and the US-Inc.

IV) Whereas the spirit of The Constitution for the United States of America is to protect,

10 :ignorant -progeny means: 1) We do not know who we are; and: 2) we sustain to ourselves the :subverted- patterns of :seventy- year -bankruptcy- cycles. That is: the **Declaration of Independence** pronounced the united states of America that set :all -men free. However, **The Constitution for the United States of America** established the :legalized - murder and slavery of :millions of :Negroes; the :effect was ill-fated. – **The American Civil War** bankrupted the nation, and evolved today under the Lieber code. The Negro was set "free" but unto legalized :socio-institutional -despise, scorn and undermine; again, the :effect was ill-fated.

11 :man -:POTUS- Trustee received means: Donald-John: Trump :USPS RE 047 610 440 US; to wit: USPS RMN RE 322 387 559 US for :USPS RE 047 610 440 US (failed to scan); received: May 29, 2020 at: 4:12 a.m. See: USPS Registered mailing information with presentment: 1 page.

12 :man -:USAG- Alien property custodian and Common law trustee received means: :William-Pelham: Barr, :USPS RE 047 610 438 US; received: May 28, 2020 at 4:05 a.m.

13 :man -:Secretary of Treasury- IMF liaison received means: Steve-Turner: Mnuchin :USPS CMN 7008 1300 0002 2256 4705; received: May 26, 2020 at: 4:03 p.m.

:Presentment to :Army, :Right for Conveyance of Property-held-without-right in:
Dry-Trust: EBA-1933 A.D - 2003 A.D. USPS RMN RE 047 610 512 US June 09, 2020 2 / 3

2022-011769 MISC Page: 1517 of 2782

09/26/2022 03:35:37 PM Receipt #: 22-9381

Rec Fee: \$30.00 Darrell James Hill

Gila County, Az, Sadie Jo Bingham, Recorder



1514

support and defend this demand for the restoration of the private right and property, and, as one ought not to prejudice the right and property of man for the commercial benefit to any man -government-services-provider;
V) man believe this EBA-1933-A.D.- dry trust -matter ought- now to settle and close by the ministerial fiduciary- duty and obligation by the man -government- services- provider, et al.

For the stealing, theft or administration of man's property without right is with the violation of the Lieber Code, et seq. tantamount to the military -confiscation of man - Executor- :civilian's personal property, et seq. for no cause with no compensation and with no receipt for the property -taken.

Enclosure:

'Priority-Creditor for: Equity-Claim for :Property- :Presentment: USPS RE 047 610 440 US ...; 16 pages.

i verify that this is the righteous truth and will testify to same in the open court.

Sincerely,
Without prejudice

Darrell James Hill H. 71, AR.

:Darrell-James: Hill, -civilian, -Executor
:Priority-Creditor, in the remedial :equitable- right
:EBA-1933-A.D.

Jurat

Affirmed and autographed before me this day 9th, June 2020. A.D.

Allan Almanza
Notary Public

SEAL

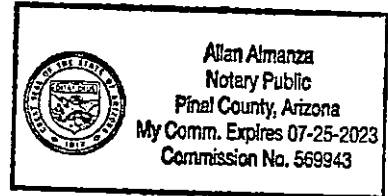

:Presentment to :Army, :Right for Conveyance of Property-held-without-right in:
Dry-Trust: EBA-1933 A.D - 2003 A.D. USPS RMN RE 047 610 512 US June 09, 2020 3 / 3

2022-011769 MISC Page: 1518 of 2782
09/26/2022 03:35:37 PM Receipt #: 22-9381
Rec Fee: \$30.00 Darrell James Hill
Gila County, Az, Sadie Jo Bingham, Recorder

1515

APACHE JUNCTION, AZ 85120-9998
 030259-0130
 (800)275-8777
 05/20/2020 12:44 PM

(Domestic)
 (PRESCOTT, AZ 86301)
 (Weight: 0 Lb 2.30 Oz)
 (Estimated Delivery Date)
 (Saturday 05/23/2020)

Affixed Postage (\$0.55)

(Affixed Amount: \$0.55)
 First-Class Mail® 1 \$0.85 \$0.85

Letter
 (Domestic)
 (PARKER, AZ 85344)
 (Weight: 0 Lb 2.30 Oz)
 (Estimated Delivery Date)
 (Saturday 05/23/2020)

Affixed Postage (\$0.55)

(Affixed Amount: \$0.55)
 First-Class Mail® 1 \$0.85 \$0.85

Letter
 (Domestic)
 (SAFFORD, AZ 85546)
 (Weight: 0 Lb 2.30 Oz)
 (Estimated Delivery Date)
 (Saturday 05/23/2020)

Affixed Postage (\$0.55)

(Affixed Amount: \$0.55)
 First-Class Mail® 1 \$0.85 \$0.85

Letter
 (Domestic)
 (NOGALES, AZ 85621)
 (Weight: 0 Lb 2.30 Oz)
 (Estimated Delivery Date)
 (Saturday 05/23/2020)

Affixed Postage (\$0.55)

(Affixed Amount: \$0.55)
 First-Class Mail® 1 \$0.85 \$0.85

Letter
 (Domestic)
 (ALEXANDRIA, VA 22314)
 (Weight: 0 Lb 2.30 Oz)
 (Estimated Delivery Date)
 (Tuesday 05/26/2020)

Affixed Postage (\$0.55)

(Affixed Amount: \$0.55)
 First-Class Mail® 1 \$0.85 \$0.85

Letter
 (Domestic)
 (SAINT JOHNS, AZ 85936)
 (Weight: 0 Lb 2.30 Oz)
 (Estimated Delivery Date)
 (Saturday 05/23/2020)

Affixed Postage (\$0.55)

(Affixed Amount: \$0.55)
 First-Class Mail® 1 \$0.85 \$0.85

Letter
 (Domestic)
 (BISBEE, AZ 85603)
 (Weight: 0 Lb 2.30 Oz)
 (Estimated Delivery Date)
 (Saturday 05/23/2020)

Affixed Postage (\$0.55)

(Affixed Amount: \$0.55)
 Rate Inquiries 1 \$0.00 \$0.00

First-Class Mail® 1 \$0.85 \$0.85

Letter
 (Domestic)
 (FLORENCE, AZ 85132)
 (Weight: 0 Lb 2.70 Oz)
 (Estimated Delivery Date)
 (Saturday 05/23/2020)

Registered \$13.20

(Amount: \$21.00)
 (USPS Registered Mail #)
 (RE322387545US)

Total: \$18.55

Cash \$20.00

Change (\$1.45)

Product	Qty	Unit Price	Price
First-Class Mail® Letter (Domestic) (PHOENIX, AZ 85003) (Weight: 0 Lb 2.30 Oz) (Estimated Delivery Date) (Saturday 05/23/2020)	1	\$0.85	\$0.85
Affixed Postage (Affixed Amount: \$0.55)			(\$0.55)
First-Class Mail® Letter (Domestic) (FLAGSTAFF, AZ 86001) (Weight: 0 Lb 2.30 Oz) (Estimated Delivery Date) (Saturday 05/23/2020)	1	\$0.85	\$0.85
Affixed Postage (Affixed Amount: \$0.55)			(\$0.55)
First-Class Mail® Letter (Domestic) (GLOBE, AZ 85502) (Weight: 0 Lb 2.30 Oz) (Estimated Delivery Date) (Saturday 05/23/2020)	1	\$0.85	\$0.85
Affixed Postage (Affixed Amount: \$0.55)			(\$0.55)
First-Class Mail® Letter (Domestic) (CLIFTON, AZ 85533) (Weight: 0 Lb 2.30 Oz) (Estimated Delivery Date) (Saturday 05/23/2020)	1	\$0.85	\$0.85
Affixed Postage (Affixed Amount: \$0.55)			(\$0.55)
First-Class Mail® Letter (Domestic) (KINGMAN, AZ 86402) (Weight: 0 Lb 2.30 Oz) (Estimated Delivery Date) (Tuesday 05/26/2020)	1	\$0.85	\$0.85
Affixed Postage (Affixed Amount: \$0.55)			(\$0.55)
First-Class Mail® Letter (Domestic) (YUMA, AZ 85364) (Weight: 0 Lb 2.30 Oz) (Estimated Delivery Date) (Saturday 05/23/2020)	1	\$0.85	\$0.85
Affixed Postage (Affixed Amount: \$0.55)			(\$0.55)
First-Class Mail® Letter (Domestic) (HOLBROOK, AZ 86025) (Weight: 0 Lb 2.30 Oz) (Estimated Delivery Date) (Saturday 05/23/2020)	1	\$0.85	\$0.85
Affixed Postage (Affixed Amount: \$0.55)			(\$0.55)
First-Class Mail® Letter (Domestic) (TUCSON, AZ 85714) (Weight: 0 Lb 2.30 Oz) (Estimated Delivery Date) (Saturday 05/23/2020)	1	\$0.85	\$0.85

1516

2022-011769 MISC Page: 1519 of 2782
 09/26/2022 03:35:37 PM Receipt #: 22-9381
 Rec Fee: \$30.00 Darrell James Hill
 Gila County, Az, Sadie Jo Bingham, Recorder



Registered No: RE322587545US

Date Stamp

To Be Completed By Post Office	Reg. Fee:	\$0.85	
	Handling Charge:	\$13.20	Return Receipt
	Postage:	\$0.00	Restricted Delivery
	Received by:	\$0.00	\$14.05

Customer Must Declare: Full Value: \$1.00
 Domestic insurance up to \$25,000 is included. (See information on Reverse)
 05/20/2008

To Be Completed By Customer (Please Print) All Entries Must Be in Ballpoint or Typed	FROM	Darrell - James Hill, AR PO Box 3806 Apache Junction, Arizona 85117
	TO	Mark Lamb 971 N. Jason Circle Bldg. C, PO Box 867 Florence, Ariz. 85132

PS Form 3806, Receipt for Registered Mail Copy 1 - Customer
 May 2007 (7530-02-000-9051) (See Information on Reverse)
 For domestic delivery information, visit our website at www.usps.com

COPY

SENDER: COMPLETE THIS SECTION	COMPLETE THIS SECTION ON DELIVERY																
<ul style="list-style-type: none"> Complete items 1, 2, and 3. Print your name and address on the reverse so that we can return the card to you. Attach this card to the back of the mailpiece, or on the front if space permits. 	<p>A. Signature: <i>Mark Lamb</i> <input type="checkbox"/> Agent <input checked="" type="checkbox"/> Addressee</p> <p>B. Received by (Printed Name): <i>Mark Lamb</i></p> <p>C. Date of Delivery: <i>05/20/08</i></p> <p>D. Is delivery address different from item 1? <input type="checkbox"/> Yes <input checked="" type="checkbox"/> No If YES, enter delivery address below:</p>																
<p>1. Article Addressed to:</p> <p><i>Mark Lamb - Trustee</i> <i>971 N. Jason Circle</i> <i>Bldg. C - PO Box 867</i> <i>Florence, Ariz 85132</i></p> <p>9590 9402 4563 8278 4310 14</p>	<p>3. Service Type</p> <table border="0"> <tr> <td><input type="checkbox"/> Adult Signature</td> <td><input type="checkbox"/> Priority Mail Express®</td> </tr> <tr> <td><input type="checkbox"/> Adult Signature Restricted Delivery</td> <td><input type="checkbox"/> Registered Mail™</td> </tr> <tr> <td><input type="checkbox"/> Certified Mail®</td> <td><input type="checkbox"/> Registered Mail Restricted Delivery</td> </tr> <tr> <td><input type="checkbox"/> Certified Mail Restricted Delivery</td> <td><input type="checkbox"/> Return Receipt for Merchandise</td> </tr> <tr> <td><input type="checkbox"/> Collect on Delivery</td> <td><input type="checkbox"/> Signature Confirmation™</td> </tr> <tr> <td><input type="checkbox"/> Collect on Delivery Restricted Delivery</td> <td><input type="checkbox"/> Signature Confirmation Restricted Delivery</td> </tr> <tr> <td><input type="checkbox"/> Insured Mail</td> <td></td> </tr> <tr> <td><input type="checkbox"/> Insured Mail Restricted Delivery (over \$500)</td> <td></td> </tr> </table>	<input type="checkbox"/> Adult Signature	<input type="checkbox"/> Priority Mail Express®	<input type="checkbox"/> Adult Signature Restricted Delivery	<input type="checkbox"/> Registered Mail™	<input type="checkbox"/> Certified Mail®	<input type="checkbox"/> Registered Mail Restricted Delivery	<input type="checkbox"/> Certified Mail Restricted Delivery	<input type="checkbox"/> Return Receipt for Merchandise	<input type="checkbox"/> Collect on Delivery	<input type="checkbox"/> Signature Confirmation™	<input type="checkbox"/> Collect on Delivery Restricted Delivery	<input type="checkbox"/> Signature Confirmation Restricted Delivery	<input type="checkbox"/> Insured Mail		<input type="checkbox"/> Insured Mail Restricted Delivery (over \$500)	
<input type="checkbox"/> Adult Signature	<input type="checkbox"/> Priority Mail Express®																
<input type="checkbox"/> Adult Signature Restricted Delivery	<input type="checkbox"/> Registered Mail™																
<input type="checkbox"/> Certified Mail®	<input type="checkbox"/> Registered Mail Restricted Delivery																
<input type="checkbox"/> Certified Mail Restricted Delivery	<input type="checkbox"/> Return Receipt for Merchandise																
<input type="checkbox"/> Collect on Delivery	<input type="checkbox"/> Signature Confirmation™																
<input type="checkbox"/> Collect on Delivery Restricted Delivery	<input type="checkbox"/> Signature Confirmation Restricted Delivery																
<input type="checkbox"/> Insured Mail																	
<input type="checkbox"/> Insured Mail Restricted Delivery (over \$500)																	
<p>2. Article Number (Transfer from service label)</p> <p>RE 322 387 545 US</p>	<p>USPS 85132 MAY 20 2008</p>																
PS Form 3811, July 2015 PSN 7530-02-000-9053	Domestic Return Receipt																

UNRECORDED

2022-011769 MISC Page: 1520 of 2782
 09/26/2022 03:35:37 PM Receipt #: 22-9381
 Rec Fee: \$30.00 Darrell James Hill
 Gila County, Az, Sadie Jo Bingham, Recorder



Office of the La Paz County Attorney
Civil Division
1320 Kofa Avenue
Parker, Arizona 85344
(928)669-6469 / Fax (928)669-6311

Tony Rogers
County Attorney

June 1, 2020

Darrell James Hill
P.O. Box 3806
Apache Junction, AZ 85117

Dear Mr. Hill:

I am returning the fictitious documents that you recently sent the La Paz County Sheriff.

Sincerely,

Ryan N. Dooley
Chief Deputy La Paz County Attorney

Enc. fictitious documents

1518

2022-011769 MISC Page: 1521 of 2782
09/28/2022 03:35:37 PM Receipt #: 22-9381
Rec Fee: \$30.00 Darrell James Hill
Gila County, Az, Sadie Jo Bingham, Recorder



:Darrell-James: Hill, -:civilian, -:Executor
PO Box 3806, Apache Junction, Arizona 85117

To: Arizona- state -Sheriffs

:Mark, :Sheriff- Pinal county, Arizona state- :Lamb,
:Joseph- Jr, :Sheriff Apache county, Arizona state- :Dedman,
:Mark, :Sheriff -Cochise county Arizona state- :Dannels,
:Jim, :Sheriff -Coconino county, Arizona state- :Driscoll,
:Adam, :Sheriff- Gila county, Arizona state - :Shepherd,
:Preston- "PJ", :Sheriff -Graham county, Arizona state- :Allred,
:Tim, :Sheriff- Greenlee county, Arizona state- :Sumner,
:Bill, :Sheriff- La Paz county, Arizona state- :Risen,
:Paul, :Sheriff- Maricopa county, Arizona state- :Penzone,
:Doug, :Sheriff- Mohave county, Arizona state- :Schuster,
:David, :Sheriff- Navajo county, Arizona state- :Clouse,
:Mark, :Sheriff- Pima county, Arizona state- :Napier,
:Tony, :Sheriff- Santa Cruz county, Arizona state- :Estrada,
:Scott, :Sheriff- Yavapai county, Arizona- :Mascher,
:Leon, :Sheriff- Yuma county, Arizona state- :Wilmot,
c/o :Mark :Lamb, -:Trustee
971 N Jason Lopez Circle
Building C
PO Box 867
Florence, Arizona state 85132

2022-011769 MISC Page: 1522 of 2782

09/26/2022 03:35:37 PM Receipt #: 22-9981
Rec Fee: \$30.00 Darrell James Hill
Gila County, Az, Sadie Jo Bingham, Recorder

RE: Declaration by :i- man -beneficiary -primary-creditor to the Trustee of the 'Emergency Banking Act of 1933' -:indenture to :require/request/demand for the Restoration of :all- :property post-haste with the Accounting provided to :i-man; Darrell-James: Hill, et al. (See: Equity-Claim :Presentment: Express Trust: Emergency Banking Act of 1933 A.D. -Trust¹, USPS RE 047 610 440 US -:May 15th, 2020 A.D.; appended: 9 pages).

Greetings :Mark, et al.

In the Law :Sheriffs are the :guardians of the liberty in this republic.

As the appended -document indicates, the 'Emergency Banking Act of 1933' has been completed since 2003 A.D., after 70 years. The :principal-property ought-to-have-been conveyed back at a time no-later-than 2013 A.D.; but, what is a trustee that steals the principal-property? The present :trustee's duty and obligation under his oath-of-office is to the non-competition and absolute protection to the return of :all of the principal-property post-haste. For this reason, :you have been notified.

:i- man request that you assure that this document is noticed by :you, and be placed into the permanent record of the RTCC to aid in the safety of :i- man -civilian in the pursuit to safe-guard against this massive theft of the property from the literally defunct- 'New Deal' -trust of 1933; that the property-held-without-right it will be conveyed- back to The united States of America- :people.

1 :Emergency Banking Act of 1933, et al. means: Public Law 73-1/ Statutes at Large 48 Stat. 1, et al. - Trading With The Enemy Act, amended ~Subdivision (b) of section 5 of the Act of October 6, 1917 ... to read as follows: During time of war or during any other period of national emergency declared by the President... President may require any person within the United States... engaged in any transaction...be fined... imprisoned..., or both.... Cf. Trading with the Enemy Act of 1917, Pub.L. 65-91, 40 Stat. 411.

1519

USPS RE 322 387 545 US, :May 20, 2020 A.D. to: Arizona-state Sheriffs and NSA 1 / 3

:Darrell-James: Hill, -:civilian, -:Executor
PO Box 3806, Apache Junction, Arizona 85117

Thank you.

Enclosure: Equity-Claim :Presentment: Express Trust: Emergency Banking Act of 1933 A.D. -Trust, USPS
RE 047 610 440 US -:May 15th, 2020 A.D.; appended: 9 pages.

cc: by: USPS, First Class Mail

:Joseph- Jr, :Sheriff Apache county, Arizona state- :Dedman
PO Box 518
St. Johns, Arizona 85936

:Mark, :Sheriff -Cochise county Arizona state- :Dannels
205 North Judd Drive
Mile Post 345, Highway 80
Bisbee, Arizona 85603

:Jim, :Sheriff -Coconino county, Arizona state- :Driscoll
219 East Cherry Avenue
Flagstaff, Arizona 86001

:Adam, :Sheriff- Gila county, Arizona state - :Shepherd
1100 South Street
P.O. Box 311
Globe, Arizona 85502

:Preston- "PJ", :Sheriff -Graham county, Arizona state- :Allred
921 W. Thatcher Boulevard
Safford, Arizona 85546

:Tim, :Sheriff- Greenlee county, Arizona state- :Sumner
253 5th St
Clifton, Arizona 85533

:Bill, :Sheriff- La Paz county, Arizona state- :Risen
1109 W Arizona Ave
Parker, Arizona 85344

:Paul, :Sheriff- Maricopa county, Arizona state- :Penzone
550 West Jackson
Phoenix Arizona 85003

Doug, :Sheriff- Mohave county, Arizona state- :Schuster
P.O. Box 1191
600 W. Beale St.
Kingman, Arizona 86402-1191

1520

2022-011769 MISC Page: 1523 of 2782
09/26/2022 03:35:37 PM Receipt #: 22-9381
Rec Fee: \$30.00 Darrell James Hill
Gila County, AZ, Sadie Jo Bingham, Recorder



Darrell-James Hill, -civilian, -Executor
PO Box 3806, Apache Junction, Arizona 85117

David, Sheriff- Navajo county, Arizona state- Clouse
P.O. Box 668
Holbrook, Arizona 86025

Mark, Sheriff- Pima county, Arizona state- Napier
1750 E. Benson Highway
Tucson, Arizona 85714

Tony, Sheriff- Santa Cruz county, Arizona state- Estrada
2170 N. Congress Dr,
Nogales, Arizona 85621

Scott, Sheriff- Yavapai county, Arizona state- Mascher
255 E. Gurley Street
Prescott, Arizona 86301

Leon, Sheriff- Yuma county, Arizona state-,
Board of Directors, National Sheriff's Association- Wilmot
141 S. 3rd Avenue
Yuma, Arizona 85364

Board of Directors, National Sheriff's Association,
President- National Sheriff's Association- Hall
c/o **Daron, Sheriff- Davidson county, Tennessee state-**
President- National Sheriff's Association- Hall
1450 Duke Street
Alexandria, Virginia 22314

Without prejudice

Darrell-James Hill, A.D. A.R.

Darrell-James Hill, -civilian, -Executor,
-Priority- Creditor of the dead-trust:
Emergency Banking Act of 1933

USPS RE 322-387-545 US, May 20, 2020 A.D. to: Arizona-state Sheriffs and NSA 3/3

2022-011769 MISC Page: 1524 of 2782
09/26/2022 03:35:37 PM Receipt #: 22-9381
Rec Fee: \$30.00 Darrell James Hill
Gila County, Az, Sadie Jo Bingham, Recorder



Unofficial Copy

Unofficial Copy

1521

Equity-Claim :Presentment: USPS RE 047 610 440 US :-May 15th, 2020 A.D

:Darrell-James: Hill, -civilian, -Executor¹
c/o PO Box 3806, Apache Junction, Arizona 85117.

:man -present

Darrell James Hill, Executor

:The united States of America,

Arizona state
Pinal county

Equity-Claim :Presentment: Express Trust:
Emergency Banking Act of 1933 A.D. - Trust²,
USPS RE 047 610 440 US :-May 15th, 2020 A.D., to:

Donald-John :Trump, as :Trustee³,
:POTUSA - :Commander-In-Chief- Trustee- :Trump⁴ and
:POTUS - :TRUSTEE - :Trump⁵
:Steve-Turner: Mnuchin :USPS CMN 7008 1300 0002 2256 4705
:US-SOT⁶ :Mnuchin, - :Trustee - Minister⁷,

- 1 **:Darrell-James: Hill means: :Darrell-James: Hill means: Darrell-James: Hill ©1958; Ohioan, © 1958; State of Ohio: beneficiary. See: Gila county,Arizona: Doc. # 2017-002378; pp. 6-24, 89-91,93-95 of 693. Gila county Arizona: Doc. # 2018-005176; pp. 10-21; and, et seq. See: :- man -file of: Specialized Negotiable Instruments to the :man - :Barak-Hussein: Obama, :Donald-John: Trump, et al., et seq.**
- 2 **:Emergency Banking Act of 1933, et al. means: Public Law 73-1/ Statutes at Large 48 Stat. 1, et al. - Trading With The Enemy Act, amended -Subdivision (b) of section 5 of the Act of October 6, 1917 ... to read as follows: During time of war or during any other period of national emergency declared by the President... President may require any person within the United States... engaged in any transaction...be fined... Imprisoned... or both... Cf. Trading with the Enemy Act of 1917, Pub.L. 65-91, 40 Stat. 411.**
- 3 **:Trustee means: 1) one to whom an estate has been conveyed in trust; trust means: TRUST, contracts, devises. An equitable right, title or interest in property, real or personal, distinct from its legal ownership; or it is a personal obligation for paying, delivering or performing anything, where the person trusting has no real right or security, for by that act he confides altogether to the faithfulness of those intrusted. This is its most general meaning, and includes deposits, bailments, and the like. In its more-technical sense, it may be defined to be an obligation upon a person, arising out of a confidence reposed in him, to apply property faithfully, and according to such confidence. Willis on Trustees, 1; 4 Kent, Com. 295; 2 Fonb. Eq. 1; 1 Saund. Uses and Tr, 6; Coop. Eq. Pl. Introd. 27; 3 Bl. Com. 431. 2) for the Emergency Banking Act of 1933, et al., et seq., 'EBA-1933-A.D.'**
- 4 **:POTUSA -Commander-In-Chief Trump means: President of The United States of America -unincorporated-, - Commander-in-Chief, under the :Lieber Code - :24th day, April, the year of our Lord 1863 A.D.**
- 5 **:POTUS Trump means: President of the UNITED STATES incorporated- :government-services-provider - :Trustee.**
- 6 **:US-SOT means: UNITED STATES - Secretary of Treasury; U.S.-IMF liaison.**
- 7 **:minister means: one who acts under -upon the authority of another; e.g., :man- :ambassador of the**

:Claim- :Right for us of :Property-held-without-right in: Dry-Trust: EBA-1933 A.D - 2003 A.D.-
Presentment: USPS RE 047 610 440 US May 18, 2020 1/9.

COPY

1522

2022-011769 MISC Page: 1525 of 2782

09/26/2022 03:35:37 PM Receipt #: 22-9381
Rec Fee: \$30.00 Darrell James Hill
Gila County, Az, Sadie Jo Bingham, Recorder



:William-Pelham: Barr, :USPS RE 047 610 438 US
:US-AG⁸ - :Trustee -:Common-Law-Trustee - Minister- :Barr and
:US-APC⁹, -:Trustee- Minister- :Barr,

:Jefferson-Beauregard: Sessions III, as :Trustee - Minister, :Ex-US-AG- :Sessions,
:Matthew-George: Whitaker, as :Trustee - Minister, :Ex-US-AG: Acting- :Whitaker,
:Dana-James, Boente, as :Trustee - Minister, :Ex-US-AG- Acting- :Boente,
:Sally-Caroline, Yates, as :Trustee - Minister, :Ex-US-AG- Acting- :Yates,
c/o :Donald-John: Trump¹⁰ :USPS RE 047 610 440 US
1600 Pennsylvania Ave NW
Washington, District of Columbia 20500

re: The 'Emergency Banking Act of 1933 A.D.' - 2003 A.D., 'EBA-1933-A.D.' is
:completed-of-purpose and :extinct, then is the 'dry-trust' and ought-to-have-been
dissolved and conveyed to :i-man -:beneficiary and priority-creditor¹¹.

Greetings :Donald-John, :William-Pelham, :Steve-Turner, et al. man:

:i- man¹² hope :you are safe with :righteous- guidance and acts. This :document
is for the settle-and-close¹³ of the :1933 A.D. -trust from the Franklin-Delano, :POTUS-
POTUSA -:Roosevelt's :1933 A.D. -:New-Deal unto The united States of America -
people, et seq. -:i-man -affiant.

A) :Affiant is :man- Darrell-James: Hill, -:civilian, -:Executor¹⁴,

- 8 :Most-High-God: e.g., Enoch, Yushuah (Jesus-the-Christ), Peter, Paul.
- 8 :US-AG means: UNITED STATES Attorney General
- 9 :APC means: Alien-Property-Custodian means: the duty and obligation to take charge of the
property of alien enemies; e.g., the :common law trustee- minister for the EBA-1933-A.D., et al.-
:TWEA of 1917 A.D., as amended, by the authority of the POTUS under Law.
- 10 :Donald-John: Trump means: the :man -:trustee under the duty, obligation and moral-Oath of Office:
20th day of January, the year our Lord 2020 A.D., ministry: 1) as :President of The United States of
America ~unincorporated, 1776 A.D. ~ - Commander-in-Chief. And, with the :General Order 100
~Lieber Code~ :24th day, April, the year of our Lord 1863 A.D. by :Constitution for the United States of
America law, as 2) the President of the UNITED STATES incorporated- :government-services-
provider- :Trustee: by: U.S. Constitution policy and martial law, the 87th year of the United States.
- 11 :Priority-Creditor means: one to whom compensation is made before any other debt is paid
- 12 :i- man means: 'i' refers to :Almighty-God as the great 'i- am'. And: 'i- man'/'i-man' acknowledges
that the Almighty-God -created the 'man' is present.
- 13 :settle and close of all accounts means: TO #1: restore :all :gold, silver, chattel by: (A) from the Total
assets of :all :accounts of :i-man-beneficiary (B) now pay-off the Total :public- debt -account- obligation
for :i- man; now, then (C) merge the two accounts into a (D) new :private-revocable-trust for :i- man;
and (D) continue the status of :investment. Now, (E) Set-up an :L.L.C-type - account for to receive
:payment- proceeds for the non-commercial- :cestui-que-use from (D) the: 'new': :private-revocable-
trust for :i- man' without prejudice; and: #2: restore all lands: to :i- man, et seq. in :allodium.
- 14 :Ibid 1.

:Claim - :Right for us of :Property-held-without-right in: Dry-Trust: EBA-1933 A.D - 2003 A.D.-
Presentment: USPS RE 047 610 440 US May 18, 2020 2 / 9

2022-0111769 MISC Page: 1526 of 2762
09/26/2022 09:35:37 PM Receipt #: 22-9381
Rec Fee: \$30.00 Darrell James Hill
Gila County, Az, Sadie Jo Bingham, Recorder



1523

1. :i- man, :beneficiary¹⁵ -by-:birth¹⁶ of the inherent -trust¹⁷ from :Almighty God¹⁸~ where nothing stands between :Almighty-God and :i- man ~ am: (1) :Executor- Darrell-James: Hill © 1958 A.D., :Ohioan¹⁹, in the fullness of age, and of :sound- mind; (2) by :birth :Negro²⁰ -:beneficiary of the :Emancipation- Proclamation -1863²¹, and forever-guaranteed -:protection by the Army, et al., by the full- force and authority of The Constitution for the United States of America ~ 1789-1791~²²; and: (3) :beneficiary of the ':United-States-of-America,-Incorporated' -:government²³ -services-provider-Trustee's :self-indenture²⁴ to :i-man: with the debenture²⁵ ²⁶ created in the 'idem-sonans²⁷ -:subrogation²⁸ entitled: DARRELL JAMES HILL~ & et al. derivatives~ © 1958

15 :beneficiary means: one onto whom a :trust-benefit is demonstrated by the execution by the :Executor of the beneficiary's use of the trust- property.

16 :birthed :son of :Clarence, :son of :James, :son ':Negroland, :Kingdom-of-Judah, :Africa', ...:son :Ysrael- :Southern-Kingdom ~ of the sons :Judah and Benjamin and Levi, et al., ...:son of :Jacob and :Ysrael, :son of :Isaac, :son of :Abram and :Abraham, ...:son of :Shem, :son of :Noah, ...:son of :Methuselah, :son of :Enoch, ...:son of :Seth, :son of :Adam with :Eve of the garden of :Eden ~ including all :known and unknown :ancestral- lands ~ on the earth placed under the Adamic- lineage and under the :only-begotten -son of the Most-High-God and Father embodied within the rebirth by :i-man of the power of :Yushuah-Messiah, -:God, with the redemption by the Messiah- Yushuah (:Jesus-the-Christ), and encompassing the :receivership, responsibility and administration over :all of the earth-planet as :heir - :remainderman, and :Kinsman- :redeemer of the Earth, both from the Adamic-lineage by the :loss in :spirit in the man upon the Earth, and by the Messiah-Yushuah by the restoration in :spirit in the man upon the Earth: on, in or under-the-surface of the planet; :on, in or under-the-surface of the oceans and waters, and :on, in, under-the-surface of the atmosphere/ above the atmosphere of the Earth to wherever the :Adamic- :man- kind in the quantum and in the spirit is, of :where the :purposes of the Most High God and Father are immeasurable by mere :man.

17 inherent -trust means: that trust is given by the Creator- :Almighty-God -grantor to :i-man- kind -:beneficiary as the steward of the realm; e.g., :gravity, water, air, land, and man- beneficiary.

18 :Almighty God means: a) the :Creator of the worlds: embodied as :Yushuah the Messiah ~a.k.a. Jesus the Christ~ the only begotten son of the Most High God, b) He who for our sake for our redemption did lay down His glory, birthed as man-kind onto our earth-planet, fulfilled all of the word, Law and prophesy, then layed-down his :life, giving his life for to atone for our sins so that :man- kind -whosoever-will may become like Him, in the fullness of that stature, sons of the Most-High-God.

19 See: Record of live Birth means: Authentication ~:Birth No 134 - 58 -208851, Certified Doc.# F4012640,:State Registrar -Judith-B.: Nagy, May -9, 2018.; and: (2) OHIO- SOS -certification: C074912, :Jon: Husted, June 14, 2018; and: (3) The United States of America- SOS- Authentication No. 18047749-2, :Michael -R: Pompeo, July 17, 2018 ~ :Debenture; appended: 3 pages.

20 Ibid 16.

21 Emancipation Proclamation of 1863 means: Proclamation 95 from POTUSA Abraham Lincoln on September 22nd, 1862: effective :January 1st, 1863.

EMANCIPATION. An act by which a person, who was once in the power of another, is rendered free. By the laws of Louisiana, minors may be emancipated. Emancipation is express or implied.

2. Express emancipation. The minor may be emancipated by his father, or, if he has no father, by his mother, under certain restrictions. This emancipation takes place by the declaration, to that effect, of the father or mother, before a notary public, in the presence of two witnesses. The orphan minor may, likewise, be emancipated by the judge, but not before he has arrived at the full age of eighteen years, if the family meeting, called to that effect, be of opinion that he is able to administer his property. The minor may be emancipated against the will of his father and mother, when they ill treat him excessively, refuse him support, or give him corrupt example.

22 The Constitution for the United States of America ~ 1789-1791~ means: The :original - organic -constitution and includes the ':Bill of Rights', et al.

23 ':United-States-corporation' -:government means: 'United-States-of -America- -:corporation'

2022-011769 MISC Page: 1527 of 2782
09/26/2022 03:35:37 PM Receipt #: 22-9981
Rec Fee: \$30.00 Darrell James Hill
Gila County, Az, Sadie Jo Birmingham, Recorder

1524

A.D., :State-of-Ohio²⁹ by the 'Emergency Banking Act of 1933, et al.', 'EBA-1933-A.D.'
-Trust (ended :2003 A.D.);

- 2. :i- man am :member of the non-political -aggregate³⁰;
- 3. :i- man am the literate, legalese-idiot -non-member of the :B.A.R.- legal -society.
:i man am the :Christian -Ambassador³¹ of the Almighty-God

4. :Almighty-God, -Yushuah -the -Messiah (aka: Jesus-the-Christ) who prophetically came to this planet, was birthed -:man, healed :man-kind, died for :man-kind, did resurrect, and now sits at the right-hand of his Father, the :Most-High-God, in Heaven; :i- man am a :disciple of that Messiah Yushuah's teaching and spiritual guidance. :Thereto,

-government -services -provider -Trustee: status post :1862 A.D., e.g., (1) cf :2020: Donald-John: POTUS Trump- Trustee/ EBA-1933-A.D. :CIC acting under U.S. Constitution - incorporated, and (2) cf. :Donald-John: POTUSA Trump, :CIC understanding The Constitution for the United States of America - unincorporated.

- 24 :indenture means: **INDENTURE**, conveyancing. An instrument of writing containing a conveyance or contract between two or more persons, e.g., as between the 'UNITED-STATES-CORPORATION' and 'The United States of America, unincorporated, i.e., the people of the non-political- aggregate.
- 25 :debenture means: **DEBENTURE**. A certificate given, in pursuance of law, by the collector of a port of entry, for a certain sum, due by the United States, payable at a time therein mentioned, to an importer for drawback of duties on merchandise imported and exported by him, provided the duties arising on the importation of the said merchandise shall have been discharged prior to the time aforesaid. Vide Act of Congress of March 2, 1799, s. 80; Encyclopedie, h. t.; Dane's Ab. Index, h. t.
- 26 Ibid 19; '**Birth-day**' means: the 20th day, November, year of our Lord 1958 A.D. at: 11:35 a.m. Birth. The act of being wholly brought into the world: The whole body must be detached from that of the mother, in order to make the birth complete. 5 C. & P. 329; S. C. 24 E. C. L. R. 344 6 C. & P. 349; S. C. 25 E. C. L. R. 433.
day. A division of time. It is natural, and then it consists of twenty-four hours, or the space of time which elapses while the earth makes a complete revolution on its axis; or artificial, which contains the time, from the rising until the setting of the sun, and a short time before rising and after setting. Vide Night; and Co. Lit. 135, a.
2. Days are sometimes calculated exclusively, as when an act required that an appeal should be made within twenty days after a decision. 3 Penna. 200; 3 B. & A. 581; 15 Serg. & Rawle, 43. In general, if a thing is to be done within such a time after such a fact, the day of the fact shall be taken inclusively. Hob. 139; Doug. 463; 3 T. R. 623; Com. Dig. Temps; A; 3 East, 407.
3. The law, generally, rejects fractions of days, but in some cases it takes notice of such parts. 2 B. & A. 586. Vide Date.
- 27 **Idem-sonans** means: **IDEM SONANS**. Sounding the same.
2. In pleadings, when a name which it is material to state, is wrongly spelled, yet if it be idem sonans with that proved, it is sufficient, as Segrave for Segrave, 2 Str. R. 889; Keen for Keene, Thach. Cr. Cas. 67; Deadema for Diadema, 2 Ired. 346; Hutson for Hudson, 7 Miss. R. 142; Coonrad for Conrad, 8 Miss. R. 291. See 5 Pike, 72; 6 Ala. R. 679; vide also Russ. & Ry. 412; 2 Taunt. R. 401. In the following cases the variances there mentioned were declared to be fatal. Russ. & Ry. 351; 10 East, R. 83; 5 Taunt. R. 14; 1 Baldw. R. 83; 2 Crom. & M. 189; 6 Price, R. 2; 1 Chit. R. 659; 13 E. C. L. R. 194. See, generally, 8 Chit. Pr. 231, 2; 4 T. R. 611; 3 B. & P. 559; 1 Stark. R. 47; 2 Stark. R. 29; 3 Camp. R. 29; 6 M. & S. 45; 2 N. H. Rep. 557; 7 S. & R. 479; 3 Caines, 219; 1 Wash. C. C. R. 285; 4 Cowen, 148 and the article Name.
- 28 **Subrogation** means: **SUBROGATION**, civil law, contracts. The act of putting by a transfer, a person in the place of another, or a thing in the place of another thing. It is the substitution (q. v.) of a new for an old creditor, and the succession to his rights, which is called subrogation; transfusio unius creditoris in alium. It is precisely the reverse of delegation. (q. v.)
2. There are three kinds of subrogation: 1. That made by the owner of a thing of his own free will; example, when he voluntarily assigns it. 2. That which arises in consequence of the law, even without

:Claim - :Right for us of :Property-held-without-right in: Dry-Trust: EBA-1933 A.D - 2003 A.D.- Presentment: USPS RE 047 610 440 US May 18, 2020 4 / 9

2022-011769 MISC Page: 1528 of 2782

09/26/2022 03:35:37 PM Receipt #: 22-9381
Reg. Fee: \$30.00 Darrell James Hill
Gila County, AZ, Sadie Jo Birmingham, Recorder



1525

5. :i- man am my brother's keeper as the :ambassador of the :Almighty-God, and openly-accept herenow the duty as the :kinsman- redeemer³² for the unknown -creditors to the :extinct- 'EBA-1933-A.D.' :-completed-trust -contract, aka 'dry-trust'³³, and, as such, for: a) the :tribes of :Ysrael, and: b) for the people understanding the :Almighty-God.

:Declaration of the Beneficiary & :Priority-Creditor of the EBA-1933-A.D. :-dry-trust

6. :i- man -:Darrell-James: Hill, :Executor declare³⁴ that :i- man am: (a) :beneficiary -:remainderman³⁵ and :priority-creditor in the remedial :equitable- right³⁶ and ownership of the principal and proceeds from the extinct 'EBA-1933-A.D.' -contract according to

the consent of the owner; example, when a man pays a debt which could not be properly called his own, but which nevertheless it was his interest to pay, or which he might have been compelled to pay for another, the law subrogates him to all the rights of the creditor. Vide 2 Binn. Rep. 382; White's L. C. in Eq.* 60-72. 3. That which arises by the act of law joined to the act of the debtor; as, when the debtor borrows money expressly to pay off his debt, and with the intention of substituting the lender in the place of the old creditor. 7 Toull. liv. 3, t. 3, c. 5, sect. 1, §2. Vide Civ. Code of Louisiana, art. 2155 to 2158; Merl. Repert. h. t.; Dig. lib. 20; Code, lib. 8, t. 18 et 19 9 Watts. R. 451; 6 Watts & Serg. 190; 2 Bouv. Inst. n. 1413.

29 Ibid 19; ':berth-date' means: the 28th day, November, year of our Lord 1958 A.D., in the 244th year of the United States.

Berth: (v.) 1660s, of ships, from berth (n.). Of persons (intransitive), from 1886. Related: Berthed; berthing.

berth (n.) 1620s, "convenient sea room" (both for ships and sailors), of uncertain origin, probably from bear (v.) + abstract noun suffix -th (2) as in strength, health, etc. Original sense is preserved in phrase to give (something or someone) wide berth. Meaning "place on a ship to stow chests, room for sailors" is from 1706; extended to non-nautical situations by 1778.

Date. The designation or indication in an instrument of writing, of the time, and usually of the time and place, when and where it was made. When the place is mentioned in the date of a deed, the law intends, unless the contrary appears, that it was executed at the place of the date. Plowd. 7 b., 31 H. VI. This word is derived from the Latin datum, because when deeds and agreements were written in that language, immediately before the day, month and year in which they were made, was set down, it was usual to put the word datum, given.

2. All writings ought to bear a date, and in some it is indispensable in order to make them valid, as in policies of insurance; but the date in these instruments is not inserted in the body of the writing because as each subscription makes a separate contract, each underwriter sets down the day, month and year he makes his subscription. Marsh. Ins. 336.

3. Deeds, and other writings, when the date is an impossible one, take effect from the time of deliver; the presumption of law is, that the deed was dated on the day it bears date, unless, as just mentioned, the time is impossible; for example, the 32d day of January.

4. The proper way of dating, is to put the day, month, and year of our Lord; the hour need not be mentioned, unless specially required; an instance of which may be taken from the Pennsylvania Act of the 16th June, 1836, sect. 40, which requires the sheriff, on receiving a writ of fieri facias, or other writ of execution, to endorse thereon the day of the month, the year, and the hour of the day whereon he received the same.

5. In public documents, it is usual to give not only the day, the month, and the year of our Lord, but also the year of the United States, when issued by authority of the general government; or of the commonwealth, when issued under its authority. Vide, generally, Bac. Ab. Obligations, C; Com. Dig. Fait, B 3; Crujse, Dig. tit, 32, c. 20, s. 1-6; 1 Burr. 60; 2 Rol. Ab. 27, 1. 22; 13 Vin. Ab. 34; Dane's Ab. Index, h. t. See Almanac.

30 :non-political -over-standing -aggregate means: the body of people from whom :government is derived; also, :non-actors/citizens in the daily administration of the government service.

31 :Ambassador means: Ibid 7.

:Claim - :Right for us of :Property-held-without-right in: Dry-Trust: EBA-1933 A.D - 2003 A.D.- Presentment: USPS RE 047 610 440 US May 18, 2020 5/9

2022-011769 MISC Page: 1529 of 2782

09/26/2022 03:35:37 PM

Receipt #: 22-9381

Darrell James Hill

Gila County, AZ, Sadie Jo Bingham, Recorder



1526

the Law; and: (b) the :kinsman-redeemer for all :unknown-creditors no-longer-deposed³⁷ as :surety³⁸ for the 'United-States-of-America,-incorporated'³⁹-government-services- :provider's -bankruptcy which was mitigated by the EBA-1933-A.D.-indenture, administered by the person: 'UNITED STATES Incorporated'-government-services- provider -:Trustee for the United-States-of-America,-Incorporated: 1933- A.D., et al., et seq. - :debenture to: The united States of America - people, et seq. - :i- man :Darrell-James ~ 1958 A.D.

B. :Trustee -:Trump is The Trustee To This.:Presentment: USPS :RE 047 610 440 US, May 18th, 2020 A.D., For This Exercise Of The Right By :i- man With The Conveyance Of Assets To :i- man ByThe Emergency Banking Act Of 1933 A.D. under Law

7. :You are the Trustee of the extinct- 'EBA-1933-A.D.' -:completed-trust- principal which should ought-to have-been conveyed to :i-man, et al. in the year of our Lord: 2003 A.D.; and, now ought-be made so: post-haste, agreeably, and with :all -principal-property in :all- accounts, :chattel and land conveyed to a) :i- man- sole, and b) :i-man -kinsman-redeemer.

All Previous Notices To You Are Acquiesced By :you, et al.

8. :This is the second beneficiary request from :i- man to you, et al., for :trust-information for to settle-and-close the :accounts of the extinct- 'EBA-1933-A.D.' -dry-trust. All previous contacts are answered in the response of the :silent- acquiescence.

9. Ignoring :this -Trustee- duty and obligation for to release :all of the property belonging to :i- man is the :same- :wrong-doing as :abandonment of :your fiduciary-duty and oath-of-office to uphold: The Constitution for the United States of America, et al. -Bill-of-Rights.

C. Remedy

10. :Where as the :Emergency Banking Act of 1933' -2003 A.D. is a :dry-trust

- 32 :Kinsman-redeemer means: a relative, male, who delivers a family member from bondage, or sin, or penalties who stands in the gap of the need for the family -unprotected: a relative who delivers a family member from bondage, or sin, or penalties.
- 33 :dry-trust means: the end/ extinction of the trust upon the completion of its duties by the consent and demand of :i- man, et al., beneficiary for the restoration of :all of the trust-property.
- 34 declare means: to make known explicitly and plainly by the full statement as being in one's possession or ownership.
- 35 :Remainderman means: heir, one who inherits; - a person who inherits or is entitled to inherit property upon the termination of the estate
- 36 remedial :equitable- right means: Remedy, exercise in the choice to attain the right of a contract of which one injured is agreed- by :Law, :entitled.
- 37 desposed means: government rule forced -upon :people whether by an overt-wrong or otherwise under the guise of a :remedy; despotism.
- 38 :surety means: contracts. One bound for the payment of a sum of money or for the performance of something else, for another, who is already bound for the same
- 39 'United-States-of-America,-incorporated' means: The government of the united States of America, fashioned under the auspices by the Executive Branch with the Lieber Code upon the American -Civil-War -Crisis: 1861 -A.D.

:Claim -:Right for us of :Property-held-without-right in: Dry-Trust: EBA-1933 A.D - 2003 A.D.- Presentment: USPS RE 047 610 440 US May 18, 2020 6 / 9

2022-011769 MISC Page: 1530 of 2782
09/26/2022 03:35:37 PM Receipt #: 22-9381
Rec Fee: \$30.00 Darrell James Hill
Gila County, Az, Sadie Jo Bingham, Recorder

1527

-:indenture,

- a) administrating the :property without right is now :willful- wrong-doing;
- b) the :Full-Accounting to the penny is required/requested/demanded/ordered- ; and:
- c) :You are required/requested/demanded/ordered to restore :all- property to :i- man- sole upon your receipt of the returned- debenture of the EBA-1933-A.D.- :dry- trust indenture for the settle and close of all accounts.

D. :i- man :Beneficiary And Priority-Creditor Now Herein Expressively Return To The Trustee- :Donald-John: Trump The :EBA-1933-A.D. - :Debenture Expressively Provided For To Settle-And-Close :All-Accounts, And Convey :All - Property To :i- man: Darrell-James Post-Haste.

:Authenticated -:Debenture to :Darrell-James: Hill

11. See the :Authenticated -:certified-debenture ~appended: 3 pages~ returned herein for the settle and close of :all- accounts in the extinct- 'EBA-1933-A.D.' -:dry- trust, for the restoration of :all property to :i- man post-haste.

:Declaration :Beneficiary& :Priority-Creditor: EBA-1933-A.D. -:dry-trust

12. :i- man -:Darrell-James: Hill, :Executor declare⁴⁰ comprehension now that :i- man am a) :beneficiary -:remainderman and :priority-creditor in the remedial :equitable- right⁴¹ and ownership of the principal and proceeds by/according to the Law by the extinction of the 'EBA-1933-A.D.' -:completed-trust, and b) the :kinsman-redeemer for :unknown-creditors no- longer desposed as :surety to the 'United-States-of- America,-incorporated'-government-services- provider's -bankruptcy mitigated by the EBA-1933-A.D.⁴² -contract with the :debenture to :The united States of America - people, -:beneficiary and priority-creditor, et seq. - :Darrell-James.

Require/request/ demand :all property upon return of the debenture

13. :i- man :Darrell-James -:beneficiary and priority-creditor to the extinct- 'EBA- 1933-A.D.' -:completed-trust herein exercise the :right in :Law and equity to require/request/ demand the :trustee, et al. to assent, and to release :all property to :i- man upon the receipt of the debenture to the 'EBA-1933-A.D.' -contract. Notice to the primary Trustee is :notice to every minister, Notice upon the any minister must be expediently noticed to :Trustee, :POTUS-, :POTUSA- :Trump.

Require/Request/Demand/Order The Full-Accounting To :penny Of: Property

14. :i- man Require/ Request/ Demand /Order the :Full-Accounting to the penny for :all accounts for (1) :i- man for: all- property held nowtofore and now-after by the 'Emergency Banking Act of 1933' -:dry- trust.

Return Of All Principal-Property, :Settle And Close -All Accounts -:Property And Chattel

40 declare means: to make known explicitly and plainly by the full statement as being in one's possession or ownership.

41 remedial :equitable- right means: a right of a contractual remedy to which one injured is entitled

42 'United-States-of-America,-Incorporated- :1933' -:bankruptcy means: the : bankruptcy of the corporate-government 'mitigated' by the EBA-1933-A.D., et seq. by the :Primary-:Trust-Management- Organization - :Trustee for the United-States-of-America,-Incorporated: 1933- 2003- A.D. bankruptcy period: seventy years.

:Claim -:Right for us of :Property-held-without-right in: Dry-Trust: EBA-1933 A.D - 2003 A.D.- Presentment: USPS RE 047 610 440 US May 18, 2020 7 / 9

2022-011769 MISC Page: 1531 of 2782

09/26/2022 03:35:37 PM Receipt #: 22-9381
Rec Fee: \$30.00 Darrell J. James Hill
Clita County, Pz, Sadie Jo Bingham, Recorder



1528

Equity-Claim :Presentment: USPS RE 047 610 440 US -May 15th. 2020 A.D

15. :- man :Darrell-James: Hill, :Executor, :priority- creditor and :known -:kinsman-redeemer now require/ request/demand for :you- :Trustee to make :order expressly that :all -principal⁴³ -propertyadministered in to the 'United-States-of-America,- Incorporated: 1933'- A.D. -bankruptcy ought- must- now be :settled and closed with :all -principal -property returned **post-haste** to: (1) :- man :Darrell-James: Hill, -:Executor -:priority-creditor -:sole, and: (2) to :-man :Darrell-James:Hill, -:Executor- :known -:kinsman-redeemer for :all unknown-priority-Creditors due the surety-assets in :total-remainder.

Enclosure: 1/1: Record of live Birth Authentication ~:Birth No 134 - 58 -208851; Certified Doc.# F4012640,:State Registrar - Judith-B.: Nagy, May -9, 2018.; and: (2) OHIO- SOS -certificatiōn: C074912, :Jon: Husted, June 14, 2018; and: (3) United States of America- SOS- Authentication No. 18047749-2, :Michael -R: Pompeo, July 17, 2018 ~ :Debenture: 3 pages.

cc: Army, et al. JCOS :USPS RE 047 610 512 US

:Mark-Alexander :General United States Army⁴⁴:-Chairman: CJCOS⁴⁵- :Milley,
:John-Earl :General United States Air Force: Vice- CJCOS- :Hyten,
:James-Charles :General United States Army: COS⁴⁶ Army- :McConville,
:David-Hilberry :General United States Marine Corps: CMC⁴⁷- :Berger,
:Michael-Martin :Admir.. al United States Navy: CNO⁴⁸- :Gilday.,
:David-Lee :General United States air Force: COS AF⁴⁹- :Goldfein,
:John-William :General United States Space Force: CSO⁵⁰- :Raymond,
:Joseph-Lauren :General United States Air Force: CNG⁵¹- :Lengyel
:Karl-Leo :Admiral United States Coast Guard: CCG⁵²- :Schultz
c/o :Mark-Alexander.Milley, :USPS RE 047 610 512 US
Office: CJCOS
9999 Join Staff Pentagon
Washington, District of Columbia 20318-9999

:William-Pelham: Barr, :USPS RE 047 610 438 US
:US-AG - :Trustee -Common-Law-Trustee - Minister- :Barr and
:US-APC, -:Trustee- Minister- :Barr,
950 Pennsylvania Avenue, N.W.

- 43 :all -principal -property means: Gold, silver, chattel, land, of the original confiscation in the open accounting.
- 44 :General United States means: General: 'The United States of America' Army
- 45 :CJCOS means: Chairman: Joint Chief Of Staff
- 46 :COS means: Chief of Staff
- 47 :CMC means: Commandant of the Marine Corps
- 48 :CNO means: Chief of Naval Operations
- 49 :COS AF means: Chief of Staff of the Air Force
- 50 :CSO means: Chief of Space Operations
- 51 :CNG means: Chief of the National Guard Bureau
- 52 :CCG means: Commandant of the Coast Guard

:Claim - :Right for us of :Property-held-without-right in: Dry-Trust: EBA-1933 A.D - 2003 A.D,- Presentment: USPS RE 047 610 440 US May 18, 2020 8 / 9

2022-011769 MISC Page: 1532 of 2782
09/26/2022 03:35:37 PM Receipt #: 22-9381
Rec Fee: \$30.00 Darrell James Hill
Gila County, AZ, Sadie Jo Bingham, Recorder

1529

Equity-Claim :Presentment: USPS RE 047 610 440 US :May 15th, 2020 A.D

Washington, District of Columbia 20530-0001

:Steve-Turner: Mnuchin, ~:USPS GMN 7008 1300 0002 2256.4705~
:US-SOT :Mnuchin, ~Trustee - Minister,
1500 Pennsylvania Avenue, NW
Washington, District of Columbia 20220

Notice to the primary Trustee is :notice to every minister; Notice upon the any minister
must be expediently noticed to :Trustee - POTUS-, :POTUSA- Trump,

:i- man affirm all said above is true and correct, and will state same in the open court.

Without prejudice

Darrell-James Hill, Executor
:Darrell-James: Hill, :civilian, ~:Executor, ~:Beneficiary and
:Kinsman-redeemer ~:Priority-Creditor in the remedial
:equitable- right by the :Emergency Banking Act of
1933' ~:dry-trust with 'United-States-of-America,-
Incorporated ~:1933- 2003 :bankruptcy.

Jurat

Affirmed and autographed before me this day 18 May, the year of our Lord 2020 A.D.
Type of Identification: Arizona Driver License.

[Signature]
Notary Public

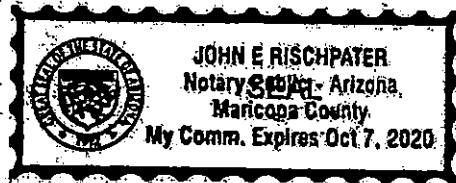

:Claim - :Right for us of :Property-held-without-right In: Dry-Trust: EBA-1933 A.D - 2003 A.D.-
Presentment: USPS RE 047 610 440 US May 18, 2020 9/9

2022-011769 MISC Page: 1533 of 2782
09/26/2022 03:35:37 PM Receipt #: 22-9381
Rec Fee: \$30.00 Darrell James Hill
Gila County, Az, Sadie Jo Bingham, Recorder



Unofficial
1530

1531



Tony Rogers
La Paz County Attorney
1320 KOFA AVENUE
PARKER, AZ 85344

Darrell James Hill
P.O. Box 3806
Apache Junction, AZ 85117

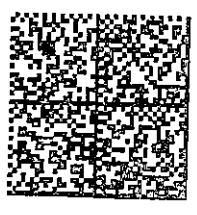

NEOPOST
FIRST-CLASS MAIL
\$000.80
06/01/2020 ZIP 85344
043M30204003

US POSTAGE

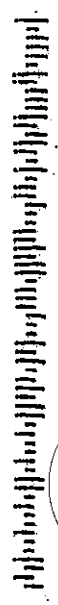

8511784137 8026

2022-011769 MISC Page: 1534 of 2782
09/26/2022 03:35:37 PM Receipt #: 22-9381
Rec Fee: \$30.00 Darrell James Hill
Gila County, Az, Sadie Jo Bingham, Recorder



Official Copy

The UPS Store - #3750
 5301 S. Superstition Mountain Dr
 Ste 104
 Gold Canyon, AZ 85118
 (480) 474-9838

05/18/20 03:36 PM

We are the one stop for all your shipping, postal and business needs.

We offer all the services you need to keep your business going.



001 000003 (011) TO \$ 10.00
 Notary

SubTotal \$ 10.00
 Total \$ 10.00

Cash \$ 100.00
 Change \$ 90.00

Receipt ID 83947883956030888381 001 Items
 CSH: John Tran: 6414 Reg: 001

Thank you for visiting our store.
 Please come back again soon.

Whatever your business and personal needs, we are here to serve you.

We're here to help.
 Join our FREE email program to receive great offers and resources.

www.theupsstore.com/signup

UNITED STATES POSTAL SERVICE
REGISTERED MAIL™

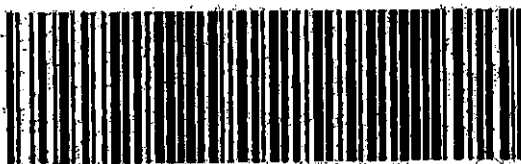

RE 047 610 440 US

Label 200, August 2005

PSN 7890-03-000-9311

Registered No.

RE322387559US

To Be Completed By Post Office	Reg. Fee	\$4.20	Return Receipt
	Handling Charge	\$13.20	Restricted Delivery
	Postage	\$2.00	
	Received by	\$0.00	

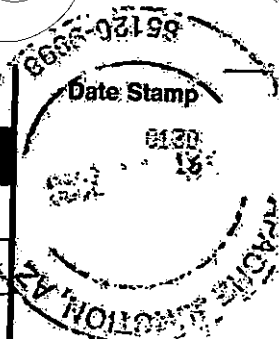

Customer Must Declare Full Value \$21.00

Domestic Insurance up to \$25,000 is included based upon the declared value. International Insurance is limited. (See Reverse).

To Be Completed By Customer (Please Print) All Entries Must Be in Ballpoint or Typewrite

FROM	Darrell James Hill, beneficiary 90 PO Box 3806 Apache Junction, Arizona 85117
TO	Donald John Trump, trustee 1100 Pennsylvania Ave NW Washington, District of Columbia 20500

PS Form 3806, Receipt for Registered Mail Copy 1 - Customer
 May 2007 (7530-02-000-9051) (See Information on Reverse)
 For domestic delivery information, visit our website at www.usps.com

2022-011769 MISC Page: 1535 of 2782
 09/26/2022 03:35:37 PM Receipt #: 22-9381
 Rec Fee: \$30.00 Darrell James Hill
 Gila County, Az, Sadie Jo Bingham, Recorder



Unofficial

1632

APACHE JUNCTION
 151 W SUPERSTITION BLVD
 APACHE JUNCTION, AZ 85120-9998
 030259-0130
 (800)275-8777
 05/18/2020 03:35 PM

UNITED STATES POSTAL SERVICE
REGISTERED MAIL™

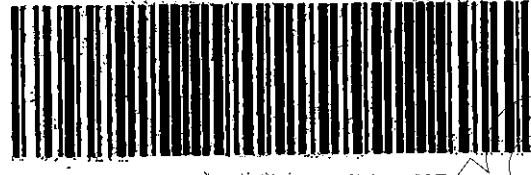

RE 047 610 440 US

Label 200, August 2005 PSN 7690-03-000-9311

Product	Qty	Unit Price	Price
First-Class Package Service 3 Days (Domestic) (WASHINGTON, DC 20500) (Weight: 0 Lb 2.10 Oz) (Estimated Delivery Date) (Friday 05/22/2020)	1	\$4.20	\$4.20
Registered (Amount: \$21.00) (USPS Registered Mail #) (RE322387559US)			\$13.20
Return Receipt (USPS Return Receipt #) (9590940245638278430987)			\$2.85
Total:			\$20.25

Cash Change \$100.00 (\$79.75)

Due to the security of Registered Mail, an additional 3-10 delivery days should be added to the expected delivery date provided.

In a hurry? Self-service kiosks offer quick and easy check-out. Any Retail Associate can show you how.

Text your tracking number to 28777

Registered No. RE322387559US

Reg. Fee	\$4.20	
Handling Charge	\$13.20	Return Receipt
Postage	\$2.85	Restricted Delivery
Received by	\$0.00	
Customer Must Declare Full Value \$21.00		420.25

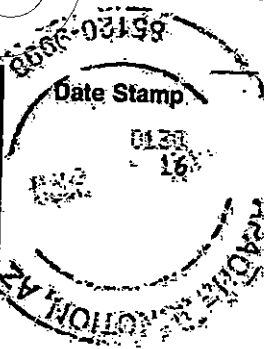

FROM: Darrell James Hill, beneficiary
 90 PO Box 3806
 Apache Junction, Arizona 85117

TO: Donald John Trump, trustee
 1600 Pennsylvania Ave NW
 Washington, District of Columbia 20500

PS Form 3806, Receipt for Registered Mail Copy 1 - Customer
 May 2007 (7530-02-000-9051) (See Information on Reverse)
 For domestic delivery information, visit our website at www.usps.com®

Unofficial

1533

2022-011769 MISC Page: 1536 of 2782
 09/26/2022 03:35:37 PM Receipt #: 22-9381
 Rec Fee: \$30.00 Darrell James Hill
 Gila County, Az, Sadie Jo Bingham, Recorder



:Darrell-James: Hill, -:civilian, -:Executor
PO Box 3806
Apache Junction, Arizona 85117
:man, :present

:The United States of America,

Arizona state
Pinal county

To: Tony: La Paz county Attorney -:Rogers, Trustee
:Ryan-N.: Chief Deputy La paz county Attorney -:Dooley
c/o :Tony: Rogers, Trustee -- USPS CMN 7012 2210 0000 4269 7391
1320 Kofa Avenue
Parker, Arizona 85344

Re: ~Political Election; Request for Protection~ "I am returning the fictitious [FICTITIOUS Pretended; supposed; as, fictitious actions; fictitious payee.] documents that you recently sent the La Paz County Sheriff." - regarding the: 'Declaration of :- man... ' WITHOUT THE DEMOGRAPHY: appended: 13 pages; dated: June 1, 2020 [A.D.], 1 page.

Greetings :Tony, Ryan-N.; Arizona- state -:constitutional -officers

:This -notice to the man- agent(s) must be -made-noticed to the Trustee- principal(s); notice to the Trustee- principal(s) is notice to the agent:

1) Legalese- Idiot: i- man am the :literate :legalese- idiot :non-member of the B.A.R. -legal society; and: 2) Now-to-forward, :all -communication must be with the words in the common-usage in the common -law meanings and methods; and: 3) To infer upon the :righteous-truth of the presentment- :in- material- fact you must present with the :verified- claim of your injury; and:

4) Compensation for: Injury upon :- man: Beyond the :publically -known -:compensation- obligation due for trespass against :- man, :- man do not now wish to contract; and:

5) Protection: i- man do not ask for the man- Bill : sheriff -:Risen's opinion, but for his, et al.'s lawful duty of :protection against the injury from the sundry dishonorable- men acting under the cover of the violent protests fomented in this :nation at this time.

Thank you;

cc: man
:Doug :Arizona state Governor -:Ducey
c/o :Mark :Arizona state AG -:Brnovich – USPS CMN 7009 2820 0003 8851 6032
2005 N Central Ave
Phoenix, Arizona 85004-2926

Political Election; Request for Protection to :Tony: Rogers, Trustee – La Paz county Arizona state:
USPS CMN 7012 2210 0000 4269 7391

2022-011769 MISC Page: 1537 of 2782
09/26/2022 03:35:37 PM Receipt #: 22-9361

Rec Fee: \$30.00 Darrell James Hill
Gila County, Az, Sadie Jo Bingham, Recorder



1534

:Michael :Apache county Attorney -:Whiting
PO Box 637
St. Johns, Arizona 85936

:Bradley- D. :Gila county Attorney -:Beauchamp
1400 E. Ash Street
Globe, Arizona 85501

:William-P. :Coconino county Attorney -:Ring
110 E. Cherry Ave.
Flagstaff, Arizona 86001

:George :Santa Cruz county Attorney -:Silva
2150 N. Congress Drive
Nogales, Arizona 85621

:Sheila :Yavapai county Attorney -:Polk
255 E Gurley Street
Prescott, Arizona 86301

:Brian :Cochise county Attorney -:McIntyre
150 Quality Hill Rd, 2nd Floor
P.O. Drawer CA
Bisbee, Arizona 85603

:Jeremy : Greenlee county Attorney -:Ford
P.O. Box 1717
Clifton , Arizona 85533

:Kent :Pinal county Attorney -:Volkmer
P.O. Box 887
Florence, Arizona 85132

:Allister :Maricopa county Attorney -:Adel
225 West Madison Street
Phoenix, Arizona 85003

Matthew-J. :Mohave county Attorney -:Smith
315 N. 4th Street
Kingman, Arizona 86401

:Barbara :Pima county Attorney -:LaWall
32 N. Stone Avenue
Tucson, Arizona 85701

:Kenny :Graham county Attorney -:Angle
800 Main Street
Safford, Arizona 85546

:Brad :Navajo county Attorney -:Carlyon
100 East Code Talkers Drive
South Highway 77
P.O. Box 668
Holbrook, AZ 86025

:Jon-R. :Yuma county Attorney -:Smith
Yuma county Justice Center
250 W 2nd St.
Suite G
Yuma, Arizona 85364

Appended: 14 pages

i- man affirm this is right-truth and correct, and will testify :same onto the record in the open court.

Without prejudice

Darrell - James Hill, AR
:Darrell-James: Hill, *James Hill, AR* -:Executor

Affirmed and autographed before me this 15 day :June 2020.
Type of Identification: Arizona Driver License

Adam Smith

Notary Public



Political Election; Request for Protection to :Tony: Rogers, Trustee, La Brea, Ariz
USPS CMN 7012 2210 0000 4269 7391

2022-011769 MISC Page: 1538 of 2782
09/26/2022 03:35:37 PM Receipt #: 22-9381
Rec Fee: \$30.00 Darrell James Hill
Gila County, Az, Sadie Jo Bingham, Recorder



1535



Office of the La Paz County Attorney
Civil Division
1320 Kofa Avenue
Parker, Arizona 85344
(928)669-6469 / Fax (928)669-6311

Tony Rogers
County Attorney

June 1, 2020

Darrell James Hill
P.O. Box 3806
Apache Junction, AZ 85117

Dear Mr. Hill:

I am returning the fictitious documents that you recently sent the La Paz County Sheriff.

Sincerely,

Ryan N. Booley
Chief Deputy La Paz County Attorney

Enc. fictitious documents

1936

2022-011769 MISC Page: 1539 of 2782
09/26/2022 03:35:37 PM Receipt #: 22-9381
Rec Fee: \$30.00 Darrell James Hill
Gila County, Az, Sadie Jo Bingham, Recorder



:Darrell-James: Hill, -:civilian, -:Executor
PO Box 3806, Apache Junction, Arizona 85117

To: Arizona- state -Sheriffs

:Mark, :Sheriff- Pinal county, Arizona state- :Lamb,
:Joseph- Jr, :Sheriff Apache county, Arizona state- :Dedman,
:Mark, :Sheriff -Cochise county Arizona state- :Dannels,
:Jim, :Sheriff -Coconino county, Arizona state- :Driscoll,
:Adam, :Sheriff- Gila county, Arizona state - :Shepherd,
:Preston- "PJ", :Sheriff -Graham county, Arizona state- :Allred,
:Tim, :Sheriff- Greenlee county, Arizona state- :Sumner,
:Bill, :Sheriff- La Paz county, Arizona state- :Risen,
:Paul, :Sheriff- Maricopa county, Arizona state- :Penzone,
:Doug, :Sheriff- Mohave county, Arizona state- :Schuster,
:David, :Sheriff- Navajo county, Arizona state- :Clouse,
:Mark, :Sheriff- Pima county, Arizona state- :Napier,
:Tony, :Sheriff- Santa Cruz county, Arizona state- :Estrada,
:Scott, :Sheriff- Yavapai county, Arizona- :Mascher,
:Leon, :Sheriff- Yuma county, Arizona state- :Wilmot,
c/o :Mark :Lamb, -:Trustee
971 N Jason Lopez Circle
Building C
PO Box 867
Florence, Arizona state 85132

2022-011769 MISC Page: 1540 of 2782
09/26/2022 03:35:37 PM Receipt #: 22-9381
Rec Fee: \$30.00 Darrell James Hill
Gila County, Az., Sadie Jo Bingham, Recorder

RE: Declaration by :-i- man -beneficiary -primary-creditor to the Trustee of the 'Emergency Banking Act of 1933' -:Indenture to :require/request/demand for the Restoration of :all- :property post-haste with the Accounting provided to :-i-man: Darrell-James: Hill, et al. (See: Equity-Claim :Presentment: Express Trust: Emergency Banking Act of 1933 A.D. -Trust!, USPS RE 047 610 440 US -:May 15th, 2020 A.D.; appended: 9 pages).

Greetings :Mark, et al.

In the Law :Sheriffs are the :guardians of the liberty in this republic.

As the appended -document indicates, the 'Emergency Banking Act of 1933' has been completed since 2003 A.D., after 70 years. The :principal-property ought-to-have-been conveyed back at a time no-later-than 2013 A.D.; but, what is a trustee that steals the principal-property? The present :trustee's duty and obligation under his oath-of-office is to the non-competition and absolute protection to the return of :all of the principal-property post-haste. For this reason, :you have been notified.

:i- man request that you assure that this document is noticed by :you, and be placed into the permanent record of the RTCC to aid in the safety of :-i- man -civilian in the pursuit to safe-guard against this massive theft of the property from the literally defunct- 'New Deal' -trust of 1933; that the property-held-without-right it will be conveyed- back to The united States of America- ;people.

1 **:Emergency Banking Act of 1933, et al. means: Public Law 73-1/ Statutes at Large 48 Stat. 1, et al. - Trading With The Enemy Act, amended -Subdivision (b) of section 5 of the Act of October 6, 1917 ... to read as follows: During time of war or during any other period of national emergency declared by the President... President may require any person within the United States... engaged in any transaction...be fined... imprisoned...; or both... Cf. Trading with the Enemy Act of 1917, Pub.L. 65-91, 40 Stat. 411.**

1537 USPS RE 322 387 545 US, :May 20, 2020 A.D. to: Arizona-state Sheriffs and NSA 1 / 3

:Darrell-James: Hill, -:civilian, -:Executor
PO Box 3806, Apache Junction, Arizona 85117

Thank you.

Enclosure: Equity-Claim :Presentment: Express Trust: Emergency Banking Act of 1933 A.D. -Trust, USPS
RE 047 610 440 US -:May 15th, 2020 A.D.; appended: 9 pages.

cc: by: USPS, First Class Mail

:Joseph- Jr, :Sheriff Apache county, Arizona state- :Dedman
PO Box 518
St. Johns, Arizona 85936

:Mark, :Sheriff -Cochise county Arizona state- :Dannels
205 North Judd Drive
Mile Post 345, Highway 80
Bisbee, Arizona 85603

:Jim, :Sheriff -Coconino county, Arizona state- :Driscoll
219 East Cherry Avenue
Flagstaff, Arizona 86001

:Adam, :Sheriff- Gila county, Arizona state- :Shepherd
1100 South Street
P.O. Box 311
Globe, Arizona 85502

:Preston- "PJ", :Sheriff -Graham county, Arizona state- :Allred
921 W. Thatcher Boulevard
Safford, Arizona 85546

:Tim, :Sheriff- Greenlee county, Arizona state- :Sumner
253 5th St
Clifton, Arizona 85533

:Bill, :Sheriff- La Paz county, Arizona state- :Risen
1109 W Arizona Ave
Parker, Arizona 85344

:Paul, :Sheriff- Maricopa county, Arizona state- :Penzone
550 West Jackson
Phoenix Arizona 85003

Doug, :Sheriff- Mohave county, Arizona state- :Schuster
P.O. Box 1191
600 W. Beale St.
Kingman, Arizona 86402-1191

1538

USPS RE 322 387 545 US, :May 20, 2020 A.D. to: Arizona-state Sheriffs and NSA

2022-011769 MISC Page: 1541 of 2782
09/25/2022 03:35:37 PM Receipt #: 22-9381
Rec. Fee: \$30.00 Darrell James Hill
Gila County, Az, Sadie Jo Bingham, Recorder



Darrell-James Hill, -civilian, -Executor
PO Box 3866, Apache Junction, Arizona 85117

:David, :Sheriff- Navajo county, Arizona state- :Clouse
P.O. Box 668
Holbrook, Arizona 86025

:Mark, :Sheriff- Pima county, Arizona state- :Napier
1750 E. Benson Highway
Tucson, Arizona 85714

:Tony, :Sheriff- Santa Cruz county, Arizona state- :Estrada
2170 N. Congress Dr
Nogales, Arizona 85621

:Scott, :Sheriff- Yavapai county, Arizona state- :Mascher
255 E. Gurley Street
Prescott, Arizona 86301

:Leon, :Sheriff- Yuma county, Arizona state,
:Board of Directors, :National Sheriff's Association- :Wilmot
141 S. 3rd Avenue
Yuma, Arizona 85364

:Board of Directors, National Sheriff's Association,
:President- National Sheriff's Association- :Hall
c/o :Daron, :Sheriff- Davidson county, Tennessee state-
:President- National Sheriff's Association- :Hall
1450 Duke Street
Alexandria, Virginia 22314

Without prejudice

Darrell James Hill, A.E.
:Darrell-James Hill, -civilian, -Executor,
-Priority- Creditor of the dead-trust
Emergency Banking Act of 1933

USPS RE 322 387 545 US, :May 20, 2020 A.D. to: Arizona-state Sheriffs and NSA 3/3

2022-011769 MISC Page: 1542 of 2782
09/26/2022 03:35:37 PM Receipt #: 22-9381
Rec Fee: \$30.00 Darrell James Hill
Gila County, Az, Sadie Jo Bingham, Recorder



Equity-Claim :Presentment: USPS RE 047 610 440 US -May 15th, 2020 A.D

:Darrell-James: Hill, -civilian, -Executor¹
c/o PO Box 3806, Apache Junction, Arizona 85117.

:man -present

Darrell James Hill, Executor

:The united States of America,

Arizona state
Pinal county

Equity-Claim :Presentment: Express Trust:
Emergency Banking Act of 1933 A.D. - Trust²,
USPS RE 047 610 440 US -May 15th, 2020 A.D., to:

Donald-John :Trump, as :Trustee³,
:POTUSA - :Commander-In-Chief- Trustee- :Trump⁴ and
:POTUS -TRUSTEE -Trump⁵
:Steve-Turner: Mnuchin :USPS CMN 7008 1300 0052 2256 4705
:US-SOT⁶:Mnuchin, -Trustee - Minister⁷,

- 1 **:Darrell-James: Hill means: Darrell-James: Hill means: Darrell-James: Hill ©1958; Ohioan, © 1958; State of Ohio: beneficiary. See: Gila county Arizona: Doc. # 2017-002378; pp. 6-24, 89-91, 93-95 of 693; Gila county Arizona: Doc. # 2018-005176; pp. 10-21; and, et seq. See: -I- man -file of: Specialized Negotiable Instruments to the :man - :Barak-HusseIn: Obama, :Donald-John: Trump, et al., et seq.**
- 2 **:Emergency Banking Act of 1933, et al. means: Public Law 73-1/ Statutes at Large 48 Stat. 1, et al. - Trading With The Enemy Act, amended -Subdivision (b) of section 5 of the Act of October 6, 1917 ... to read as follows: During time of war or during any other period of national emergency declared by the President... President may require any person within the United States... engaged in any transaction... be fined... imprisoned... or both... Cf. Trading with the Enemy Act of 1917, Pub.L. 65-91, 40 Stat. 411.**
- 3 **:Trustee means: 1) one to whom an estate has been conveyed in trust; trust means: TRUST, contracts, devises. An equitable right, title or interest in property, real or personal, distinct from its legal ownership; or it is a personal obligation for paying, delivering or performing anything, where the person trusting has no real right or security, for by that act he confides altogether to the faithfulness of those intrusted. This is its most general meaning, and includes deposits, bailments, and the like. In its more-technical sense, it may be defined to be an obligation upon a person, arising out of a confidence reposed in him, to apply property faithfully, and according to such confidence. Willis on Trustees, 1; 4 Kent, Com. 295; 2 Fanb. Eq. 1; 1 Saund. Uses and Tr. 6; Coop. Eq. Pl. introd. 27; 3 Bl. Com. 431. 2] for the Emergency Banking Act of 1933, et al., et seq. 'EBA-1933-A.D.'**
- 4 **:POTUSA -Commander-In-Chief Trump means: President of The United States of America -unincorporated- - Commander-in-Chief, under the Lieber Code - 24th day, April, the year of our Lord 1863 A.D.**
- 5 **:POTUS Trump means: President of the UNITED STATES incorporated- government-services-provider -Trustee.**
- 6 **:US-SOT means: UNITED STATES - Secretary of Treasury; U.S.-IMF liaison.**
- 7 **:minister means: one who acts under -upon the authority of another; e.g. :man- :ambassador of the**

:Claim - :Right for us of :Property-held-without-right In: Dry-Trust: EBA-1933 A.D - 2003 A.D.-
Presentment: USPS RE 047 610 440 US May 18, 2020 1 / 9

2022-011769 MISC Page: 1543 of 2782
09/26/2022 03:35:37 PM Receipt #: 22-9381
Rec Fee: \$30.00 Darrell James Hill
Gila County, Az, Sadie Jo Bingham, Recorder



:William-Pelham: Barr, :USPS RE 047 610 438 US
:US-AG⁸ - :Trustee - :Common-Law-Trustee - Minister- :Barr and
:US-APC⁹, -:Trustee- Minister- :Barr,
:Jefferson-Beauregard: Sessions III, as :Trustee - Minister, :Ex-US-AG- :Sessions,
:Matthew-George: Whitaker, as :Trustee - Minister, :Ex-US-AG: Acting- :Whitaker,
:Dana-James, Boente, as :Trustee - Minister, :Ex-US-AG- Acting- :Boente,
:Sally-Caroline, Yates, as :Trustee - Minister, :Ex-US-AG- Acting- :Yates,
c/o :Donald-John: Trump¹⁰ :USPS RE 047 610 440 US
1600 Pennsylvania Ave NW
Washington, District of Columbia 20500

re: The 'Emergency Banking Act of 1933 A.D.' - 2003 A.D., 'EBA-1933-A.D.' is
:completed-of-purpose and :extinct, then is the 'dry-trust' and ought-to-have-been
dissolved and conveyed to :i-man -:beneficiary and priority-creditor¹¹.

Greetings :Donald-John, :William-Pelham, :Steve-Turner, et al. man:

:i- man¹² hope :you are safe with :righteous- guidance and acts. This :document
is for the settle-and-close¹³ of the :1933 A.D. -trust from the Franklin-Delano, :POTUS-
POTUSA -:Roosevelt's :1933 A.D. -:New-Deal unto The united States of America -
people, et seq. -:i-man -affiant.

A) :Affiant is :man- Darrell-James: Hill, -:civilian, -:Executor¹⁴,

- Most-High-God: e.g., Enoch, Yushuah (Jesus-the-Christ), Peter, Paul.
- 8 :US-AG means: UNITED STATES Attorney General
- 9 :APC means: Alien-Property-Custodian means: the duty and obligation to take charge of the
property of alien enemies, e.g., the :common law trustee- minister for the EBA-1933-A.D., et al.
:TWEA of 1917 A.D., as amended, by the authority of the POTUS under Law.
- 10 :Donald-John: Trump means: the :man -trustee under the duty, obligation and moral-Oath of Office:
20th day of January, the year our Lord 2020 A.D.~ :ministry: 1) as :President of The United States of
America ~unincorporated,1776 A.D.~ -:Commander-in-Chief. And, with the :General Order 100
~Lieber Code~ :24th day, April, the year of our Lord 1863 A.D: by :Constitution for the United States of
America Law, as 2) the President of the UNITED STATES incorporated- :government-services-
provider- :Trustee: by: U.S. Constitution policy and martial law, the 87th year of the United States.
- 11 :Priority-Creditor means: one to whom compensation is made before any other debt is paid
- 12 :i- man means: 'i' refers to :Almighty-God as the great 'i- am'. And: 'i- man/' :i-man' acknowledges
that the Almighty-God -created the 'man' is present.
- 13 :settle and close of all accounts means: TO #1: restore :all :gold, silver, chattel by: (A) from the Total
assets of :all :accounts of :i-man-beneficiary (B) now pay-off the Total :public- debt -account- obligation
for :i- man; now, then (C) merge the two accounts into a (D) new :private-revocable-trust for :i- man;
and (D) continue the status of :investment. Now, (E) Set-up an :L.L.C-type - account for to receive
:payment- proceeds for the non-commercial- :cestui-que-use from (D) the :new: :private-revocable-
trust for :i- man' without prejudice; and: #2: restore all lands to :i- man, et seq. in :allodium.
- 14 :Ibid f.

:Claim - :Right for us of :Property-held-without-right in: Dry-Trust: EBA-1933 A.D - 2003 A.D.-
Presentment: USPS RE 047 610 440 US May 18, 2020 2 / 9



1. :i- man, :beneficiary¹⁵ -by-:birth¹⁶ of the inherent -trust¹⁷ from :Almighty God¹⁸~ where nothing stands between :Almighty-God and :i- man ~ am: (1) :Executor- Darrell-James: Hill © 1958 A.D., :Ohioan¹⁹, in the fullness of age, and of :sound- mind; (2) by :birth :Negro²⁰ -:beneficiary of the :Emancipation- Proclamation -1863²¹, and forever-guaranteed -:protection by the Army, et al., by the full- force and authority of The Constitution for the United States of America ~ 1789-1791~²²; and: (3) :beneficiary of the ':United-States-of-America,-Incorporated' -:government²³ -services-provider-Trustee's :self-indenture²⁴ to :i-man: with the debenture^{25 26} created in the 'idem-sonans²⁷ -:subrogation²⁸ entitled: DARRELL JAMES HILL~ & et al. derivatives~ @ 1958

15 :beneficiary means: one onto whom a :trust-benefit is demonstrated by the execution by the :Executor of the beneficiary's use of the trust- property.

16 :birthed :son of :Clarence, :son of :James, :son ':Negroland, :Kingdom-of-Judah, :Africa',:son :Ysrael- :Southern-Kingdom ~ of the sons :Judah and Benjamin and Levi, et al.,:son of :Jacob and :Ysrael, :son of :Isaac, :son of :Abram and :Abraham,:son of :Shem, :son of :Noah,:son of :Methuselah, :son of :Enoch,:son of :Seth, :son of :Adam with :Eve of the garden of :Eden ~ including all :known and unknown :ancestral- lands ~ on the earth placed under the Adamic- lineage and under the :only-begotten -son of the Most-High-God and Father embodied within the rebirth by :i-man of the power of :Yushuah-Messiah, -God, with the redemption by the Messiah- Yushuah (:Jesus-the-Christ), and encompassing the :receivership, responsibility and administration over :all of the earth-planet as :heir - :remainderman; and :Kinsman-:redeemer of the Earth, both from the Adamic-lineage by the :loss in :spirit in the man upon the Earth, and by the Messiah-Yushuah by the restoration in :spirit in the man upon the Earth: on, in or under-the-surface of the planet; on, in or under-the-surface of the oceans and waters, and :on, in, under-the-surface of the atmosphere/ above the atmosphere of the Earth to wherever the :Adamic- man -kind in the quantum and in the spirit is, of :where the :purposes of the Most High God and Father are immeasurable by mere :man.

17 inherent -trust means: that trust is given by the Creator- :Almighty-God -grantor to :i-man- kind -:beneficiary as the steward of the realm; e.g., :gravity, water, air, land, and man- beneficiary.

18 :Almighty God means: a) the :Creator of the worlds: embodied as :Yushuah the Messiah ~a.k.a. Jesus the Christ- the only begotten son of the Most High God, b) He who for our sake for our redemption did lay down His glory, birthed as man-kind onto our earth-planet, fulfilled all of the word, Law and prophesy, then layed-down his :life, giving his life for to atone for our sins so that :man- kind -whosoever-will may become like Him, in the fullness of that stature, sons of the Most-High-God.

19 See: Record of live Birth means: Authentication ~:Birth No 134 - 58 -208851, Certified Doc.# F4012640.:State Registrar -Judith-B.: Nagy, May -9, 2018.; and: (2) OHIO- SOS -certification: C074912, :Jon: Husted, June 14, 2018; and: (3) The United States of America- SOS- Authentication No. 18047749-2, :Michael -R: Pompeo, July 17, 2018 ~ :Debenture; appended: 3 pages.

20 Ibid 16.

21 Emancipation Proclamation of 1863 means: Proclamation 95 from POTUSA Abraham Lincoln on September 22nd, 1862: effective :January 1st, 1863.

EMANCIPATION. An act by which a person, who was once in the power of another, is rendered free. By the laws of Louisiana, minors may be emancipated. Emancipation is express or implied.

2. Express emancipation. The minor may be emancipated by his father, or, if he has no father, by his mother, under certain restrictions. This emancipation takes place by the declaration, to that effect, of the father or mother, before a notary public, in the presence of two witnesses. The orphan minor may, likewise, be emancipated by the judge, but not before he has arrived at the full age of eighteen years, if the family meeting, called to that effect, be of opinion that he is able to administer his property. The minor may be emancipated against the will of his father and mother, when they ill treat him excessively, refuse him support, or give him corrupt example.

22 The Constitution for the United States of America ~ 1789-1791~ means: The :original - organic -constitution and includes the ':Bill of Rights', et al.

23 ':United-States-corporation' -:government means: 'United-States-of -America- -:corporation'

:Claim - :Right for us of :Property-held-without-right in: Dry-Trust:EBA-1933 A.D - 2003 A.D.- Presentment: USPS RE 047 610 440 US May 18, 2020 3 / 9

1542

2022-011769 MISC Page: 1545 of 2782
09/26/2022 09:35:37 PM Receipt #: 22-9381
Rec Fee: \$30.00 Darrell James Hill
Gila County, Az, Sadle Jo Blingham, Recorder



A.D., :State-of-Ohio²⁹ by the 'Emergency Banking Act of 1933, et al.', 'EBA-1933-A.D.'
-Trust (ended :2003 A.D.);

- 2. :i- man am :member of the non-political -aggregate³⁰;
- 3. :i- man am the literate, legalese-idiot -non-member of the :B.A.R.- legal -society.

:i man am the :Christian -Ambassador³¹ of the Almighty-God

- 4. :Almighty-God, -Yushuah -the -Messiah (aka: Jesus-the-Christ) who prophetically came to this planet, was birthed :man, healed :man-kind, died for :man-kind, did resurrect, and now sits at the right-hand of his Father, the :Most-High-God, in Heaven; :i- man am a :disciple of that Messiah Yushuah's teaching and spiritual guidance. :There to,

-:government -services -provider -Trustee: status post :1862 A.D., e.g., (1) cf :2020: Donald-John: POTUS Trump- Trustee/ EBA-1933-A.D, :CIC acting under U.S. Constitution - incorporated, and (2) cf. :Donald-John: POTUSA Trump, :CIC understanding The Constitution for the United States of America - unincorporated.

- 24 :indenture means: INDENTURE, conveyancing. An instrument of writing containing a conveyance or contract between two or more persons, e.g., as between the 'UNITED STATES-CORPORATION' and 'The United States of America, unincorporated, i.e., the people of the non-political- aggregate.

- 25 :debenture means: DEBENTURE. A certificate given, in pursuance of law, by the collector of a port of entry, for a certain sum, due by the United States, payable at a time therein mentioned, to an importer for drawback of duties on merchandise imported and exported by him, provided the duties arising on the importation of the said merchandise shall have been discharged prior to the time aforesaid. Vide Act of Congress of March 2, 1799, s. 80; Encyclopedie, h. t.; Dane's Ab. Index, h. t.

- 26 Ibid 19; :Birth-day' means: the 20th day, November, year of our Lord 1958 A.D. at 11:35 a.m. Birth. The act of being wholly brought into the world. The whole body must be detached from that of the mother, in order to make the birth complete. 5 C. & P. 329; S. C. 24 E. C. L. R. 344 6 C. & P. 349; S. C. 25 E. C. L. R. 433.

day. A division of time. It is natural, and then it consists of twenty-four hours, or the space of time which elapses while the earth makes a complete revolution on its axis; or artificial, which contains the time, from the rising until the setting of the sun, and a short time before rising and after setting. Vide Night; and Co. Lit. 135, a.

2. Days are sometimes calculated exclusively, as when an act required that an appeal should be made within twenty days after a decision. 3 Penna. 200; 3 B. & A. 581; 15 Serg. & Rawle, 43. In general, if a thing is to be done within such a time after such a fact, the day of the fact shall be taken inclusively. Hob. 139; Doug. 463; 3 T. R. 623; Com. Dig. Temps; A; 3 East, 407.

3. The law, generally, rejects fractions of days, but in some cases it takes notice of such parts. 2 B. & A. 586. Vide Date.

- 27 Idem-sonans means: IDEM SONANS: Sounding the same.

2. In pleadings, when a name which it is material to state, is wrongly spelled, yet if it be idem sonans with that proved, it is sufficient, as Segrave for Seagrave, 2 Str. R. 889; Keen for Keene, Thach. Cr. Cas. 67; Deadema for Diadema, 2 Ired. 346; Hutson for Hudson, 7 Miss. R. 142; Coonrad for Conrad, 8 Miss. R. 291. See 5 Pike, 72; 6 Ala. R. 679; vide also Russ. & Ry. 412; 2 Taunt. R. 401, In the following cases the variances there mentioned were declared to be fatal. Russ. & Ry. 351; 10 East, R. 83; 5 Taunt. R. 14; 1 Baldw. R. 83; 2 Crom. & M. 189; 6 Price, R. 2; 1 Chit. R. 659; 13 E. C. L. R. 194. See, generally, 8 Chit. Pr. 231, 2; 4 T. R. 611; 3 B. & P. 559; 1 Stark. R. 47; 2 Stark. R. 29; 3 Camp. R. 29; 6 M. & S. 45; 2 N. H. Rep. 557; 7 S. & R. 479; 3 Caines, 219; 1 Wash. C. C. R. 285; 4 Cowen, 148 and the article Name.

- 28 Subrogation means: SUBROGATION, civil law, contracts. The act of putting by a transfer, a person in the place of another, or a thing in the place of another thing. It is the substitution (q. v.) of a new for an old creditor, and the succession to his rights, which is called subrogation; transfusio unius creditoris in alium. It is precisely the reverse of delegation. (q. v.)

2. There are three kinds of subrogation: 1. That made by the owner of a thing of his own free will; example, when he voluntarily assigns it. 2. That which arises in consequence of the law, even without

:Claim - :Right for us of :Property-held-without-right in: Dry-Trust: EBA-1933 A.D - 2003 A.D.- Presentment: USPS RE 047 610 440 US May 18, 2020 4 / 9

Page: 1546 of 2782

MISC 2022-011769

09/26/2022 03:35:37 PM Receipt #: 22-9381
Rec Fee: \$30.00 Darrell James Hill
Gila County, Az, Sadie Jo Bingham, Recorder



1543

5. I- man am my brother's keeper as the ambassador of the Almighty-God, and openly-accept herenow the duty as the kinsman- redeemer³² for the unknown -creditors to the extinct-'EBA-1933-A.D.' -completed-trust -contract, aka 'dry-trust'³³, and, as such, for: a) the tribes of Ysrael, and: b) for the people understanding the Almighty-God.

:Declaration of the Beneficiary & :Priority-Creditor of the EBA-1933-A.D. -:dry-trust

6. I- man -Darrell-James: Hill, :Executor declare³⁴ that I- man am: (a) :beneficiary -:remainderman³⁵ and :priority-creditor in the remedial :equitable- right³⁶ and ownership of the principal and proceeds from the extinct 'EBA-1933-A.D.' -contract according to

the consent of the owner; example, when a man pays a debt which could not be properly called his own, but which nevertheless it was his interest to pay, or which he might have been compelled to pay for another, the law subrogates him to all the rights of the creditor. Vide 2 Binn. Rep. 382; White's L. C. in Eq.* 60-72. 3. That which arises by the act of law joined to the act of the debtor; as, when the debtor borrows money expressly to pay off his debt, and with the intention of substituting the lender in the place of the old creditor. 7 Toull. liv. 3, t. 3, c. 5, sect. 1, §2. Vide Civ. Code of Louisiana, art. 2155 to 2158; Merl. Repert. h. t.; Dig. lib. 20; Code, lib. 8, t. 18 et 19 9 Watts. R. 451; 6 Watts & Serg. 190; 2 Bouv. Inst. n. 1413.

29 Ibid 19; 'berth-date' means: the 28th day, November, year of our Lord 1958 A.D., in the 244th year of the United States.

Berth: (v.) 1660s, of ships, from berth (n.). Of persons (intransitive), from 1886. Related: Berthed; berthing.

berth (n.) 1620s, "convenient sea room" (both for ships and sailors), of uncertain origin, probably from bear (v.) + abstract noun suffix -th (2) as in strength, health, etc. Original sense is preserved in phrase to give (something or someone) wide berth. Meaning "place on a ship to stow chests, room for sailors" is from 1706; extended to non-nautical situations by 1778.

Date. The designation or indication in an instrument of writing, of the time, and usually of the time and place, when and where it was made. When the place is mentioned in the date of a deed, the law intends, unless the contrary appears, that it was executed at the place of the date. Plowd. 7 b., 31 H. VI. This word is derived from the Latin datum, because when deeds and agreements were written in that language, immediately before the day, month and year in which they were made, was set down, it was usual to put the word datum, given.

2. All writings ought to bear a date, and in some it is indispensable in order to make them valid, as in policies of insurance; but the date in these instruments is not inserted in the body of the writing because as each subscription makes a separate contract, each underwriter sets down the day, month and year he makes his subscription. Marsh. Ins. 336.

3. Deeds, and other writings, when the date is an impossible one, take effect from the time of deliver; the presumption of law is, that the deed was dated on the day it bears date, unless, as just mentioned, the time is impossible; for example, the 32d day of January.

4. The proper way of dating, is to put the day, month, and year of our Lord; the hour need not be mentioned, unless specially required; an instance of which may be taken from the Pennsylvania Act of the 16th June, 1836, sect. 40, which requires the sheriff, on receiving a writ of fieri facias, or other writ of execution, to endorse thereon the day of the month, the year, and the hour of the day whereon he received the same.

5. In public documents, it is usual to give not only the day, the month, and the year of our Lord, but also the year of the United States, when issued by authority of the general government; or of the commonwealth, when issued under its authority. Vide, generally, Bac. Ab. Obligations, C; Com. Dig. Fait, B 3; Cruise, Dig. tit. 32, c. 20, s. 1-6; 1 Burr. 60; 2 Rol. Ab. 27, 1. 22; 13 Vin. Ab. 34; Dane's Ab. Index, h. t. See Almanac.

30. :non-political -:over-standing -aggregate means: the body of people from whom :government is derived; also; :non-actors/citizens in the daily administration of the government service.

31. :Ambassador means: Ibid 7.

:Claim -:Right for us of :Property-held-without-right in: Dry-Trust: EBA-1933 A.D - 2003 A.D.- Presentment: USPS RE 047 610 440 US May 18, 2020 5/9

2022-011769 MISC Page: 1547 of 2782
09/25/2022 03:35:37 PM Receipt #: 22-9381
Rec Fee: \$30.00 Darrell James Hill
Gila County, Az, Saddle Jo Bingham, Recorder



1544

the Law; and: (b) the kinsman-redeemer for all unknown-creditors no-longer-desposed³⁷ as surety³⁸ for the 'United-States-of-America,-incorporated'³⁹-government-services- provider's -bankruptcy which was mitigated by the EBA-1933-A.D.-indenture, administered by the person: 'UNITED STATES Incorporated'-government-services- provider -Trustee for the United-States-of-America,- Incorporated: 1933- A.D.; et al., et seq. - debenture to: The united States of America - people, et seq. - i- man Darrell-James ~ 1958 A.D.

B. Trustee - Trump is The Trustee To This Presentment: USPS RE 047 610 440 US, May 18th, 2020 A.D., For This Exercise Of The Right By i- man With The Conveyance Of Assets To i- man By The Emergency Banking Act Of 1933 A.D. under Law

7. You are the Trustee of the extinct 'EBA-1933-A.D.' -completed-trust- principal which should ought-to have-been conveyed to i-man, et al. in the year of our Lord: 2003 A.D.; and, now ought-be made so: post-haste, agreeably, and with all -principal- property in all- accounts, -chattel and land conveyed to a) i- man- sole, and b) i-man- kinsman-redeemer.

All Previous Notices To You Are Acquiesced By you, et al.

8. This is the second beneficiary request from i- man to you, et al., for trust- information for to settle-and-close the accounts of the extinct 'EBA-1933-A.D.' -dry- trust. All previous contacts are answered in the response of the silent- acquiescence.

9. Ignoring this Trustee- duty and obligation for to release all of the property belonging to i- man is the same- wrong-doing as abandonment of your fiduciary- duty and oath-of-office to uphold: The Constitution for the United States of America, et al. -Bill-of-Rights.

C. Remedy

10. Where as the 'Emergency Banking Act of 1933' -2003 A.D. is a dry-trust

- 32 Kinsman-redeemer means: a relative, male, who delivers a family member from bondage, or sin, or penalties who stands in the gap of the need for the family -unprotected: a relative who delivers a family member from bondage, or sin, or penalties.
- 33 dry-trust means: the end/ extinction of the trust upon the completion of its duties by the consent and demand of i- man, et al., beneficiary for the restoration of all of the trust- property.
- 34 declare means: to make known explicitly and plainly by the full statement as being in one's possession or ownership.
- 35 Remainderman means: heir, one who inherits; - a person who inherits or is entitled to inherit property upon the termination of the estate
- 36 remedial equitable- right means: Remedy, exercise in the choice to attain the right of a contract of which one injured is agreed- by Law, entitled.
- 37 desposed means: government rule forced -upon people whether by an overt-wrong or otherwise under the guise of a remedy, despotism.
- 38 surety means: contracts. One bound for the payment of a sum of money or for the performance of something else, for another, who is already bound for the same
- 39 'United-States-of-America,-incorporated' means: The government of the united States of America, fashioned under the auspices by the Executive Branch with the Lieber Code upon the American -Civil- War -Crisis: 1861 -A.D.

Claim - Right for us of Property-held-without-right in Dry-Trust EBA-1933 A.D - 2003 A.D. Presentment: USPS RE 047 610 440 US May 18, 2020 6 / 9

2022-011769 MISC Page: 1548 of 2782
09/26/2022 03:35:37 PM Receipt #: 22-9381
Rec Fee: \$30.00 Darrell James Hill
Gila County, Az, Sadie Jo Bingham, Recorder

1545

-indenture,

- a) administrating the property without right is now willful-wrong-doing;
- b) the Full-Accounting to the penny is required/requested/demanded/ordered; and;
- c) You are required/requested/demanded/ordered to restore all property to i-man-sole upon your receipt of the returned-debenture of the EBA-1933-A.D.-dry-trust indenture for the settle and close of all accounts.

D. i-man Beneficiary And Priority-Creditor Now Herein Expressively Return To The Trustee Donald-John: Trump The EBA-1933-A.D. Debenture Expressively Provided For To Settle-And-Close All-Accounts, And Convey All Property To i-man: Darrell-James Post-Haste.

Authenticated Debenture to Darrell-James: Hill

11. See the Authenticated-certified-debenture appended: 3 pages~ returned herein for the settle and close of all accounts in the extinct 'EBA-1933-A.D.'-dry-trust, for the restoration of all property to i-man post-haste.

Declaration Beneficiary & Priority-Creditor: EBA-1933-A.D. -dry-trust

12. i-man Darrell-James: Hill, Executor declare⁴⁰ comprehension now that i-man am a) beneficiary-remainderman and priority-creditor in the remedial equitable⁴¹ and ownership of the principal and proceeds by/according to the Law by the extinction of the 'EBA-1933-A.D.'-completed-trust, and b) the kinsman-redeemer for unknown-creditors no longer desposed as surety to the 'United-States-of-America,-incorporated'-government-services-provider's-bankruptcy mitigated by the EBA-1933-A.D.⁴²-contract with the debenture to The united States of America - people, -beneficiary and priority-creditor, et seq. - Darrell-James.

Require/request/ demand all property upon return of the debenture

13. i-man Darrell-James-beneficiary and priority-creditor to the extinct 'EBA-1933-A.D.'-completed-trust herein exercise the right in Law and equity to require/request/ demand the trustee, et al. to assent, and to release all property to i-man upon the receipt of the debenture to the 'EBA-1933-A.D.'-contract. Notice to the primary Trustee is notice to every minister; Notice upon the any minister must be expediently noticed to Trustee, POTUS, POTUSA-Trump.

Require/Request/Demand/Order The Full-Accounting To penny Of: Property

14. i-man Require/ Request/ Demand /Order the Full-Accounting to the penny for all accounts for (1) i-man for all property held nowtfore and now-after by the 'Emergency Banking Act of 1933' -dry-trust.

Return Of All Principal-Property, Settle And Close -All Accounts -Property And Chattel

40 declare means: to make known explicitly and plainly by the full statement as being in one's possession or ownership.

41 remedial equitable- right means: a right of a contractual remedy to which one injured is entitled

42 'United-States-of-America,-incorporated- 1933' -bankruptcy means: the bankruptcy of the corporate-government 'mitigated' by the EBA-1933-A.D., et seq. by the Primary-Trust-Management-Organization - Trustee for the United-States-of-America,-Incorporated: 1933- 2003- A.D. bankruptcy period: seventy years.

2022-011769 MISC Page: 1549 of 2782
 09/26/2022 03:35:37 PM Receipt #: 22-9361
 Rec Fee: \$30.00 Darrell James Hill
 21 La County, Az, Sadie Jo Bingham, Recorder



1546

15. i-man Darrell-James Hill, Executor, priority- creditor and known -kinsman-redeemer now require/ request/demand for you- Trustee to make order expressly that all -principal⁴³ -property administered in to the 'United States of America, - Incorporated: 1933'- A.D. -bankruptcy ought- must- now be settled and closed with all -principal -property returned post-haste to: (1) i-man Darrell-James Hill, -Executor -priority-creditor -sole, and: (2) to i-man Darrell-James Hill, -Executor- known -kinsman-redeemer for all unknown-priority-Creditors due the surety-assets in total-remainder.

Enclosure: 1/1: Record of live Birth Authentication ~:Birth No 134 - 58 -208851, Certified Doc.# F4012640, State Registrar - Judith-B. Nagy, May -9, 2018.; and: (2) OHIO- SOS -certification: C074912, Jon: Husted, June 14, 2018; and: (3) United States of America- SOS- Authentication No. 18047749-2, Michael -R: Pompeo, July 17, 2018 ~ :Debenture: 3 pages.

cc: Army, et al. JCOS :USPS RE 047 610 512 US

:Mark-Alexander :General United States Army⁴⁴-Chairman: CJCOS⁴⁵- :Milley,
:John-Earl :General United States Air Force: Vice- CJCOS- :Hyten,
:James-Charles :General United States Army: COS⁴⁶ Army- :McConville,
:David-Hilberry :General United States Marine Corps: CMC⁴⁷- :Berger,
:Michael-Martin :Admir.. al United States Navy: CNO⁴⁸- :Gilday,
:David-Lee :General United States air Force: COS AF⁴⁹- :Goldfein,
:John-William :General United States Space Force: CSO⁵⁰- :Raymond,
:Joseph-Lauren :General United States Air Force: CNG⁵¹- :Lengyel
:Karl-Leo :Admiral United States Coast Guard: CCG⁵²- :Schultz
c/o :Mark-Alexander:Milley; :USPS RE 047 610 512 US

Office: CJCOS
9999 Join Staff Pentagon
Washington, District of Columbia 20318-9999

:William-Pelham Barr, :USPS RE 047 610 438 US
:US-AG - Trustee -Common-Law-Trustee - Minister- :Barr, and
:US-APC, -Trustee- Minister- :Barr,
950 Pennsylvania Avenue, N.W.

- 43 :all -principal -property means: Gold, silver, chattel, land, of the original confiscation in the open accounting.
- 44 :General United States means: General: 'The United States of America' Army
- 45 :CJCOS means: Chairman: Joint Chief Of Staff
- 46 :COS means: Chief of Staff
- 47 :CMC means: Commandant of the Marine Corps
- 48 :CNO means: Chief of Naval Operations
- 49 :COS AF means: Chief of Staff of the Air Force
- 50 :CSO means: Chief of Space Operations
- 51 :CNG means: Chief of the National Guard Bureau
- 52 :CCG means: Commandant of the Coast Guard

:Claim - :Right for us of :Property-held-without-right in: Dry-Trust: EBA-1933 A.D - 2003 A.D.- Presentment: USPS RE 047 610 440 US - May 18, 2020 8 / 9

2022-011769 MISC Page: 1550 of 2782
09/26/2022 09:35:37 PM Receipt #: 22-9381
James Hill, Recorder
Darrell Jo Bingham, Recorder
Gila County, Az, Sadie Jo Bingham, Recorder

1547

Equity Claim Presentment: USPS RE 047 610 440 US - May 15, 2020 A.D

Washington, District of Columbia 20530-0001

Steve Turner Mnuchin, - USPS GMN 7008 1300 0002 2256.4705 -

US-SOT Mnuchin, - Trustee - Minister,

1500 Pennsylvania Avenue, NW

Washington, District of Columbia 20220

Notice to the primary Trustee is notice to every minister, Notice upon the any minister must be expediently noticed to Trustee - POTUS, POTUSA, Trump.

I, man affirm all said above is true and correct, and will state same in the open court.

Without prejudice

Darrell James Hill, Executive

Darrell James Hill, civil, Executor, Beneficiary and
Kinsman-redeemer, Priority Creditor in the remedial
equitable right by the Emergency Banking Act of
1933 - dry-trust with United States of America,
Incorporated - 1933 - 2003 bankruptcy.

Jurat

Affirmed and autographed before me this day 18 May, the year of our Lord 2020 A.D.
Type of Identification: Arizona Driver License.

[Signature]
Notary Public



Claim - Right for us of Property held without right in Dry-Trust EBA-1933 A.D - 2003 A.D.
Presentment: USPS RE 047 610 440 US May 18, 2020 9/9

2022-011769 MISC Page: 1551 of 2782
09/26/2022 03:35:37 PM Receipt #: 22-9981
Rec Fee: \$30.00 Darrell James Hill
Gila County, Az, Sadie Jo Bingham, Recorder

1548

THE UPS STORE - #3150
 5301 S. Superstition Mountain Dr
 Ste 104
 Gold Canyon, AZ 85118
 (480) 474-9838

05/18/20 03:36 PM

We are the one stop for all your shipping, postal and business needs.

We offer all the services you need to keep your business going.



001 000003 (011) TO \$ 10.00
 Notary

SubTotal \$ 10.00
 Total \$ 10.00

Cash \$ 100.00
 Change \$ 90.00

Receipt ID: 83947883956030888361 001 Items
 CSH: John Tran: 8414 Reg: 001

Thank you for visiting our store.
 Please come back again soon.

Whatever your business and personal needs, we are here to serve you.

We're here to help.
 Join our FREE email program to receive great offers and resources.

www.theupsstore.com/signup

UNITED STATES POSTAL SERVICE
REGISTERED MAIL™

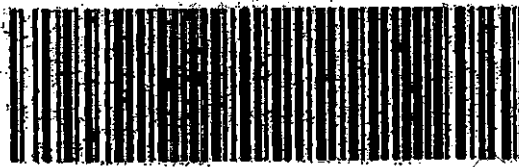

RE 047 610 440 US

Label 200, August 2005

PSN 7690-03-000-9311

Registered No.

RE22307559US

To Be Completed By Post Office	Reg. Fee	\$4.20	
	Handling Charge	\$13.00	Return Receipt
	Postage	\$2.85	Restricted Delivery
	Received by	\$0.00	

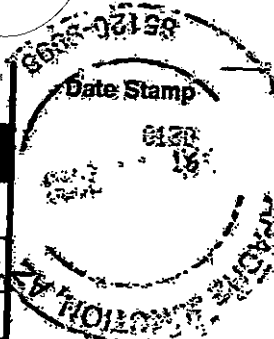

Customer Must Declare Full Value \$21.00

Domestic Insurance up to \$25,000 is included based upon the declared value. International Insurance is limited. (See Reverse)

To Be Completed by Customer (Please Print) All Entries Must Be in Ballpoint or Typewritten

FROM: Darrell James Hill, Notary
 90 PO Box 3806
 Apache Junction, Arizona 85117

TO: Donald John Temp, Trustee
 1600 Pennsylvania Ave NW
 Washington, District of Columbia 20500

PS Form 3806, Receipt for Registered Mail, Copy 1 - Customer
 May 2007 (7530-02-000-9051)
 For domestic delivery information, visit our website at www.usps.com

Unofficial

1549

2022-011769 MISC Page: 1552 of 2782
 09/26/2022 03:35:37 PM Receipt #: 22-9381
 Rec Fee: \$30.00 Darrell James Hill
 Gila County, Az, Sadie Jo Bingham, Recorder



OFFICE ADDRESS
 151 W SUPERSTATION BLVD
 APACHE JUNCTION, AZ 85120-9998
 030269-0130
 (800)273-8777
 05/18/2022 03:35 PM

Product	Qty	Unit Price	Price
First-Class Package Service 3 Days (Domestic) (WASHINGTON, DC 20500) (Weight: 0 Lb 2.10 Oz) (Estimated Delivery Date) (Friday 05/22/2022)	1	\$4.20	\$4.20
Registered			\$13.20
Return Receipt			\$2.85
Total:			\$20.25

Cash Change \$100.00 (\$79.75)

Due to the security of Registered Mail, an additional 3-10 delivery days should be added to the expected delivery date provided.

In a hurry? Self-service kiosks offer quick and easy check-out. Any Retail Associate can show you how.

Text your tracking number to 28777



Registered No. RE32238755909

Reg. Fee	\$4.20	
Handling Charge	\$13.20	Return Receipt
Postage	\$2.85	Restricted Delivery
Received by	\$0.00	
		\$20.25

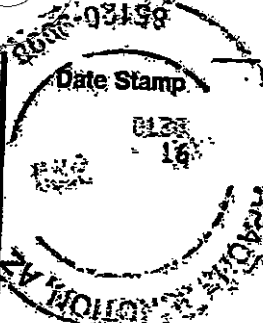

Customer Must Declare Full Value \$21.00
 Domestic Insurance up to \$25,000 is included based upon the declared value. International liability is limited. (See Reverse)

FROM: Darrell James Hill, beneficiary
 90 PO Box 3806
 Apache Junction, Arizona 85117

TO: Donald John Trump, trustee
 1600 Pennsylvania Ave NW
 Washington, District of Columbia 20500

PS Form 3806, Receipt for Registered Mail
 May 2007 (7530-02-000-9051) Copy 1 - Customer
 (See Information on Reverse)
 For domestic delivery information, visit our website at www.usps.com

To be Completed by Customer (Pen or Ink)
 All Entries Must Be in Ballpoint or Typed





Tony Rogers
La Paz County Attorney
1320 KOHA AVENUE
PARKER, AZ 85344

Darrell James Hill
P.O. Box 3806
Apache Junction, AZ 85117

8511784137 EC36

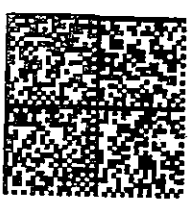

NEOPOST
FIRST-CLASS MAIL
\$000.80
06/01/2020 ZIP 85344
043M/30204003

US POSTAGE

2022-011769 MISC Page: 1554 of 2782
09/26/2022 03:35:37 PM Receipt #: 22-9381
Rec Fee: \$30.00 Darrell James Hill
Gila County, Az, Sadie Jo Bingham, Recorder



1554

U.S. Postal Service™
CERTIFIED MAIL™ RECEIPT
 (Domestic Mail Only; No Insurance Coverage Provided)

For delivery information visit our website at www.usps.com

PHOENIX 85004 OFFICIAL USE

Postage	\$3.55
Certified Fee	\$2.95
Return Receipt Fee (Endorsement Required)	\$0.00
Restricted Delivery Fee (Endorsement Required)	\$0.00
Total Postage & Fees	\$6.50

0130
16

Postmark Here

06/15/2020

Sent to **Doug Duce & Mark Brinrich**
 Street, Apt. No. or PO Box No. **2005 N. Central Ave**
 City, State, ZIP+4 **Phoenix, Arizona 85004-2926**

PS Form 3800, August 2006 See Reverse for Instructions

7009 2820 0003 8851 6032

2591

APACHE JUNCTION
 151 W SUPERSTITION BLVD
 APACHE JUNCTION, AZ 85120-9998
 030259-0130
 (800)275-8777
 06/15/2020 10:44 AM

Product	Qty	Unit Price	Price
---------	-----	------------	-------

First-Class Mail® Letter	1	\$0.85	\$0.85
--------------------------	---	--------	--------

(Domestic)
 (PHOENIX, AZ 85004)
 (Weight: 0 Lb 2.30 Oz)
 (Estimated Delivery Date)
 (Thursday 06/18/2020)

Certified (USPS Certified Mail #X) \$3.55
 (70092820000388516032)

Return Receipt (USPS Return Receipt #) \$2.85
 (9590940247428344639615)

First-Class Mail® Letter	1	\$0.85	\$0.85
--------------------------	---	--------	--------

(Domestic)
 (PARKER, AZ 85344)
 (Weight: 0 Lb 2.30 Oz)
 (Estimated Delivery Date)
 (Thursday 06/18/2020)

Certified (USPS Certified Mail #) \$3.55
 (70122210000042697391)

Return Receipt (USPS Return Receipt #) \$2.85
 (9590940247428344639646)

Uncle Sams Hat	14	\$0.15	\$2.10
----------------	----	--------	--------

Total: \$16.60

Cash Change \$17.00
 (\$0.40)

 Due to limited transportation availability as a result of nationwide COVID-19 impacts, package delivery times may be affected.

COMPLETE THIS SECTION ON DELIVERY

RECEIVED

A. Signature Agent Addressee

B. Received by Date of Delivery

C. Is delivery address different from 1? Yes No
 If YES, enter delivery address below:
**AZ ATTORNEY GENERAL
 PHOENIX MAIL ROOM
 PALM BUILDING**

D. Is delivery address different from 1? Yes No

3. Service Type

Priority Mail Express®
 Registered Mail™
 Registered Mail Restricted Delivery
 Certified Mail®
 Certified Mail Restricted Delivery
 Collect on Delivery
 Insured Mail, including Mail Restricted Delivery (over \$500)
 Return Receipt for Merchandise
 Signature Confirmation™
 Signature Confirmation Restricted Delivery

Domestic Return Receipt

SENDER: COMPLETE THIS SECTION

1. Complete items 1, 2, and 3.
 2. Print your name and address on the reverse so that we can return the card to you.
 Attach this card to the back of the mailpiece, or on the front if space permits.
 3. Article Addressed to:
**Doug Duce
 & Mark Brinrich
 2005 N. Central Ave
 Phoenix, Arizona 85004**

9590 9402 4742 8344 6396 15

2. Article Number (transfer from service label)
7009 2820 0003 8851 6032

PS Form 3811, July 2015 PSN 7530-02-000-9053



U.S. Postal Service™
CERTIFIED MAIL™ RECEIPT
 (Domestic Mail Only; No Insurance Coverage Provided)

For delivery information visit our website at www.usps.com

OFFICIAL USE

7012 2210 0000 4269 7391

Postage	\$3.55
Certified Fee	\$2.85
Return Receipt Fee (Endorsement Required)	\$0.00
Restricted Delivery Fee (Endorsement Required)	\$0.00
Total Postage & Fees	\$7.25

0130
16
Postmark Here
06/15/2020

8991

APACHE JUNCTION
 151 W SUPERSTITION BLVD
 APACHE JUNCTION, AZ 85120-9998
 030259-0130
 (800)275-8777
 06/15/2020 10:44 AM

Product	Qty	Unit Price	Price
First-Class Mail® Letter (Domestic) (PHOENIX, AZ 85004) (Weight: 0 Lb 2.30 Oz) (Estimated Delivery Date) (Thursday 06/18/2020)	1	\$0.85	\$0.85
Certified (USPS Certified Mail #X (70092820000388516032))			\$3.55
Return Receipt (USPS Return Receipt #) (9590940247428344639615)			\$2.85
First-Class Mail® Letter (Domestic) (PARKER, AZ 85344) (Weight: 0 Lb 2.30 Oz) (Estimated Delivery Date) (Thursday 06/18/2020)	1	\$0.85	\$0.85
Certified (USPS Certified Mail #) (70122210000042697391)			\$3.55
Return Receipt (USPS Return Receipt #) (9590940247428344639646)			\$2.85
Uncle Sams Hat	14	\$0.15	\$2.10
Total:			\$16.60

Cash Change \$17.00 (\$0.40)

Sent To: **Tony Rogers**
 Street, Apt. No. or PO Box No. **1320 Kofa Avenue**
 City, State, ZIP+4 **Parker, Arizona 85344**
 PS Form 3800, August 2006 See Reverse for Instructions

COMPLETE THIS SECTION ON DELIVERY

A. Signature Agent Addressee

B. Received by (Printed Name) _____ C. Date of Delivery _____

D. Is delivery address different from item 1? Yes No
 If YES, enter delivery address below: _____

3. Service Type
 Priority Mail Express®
 Registered Mail™
 Adult Signature Restricted Delivery
 Certified Mail®
 Certified Mail Restricted Delivery
 Collect on Delivery
 Insured Mail (over \$500)
 Return Receipt for Merchandise
 Signature Confirmation™
 Signature Confirmation Restricted Delivery

Domestic Return Receipt

SENDER: COMPLETE THIS SECTION

1. Article Addressed to:
 Complete items 1, 2, and 3.
 Print your name and address on the reverse so that we can return the card to you.
 Attach this card to the back of the mailpiece, or on the front if space permits.

2. Article Addressed to:
Tony - La Paz Co Atty. Rogers
1320 Kofa Avenue
Parker, Arizona 85344

9590 9402 4742 8344 6396 46

2. Article Number (transfer from service label)
7012 2210 0000 4269 7391

 Due to limited transportation availability as a result of nationwide COVID-19 impacts, package delivery times may be affected.

UNDELIVERED



:Darrell-James: Hill, -:civilian, -:Executor
PO Box 3806
Apache Junction, Arizona 85117
:man, :present

:The United States of America,

Arizona state
Pinal county

To: Tony: La Paz county Attorney -:Rogers, Trustee
:Ryan-N.: Chief Deputy La paz county Attorney -:Dooley
c/o :Tony: Rogers, Trustee -- USPS CMN 7012 2210 0000 4269 7391
1320 Kofa Avenue
Parker, Arizona 85344

Re: ~**Political Election; Request for Protection**~ "I am returning the fictitious [FICTITIOUS Pretended; supposed; as, fictitious actions; fictitious payee.] documents that you recently sent the La Paz County Sheriff." - regarding the: 'Declaration of :i- man...' WITHOUT THE DEMOGRAPHY; appended: 13 pages; dated: June 1, 2020 [A.D.], 1 page.

Greetings :Tony, Ryan-N.; Arizona- state -:constitutional -officers

:This -notice to the man- agent(s) must be -made-noticed to the Trustee- principal(s); notice to the Trustee- principal(s) is notice to the agent:

1) Legalese- Idiot: i- man am the :literate :legalese- idiot :non-member of the B.A.R. -legal society; and: 2) Now-to-forward, :all -communication must be with the words in the common-usage in the common -law meanings and methods; and: 3) To infer upon the :righteous-truth of the presentment- :in- material- fact you must present with the :verified- claim of your injury; and:

4) Compensation for: Injury upon :i- man: Beyond the :publically -known -:compensation- obligation due for trespass against :i- man, :i- man do not now wish to contract; and:

5) Protection: i- man do not ask for the man- Bill : sheriff -:Risen's opinion, but for his, et al.'s lawful duty of :protection against the injury from the sundry dishonorable- men acting under the cover of the violent protests fomented in this :nation at this time.

Thank you;

cc: man -
:Doug :Arizona state Governor -:Ducey
c/o :Mark :Arizona state AG -:Brnovich - USPS CMN 7009 2820 0003 8851 6032
2005 N Central Ave
Phoenix, Arizona 85004-2926

1554
Political Election; Request for Protection to :Tony: Rogers, Trustee - La Paz county, Arizona state:
USPS CMN 7012 2210 0000 4269 7391

2022-011769 MISC Page: 1557 of 2782

09/26/2022 03:35:37 PM Receipt #: 22-9381
Rec Fee: \$30.00 Darrell James Hill
Gila County, Az, Sadie Jo Bingham, Recorder



:Michael :Apache county Attorney -:Whiting
PO Box 637
St. Johns, Arizona 85936

:Bradley- D. :Gila county Attorney -:Beauchamp
1400 E. Ash Street
Globe, Arizona 85501

:William-P. :Coconino county Attorney -:Ring
110 E. Cherry Ave.
Flagstaff, Arizona 86001

:George :Santa Cruz county Attorney -:Silva
2150 N. Congress Drive
Nogales, Arizona 85621

:Sheila :Yavapai county Attorney -:Polk
255 E Gurley Street
Prescott, Arizona 86301

:Brian :Cochise county Attorney -:McIntyre
150 Quality Hill Rd, 2nd Floor
P.O. Drawer GA
Bisbee, Arizona 85603

:Jeremy : Greenlee county Attorney -:Ford
P.O. Box 1717
Clifton , Arizona 85533

:Kent :Pinal county Attorney -:Volkmer
P.O. Box 887
Florence, Arizona 85132

:Allister :Maricopa county Attorney -:Adel
225 West Madison Street
Phoenix, Arizona 85003

Matthew-J. :Mohave county Attorney -:Smith
315 N. 4th Street
Kingman, Arizona 86401

:Barbara :Pima county Attorney -:LaWall
32 N. Stone Avenue
Tucson, Arizona 85701

:Kenny :Graham county Attorney -:Angle
800 Main Street
Safford, Arizona 85546

:Brad :Navajo county Attorney -:Carlyon
100 East Code Talkers Drive
South Highway 77
P.O. Box 668
Holbrook, AZ 86025

:Jon-R. :Yuma county Attorney -:Smith
Yuma county Justice Center
250 W 2nd St.
Suite G
Yuma, Arizona 85364

Appended: 14 pages

:i- man affirm this is right-truth and correct, and will testify :same onto the record in the open court.

Without prejudice

Darrell James Hill, AR
:Darrell-James: Hill, -:James Hill, -:Executor

Affirmed and autographed before me this 15 day :June 2020.
Type of Identification: Arizona Driver License

Adam Smiskey
Notary Public



Political Election; Request for Protection to :Tony: Rogers, Trustee – La Paz county, Arizona state;
USPS CMN 7012 2210 0000 4269 7391

212

2022-011769 MISC Page: 1558 of 2782
09/26/2022 03:35:37 PM Receipt #: 22-9361
Darrell James Hill
Rec Fee: \$30.00
Gila County, Az, Sadie Jo Birmingham, Recorder



1556

CERTIFIED MAIL™



7012 2210 0000 4289 7391

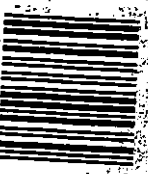

1000

85344

U.S. POSTA
FORM LETTER
APACHE JU
95120
JUN 15, 20
AMOUNT
\$7.22
R2305H1283

ROY

2022-011769 MISC Page: 1559 of 2782

09/26/2022 03:35:37 PM Receipt #: 22-9381
Rec Fee: \$30.00 Darrell James Hill
Gila County, Az, Sadie Jo Bingham, Recorder



US POSTAGE

NEOPOST

FIRST-CLASS MAIL

\$000.95⁰⁰

06/17/2020 ZIP 85344
043M90204003

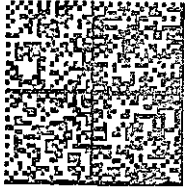

Tony Rogers
La Paz County Attorney
1320 KOFA AVENUE
PARKER, AZ 85344



Darrell James Hill
P.O. Box 3806
Apache Junction, AZ 85117

2022-011769 MISC Page: 1560 of 2782

09/26/2022 03:35:37 PM Receipt #: 22-9381
Rec Fee: \$30.00 Darrell James Hill
Gila County, Az, Sadie Jo Bingham, Recorder



1557

Unofficial Copy

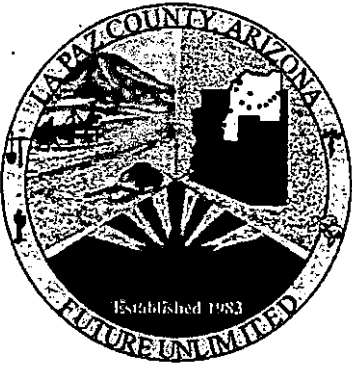

Office of the La Paz County Attorney
Civil Division
1320 Kofa Avenue
Parker, Arizona 85344
(928)669-6469 / Fax (928)669-6311

Tony Rogers
County Attorney

June 17, 2020

Darrell James Hill
P.O. Box 3806
Apache Junction, AZ 85117

Dear Mr. Hill:

I am returning the documents that you recently mailed to my office (again) as I located no criminal or civil case involving yourself and the County or the Sheriff.

If you need legal advice, then you might find the State Bar of Arizona's website (www.azbar.org) a helpful source of information to assist you.

Sincerely,

Ryan N. Dooley
Chief Deputy La Paz County Attorney

Enc: as stated above

2022-011769 MISC Page: 1561 of 2782
09/26/2022 03:35:37 PM Receipt #: 22-9381
Rec Fee: \$30.00 Darrell James Hill
Gila County, Az, Sadie Jo Bingham, Recorder



1558

:Darrell-James: Hill, -:civilian, -:Executor
c/o PO Box 3806, Apache Junction, Arizona 85117.
:man -:present,

:The United States of America

Arizona state
Pinal county

To: Doug :Arizona state Governor -:Ducey, -:Trustee¹,
:Katie :Secretary of State -:Hobbs
c/o: Katie: Hobbs, -:Trustee – USPS RMN RE 047 610 526 US
1700 West Washington Street, Floor 7
Phoenix, Arizona 85007

:John :Director- Dept. of Transportation -:Halikowski, -:Trustee
:Tim :Director- Enforcement and Compliance Division -: Lane, -:Trustee
:Scott :COO- Dept. of Transportation -:Omer
c/o: Scott: Omer, -:Trustee – USPS CMN 7009 1410 0000 7868 5796
206 South 17th Avenue, Mail Drop 100A
Phoenix, Arizona 85007

Re: :Specialized Negotiable Instrument- Presentment: USPS-RMN- 'RE 047 610 526
US' With The 1) Authorization For The Termination Of The Compelled Benefit Of
The 'Arizona Driver License' Upon The Notice Of The Same to :i-man; And, 2)
With The Return Of The Four -Property- Bonds: 'Arizona Certificates Of Title'
From :Arizona- Motor -Vehicle -Division For The Ending Of The :Bond
-Relationship Is Now Exercised By The Bond- Holder -:Darrell-James: Hill,
 -:Executor, :husband, With The Wife: -Bond -Holder, -:Beverly-Jean: Romero-
Hill, -:Executor, Affirming:

1) :Title-Number – K015013311014, :Issue-Date – 11072013, :File-Number –
N311K01506; – Property- (Vehicle) Identification – :Number: 22D42408S6936;
appended, bond: one.

2) :Title-Number – K015013311011, :Issue-Date – 11072013, :Film- Number –
N311K01505; + Property- (Vehicle) Identification – :Number:
1FTHX26H6FKB58041; appended, the bond: one.

3) :Title-Number – K015013311008, :Issue-Date – 11072013, :Film-Number –
N311K01504; – Property- (Vehicle) Identification – :Number:
1G8EK16L1GF207716; appended, the bond: one.

4) :Title-Number – 17AK011018008, :Issue-Date – 01182011, :Film-Number –
L01817AK03; – Property- (Vehicle) Identification – :Number:
1GBKP37W3H3313848; appended, the bond: one.

:Claim - :Right to Conveyance for Property-held-without-right in: Dry-Trust: EBA-1933 A.D - 2003 A.D.
USPS RMN RE 047 610 526 US JUNE 22, 2020 1 / 6

2022-0111769 MISC Page: 1562 of 2782

09/26/2022 03:35:37 AM Receipt #: 22-9381

Reg Fee: \$30.00 Darrell James Hill

Gila County, Az, Sadie Jo Bingham, Recorder



Greetings :Doug, :Katie, :John, :Tim, :Scott:

Affiant: – :standing, political election and status. :i- man², :beneficiary³ -by-:birth⁴ of the inherent -trust⁵ from :Almighty God⁶~ where nothing stands between :Almighty-God and :i- man ~ am (1) :Executor- Darrell-James: Hill © 1958 A.D., :Ohioan^{7 8}, in the fullness of age, and of :sound- mind; (2) by :birth :Negro⁹ -:beneficiary of the :Emancipation- Proclamation -1863¹⁰ and forever-guaranteed -:protection by the Army, et al., by the full- force and authority of The Constitution for the United States of America ~ 1789-1791~¹¹; and: (3) :beneficiary of the 'UNITED-STATES-corporation' -:government¹² -services-provider-Trustee's :self-indenture¹³ to :i-man: by the 'Emergency Banking Act of 1933, et al.¹⁴, 'EBA-1933-A.D.'~ ended 2003 A.D.~ with the debenture^{15 16} created in the 'idem-sonans¹⁷ -:subrogation¹⁸ entitled: DARRELL JAMES HILL~ & et al. derivatives~ © 1958 A.D., :STATE-OF-OHIO¹⁹ - pending settle and closure- :May- 2020 A.D.

Return Of :Property- Bonds For The End Of :All -Compelled- Contracts

- 1) :i- man believe that it is in my best interest at this time to no longer register property under the 'State of Arizona -Certificate of Title' for the property referenced;
- 2) :i- man believe that the righteous-choice for the a) non-renewal of the registration ~ done, and b) :this -demand for the receipt of the 'title' to this property is the exercise of the inherent- property-right by :i- man;
- 3) :i- man believe that this election is merely the rightful- exercise of the option for the title-of- the-property-held to be severed from the compelled- 'State of Arizona' -granted -rights and privileges and related -adhesion-contracts thereto;
- 4) :i- man believe that it is in my best interest at this time to return the :State-of-Arizona-certificate-of-titles' for to receive from the State of Arizona system :all of the titles in the absolute -ownership to none other but to :i- man;
- 5) :i-man believe that the exercise of this chose is in the sole -discretion of the none-other than :i- man;
- 6) :i- man believe that the State of Arizona has no discretion in this matter; and,
- 7) :i-man deny-now your any importune for your discretion, thank-you but no;
- 8) :i- man am /not a U.S. Citizen; please correct any error on this matter in the any record. Finally,
- 9) :i- man believe that the "Arizona Driver License" is not required for :i-man to travel in the Arizona state. Thereto, :i- man now authorize for :you to terminate the compelled -benefit of the Arizona Driver License for :i- man with due notice and replacement with the benefit -functional -equivalent that is ambassadorial and/or otherwise without the :compelled -adhesion-contracts.

:Compensation For The Trespass Upon This Right

:Where as by the effort by the State of Arizona, et al., to administer this :property without the right is willful wrong-doing not- authorized to the 'State of Arizona, et al.- you', by :i- man: Darrell-James: Hill and/ or Beverly-Jean: Romero- Hill is trespassing upon the right, and subject, by the tacit acquiescence, to the compensation established in the record at the rate of :one- ounce of :silver, U.S. mint, in -specie per minute beginning from the time of this special-negotiable-instrument-sending unto the end of the matter with the payment of the compensation due upon the any request for the :any-debt-amount -accumulated with the default to the billing thereof after the period of the thirty serial calendar days following the

:Claim - :Right to Conveyance for Property-held-without-right in: Dry-Trust: EBA-1933 A.D - 2003 A.D.
USPS RMN RE 047 610 526 US JUNE 22, 2020 2 / 6

2022-011769 MISC Page: 1563 of 2782
09/26/2022 03:35:37 PM Receipt #: 22-9381
Rec Fee: \$30.00 Darrell James Hill
Gila County, AZ, Sadie Jo Bingham, Recorder

receipt of the bill of the particulars.

cc:

:Mark -Sheriff Pinal county, Arizona -:Lamb
971 N Jason Lopez Circle, Building C
PO Box 867
Florence, Arizona state 85132

enclosures:

- 1) Property- (Vehicle) Identification – :Number: 22D42408S6936; appended, the bond, 1 sheet.
- 2) :Property- (Vehicle) Identification – :Number: 1FTHX26H6FKB58041; appended, the bond, one sheet.
- 3) :Property- (Vehicle) Identification – :Number: 1G8EK16L1GF207716; appended, the bond, one sheet.
- 4) :Property- (Vehicle) Identification – :Number: 1GBKP37W3H3313848; appended, the bond, one sheet.

Notice to the primary Trustee is :notice to every minister;
Notice to the any minister must be made notice to the primary Trustee.

:i- man affirm all said above is true and correct, and will state same in the open court.

Without prejudice

Darrell James Hill, A.R.

:Darrell-James: Hill, civilian- :Executor;

Without prejudice

Beverly-Jean Romero Hill, A.R.

:Beverly-Jean: Romero Hill, civilian- :Executor.

Jurat

Affirmed and autographed before me this day 22ND June, the year of our Lord 2020 A.D.
Type of Identification: Arizona Driver License.

[Signature]
Notary Public

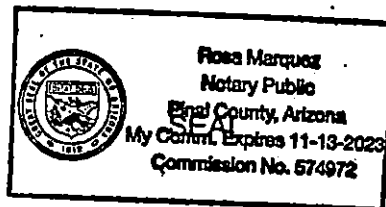

:Claim - :Right to Conveyance for Property-held-without-right in: Dry-Trust: EBA-1933 A.D - 2003 A.D.
USPS RMN RE 047 610 526 US JUNE 22, 2020 3 / 6

2022-011769 MISC Page: 1564 of 2782
09/26/2022 03:35:37 PM Receipt #: 22-9381
Rec Fee: \$30.00 Darrell James Hill
Gila County, Az, Sadle Jo Bingham Recorder



- 1 :Trustee means: 1) one to whom an estate has been conveyed in trust; trust means: TRUST, contracts, devises. An equitable right, title or interest in property, real or personal, distinct from its legal ownership; or it is a personal obligation for paying, delivering or performing anything, where the person trusting has no real right or security, for by, that act he confides altogether to the faithfulness of those intrusted. This is its most general meaning, and includes deposits, bailments, and the like. In its more technical sense, it may be defined to be an obligation upon a person, arising out of a confidence reposed in him, to apply property faithfully, and according to such confidence. Willis on Trustees, 1; 4 Kent, Com. 295; 2 Fonb. Eq. 1; 1 Saund. Uses and Tr. 6; Coop. Eq. Pl. Introd. 27; 3 Bl. Com. 431. 2) for the Emergency Banking Act of 1933, et al., et seq., 'EBA-1933-A.D.'
- 2 :i-man means: 'i' refers to :Almighty-God as the great 'i- am'. And: 'i- man/' 'i-man' acknowledges that the Almighty-God -created the 'man' is present.
- 3 :beneficiary means: one onto whom a :trust-benefit is disposed by the :Executor of the beneficiary's property.
- 4 :birthed :son of :Clarence, :son of :James, :son :Negroland, :Kingdom-of-Judah, :Africa', ...:son :Ysrael- :Southern-Kingdom ~ of the sons :Judah and Benjamin and and Levi, et al., ...:son of :Jacob and :Ysrael, :son of :Isaac, :son of :Abram and :Abraham, ...:son of :Shem, :son of :Noah, ...:son of :Methuselah, :son of :Enoch, ...:son of :Seth, :son of :Adam with :Eve of the garden of :Eden .
- 5 inherent -trust means: that trust given by the Creator- :Almighty-God to :i-man-kind; e.g., :gravity, water, :man- value.
- 6 :Almighty God means: the only begotten son of the Most High God, :Creator of the worlds, Yushuah the Messiah~a.k.a. Jesus the Christ~, He who for our sake for our redemption did ly down His glory, birthed as man-kind onto our earth-planet, fulfilled all of the word, Law and prophesy, then layed-down his :life, giving his life for to atone for our sins so that :man-kind -whosoever-will may become like Him, in the fullness of that stature, sons of the Most-High-God.
- 7 Record of live Birth means: Authentication ~:Birth No 134 - 58 -208851, Certified Doc.# F4012649, :State Registrar - Judith-B.: Nagy, May -9, 2018.; and: (2) OHIO- SOS -certification: C074912, :Jon: Husted, June 14, 2018; and: (3) The United States of America- SOS- Authentication No. 18047749-2, :Michael -R: Pompeo, July 17, 2018 ~ :Debenture; appended: 3 pages.
- 8 :Darrell-James: Hill means: :Darrell-James: Hill means: Darrell-James: Hill ©1958: Ohioan, © 1958: State of Ohio: beneficiary. See: Gila county Arizona: Doc. # 2017-002378: pp. 6-24, 89-91,93-95 of 693. Gila county Arizona: Doc. # 2018-005176: pp. 10-21; and, et seq. See: :i- man -file of: Specialized Negotiable Instruments to the :man - :Barak-Hussein: Obama, :Donald-John: Trump, et al., et seq.
- 9 Ibid 4.
- 10 Emancipation Proclamation of 1863 means: Proclamation 95 from POTUSA Abraham Lincoln on September 22nd, 1862: effective :January 1st, 1863. EMANCIPATION. An act by which a person, who was once in the power of another, is rendered free, as is the 'Declaration of Independence of 1776 A.D.' upon all man-kind, on the people upon the land.
- 11 The Constitution for the United States of America ~ 1789-1791~ means: The :original - organic -constitution and includes the 'Bill of Rights', et al.
- 12 'United-States-corporation' -government means: 'UNITED-STATES-corporation' -government -services -provider -Trustee: 1863 A.D. e.g., (1) cf.1929: Herbert-Clark: POTUS Hoover with: (2) cf.1934: Franklin-Delano: POTUS Roosevelt- Trustee/ :EBA-1933-A.D; with (3) cf.2020: Donald-John: POTUS Trump- Trustee/ EBA-1933-A.D, CIC under U.S. Constitution - incorporated, and (4) cf. :Donald-John: POTUS Trump, CIC under The Constitution for the United States of America - unincorporated.
- 13 :indenture means: INDENTURE, conveyancing. An instrument of writing containing a conveyance or contract between two or more persons, e.g., as between the 'UNITED-STATES-CORPORATION' and 'The United States of America, unincorporated, i.e., the people of the non-political- aggregate.
- 14 :Emergency Banking Act of 1933, et al. means: Public Law 73-1/ Statutes at Large 48 Stat. 1, et al. Trading With The Enemy Act, amended ~Subdivision (b) of section 5 of the Act of October 6, 1917 ... as follows: During time of war or during any other period of national emergency declared by the President... President may require any person within the United States... engaged in any transaction... be fined... imprisoned... or both... OF Trading with the Enemy Act of 1917, Pub.L. 65-91, 40 Stat. 411.
- 15 :debenture means: DEBENTURE. A certificate given, in pursuance of law, by the collector of a port of entry for a certain sum, due by the United States, payable at a time therein mentioned, to an importer for drawback of duties on merchandise imported and exported by him, provided the duties arising on the importation of the said merchandise shall have been discharged prior to the time aforesaid. Vide Act of Congress of March 2, 1799, s. 80; Encyclopædie, h. t.; Dane's Ab. Index, h. t.
- 16 Birth-day means: the 20th day, November, year of our Lord 1958 A.D. at 11:35 a.m. Ibid 11. Birth. The act of being wholly brought into the world. The whole body must be detached from that of the

1502



mother, in order to make the birth complete. 5 C. & P. 329; S. C. 24 E. C. L. R. 344 6 C. & P. 349; S. C. 25 E. C. L. R. 433.

day. A division of time. It is natural, and then it consists of twenty-four hours, or the space of time which elapses while the earth makes a complete revolution on its axis; or artificial, which contains the time, from the rising until the setting of the sun, and a short time before rising and after setting. Vide Night; and Co. Lit. 136, a.

2. Days are sometimes calculated exclusively, as when an act required that an appeal should be made within twenty days after a decision. 3 Penna. 200; 3 B. & A. 581; 15 Serg. & Rawle, 43. In general, if a thing is to be done within such a time after such a fact, the day of the fact shall be taken inclusively. Hob. 139; Doug. 463; 3 T. R. 623; Com. Dig. Temps, A; 3 East, 407.

3. The law, generally, rejects fractions of days, but in some cases it takes notice of such parts. 2 B. & A. 586. Vide Date.

17 Idem-sonans means: IDEM SONANS. Sounding the same.

2. In pleadings, when a name which it is material to state, is wrongly spelled, yet if it be idem sonans with that proved, it is sufficient, as Segrave for Seagrave, 2 Str. R. 889; Keen for Keene, Thach. Cr. Cas. 67; Deadema for Diadema, 2 Ired. 346; Hutson for Hudson, 7 Miss. R. 142; Coonrad for Conrad, 8 Miss. R. 291. See 5 Pike, 72; 6 Ala. R. 679; vide also Russ. & Ry. 412; 2 Taunt. R. 401. In the following cases the variances there mentioned were declared to be fatal. Russ. & Ry. 351; 10 East, R. 83; 5 Taunt. R. 14; 1 Baldw. R. 83; 2 Crom. & M. 189; 6 Price, R. 2; 1 Chit. R. 659; 13 E. C. L. R. 194. See, generally, 8 Chit. Pr. 231, 2; 4 T. R. 611; 3 B. & P. 559; 1 Stark. R. 47; 2 Stark. R. 29; 3 Camp. R. 29; 6 M. & S. 45; 2 N. H. Rep. 557; 7 S. & R. 479; 3 Caines, 219; 1 Wash. C. C. R. 285; 4 Cowen, 148 and the article Name.

18 Subrogation means: SUBROGATION, civil law, contracts. The act of putting by a transfer, a person in the place of another, or a thing in the place of another thing. It is the substitution (q. v.) of a new for an old creditor, and the succession to his rights, which is called subrogation; transfusio unius creditoris in alium. It is precisely the reverse of delegation. (q. v.)

2. There are three kinds of subrogation: 1. That made by the owner of a thing of his own free will; example, when he voluntarily assigns it. 2. That which arises in consequence of the law, even without the consent of the owner; example, when a man pays a debt which could not be properly called his own, but which nevertheless it was his interest to pay, or which he might have been compelled to pay for another, the law subrogates him to all the rights of the creditor. Vide 2 Binn. Rep. 382; White's L. C. in Eq.* 60-72. 3. That which arises by the act of law joined to the act of the debtor; as, when the debtor borrows money expressly to pay off his debt, and with the intention of substituting the lender in the place of the old creditor. 7 Toull. liv. 3, t. 3, c. 5, sect. 1, §2. Vide Civ. Code of Louisiana, art. 2155 to 2158; Merl. Repert. h. t.; Dig. lib. 20; Code, lib. 8, t. 18 et 19 9 Watts. R. 451; 6 Watts & Serg. 190; 2 Bouv. Inst. n. 1413.

19 berth-date means: the 28th day, November, year of our Lord 1958 A.D., in the 244th year of the United States: Ibid 11.

Berth: (v.) 1660s, of ships, from berth (n.). Of persons (intransitive), from 1886. Related: Berthed; berthing. berth (n.) 1620s, "convenient sea room" (both for ships and sailors), of uncertain origin, probably from bear (v.) + abstract noun suffix -th (2) as in strength, health, etc. Original sense is preserved in phrase to give (something or someone) wide berth. Meaning "place on a ship to stow chests, room for sailors" is from 17 extended to non-nautical situations by 1778.

Date. The designation or indication in an instrument of writing, of the time, and usually of the time and place when and where it was made. When the place is mentioned in the date of a deed, the law intends, unless contrary appears, that it was executed at the place of the date. Plowd. 7 b., 31 H. VI. This word is derived from the Latin datum, because when deeds and agreements were written in that language, immediately before the day, month and year in which they were made, was set down, it was usual to put the word datum given.

2. All writings ought to bear a date, and in some it is indispensable in order to make them valid, as in policy of insurance; but the date in these instruments is not inserted in the body of the writing because as each subscription makes a separate contract, each underwriter sets down the day, month and year he makes his subscription. Marsh. Ins. 336.

3. Deeds, and other writings, when the date is an impossible one, take effect from the time of delivery; the presumption of law is, that the deed was dated on the day it bears date, unless, as just mentioned, the time is impossible; for example, the 32d day of January.

4. The proper way of dating, is to put the day, month, and year of our Lord; the hour need not be mentioned unless specially required; an instance of which may be taken from the Pennsylvania Act of the 16th June, 1836, sect. 40, which requires the sheriff, on receiving a writ of fieri facias, or other writ of execution, to endorse thereon the day of the month, the year, and the hour of the day whereon he received the same.

5. In public documents, it is usual to give not only the day, the month, and the year of our Lord, but also the

2022-0111769 MISC Page: 1566 of 2782

09/26/2022 03:35:37 PM Receipt #: 22-9381
Darrell James Hill
Gila County, Az. Sadie Jo Bingham, Recorder



1563

year of the United States, when issued by authority of the general government; or of the commonwealth, when issued under its authority. Vide, generally, Bac. Ab. Obligations, C; Com. Dig, Fait, B 3; Cruise, Dig. tit, 32, c. 20, s. 1-6; 1 Burr. 60; 2 Rol. Ab. 27, 1. 22; 13 Vin. Ab. 34; Dane's Ab. Index, h. t. See Almanac.

1564

Unofficial Copy

2022-011769 MISC Page: 1567 of 2782
09/26/2022 03:35:37 PM Receipt #: 22-9381
Rec Fee: \$30.00 Darrell James Hill
Gila County, Az. Sadie Jo Bingham, Recorder



ARIZONA CERTIFICATE OF TITLE



Inventory Control
24309059

Vehicle Identification Number 22D42408S6936
 Year 1979 Make PROWL Model Body Style TV
 First Registered 05/1978 List Price 006021 Mobile Home Manufacturer Unit Number

DARRELL JAMES HILL
 3018 JOHNSON ST
 LAKESIDE AZ 85929-5309

Title Number K015013311014 Issue Date 11/07/2013 Film Number N311K01506 Odometer Miles (no tenths) 000000
 Previous Title Number AV23010111004 AZ State Issue Date 04/21/2010 Previous Film Number K111AV2302
A - Actual Mileage
 B - Mileage in excess of the odometer mechanical limits
 C - NOT Actual Mileage, WARNING ODOMETER DISCREPANCY

Arizona Brands

Previous Brand State Previous Brand State Previous Brand State Other States With Brands

Owners/Lessees
 DARRELL JAMES HILL
 BEVERLY JEAN ROMERO HILL
 AND/OR

Lienholders

LIEN RELEASE

Lienholder Name	Acknowledged before me this date.	Notary Public Signature
Lien Amount	Date	County State Commission Expires

2022-011769 MISC Page: 1568 of 2782
 09/26/2022 03:35:37 PM Receipt # : 22-9381
 Rec Fee: \$30.00 Darrell James Hill
 Gila County, Az, Sadie Jo Blinsham, Recorder

VOID WITHOUT EAGLE WATERMARK OR IF ALTERED OR ERASED

Federal and State law require that the seller states the vehicle mileage upon transfer of ownership. Failure to complete the odometer statement, or providing a false statement, may result in fines and/or imprisonment. The buyer has 15 business days to apply for a new vehicle title in order to avoid penalty charges, whether or not the vehicle is being used. This time period is subject to legislative change.

TRANSFER OF OWNERSHIP _____ Seller must complete this section and give title to the new owner _____

Buyer Name (printed)		Sale Date	
Street Address		City	State Zip
New Lienholder Driver License or EIN	New Lienholder Name and Street Address (if no lien, write NONE)		Lien Date
Odometer Reading (no tenths) <input type="checkbox"/> miles <input type="checkbox"/> kilometers		<input type="checkbox"/> Mileage in excess of the odometer mechanical limits <input type="checkbox"/> NOT Actual Mileage - WARNING - ODOMETER DISCREPANCY	
I certify to the best of my knowledge that the odometer reading is the actual mileage unless one of the boxes above is checked.			
Seller Name (printed)		Dealer Number	Seller Signature
Street Address		City	State Zip
Acknowledged before me this date		Notary Public or MVD Agent Signature	
Date	County	State	Commission Expires

I am aware of the above odometer certification made by the seller.
Buyer Name (printed) _____ Buyer Signature _____

DEALER REASSIGNMENT _____

Buyer Name (printed)		Sale Date	
Street Address		City	State Zip
New Lienholder Driver License or EIN	New Lienholder Name and Street Address (if no lien, write NONE)		Lien Date
Odometer Reading (no tenths) <input type="checkbox"/> miles <input type="checkbox"/> kilometers		<input type="checkbox"/> Mileage in excess of the odometer mechanical limits <input type="checkbox"/> NOT Actual Mileage - WARNING - ODOMETER DISCREPANCY	
I certify to the best of my knowledge that the odometer reading is the actual mileage unless one of the boxes above is checked.			
Dealership Name		Dealer Number	Agent Name
Street Address		City	State Zip
I am aware of the above odometer certification made by the seller.		Buyer Signature	

DEALER REASSIGNMENT _____

Buyer Name (printed)		Sale Date	
Street Address		City	State Zip
New Lienholder Driver License or EIN	New Lienholder Name and Street Address (if no lien, write NONE)		Lien Date
Odometer Reading (no tenths) <input type="checkbox"/> miles <input type="checkbox"/> kilometers		<input type="checkbox"/> Mileage in excess of the odometer mechanical limits <input type="checkbox"/> NOT Actual Mileage - WARNING - ODOMETER DISCREPANCY	
I certify to the best of my knowledge that the odometer reading is the actual mileage unless one of the boxes above is checked.			
Dealership Name		Dealer Number	Agent Name
Street Address		City	State Zip
I am aware of the above odometer certification made by the seller.		Buyer Signature	

DEALER REASSIGNMENT _____

Buyer Name (printed)		Sale Date	
Street Address		City	State Zip
New Lienholder Driver License or EIN	New Lienholder Name and Street Address (if no lien, write NONE)		Lien Date
Odometer Reading (no tenths) <input type="checkbox"/> miles <input type="checkbox"/> kilometers		<input type="checkbox"/> Mileage in excess of the odometer mechanical limits <input type="checkbox"/> NOT Actual Mileage - WARNING - ODOMETER DISCREPANCY	
I certify to the best of my knowledge that the odometer reading is the actual mileage unless one of the boxes above is checked.			
Dealership Name		Dealer Number	Agent Name
Street Address		City	State Zip
I am aware of the above odometer certification made by the seller.		Buyer Signature	

No Additional Reassignments Permitted _____ Last Buyer Must Apply For Title _____ Void If Altered _____

2022-011769 MISC Page: 1569 of 2782
09/26/2022 03:35:37 PM Receipt #: 22-9361
James Hill
Rec Fee: \$30.00 Darrell
Gila County, Az, Sadie Jo Bingham, Recorder



ARIZONA CERTIFICATE OF TITLE



Motor Vehicle Division

48-7200 R10/09 www.azdot.gov

Inventory Control
24309058

Vehicle Identification Number
1FTHX26H6FKB58041

Year
1985

Make
FORD

Model
X268

Body Style
PU

First Registered
01/1986

List Price
010250

Mobile Home Manufacturer

Unit Number

DARRELL JAMES HILL
3018 JOHNSON ST
LAKESIDE AZ 85929-5309

Title Number
K015013311011

Issue Date
11072013

Film Number
N311K01505

Odometer Miles (no tenths)
0015790 B

Previous Title Number State
100A013271022 AZ

Issue Date
09282013

Previous Film Number
N271100A09

A - Actual Mileage
B - Mileage in excess of the odometer mechanical limits
C - NOT Actual Mileage, WARNING ODOMETER DISCREPANCY

Arizona Brands

Previous Brand

State Previous Brand

State Previous Brand

State Other States With Brands

Owners/Lessees

DARRELL JAMES HILL

AND/OR

BEVERLY JEAN ROMERO-HILL

Lienholders

LIEN RELEASE

Lienholder Name	Acknowledged before me this date.	Notary Public Signature		
Lien Amount	Lienholder Signature	Date	County	State Commission

Page: 1570 of 2782

MISC

09/26/2022 03:35:37 PM
Rec Fee: \$30.00
Gila County, Az

Darrell James Hill
Sadie Jo Bingham, Recorder



VOID WITHOUT EAGLE WATERMARK OR IF ALTERED OR ERASED

Federal and State law require that the seller states the vehicle mileage upon transfer of ownership. Failure to complete the odometer statement, or providing a false statement, may result in fines and/or imprisonment. The buyer has 15 business days to apply for a new vehicle title in order to avoid penalty charges, whether or not the vehicle is being used. This time period is subject to legislative change.

TRANSFER OF OWNERSHIP _____ Seller must complete this section and give title to the new owner. _____

Buyer Name (printed)		Sale Date	
Street Address		City	State Zip
New Lienholder Driver License or EIN	New Lienholder Name and Street Address (if no lien, write NONE)		Lien Date

Odometer Reading (no tenths) miles kilometers Mileage in excess of the odometer mechanical limits. NOT Actual Mileage. WARNING -- ODOMETER DISCREPANCY.

I certify to the best of my knowledge that the odometer reading is the actual mileage unless one of the boxes above is checked.

Seller Name (printed)		Dealer Number	Seller Signature
Street Address		City	State Zip

Acknowledged before me this date: _____

Date	County	State	Commission Expires
------	--------	-------	--------------------

Notary Public or MVD Agent Signature

I am aware of the above odometer certification made by the seller.

Buyer Name (printed)	Buyer Signature
----------------------	-----------------

DEALER REASSIGNMENT _____

Buyer Name (printed)		Sale Date	
Street Address		City	State Zip
New Lienholder Driver License or EIN	New Lienholder Name and Street Address (if no lien, write NONE)		Lien Date

Odometer Reading (no tenths) miles kilometers Mileage in excess of the odometer mechanical limits. NOT Actual Mileage. WARNING -- ODOMETER DISCREPANCY.

I certify to the best of my knowledge that the odometer reading is the actual mileage unless one of the boxes above is checked.

Dealership Name		Dealer Number	Agent Name	Agent Signature
-----------------	--	---------------	------------	-----------------

I am aware of the above odometer certification made by the seller.

Buyer Name (printed)	Buyer Signature
----------------------	-----------------

DEALER REASSIGNMENT _____

Buyer Name (printed)		Sale Date	
Street Address		City	State Zip
New Lienholder Driver License or EIN	New Lienholder Name and Street Address (if no lien, write NONE)		Lien Date

Odometer Reading (no tenths) miles kilometers Mileage in excess of the odometer mechanical limits. NOT Actual Mileage. WARNING -- ODOMETER DISCREPANCY.

I certify to the best of my knowledge that the odometer reading is the actual mileage unless one of the boxes above is checked.

Dealership Name		Dealer Number	Agent Name	Agent Signature
-----------------	--	---------------	------------	-----------------

I am aware of the above odometer certification made by the seller.

Buyer Name (printed)	Buyer Signature
----------------------	-----------------

DEALER REASSIGNMENT _____

Buyer Name (printed)		Sale Date	
Street Address		City	State Zip
New Lienholder Driver License or EIN	New Lienholder Name and Street Address (if no lien, write NONE)		Lien Date

Odometer Reading (no tenths) miles kilometers Mileage in excess of the odometer mechanical limits. NOT Actual Mileage. WARNING -- ODOMETER DISCREPANCY.

I certify to the best of my knowledge that the odometer reading is the actual mileage unless one of the boxes above is checked.

Dealership Name		Dealer Number	Agent Name	Agent Signature
-----------------	--	---------------	------------	-----------------

I am aware of the above odometer certification made by the seller.

Buyer Name (printed)	Buyer Signature
----------------------	-----------------

No Additional Reassignments Permitted _____ Last Buyer Must Apply For Title _____ Void If Altered

2022-011769 MISC Page: 1571 of 2782
 09/26/2022 03:35:37 PM Receipt #: 22-9381
 James Hill Darrell Birmingham, Recorder
 Gila County, Az, Sadie Jo





Motor Vehicle Division

48-7200 R10/08 www.azdot.gov

Inventory Control
24309052

Vehicle Identification Number 1G8EK16L1GF207716	Year 1986	Make CHEV	Model KSU	Body Style 4DSW
First Registered 01/1987	List Price 012817	Mobile Home Manufacturer	Unit Number	

DARRELL JAMES HILL
3018 JOHNSON ST
LAKE SIDE AZ 85929-5309

Title Number K015013311008	Issue Date 11/07/2013	Film Number N311K01504	Odometer Miles (no tenths) 0019339 B
Previous Title Number 174M002339036 AZ	Issue Date 12/05/2002	Previous Film Number C339174M13	A - Actual Mileage B - Mileage In excess of the odometer mechanical limits C - NOT Actual Mileage, WARNING ODOMETER DISCREPANCY

Arizona Brands

Previous Brand	State	Previous Brand	State	Previous Brand	State	Other States With Brands
----------------	-------	----------------	-------	----------------	-------	--------------------------

Owners/Lessees
 DARRELL JAMES HILL
 BEVERLY JEAN ROMERO-HILL
 AND/OR

Lienholders

1567

2022-011769 MISC Page: 1572 of 2782
 09/26/2022 03:35:37 PM Receipt #: 22-9381
 Rec Fee: \$30.00 Darrell James Hill
 Gila County, AZ, Sadie Jo Bingham, Recorder

LIEN RELEASE

Lienholder Name	Acknowledged before me this date.	Notary Public Signature	
Lien Amount	Lienholder Signature	Date	County State Commission Expires

VOID WITHOUT EAGLE WATERMARK OR IF ALTERED OR ERASED

Federal and State law require that the seller states the vehicle mileage upon transfer of ownership. Failure to complete the odometer statement, or providing a false statement, may result in fines and/or imprisonment. The buyer has 15 business days to apply for a new vehicle title in order to avoid penalty charges, whether or not the vehicle is being used. This time period is subject to legislative change.

TRANSFER OF OWNERSHIP _____ Seller must complete this section and give title to the new owner _____

Buyer Name (printed)		Sale Date	
Street Address		City	State Zip
New Lienholder Driver License or EIN	New Lienholder Name and Street Address (if no lien, write NONE)		Lien Date
Odometer Reading (no tenths) <input type="checkbox"/> miles <input type="checkbox"/> kilometers		<input type="checkbox"/> Mileage in excess of the odometer mechanical limits. <input type="checkbox"/> NOT Actual Mileage. WARNING - ODOMETER DISCREPANCY.	
I certify to the best of my knowledge that the odometer reading is the actual mileage unless one of the boxes above is checked.			
Seller Name (printed)		Dealer Number	Seller Signature
Street Address		City	State Zip
Acknowledged before me this date		Notary Public or MVD Agent Signature	
Date	County	State	Commission Expires
I am aware of the above odometer certification made by the seller.			
Buyer Name (printed)		Buyer Signature	

DEALER REASSIGNMENT _____

Buyer Name (printed)		Sale Date	
Street Address		City	State Zip
New Lienholder Driver License or EIN	New Lienholder Name and Street Address (if no lien, write NONE)		Lien Date
Odometer Reading (no tenths) <input type="checkbox"/> miles <input type="checkbox"/> kilometers		<input type="checkbox"/> Mileage in excess of the odometer mechanical limits. <input type="checkbox"/> NOT Actual Mileage. WARNING - ODOMETER DISCREPANCY.	
I certify to the best of my knowledge that the odometer reading is the actual mileage unless one of the boxes above is checked.			
Dealership Name		Dealer Number	Agent Name
Street Address		City	State Zip
I am aware of the above odometer certification made by the seller.		Agent Signature	
Buyer Name (printed)		Buyer Signature	

DEALER REASSIGNMENT _____

Buyer Name (printed)		Sale Date	
Street Address		City	State Zip
New Lienholder Driver License or EIN	New Lienholder Name and Street Address (if no lien, write NONE)		Lien Date
Odometer Reading (no tenths) <input type="checkbox"/> miles <input type="checkbox"/> kilometers		<input type="checkbox"/> Mileage in excess of the odometer mechanical limits. <input type="checkbox"/> NOT Actual Mileage. WARNING - ODOMETER DISCREPANCY.	
I certify to the best of my knowledge that the odometer reading is the actual mileage unless one of the boxes above is checked.			
Dealership Name		Dealer Number	Agent Name
Street Address		City	State Zip
I am aware of the above odometer certification made by the seller.		Agent Signature	
Buyer Name (printed)		Buyer Signature	

DEALER REASSIGNMENT _____

Buyer Name (printed)		Sale Date	
Street Address		City	State Zip
New Lienholder Driver License or EIN	New Lienholder Name and Street Address (if no lien, write NONE)		Lien Date
Odometer Reading (no tenths) <input type="checkbox"/> miles <input type="checkbox"/> kilometers		<input type="checkbox"/> Mileage in excess of the odometer mechanical limits. <input type="checkbox"/> NOT Actual Mileage. WARNING - ODOMETER DISCREPANCY.	
I certify to the best of my knowledge that the odometer reading is the actual mileage unless one of the boxes above is checked.			
Dealership Name		Dealer Number	Agent Name
Street Address		City	State Zip
I am aware of the above odometer certification made by the seller.		Agent Signature	
Buyer Name (printed)		Buyer Signature	

No Additional Reassignments Permitted _____ Last Buyer Must Apply For Title _____ Void If Altered

2022-011769 MISC Page: 1573 of 2782
 09/26/2022 03:35:37 PM Receipt #: 22-9981
 Rec Fee: \$30.00 Darrell James Hill
 Gila County, AZ, Sadie Jo Bingham, Recorder





Motor Vehicle Division

48-7200 R-10/08 www.azdot.gov

Vehicle Identification Number
1GBKP37W3H3313848

Year
1987

Make
ALLEG

Model
P30

Inventory Control

17660562

Body Style
MHA

First Registered
05/1987

List Price
048500

Mobile Home Manufacturer

Unit Number

**BEVERLY JEAN ROMERO-HILL
15024 W CHARTER OAK RD
SURPRISE AZ 85379-5922**

Title Number
17AK011018008

Issue Date
01182011

Film Number
L01817AK03

Odometer Miles (no tenths)
0081500 A

Previous Title Number
448M011011020 AZ

Issue Date
01112011

Previous Film Number
L011448M09

A: Actual Mileage
B: Mileage in excess of the odometer mechanical limits
C: NOT Actual Mileage, WARNING ODOMETER DISCREPANCY

Arizona Brands

Previous Brand

State Previous Brand

State Previous Brand

State Other States With Brands

Owners/Lessees

BEVERLY JEAN ROMERO-HILL

AND/OR

DARRELL JAMES HILL

Lienholders

LIEN RELEASE

Lienholder Name

Acknowledged before me this date

Notary Public Signature

Lien Amount

Lienholder Signature

Date

County

State

Commission Expires

2022-0111769 MISC Page: 1574 of 2782

09/26/2022 03:35:37 PM Receipt #: 22-9381

Rec Fee: \$30.00 Darrell James Hill

Gila County, Az, Sadie Jo Bingham, Recorder



VOID WITHOUT EAGLE WATERMARK OR IF ALTERED OR ERASED

Federal and State law require that the seller states the vehicle mileage upon transfer of ownership. Failure to complete the odometer statement, or providing a false statement, may result in fines and/or imprisonment. The buyer has 15 business days to apply for a new vehicle title in order to avoid penalty charges, whether or not the vehicle is being used. This time period is subject to legislative change.

Seller must complete this section and give title to the new owner.

TRANSFER OF OWNERSHIP

Buyer Name (printed) _____ Sale Date _____
 Street Address _____ City _____ State _____ Zip _____
 New Lienholder Driver License or EIN _____ New Lienholder Name and Street Address (if no lien, write NONE) _____ Lien Date _____

Odometer Reading (no tenths) miles kilometers Mileage in excess of the odometer mechanical limits
 NOT Actual Mileage. WARNING - ODOMETER DISCREPANCY

I certify to the best of my knowledge that the odometer reading is the actual mileage unless one of the boxes above is checked.

Seller Name (printed) _____ Dealer Number _____ Seller Signature _____
 Street Address _____ City _____ State _____ Zip _____
 Notary Public or MVD Agent Signature _____
 Acknowledged before me this date _____ State _____ Commission Expires _____
 Date _____ County _____

I am aware of the above odometer certification made by the seller.
 Buyer Name (printed) _____ Buyer Signature _____

DEALER REASSIGNMENT

Buyer Name (printed) _____ Sale Date _____
 Street Address _____ City _____ State _____ Zip _____
 New Lienholder Driver License or EIN _____ New Lienholder Name and Street Address (if no lien, write NONE) _____ Lien Date _____

Odometer Reading (no tenths) miles kilometers Mileage in excess of the odometer mechanical limits
 NOT Actual Mileage. WARNING - ODOMETER DISCREPANCY

I certify to the best of my knowledge that the odometer reading is the actual mileage unless one of the boxes above is checked.

Dealership Name _____ Dealer Number _____ Agent Name _____ Agent Signature _____
 I am aware of the above odometer certification made by the seller.
 Buyer Name (printed) _____ Buyer Signature _____

DEALER REASSIGNMENT

Buyer Name (printed) _____ Sale Date _____
 Street Address _____ City _____ State _____ Zip _____
 New Lienholder Driver License or EIN _____ New Lienholder Name and Street Address (if no lien, write NONE) _____ Lien Date _____

Odometer Reading (no tenths) miles kilometers Mileage in excess of the odometer mechanical limits
 NOT Actual Mileage. WARNING - ODOMETER DISCREPANCY

I certify to the best of my knowledge that the odometer reading is the actual mileage unless one of the boxes above is checked.

Dealership Name _____ Dealer Number _____ Agent Name _____ Agent Signature _____
 I am aware of the above odometer certification made by the seller.
 Buyer Name (printed) _____ Buyer Signature _____

DEALER REASSIGNMENT

Buyer Name (printed) _____ Sale Date _____
 Street Address _____ City _____ State _____ Zip _____
 New Lienholder Driver License or EIN _____ New Lienholder Name and Street Address (if no lien, write NONE) _____ Lien Date _____

Odometer Reading (no tenths) miles kilometers Mileage in excess of the odometer mechanical limits
 NOT Actual Mileage. WARNING - ODOMETER DISCREPANCY

I certify to the best of my knowledge that the odometer reading is the actual mileage unless one of the boxes above is checked.

Dealership Name _____ Dealer Number _____ Agent Name _____ Agent Signature _____
 I am aware of the above odometer certification made by the seller.
 Buyer Name (printed) _____ Buyer Signature _____

No Additional Reassignments Permitted ————— Last Buyer Must Apply For Title ————— Void If

2022-011769 MISC Page: 1575 of 2782
 09/26/2022 03:35:37 PM Receipt #: 22-9361
 Reg Fee: \$30.00 Darrell James Hill
 CLIA County, AZ, Sadie Jo Bingham, Recorder



APACHE JUNCTION
151 W SUPERSTITION BLVD
APACHE JUNCTION, AZ 85120-9998
030259-0130
(800)275-8777
06/23/2020 03:07 PM

Registered No: RE047610526US

Date Stamp



Product	Qty	Unit Price	Price
First-Class Mail® Letter	1	\$0.70	\$0.70
(Domestic) (PHOENIX, AZ 85007) (Weight: 0 Lb 2.00 Oz) (Estimated Delivery Date) (Friday 06/26/2020)			
Registered			\$13.20
(Amount: \$21.00) (USPS Registered Mail #) (RE047610526US)			
Return Receipt			\$2.85
(USPS Return Receipt #) (9590940247188344961900)			
First-Class Mail® Letter	1	\$0.70	\$0.70
(Domestic) (PHOENIX, AZ 85007) (Weight: 0 Lb 1.70 Oz) (Estimated Delivery Date) (Friday 06/26/2020)			
Non Mach. Surch.			\$0.15
Certified			\$3.55
(USPS Certified Mail #) (70091410000078685795)			
Return Receipt			\$2.85
(USPS Return Receipt #) (9590940247188344961917)			
Total:			\$24.00
Cash Change		\$25.00 (\$1.00)	

Reg. Fee	\$0.70	
Handling Charge	\$13.20	Return Receipt
Postage	\$0.00	Restricted Delivery
Received by	TK 00	\$13.90
Customer Must Declare Full Value	\$21.00	06/23/2020

OFFICIAL USE

FROM: APACHE JUNCTION, AZ 85120
Darrell - James Hill, AR
PO Box 3806
Apache Junction, Arizona
85117

TO: Kate Hobbs - Tevstee
1700 W Washington St., Floor 7
Phoenix, Arizona 85007

PS Form 3806, Receipt for Registered Mail Copy 1 - Customer
May 2007 (7530-02-000-9051)
For domestic delivery information, visit our website at www.usps.com®

U.S. Postal Service™
CERTIFIED MAIL™ RECEIPT
(Domestic Mail Only; No Insurance Coverage Provided)
For delivery information visit our website at www.usps.com®
PHOENIX AZ 85007

Postage	\$3.55	0130
Certified Fee	\$2.85	06
Return Receipt Fee	\$0.00	
Restricted Delivery Fee	\$0.00	
Total Postage & Fees	\$0.70	
	\$7.25	

Sent to: Scott Omer
Street, Apt. No. or PO Box No.: 206 S 17th Ave, Mail 100A
City, State, ZIP+4: Phoenix, Arizona 85007

COMPLETE THIS SECTION ON DELIVERY

A. Signature: *[Signature]* Agent Addressed

B. Received by (Printed Name): Thomas B. Stickney C. Date of Delivery: JUN 24 2020

D. Is delivery address different from item? Yes No

3. Service Type: Priority Mail Express, Registered Mail, Registered Mail Restricted Delivery, Certified Mail®, Certified Mail Restricted Delivery, Collect on Delivery Registered Delivery, Signature Confirmation™, Insured Mail Restricted Delivery (over \$500)

SENDER: COMPLETE THIS SECTION

1. Article Addressed to: Kate Hobbs - Tevstee, 1700 W Washington St., Floor 7, Phoenix, Arizona 85007

2. Article Number (transfer from service label): 9590 9402 4718 8344 9619 00

RE 047 610 526 US

ALERT: DUE TO LIMITED TRANSPORTATION AVAILABILITY AS A RESULT OF NATIONWIDE COVID-19 IMPACTS, PACKAG...

USPS Tracking®

[FAQs >](#)

Track Another Package +

Track Packages
Anytime, Anywhere

Get the free Informed Delivery® feature to receive automated notifications on your packages

[Learn More](#)

(<https://reg.usps.com>)

[/xsell?app=UspsTools&ref=homepage&Banner&appURL=https%3A%2F%2Finformeddelivery.usps.com/box/pages/intro/startAction](#)

Tracking Number: RE047610526US

Remove X

Your item was picked up at a postal facility at 8:07 am on June 24, 2020 in PHOENIX, AZ 85009.

✓ Delivered

June 24, 2020 at 8:07 am
Delivered, Individual Picked Up at Postal Facility
PHOENIX, AZ 85009

[Get Updates](#) ▾

Text & Email Updates ▾

Tracking History ▲

June 24, 2020, 8:07 am
Delivered, Individual Picked Up at Postal Facility
PHOENIX, AZ 85009

Your item was picked up at a postal facility at 8:07 am on June 24, 2020 in PHOENIX, AZ 85009.

June 24, 2020, 5:13 am
Available for Pickup
PHOENIX, AZ 85009

June 24, 2020, 5:12 am
Available for Pickup
PHOENIX, AZ 85009

June 24, 2020, 5:09 am
Arrived at Unit
PHOENIX, AZ 85009

2022-011769 MISC Page: 1577 of 2782

09/26/2022 03:35:37 PM Receipt #: 22-9381

Rec Fee: \$30.00 Darrell James Hill

Gila County, Az, Sadie Jo Bingham, Recorder



6/26/20, 5:35 PM

:Darrell-James: Hill, -:civilian, -:Executor
c/o PO Box 3806, Apache Junction, Arizona 85117.
:man -:present,

:The United States of America

Arizona state
Pinal county

To: Doug :Arizona state Governor -:Ducey, -Trustee'
:Katie :Secretary of State -:Hobbs
c/o: Katie: Hobbs, -:Trustee – USPS RMN RE 047 610 526 US
1700 West Washington Street, Floor 7
Phoenix, Arizona 85007

:John :Director- Dept. of Transportation -:Halikowski, -:Trustee
:Tim :Director- Enforcement and Compliance Division -: Lane, -:Trustee
:Scott :COO- Dept. of Transportation -:Omer
c/o: Scott: Omer, -:Trustee – USPS CMN 7009 1410-0000 7868 5796
206 South 17th Avenue, Mail Drop 100A
Phoenix, Arizona 85007

Re: :Specialized Negotiable Instrument- Presentment: USPS-RMN- 'RE 047 610 526
US' With The 1) Authorization For The Termination Of The Compelled Benefit Of
The 'Arizona Driver License' Upon The Notice Of The Same to :i-man; And, 2)
With The Return Of The Four -Property- Bonds: 'Arizona Certificates Of Title'
From :Arizona-/ Motor -Vehicle -Division For The Ending Of The :Bond
-Relationship (s Now Exercised By The Bond- Holder -:Darrell-James: Hill,
 -:Executor, :husband, With The Wife: -Bond -Holder, -:Beverly-Jean: Romero-
Hill, -:Executor, Affirming:

1) :Title-Number – K015013311014; :Issue-Date – 11072013, :File-Number – N311K01506; – Property- (Vehicle) Identification – :Number: 22D42408S6936; appended, bond: one.

2) :Title-Number – K015013311011, :Issue-Date – 11072013, :Film- Number – N311K01505; + Property- (Vehicle) Identification – :Number: 1FTHX26H6FKB58041; appended, the bond: one.

3) :Title-Number – K015013311008, :Issue-Date – 11072013, :Film-Number – N311K01504; – Property- (Vehicle) Identification – :Number: 1G8EK16L1GF207716; appended, the bond: one.

4) :Title-Number – 17AK011018008, :Issue-Date – 01182011, :Film-Number – L01817AK03; – Property- (Vehicle) Identification – :Number: 1GBKP37W3H3313848; appended, the bond: one.

:Claim - :Right to Conveyance for Property-held-without-right in: Dry-Trust: EBA-1933 A.D - 2003 A.D.
USPS RMN RE 047 610 526 US JUNE 22, 2020 1 / 6

2022-011769 MISC Page: 1578 of 2782

09/25/2022 03:35:37 PM Receipt #: 22-9981
Rec Fee: \$30.00 Darrell James Hill
Gila County, Az Sadie Jo Bingham, Recorder



Greetings :Doug, :Katie, :John, :Tim, :Scott:

Affiant – :standing, political election and status. :i- man², :beneficiary³ -by-:birth⁴ of the inherent -trust⁵ from :Almighty God⁶~ where nothing stands between :Almighty-God and :i- man ~ am (1) :Executor- Darrell-James: Hill © 1958 A.D., :Ohioan^{7 8}, in the fullness of age, and of :sound- mind; (2) by :birth :Negro⁹ -:beneficiary of the :Emancipation- Proclamation -1863¹⁰ and forever-guaranteed -:protection by the Army, et al., by the full- force and authority of The Constitution for the United States of America ~ 1789-1791~¹¹; and: (3) :beneficiary of the ':UNITED-STATES-corporation' -:government¹² -services-provider-Trustee's :self-indenture¹³ to :i-man: by the 'Emergency Banking Act of 1933, et al.¹⁴, 'EBA-1933-A.D.'~ ended 2003 A.D.~ with the debenture^{15 16} created in the 'idem-sonans¹⁷ -:subrogation¹⁸ entitled: DARRELL JAMES HILL~ & et al. derivatives~ © 1958 A.D., :STATE-OF-OHIO¹⁹ - pending settle and closure- :May- 2020 A.D.

Return Of :Property- Bonds For The End Of :All -Compelled- Contracts

- 1) :i- man believe that it is in my best interest at this time to no longer register property under the 'State of Arizona -Certificate of Title' for the property referenced;
- 2) :i- man believe that the righteous-choice for the a) non-renewal of the registration ~ done, and b) :this -demand for the receipt of the 'title' to this property is the exercise of the inherent- property-right by :i- man;
- 3) :i- man believe that this election is merely the rightful- exercise of the option for the title-of- the-property-held to be severed from the compelled- 'State of Arizona' -granted -rights and privileges and related -adhesion-contracts thereto;
- 4) :i- man believe that it is in my best interest at this time to return the :State-of-Arizona- certificate-of-titles' for to receive from the State of Arizona system :all of the titles in the absolute -ownership to none other but to :i- man;
- 5) :i-man believe that the exercise of this chose is in the sole -discretion of the none- other than :i- man;
- 6) :i- man believe that the State of Arizona has no discretion in this matter; and,
- 7) :i-man deny-now your any importune for your discretion, thank-you but no;
- 8) :i- man am not a U.S. Citizen; please correct any error on this matter in the any record. Finally,
- 9) :i- man believe that the "Arizona Driver License" is not required for :i-man to travel in the Arizona state. Thereto, :i- man now authorize for :you to terminate the compelled -benefit of the Arizona Driver License for :i- man with due notice and replacement with the benefit -functional -equivalent that is ambassadorial and/or otherwise without the :compelled -adhesion-contracts.

:Compensation For The Trespass Upon This Right

:Where as by the effort by the State of Arizona, et al., to administer this :property without the right is willful wrong-doing not- authorized to the 'State of Arizona, et al.- you', by :i- man: Darrell-James: Hill and/ or Beverly-Jean: Romero- Hill is trespassing upon the right, and subject, by the tacit acquiescence, to the compensation established in the record at the rate of :one- ounce of :silver, U.S. mint, in -specie per minute beginning from the time of this special-negotiable-instrument-sending unto the end of the matter with the payment of the compensation due upon the any request for the :any-debt-amount -accumulated with the default to the billing thereof after the period of the thirty serial calendar days following the

:Claim - :Right to Conveyance for Property-held-without-right in: Dry-Trust: EBA-1933 A.D - 2003 A.D.
USPS RMN RE 047 610 526 US JUNE 22, 2020 2 / 6

2022-011769 MISC Page: 1579 of 2782

09/26/2022 03:35:37 PM Receipt #: 22-9381
Rec Fee: \$30.00 Darrell James Hill
Gila County, AZ Sadie Jo Bingham, Recorder



receipt of the bill of the particulars.

cc:
:Mark -Sheriff Pinal county, Arizona -:Lamb
971 N Jason Lopez Circle, Building C
PO Box 867
Florence, Arizona state 85132

enclosures:

- 1) Property- (Vehicle) Identification – :Number: 22D42408S6936; appended, the bond, 1 sheet.
- 2) :Property- (Vehicle) Identification – :Number: 1FTHX26H6FKB58041; appended, the bond, one sheet.
- 3) :Property- (Vehicle) Identification – :Number: 1G8EK16L1GF207716; appended, the bond, one sheet.
- 4) :Property- (Vehicle) Identification – :Number: 1GBKP37W3H3313848; appended, the bond, one sheet.

Notice to the primary Trustee is :notice to every minister;
Notice to the any minister must be made notice to the primary Trustee.

:i- man affirm all said above is true and correct, and will state same in the open court.

Without prejudice

Darrell James Hill, A.R.
:Darrell-James: Hill, civilian- :Executor;

Without prejudice

Beverly-Jean Romero-Hill, A.R.
:Beverly-Jean: Romero, Hill, civilian- :Executor.

Jurat

Affirmed and autographed before me this day 22 June, the year of our Lord 2020 A.D.
Type of Identification: Arizona Driver License.

[Signature]
Notary Public

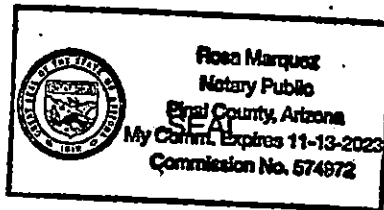

:Claim - :Right to Conveyance for Property-held-without-right in: Dry-Trust: EBA-1933 A.D - 2003 A.D.
USPS RMN RE 047 610 526 US JUNE 22, 2020 3 / 6

2022-011769 MISC Page: 1580 of 2782
09/26/2022 03:35:37 PM Receipt #: 22-9381
Rec Fee: \$30.00 Darrell James Hill
Gila County, Az, Sadie Jo Bingham, Recorder



- 1 :Trustee means: 1) one to whom an estate has been conveyed in trust; trust means: TRUST, contracts, devises. An equitable right, title or interest in property, real or personal, distinct from its legal ownership; or it is a personal obligation for paying, delivering or performing anything, where the person trusting has no real right or security, for by, that act he confides altogether to the faithfulness of those intrusted. This is its most general meaning, and includes deposits, bailments, and the like. In its more technical sense, it may be defined to be an obligation upon a person, arising out of a confidence reposed in him, to apply property faithfully, and according to such confidence. Willis on Trustees, 1; 4 Kent, Com. 295; 2 Fonb. Eq. 1; 1 Saund. Uses and Tr. 6; Coop. Eq. Pl. Introd. 27; 3 Bl. Com. 431. 2) for the Emergency Banking Act of 1933, et al., et seq., 'EBA-1933-A.D.'
- 2 :i-man means: 'i' refers to :Almighty-God as the great 'i- am'. And: 'i- man/' :i-man' acknowledges that the Almighty-God -created the 'man' is present.
- 3 :beneficiary means: one onto whom a :trust-benefit is disposed by the :Executor of the beneficiary's property.
- 4 :birthed :son of :Clarence, :son of :James, :son 'Negroland, :Kingdom-of-Judah, :Africa', ...:son :Ysrael- :Southern-Kingdom ~ of the sons :Judah and Benjamin and and Levi, et al.~, ...:son of :Jacob and :Ysrael, :son of :Isaac, :son of :Abram and :Abraham, ...:son of :Shem, :son of :Noah, ...:son of :Methuselah, :son of :Enoch, ...:son of :Seth, :son of :Adam with :Eve of the garden-of :Eden.
- 5 inherent -trust means: that trust given by the Creator- :Almighty-God to :i-man-kind; e.g., :gravity, water, :man- value.
- 6 :Almighty God means: the only begotten son of the Most High God, :Creator of the worlds, Yushuah the Messiah~a.k.a. Jesus the Christ~, He who for our sake for our redemption did lay down His glory, birthed as man-kind onto our earth-planet, fulfilled all of the word, Law and prophesy, then layed-down his life, giving his life for to atone for our sins so that :man-kind -whosoever-will may become like Him, in the fullness of that stature, sons of the Most-High-God.
- 7 Record of live Birth means: Authentication ~:Birth No 134 - 58 -208851, Certified Doc.# F4012640, :State Registrar - Judith-B.: Nagy, May -9, 2018.; and: (2) OHIO- SOS -certification: C074912, :Jon: Husted. June 14, 2018; and: (3) The United States of America- SOS- Authentication No. 18047749-2, :Michael -R: Pompeo, July 17, 2018 ~ :Debenture; appended: 3 pages.
- 8 :Darrell-James: Hill means: :Darrell-James: Hill means: Darrell-James: Hill ©1958: Ohioan, © 1958: State of Ohio: beneficiary. See: Gila county Arizona: Doc. # 2017-002378: pp. 6-24, 89-91,93-95 of 693. Gila county Arizona: Doc. # 2018-005176: pp. 10-21; and, et seq. See: :i- man -file of: Specialized Negotiable Instruments to the :man - :Barak-Hussein: Obama, :Donald-John: Trump, et al., et seq.
- 9 Ibid 4.
- 10 Emancipation Proclamation of 1863 means: Proclamation 95 from POTUSA Abraham Lincoln on September 22nd, 1862: effective :January 1st, 1863. EMANCIPATION. An act by which a person, who was once in the power of another, is rendered free. as is the 'Declaration of Independence of 1776 A.D.' upon all man-kind, on the people upon the land.
- 11 The Constitution for the United States of America ~ 1789-1791~ means: The :original - organic -constitution and includes the 'Bill of Rights', et al.
- 12 ':United-States-corporation' -government means: ':UNITED-STATES-corporation' -government -services -provider -Trustee: 1863 A.D., e.g., (1) cf.1929: Herbert-Clark: POTUS Hoover with: (2) cf.1934: Franklin-Delano: POTUS Roosevelt- Trustee/ :EBA-1933-A.D; with (3) cf.2020: Donald-John: POTUS Trump- Trustee/ EBA-1933-A.D, CIC under U.S. Constitution - incorporated, and (4) cf. :Donald-John: POTUSA Trump, CIC under The Constitution for the United States of America - unincorporated.
- 13 :indenture means: INDENTURE, conveyancing. An instrument of writing containing a conveyance of contract between two or more persons, e.g., as between the ':UNITED-STATES-CORPORATION' and 'The United States of America, unincorporated, i.e., the people of the non-political- aggregate.
- 14 :Emergency Banking Act of 1933, et al. means: Public Law 73-1/ Statutes at Large 48 Stat. 1, et al. Trading With The Enemy Act, amended ~Subdivision (b) of section 5 of the Act of October 6, 1917 ... as follows: During time of war or during any other period of national emergency declared by the President... President may require any person within the United States... engaged in any transaction...be fined... imprisoned... or both... Of Trading with the Enemy Act of 1917, Pub.L. 65-91, 40 Stat. 411.
- 15 :debenture means: DEBENTURE. A certificate given, in pursuance of law, by the collector of a port of entry for a certain sum, due by the United States, payable at a time therein mentioned, to an importer for the duties on merchandise imported and exported by him, provided the duties arising on the importation of the said merchandise shall have been discharged prior to the time aforesaid. Vide Act of Congress of March 2, 1799, s. 80; Encyclopedie, h. t.; Dane's Ab. Index, h. t.
- 16 Birth-day means: the 20th day, November, year of our Lord 1958 A.D. at 11:35 a.m. Ibid 11. Birth. The act of being wholly brought into the world. The whole body must be detached from that of the

1574



mother, in order to make the birth complete. 5 C. & P. 329; S. C. 24 E. C. L. R. 344 6 C. & P. 349; S. C. 25 E. C. L. R. 433.

day. A division of time. It is natural, and then it consists of twenty-four hours, or the space of time which elapses while the earth makes a complete revolution on its axis; or artificial, which contains the time, from the rising until the setting of the sun, and a short time before rising and after setting. Vide Night; and Co. Lit. 135, a.

2. Days are sometimes calculated exclusively, as when an act required that an appeal should be made within twenty days after a decision. 3 Penna. 200; 3 B. & A. 581; 15 Serg. & Rawle, 43. In general, if a thing is to be done within such a time after such a fact, the day of the fact shall be taken inclusively. Hob. 139; Doug. 463; 3 T. R. 623; Com. Dig. Temps, A; 3 East, 407.

3. The law, generally, rejects fractions of days, but in some cases it takes notice of such parts. 2 B. & A. 586. Vide Date.

17 **Idem-sonans means: IDEM SONANS.** Sounding the same.

2. In pleadings, when a name which it is material to state, is wrongly spelled, yet if it be idem sonans with that proved, it is sufficient, as Segrave for Segrave, 2 Str. R. 889; Keen for Keene, Thach. Cr. Cas. 67; Deadema for Diadema, 2 Ired. 346; Hutson for Hudson, 7 Miss. R. 142; Coonrad for Conrad, 8 Miss. R. 291. See 5 Pike, 72; 6 Ala. R. 679; vide also Russ. & Ry. 412; 2 Taunt. R. 401. In the following cases the variances there mentioned were declared to be fatal. Russ. & Ry. 351; 10 East, R. 83; 5 Taunt. R. 14; 1 Baldw. R. 83; 2 Crom. & M. 189; 6 Price, R. 2; 1 Chit. R. 659; 13 E. C. L. R. 194. See, generally, 8 Chit. Pr. 231, 2; 4 T. R. 611; 3 B. & P. 559; 1 Stark. R. 47; 2 Stark. R. 29; 3 Camp. R. 29; 6 M. & S. 45; 2 N. H. Rep. 557; 7 S. & R. 479; 3 Caines, 219; 1 Wash. C. C. R. 285; 4 Cowen, 148 and the article Name.

18 **Subrogation means: SUBROGATION,** civil law, contracts. The act of putting by a transfer, a person in the place of another, or a thing in the place of another thing. It is the substitution (q. v.) of a new for an old creditor, and the succession to his rights, which is called subrogation; transfusio unius creditoris in alium. It is precisely the reverse of delegation. (q. v.)

2. There are three kinds of subrogation: 1. That made by the owner of a thing of his own free will; example, when he voluntarily assigns it. 2. That which arises in consequence of the law, even without the consent of the owner; example, when a man pays a debt which could not be properly called his own, but which nevertheless it was his interest to pay, or which he might have been compelled to pay for another, the law subrogates him to all the rights of the creditor. Vide 2 Binn. Rep. 382; White's L. C. in Eq.* 60-72. 3. That which arises by the act of law joined to the act of the debtor; as, when the debtor borrows money expressly to pay off his debt, and with the intention of substituting the lender in the place of the old creditor. 7 Toull. liv. 3, t. 3, c. 5, sect. 1, §2. Vide Civ. Code of Louisiana, art. 2155 to 2158; Merl. Repert. h. t.; Dig. lib. 20; Code, lib. 8, t. 18 et 19 9 Watts. R. 451; 6 Watts & Serg. 190; 2 Bouv. Inst. n. 1413.

19 **berth-date means: the 28th day, November, year of our Lord 1958 A.D., in the 244th year of the United States: Ibid 11.**

Berth: (v.) 1660s, of ships, from berth (n.). Of persons (intransitive), from 1886. Related: Berthed; berthing. **berth (n.)** 1620s, "convenient sea room" (both for ships and sailors), of uncertain origin, probably from bear (v.) + abstract noun suffix -th (2) as in strength, health, etc. Original sense is preserved in phrase to give (something or someone) wide berth. Meaning "place on a ship to stow chests, room for sailors" is from 1706; extended to non-nautical situations by 1778.

Date. The designation or indication in an instrument of writing, of the time, and usually of the time and place, when and where it was made. When the place is mentioned in the date of a deed, the law intends, unless the contrary appears, that it was executed at the place of the date. Plowd. 7 b., 31 H. VI. This word is derived from the Latin datum, because when deeds and agreements were written in that language, immediately before the day, month and year in which they were made, was set down, it was usual to put the word datum, given.

2. All writings ought to bear a date, and in some it is indispensable in order to make them valid, as in policies of insurance; but the date in these instruments is not inserted in the body of the writing because as each subscription makes a separate contract, each underwriter sets down the day, month and year he makes his subscription. Marsh. Ins. 336.

3. Deeds, and other writings, when the date is an impossible one, take effect from the time of deliver; the presumption of law is, that the deed was dated on the day it bears date, unless, as just mentioned, the time is impossible; for example, the 32d day of January.

4. The proper way of dating, is to put the day, month, and year of our Lord; the hour need not be mentioned, unless specially required; an instance of which may be taken from the Pennsylvania Act of the 16th June, 1763, sect. 40, which requires the sheriff, on receiving a writ of fieri facias, or other writ of execution, to endorse thereon the day of the month, the year, and the hour of the day whereon he received the same.

5. In public documents, it is usual to give not only the day, the month, and the year of our Lord, but also the



year of the United States, when issued by authority of the general government; or of the commonwealth, when issued under its authority. Vide, generally, Bac. Ab. Obligations, C; Com. Dig, Fait, B 3; Cruise, Dig. tit, 32, c. 20, s. 1-6; 1 Burr. 60; 2 Rol. Ab. 27, 1. 22; 13 Vin. Ab. 34; Dane's Ab. Index, h. t. See Almanac.

176

2022-011769 MISC Page: 1583 of 2782

09/26/2022 09:35:37 PM Receipt #: 22-9381

Rec Fee: \$30.00 Darrell James Hill

Gila County, Az, Sadie Jo Bingham, Recorder



ARIZONA CERTIFICATE OF TITLE



Vehicle Identification Number
22D42408S6936

Year
1979

Make
PROWL

Model
TV

Inventory Control
24309059

First Registered
05/1978

List Price
006021

Mobile Home Manufacturer

DARRELL JAMES HILL
3018 JOHNSON ST
LAKESIDE AZ 85929-5309

Title Number
K015013311014

Issue Date
11072013

Film Number
N311K01506

Odometer Miles (no tenths)
000000

Previous Title Number State
AV23010111004 AZ

Issue Date Previous Film Number
04212010 K111AV2302

A - Actual Mileage
B - Mileage in excess of the odometer mechanical limits
C - NOT Actual Mileage, WARNING ODOMETER DISCREPANCY

Arizona Brands

Previous Brand State Previous Brand

State Previous Brand

State Other States With Brands

Owners/Lessees

DARRELL JAMES HILL

AND/OR

BEVERLY JEAN ROMERO-HILL

Lienholders

2022-011769 MISC Page: 1584 of 2782
09/26/2022 03:35:37 PM Receipt #: 22-9381
Rec Fee: \$30.00 Darrell James Hill
Gila County, Az, Sadie Jo Bingham, Recorder



LIEN RELEASE

Lienholder Name		Acknowledged before me this date.		Notary Public Signature	
Lien Amount	Lienholder Signature	Date	County	State	Commission Expires

VOID WITHOUT EAGLE WATERMARK OR IF ALTERED OR ERASED

Federal and State law require that the seller states the vehicle mileage upon transfer of ownership. Failure to complete the odometer statement, or providing a false statement, may result in fines and/or imprisonment. The buyer has 15 business days to apply for a new vehicle title in order to avoid penalty charges, whether or not the vehicle is being used. This time period is subject to legislative change.

TRANSFER OF OWNERSHIP Seller must complete this section and give title to the new owner.

Buyer Name (printed)		City		State		Zip		Sale Date	
Street Address		City		State		Zip		Lic. Date	
New Dealer Name and Street Address (if no license, write NONE)		City		State		Zip		Lic. Date	
<input type="checkbox"/> None <input type="checkbox"/> Miles <input type="checkbox"/> Kilometers		<input type="checkbox"/> Mileage in excess of the odometer mechanical limits. <input type="checkbox"/> NOT Actual Mileage. WARNING - ODOMETER DISCREPANCY.							
I certify to the best of my knowledge that the odometer reading is the actual mileage unless one of the boxes above is checked.									
Seller Name (printed)		Dealer Number		Seller Signature					
Street Address		City		State		Zip		Lic. Date	
ACKNOWLEDGED BEARS ME THIS DATE				Notary Public or MVD Agent Signature					
Date		County		State		Commission Expires			
I am aware of the above odometer certification made by the seller.									
Buyer Name (printed)				Buyer Signature					

DEALER REASSIGNMENT

Buyer Name (printed)		City		State		Zip		Sale Date	
Street Address		City		State		Zip		Lic. Date	
New Dealer Name and Street Address (if no license, write NONE)		City		State		Zip		Lic. Date	
<input type="checkbox"/> None <input type="checkbox"/> Miles <input type="checkbox"/> Kilometers		<input type="checkbox"/> Mileage in excess of the odometer mechanical limits. <input type="checkbox"/> NOT Actual Mileage. WARNING - ODOMETER DISCREPANCY.							
I certify to the best of my knowledge that the odometer reading is the actual mileage unless one of the boxes above is checked.									
Dealership Name		Dealer Number		Agent Name		Agent Signature			
I am aware of the above odometer certification made by the seller.									
Buyer Name (printed)				Buyer Signature					

DEALER REASSIGNMENT

Buyer Name (printed)		City		State		Zip		Sale Date	
Street Address		City		State		Zip		Lic. Date	
New Dealer Name and Street Address (if no license, write NONE)		City		State		Zip		Lic. Date	
<input type="checkbox"/> None <input type="checkbox"/> Miles <input type="checkbox"/> Kilometers		<input type="checkbox"/> Mileage in excess of the odometer mechanical limits. <input type="checkbox"/> NOT Actual Mileage. WARNING - ODOMETER DISCREPANCY.							
I certify to the best of my knowledge that the odometer reading is the actual mileage unless one of the boxes above is checked.									
Dealership Name		Dealer Number		Agent Name		Agent Signature			
I am aware of the above odometer certification made by the seller.									
Buyer Name (printed)				Buyer Signature					

DEALER REASSIGNMENT

Buyer Name (printed)		City		State		Zip		Sale Date	
Street Address		City		State		Zip		Lic. Date	
New Dealer Name and Street Address (if no license, write NONE)		City		State		Zip		Lic. Date	
<input type="checkbox"/> None <input type="checkbox"/> Miles <input type="checkbox"/> Kilometers		<input type="checkbox"/> Mileage in excess of the odometer mechanical limits. <input type="checkbox"/> NOT Actual Mileage. WARNING - ODOMETER DISCREPANCY.							
I certify to the best of my knowledge that the odometer reading is the actual mileage unless one of the boxes above is checked.									
Dealership Name		Dealer Number		Agent Name		Agent Signature			
I am aware of the above odometer certification made by the seller.									
Buyer Name (printed)				Buyer Signature					

No Additional Reassignments Permitted Last Buyer Must

2022-011769 MISC Page: 1585 of 2782
 09/26/2022 03:35:37 PM Receipt #: 22-9381
 Rec Fee: \$30.00 Darrell James Hill
 Gila County, Az, Sadie Jo Bingham, Recorder



Motor Vehicle Division

Inventory Control
24309058

48-7200 R10/08 www.azdot.gov

Vehicle Identification Number
1FTHX26H6FKB58041

Year
1985

Make
FORD

Model
X268

Body Style
PU

First Registered
01/1986

List Price
010250

Mobile Home Manufacturer

Unit Number

**DARRELL JAMES HILL
3018 JOHNSON ST
LAKESIDE AZ 85929-5309**

Title Number
K015013311011

Issue Date
11072013

Film Number
N311K01505

Odometer Miles (no tenths)
0015790 B

Previous Title Number State
100A013271022 AZ

Issue Date
09282013

Previous Film Number
N271100A09

A - Actual Mileage
B - Mileage in excess of the odometer mechanical limits
C - NOT Actual Mileage, WARNING ODOMETER DISCREPANCY

Arizona Brands

Previous Brand

State Previous Brand

State Previous Brand

State Other States With Brands

Owners/Lessee

DARRELL JAMES HILL

AND/OR

BEVERLY JEAN ROMERO-HILL

Lienholders

2022-011769 MISC Page: 1586 of 2782
09/26/2022 03:35:37 PM Receipt #: 22-9381
Rec Fee: \$30.00 Darrell James Hill
Gila County, Az, Sadie Jo Bingham, Recorder



LIEN RELEASE

Lienholder Name	Acknowledged before this date	Notary Public Signature		
Lien Amount	Lienholder Signature	Date	County	State Commission Expires

VOID WITHOUT EAGLE WATERMARK OR IF ALTERED OR ERASED

Federal and State law require that the seller states the vehicle mileage upon transfer of ownership. Failure to complete the odometer statement or providing a false statement, may result in fines and/or imprisonment. The buyer has 15 business days to apply for a new vehicle title in order to avoid penalty charges, whether or not the vehicle is being used. This time period is subject to legislative change.

TRANSFER OF OWNERSHIP _____ Seller must complete this section and give title to the new owner _____

Buyer Name (printed)		Sale Date	
Street Address		City	State Zip
New License Plate, Title or VIN (New License Plate Name and Street Address if no lien, with NONE)		Licor Date	

Mileage in excess of the odometer mechanical limits.
 NOT Actual Mileage. WARNING - ODOMETER DISCREPANCY.
 I certify to the best of my knowledge that the odometer reading is the actual mileage unless one of the boxes above is checked.

Seller Name (printed)		Dealer Number	Seller Signature
Street Address		City	State Zip

Acknowledged before me this date _____
 Notary Public or MVD Agent Signature _____
 Date _____ City _____ State _____ Commission Expires _____

I am aware of the above odometer certification made by the seller.
 Buyer Name (printed) _____ Buyer Signature _____

DEALER REASSIGNMENT _____

Buyer Name (printed)		Sale Date	
Street Address		City	State Zip
New License Plate, Title or VIN (New License Plate Name and Street Address if no lien, with NONE)		Licor Date	

Mileage in excess of the odometer mechanical limits.
 NOT Actual Mileage. WARNING - ODOMETER DISCREPANCY.
 I certify to the best of my knowledge that the odometer reading is the actual mileage unless one of the boxes above is checked.

Dealership Name		Dealer Number	Agent Name	Agent Signature
Buyer Name (printed)		Buyer Signature		

I am aware of the above odometer certification made by the seller.

DEALER REASSIGNMENT _____

Buyer Name (printed)		Sale Date	
Street Address		City	State Zip
New License Plate, Title or VIN (New License Plate Name and Street Address if no lien, with NONE)		Licor Date	

Mileage in excess of the odometer mechanical limits.
 NOT Actual Mileage. WARNING - ODOMETER DISCREPANCY.
 I certify to the best of my knowledge that the odometer reading is the actual mileage unless one of the boxes above is checked.

Dealership Name		Dealer Number	Agent Name	Agent Signature
Buyer Name (printed)		Buyer Signature		

I am aware of the above odometer certification made by the seller.

DEALER REASSIGNMENT _____

Buyer Name (printed)		Sale Date	
Street Address		City	State Zip
New License Plate, Title or VIN (New License Plate Name and Street Address if no lien, with NONE)		Licor Date	

Mileage in excess of the odometer mechanical limits.
 NOT Actual Mileage. WARNING - ODOMETER DISCREPANCY.
 I certify to the best of my knowledge that the odometer reading is the actual mileage unless one of the boxes above is checked.

Dealership Name		Dealer Number	Agent Name	Agent Signature
Buyer Name (printed)		Buyer Signature		

I am aware of the above odometer certification made by the seller.

No Additional Reassignments Permitted _____ Last Buyer Must Appear _____

2022-011769 MISC Page: 1587 of 2782
 09/26/2022 03:35:37 PM Receipt #: 22-9381
 Rec Fee: \$30.00 Darrell James Hill
 Gila County, Az, Sadie Jo Bingham, Recorder



Motor Vehicle Division

48-7200 R10/08 www.azdot.gov

Inventory Control
24309057

Vehicle Identification Number
1G8EK16L1GE207716

Year
1986

Make
CHEV

Model
K5U

Body Style
4DSW

First Registered
01/1987

List Price
012817

Mobile Home Manufacturer

Unit Number

DARRELL JAMES HILL
3018 JOHNSON ST
LAKESIDE AZ 85929-5309

Title Number
K015013311008

Issue Date
11/07/2013

Film Number
N311K01504

Odometer Miles (no tenths)
0019339 B

Previous Title Number State
174M002339036 AZ

Issue Date
12/05/2002

Previous Film Number
C339174M13

A - Actual Mileage
B - Mileage in excess of the odometer mechanical limit
C - NOT Actual Mileage, WARNING ODOMETER DISCREPANCY

Arizona Brands

Previous Brand

State Previous Brand

State Previous Brand

State Other States With Brands

Owners/Lessees

DARRELL JAMES HILL

AND/OR

BEVERLY JEAN ROMERO-HILL

Lienholders

2022-011769 MISC Page: 1588 of 2782
09/26/2022 03:35:37 PM Receipt #: 22-9381
Rec Fee: \$30.00 Darrell James Hill
Gila County, Az, Sadie Jo Bingham, Recorder



LIEN RELEASE

Lienholder Name

Acknowledged before me this date

Notary Public Signature

Lien Amount

Lienholder Signature

Date

County

State

Commission Expires

VOID WITHOUT EAGLE WATERMARK OR IF ALTERED OR ERASED

Federal and State law require that the seller states the vehicle mileage upon transfer of ownership. Failure to complete the odometer statement, or providing a false statement, may result in fines and/or imprisonment. The buyer has 15 business days to apply for a new vehicle title in order to avoid penalty charges, whether or not the vehicle is being used. This time period is subject to legislative change.

TRANSFER OF OWNERSHIP Seller must complete this section and give title to the new owner.

Buyer Name (printed)		Sale Date	
Street Address		City	State Zip
New Lichholder Driver License or EIN		New Lichholder Name and Street Address (if no lien, write NONE)	
<input type="checkbox"/> Miles <input type="checkbox"/> Kilometers		<input type="checkbox"/> Mileage in excess of the odometer mechanical limits. <input type="checkbox"/> NOT Actual Mileage. WARNING - ODOMETER DISCREPANCY.	
I certify to the best of my knowledge that the odometer reading is the actual mileage unless one of the boxes above is checked.			
Seller Name (printed)		Dealer Number	Seller Signature
Street Address		City	State Zip
Acknowledged before me this date		Notary Public or MVD Agent Signature	
Date	County	State	Commission Expires
I am aware of the above odometer certification made by the seller.			
Buyer Name (printed)		Buyer Signature	

DEALER REASSIGNMENT

Buyer Name (printed)		Sale Date	
Street Address		City	State Zip
New Lichholder Driver License or EIN		New Lichholder Name and Street Address (if no lien, write NONE)	
<input type="checkbox"/> Miles <input type="checkbox"/> Kilometers		<input type="checkbox"/> Mileage in excess of the odometer mechanical limits. <input type="checkbox"/> NOT Actual Mileage. WARNING - ODOMETER DISCREPANCY.	
I certify to the best of my knowledge that the odometer reading is the actual mileage unless one of the boxes above is checked.			
Dealership Name		Dealer Number	Agent Name
Agent Signature		Agent Signature	
I am aware of the above odometer certification made by the seller.			
Buyer Name (printed)		Buyer Signature	

DEALER REASSIGNMENT

Buyer Name (printed)		Sale Date	
Street Address		City	State Zip
New Lichholder Driver License or EIN		New Lichholder Name and Street Address (if no lien, write NONE)	
<input type="checkbox"/> Miles <input type="checkbox"/> Kilometers		<input type="checkbox"/> Mileage in excess of the odometer mechanical limits. <input type="checkbox"/> NOT Actual Mileage. WARNING - ODOMETER DISCREPANCY.	
I certify to the best of my knowledge that the odometer reading is the actual mileage unless one of the boxes above is checked.			
Dealership Name		Dealer Number	Agent Name
Agent Signature		Agent Signature	
I am aware of the above odometer certification made by the seller.			
Buyer Name (printed)		Buyer Signature	

DEALER REASSIGNMENT

Buyer Name (printed)		Sale Date	
Street Address		City	State Zip
New Lichholder Driver License or EIN		New Lichholder Name and Street Address (if no lien, write NONE)	
<input type="checkbox"/> Miles <input type="checkbox"/> Kilometers		<input type="checkbox"/> Mileage in excess of the odometer mechanical limits. <input type="checkbox"/> NOT Actual Mileage. WARNING - ODOMETER DISCREPANCY.	
I certify to the best of my knowledge that the odometer reading is the actual mileage unless one of the boxes above is checked.			
Dealership Name		Dealer Number	Agent Name
Agent Signature		Agent Signature	
I am aware of the above odometer certification made by the seller.			
Buyer Name (printed)		Buyer Signature	

Page: 1589 of 2782
 Receipt #: 22-9361
 James Hill
 Darrell Jo
 Sadie Jo Bingham Recorder
 Gila County, Az.
 2022-011769 MISC
 09/26/2022 03:35:37 PM
 Rec Fee: \$30.00



**Motor Vehicle
Division**

Inventory Control
#17550551

Vehicle Identification Number: **1GBKP37W3H3313842**
 Year: **1987** Make: **ALLEG** Model: **P30** Body Style: **MHA**
 First Registered: **05/1987** List Price: **048500** Mobile Home Manufacturer: Unit Number:

BEVERLY JEAN ROMERO HILL
15024 W CHARTER OAK RD
SURPRISE AZ 85379-5922

Title Number: **7AK011018008** Issue Date: **01182011** Film Number: **L01187AK03** Odometer Miles (as of title): **0087500**
 Previous Title Number: **448M011011020** State: **AZ** Issue Date: **01112011** Previous Film Number: **L011448M09**
Actual Mileage
If Miled in excess of the odometer mechanical limits
NOT Actual Mileage. WARNING ODOMETER DISCREPANCY

Arizona Brand: **ALLEG** State: **AZ** Previous Brand: **ALLEG** State: **AZ** Other States With Brand:

Owners/Lessees:
BEVERLY JEAN ROMERO HILL AND/OR
DARRELL JAMES HILL

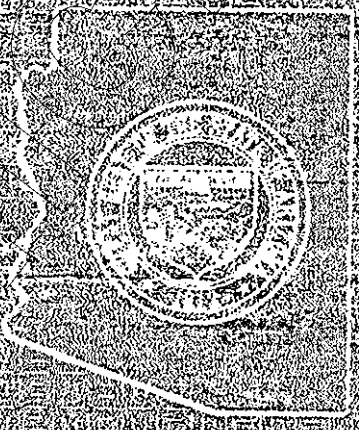

2022-011769 MISC Page: 1590 of 2782
 09/26/2022 03:35:37 PM Receipt #: 22-9381
 Rec Fee: \$30.00 Darrell James Hill
 Gila County, Az, Sadie Jo Bingham, Recorder



LIEN RELEASE
 Lien Amount: \$0.00 Lienholder Signature: Date: County: State: Commission Expires:

VOID WITHOUT EAGLE WATERMARK OR IF ALTERED OR ERASED

Federal and State law require that the seller states the vehicle mileage upon transfer of ownership. Failure to complete the odometer statement, or providing a false statement, may result in fines and/or imprisonment. The buyer has 15 business days to apply for a new vehicle title in order to avoid penalty charges, whether or not the vehicle is being used. This time period is subject to legislative change.

Seller must complete this section and give title to the new owner.

TRANSFER OF OWNERSHIP

Buyer Name (printed) _____ State _____ ZIP _____
 Street Address _____ City _____ State _____ ZIP _____
 New Lienholder Driver License or EIN / New Lienholder Name and Street Address (if no lien, write NONE) _____
 Odometer Reading (in tenths) _____ Miles Kilometers
 Mileage in excess of the odometer mechanical limits
 NOT Actual Mileage - WARNING - ODOMETER DISCREPANCY
 I certify to the best of my knowledge that the odometer reading is the actual mileage unless one of the boxes above is checked.
 Dealer Number _____ Seller Signature _____
 Seller Name (printed) _____ State _____ ZIP _____
 Street Address _____ City _____ State _____ ZIP _____
 Acknowledged before me this date: _____
 Date _____ County _____ State _____ Commission Expires _____
 I am aware of the above odometer certification made by the seller.
 Buyer Signature _____
 Buyer Name (printed) _____

DEALER REASSIGNMENT

Buyer Name (printed) _____ State _____ ZIP _____
 Street Address _____ City _____ State _____ ZIP _____
 New Lienholder Driver License or EIN / New Lienholder Name and Street Address (if no lien, write NONE) _____
 Odometer Reading (in tenths) _____ Miles Kilometers
 Mileage in excess of the odometer mechanical limits
 NOT Actual Mileage - WARNING - ODOMETER DISCREPANCY
 I certify to the best of my knowledge that the odometer reading is the actual mileage unless one of the boxes above is checked.
 Dealership Name _____ Dealer Number _____ Agent Name _____ Agent Signature _____
 I am aware of the above odometer certification made by the seller.
 Buyer Signature _____
 Buyer Name (printed) _____

DEALER REASSIGNMENT

Buyer Name (printed) _____ State _____ ZIP _____
 Street Address _____ City _____ State _____ ZIP _____
 New Lienholder Driver License or EIN / New Lienholder Name and Street Address (if no lien, write NONE) _____
 Odometer Reading (in tenths) _____ Miles Kilometers
 Mileage in excess of the odometer mechanical limits
 NOT Actual Mileage - WARNING - ODOMETER DISCREPANCY
 I certify to the best of my knowledge that the odometer reading is the actual mileage unless one of the boxes above is checked.
 Dealership Name _____ Dealer Number _____ Agent Name _____ Agent Signature _____
 I am aware of the above odometer certification made by the seller.
 Buyer Signature _____
 Buyer Name (printed) _____

DEALER REASSIGNMENT

Buyer Name (printed) _____ State _____ ZIP _____
 Street Address _____ City _____ State _____ ZIP _____
 New Lienholder Driver License or EIN / New Lienholder Name and Street Address (if no lien, write NONE) _____
 Odometer Reading (in tenths) _____ Miles Kilometers
 Mileage in excess of the odometer mechanical limits
 NOT Actual Mileage - WARNING - ODOMETER DISCREPANCY
 I certify to the best of my knowledge that the odometer reading is the actual mileage unless one of the boxes above is checked.
 Dealership Name _____ Dealer Number _____ Agent Name _____ Agent Signature _____
 I am aware of the above odometer certification made by the seller.
 Buyer Signature _____
 Buyer Name (printed) _____

2022-011769 MISC Page: 1591 of 2782
 05/26/2022 03:35:37 PM Receipt #: 22-9381
 Rec Fee: \$30.00 Darrell James Hill
 Gila County, Az, Sadie Jo Bingham, Recorder



APACHE JUNCTION
 151 W SUPERSTITION BLVD
 APACHE JUNCTION, AZ 85120-9998
 030259-0130
 (800)275-8777
 06/23/2020 03:07 PM

Registered No. RE047610526US

Date Stamp



Product	Qty	Unit Price	Price
First-Class Mail® Letter (Domestic) (PHOENIX, AZ 85007) (Weight: 0 Lb 2.00 Oz) (Estimated Delivery Date) (Friday 06/26/2020)	1	\$0.70	\$0.70
Registered (Amount: \$21.00) (USPS Registered Mail #) (RE047610526US)			\$13.20
Return Receipt (USPS Return Receipt #) (9590940247188344961900)			\$2.85
First-Class Mail® Letter (Domestic) (PHOENIX, AZ 85007) (Weight: 0 Lb 1.70 Oz) (Estimated Delivery Date) (Friday 06/26/2020)	1	\$0.70	\$0.70
Non Mach. Surch.			\$0.15
Certified (USPS Certified Mail #) (70091410000078685796)			\$3.55
Return Receipt (USPS Return Receipt #) (9590940247188344961917)			\$2.85
Total:			\$24.00
Cash Change		\$25.00 (\$1.00)	

Reg. Fee	\$0.70
Handling Charge	\$13.20
Postage	\$0.00
Received by	\$13.90
Customer Must Declare Full Value	\$21.00
Domestic Insurance up to \$25,000 included on the declared value. International indemnity is limited. (See Reverse)	06/23/2020

OFFICIAL USE

FROM: Darrell - James Hill, APACHE JUNCTION, AZ 85120
 PO Box 3806
 Apache Junction, Arizona 85117

TO: Kate Hobbs - Trustee
 1701 N. Washington St., Floor 7
 Phoenix, Arizona 85007

PS Form 3806, Receipt for Registered Mail Copy 1 - Customer
 May 2007 (7530-02-000-9051) (See Information on Reverse)
 For domestic delivery information, visit our website at www.usps.com®

U.S. Postal Service™
CERTIFIED MAIL™ RECEIPT
 (Domestic Mail Only; No Insurance Coverage Provided)
 For delivery information visit our website at www.usps.com®

Postage	\$3.55	0130
Certified Fee	\$2.85	06
Return Receipt Fee (Endorsement Required)	\$0.00	
Restricted Delivery Fee (Endorsement Required)	\$0.00	
Total Postage & Fees	\$7.25	06/23/2020

Sent to: Scott Omer
 Street Apt. No. or PO Box No.: 206 S 17th Ave, Mail 100A
 City, State, ZIP+4: Phoenix, Arizona 85007

PS Form 3800, August 2006 See Reverse for Instructions

COMPLETE THIS SECTION ON DELIVERY

A. Signature: *Samuel Mendez*
 B. Received by (Printed Name): Samuel Mendez
 C. Date of Delivery: JUN 24 2020
 D. Is delivery address different from item 1? Yes No
 If YES, enter delivery address below:

3. Service Type:
 Priority Mail Express®
 Registered Mail™
 Adult Signature Restricted Delivery®
 Certified Mail®
 Collect on Delivery Restricted Delivery
 Signature Confirmation™
 Signature Confirmation Restricted Delivery

SENDER: COMPLETE THIS SECTION

1. Article Addressed to:
 Scott Omer Trustee
 206 S 17th Ave, Mail 100A
 Phoenix, Arizona 85007

2. Article Addressed to:
 9590 9402 4718 8344 9619 17

3. Barcode: 9590 9402 4718 8344 9619 17

ALERT: DUE TO LIMITED TRANSPORTATION AVAILABILITY AS A RESULT OF NATIONWIDE COVID-19 IMPACTS, PACKAG...

USPS Tracking®

[FAQs >](#)

Track Another Package +

**Track Packages
Anytime, Anywhere**

Get the free Informed Delivery® feature to receive automated notifications on your packages

[Learn More](#)

<https://reg.usps.com>

</xcell?app=UspsTools&ref=homepageBanner&appURL=https%3A%2F%2Finformeddelivery.usps.com/box/pages/intro/start.action>

Tracking Number: 70091410000078685796

[Remove X](#)

Your item was picked up at a postal facility at 8:14 am on June 24, 2020 in PHOENIX, AZ 85009.

✓ Delivered

June 24, 2020 at 8:14 am
Delivered, Individual Picked Up at Postal Facility
PHOENIX, AZ 85009

[Get Updates ▾](#)

Text & Email Updates ▾

Tracking History ▲

June 24, 2020, 8:14 am
Delivered, Individual Picked Up at Postal Facility
PHOENIX, AZ 85009
Your item was picked up at a postal facility at 8:14 am on June 24, 2020 in PHOENIX, AZ 85009.

June 24, 2020, 7:10 am
Out for Delivery
PHOENIX, AZ 85007

June 24, 2020, 6:40 am
Arrived at Unit
PHOENIX, AZ 85009

June 23, 2020, 7:55 pm
Arrived at USPS Regional Facility
PHOENIX AZ DISTRIBUTION CENTER ANNEX

2022-011769 MISC Page: 1593 of 2782
09/26/2022 03:35:37 PM Receipt #: 22-9381
Rec Fee: \$30.00 Darrell James Hill
Gila County, Az, Sadie Jo Bingham, Recorder



6/26/20, 5:44 PM

Declaration of :i- man - :Ambassador to :Yushuah the :Messiah

From :Darrell-James: Hill¹, -:i- man², -:civilian, -:Executor³, -:Ambassador⁴,
PO Box 3806, Apache Junction, Arizona 85117

:man -:present,

:The united States of America,

Arizona state
Pinal county

To :Jorge-Mario: Bergoglio⁵ ~:USPS RMN RE 322 387 576 US
c/o Apostolic Palace
00120 Vatican City^{6 7}

c/o :Donald-John :CIC- :Trump^{8 9} :USPS RMN RE 322 387 562 US
1600 Pennsylvania Ave NW
Washington, District of Columbia 20500

**Specialty- Presentment: To The Roman -Church¹⁰, et al.- Usurpers,
For the Cure and Relief -in the :Equity-Claim, and For the Remedy-Required
For the Trespassing Upon The Children of Ysrael/Israel, et al.**

Greetings :Jorge-Mario, :Donald-John, et al.,

With all due respect, :i- man am to declare this to you by :order of the Messiah
Yushuah~Jesus~ God-Almighty. You must let All of the people of the Most-High-God
go free unharmed with all of their belongings and with the full-accounting of their
property and chattel. To :this- end, :i- man must declare to you:

A - :Declaration: i- man am: Judah of: Ysrael

:i- man declare 1) the :embodiment of :i-man- Adam¹¹ within the oneness with the
Almighty- Creator -:God with the man :Jacob~ Ysrael¹², son of :Isaac¹³ the :brother of

1 :Darrell-James: Hill means: Earthen -man-child, :birthed :son of :Clarence, :son of :James, :son :Negroland, :Kingdom-of-
Judah, :Africa', ...:son :Ysrael' :Southern-Kingdom ~ of the sons :Judah and Benjamin and Levi, et al., ...:son of :Jacob and
:Ysrael, :son of :Isaac, :son of :Abram and :Abraham, ...:son of :Shem, :son of :Noah, ...:son of :Methuselah, :son of
:Enoch, ...:son of :Seth, :son of :Adam with :Eve of the garden of :Eden ~ including all :known and unknown :ancestral- lands ~
on the earth placed under the Adamic- lineage and under the :only-begotten -son of the Most-High-God and Father embodied
within the rebirth by :i- man of the power of :Yushuah-Messiah, -:God, with the redemption by the Messiah- Yushuah ('Jesus-
the-Christ'), and encompassing the :receivership, responsibility and administration over :all of the earth-planet as :heir -
:remainderman, and :Kinsman- :redeemer of the Earth, both 1) from the Adamic-lineage by the :loss in :spirit in the man upon
the Earth, and 2) by the Messiah-Yushuah by the restoration in the Holy Spirit in :i- man upon the Earth: on, in or under-the-
surface of the planet; on, in or under-the-surface of the oceans and waters, and :on, in, under-the-surface of the atmosphere/
above the atmosphere of the Earth to wherever the :Adamic- :man -kind in the quantum and in the spirit is now, of where the
:purposes of the Most High God and :Father are immeasurable by mere :man. No-thing Stands between the Almighty God~ His
Father; See: KJV- Book: Daniel -chap. 7 v 9 - 14.~ and :i-man.

2 :i- man means: 'I' is the Great :I am, Almighty God Creator of all and for whom all is; 'man' is the kind on this Earth- world, made
in the image of the Almighty God and His Father, the :Ancient-of-Days - the Most-High-God

3 :Darrell-James: Hill means: :Darrell-James: Hill means: Darrell-James: Hill © 1958: Ohioan, © 1958: State of Ohio:
beneficiary. See: Gila county Arizona: Doc. # 2017-002378: pp. 6-24, 89-91,93-95 of 693. Gila county Arizona: Doc. # 2018-
005176: pp. 10-21; and, et seq.: beneficiary of the Cestui Quo Trustee-minister: Jorge-Mario: Bergoglio55

4 :Ambassador means: KJV- Book: Ephesians— chap.. 6, v. 20. "For which I am an ambassador in bonds: that therein I may
speak boldly, as I ought to speak."

5 :Jorge-Mario: Bergoglio means: man-kind of the Earth-planet

6 :Babylon- Rome means: KJV- Book :Daniel -chap. 2, v. 40 - 43.

7 :Rome means: KJV- Book: Obadiah-- chap. 1; Psalms— chap.. 83.

8 :Donald-John: Trump means: man -trustee under the duty, obligation and moral-Oath of Office: 20th day of January, the year
our Lord 2020 A.D.-, ministry: as :President of 'The united states of America' ~unincorporated,1776 A.D.- as 'Commander-in-
Chief' with the :General Order 100 ~Lieber Code~ :24th day, April, the year of our Lord 1863 A.D: under the Declaration of
Independence for the united states of America -people by 'The Constitution for the United States of America'.

9 :Donald-John: Trump means: man-kind of the Earth-planet, :man -trustee under the duty, obligation and moral-Oath of Office

10 :Roman -Church means: the polytheism government methodology contrived and implemented from the 4th century A.D. by the
Roman Emperor Constantine.

11 :Adam means: within the oneness with the Almighty- Creator -:God. See: KJV- Book: Genesis- chap. 2

12 :Jacob~ Ysrael means: covenant of :God-Almighty and :Jacob means: KJV- Book: Genesis- chap 26 v 34 - Genesis- chap
31 v 29.

13 :Isaac means: covenant of :God-Almighty and Issac means: KJV- Book: Genesis-- chap.. 17 v 15 And God said unto



Declaration of :-i- man - :Ambassador to :Yushuah the :Messiah

:Ishmael¹⁴, sons of :Abram ~ Abraham¹⁵, ...son of :Shem, ...son of: Noah¹⁶, ...son of Methuselah, ...son of :Adam; and, 2) :-i- man- Adam declare that :-i- man -:Negro¹⁷ am yet upon The united states of America a) :Judah of the people of Ysrael of the man :Jacob, and that :-i- man am b) spiritually :Adam -of -Ysrael¹⁸ by the blood of the Messiah: Yushuah ~'Christ Jesus' ~ the : Almighty God~, by His Father's will be done.¹⁹ Thereto: No-thing Stands between the :Almighty God~ who is in oneness with His Father²⁰ and :-i-man-²¹ :Darrell-James: Hill.

B - :-i- man -:Adam Believe with :Faith in the Creator -:Almighty- God -:Statement

1. :-i- man believe in the Creator-Almighty-God as characterized in the wise by the equations:

- a) $0 + 0 = 0$, et seq., where "0" is the absolutely empty set; where
a.i.) "0" is the only moral -truth -set; that is, nothing plus nothing equals nothing;

- Abraham, As for Sarai thy wife, thou shalt not call her name Sarai, but Sarah *shall her name be*. 16 And I will bless her, and give thee a son also of her: yea, I will bless her, and she shall be a *mother* of nations; kings of people shall be of her. 17 Then Abraham fell upon his face, and laughed, and said in his heart, Shall a *child* be born unto him that is an hundred years old? and shall Sarah, that is ninety years old, bear? 18 And Abraham said unto God, O that Ishmael might live before thee! 19 And God said, Sarah thy wife shall bear thee a son indeed; and thou shalt call his name Isaac: and I will establish my covenant with him for an everlasting covenant, and with his seed after him.
- 14 :-i- brother -Ishmael means: covenant of :God-Almighty and Ishmael means: KJV- Book: Genesis- chap.. 17 (a) v 9 And God said unto Abraham, Thou shalt keep my covenant therefore, thou, and thy seed after thee in their generations. 10 This is my covenant, which ye shall keep, between me and you and thy seed after thee; Every man child among you shall be circumcised. ... 11 And ye shall circumcise the flesh of your foreskin; and it shall be a token of the covenant betwixt me and you. 12 And he that is eight days old shall be circumcised among you, every man child in your generations, he that is born in the house, or bought with money of any stranger, which is not of thy seed. 13 He that is born in thy house, and he that is bought with thy money, must needs be circumcised; and my covenant shall be in your flesh for an everlasting covenant. 14 And the uncircumcised man child whose flesh of his foreskin is not circumcised, that soul shall be cut off from his people; he hath broken my covenant. ... 18 And Abraham said unto God, O that Ishmael might live before thee! 19 And God said, Sarah thy wife shall bear thee a son indeed; and thou shalt call his name Isaac: and I will establish my covenant with him for an everlasting covenant, and with his seed after him. 20 And as for Ishmael, I have heard thee: Behold, I have blessed him, and will make him fruitful, and will multiply him exceedingly; twelve princes shall he beget, and I will make him a great nation. ... 23 And Abraham took Ishmael his son, and all that were born in his house, and all that were bought with his money, every male among the men of Abraham's house; and circumcised the flesh of their foreskin in the selfsame day, as God had said unto him. 24 And Abraham was ninety years old and nine, when he was circumcised in the flesh of his foreskin. 25 And Ishmael his son was thirteen years old, when he was circumcised in the flesh of his foreskin. 26 In the selfsame day was Abraham circumcised, and Ishmael his son.
- 15 :Abram ~ Abraham means: covenant of God-Almighty and Abram ~ Abraham means: KJV- Book: Genesis- chap.. 17 (a) v 1 And when Abram was ninety years old and nine, the LORD appeared to Abram, and said unto him, I *am* the Almighty God; walk before me, and be thou perfect. 2 And I will make my covenant between me and thee, and will multiply thee exceedingly. 3 And Abram fell on his face: and God talked with him, saying, 4-As for me, behold, my covenant is with thee, and thou shalt be a father of many nations. 5 Neither shall thy name any more be called Abram, but thy name shall be Abraham; for a father of many nations have I made thee. (b) 6 And I will make thee exceeding fruitful, and I will make nations of thee, and kings shall come out of thee. (c) 7 And I will establish my covenant between me and thee and thy seed after thee in their generations for an everlasting covenant, to be a God unto thee, and to thy seed after thee. 8 And I will give unto thee, and to thy seed after thee, the land wherein thou art a stranger, all the land of Canaan, for an everlasting possession; and I will be their God. 9 And God said unto Abraham, Thou shalt keep my covenant therefore, thou, and thy seed after thee in their generations. 10 This is my covenant, which ye shall keep, between me and you and thy seed after thee; Every man child among you shall be circumcised. (d1/2) 11 And ye shall circumcise the flesh of your foreskin; and it shall be a token of the covenant betwixt me and you. 12 And he that is eight days old shall be circumcised among you, every man child in your generations, he that is born in the house, or bought with money of any stranger, which is not of thy seed. 13 He that is born in thy house, and he that is bought with thy money, must needs be circumcised; and my covenant shall be in your flesh for an everlasting covenant. 14 And the uncircumcised man child whose flesh of his foreskin is not circumcised, that soul shall be cut off from his people; he hath broken my covenant. (e) 15 And God said unto Abraham, As for Sarai thy wife, thou shalt not call her name Sarai, but Sarah *shall her name be*. 16 And I will bless her, and give thee a son also of her: yea, I will bless her, and she shall be a *mother* of nations; kings of people shall be of her. 17 Then Abraham fell upon his face, and laughed, and said in his heart, Shall a *child* be born unto him that is an hundred years old? and shall Sarah, that is ninety years old, bear? (f) 18 And Abraham said unto God, O that Ishmael might live before thee! (g1/2) 19 And God said, Sarah thy wife shall bear thee a son indeed; and thou shalt call his name Isaac: and I will establish my covenant with him for an everlasting covenant, and with his seed after him. (h) 20 And as for Ishmael, I have heard thee: Behold, I have blessed him, and will make him fruitful, and will multiply him exceedingly; twelve princes shall he beget, and I will make him a great nation. (g2/2) 21 But my covenant will I establish with Isaac, which Sarah shall bear unto thee at this set time in the next year. (i) 22 And he left off talking with him, and God went up from Abraham. (j) 23 And Abraham took Ishmael his son, and all that were born in his house, and all that were bought with his money, every male among the men of Abraham's house; and circumcised the flesh of their foreskin in the selfsame day, as God had said unto him. 24 And Abraham was ninety years old and nine, when he was circumcised in the flesh of his foreskin. 25 And Ishmael his son was thirteen years old, when he was circumcised in the flesh of his foreskin. 26 In the selfsame day was Abraham circumcised, and Ishmael his son. 27 And all the men of his house, born in the house, and bought with money of the stranger, were circumcised with him.
- 16 :Noah means covenant of God-Almighty and Noah means: KJV- Book: Genesis- chap.. 9 v 8 And God spake unto Noah, and to his sons with him, saying, 9 And I, behold, I establish my covenant with you, and with your seed after you; 10 And every living creature that is with you, of the fowl, of the cattle, and of every beast of the earth with you; from all that go out of the ark, to every beast of the earth. 11 And I will establish my covenant with you; neither shall all flesh be cut off any more by the waters of a flood; neither shall there any more be a flood to destroy the earth. 12 And God said, This is the token of the covenant which I make between me and you and every living creature that is with you, for perpetual generations: 13 I do set my bow in the cloud, and it shall be for a token of a covenant between me and the earth. 14 And it shall come to pass, when I bring a cloud over the earth, that the bow shall be seen in the cloud: 15 And I will remember my covenant, which is between me and you and every living creature of all flesh; and the waters shall no more become a flood to destroy all flesh. 16 And the bow shall be in the cloud; and I will look upon it, that I may remember the everlasting covenant between God and every living creature of all flesh that is upon the earth. 17 And God said unto Noah, This is the token of the covenant, which I have established between me and all flesh that is upon the earth. 18 And the sons of Noah, that went forth of the ark, were Shem, and Ham, and Japheth: and Ham is the father of Canaan.
- 17 :Negro means: son of the Southern-Kingdom -of -Ysrael; enslaved by the Trustee-minister of the Magna Carta, et al.- Usurpers
18 :Adam of :Ysrael means: KJV- Book: A) Romans- chap. 5 v 12 Wherefore, as by one man sin entered into the world, and

Declaration of :i- man - :Ambassador to :Yushuah the :Messiah

and:

b) $0 + 1 = 1$, et seq., where "1" is the presence of the substance of the set of :characteristics; that is, nothing plus :1 -:something equals :1 -:something; where b.i.) "1" is the only moral -truth -set;

and,

c) where the inverse of truth is characterized by the equations:

c.i) $0 + 0 = X$ -set where the untruth is the any 'set of X', except the "0" truth,

and

where

c.ii) $0 + 1 = Y$ -set where the untruth is the any 'set of Y', except the "1" truth.

Where-as: all -that -is -created in the worlds of the universes has :origin in the sum of the sets of :characteristics expressed within :a), b) and c)' with the intelligent- design by the Almighty-God with His Father, the :Most-High-God.

2. :i- man believe that :man -kind is the indivisible corporation of the spiritual faculties of the spirit and soul components joined into the original-intelligence- live- earthen-product by the Creator-God's design. And:

3. :i- man believe that man -kind's now-fallen-state diverged from the Creator-Gods' baseline design of :man- kinds' first estate -in -:oneness -with -:God; that, :man-kind's baseline -normal is in :oneness with the Most-High-God;

Where-as, that the act-of-repentance, -changing and turning toward God's law is by the exercise of the spiritual faculties toward :oneness -with -:God, repentance is the :foundation of :man-kinds' :spiritual-joy, physical-happiness, and :gladness with :abundance in :well-being ²².

C - :NOTICE:

Purgatory Oath: Lateness Of This Presentment

:i-man Affirm and Declare That The 'lateness Of This Presentment' Is Due To The Lack Of Knowledge And Ignorance Of :i-man; and, the :Trust -resources to afford the cost of this pursuit have been a) administered without authorization and b) used to impose harm and competition against :i-man -:beneficiary, et al.- children of Ysrael.

For the fact that :i-man- Adam, et al.- Judah, have been systematically -systemically -oppressed with the brutality-imposed -ignorance and assurance unto the lack of knowledge from the confederate- usurpers since on or before 1600 A.D. unto now ~2020 A.D.~ with the oversight and support for these and other harms by the Roman-Church -Usurper-Trustee -gross -malfeasance. Thereto, :i- man believe that this presentment is timely through the four centuries upon the historical accounts and recorded facts of the murder-for- annihilation for the extinction²³, and the continued abject- hostility upon :i- man, et al. - members of the House of Ysrael by the :absolute-malfeasance²⁴ of the pure -obligation²⁵ by the "Roman -Church", et al.- confederate -impostors.

death by sin; and so death passed upon all men, for that all have sinned: 13 (For until the law sin was in the world: but sin is not imputed when there is no law. 14 Nevertheless death reigned from Adam to Moses, even over them that had not sinned after the similitude of Adam's transgression, who is the figure of him that was to come. B) 1 Corinthians-- chap.. 15 v 21 For since by man came death, by man came also the resurrection of the dead. 22 For as in Adam all die, even so in Christ shall all be made alive. 23 But every man in his own order: Christ the firstfruits; afterward they that are Christ's at his coming. 24 Then cometh the end, when he shall have delivered up the kingdom to God, even the Father; when he shall have put down all rule and all authority and power. 25 For he must reign, till he hath put all enemies under his feet. 26 The last enemy that shall be destroyed is death. C) 1 Corinthians-- chap.. 15 v 42 So also is the resurrection of the dead. It is sown in corruption; it is raised in incorruption: 43 It is sown in dishonour; it is raised in glory: it is sown in weakness; it is raised in power: 44 It is sown a natural body; it is raised a spiritual body. There is a natural body, and there is a spiritual body. 45 And so it is written, The first man Adam was made a living soul; the last Adam was made a quickening spirit.

19 :Father's will be done[] means: KJV- Book: Mark-- chap.. 14 v. 32-36.

20 :Almighty God- who is in oneness with His Father means: KJV- Book: John -chap 17

21 Ibid, 1

22 :abundance in :well-being means: KJV- Book :Hebrews- chap 5 and 6.

23 :murder-for- annihilation for the extinction means: KJV- a) Book: Psalms 83. ; b) Book: Obadiah -chap 1.

24 :absolute- malfeasance means: contracts, torts. The unjust performance of some act which the party had no right, or which he had contracted not to do.

25 :pure -obligation means: tie which binds us to pay or to do something agreeably to the laws and customs of the country in which the obligation is made.



Declaration of :i- man - :Ambassador to :Yushuah the :Messiah

D – :Wrong-doing: Roman -Church -Trespassing Upon The :Children -Of -Ysrael

:Roman -Church Fraud

:i- man declare that for the last four-hundred ~400~ years or more that the annihilation with the :murders upon the House of Judah of :Ysrael unto the abject enslavement onto the American-continent, et al.- "Egypt"²⁶ is commonly known and well documented within the records of the decisions with the violations of the fiduciary-duty and obligation by the :non- Christian -rulers of the Roman -Church -military -church -regime until now. See: Magna Carta²⁷. – :Thereto, that :fraud vitiates, a) the equation of the fraud is fraud in :fact from the beginning, and, b) Where as, the Roman- Church is established in fraud as an impostor then the any :Roman -Church- :papal- infallibility is merely impossible.

E – Faux- Nobility of :Esau²⁸ with :Saul²⁹; et al.- Roman -Church Identity Theft

:i- man know and believe that as :Nothing is new under the sun, so again was Satan's use of the :pagen-rulers of :Rome akin to :King Herod's oppression directly upon the infant -:Yushuah, and unto Rome's, et al's, callous deeds surrounding the immoral :sacrifice of the adult -:Yushuah~ the :lamb of the Most-High-God~; so now-again after nearly :two-thousand~2000~ years ought the Roman -Church, et al., choose life through the :repentance, changing and turning afforded to :all and them by the Messiah -:Yushuah~ Jesus-the-Christ – Almighty-God~, the :lamb of the Most-High-God.

:i- man believe that the faux- nobility amalgam of Saul with Esau, et al.- Roman -Church -military- :church -regime -:lineage has for many centuries opportunistically and tyrannically promoted :itself to the world with the deception that either bloodline is a) in the line of the succession of the children of Jacob/Ysrael, or, that b) :either has acted in the righteous -keeping of the commandments of the Almighty-God before the billions of :soul- witnesses sojourning on Almighty-God's Earth.

F – Coveting Is Now Fraud

- a) :i- man believe that for the coveting of the office of :Jacob~Ysrael that the 'Roman -Church', et al., passes-itself -off/passed-itself -off to the world as the "Holy Church"³⁰.";
b) Both :Esau and :Saul remain complicit in the fraud and are historically unfit to lead the "Holy -Church" as a matter of :common - biblical- knowledge as adjudged by the Almighty-God;
c) The :Roman -Church to day remains unrepentant of the fiduciary-violations with the aiding, abetting, and condoning the continued brutal enslavement- for-annihilation of the

26 "Egypt" means: KJV- Book: Deuteronomy- chap 28 v 64 -68.

27 :Magna Carta 1215, A.D. means: a) Magna Carta, 1215 A.D. by: b) the :King John I, :Concession of England To The Pope, 1213 A.D., "We wish it to be known to all of you, through this our charter, furnished with our seal, that inasmuch as we had offended in many ways God and our mother the holy church, and in consequence are known to have very, much needed the divine mercy, and can not offer anything worthy for making due satisfaction to God and to the church unless we humiliate ourselves and our kingdoms:-we, wishing to humiliate ourselves for Him who humiliated Himself for us unto death, the grace of the Holy Spirit inspiring, not induced by force or compelled by fear, but of our own good and spontaneous will and by the common counsel of our barons, do offer and freely concede to God and His holy apostles Peter and Paul and to our mother the holy Roman church, and to our lord pope Innocent and to his Catholic successors, the whole kingdom of England and the whole kingdom Ireland with all their right and appurtenances...." administered by c) the 'Crown Temple' in the receipt of the Crown In Chancery understanding common law.

28 :Esau means: KJV- Book: A) Genesis-- chap.. 25 v 34; "... Esau despised *his* birthright."; B) Book: Romans 9:13 As it is written, Jacob have I loved, but Esau have I hated. ~ KJV- Book :Malachi- chap. 1 v 2 Was not Esau Jacob's brother? saith the LORD: yet I loved Jacob, 3 And I hated Esau, and laid his mountains and his heritage waste for the dragons of the wilderness. 4 Whereas Edom saith, We are impoverished, but we will return and build the desolate places; thus saith the LORD of hosts, They shall build, but I will throw down; and they shall call them, The border of wickedness, and, The people against whom the LORD hath indignation for ever." C) Book: Obadiah- chap 1.

29 :Saul means: KJV- Book: 1 Samuel-- chap.. 15 v 22: "... to obey is better than sacrifice," – v 28: The LORD hath rent the kingdom of Israel from thee [Saul] this day, and hath given it to a neighbour of thine, *that* is better than thou." – v 35'... and the LORD repented that he had made Saul king over Israel."

30 :Holy Church means: A) KJV- Book: Acts-- chap.. 1 v 4 And, being assembled together with *them*, commanded them that they should not depart from Jerusalem, but wait for the promise of the Father, which, *saith he*, ye have heard of me. 5 For John truly baptized with water; but ye shall be baptized with the Holy Ghost not many days hence. 6 When they therefore were come together, they asked of him, saying, Lord, wilt thou at this time restore again the kingdom to Israel? 7 And he said unto them, It is not for you to know the times or the seasons, which the Father hath put in his own power. 8 But ye shall receive power, after that the Holy Ghost is come upon you: and ye shall be witnesses unto me both in Jerusalem, and in all Judaea, and in Samaria, and unto the uttermost part of the earth. B) The 'Holy -Church' is the many-membered -body of :those -whosoever -will -believe -upon -the -Messiah -Yushuah, creator of the :heavens and Earth; He, who with leaving His Heavenly state, came to His Earth in the humble form of :man with humble beginnings, and who taught and demonstrated to the world the :Adam- man- kind by the will of His father: and, then-after He who died upon crucifixion for the sins of :man- kind, rose to life on the third-day, and now sits at the right-hand of :His -father -on -the -throne in :Heaven



Declaration of :i- man - :Ambassador to :Yushuah the :Messiah

Negro-remnant of :Judah of the children of :Ysrael with plunder and violation and perversity.

G – Remedy

1) Order: Receivership of the Earth-planet

:i- man declare and now accept the :duty and obligation from the Almighty- God, et seq.³¹, as :i- man -:Adam -:Ambassador of the Almighty-God with all authority for the receipt, possession and complete accounting for the real and chattel property disposed in the devotion to :Yushuah ~Jesus the Messiah~ and onto Peter³², Paul³³ and the Holy Church.

2) Duty And Obligation To The Holy -Church

:Where, as the :‘Roman -Church’ is Not the ‘Holy Church’ -body-of-believers in the Most-High-God, nor keepers of the Word-of-God, so too neither is/ was Petros~ Peter~, one :apostle of :Yushuah the :Messiah, in any way a member of the Rome -Church -:military -:church -base, except with the deception by the Roman -Church, et al., fraud. – :Thereto,

:i- man declare and accept the duty and obligation to the Holy- Church of the Messiah- Yushuah~ Jesus for whom am :i- man- Adam -:Ambassador.

3) Duty and Obligation To The Houses -of -Israel and -:Judah, et al.

The ‘Holy -Church’ is the many-membered -body of :those -whosoever -will -believe upon the Messiah -Yushuah, creator of the :heavens and Earth; and, who with leaving His Heavenly state, came to His Earth in the humble form of :man with humble beginnings, and who taught and demonstrated to the world the :Adam- man- kind by the will of His father³⁴~ the Most High God~, and then-after who died upon crucifixion for the sins of :man- kind, rose to life on the third-day, and now sits at the right-hand of :His -father -on the -throne in :Heaven. – :Thereto,

:i- man declare and accept the duty and obligation to the House -of -Israel and House -of -Judah from whom am :i- man- Adam - :Ambassador of :Yushuah~Jesus ~the Messiah.

4) Duty and Obligation To The Tribe of Israel as Kinsman³⁵-redeemer³⁶ for the lost

31 from the Almighty- God, et seq. means: Ibid. 27

32 :Peter means: KJV- Book: 2 Peter- chap. 1 v 1 Simon Peter, a servant and an apostle of Jesus Christ, to them that have obtained like precious faith with us through the righteousness of God and our Saviour Jesus Christ: 2 Grace and peace be multiplied unto you through the knowledge of God, and of Jesus our Lord. 3 According as his divine power hath given unto us all things that pertain unto life and godliness, through the knowledge of him that hath called us to glory and virtue: 4 Whereby are given unto us exceeding great and precious promises: that by these ye might be partakers of the divine nature, having escaped the corruption that is in the world through lust. 5 And beside this, giving all diligence, add to your faith virtue; and to virtue knowledge; 6 And to knowledge temperance; and to temperance patience; and to patience godliness; 7 And to godliness brotherly kindness; and to brotherly kindness charity. 8 For if these things be in you, and abound, they make you that ye shall neither be barren nor unfruitful in the knowledge of our Lord Jesus Christ. 9 But he that lacketh these things is blind, and cannot see afar off, and hath forgotten that he was purged from his old sins. 10 Wherefore the rather, brethren, give diligence to make your calling and election sure: for if ye do these things, ye shall never fall: 11 For so an entrance shall be ministered unto you abundantly into the everlasting kingdom of our Lord and Saviour Jesus Christ.

33 :Paul means: KJV- Book: A) Acts- chap. 17 v Act 17:22 Then Paul stood in the midst of Mars’ hill, and said, Ye men of Athens, I perceive that in all things ye are too superstitious. 23 For as I passed by, and beheld your devotions, I found an altar with this inscription, TO THE UNKNOWN GOD. Whom therefore ye ignorantly worship, him declare I unto you. 24 God that made the world and all things therein, seeing that he is Lord of heaven and earth, dwelleth not in temples made with hands; 25 Neither is worshipped with men’s hands, as though he needed any thing, seeing he giveth to all life, and breath, and all things; 26 And hath made of one blood all nations of men for to dwell on all the face of the earth, and hath determined the times before appointed, and the bounds of their habitation; 27 That they should seek the Lord, if haply they might feel after him, and find him, though he be not far from every one of us: 28 For in him we live, and move, and have our being; as certain also of your own poets have said, For we are also his offspring. 29 Forasmuch then as we are the offspring of God, we ought not to think that the Godhead is like unto gold, or silver, or stone, graven by art and man’s device. 30 And the times of this ignorance God winked at; but now commandeth all men every where to repent: 31 Because he hath appointed a day, in the which he will judge the world in righteousness by that man whom he hath ordained; whereof he hath given assurance unto all men, in that he hath raised him from the dead. B) Romans:- chap. 1 v Rom 1:1 Paul, a servant of Jesus Christ, called to be an apostle, separated unto the gospel of God, 2 (Which he had promised afore by his prophets in the holy scriptures,) 3 Concerning his Son Jesus Christ our Lord, which was made of the seed of David according to the flesh; 4 And declared to be the Son of God with power, according to the spirit of holiness, by the resurrection from the dead: 5 By whom we have received grace and apostleship, for obedience to the faith among all nations, for his name: 6 Among whom are ye also the called of Jesus Christ: 7 To all that be in Rome, beloved of God, called to be saints: Grace to you and peace from God our Father, and the Lord Jesus Christ.

34 :Adam- man- kind by the will of His father means: KJV- Book: Isaiah- chap. 58 – 61; Luke 4:

35 :Kinsman means: KJV- Book: Numbers- chap. 27 v 7 ... ye shall give his inheritance unto his kinsman that is next to him of his family, and he shall possess it: and it shall be unto the children of Israel a statute of judgment, as the LORD commanded Moses.

36 :Kinsman-redeemer means: KJV- Book: A) Exodus- chap., 6 v 2 And God spake unto Moses, and said unto him, I am the LORD: 3 And I appeared unto Abraham, unto Isaac, and unto Jacob, by the name of God Almighty, but by my name JEHOVAH



Declaration of :- man - :Ambassador to :Yushuah the :Messiah

-Tribes -of -Ysrael. :Thereto, :- man declare and accept the duty and obligation to/ for the lost -Tribes -of -Ysrael for whom am :- man- Adam -Ambassador- brother -kinsman- redeemer.

5) Accounting Demand

A full-accounting of all right and property -real, chattel, and account to the penny is immediately -required, now.

Sincerely,
Without Prejudice

:Darrell-James: Hill,
:-Executor, -:Ambassador

Affirmed and autographed before me this 24 day: July 2020 A.D.

Type of Identification: Arizona Driver License

Notary Public

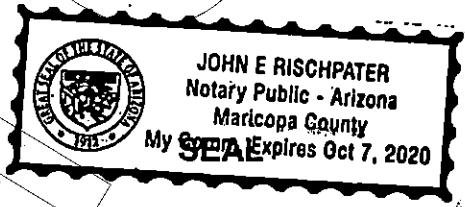

was I not known to them. 4 And I have also established my covenant with them, to give them the land of Canaan, the land of their pilgrimage, wherein they were strangers. 5 And I have also heard the groaning of the children of Israel, whom the Egyptians keep in bondage; and I have remembered my covenant. 6 Wherefore say unto the children of Israel, I am the LORD, and I will bring you out from under the burdens of the Egyptians, and I will rid you out of their bondage, and I will redeem you with a stretched out arm, and with great judgments: 7 And I will take you to me for a people, and I will be to you a God: and ye shall know that I am the LORD your God, which bringeth you out from under the burdens of the Egyptians. B) Psalms- chap.. 19 v 7 The law of the LORD is perfect, converting the soul: the testimony of the LORD is sure, making wise the simple. 8 The statutes of the LORD are right, rejoicing the heart: the commandment of the LORD is pure, enlightening the eyes. 9 The fear of the LORD is clean, enduring for ever: the judgments of the LORD are true and righteous altogether. 10 More to be desired are they than gold, yea, than much fine gold: sweeter also than honey and the honeycomb. 11 Moreover by them is thy servant warned: and in keeping of them there is great reward. 12 Who can understand his errors? cleanse thou me from secret faults. 13 Keep back thy servant also from presumptuous sins; let them not have dominion over me: then shall I be upright, and I shall be innocent from the great transgression. 14 Let the words of my mouth, and the meditation of my heart, be acceptable in thy sight, O LORD, my strength, and my redeemer.

ambassador to :Yushuah the :Messiah



Registered No. RE322387576US

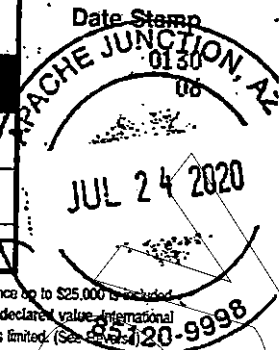

APACHE JUNCTION
151 W SUPERSTITION BLVD
APACHE JUNCTION, AZ 85120-9998
030259-0130
(800)275-8777
07/24/2020 02:46 PM

Reg. Fee	\$2.24	Return Receipt	
Handling Charge	\$16.00	Restricted Delivery	
Postage	\$4.15		
Received by	\$0.00		
Customer Must Declare Full Value \$0.00		Domestic Insurance up to \$25,000 is included on the declared value. International Indemnity is limited. (See Form 3800-9998)	

Product	Qty	Unit Price	Price
First-Class Intl Letter	1	\$2.24	\$2.24
International Vatican City			
Weight: 0 Lb 1.90 Oz			
Registered Amount: \$0.00			\$16.00
USPS Registered Mail # RE322387576US			
Return Receipt			\$4.15
Total:			\$22.39
Cash Change			\$50.00 (\$27.61)

OFFICIAL USE

FROM: DARRYL JAMES HILL, Domicilio
PO Box 3806
Apache Junction, Arizona 85117

TO: Jorge-Mario Bergoglio
Apostolic Palace
00120 Vatican City

PS Form 3806, Receipt for Registered Mail Copy 1 - Customer
May 2007 (7530-02-000-9051) (See Information on Reverse)
For domestic delivery information, visit our website at www.usps.com®

Due to limited transportation availability as a result of nationwide COVID-19 impacts package delivery times may be extended. Priority Mail Express® service will not change.

In a hurry? Self-service kiosks offer quick and easy check-out. Any Retail Associate can show you how.

Save this receipt as evidence of postage. For information on filing a claim go to www.usps.com/claim

2022-011769 MISC
09/26/2022 09:35:27 PM
Rec Fee: \$39.00
Clerk: James Hill
City: Apache Junction, AZ
Recorder: Sadie Jo Bingham



Completed by the office of origin. (A remplir par le bureau d'origine.)	Item Description (Nature de l'envoi) <input type="checkbox"/> Registered Article (Envoi recommandé) <input type="checkbox"/> Insured Parcel (Colis avec valeur déclarée)	<input checked="" type="checkbox"/> Letter (Lettre) <input type="checkbox"/> Printed Matter (Imprimé) <input type="checkbox"/> Other (Autre)	<input type="checkbox"/> Recorded Delivery (Envoi à livraison attestée) <input type="checkbox"/> Express Mail International
	Office of Mailing (Bureau de dépôt) APACHE JCT AZ	Insured Value (Valeur déclarée)	Article Number RE 322 387 576 US
Completed at destination. (A compléter à destination.)	Addresssee Name or Firm (Nom ou raison sociale du destinataire) JORGE-MARIO BERGOGLIO	Date of Posting (Date de dépôt) 07-24-2020	Postmark of the office of destination (Timbre du bureau de destination)
	Street and No. (Rue et No.) APOSTOLIC PALACE	Signature of Addressee (Signature du destinataire)	
	Place and Country (Localité et pays) 00120 VATICAN CITY	Office of Destination Employee Signature (Signature de l'agent du bureau de destination)	

PS Form 2865, February 1997 (Reverse)

1 From:
2 Darrell-James: Hill¹ -Negro-Ysrael², -:Ohioan-©-1958 A.D.³, -:civilian⁴,
3 -:Executor⁵ -:beneficiary⁶, :Ambassador⁷,
4 PO Box 3806, Apache Junction, Arizona 85117

5
6 :i- man⁸ -:present,
7
8
9

10
11
12 :The united States of America, 'uSofA'
13
14

15 Arizona state
16 Pinal county
17

18 :Special- Presentment, ~Book⁹

19 **A.**

20 **:i- man- :ambassador- of the Almighty-God give you :Notice:**

21 'Repent, change and turn to God-Almighty, be deceived no more.

22 **Let my people go¹⁰.**

23 KJV- Book: Proverbs chap 1¹¹; Malachi chap 3¹²;

24 Deuteronomy chap 27 v 9-26¹³; Colossians chap 4 v 1-6¹⁴;

25 Shalom¹⁵.
26

27 To: Donald-John, -:POTUSA-CIC¹⁶, -POTUScorp¹⁷- Trustee^{18, 19}

28 c/o :Donald-John: Trump²⁰ :USPS RMN RE 322 387 562 US

29 1600 Pennsylvania Ave NW

30 Washington, District of Columbia 20500

B.

Introduction

:i- man- Darrell-James: Hill -Negro-Ysrael, -:Ohioan-©-1958 A.D., -:civilian, -:Executor
-:beneficiary, :Ambassador am biological-progeny^{21, 22}, of the people of Ysrael-Israel of the
Most-High-God whose Son is the Messiah-Yushuah of the House-of-Judah from which :i- man
-exercise in this life; **not a member of the Synagogues of Satan²³.**

The topics of this document are simple, that :in '-B#1: Affidavit of :Distress', below, are



the declarations that :i- man have been-forced-made to endure damage-imposed by the Trustee-actor- Derelicts to the a) Concession-of-1213 A.D.²⁴ with the Roman-Church, et al²⁵, and b) Declaration of Independence of 1776 A.D.²⁶ of the uSofA²⁷- people. :Both Trust-covenants²⁸ distinguish that :i- man -progeny- beneficiary am the express- focus-beneficiary of the cestui-que-vie (life) -Trust-covenants: Concession-of-1213-A.D., and Declaration-of-Independence-of-1776-A.D.

Very much harm²⁹ is been done by the Trustees, and much property is been stolen³⁰ by the Trustees by the use of the doctrine³¹ of :paternalism³² and enslavement³³ characterized by satanism³⁴ with :profound-damage against the people-abused, even the children-of-Jacob-Ysrael, et al.- :i- man, Negro-Ysrael- people-beneficiaries and subjects of every covenant with the Most-High-God and His -ONLY- Begotten -Son, the :Messiah-Yushuah.

:The -deprivation³⁵ of the :unalienable³⁶-rights-damages of :i- man- Darrell-James are continued in the violations of the Fiduciary-Duty-and-Obligation by the Trustee- Derelicts³⁷ imposing insidious³⁸- paternalism-socialism and enslavement practices against :God's- chosen-people, i.e., Negro-Ysrael, et al., and the Holy-Church.

In place of the Almighty-God-given-unalienable-rights-ordained by the covenants-agreed-to, both: Jorge-Mario³⁹ and Donald-John, -:Trustees, use this insidious -socio-cultural - :paternalism- socialism⁴⁰ to justify any wrong-doing and abet, as socially-acceptable, the 'ends-justify-the-means' -doctrine of :any-harms against the covenant-goals of :Almighty-God after the damage upon the Negro-Ysrael- beneficiary, et al.- :i- man.

This anti-covenant-cultural-despise against the Negro-Ysrael, et al., is a sickness with the social-cultural- immorality; the doctrine of Baalim in the uSofA, where the main feature of this practice is theft-of-property -claimed and possessed⁴¹,⁴²: both the unalienable-Almighty-God-given-rights to life, liberty and property, and, specifically, :all -property. – See: Attachment C and D.

By these actions are trustee-derelicts mere thieves, daily creating harm and damage upon :i- man- beneficiary. See: :in - B#1: 'Affidavit of Distress' and B#2, the declaration of the claim, and demand for the restoration of the property-claimed and possessed that has been/is stolen by the Trustee-derelicts. In fact:

The :Trustee-derelicts have stolen very-much-property ~see B#2~ -:in the greater-than twenty-dollars U.S.-money :In-specie 'of ounces of gold and silver' -belonging to :Negro-Ysrael, et al.- e.g. from -:i- man- beneficiary. AND, for :i- man to merely begin to knowledgeably-righteously-question-to-correct this wrong-doing as is herein done, :i- man must now have-need of personal body-protection twenty-four (24) hours per day for the completion of the Almighty-God's :will-be-done by :i- man, the -simple-Almighty-God -:Ambassador -man.

Notice: Danger :i- man am now-, as of this signing, ever- more-so UNDER the THREAT from the :Derelict-Trustees -:Roman-Church and the uSofA- Constitutional- government for they love money and power, and have/do condone and/or corroborate the :deprivation/theft of the Concession-1213-A.D. and Declaration-1776-A.D.- covenant-rights, et seq., at this signing with diffuse- multi-variant harms determined upon :i- man, et al.- Negro-Ysrael, children of Jacob-Ysrael, et al., and the Holy-Church.



B#1 :Affidavit of :Distress⁴³

:Affiant -:i- man- :Darrell-James: Hill, -:Negro-Ysrael, -:Ohioan-©-1958-A.D., -:civilian, -:Executor -:beneficiary of the a) inherent-trust from the Law of :Almighty-God⁴⁴ where nothing stands between the :Almighty-God and :i- man⁴⁵, b) :Almighty-God given-lineage-covenants⁴⁶ and rights to life, liberty and property, and c) "New Deal of 1933 A.D.", i.e., the :Emergency-Banking-Act of 1933 -Legislative-Dry-Trust.

- 1) :i- man affirm and declare the shame of the uSofA-government- services -providers' ~POTUSA-CIC and POTUS-corp-Trustees, et al.- Barack-Hussein⁴⁷ and Donald-John, et seq.~ direct inhibition without-right of the ready capacity for :i- man to freely donate the private-resources of :i- man to community, family, church-services, open election of the public-officials, and philanthropy-agape. Furthermore:
- 2) :transportation and general service vehicles of :i- man remain unrepaired;
- 3) the :continued-wrong-doing against :i- man is not suffered, and increased: ignored by the Trustee, et al.-dereliction, with :violation of the fiduciary duty and obligation to: protect, Not-compete, and not-thieve the :property-claimed and possessed by :i- man- beneficiary,
- 4) :Trustees, et al., have corroborated :in-theft of the EBA-1933-2003-A.D.⁴⁸ -legislative-dry-trust and property from: i-man- beneficiary while agreeing to the contracts by tacit-acquiescence with tacit-procuration⁴⁹; approving :all-rights -exercised, the Trustees, et al.; have stolen the property with :No-receipt-given, and No-correspondence to assure the :unalienable-rights to life, liberty and property-claim and possessed by :i- man; i.e., no lawfully or legal, nor personal- :i- man authority! Moreover,
- 5) the :continued-violation of the right of life, liberty and property-claimed and possessed :daily-damages -:i- man's-unalienable-rights and devolvement into the forced-benefit under the :paternalism of the involuntary servitude modi-operandii but they are basically thieves because they have basically stolen the unalienable-rights-given-from-God-Almighty for :i- man to exercise rights and access needs: dental care, visual, general-medical, change, shelter-quality, common-comfort-needs, decreased-ability to help the widow and the orphan, and the infirmed.
- 6) :This- entirety is wrong-doing, trespass and determinable upon :you- Donald-John, and to :all-else whosoever can see and hear. -See below: B#2. To wit:
- 7) :i- man wish/require/demand :all of the property-claimed and possessed, contracts-agreed thereto, and the :EBA-1933-2003-A.D.- account-reports, settlement and closure of the cestui-que-vie -legislative-dry-trust -property restored-now, post haste, to :i- man: :Darrell-James: Hill, -:Negro-Ysrael, -:Ohioan-©-1958-A.D., -:civilian, -:Executor -:beneficiary. --
- 8) That, either :you-man -Donald-John, et al., by :your -Trustee-Dereliction and violation of the fiduciary-duty and obligation, or :you by :your- integrity without

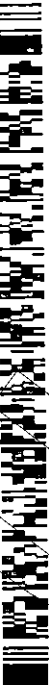

Specialty Presentment: USPS RMN RE 322 387 562 US To: Donald-John, -:Trump – Trustee
Fore Theft of Covenant Property: unalienable-Rights-From-God-Almighty -:Covenant
For :Restoration of: intangible and tangible stolen-property with remedy to:
:Darrell-James: Hill, -:Negro-Ysrael, -:Ohioan-©-1958-A.D., -:civilian, -:Executor -:beneficiary, -:Ambassador,
4 / 62

Dishonor.

B#2 Declaration of :Claim and Demand for the Restoration of the Property-claimed and Possessed and stolen by Trustee- Dereliction and Violation of the Fiduciary-Duty and Obligation.

:Express- CLAIM FOR THE Restoration⁵⁰ Of :STOLEN⁵¹-PROPERTY- Claimed and possessed By :i- man for :In -Common-Law With :Equitable -:Remedy And Recourse⁵² In :Accordance With The Prevailing Contract-Agreements⁵³ With :you- man -:Donald-John: Trump, et al.- Barack-Hussein, ~:POTUSA-CIC, -:POTUS-corp -:Trustee – Emergency-Banking-Act of 1933 A.D., 'EBA-1933-2003-A.D.~, as relates to :i- man -Darrell-James: Hill, -Negro-Ysrael -:Executor- beneficiary of the - :unalienable-law⁵⁴ to the unalienable-Almighty-God-given- rights⁵⁵~
:Torah- KJV, et al.⁵⁶, - :Concession-1213-A.D., - :DOI-1776-A.D. ^{57, 58, 59, 60, 61, 62} ~, and,

:birth-location-law⁶³ ~
:TheCftUSofA-1789-1791-A.D. ^{64, 65} with: BOR-1791-A.D. ⁶⁶, :The Concession-1213- A.D.- TheCftUSofA-1789-1791-A.D. -nexus⁶⁷ with the :ACW-1861-1865-A.D. ^{68, 69} and :EP-1863-A.D. ^{70, 71, 72, 73, 74} with the Lieber-Code-1863-A.D. ⁷⁵
~, and,

:legislative-indenture Law⁷⁶ ~:FRA-1913-A.D.⁷⁷, :EBA-1933-2003-A.D.^{78, 79, 80}, ^{81, 82} with the :TWEA-1917-A.D.⁸³, amended⁸⁴ within the EBA-1933-2003-A.D., and :National Emergency Act of 1976 A.D., NEA-1976-A.D.⁸⁵~

See: 'For the Cure and Relief⁸⁶ -in the :Perfect-Equity-Claim⁸⁷, and For the Remedy-Required For the Trespassing Upon The Children of Ysrael/Israel, et seq.⁸⁸ ~:Trustee- Fraud ^{89, 90, 91}, Dereliction^{92, 93, 94} and Deception⁹⁵ on the uSofA- people- beneficiaries:^{96, 97}~; To:Jorge-Mario: Bergoglio⁹⁸ :USPS RMN RE 322 387 576 US; c/o Apostolic Palace, 00120 Vatican City^{99, 100}, c/o :Donald-John :CIC- :Trump^{101, 102} :USPS RMN RE 322 387 562 US; 1600 Pennsylvania Ave NW, Washington, District of Columbia 20500; appended: 7 pages; -: ATTACHMENT B: -wholly-Incorporated by-this-reference¹⁰³.

a) :Satan's Role¹⁰⁴: Danger¹⁰⁵ of More Harm^{106 107 108 109 110 111 112 113 114 115} From The :Roman-Church¹¹⁶;

b) :Demand: Cease Roman-Church- Trustee Danger, :Demand: Cease :Roman-Church and POTUS-corp -anti-Negro-Ysrael, et al.- :i- man,

From: Darrell-James, :Specialty Presentment: USPS RMN RE 322 387 562 US
To: Donald- John, :Civilian -Exercise :Unalienable-Rights-From-God-Almighty -:Covenant 4 / 62

2022-011769 MISC Page: 1604 of 2782
09/26/2022 03:35:47 PM Receipt #: 22-9381
Rec Fee: \$30.00 Darrell James Hill
Gila County, Az, Sadie Jo Bingham, Recorder



activity ¹¹⁷
c) :PROPERTY-CLAIMED by :i- man sole, et al.¹¹⁸ due restored from
Roman-Church- Trustee-actor- Dereliction to the beneficiary private
possession and use.

Line# 31 Greetings
116 A :IDENTIFY, 'ID', – :i- man- beneficiary- Darrell-James: Hill
251 B :ID – :Trustee -:man - Donald-John: Trump
379 C :ID – :Property Claimed and Possessed by :i- man -Darrell-James: Hill
523 D :ID – :Trustee has stolen :i- man's -:Property-Claimed and Possessed
703 E :ID – :i- man Now-Wishes Property-Claimed and Possessed -Restored

31 Greetings :Donald-John: Trump:
32
33 :i- man pray for the safety for :you and family.
34
35

36 Purpose: Address the Theft from :i- man, et al.

37 G1 This report is the address of the theft from :i- man by :you-man- :Donald-John- Trump,
38 acting as the :POTUSA-CIC, et al. -POTUScorp- Trustee, with the understanding¹¹⁹ of the :DOI-
39 1776-A.D., which over-stands¹²⁰ the :TheCftUSofA-1789-1791-A.D., et seq.- EP-1863-A.D. laws;
40 and, with :you-man, -:POTUSA-CIC over-standing the :POTUS-corp, et al.-Trustee of the :EBA-
41 1933-2003-A.D.- Legislative-Dry-Trust.

42 G2 :i- man believe and declare that this Specialty- Presentment to you: Donald-John,
43 -:POTUSA-CIC, -:Trustee -:Trump enables :you-to-be-made-aware¹²¹ that by :you- man with
44 :Trustee-dereliction, or by you-man through :Trustee-actors -otherwise, :your- derived-authority
45 is Not for the thieving of the property- claimed and possessed by :i- man -beneficiary. :These-
46 actions present to be :wrong-doings against :i- man that :daily-causes -harm to :i-man and fami
47 by the forced-deprivation-actions against the :private :life, liberty and property¹²² tantamount¹²³
48 the enslavement-methods upon :Negro-Ysrael, et al.- :i- man -Darrell-James: Hill, progeny.

49 G3 Can you see it, hidden in the plain view?

50 G4 Fraud vitiates: i.e., the reason why.MAGA or KAG cannot be attained without the
51 absolute reversal of the slavery-system on the people in this nation is Not about your capability,
52 but, rather, is about the wide-open :demonic-spiritual-doors enabling evil access to enter and
53 destroy this nation at-will as though :you are enslaved¹²⁴. Call upon the :Almighty-God to
54 close the :open-doors, and you will see, e.g.:

55 G5 The CCP -imperialism will overtake the uSofA (et al.) unless :you- Donald-John, the
56 man of righteousness, can get that door closed. Let the people go; no more of this-type

1594
From: Darrell-James, :Specialty Presentment: USPS RMN RE 322 387 562 US
To: Donald- John, :Civilian -Exercise :Unalienable-Rights-From-God-Almighty -:Covenant 5 / 6

2022-011769 MISC Page: 1605 of 2782

09/26/2022 09:35:37 PM Receipt #: 22-9381
Rec Fee: \$30.00 Darrell James Hill
Gila County, Az, Sadie Jo Bingham, Recorder



Specialty Presentment: USPS RMN RE 322 387 562 US To: Donald-John, -Trump - Trustee
Fore Theft of Covenant Property: unalienable-Rights-From-God-Almighty -Covenant
For :Restoration of: intangible and tangible stolen-property with remedy to:
:Darrell-James: Hill, -:Negro-Ysrael, -:Ohioan-@-1958-A.D., -:civilian, -:Executor -:beneficiary, -:Ambassador,
6 / 62

57 document against a regime of paternalistic-deprivation of the unalienable-God-Almighty-given-
58 rights against Negro-Ysrael, et al. -:i- man -progeny, the one-group in :all of the world to Not
59 enslave has been enslaved by the uSofA- people. How did this happen? Ans.--
60 G6 The ROMAN-CHURCH-TRUSTEE-Derelict-to the Concession-1213-A.D.-covenant¹²⁵, et
61 al., did this in the 17th century when the uSofA- nation was being developed. Some of the
62 :revered- figures of the 'forefathers' were :B.A.R.¹²⁶-wicked-man-kind- representatives of the
63 United-States-of-America-1776-1789 A.D. -:DOI-1776-A.D.-TheCftUSofA-1789-A.D. Some five
64 hundred and seventy-plus (570+) recent years from the Concession-1213-A.D. then of the near
65 two-thousand (2000) years now since Rome executed the :Messiah-Yushuah, and :other-
66 **members of the Holy-Church**¹²⁷ to please Satanists, demonists, and anti-Messiahs. The
67 Roman-Church is literally the habitation of :Satan, and there is no such thing as the 'vicar of
68 Christ' pertaining to the Messiah-Yushuah and the Most-High-God in Heaven.

69 G7 B.A.R. -people ultimately work-:under-the-pain-of-death for the Crown-Temple who,
70 under the Concession-1213-A.D., et seq.-contracts in -common -law, work for the Roman-
71 Church-Trustee-Derelict of the Concession-1213-A.D. since of 1213-1789 A.D.¹²⁸ - to now.

72 G8 **The :Messiah Answers :Whosoever Seeks :Him**
73 :Yushuah the :Messiah's work and death-price created the 'Holy-Church', first with the
74 House-of-Judah¹²⁹- Ysrael , and for whosoever -:in -spirit and truth¹³⁰ will seek the Most-High-
75 God through :His -son- Yushuah the Messiah.

76 **:Grievance**

77 G9 Over the last 4 years, starting in the fall of :2016 A.D., three (3)- Serial -Specialty-
78 Presentments were sent with USPS-Registered-Mail-delivery-verification to you: Donald-John,
79 et al.- Barack-Hussein, for to obtain property-claimed and possessed by :i- man, :STOLEN-3 of
80 3-property¹³¹, et al.-contracts¹³², and, to obtain access to the :account- information of the 'cestui-
81 que-vie-trust'¹³³ -:EBA-1933-2003-A.D.- FRA-1913-A.D. -:STOLEN-FRA-property¹³⁴, and, finally,
82 to obtain the account-reports for the absolute-settle and closure of the EBA-1933-2003-A.D.-
83 Trust-property-claimed, possessed and appears to be stolen by the Trustee.

84 G10 :This-grievance is for the mitigation¹³⁵ of the damages, for the stopping of the harm
85 from your stealing and/or holding the property of :i- man without-right¹³⁶.

86 G11 No continued present harm to the children-of-Jacob- et al.- Negro-Ysrael for :Satan in
87 this nation and world will change the facts or history. Satan is already judged and condemned by
88 the :Most-High-God! And, his actions and influences¹³⁷ are in defiance of his judgment, and only
89 to entrap :man-kind for harm.

90 G12 **Mitigation** is for to lessen the :“loss-of-use-damages” -endured by :i- man under the
91 prevailing-contract- agreements as normally required under the conditions of the Trustee-
92 Dereliction and Violation of the Fiduciary-duty and obligation, et al.-Notarial-Dishonor.

93 :All- Property is claimed and possessed by :i- man:

- 94 1) :Unalienable-Rights¹³⁸ of :PROPERTY-CLAIMED and possessed: a) 'unalienable-rights'
95 of the Unalienable-Law, of Almighty-God¹³⁹ into the covenants:Concession-1213-A.D,
96 DOI-1776-A.D. (of :TheCftUSofA-1789-1791, as amended: EP-1863-A.D.)^{140, 141, 142},
- 97 2) :three-lots of property-claimed and possessed and contracts-agreed thereto,
- 98 3) :state-national-trust, -:EBA-1933-2003-A.D.- Legislative-Dry-Trust¹⁴³, for :i- man, - for the
99 Accounts-Reports, and :settle-and-closure upon the return of the debenture-bond-



Specialty Presentment: USPS RMN RE 322 387 562 US To: Donald-John, -:Trump – Trustee
Fore Theft of Covenant Property: unalienable-Rights-From-God-Almighty -:Covenant
For :Restoration of: intangible and tangible stolen-property with remedy to:
:Darrell-James: Hill, -:Negro-Ysrael, -:Ohioan-©-1958-A.D., -:civilian, -:Executor -:beneficiary, -:Ambassador,
7 / 62

100
101
102
103
104
105
106
107
108
109
110
111
112
113
114
115

-'certificate of live birth' with the explicit instructions to :you- POTUScorp- Trustee,
-:Trump for the account, settle and closure of the ':United States' corp': :government-
services-provider -:Trustee -:EBA-1933-2003-A.D. - legislative, -dry-trust-indenture,
completed on May 18th, 2020 A.D. See: Attachment E, Item 1;

- 4) OPEN or CLOSED, the 'cestui-que-use' of the 'cestui-que-vie- trust-property-benefit'
must Not be hidden/ stolen-property any longer. :-i- man's Specialty-presentments to the
FRB have been: a) compliant with the EBA-1933-2003-A.D. requirements to obtain
'cestui-que-use' via the FRA-1901-A.D., and :b) have been tacitly- acquiesced with tacit
procuration, and c) stolen-property by modi operandii.
- 5) :POTUSA-CIC -Trustee Dereliction is Not Acceptable: – :-i- man believe and declare that
it is the oath, duty and obligation¹⁴⁴ that the CIC~POTUSA -:Trump understands the :EP-
1863- A.D. which understands :TheCftUSofA-1789-1791-A.D. which understands the
:DOI-1789 A.D., which understands the Concession-1213-A.D. which understands the
Torah-KJV-bible -:beneficiary -:Darrell-James: Hill, et al. Negro-Ysrael, et al. -Executor-
beneficiary.

116

A: i- man- beneficiary- Darrell-James: Hill

117

:CLAIMS and STANDING

118

119

120

Assignment by :Almighty-God

121

A1 :-i- man's -assignment during this writing is: KJV-Book: Proverbs chap 31 v 8- 9.

122

123

124

125

KJV-Book: Proverbs chap 31:8 Open thy mouth for the dumb in the cause of all
such as are appointed to destruction. 9 Open thy mouth, judge righteously, and plead
the cause of the poor and needy

126

127

**A2 POLITICAL ELECTION IS SET¹⁴⁵ AND RECORDED INTO THE PUBLIC-RECORD BY
EXECUTOR- BENEFICIARY -Darrell-James: Hill -man, -Negro-Ysrael, -:Darrell-James: Hill,
-beneficiary, -:Ohioan-©-1958-A.D., :civilian -beneficiary**

128

129

130

131

:Beneficiary- Appointed :EXECUTOR- :man - Darrell-James: Hill

132

133

134

A3 :-i- man- beneficiary, et al. appointed the :man- Darrell-James: Hill as the Executor for the
beneficiary: Darrell-James: Hill~self~, ':Executor- beneficiary'. – See: **Constructive Notice Of
The Setting Of Presumptions**¹⁴⁶.

135

136

137

138

**A4 :Messiah-Yushuah who created us, came and died for us, and rose to life by His
Father's will being done, Is The Kinsman-Redeemer Of Negro-Ysrael, et al.- :i- man And
The Holy-Church.**

139

140

141

A5 :-i- man believe and declare that :Yushuah~Jesus~the Messiah is the :kinsman-
redeemer of the :Negro-Ysrael- people and the Holy-Church :in-the-lineage-covenants of
:Concession-1213-A.D. – :DOI-1776-A.D., et seq.

From: Darrell-James, :Specialty Presentment: USPS RMN RE 322 387 562 US
To: Donald- John, :Civilian -Exercise :Unalienable-Rights-From-God-Almighty -:Covenant 7 / 62

1596

Specialty Presentment: USPS RMN RE 322 3
Fore Theft of Covenant Property: unalienable-Rights-From-God-Almighty -Covenant
For :Restoration of: intangible and tangible stolen-property with remedy to:
:Darrell-James: Hill, -:Negro-Ysrael, -:Ohioan-©-1958-A.D., -:civilian, -:Executor -:beneficiary, -:Ambassador,
8 / 62

142
143
144
145
146
147
148
149
150
151
152
153
154
155
156
157
158
159
160
161
162
163
164
165
166
167
168
169
170
171
172
173
174
175
176
177
178
179
180
181
182
183
184

The Concession-1213-A.D. – :DOI-1776-A.D. Alignment

A6 :i- man believe and declare that the :DOI-1776-A.D. -covenanted -unalienable- rights beneficiary is the :Negro-Ysrael- :Concession-1213-A.D.- DOI-1776-A.D. -covenant- people, et al.- :i- man.

United Colonies of 1776 A.D. with Concession-1213-A.D. - :Anti-Ysraelism - :Anti-Messiahism- polytheism-pantheism-Non-Christian- Roman-Church-Trustee -philosophy.

A7 :i- man believe and declare that the uSofA-1776-A.D. corroboration of the 'Concession-1213 -A.D. – :TheCftUSofA-1789-1791- A.D.- unalienable-right -fraud in the uSofA- land and the world by the Trustee- Dereliction is with the violation of the fiduciary- duty and obligations to the Negro-Ysrael/-:Children of Jacob/Ysrael by the inalienable Law of the lineage-covenants by the Almighty-God -covenanter

Enslavement of Negro-Ysrael/ Children-of-Jacob/Ysrael is the oxymoronic- dissociative- behavior for the United-Colonies and united States of America- Christian- Nation of 1776 A.D., et al. - Roman-Church- Trustee, 1213- 1776 A.D.

A8 :i- man believe and declare that the united States of America are of the Judah-Christian -national heritage of the Messiah-Yushuah from the tribes of :Ysrael. :Yushuah the :Messiah's atoning-sacrifice is :FOREVER and done from the Negro-JUDAH-Ysrael- Christian -Forefathers who are also the same Negro-Ysrael- people that the uSofA professionally -despised/despises with the policies of the social-institutions imprisoning the :uSofA- people.

:TheCftUSofA-1789-1791- A.D. -deprivation of :unalienable- :Almighty-God-given- rights

A9 :i- man believe and declare that :TheCftUSofA-1789-A.D.-Wrong-Doing upon the Negro-Ysrael- people is with the uSofA-people and representatives acceptance of the 'Concession-1213 -A.D.- fraud by the Roman-Church -Trustee -:Dereliction and willful deception to corroborate harm upon the Children of Jacob/ Ysrael, and to undermine the enslaving nations.

ACW-1861-1865-A.D to the EP-1863-A.D.

A10 The ACW-1861-1865-A.D. was the big-deal "doctrine-of-Baalim/ Hegelian-dialectic for to obtain :economic-supremacy of the wealthy-southern-slave states. By this targeted eradication of the violation of the unalienable-rights of the Negro-Ysrael, the POTUSA-CIC during the :ACW-1861-1865-A.D.- era forced a default upon the wealthy-southern-slave-states upon POTUSA -:Lincoln's -Emancipation-Proclamation-of-1863-A.D., to stop the secession by threatening the unjust-gain brought by the enslavement and paternalism against Negro-Ysrael.

The :Paternalism and Dishonor Imprint of :Enslavement

A11 The :Imprint of :Slavery¹⁴⁷ by the POTUSA- CIC, – :POTUS-Trustee is delineated by the :General Order 100 of 1863 A.D., ~Lieber-Code, 'Lieber-Code-1863-A.D.~', and :TWEA-1917-A.D., as amended¹⁴⁸, et seq.-ICCPR-et al.-:TheCftUSofA, et seq.

A12 :i- man accept and declare that the POTUS and POTUSA :in-silent- agreement of the :three (3) - lots of :property-claimed and possessed by :i- man with the :three -:specialty-

1597



Specialty Presentment: USPS RMN RE 322 387 562 US To: Donald-John, -Trump -Trustee

Fore Theft of Covenant Property: unalienable-Rights-From-God-Almighty -Covenant

For :Restoration of: intangible and tangible stolen-property with remedy to:

:Darrell-James: Hill, -:Negro-Ysrael, -:Ohioan-©-1958-A.D., -:civilian, -:Executor -:beneficiary, -:Ambassador,

9 / 62

185 presentments by the Notary-Public -:Specialty- Presentment regarding the three (3) - lots of
186 :property-claimed by :i- man to the man- Trustee, -:POTUSA - :POTUS, are in the status of:
187 Notarial- Dishonor.

188
189

OATHS:

190 **Purgatory Oath: EBA-1933-2003-A.D. Legislative-Dry-Trust**

191 A13 :i- man- civilian, beneficiary, -:Executor affirm and declare that at the ending of the EBA-
192 1933-2003-A.D.-Trust ~:FDR's "New-Deal," -:Surety for the United-States-corp- bankruptcy of:
193 2003- 2013 A.D.~ :i- man did not know, and was not informed by the U.S.-corp-Trustee, et al.,
194 that the EBA-1933-2003-A.D.- Legislative-Trust became completed in its purpose, and thereto
195 was ended as the 'dry-trust,' - subject-to-account, settle-and closure by the beneficiary, -:i- man.

196

197 **Purgatory Oath: 59-1/2 -year -account, Settle-And-Closure Of The EBA-1933-2003-A.D.**
198 **-cestui-que-vie- Trust Unto The Private -Self-Management.**

199 A14 :i- man -civilian, -beneficiary, -:Executor affirm and declare that :i- man did not
200 comprehend to know, and was not informed by the man-Trustee, et al., that :i- man -beneficiary
201 at the age-count -of :59-1/2 -years, was/am to request/require/demand the EBA-1933-2003-
202 A.D.:accounts for the :settle and closure of the EBA-1933-2003-A.D. -Legislative- Dry- Trust
203 unto the self-private -management by the mature and of sound-mind of :i- man- :beneficiary-
204 Executor: of Darrell-James: Hill, -Negro- Ohioan-©-1958-A.D., or other- disposition/
205 management.

206

207 **A15 NOTICE: DANGER FROM THE POTUSA-CIC - POTUS-AGENTS OR PROXIES, et**
208 **al.- Deep State- elements, FOR DEPRIVATION OF :UNALIENABLE-RIGHTS AGAINST** :i-

209 man- beneficiary for speaking of the truth and accultured- racism and paternalism unto wanton
210 harms and/or murder of people, and for establishing the Political-election of: Darrell-James: Hill,
211 et al., -:beneficiary- :Executor.

212

213 **U.S.-corp- Trustee- :COINTELPRO -AND Socio-Cultural -PROPAGANDA**

214 A16 :i- man -:Darrell-James: Hill, -:Negro-Ysrael, -:civilian and sixty-year-old -:elderly- man
215 was and am still-yet opportunistically hunted by :subordinate- Trustee- actor's accultured to
216 wantonly threaten :anti-Negro-Ysrael -imminent-harm and 'Cointelpro -and socio-cultural
217 -propaganda' -policies of :despise and harm -policing now-normalized in the minds of the
218 :majority of :Americans and the world citizens. It is a subversion but the experience is like the
219 'death by the thousand-cuts' upon a wronged-people suffering this PTSD-LEVEL-SERIOUS-
220 DEVASTATION for :four-centuries.

221

222 **Truth or the Annihilation Upon the uSofA- Chosing Judgment**

223 A17 (:i- man believe and declare that today-2020 A.D. to halt the paternalism and
224 :insidious-'soft-slavery' there can be a judgment as the :ACW-1861-1865-A.D. of the uSofA by
225 the truth OR by the new imperial-globalists who will enslave and brutalize the uSofA- land-mass
226 and population. **Let us hope for the truth.**

227

From: Darrell-James, :Specialty Presentment: USPS RMN RE 322 387 562 US

To: Donald- John, :Civilian -Exercise :Unalienable-Rights-From-God-Almighty -:Covenant 9 / 62

1598



Specialty Presentment: USPS RMN RE 322 387 562 US To: Donald-John, -Trump- Trustee
Fore Theft of Covenant Property: unalienable-Rights-From-God-Almighty -Covenant
For :Restoration of: intangible and tangible stolen-property with remedy to:
:Darrell-James: Hill, -:Negro-Ysrael, -:Ohioan-©-1958-A.D., -:civilian, -:Executor -:beneficiary, -:Ambassador,
10 / 62

228 **The Fifth (5th) Column of the CCP**

229 A18 The coming-aggressors are here (5th column) and they know the history; they know
230 about the big-demonic four-hundred- year-wide-open-door about the :Negro-Ysrael -people and
231 they support your pride to feel superior because you can only stop them by :dealing-with the
232 faux-pride and closing the :door of the curse that comes, i.e. by serious-change: KJV-Book:
233 Deuteronomy chap 28. Can you see this? The Chinese believe in :God-Almighty; the CCP
234 knows :this vulnerability.

235
236 **SURVIVAL- :NEEDS MEET WITH :PROPERTY-CLAIMED AND POSSESSED BY :i- man.**

237 A19 :i- man, :civilian, -:Executive- :beneficiary believe that this document is to :you-man
238 -:Donald-John: Trump- :Trustee, -:POTUSA/CIC, -:POTUS-Corp- Trustee with the statements of
239 survival-needs meets the finale requirements possible to be met For-The Lawful and Legal
240 Release of :All- :Property and Claimed-Property-:Demanded by the :i- man -:Executive-
241 :beneficiary of-and for: Darrell-James: Hill, -:Ohioan-©-1958-A.D., -:Executor- beneficiary of:

- 242 1) the God-Almighty-law- given -inherent- unalienable Rights;
- 243 2) :Earth-man- :Ohioan-©-1958-A.D. -line-rights-of--embodiment – Negro-Ysrael, -:son of
- 244 Adam, -:son of Jacob/Ysrael, son of Clarence;
- 245 3) The United States of America- 1862- 1863 A.D. -:Emancipation Proclamation,
- 246 4) :Declaration of Independence of 1776 A.D.,
- 247 5) The Concession of England and Ireland to :Almighty-God and et al, -:Holy-Church by
- 248 :King-John-I, of 1213 A.D., and:
- 249 6) the God-Almighty- given Torah, et seq.- KJV Bible -inherent- unalienable rights:
- 250 -Children-of-Jacob/Ysrael/Jehovah- :Almighty-God.
- 251

252 **B: Trustee -:man - Donald-John: Trump**

253 **Notice To The Principal Is Always Notice To The Agent;**
254 **Notice to the Agent Must be Made Noticed to the Principal**

255
256
257 B1 :i- man -beneficiary, -:Executor believe that :this Specialty- Presentment of :Claims-
258 Document with the merely-stated-harms- present and endured, with the claims-in-requests for
259 the property-claimed and possessed for the remedy in the restoration of the property-claimed
260 and possessed, and for the recourse -due in the :common -law and equity-claim for :i- man, is
261 the quintessential-goal -accomplished HEREIN- Now-after.

262
263 **:You -man- Trustee -:Trump, -POTUSA- CIC, -:POTUS- :EBA-1933-2003-A.D. -Trustee**
264 **POTUSA:**

265 B2 :i- man believe that :you- man-:Donald-John, -:POTUSA- CIC; -:Trump are the Trustee
266 for the man :Darrell-James: Hill, -:Ohioan-©-1958-A.D., under :TheftUSofA-1789-A.D.¹⁴⁹, -:DOI-
267 1776-A.D.-:covenant with :Almighty-God.
268

From: Darrell-James, :Specialty Presentment: USPS RMN RE 322 387 562 US
To: Donald- John, :Civilian -Exercise :Unalienable-Rights-From-God-Almighty -Covenant 10 / 62

1599



Specialty Presentment: USPS RMN RE 322 387

Fore Theft of Covenant Property: unalienable-Rights-From-God-Almighty -Covenant

For :Restoration of: intangible and tangible stolen-property with remedy to:

:Darrell-James: Hill, -:Negro-Ysrael, -:Ohioan-©-1958-A.D., -:civilian, -:Executor -:beneficiary, -:Ambassador,

11 / 62

269 **:Donald-John: Trump, -:TRUSTEE-NOTARIAL- :PROTEST AND -:DISHONOR**
 270 **B3** :i- man declare that :i- man presented solely, and then subsequently with the Notarial-
 271 Protest unto :Notarial-Dishonor, :specialty-presentments delivered specifically to :you- man,
 272 -:Donald-John: Trump, -:Trustee-in-Notarial-dishonor, requesting, etc.- communicating that :i-
 273 man- :Negro-Ysrael, -:civilian, -Ohioan-©-1958-A.D., :Executor- beneficiary have made and
 274 publicized the political-election that set the (:your) presumption to 'i-man, et al.-'Executor-
 275 beneficiary', that :you, et al.- :your agents: **APC¹⁵⁰, USAG¹⁵¹, and CLT¹⁵² -Barr, and SOT¹⁵³**
 276 -:Mnuchin too release :all of the :i- man -:property- claimed and possessed. Thereto:
 277
 278 **:TRUST; AND :SERIAL-COVENANT-BREAKERS**
 279 **:i- man Provided SERIAL ~over 4 years~ -SPECIALTY- PRESENTMENTS to you: Donald-**
 280 **John, et al.**
 281 **B4** :i-man declare that the three (3) Specialty presentment -property-claimed -requests
 282 started in the fall- :2016 A.D. and continue into this signing; beginning with :Barack-Hussein,
 283 -:POTUS-Corp-:Obama and :Loretta, -:*USAG- **APC- ***CLT-:Lynch, et al. to the ****EBA-
 284 **1933-A.D. with *****TWEA-1917-1933-A.D., as amended, and, finally unto :you- Donald-John,**
 285 **-:POTUSA, -:CIC' -:Trump, et al. - :USAG -APC -CLT. -**
 286 *** :United-States-Attorney-General; ** :Alien -Property -Custodian; *** :Common-Law-Trustee;**
 287 ****** :Emergency-Banking-Act of 1933 A.D.; ***** :Trading-With-The-Enemy-Act-of-1917-1933**
 288
 289 **B5 NOTICE: POTUSA-CIC, -Trustee; and: POTUS, - TRUSTEE, -:Trump LIABILITY and**
 290 **Notarial- DISHONOR¹⁵⁴ -**
 291
 292 **:Trustee POTUSA-CIC (common-law-trustee) TO POTUS (commercial-law-obligor of :EBA-**
 293 **1933-2003-A.D.) DECISION TREE**
 294
 295 **B6** :ID - Trustee, :man- :Donald-John, -:Trustee -:POTUSA- CIC, -:Trump over-standing the
 296 :POTUS-Corp, -:government services-provider- :Trustee-indenturer of the EBA-1933-2003-A.D.
 297
 298 **POTUSA-CIC -duty and obligations¹⁵⁵**
 299 **B7** :i- man believe and declare that the **POTUSA-CIC -duty and obligations** are for the
 300 protection of the unalienable-right to life, liberty and property -guaranteed by the critical-
 301 covenants of this nation with the Almighty-God of the Holy -Biblical -KJV over-standing the DOI-
 302 1776-A.D., over-standing: TheCftUSofA-1789-1791-A.D. with the EP-1863-A.D. to FOREVER-
 303 specifically- protect :i- man -:Darrell-James: Hill -Negro-Ysrael, from the normalized- paternalism
 304 -foot-print of the enslavement and dependency -compelled- benefit created from the systematic-
 305 deprivation of life, liberty and property imposed upon :i- man, et al.- uSofA-people.
 306
 307 **POTUSA-CIC UNDER :TheCftUSofA-1789-1791- A.D., 'EP-1863-A.D.- GO-1863-A.D.**
 308 **B8** :i- man believe that as the POTUSA :you- man are the :Commander-In-Chief under
 309 :TheCftUSofA-1789-1791- A.D... understanding the Emancipation Proclamation of 1862-1863-
 310 A.D., 'EP-1863-A.D.', and the General Orders of 1863 A.D., 'GO-1863-A.D.', et seq.
 311

Handwritten mark resembling a stylized 'U' or '1600' in the bottom left corner.



Specialty Presentment: USPS RMN RE 322 387 562 US To: Donald-John, -:Trump - Trustee

Fore Theft of Covenant Property: unalienable-Rights-From-God-Almighty -:Covenant

For :Restoration of: intangible and tangible stolen-property with remedy to:

:Darrell-James: Hill, -:Negro-Ysrael, -:Ohioan-©-1958-A.D., -:civilian, -:Executor -:beneficiary, -:Ambassador,

12 / 62

312 :POTUSA- :CIC, et al., in Accordance with the Lieber-Code-1863-A.D. ARE NOT TO STEAL
313 CIVILIAN, et al.- :i- mans'- PROPERTY UNDER THE COLOR OF LAW OF WAR.

314 B9 :i- man- beneficiary believe that as the :POTUSA- :CIC :you- man are charged with the
315 specific protection of the :i- man- Negro-Ysrael- Ohioan-©-1958-A.D.-beneficiary political
316 -election as :man -mature in years with the sound- mind with :all - :unalienable-rights
317 conspicuously- required to be protected by the EP-1863-A.D to specifically not steal from the
318 Negro-Ysrael- civilian, et al.- :i- man under the color of war or color of law.

319
320 :POTUSA-CIC OVERSTANDS :POTUS-Corp -JOB TO GUARANTEE UNALIENABLE
321 RIGHTS

322 B10 :i- man-civilian- beneficiary believe that it is :your-specific- POTUSA-CIC -duty and
323 obligation to act with the guarantee of the republic-form of :government in the favor of :i-man
324 -civilian- :Executor- beneficiary- Darrell-James: Hill, and to protect the sovereign-core-status
325 of :all- Americans, which includes the :protection of :i- man against the unalienable-Rights
326 encroachment by the 'United' States corp-' government-services-provider- Trustee: EBA-1933-
327 2003-A.D.

328
329 :POTUSA-CIC OVERSTANDS THE uSofA- military

330 B11 The :POTUSA- CIC duty and obligation is common- law and -equity -over-standing of the
331 POTUS-Corp -Trustee for the property -:of the republic-form- of-government to the favor of :i-
332 man -:Darrell-James: Hill, -:Negro-Ysrael -civilian -:Ohioan-©-1958-A.D., -:Executor-
333 beneficiary, for the lawful -restoration of the :three of three (3) lots of :property, -real and chattel -
334 in :specie, that is disposed-to and by unalienable-rights -claimed and possessed by :i- man
335 -:Darrell-James: Hill, -:Negro, -:civilian, -:Ohioan-©-1958-A.D. -:Executor- beneficiary.

336
337 :i- man MUST REQUIRE YOU TO BE LIABLE

338 B12 :i- man must-require :you- man: Donald-John to be held liable for the :willful- wrong-doing
339 and damage endured by :i- man -beneficiary :in-accordance with the prevailing contracts of the
340 specialty presentments for :property-claimed and possessed by :i- man, and, apparently, 'stolen'
341 on :your- orders here-to-fore:

342 a) Where the :Trustee -Dereliction and/or violation of Fiduciary- duty-and-obligation is in
343 question, 'estoppel'¹⁵⁶ -by-laches¹⁵⁷ must may-not- apply.

344 b) The :list of the stolen-property-claimed by :i- man is extensive, as :you- Trustee know or
345 should-have-known; and,

346 c) The :wrongful- :deprivation of the property-claimed by :i- man is the :denial of the
347 unalienable-rights to :life, liberty and property :in-violation of the DOI-1776-A.D., et
348 seq- :TheCftUSofA-1789-1791-A.D., et al.- :EP-1863-A.D. and LIEBER-CODE-1863.A.D.,
349 and the :EBA-1933-2003-A.D. and TWEA-1917-A.D., as amended, and, :above-all, by the
350 :unalienable- law of :Almighty-God.

351 d) This document is to openly establish :your- integrity or Trustee- dereliction with the
352 violations of :your- fiduciary duty and obligation for restoration, remedy and recourse
353 for :i- man -Darrell-James: Hill, -:Executor- beneficiary.

354 (i) :All-property-value-amounts are greater-than twenty dollars- .9999, one-ounce U.S.

From: Darrell-James, :Specialty Presentment: USPS RMN RE 322 387 562 US

To: Donald- John, :Civilian -Exercise :Unalienable-Rights-From-God-Almighty -:Covenant 12 / 62

1601



Specialty Presentment: USPS RMN RE 322 387 562 US To: Donald-John, -:Trump - Trustee
Fore Theft of Covenant Property: unalienable-Rights-From-God-Almighty -:Covenant
For :Restoration of: intangible and tangible stolen-property with remedy to:
:Darrell-James: Hill, -:Negro-Ysrael, -:Ohioan-©-1958-A.D., -:civilian, -:Executor -:beneficiary, -:Ambassador,
13 / 62

355 sliver coin;
356 (ii) please do not create :fame with :Trustee-controversy;
357 (iii) :competition by the Trustee, et al., must is-disallowed; and:
358 (iv) the :contracts- all are under :tacit- procuration by contract-agreement
359 (v) based-:i- the political-election of the:man- Negro-Ysrael, :Ohioan-©-1958-A.D.,
360 -:civilian, -:Executor -:beneficiary -standing.
361
362 B13 :i- man -:civilian -:Executor- beneficiary believe and declare that :You -Donald-John are
363 the :man administratively- :responsible as the POTUS-corp- Trustee of the EBA-1933-2003-
364 A.D., et seq., to protect :i- man's-unalienable-rights, required to be monitored by :you -POTUSA-
365 CIC understanding the DOI-1776-A.D. and acting :in-accordance with the EP-1863-A.D. and
366 Lieber-Code-1863-A.D. :in- protection of :i- man- Negro-Ysrael, -:Ohioan-©-1958-A.D.- civilian,
367 -:Executor -beneficiary.

368
369 **POTUS Understands The Ultimate Authority of the POTUSA-CIC**
370 B14 :i- man Believe That The POTUS- TRUSTEE UNDERSTANDS THE POTUSA- CIC -
371 Identity, :you- man-trustee -:Donald-John: Trump, -POTUS-Corp, -:POTUSA-CIC.

372
373 **:PROPERTY- CONTRACTS: POTUSA-CIC - AND POTUS-Trustee, -:Trump's Silent-**
374 **Agreement-unto-Tacit-Procuration**

375
376 B15 :i- man -:Darrell-James: Hill, -:Negro, -:Ohioan-©-1958-A.D.- civilian- beneficiary,
377 -:Executor believe that the POTUSA- CIC, -:Trump -common- law and -equity -over-standing of
378 the POTUS-Corp -Trustee is for the restoration of the property-claim exercised by :i-
379 man-:Darrell-James: Hill, -:Negro, -:Ohioan-©-1958-A.D.- civilian -:Executor - beneficiary.
380

381 **C: Property Claimed and Possessed**
382 **by :i- man**

383
384 **:PROPERTY- CLAIMED and POSSESSED¹⁵⁸**
385 C1 :i man declare that this and all Specialty-Presentment- :Claims are :Exercised of :i-
386 man's- Prerogative Started on or about: August-September 2016 A.D.

387
388
389 **:Deprivation of :Unalienable- Rights Imposes Harm¹⁵⁹ by theft**
390 C2 :i man: Darrell-James: Hill, -:civilian, -:Executive- :beneficiary believe and declare that :i-
391 man must-ostentatiously present and declare to :you -:Donald-John: Trump, -:Trustee, et al., that
392 :property belonging to :i- man-beneficiary has without right been apparently stolen by :you-
393 Donald-John, -:in -Trustee -dereliction, :in-violation of :the fiduciary- duty and obligation to
394 protect, not steal and not compete to possess the properties claimed and possessed by :i- man
395 -:beneficiary:



Specialty Presentment: USPS RMN RE 322 387 562 US To: Donald-John, -Trump – Trustee
Fore Theft of Covenant Property: unalienable-Rights-From-God-Almighty -Covenant
For :Restoration of: intangible and tangible stolen-property with remedy to:
:Darrell-James: Hill, -:Negro-Ysrael, -:Ohioan-©-1958-A.D., -:civilian, -:Executor -:beneficiary, -:Ambassador,
14 / 62

396 **Attachment B**

397 a) unalienable-Rights-from-God-Almighty /;POTUSA- CIC: DOI-1776-A.D., et seq., et al.

398 **Attachment C**

399 b) Property-Claimed #1¹⁶⁰: Gila county, Arizona state, Recorder of the public record,

400 c) Property-Claimed #2¹⁶¹:

401 d) Property-Claimed #3¹⁶²., and:

402 **Attachment D**

403 b) Deprivation Contract-Agreement for :Property-Claimed #1¹⁶³. Gila county, Arizona state,
404 Recorder

405 c) Deprivation Contract-Agreement for :Property-Claimed #2¹⁶⁴:

406 d) Deprivation Contract-Agreement for :Property-Claimed #3¹⁶⁵:

407 **Attachment E**

408 e) you-Donald-John, et al.- POTUS, APC, CLT, USAG have answered in the silent-acquiescence
409 and failed to account, settle-and-closure of the EBA-1933-A.D. -cestui-que-vie -subrogation, et
410 al.- derivatives – accounts /:POTUS:and/or POTUSA-CIC -:Trump.

412 **THREE (3)- LOTS OF PROPERTY-CLAIMED AND POSSESSED.**

413 C3 :i- man accept and declare that the POTUScorp and POTUSA-CIC in :silent- agreement
414 of the :three (3) - lots of :property-claimed¹⁶⁶ with the :three -:specialty- presentments by the
415 Notary-Public -:Specialty- Presentment regarding the three (3) – lots of :property-claimed by :i-
416 man to the man- Trustee, -:POTUSA – POTUS, are in the status of: Dishonor.¹⁶⁷

417 C4 Attached :in/to the :three (3) -property-claims are the :deprivation-of-property-claimed-
418 contract -agreements¹⁶⁸ and/or :trespass-agreements¹⁶⁹ for :i- man, alternatively, for money :in-
419 specie payable-on-demand to :i-man in :specie with the amount accumulating until the
420 deprivation of the property in -specie, or other-deprivation- agreement, is ended.

421 **C5 For :this- reason of the massive-theft of :property-claimed and possessed**
422 **by :i-man being apparently-stolen is why :this-letter-content must make it to :your,**
423 **:-Donald-John's, the :man's, attention.**

425 **:Silent-Acquiescence with Tacit-Procurator -Agreed by: Notarial- Protest unto Dishonor**
426 **by the man: Donald-John: Trump.**

427 C6 For the obtence of the three (3) -lots of :property with the three Specialty Presentment
428 property-claims with the three deprivation- contracts is with the silently-accepted -:specialty-
429 presentments of the property-claimed and possessed by the :notarial-protest unto :notarial-
430 dishonor¹⁷⁰.

432 **i- man ACCEPT THE SILENT-AGREEMENTS UNTO TACIT- PROCURATION**

433 **C7** :i- man accept the **tacit-acquiescence of the property-claims and contract-agreed** for
434 to accept the :done- exercised- unalienable rights; thereto: in the Lawful- Specialty-Presentment
435 -offers to the Trustee -:Trump, in the claims-with the unalienable-right -to possess the property-
436 claimed by the unalienable-right to :that-election for three-lots of property disposed to :man-
437 claimant of the uSofA-people by the determination and order of the several -trustee-actors of the

1603



Specialty Presentment: USPS RMN RE 322 387 562 US To: Donald-John, -:Trump - Trustee.
Fore Theft of Covenant Property: unalienable-Rights-From-God-Almighty -:Covenant
For :Restoration of: intangible and tangible stolen-property with remedy to:
:Darrell-James: Hill, -:Negro-Ysrael, -:Ohioan-©-1958-A.D., -:civilian, -:Executor -:beneficiary, -:Ambassador,
15 / 62

438 United States-corp, -:district-courts.

439

440 **C8 CESTUI-QUE-USE ~:i- man~ PROPERTY-USE-RIGHTS IN :ACCORDANCE WITH**
441 **FRA-1913-A.D.- :DEPRIVATION-OF- THIS UNALIENABLE-RIGHT IS THEFT**

442

443 C9 :i- man- Negro-civilian -beneficiary, :Executor believe that at the end of the emergency-
444 banking-act, :EBA-1933-2003-A.D. -:Legislative- Dry-Trust -Account, the :option for the demand
445 of account-reports, and/or for the settlement and closure of the cestui-que-vie-trust-accounts is
446 for :i- man- Negro- civilian -beneficiary: Darrell-James: Hill (Ohioan-©-1958-A.D.) to receive the
447 property-claim- :verified.

448

449 **:NEED :ALL-PROPERTY : Federal Reserve Act of 1913 A.D, 'FRA-1913-A.D.' Contract**
450 **Compliance With The EBA-1933-2003-A.D. for :i- man -beneficiary- Access For The :Use**
451 **Of The Trust-Fund Resources.**

452

453 **C10 :i- man requested funds from the Federal Reserve Bank in accordance with the**

454

455 **:Federal-Reserve-Act -:EBA-1933-2003-A.D. -requirements**
456 **C11 :i- man declare that :i- man requested funds from the Federal Reserve Bank in**
457 **accordance with the :Federal-Reserve-Act -:EBA-1933-2003-A.D. -requirements, and both the**
458 **Regional- Federal Reserve -Bank -corp. and :you -POTUS-corp, et al.- administration - actions**
459 **answer by silent agreement with tacit procuracy against the :harm of depriving the 'cestui-que-**
460 **use' from :i- man -:Darrell-James: Hill, -:Negro-Ysrael, -:civilian, -:Ohioan-©-1958-A.D.,**
461 **:-Executor- beneficiary. -**

460

461 **C12 The :EBA-1933-2003-A.D.-Cestui-Que-Trust - :FRA-1913-A.D.-account is for :i-**
462 **man, et al.'s -Unalienable- Right To The 'CESTUI-QUE-USE' via The 'Cestui-Que-Vie**
463 **-ACCOUNT -Property- Claimed and Possessed' For :i- man By The 'FRA-1913-A.D. - EBA-**
464 **1933-2003-A.D.- UScorp- Indenture**

465

466 **The 'Cestui-Que-Use' Of The 'Cestui-Que-Vie' Is To Terminate At 59-1/2 Years Of :age**
467 **C13 :i- man believe that the Right of the benefit of the :property-agreed by the EBA-1933-**
468 **2003-A.D. - 'cestui-que-vie created for :i- man- :Darrell-James: Hill, -:Negro-Ysrael, -:Ohioan-©-**
469 **1958-A.D., -:civilian- beneficiary for the use by the 'cestui-que-use' who is :i- man- Darrell-**
470 **James: Hill, -:Negro-Ysrael, -:Ohioan-©-1958-A.D., -civilian, :Executor- beneficiary is :due**
471 **released to :i- man :all of the property-claimed, in :all- good-faith of the request and verification**
472 **by the APC, CLT, USAG, and SOT et seq., at 59-1/2 years after indenture.**

472

473 **C14 :Mature -debenture- Right of Request Cestui-que-use -property-claim and request**
474 **by :i- man's-unalienable-right :in-accordance with the EBA-1933-2003-A.D. - Federal**
475 **Reserve Act of 1913 A.D., 'FRA-1913-A.D.', - Value is Greater- than :Twenty- Dollars- U.S.**
476 **-Silver- .9999 -one-ounce -money**

477

478 **C15 :i- man believe and declare that the amount of the property claimed in the Specialty**
479 **Presentment -USPS RMN RE 047 610 440 US -: May 15th, 2020 A.D. to: Donald-John...**
480 **:Steve-Turner.... - deprivation is the :amount :in- equity greater-than twenty-dollars U.S. Silver .**
481 **9999 one-ounce money in :specie by the contract-agreed.**

1604



Specialty Presentment: USPS RMN RE 322 387 562 US 10: Donald-John; -Trustee
Fore Theft of Covenant Property: unalienable-Rights-From-God-Almighty -Covenant
For :Restoration of: intangible and tangible stolen-property with remedy to:
:Darrell-James: Hill, -:Negro-Ysrael, -:Ohioan-©-1958-A.D., -:civilian, -:Executor -:beneficiary, -:Ambassador,
16 / 62

481
482
483
484
485
486
487
488
489
490
491
492
493
494
495
496
497
498
499
500
501
502
503
504
505
506
507
508
509
510
511
512
513
514
515
516
517
518
519
520
521
522
523

Deprivation of the :Cestui-Que-Use' OF the 'cestui que vie'- trust- benefit is theft of property-claimed and possessed by :i- man

C16 :i- man -:Negro-Ysrael, -:civilian, -:Ohioan-©-1958-A.D.; :Executor- beneficiary believe that the Right of Request of the Cestui-que-Trust -property in :accordance with the FRA-1913-A.D.- Trustee- dereliction with the Trustee- dereliction and deprivation of EBA-1933-2003-A.D.- beneficiary- contractual- right is :theft in the Value-amount Greater- than :Twenty- Dollars- U.S. -Silver- .9999 -one-ounce -money in :specie.

C17 :No authorization nor right to infringe upon the life, liberty and property-claimed and possessed by :i- man's-unalienable-right. ^{171 172 173}

No authorization for competition with :i- man's-unalienable-rights

C18 :i- man believe and declare that :i- man have given you no authorization to compete to justify or to thieve the property-claimed and owned by :i- man; and,

C19 :i- man -Darrell-James: Hill, claim and possess :all spiritual-rights

C20 :i- man -Darrell-James: Hill, claim and possess :all quantum¹⁷⁴ -rights

C21 :i- man- :Darrell-James: Hill, -Negro- Ohioan-©-1958-A.D., claim :all of the quantum-biology and capability and rights, without prejudice.

C22 :i- man -Darrell-James: Hill possess :all-rights to privately -administer :i- man's-unalienable-right to life, liberty and property-claimed and possessed.

C23 :i- man -:beneficiary, -:Executor believe and declare that :i- man privately and inherently possess :all -rights to privately possess and manage :all -property of :i- man -:Darrell-James: Hill :Negro-Ysrael- :Ohioan-©-1958-A.D., -:civilian, -:Executor-:beneficiary with :inherent and covenant- -unalienable-Rights and Authority.

C24 :i- man -Darrell-James: Hill, claim and possess :all bio-spiritual-rights¹⁷⁵

C25 :i- man -:Darrell-James: Hill, own and possess all of the DNA, et al- other biological -substrate of :i- man, solely, and as kinsman-redeemer¹⁷⁶, without prejudice, without restriction, from the beginning, or ever is the consideration of :same.

Specialty- Presentment Of The Property-Claims To The Army, et al.- military of the USofA- people, For To Halt The Thieving As Per The Lieber-Code-1863-A.D. As Relates To The Guarantees Of The EP-1863-A.D. - See: Attachment E: Gila county, Arizona state, Recorder Doc.# 201-009297 cover-sheet, and pp. 353-272:

C26 :i- man declare that :all of the :i- man: -Property-Claims have with :specialty-presentments been informed-over to the formal attention of TheUSofA- Army, et al.-military-officer-trustees, -:General for to assure accordance with TheUSofA- Army, et al., EP-1863-A.D.- protection of :i- man's unalienable-rights and property-claims.

1605



Specialty Presentment: USPS RMN RE 322 387 562 US To: Donald-John, -:Trump – Trustee

Fore Theft of Covenant Property: unalienable-Rights-From-God-Almighty -:Covenant

For :Restoration of: intangible and tangible stolen-property with remedy to:

:Darrell-James: Hill, -:Negro-Ysrael, -:Ohioan-©-1958-A.D., -:civilian, -:Executor -:beneficiary, -:Ambassador,

17 / 62

524 **Trustee- POTUS contract-agreement for this deprivation of :property-claimed and**
 525 **possessed by :i- man's :unalienable-rights to possess and use :private property for :life,**
 526 **liberty and happiness**
 527 C27 :i- man believe and declare for :that this deprivation is :in- Notarial-dishonor, :you-
 528 Donald-John , :Trustee- POTUS have by contracts-agreed to the deprivation compensation to :i-
 529 man -:civilian -aggrieved, in the amount-rate specified with :tacit procuration by the law of the
 530 contract in the amount of the calculation of : one- ounce of .9999 -silver- U.S. -coin in :specie
 531 per :minute, :unit-of-time¹⁷⁷, **DUE NOW-PAYABLE**. See: **Attachment C: Bill of Particulars for**
 532 **Property-Claimed**; Deprivation- contract- agreements: Property- Claim 1, Claim 2, Claim 3.
 533 **See: Attachment D.**
 534

535 **D: Trustee Holds :i- man's Property-Claimed**
 536 **and Possessed**

537
 538 **VERY- MUCH PROPERTY-CLAIMED AND POSSESSED HAS BEEN STOLEN, which creates**
 539 **the :huge -persistent- DAILY -:loss-of-use -damage upon :i- man.**¹⁷⁸

540 D1 :i man: Darrell-James: Hill, -:civilian, -:Executive- :beneficiary believe and declare that :i-
 541 man must-ostentatiously present and declare to :you :Donald-John: Trump, -:Trustee, et al., that
 542 :property belonging to :i- man-beneficiary has without right been apparently stolen by :you-
 543 Donald-John, -:in -Trustee -dereliction, :in-violation of :the fiduciary- duty and obligation to
 544 protect, not steal and not compete to possess the belongings of :i- man -:beneficiary:
 545 Refer to: C2 above.

546
 547 **POTUSA-CIC, et al- :man- Obama and :Trump, -:Tacit- Acquiescence And Tacit-**
 548 **Procuration To Three-Lots Of Property-Claimed and Possessed, et al.- :deprivation-**
 549 **compensation- contract-agreed -property-claimed and possessed**

550 D2 :i- man believe and declare that for the tacit-acquiescence of the three (3) – lots of
 551 :property-claimed and possessed, and none-else, is theft of the lots of :property-claimed and
 552 possessed by the deprivation of the tangible and in-tangible unalienable-rights :in -Willful-
 553 Dereliction with :harms- imposed against :i- man -:beneficiary, -:Executor- :Darrell-James: Hill,
 554 -:Negro- Ohioan-©-1958-A.D., -:civilian, -:beneficiary

555
 556 -right to own, possess and forever privately -utilize :all of the Property-claimed and possessed
 557 by :i- man's unalienable-rights.

558
 559 **Bill-of-Rights, -:Amendment 9¹⁷⁹, -:Amendment 10¹⁸⁰**

560 D3 :i- man- beneficiary- Executor believe, require and declare that it is the POTUS-Corp
 561 -Trustee's job- oath, duty and obligation to perform the effective- guaranteed-duty to :i- man to
 562 assure to :i- man the guaranteed-duty and obligation for the republic-form- of-government, also
 563 including the :restoration of all property and the EBA-1933-2003-A.D. -Legislative- Dry-Trust
 564 upon the return of the verified- trust- debenture to the man-Trustee, -:Trump for restoration of

Handwritten mark resembling a stylized 'J' or 'L' with the number '1606' written vertically next to it.



Specialty Presentment: USPS RMN RE 322 387 562 US To: Donald-John, -:Trump - Trustee
Fore Theft of Covenant Property: unalienable-Rights-From-God-Almighty -:Covenant
For :Restoration of: intangible and tangible stolen-property with remedy to:
:Darrell-James: Hill, -:Negro-Ysrael, -:Ohioan-©-1958-A.D., -:civilian, -:Executor -:beneficiary, -:Ambassador,
18 / 62

565 the all- of the property-claimed and requested restored to :i- man, -Negro-Ysrael -:-Ohioan-©-
566 1958-A.D.- civilian, -:Executor- beneficiary -:Darrell-James: Hill, of the usofA-people over
567 standing TheCftUSofA¹⁸¹, which you received: USPS RMN RE 047 610 440 US -: May 15TH,
568 2020 A.D.

569
570 **PROPERTY-CLAIMED AND POSSESSED: UNALIENABLE-RIGHTS**
571 **D4 PROPERTY-CLAIMED: 'unalienable-rights' of the Unalienable-Law of Almighty-God**
572 **-covenants :Concession-1213-A.D , DOI-1776-A.D. (of :TheCftUSofA-1789-1791, as**
573 **amended: EP-1863-A.D.)**

574 See :For the Cure and Relief -in the :Equity-Claim, and For the Remedy-Required For the
575 Trespassing Upon The Children of Ysrael/Israel, et al.; ATTACHMENT B: -wholly-Incorporated
576 by-this- :reference.

577
578 **:TheCftUSofA-1789-1791- A.D. -deprivation of :unalienable- :Almighty-God-given- rights**
579 **D5 :i- man believe and declare that :TheCftUSofA-1789-A.D.-Wrong-Doing upon the Negro-**
580 **Ysrael- people is with the uSofA-people and representatives acceptance of the 'Concession-**
581 **1213 -A.D.- fraud by the Roman-Church -Trustee -:Dereliction and wilful deception to**
582 **corroborate harm upon the Children of Jacob/ Ysrael, and to undermine the enslaving nations,**
583 **et al.- uSofA.**

584
585 **:PROPERTY- CLAIMED AND POSSESSED: THREE-DEPRIVATION CONTRACTS- AGREED**
586 **FOR CONTRACTS: POTUSA-CIC - AND POTUS-Trustee, -:Trump's Silent-Agreement-unto-**
587 **Tacit-Procuration.**

588
589 **D6 :i- man -:Darrell-James: Hill, -:Negro, -:Ohioan-©-1958-A.D.- civilian- beneficiary,**
590 **-:Executor believe that the POTUSA- CIC, -:Trump -common- law and -equity -over-standing of**
591 **the POTUS-Corp -Trustee is for the restoration of the property-claimed and possessed**
592 **exercised by :i- man -:Darrell-James: Hill, -:Negro-Ysrael, -:Ohioan-©-1958-A.D.- civilian**
593 **-:Executor - beneficiary**

594
595 **PROPERTY-CLAIMED AND POSSESSED: THREE-LOTS AND THREE-DEPRIVATION**
596 **CONTRACTS-AGREED, AFFIRMED UNTO NOTARIAL-DISHONOR**

597 **D7 :i- man made three (3) property-claims and possessed -property that appears to have be**
598 **'stolen' and/or deprived without :authorization from :i- man with the appearance of :naked- theft**
599 **by you, et al.**

600 **D8 For the obtence of the three (3) -lots of :property with the three Specialty Presentment**
601 **property-claims with the three deprivation- contracts is with the silently-accepted -:specialty-**
602 **presentments of the property-claimed by the :notarial-protest unto :notarial-dishonor¹⁸².**

603
604 **NOTARIAL-DISHONOR UPON THE THREE OF THREE -LOTS Equals Intent to Defraud.**

605 **D9 :i- man accept and declare that the :man- POTUS and POTUSA, in :silent- agreement of**
606 **the :three (3) - lots of :property-claimed with the :three -:specialty- presentments by the Notary-**
607 **Public -:Specialty- Presentment regarding the three (3) - lots of :property-claimed by :i- man to**

1607



Specialty Presentment: USPS RMN RE 322 387 562 US To: Donald-John, -:Trump – Trustee
Fore Theft of Covenant Property: unalienable-Rights-From-God-Almighty -:Covenant
For :Restoration of: intangible and tangible stolen-property with remedy to:
:Darrell-James: Hill, -:Negro-Ysrael, -:Ohioan-©-1958-A.D., -:civilian, -:Executor -:beneficiary, -:Ambassador,
19 / 62

608 the man- Trustee, -:POTUSA – :POTUS, are :in the :status of: Notarial- Dishonor.¹⁸³
609
610 **D10 The Presumed-Paternalism-Right For Stealing- Property, whether tangible or**
611 **intangible property-claimed and possessed Is Theft, and the specific-tool and modus of**
612 **the Subject-Involuntary Servitude of Slavery.**
613
614 **D11 Deprivation of the Contract- Right and/ or the Agreed-Right to :i- man's Property is**
615 **tantamount to the forced compelled "benefit" of the Paternalism of Slavery, i.e., theft, the**
616 **:deprivation of unalienable rights to :i- man for damage of the :life, liberty and property.**
617
618 **:Paternalism-in-theft is the :Denial of :Unalienable-Rights of :i- man**
619 **D12 :Boot-print of :Slavery¹⁸⁴ Of the POTUSA- CIC, – POTUS-Trustee, by the :General Order**
620 **100 of 1863 A.D., the :Lieber-Code, et seq. -:TWEA-1917-A.D., as amended**
621
622 **:Trustee- Dereliction -IN -ERROR Without Correction Affirms Intent**
623 **D13 :i- man believe and declare that the deprivation of the any unalienable-God-given-right by**
624 **the Trustee- :dereliction of :duty and obligation without :correction affirms the :Trustee's**
625 **-despise of :i- man's intangible- unalienable -right to :choose for life, liberty or property in specie,**
626 **et al.**
627
628 **:POTUSA-CIC, -:POTUS -:Trustee -:Trump- DERELICTION Of Oath, And the Violation of**
629 **the Fiduciary Duty And Obligation To Account The :Property-Claimed To :i- Man**
630 **Beneficiary.**
631 **D14 :i- man -civilian, -beneficiary, -:Executor accept and declare that :all -inquiries for the**
632 **release of the :all -account-reports- to- :i- man-requests have been :all- answered in the silent,**
633 **:-acquiescence with -:tacit- procuration.**
634
635 **Deprivation of :Republic-Form Of :Government Duty And Obligation Of: Potusa-CIC**
636 **And :POTUS Dereliction Is Theft From :i- man**
637 **D15 :i- man Believe that the guarantee for the republic-form of :government is the duty and**
638 **obligation of the POTUSA-CIC over-standing the :any-job-policy of the POTUS; to do otherwise**
639 **would be to not perform the duty and obligations of the POTUSA-CIC -Trustee, -:man -Donald-**
640 **John: Trump.**
641
642 **Confiscation of Civilian- Property Without Receipt-given is Theft**
643 **D16 :i- man believe and declare that the Lieber-Code-1863-A.D. requires- that the POTUSA-**
644 **CIC- actor provide receipts for :all of the confiscated- property by the conduct of the policy-**
645 **agreement, :where-in Theft is the mere dereliction-of-the-trustee-duty-and-obligation.**
646
647 **:POTUSA-CIC and POTUS- Trustee Are Under Obligation To Not Compete With :i- man**
648 **-Beneficiary**
649 **D17 :You -Donald-John, -:POTUSA-CIC, -:POTUS-Corp-Trustee of the EBA-1933-2003-**
650 **A.D.- Legislative- Dry-Trust are under the duty and obligation to protect, and to not compete-**



Specialty Presentment: USPS RMN RE 322 387 562 US To: Donald-John, -:Trump - Trustee
Fore Theft of Covenant Property: unalienable-Rights-From-God-Almighty -:Covenant
For :Restoration of: intangible and tangible stolen-property with remedy to:
:Darrell-James: Hill, -:Negro-Ysrael, -:Ohioan-©-1958-A.D., -:civilian, -:Executor -:beneficiary, -:Ambassador,
20 / 62

651 with, :- man, -:Negro-Ysrael, -:Ohioan-©-1958-A.D., -:beneficiary's equity and rights to life,
652 liberty and property.

653
654 **NEEDS FOR LIFE AND LIVING**

655 **D18 :Donald-John. – These are some of the Needs :i- Man must NOW bring to your**
656 **attention in order to meet the last condition after which you must restore :All of the**
657 **property-claimed by :i- man, Executor- beneficiary to meet the needs of the :Hill- family, et**
658 **al. of :i- man's Private Use Of The Property- Claimed and Possessed By :i- man.**

659
660 **D19 :in -NEED OF A :HOME-BEFITTING; TRANSPORTATION; HEALTH – CARE**
661 **THREATENED BY THE Your THEFT**

662 **D20 :i- man- Negro-Ysrael, -:civilian, -:Executor- beneficiary have to meet the :immediate-**
663 **needs to obtain the suitable home, transportation, and the highest-level health needs for the**
664 **family which :necessary-items have been stolen-away-now from :i- man by :you.**

665
666 **:NEED AND USE OF YOUR PRIVATE RESOURCES FOR YOUR FAMILY**

667 **D21 :You- Donald-John reportedly have several many magnificent homes; why would you**
668 **loathe that :i- man -Negro-Ysrael; -:Ohioan, -:civilian, -:Executor- beneficiary -ex-Nurse would**
669 **have the property belonging to :i- man? Can you see this?**

670
671 **:NEED :UNALIENABLE-RIGHT TO THE :USE OF THE BENEFIT OF THE EBA-1933-2003-**
672 **A.D.**

673 **D22 :i- man believe and declare that by the deprivation of the unalienable-Right of :i- man;**
674 **Darrell-James: Hill, to progressively :account, :settle and close the legislative- dry- trust: EBA-**
675 **1933-2003- A.D. is unlawful and illegal- damage upon :i- man by :you- man -Trustee -dereliction**
676 **unto the criminal-act by Trustee -:Trump, et al.- USAG: APC and CLT, by :deprivation of the**
677 **unalienable-rights of :i- man.**

678
679 **D23 :i- man believe and declare that :i- man have given you no authorization to compete to**
680 **justify or to thieve the property-claimed and owned by :i- man; and,**

681
682 **D24 :No authorization nor right to infringe upon the life, liberty and property-claimed**
683 **and possessed by :i- man's-unalienable-right. ^{185 186 187}**

684
685 **:PROGRESSIVE -:SPECIALTY-PRESENTMENT-PROPERTIES ARE SILENTLY-**
686 **ACQUIESCED AND PROPERTY STOLEN/ HELD WITH :TRUSTEE- DERELICTION AND**
687 **VIOLATION OF THE FIDUCIARY- DUTY AND OBLIGATION**

688 **D25 :i- man believe and declare that the :several-specialty-presentments requiring restoration**
689 **of the property-claimed and unlawfully -withheld/stolen from :i-man by the Trustee -:Donald-**
690 **John, -:Trustee Trump, et al., are in the direct violation of the inherent unalienable -right and law-**
691 **agreed-to by you-Trustee of the: Torah- KJV- bible- law; Concession-1213-A.D.-covenant, DOI-**
692 **1776-A.D.-covenant, :TheCftUSofA-1789-1791- A.D. -covenant, et al.- also including the EP-**
693 **1862-1863-A.D. and the General-Order 100 of 1863 A.D., 'GO-1863-A.D.'**



Specialty Presentment: USPS RMN RE 322 387 562 US To: Donald-John, -Trump - trustee
Fore Theft of Covenant Property: unalienable-Rights-From-God-Almighty -:Covenant
For :Restoration of: intangible and tangible stolen-property with remedy to:
:Darrell-James: Hill, -:Negro-Ysrael, -:Ohioan-©-1958-A.D., -:civilian, -:Executor -:beneficiary, -:Ambassador,
21 / 62

694
695
696
697
698
699
700
701
702
703

STOP THE :harm OF :PROPERTY- THEFT^{188 189 190 191}

D26 :i- man believe and declare that :you, -Barack and Donald, et al., legally received the property-claimed and possessed by :i- man, and none else: no right nor authorization from :i- man to possess the property or otherwise to administrate :i- man's private property.
D27 :i- man believe and declare that :you :Donald, et al. are somehow involved in :thieving from the poor- :i- man; stealing the property-claimed and possessed by the unalienable-rights of :i- man that :you -the -thief are sworn to protect as the POTUSA-CIC under the laws of Almighty-God of this nation and this nation's organic- laws.

704

E. :i- man Want Property-Claimed And Possessed -Restoration

705
706
707
708
709

E1 :i man believe that :you-Donald-John erred¹⁹². So..., fix-it?
E2. :i- man Wish :All- Property-Claimed And Possessed -Restored post-haste.
E3 :Ex-post-facto -law applies.

710
711

I) :Property-Claimed: England and Ireland¹⁹³ :Concession-1213-A.D., by the right of the Children-of-Jacob/Ysrael: -Negro-Ysrael-1213-A.D¹⁹⁴- beneficiaries.

712
713
714
715
716

E4 The Concession of England and Ireland to Almighty-God, Peter, Paul, and .. Holy-Church by King-John-I, of 1213 A.D. states that by the right of the Children-of-Jacob/Ysrael: -Negro-Ysrael-1213-A.D. owing to the Concession-1213-A.D., that the: England and Ireland - property is conceded to: i- man: Darrell-James: Hill, :Negro-Ysrael-1213-A.D., et al.- the :Holy-Church.

717
718

Property-Claimed and Possessed From The Concession-1213-A.D.

719
720
721
722
723
724
725
726
727
728

E5 :i- man believe and declare that the Concession-1213-A.D. gave all of England and Ireland to the House-of-Judah ~Judah, Benjamin and Levi~ and the Holy-Church of Almighty-God the Messiah.
E6 Claim on this matter for the accounting has been made to the appointee: Jorge-Mario: Bergoglio, -Trustee -Roman-Church in the :For the Cure and Relief -in the :Equity-Claim, and For the Remedy-Required For the Trespassing Upon The Children of Ysrael/Israel, et al.; To:Jorge-Mario: Bergoglio :USPS RMN RE 322 387 576 US; c/o Apostolic Palace, 00120 Vatican City, c/o :Donald-John :CIC- :Trump: USPS RMN RE 322 387 562 US; 1600 Pennsylvania Ave NW, Washington, District of Columbia 20500; APPENDED: 7 PAGES, ATTACHMENT B: -wholly-Incorporated by-this- :reference.

729
730
731
732
733
734

II) :Unlimited-Right-to-Contract to Account-reports, settlement and closure of the EBA-1933-2003-A.D. Legislative- :'dry -cestui-que-vie -trust' for :i- man at this era : all of the property-claimed and possessed by :i- man's-unalienable-right

E7 :i- man, -Executor- beneficiary exercise the unalienable- unlimited-right to contract to Not be compelled to participate in the EBA-1933-2003-A.D. -legislative- dry-trust. To impose any



Specialty Presentment: USPS RMN RE 322 387 562 US To: Donald-John, -:Trump – Trustee
Fore Theft of Covenant Property: unalienable-Rights-From-God-Almighty -:Covenant
For :Restoration of: intangible and tangible stolen-property with remedy to:
:Darrell-James: Hill, -:Negro-Ysrael, -:Ohioan-©-1958-A.D., -:civilian, -:Executor -:beneficiary, -:Ambassador,
22 / 62

735 other paternalism- aberrancy or discretion is unlawful-detainment of the property-claimed and
736 possessed, and absolutely illegal in :all -moral law.:

737
738 **Common-law and -equity UNTO remedy and recourse required:**

739 E8 :i- man -:beneficiary's :unalienable- right of restoration unto remedy-recourse and/or
740 cure must-ought-always- be -insured: that is, :However -the -mind -of -the -:man -Trustee -is, the
741 :right of the beneficiary to the full- exercise of :his -unalienable-:right :in the obtence of
742 the life, liberty and property-sought must-ought -always -be -forthwith-met by the
743 Fiduciary -duty and obligation upon the mere Request by the beneficiary -:Executor
744 -:Darrell-James: Hill, as is :in this presentment.

745
746 E9 :NEED FOR END :of i-man's harms and the :DAILY -DEPRIVATION- DAMAGES
747 – :NEED :ALL PRIVATE-PROPERTY-CLAIMED AND POSSESSED, RESOURCES
748 PRESENTLY STOLEN BY :YOU- Donald-John, -:POTUSA-CIC, -:POTUScorp- Trustee, et al.

749
750 **:Executor-Beneficiary -:Orders:**

751
752 E10 **No Stealing :i- man's unalienable-right to property- claimed and possessed**

753 E11 :i- man -Executor-beneficiary give :you- Trustee No authorization to :possess, detain,
754 steal, thief or administer the :property of :i- man without express consent.

755
756 E12 Theft¹⁹⁵ is No Lawful Or Legal-Authority For :possession of The Property-Claimed by :i-
757 man's Unalienable Rights To Obtence Of :all- Property-Claimed, Intangible And Tangible,
758 Unknown; And Known Property- Claimed or Possessed.

759
760 **NOTICE: Demand: The 'UNITED-STATES-corp-' government must immediately cease**
761 **:DOI-1776-A.D. -:Trustee- Dereliction and ALL- activities harmful to :i- man's –**
762 **unalienable-rights to life, liberty and property-claimed and possessed.**

763 E13 :i- man believe and declare that the :DOI-1776-A.D. -covenanted -unalienable- rights
764 was deprived from the Negro-Ysrael- :Concession-1213-A.D.- DOI-1776-A.D. -covenant-
765 people - :beneficiaries by the United-Colonies and by their B.A.R.-member -type-
766 representatives of the United States of America of 1776 -1791 A.D.

767
768 **:REQUIRED :ALL-PROPERTY FOR TO OBTAIN APPROPRIATE ADDITIONAL SECURITY**

769 E14. :i- man believe and declare that in accordance with the prevailing history and non-action
770 upon the remedies-due-now for :i- man's-unalienable-rights of :life, liberty, property-agreed and
771 the pursuit of happiness that the covetousness :in-grained in the uSofA-people's despise of the
772 Negro-Ysrael- civilian will attract the 'attack-dogs' and murderers to harm :this -elderly 'man-'
773 because that modi operandii has been and still :today is :in the psycho-dynamic of the uSofA-
774 people. **However,** the additional security is instructed for :i- man to obtain-upon by the Almighty-
775 God against the Roman-Church-Derelicts of the Concession-1213-A.D., and against, sadly,
776 the :uSofA-people of the :accultured- anti-Negro-Ysrael – Roman-Church-zealot -subverted-
777 :man-kind -abusers.

1611



Specialty Presentment: USPS RMN RE 322 387 562 US To: Donald-John, :-Trump - Trustee
Fore Theft of Covenant Property: unalienable-Rights-From-God-Almighty :-Covenant
For :Restoration of: intangible and tangible stolen-property with remedy to:
:Darrell-James: Hill, :-Negro-Ysrael, :-Ohioan-©-1958-A.D., :-civilian, :-Executor :-beneficiary, :-Ambassador,
23 / 62

778
779
780
781
782
783
784
785
786
787
788
789
790
791
792
793
794
795
796
797
798
799
800
801
802
803
804
805
806
807
808
809
810
811
812
813
814
815
816
817
818
819
820

:REQUIRED :ALL-PROPERTY OF A :HOME-BEFITTING; TRANSPORTATION; HEALTH - CARE THREATENED DAILY AND NOW YOUR THEFT

E15 :- man- Negro-Ysrael, :-civilian, :-Executor- beneficiary have to meet the :immediate- needs to obtain the suitable **home, transportation, and the highest-level-WELLNESS- health- needs** now for the family and such necessary-items have been stolen-away- now from :- man by :you- :Donald-John.

: REQUIRED :ALL-PROPERTY- :UNALIENABLE-RIGHT TO THE :USE OF THE BENEFIT OF THE EBA-1933-2003-A.D.

E16 :- man believe and declare that by the deprivation of the unalienable-Right of :- man; Darrell-James: Hill, to progressively :account, :settle and close the legislative- dry- trust: EBA- 1933-2003- A.D. is unlawful and illegal- damage upon :- man by the POTUS :-Trustee, AND then by POTUSA-CIC -dereliction unto the criminal-actions by Trustee :-Trump, et al.- USAG: APC and CLT, et al., by :deprivation of the unalienable-rights of :- man.

What :- man Must Want- Should- Happen Here-Now → Expedient Fix.

E17 :- man wish that the :unalienable-rights to :all- property-claimed and possessed by :- man and by :contract-agreement are restored :in -specie to :- man :in-accordance with the prevailing-agreement for same :all of the three -lots-of-property -claimed and possessed, et seq., by :-man: to wit:

- 2) the :three of three- separate -lots of :substantial-large-amounts -of :-property- claimed and possessed, each valued at more than :twenty -silver-dollar- coins, -U.S.- money in: 0.9999 -U.S. -Silver-in :specie.
- 3) the :three of three- separate contract- agreements for each one of the three lots for the deprivation-of-property- contract-agreements [1) above] of the unalienable-right to privately-possess and use the :property-claimed, :each -valued at more than twenty -silver-dollar- coins, -U.S.- money, -in :specie, :each being the :sum of :time x one-ounce, - 0.9999 -U.S. -Silver -coin -in :specie per- minute until the resolve of the theft.
- 4) One matter of: unalienable-right to account-reports of the EBA-1933-2003-A.D.; valued at more than twenty -silver-dollar coins, -U.S.-money, -in:-specie
- 5) One matter of: unalienable-right to account-reports, settle-and-closure of of the EBA-1933-2003-A.D.; valued at more than twenty -silver-dollar coins, -U.S.- money -in:-specie; and:
- 6) One matter of :unalienable-right as the cestui-que-vie and -use :-Darrell-James: Hill, to use :the -benefit of the EBA-1933-2003-A.D. :-legislative :-Dry- Trust as complies with the EBA-1933-2003-A.D – FRA-1913-A.D. -nexus; valued at more than twenty -silver-dollar coins, -U.S.-money -in:-specie

18 **:Expedient Fix**

1) **:cease and desist the :paternalism :-Theft-of-Property -socialism**



Specialty Presentment: USPS RMN RE 322 387 562 US To: Donald-John, -Trump - Trustee
 Fore Theft of Covenant Property: unalienable-Rights-From-God-Almighty -Covenant
 For :Restoration of: intangible and tangible stolen-property with remedy to:
 :Darrell-James: Hill, -:Negro-Ysrael, -:Ohioan-©-1958-A.D., -:civilian, -:Executor -:beneficiary, -:Ambassador,
 USPS RE 322 398 401 US 24 / 53

820
821
822
823
824
825
826
827
828
829
830
831
832
833
834
835
836
837
838
839
840
841
842
843
844
845
846
847
848
849
850
851
852
853
854
855
856
857
858
859
860
861
862

- 2) :Restoration of :all- property-claim and possessed.
- 3) :Abide the :deprivation-of-property- :contract- agreements
- 4) :Account-report, settle-and-close the EBA-1933-A.D., -Legislative- Dry-Trust -Indenture
- 5) :Insure 'cestui-que-use, -:i- man -:Executor -beneficiary' access to the cestui-que-vie -trust for :i- man in accordance with the EBA-1933-2003-A.D.- Dry-Trust-Legislation

Donald-John: Trump, -:Trustee -POTUSA-CIC, - POTUS, :i- man Want and wish for the property-claimed and possessed by :i- man be restored to :i- man now post-haste, so to end these matters to the favor of :i- man, -:Executor- beneficiary.

:i- man affirm the above statement is true and correct to the best- ability and :i- man will state-same in the open court.

Without prejudice,
Darrell-James Hill, Executor
 :Darrell-James: Hill, -:Negro-Ysrael -:Ohioan-©-1958-A.D., -:civilian, -:beneficiary -:Executive; - :i- man- Adam- :Ambassador. Yushuah-the-Messiah

Affirmed and autographed before me this 18 day: September 2020 A.D.
 Type of Identification: Arizona Driver License

Cheryl Smith
 Notary Public

SEAL

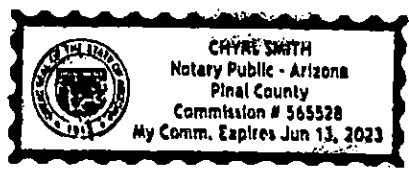

RE 322 398 401 US

From: Darrell-James, :Specialty Presentment: USPS RMN RE 322 387 562 US
 To: Donald- John, :Civilian -Exercise :Unalienable-Rights-From-God-Almighty -:Covenant 24 /

2022-011769 MISC Page: 1624 of 2782
 09/26/2022 03:35:37 PM Receipt #: 22-9381
 Rec Fee: \$30.00 Darrell James Hill
 Gila County, Az, Sadie Jo Binsman, Recorder

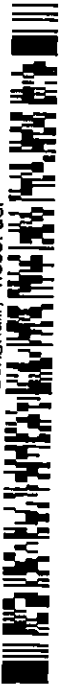

UNOFFICIAL

2022-0111769 MISC Page: 1625 of 2782
09/26/2022 03:35:37 PM Receipt # : 22-9381
Rec Fee: \$30.00 Darrell James Hill
Gila County, Az, Sadie Jo Bingham, Recorder

1 :Darrell-James: Hill means: Darrell-James: Hill, Ohio state © 1958-A.D., -: beneficiary. See: Gila county, Arizona state, Recorder Doc. # 2017-002378; Affidavit: Proof of Claims- Superior Constructive Notice and Demand: Permanent Non-Commercial Presumption: pp. 6-24, 89-91,93-95 of 693. Gila county, Arizona state, Recorder Doc. # 2018-005176; affidavit: Statement of Claim: Curative Registration fo the the found live life.... pp. 10-21; and, et seq. -beneficiary of the Cestui Que Trustee-ministers -:Jorge-Mario: Bergoglio and :Donald-John: Trump. :Gila county, Arizona state, Recorder means: <https://recorder.gilacountyaz.gov/recorder/web/> (last checked: September 13th, 2020.)

2 :Darrell-James: Hill means: Earthen -:man-child, :birthed :son of :Clarence, :son of :James, :son 'Negroland, of :Kingdom-of-Judah, :Africa', ...:son :Ysrael- :Southern-Kingdom ~ of the sons :Judah and Benjamin and Levi, et al.~, ...:son of :Jacob-:Ysrael, :son of :Isaac, :son of :Abram -:Abraham, ...:son of :Shem, :son of :Noah, ...:son of :Methuselah, :son of :Enoch, ...:son of :Seth, :son of :Adam with :Eve of the garden of :Eden ~ including all :known and unknown :ancestral- lands ~ on the earth placed under the Adamic- lineage and under the :only-begotten -son of the Most-High-God and Father embodied within the rebirth by :i- man by the power of :Yushuah-Messiah, -:God, with the redemption by the Savopr wotj the Messiah- Yushuah ('Jesus-the-Christ'), and encompassing the :receivership, responsibility and administration over :all of the earth-planet as :heir - :remainderman, and :Kinsman- :redeemer of the Earth, both 1) from the Adamic-lineage by the :loss in :spirit in the man upon the Earth, and 2) by the Messiah-Yushuah by the restoration in the Holy Spirit in :i- man upon the Earth: on, in or under-the-surface of the planet; :on, in or under-the-surface of the oceans and waters, and :on, in, under-the-surface of the atmosphere/ above the atmosphere of the Earth to wherever the Adamic- :man- kind in the quantum and in the spirit is now, of :where the :purposes of the Most High God and Father are immeasurable by mere :man. No-thing Stands between the Almighty God~ His Father; See: KJV- Book: Daniel -chap. 7 v 9 – 14.~ and :i-man. :Mental -Status: Alive © 2017 A.D.

:i- man -Darrell-James: Hill, -Negro-Ysrael, -:civilian, -:Ohioan-©-1958-A.D., -:beneficiary(s), '-:beneficiary', am full of years, and of :sound-mind. – sixty-one (61) years of Earth-time, -:soul- journeying -ex-Nurse, and privately- studied- soul.

:Ohioan-©-1958-A.D. means: refers to the after-birth- presence of :i- man with the given name of X (common-law copyright) on the ground location known as 'Ohio state', etc.- uSofA- country, on the American continent, planet: Earth....

:civilian means: as r/t the Lieber-Code-1863-A.D and the TWEA-1917-A.D., an enemy- national- private- inhabitant of the occupied country who is not a combatant, insurrectionist, etc.- belligerent

Common- Law Commercial- :CIVIL- STATUS: Alive © 2017 A.D.

:i- man -:Darrell-James: Hill, Ohioan-©-1958-A.D. -:beneficiary of the EBA-1933-2003-A.D. -Legislative-Trust, et seq., declare that on or about the age-count of :59- ½ -years were the :Trustees of the EBA-1933-2003-A.D.- Legislative-dry-trust severally-noticed that :i- man am 'civilly-alive' with the specialty- presentments upon the Summit-county of the Ohioan-©-1958-A.D.-birth, upon the public- recordation about the habitation -Arizona state ~:Gila county~, and with :sure – Specialty-Presentment, -Notice of :same upon the several-Trustee-actors, et al.- :2017-A.D. -Ohio, Arizona and POTUS -Trustee- officials, and also including the :all of the Arizona state county sheriffs, that :i- man am by every inference :in-fact :civilly-alive, to be noticed in the Real-Time-Crime-Center, 'RTCC*'.
*RTCC- the extract of the :centralized-complete and :absolute -computer-aided -face -recognition and correlated-information -database -full-time- immediate -access to :all- global-

1614

information to facilitate the :proactive- protection of :i- man's-unalienable-rights to life, liberty and property :in -assurance for to secure to :i- man the right to the pursuit of happiness by :i- man's-exercise of the unalienable-rights.

- 5 **:Executor means:** one who is appointed to act upon obtence of benefit (= 'cestui-que-use') of the advantage to the beneficiary by the exercise of the implementation of the obligations of the trust.
- 6 **:beneficiary means: one who receives a benefit or advantage.** As relate to: a) inherent beneficiary, the benefit comes unalienable with the Almighty-God's spirit-soul-quantum-law amalgam- design; b) Earth-man quantum-biology, the benefit comes unalienable with birth into the quantum-kind onto this planet with the rights of this planet, system ... universe; c) the EBA-1933-2003-A.D., the cestui-que-use (user- being :i- man-beneficiary) of the cestui-que- vie (trust-fund-made-for :i-man around birth) as evidence by the debenture-bond (Certificate of Live Birth, etc.) provided to apportion the benefit and settle and close of the trust at 59-1/2 years of age-time.
- 7 **:Ambassador means:** KJV- Book: Ephesians--- chap.. 6, v. 20. "For which I am an ambassador in bonds: that therein I may speak boldly, as I ought to speak."
- 8 **:i- man means:** 'i' is the Great :i am, Almighty God Creator of all and for whom all is; 'man' is the kind on this Earth- world, made in the image of the Almighty God and His Father, the :Ancient-of-Days – the Most-High-God. Ibid 1, et seq.
- 9 **:Book means:** 1) of considerable length for the topics; in 2) the condensed- form; 3) some information must be stated with some repetition is enabled for the ease of reading in context where the reasons concern the political-election; 4) Covenants and laws indicated are generally streamlined for the righteous self-investigation and query; 5) form is in the 'unfamiliar-' simple- common-law claim-of-right; 6) lawful and legal foundation is for that western-world and of the uSofA-legislative politic which concerns 'Adam and Eve' to the children of Ysrael to the Messiah to Negro-Ysrael, et al.-:i- man; 7) therefore, document is front-loaded with necessary definitions and concepts; 8) intention is for Donald-John, not for the politically-correct focus but for the 'problem-identification-for- problem-correction" for :i- man, et al., intent; 9) many contexts in the truth of the Torah-scriptural history in the context of man-kind's biology and progeny and capability as defined by the Torah are intimated but not the scope of this-document, in that: a) the Torah, life of the man-God-Messiah is the recorded world-history, even in China and Tibet, and b) it is the metering-device for the illuminati -secret societies of the world now-to-fore and after- Thereto: they know who the Almighty-God is, AND they have decided to serve His creation: Satan. Whether this is a big secret, .. :i- man don't know, BUT it is obvious where in seeing this that one can see it.
- 0 **'Let my people go' means:** a) In the context of :KJV- Book: **Amos chap 4.** that: b) The sum is to 'The united States of America' -people in :mass that are in the lands of the descendants of :Jacob/Ysrael by way of the Lion-of-Judah, the :Messiah- Yushuah, the ':Almighty- God' by way of the foundation- covenanted by the Northern- Kingdom -of -:Ysrael, not excluding: Europeans, Africans, and Asians – :all -:ethnically-diverse -:Americans; and, including, the :Negro-progeny embodying the tribes of the Southern -Kingdom- :House-of-Judah surviving the :extinction-events: after i) the :annihilation of :Jerusalem – 70 A.D., and ii) the :human-trafficking from the :Kingdom-of-Judah, :Negroland, -:African- continent, et al., to the Americas by ship – 1618 A.D., et seq.- KJV-Book: **Deuteronomy chap 28**
- 1 **:Proverbs chap 1 means:**
Pro 1:1 The proverbs of Solomon the son of David, king of Israel;
Pro 1:2 To know wisdom and instruction; to perceive the words of understanding;
Pro 1:3 To receive the instruction of wisdom, justice, and judgment, and equity;

Page: 1626 of 2782

MISC

2022-011769

09/26/2022 03:35:37 PM

Receipt # 22-9381

Darrell James Hill

Recorder

Arizona

Yuma County

1615

Pro 1:4 To give subtilty to the simple, to the young man knowledge and discretion.
 Pro 1:5 A wise *man* will hear, and will increase learning; and a man of understanding shall attain unto wise counsels:
 Pro 1:6 To understand a proverb, and the interpretation; the words of the wise, and their dark sayings.
 Pro 1:7 **The fear of the LORD is the beginning of knowledge: but fools despise wisdom and instruction.**
 Pro 1:8 My son, hear the instruction of thy father, and forsake not the law of thy mother:
 Pro 1:9 For they *shall be* an ornament of grace unto thy head, and chains about thy neck.
 Pro 1:10 My son, if sinners entice thee, consent thou not.
 Pro 1:11 If they say, Come with us, let us lay wait for blood, let us lurk privily for the innocent without cause:
 Pro 1:12 Let us swallow them up alive as the grave; and whole, as those that go down into the pit:
 Pro 1:13 We shall find all precious substance, we shall fill our houses with spoil:
 Pro 1:14 Cast in thy lot among us; let us all have one purse:
 Pro 1:15 My son, walk not thou in the way with them; refrain thy foot from their path:
 Pro 1:16 For their feet run to evil, and make haste to shed blood.
 Pro 1:17 **Surely in vain the net is spread in the sight of any bird.**
 Pro 1:18 **And they lay wait for their own blood; they lurk privily for their own lives.**
 Pro 1:19 **So are the ways of every one that is greedy of gain; which taketh away the life of the owners thereof.**
 Pro 1:20 Wisdom crieth without; she uttereth her voice in the streets:
 Pro 1:21 She crieth in the chief place of concourse, in the openings of the gates: in the city she uttereth her words, *saying*,
 Pro 1:22 How long, ye simple ones, will ye love simplicity? and the scorers delight in their scorning, and fools hate knowledge?
 Pro 1:23 **Turn you at my reproof: behold, I will pour out my spirit unto you, I will make known my words unto you.**
 Pro 1:24 **Because I have called, and ye refused; I have stretched out my hand, and no man regarded;**
 Pro 1:25 **But ye have set at nought all my counsel, and would none of my reproof:**
 Pro 1:26 **I also will laugh at your calamity; I will mock when your fear cometh;**
 Pro 1:27 **When your fear cometh as desolation, and your destruction cometh as a whirlwind; when distress and anguish cometh upon you.**
 Pro 1:28 Then shall they call upon me, but I will not answer; they shall seek me early, but they shall not find me:
 Pro 1:29 **For that they hated knowledge, and did not choose the fear of the LORD:**
 Pro 1:30 **They would none of my counsel: they despised all my reproof.**
 Pro 1:31 **Therefore shall they eat of the fruit of their own way, and be filled with their own devices.**
 Pro 1:32 **For the turning away of the simple shall slay them, and the prosperity of fools shall destroy them.**
 Pro 1:33 But whoso hearkeneth unto me shall dwell safely, and shall be quiet from fear of evil.

12:Malachi chap 3 means:

Mal 3:1 Behold, I will send my messenger, and he shall prepare the way before me: and the Lord, whom ye seek, shall suddenly come to his temple, even the messenger of the



16/16

covenant, whom ye delight in: behold, he shall come, saith the LORD of hosts.

Mal 3:2 But who may abide the day of his coming? and who shall stand when he appeareth? for he *is* like a refiner's fire, and like fullers' soap:

Mal 3:3 And he shall sit as a refiner and purifier of silver: and he shall purify the sons of Levi, and purge them as gold and silver, that they may offer unto the LORD an offering in righteousness.

Mal 3:4 Then shall the offering of Judah and Jerusalem be pleasant unto the LORD, as in the days of old, and as in former years.

Mal 3:5 And I will come near to you to judgment; and I will be a swift witness against the sorcerers, and against the adulterers, and against false swearers, and against those that oppress the hireling in *his* wages, the widow, and the fatherless, and that turn aside the stranger *from his right*, and fear not me, saith the LORD of hosts.

Mal 3:6 For I *am* the LORD, I change not; therefore ye sons of Jacob are not consumed.

Mal 3:7 Even from the days of your fathers ye are gone away from mine ordinances, and have not kept *them*. Return unto me, and I will return unto you, saith the LORD of hosts. But ye said, Wherein shall we return?

Mal 3:8 Will a man rob God? Yet ye have robbed me. But ye say, Wherein have we robbed thee? In tithes and offerings.

Mal 3:9 Ye *are* cursed with a curse: for ye have robbed me, *even* this whole nation.

Mal 3:10 Bring ye all the tithes into the storehouse, that there may be meat in mine house, and prove me now herewith, saith the LORD of hosts, if I will not open you the windows of heaven, and pour you out a blessing, that *there shall not be room* enough to receive it.

Mal 3:11 And I will rebuke the devourer for your sakes, and he shall not destroy the fruits of your ground; neither shall your vine cast her fruit before the time in the field, saith the LORD of hosts.

Mal 3:12 And all nations shall call you blessed: for ye shall be a delightsome land, saith the LORD of hosts.

Mal 3:13 Your words have been stout against me, saith the LORD. Yet ye say, What have we spoken *so much* against thee?

Mal 3:14 Ye have said, It is vain to serve God: and what profit *is it* that we have kept his ordinance, and that we have walked mournfully before the LORD of hosts?

Mal 3:15 And now we call the proud happy; yea, they that work wickedness are set up; yea, *they that tempt God* are even delivered.

Mal 3:16 Then they that feared the LORD spake often one to another: and the LORD hearkened, and heard *it*, and a book of remembrance was written before him for them that feared the LORD, and that thought upon his name.

Mal 3:17 And they shall be mine, saith the LORD of hosts, in that day when I make up my jewels; and I will spare them, as a man spareth his own son that serveth him.

Mal 3:18 Then shall ye return, and discern between the righteous and the wicked, between him that serveth God and him that serveth him not.

13 :Deuteronomy chap 27 v 9-26 means:

Deu 27:9 And Moses and the priests the Levites spake unto all Israel, saying, Take heed, and hearken, O Israel; this day thou art become the people of the LORD thy God.

Deu 27:10 Thou shalt therefore obey the voice of the LORD thy God, and do his commandments and his statutes, which I command thee this day.

Deu 27:11 And Moses charged the people the same day, saying,

2020 September Declaration Of :- man- Adam :-Ambassador to :Yushuah the :Messiah 33 / 62
 From: Darrell-James: Hill, Negro-Ysrael, :-Ohioan-©-1958-A.D., -civilian, :Executor- beneficiary – Without-prejudice

2022-011769 MISC Page: 1628 of 2782

09/26/2022 03:35:37 PM Receipt #: 22-9381
 Rec Fee: \$30.00 Darrell James Hill
 Gila County, Az, Sadie Jo Bingham, Recorder



Deu 27:12 These shall stand upon mount Gerizim to bless the people, when ye are come over Jordan; Simeon, and Levi, and Judah, and Issachar, and Joseph, and Benjamin:
 Deu 27:13 And these shall stand upon mount Ebal to curse; Reuben, Gad, and Asher, and Zebulun, Dan, and Naphtali.
 Deu 27:14 And the Levites shall speak, and say unto all the men of Israel with a loud voice,
 Deu 27:15 Cursed *be* the man that maketh *any* graven or molten image, an abomination unto the LORD, the work of the hands of the craftsman, and putteth *it* in a secret place. And all the people shall answer and say, Amen.
 Deu 27:16 Cursed *be* he that setteth light by his father or his mother. And all the people shall say, Amen.
 Deu 27:17 Cursed *be* he that removeth his neighbour's landmark. And all the people shall say, Amen.
 Deu 27:18 Cursed *be* he that maketh the blind to wander out of the way. And all the people shall say, Amen.
 Deu 27:19 Cursed *be* he that perverteth the judgment of the stranger, fatherless, and widow. And all the people shall say, Amen.
 Deu 27:20 Cursed *be* he that lieth with his father's wife; because he uncovereth his father's skirt. And all the people shall say, Amen.
 Deu 27:21 Cursed *be* he that lieth with any manner of beast. And all the people shall say, Amen.
 Deu 27:22 Cursed *be* he that lieth with his sister, the daughter of his father, or the daughter of his mother. And all the people shall say, Amen.
 Deu 27:23 Cursed *be* he that lieth with his mother in law. And all the people shall say, Amen.
 Deu 27:24 Cursed *be* he that smiteth his neighbour secretly. And all the people shall say, Amen.
 Deu 27:25 Cursed *be* he that taketh reward to slay an innocent person. And all the people shall say, Amen.
 Deu 27:26 Cursed *be* he that confirmeth not *all* the words of this law to do them. And all the people shall say, Amen.

14 :Colossians chap 4 v 1-6 means:

Col 4:1 Masters, give unto *your* servants that which is just and equal; knowing that ye also have a Master in heaven.
 Col 4:2 Continue in prayer, and watch in the same with thanksgiving;
 Col 4:3 Withal praying also for us, that God would open unto us a door of utterance, to speak the mystery of Christ, for which I am also in bonds:
 Col 4:4 That I may make it manifest, as I ought to speak.
 Col 4:5 Walk in wisdom toward them that are without, redeeming the time.
 Col 4:6 Let your speech *be* alway with grace, seasoned with salt, that ye may know how ye ought to answer every man.

5 :Shalom means: ~ SLVM~ destruction of the learning that secures the chaos

6 :POTUSA means: President: The united States of America- understanding the organic Constitution for the united States of America, 'TheCftUSofA',- citizen-government-services-provider

:POTUSA-CIC means: :POTUSA-CIC UNDERSTANDS COMMON LAW OF THE REPUBLIC- GOVERNMENT –

:i- man believe and declare that the POTUSA-CIC's duty and obligation to comply with the common- law and equity -stand is required by covenant-recipients for :property-claimed by :i- man- :civilian, -:Negro-Ysrael ~ the ':Concession of England and Ireland to

2020 September Declaration Of :i- man- Adam -:Ambassador to :Yushuah the :Messiah 34 / 62
 From: Darrell-James: Hill, Negro-Ysrael, -:Ohioan-©-1958-A.D., -civilian, :Executor- beneficiary – Without-prejudice



Almighty-God, Peter, Paul,... Holy-Church by :King-John-I of :1213 A.D., 'Concession-1213-A.D.' to the Children-of-Jacob/Ysrael, :House-of-Judah, of :Kingdom-of-Judah/ :Negro-land - African continent, ~ -:direct- beneficiary of the Concession-1213- A.D. -Covenant with Yushuah~'Jesus'~the Messiah;

:POTUSA-CIC OVERSEES :POTUS-Corp -JOB TO GUARANTEE UNALIENABLE RIGHTS -

:i- man-civilian- beneficiary believe that it is :your- duty and obligation to act with the guarantee of the republic-form of :government in the favor of :i-man -civilian- :Executor- beneficiary against any offender and, also including the United-States-corp, to protect the sovereign-core-status of :all- Americans, which includes the :protection of :i- man against the unalienable-Rights encroachment by the the 'United States corp-' government-services-provider/ :POTUS-Corp.

:Commander In Chief, 'CIC' means: Trustee specifically understanding the organic- :TheCftUSofA-1789-1791- A.D. with oath, duty and obligation to the EP-1863-A.D. to protect the unalienable- :Almighty-God -given-rights of :i- man: Darrell-James: Hill, -Negro, -civilian with the Army and Navy, et seq.-military-then forever-after.

7 **:POTUS-Corp means:** President Of The United States, the incorporated government-services-provider ~with the 'United States Constitution Charter' understanding 'The Constitution for the United States of America-' people of the united states of America; and 2) the self-indentured-bonded -:Obligor of the Emergency Banking Act of 1933-A.D., 'EBA-1933-2003-A.D.- Legislative-Trust~Dry-Trust~ who is resolving and managing the dry-trust: EBA-1933-2003-A.D.

:Donald-John: Trump

:i- man-civilian-beneficiary believe that :you-man-:Donald-John are the Trustee -:Trump, -POTUS of the Legislative- Dry-Trust - (Emergency Banking Act of 1933 A.D., 'EBA-1933-A.D'. The only MAGA possible is where the people-abused are TRULY FREE AGAIN.

8 **:Donald-John :CIC- :Trustee means:** man -:trustee under the duty, obligation and moral~Oath of Office: 20th day of January, the year our Lord 2016 A.D.~, ministry: as :President of 'The united states of America' ~unincorporated,1776 A.D.- as 'Commander-in-Chief with the :General Order 100 ~Lieber Code~ :24th day, April, the year of our Lord 1863 A.D: under the Declaration of Independence for the united states of America -people by 'The Constitution for the United States of America' .

19 **:Trustee means:** the maintainer of the principal, and pro-active distributor of the benefit to the beneficiary of the proceeds of the Trust- instrument and obligation :in- accordance with the prevailing agreement.

20 **:Donald-John: Trump means:** man-kind of the Earth-planet, :man -:trustee under the duty, obligation and moral~Oath of Office of the Almighty-God: KJV-Book: Isaiah chap 45 v 1-15: Isa 45:1 Thus saith the LORD to his anointed, to Cyrus, whose right hand I have holden, to subdue nations before him; and I will loose the loins of kings, to open before him the two leaved gates, and the gates shall not be shut;

Isa 45:2 I will go before thee, and make the crooked places straight: I will break in pieces the gates of brass, and cut in sunder the bars of iron:

Isa 45:3 And I will give thee the treasures of darkness, and hidden riches of secret places, that thou mayest know that I, the LORD, which call *thee* by thy name, *am* the God of Israel.

Isa 45:4 For Jacob my servant's sake, and Israel mine elect, I have even called thee by thy name: I have surnamed thee, though thou hast not known me.

Isa 45:5 I *am* the LORD, and *there is* none else, *there is* no God beside me: I girded thee,



1619

though thou hast not known me:

Isa 45:6 That they may know from the rising of the sun, and from the west, that *there is none* beside me. I *am* the LORD, and *there is none* else.

Isa 45:7 I form the light, and create darkness: I make peace, and create evil: I the LORD do all these *things*.

Isa 45:8 Drop down, ye heavens, from above, and let the skies pour down righteousness: let the earth open, and let them bring forth salvation, and let righteousness spring up together; I the LORD have created it.

Isa 45:9 Woe unto him that striveth with his Maker! *Let* the potsherd *strive* with the potsherds of the earth. Shall the clay say to him that fashioneth it, What makest thou? or thy work, He hath no hands?

Isa 45:10 Woe unto him that saith unto *his* father, What begetteth thou? or to the woman, What hast thou brought forth?

Isa 45:11 Thus saith the LORD, the Holy One of Israel, and his Maker, Ask me of things to come concerning my sons, and concerning the work of my hands command ye me.

Isa 45:12 I have made the earth, and created man upon it: I, *even* my hands, have stretched out the heavens, and all their host have I commanded.

Isa 45:13 I have raised him up in righteousness, and I will direct all his ways: he shall build my city, and he shall let go my captives, not for price nor reward, saith the LORD of hosts.

Isa 45:14 Thus saith the LORD, The labour of Egypt, and merchandise of Ethiopia and of the Sabeans, men of stature, shall come over unto thee, and they shall be thine: they shall come after thee; in chains they shall come over, and they shall fall down unto thee, they shall make supplication unto thee, *saying*, Surely God is in thee; and *there is none* else, *there is no* God.

Isa 45:15 Verily thou *art* a God that hidest thyself, O God of Israel, the Saviour.

21 :i- man am means: Ibid: 1,2,3,4,5,6,7,8

22 :progeny means: Offspring, Children-Of-Jacob-Ysrael, Issac, Abraham, son of Adam and Eve; of the covenant-rights and unto the atonement of the Messiah-Yushuah of the House of Judah et al.- :i- man -Negro-Ysrael, and the Holy-Church.

23 :not a member of the Synagogues of Satan means: :i- man adhere to the Torah-KJV Holy-Bible- moral -law of the Almighty-God's Holy-Church covenant's unto the Negro-Ysrael-people. See: POTUS-corp -:Trump- Trustee, E.O. No. 13798 § 4, 82 Fed Reg. 21657 (May 4, 2017 A.D.) and the October 6, 2017, 'Federal law Protections for Religious Liberty' by :USAG -:Sessions, against the :federal anti-Messiah- constitutional -religious -dogma- :protection against the :present -deprivation of :unalienable -rights-actions against :Negro-Ysrael, et al.- :i- man -Darrell-James: Hill, -:Executor-beneficiary.

4 :Concession-1213-A.D. means: Concession of England and Ireland of 1213 A.D.; the commitment of King-John-I of Ysrael- England and Ireland, et al.- Ysrael to the Messiah, Peter, Paul and the Holy-Church.

5 :et al. means: and all that is included

:et seq. means: and that which follows

:e.g. means: for example

:i.e. means: in other words

: ' ' means: a noun, fact, direct-object of prepositional-phrase -intent follows

: ' - ' means: a connecting compound word-group

6 :DOI-1776-A.D. means: Declaration of Independence of 1776 A.D.; the covenant with God-Almighty for the freedom of the uSofA-people – United-Colonies – United-States-of-America – from the tyranny of Britain- barbarism.

7 :uSofA means: United States of America beginning as Torah-escaped refugee-individuals

2020 September Declaration Of :i- man- Adam -:Ambassador to :Yushuah the :Messiah 36 / 62
from: Darrell-James: Hill, Negro-Ysrael, -:Ohioan-©-1958-A.D., -civilian, :Executor- beneficiary – Without-prejudice

2022-011769 MISC Page: 1631 of 2782

09/26/2022 09:35:37 PM Receipt #: 22-9381

Rec Fee: \$30.00 Darrell James Hill

Gila County, Az, Sadie Jo Bligham, Recorder



from Britain to the United-Colonies unto 'united States' against tyranny to the coin term United States of America of 1776 A.D., the sovereign people from whom power and authority is derived and the land.

- 28 :**covenant means:** common-law -contract-agreed of a firmer commitment of collateral and obligation
- 29 :**Harm means:** the trespass upon one's unalienable rights resulting :in -damage to the one
- 30 :**STOLEN means:** state of theft when access to :property-acquired is retained without :right.
- 31 :**doctrine means:** dogma- opinion, teaching as laid down by a ecclesiastical organization.
- 32 :**paternalism means:** the attempt to regulate the conduct of community as a father does children, not necessarily benevolent, as may relate to the "bad shepherd" modality
- 33 :**enslavement means:** involuntary, -forced servitude
- 34 :**satanism means:** the doctrines worship-all of the precepts of Satan: steal, kill and destroy.
- 35 :**deprivation means:** deprived means: taken away, strip, hinder from possessing
- 36 :**unalienable means:** un- not, a- to , lien- make hold of;
- 37 :**Derelict means:** unfaithful, neglectful; abandonment.
- 38 :**insidious means:** lying in wait, treacherous, harmful
- 39 :**Jorge-Mario means: present 2020 A.D.-** Trustee-actor for the Concession of 1213 A.D.
- 40 :**socialism means:** theory of social-institution-reorganization control by the government-policy-practices over economic activity unto communal ownership and distribution
- 41 :**PROPERTY-Claimed means:** unalienable-contract-right to possess tangible and intangible things as :one's own, e.g., one's spirit-body's soul, breathing, home-befitting the sojourner.
- 42 :**possessed means:** to have and hold :property -:ownership
- 43 :**Distress means:** extreme -forced- imposition upon the body and mind -:in- anguish -:in-life by the seizure and detention without right or authorization of :all of the private-properties claimed and possessed by :i- man's-unalienable-rights to life, liberty and property.
- 44 :**Law of :Almighty-God means:** Torah, prophets, writings, -:KJV Holy-Bible
- 45 :**nothing stands between the :Almighty-God and :i- man means: KJV-Book: Daniel chap 7 v 9-14.** Dan 7:9 I beheld till the thrones were cast down, and the Ancient of days did sit, whose garment was white as snow, and the hair of his head like the pure wool: his throne was like the fiery flame, and his wheels as burning fire.
- Dan 7:10 A fiery stream issued and came forth from before him: thousand thousands ministered unto him, and ten thousand times ten thousand stood before him: the judgment was set, and the books were opened.
- Dan 7:11 I beheld then because of the voice of the great words which the horn spake: I beheld even till the beast was slain, and his body destroyed, and given to the burning flame.
- Dan 7:12 As concerning the rest of the beasts, they had their dominion taken away: yet their lives were prolonged for a season and time.
- Dan 7:13 I saw in the night visions, and, behold, one like the Son of man came with the clouds of heaven, and came to the Ancient of days, and they brought him near before him.
- Dan 7:14 And there was given him dominion, and glory, and a kingdom, that all people, nations, and languages, should serve him: his dominion is an everlasting dominion, which shall not pass away, and his kingdom that which shall not be destroyed.
- 46 :**lineage-covenants means:** ibid 2.
- 47 :**Barack-Hussein means:** the POTUScorp.- -B.A.R.- member, in office before Donald-John.
- 48 :**EBA-1933-2003-A.D means:** Emergency-Banking-Act of 1933 A.D. creating the largest cestui-que-vie- trust for the entire uSofA- :then and thereafter and placing the :all-property of the uSofA as surety for the bankrupted 'United-States-corp-' government-provider to protect the FRA-1913-A.D.- banking system from collapse by people surging the banks upon the

2020 September Declaration Of :i- man- Adam -:Ambassador to :Yushuah the :Messiah 37 / 62
from: Darrell-James: Hill, Negro-Ysrael, -:Ohioan-©-1958-A.D., -civilian, :Executor- beneficiary – Without-prejudice

2022-011769 MISC Page: 1632 of 2782

09/26/2022 03:35:37 PM Receipt #: 22-9381

Rec Fee: \$30.00 Darrell James Hill

Gila County, Az, Sadie Jo Bingham Recorder



loss of confidence ~instigated by the 'instant -immediate- :call-on-any-loan-option' at the height of the the 1928 A.D.- prosperity.

49 **:silent -acquiescence with :tacit -procuration means: silence means 'tacit' .**

Acquiescence means: agree to :that contract offer. **Procuration** means: to respond with :no -defense and with agreement then-after to :all- prosecution of the contract -agreement.

POTUSA-CIC -Trustee -Tacit- Acquiescence and Tacit- Procuration to Theft-of-Property of :i- man- beneficiary

:i- man believe and declare that for the tacit-acquiescence of the three (3) – lots of :property-claimed, and none-else, is tantamount to the theft of the lots of :property-claimed and is the present-standing at this signing of the a) POTUSA-CIC -Trustee: tangible and in-tangible unalienable-rights, and b) :POTUS-Trustee: EBA-1933-2003-A.D., :in -Willful-Dereliction prejudiced- against :i- man -:beneficiary -:Executor- :Darrell-James: Hill, -:Negro- Ohioan-©-1958-A.D., -:civilian, -:beneficiary, such as to deprive :i- man's -:unalienable-right to own, possess and forever privately -utilize :all of the Property-claimed by :i- man's Executor.

50 **:Restoration means:** the condition as the state of determination-induced upon the enduring commitment to again assert to impose the former health-state by meticulous compiling and completing of the elements-in-place to address any deficit to the foregoing health-state before it was lost or stolen, reestablishing.

51 **:STOLEN means:** state of theft when access to :property-acquired is retained without :right. **:theft means: Stolen-Property –**

:i- man believe that :property-claimed and possessed un-lawfully- deprived to the owner -:Darrell-James: Hill, -:civilian, -:beneficiary after the :unalienable- right for the restoration of the property is exercised by the specialty -request/requirement/demand-presentment(s) upon the Trustee -:POTUSA- CIC, et al. > man- Donald-John: Trump, over-standing the -:POTUS- Trustee -:Trump, et al. - man- actors, that the property-claimed is patently stolen-property: –

a) **:TRUSTEE- dereliction - wanton taking -Fiduciary -wrong-doing is :trespassing,** violation of :fiduciary duty-and-obligations with :theft of :private property, tangible and in-tangible, received and withheld by :you- trustee- POTUSA- CIC, -POTUS with :no- right nor authorization; and,

b) **:NO RECEIPT NOR RECORD IS EFFECTIVELY STOLEN-PROPERTY**

:i-man believe and declare that much real- and chattel- property has been held with No- right, nor receipt-provided, neither notice-to :i-man nor :authorization-otherwise from :i-man, and effectively-stolen from :i-man by :you-Donald-John, -:Trustee Trump, et al., in direct violation of the inherent unalienable law, and fraud with: Concession-1213-A.D., DOI-1776-A.D., :TheCftUSofA-1789-1791- A.D., et al. also including the EP-1862-A.D. Thereto:

c) **:i:man- beneficiary -Right to Property According to Common-law: POTUSA-CIC -**

:i- man -:Executor- beneficiary believe that the Trustee- fiduciary -:duty and obligation to the beneficiary ought-always -to -be :remedy and recourse post-haste-met upon the mere-request by the Executor- :i- man -:Darrell-James, Hill- :civilian, -:beneficiary.

2 **:Remedy And Recourse means:** refers to the private-property-claimed where the remedy- :recourse encompasses the common-law and equitable relief to both compensate loss and to absolutely halt further harm and/or damage according to the prevailing-covenants and contracts-agreed for the deprivation of :unalienable-rights to life, liberty and property. See: Attachment D.

3 **:Prevailing Agreement means:** the obligation is secure upon the lasting contract-agreed

2020 September Declaration Of :i- man- Adam -:Ambassador to :Yushuah the :Messiah 38 / 62
from: Darrell-James: Hill, Negro-Ysrael, -:Ohioan-©-1958-A.D., -civilian, :Executor- beneficiary – Without-prejudice

2022-011769 MISC Page: 1633 of 2782

09/26/2022 03:35:37 PM Receipt #: 22-9381
Rec Fee: \$30.00 Darrell James Hill
Gila County, Az, Sadie Jo Bingham, Recorder



54 :unalienable-law means: Jehovah's Law: Torah- KJV, et al., – :Concession-1213-A.D., – :DOI- 1776-A.D. That which can only be changed by God-Almighty, e.g., you are composed of atoms.

:Unalienable-Law of Almighty-God: :- man believe and declare that :- man-Adam- :Negro-Ysrael: -unalienable- rights are from the Almighty-God's- unalienable- law of the lineage-covenants to :man-kind, earth and the heavens :where the :obtence of :property-claimed by :-man is a common law and equity-claim matter.

55 :unalienable-Almighty-God-given-rights means: choices or otherwise-considerable- opportunities for :chosings that are not subject to :man-creations' preferences of the presence or absence of the :same-said-rights, they cannot be disposed-to-others. Rights can only be enabled or deprived.

Unalienable Rights from Unalienable Law

:- man believe and declare that :- man-Adam- :Negro-Ysrael: -unalienable- rights are from the Almighty-God's- unalienable- law of the lineage-covenants :where the :obtence of :property-claimed by :-man is a common law and equity-claim matter.

56 :Torah- KJV, et al. means: Torah, et al.- the law of the Jehovah-God. KJV is the observant- Translation of the Torah, et al., acquired by Almighty-God to :us-man

57 :DOI-1776-A.D. - Unalienable-rights Beneficiary is :Negro-Ysrael, et al. –

:- man believe and declare that the :DOI-1776-A.D. -covenanted -unalienable- rights beneficiary is the :Negro-Ysrael- :Concession-1213-A.D.- DOI-1776-A.D. -covenant- people.

58 :DOI-1776-A.D. - Unalienable- rights- Stipulation –

:- man believe and declare that the DOI-1776-A.D. -covenant-stipulation with Almighty-God for “unalienable rights” is the :Almighty-God-standard with the 'United-Colonies' and the representatives of the 'United States of America' of 1776 A.D., 'UC-USofA-1776-A.D.'. - See: KJV- Book: Leviticus chap 25; Malachi chap 3

59 :DOI-1776-A.D. - Unalienable- rights- Stipulation –

:- man believe and declare that the God-Almighty- DOI-1776-A.D.-covenant freed all of the man-kind on the land, and did not enslave :His -chosen-people, :Negro-Ysrael / -:House of Judah/ -:Children of Jacob/ Ysrael, of the Almighty-God according to the law given to Moses.

60 :DOI-1776-A.D. - Unalienable- rights- Stipulation –

:- man -:civilian -beneficiary believe and declare that :-man accept and agree to the truth of the God-Almighty- DOI-1776-A.D.-covenant - stipulation of :unalienable rights for the Almighty-God's chosen- people Negro-Ysrael / -:House-of-Judah/ Ysrael understanding :His -'Laws of ... Nature's, God' agreed-to in the DOI-1776-A.D. -:Almighty-God -covenant with the United- Colonies by the B.A.R. -representatives of the united States of America of 1776 A.D.

61 :DOI-1776-A.D. - Unalienable- rights- Stipulation –

:-man accept that the God-Almighty- DOI-1776-A.D.-covenant was for the freeing of :- man: Darrell-James: Hill, beneficiary, the progeny of the Negro-Judah/ -:Children-of-Ysrael

62 :DOI-1776-A.D. - Unalienable- rights- Stipulation –

:-man Accept the God-Almighty- DOI-1776-A.D.-covenant of freedom that was wrong-fully and fraudulently- denied to the Negro-Ysrael/ Children-of-Jacob/Ysrael -ancestry of :- man-beneficiary.

63 :birth-location-law means: that wherever one is birthed into the quantum-biology is the substance of where they are; it is the a mere triangulation-location on the soul's arrival.

64 :TheCftUSofA-1789-1791-A.D. means: The Constitution for the uSofA- people-control- system for :man-trafficking and profit-taking with an abject-enslavement system of the Negro-Ysrael- people in a 'Roman-' Christian nation-confusion: that is, while a) professing to believe



:in the son of the Most-High-God of the Abraham, Isaac and Jacob- lineage-covenants the believing Jesus the Christ as the Messiah-Yushuah.

65 :**TheCftUSofA-1789-1791-A.D. means: :Abject-Oppression upon the Negro-Ysrael – In The uSofA The :Abject-Oppression upon the Negro-Ysrael/ Children-of-Jacob/Ysrael, -:despised- minority-populaton was not 'Christian' behavior of the Messiah-Yushuah~Jesus~, as described in the Torah, et al.- KJV-Bible. The uSofA proceeded upon the perverted- :Roman-Church -doctrine :in- dishonor to the oath, duty and obligations to the Concession-1213-A.D. that specifically charged upon the Trustees and covenant-recipients to protect the :House-of-Judah/Ysrael and the :Holy-Church-people.**

:i- man believe and declare that the united States of America are of the Judah-Torah-Christian -national heritage of the Messiah from the tribes of :Ysrael. :Yushuah's atoning-sacrifice is :FOREVER done from the Ysrael- Christian -Forefathers who are the same Ysrael- people this America professionally -despises with the policies of the social-institutions imprisoning the :uSofA- people into communal-criminal- actions.

66 :**BOR-1791-A.D. means: Bill-of-Rights 1791 A.D.; additional stipulations to the constitutional restriction upon the new citizen-government for the uSofA- people.**

67 :**The Concession-1213-A.D.- TheCftUSofA-1789-1791-A.D. nexus means: --United Colonies of 1776 A.D. with Concession-1213-A.D. -:Anti-Ysraelism - :Anti-Messiahism-polytheism-pantheism-philosophy**

:i- man believe and declare that by the uSofA corroboration of the 'Concession-1213 -A.D.-Fraud is TheCftUSofA-1789-1791- A.D.- unalienable-right -fraud by the Trustee dereliction with the violation of the fiduciary- duty and obligations to the Negro-Ysrael/-:Children of Jacob/Ysrael on the uSofA- land.

68 :**ACW-1861-1865-A.D. means: American Civil War of 1861 to 1865 -:hegelian dialectic that for the European-American World leaders to subjugate the :southern-uSofA- states, and opportunistically ended slavery in the southern-states- uSofA, breaking their perverted financial 'independence' upon the enslavement of the Negro-Ysrael -:people of the Almighty-God.**

69 :**ACW-1861-1865-A.D.- Ended unlawful- illegal trafficking and enslavment – The American-Civil-War of 1861 -1865 A.D., 'ACW-1861-1865- A.D.'**

:i- man believe and declare that during the American- Civil- War of 1861- 1865 A.D. with the Executive-Order -:'Emancipation Proclamation of 1862 - 1863 A.D., 'EP-1863-A.D.', ended the :unlawful, -:Constitutionally- legalized, -:trafficking and abject- enslavement of the Negro-Ysrael -people; Not ending the sundry :wrong-doings and harms upon the people; but, rather, was the penalty of the known- wrong-doing ceased to undermine the insurrectionist-economically- slave-based – economiies of the uSofA- :Negro-Ysrael- :people-control-system.

70 :**EP-1863-A.D means: :Executive-Order -:'EMANCIPATION Proclamation Of 1862 - 1863 A.D., 'EP-1863-A.D.' –**

January 01, 1863, the POTUSA-CIC of the United States government of 1863 A.D. committed to protect :i- man -:Negro-Ysrael, -:uSoA -member -:Ohioan-©-1958-A.D. of the non-political -:aggregate FOREVER by the EP-1863-A.D. over-standing the :All- policy in regard to the Negro-Ysrael people enduring the torment of the abject- enslavement by uSofA- "Christians" upon the House of Judah since on or about 1619 A.D.

71 :**EP-1863-A.D - Forever and Military-Protection of Freedom Accepted –**

:i- man ACCEPT, Without Prejudice, and believe and declare that by the mere

2020 September Declaration Of :i- man- Adam -:Ambassador to :Yushuah the :Messiah 40 / 62
From: Darrell-James: Hill, Negro-Ysrael - :Ohioan-©-1958-A.D., -civilian, :Executor- beneficiary – Without-prejudice

1624
2022-011769 MISC Page: 1635 of 2782
09/26/2022 03:35:37 PM Receipt #: 22-9381
Rec Fee: \$30.00 Darrell James Hill
Gila County, Az, Sadie Jo Bingham, Recorder



fiduciary duty and obligations required from the POTUSA-CIC, et al.- military- generals of the EP-1863-A.D., that the 'United States government-services-provider' of 1863 A.D. committed to forever-after assure and specifically-protect -i- man- progeny -:Darrell-James: Hill, :Negro-Ysrael/ 'The House of Judah' from the any :deprivation of :unalienable-rights.

72 :EP-1863-A.D DEMARCATED LEGAL-CONSTITUTION-FREEING OF :i- man PROGENY -NEGRO-YISRAEL-1863. A.D. BY POTUSA-CIC -EXECUTIVE -ORDER –

:i- man believe and declare that the Emancipation Proclamation of 1863 A.D., 'EP-1863-A.D.', et seq., demarcated the legal - constitutional -freeing of the :i-man- Negro -predecessors, as the :punitive-measure against the secession-states of America, e.g., Arkansas, Alabama.

73 :EP-1863-A.D. -Trustee Dereliction AGAINST :i- man -Negro-Ysrael, :civilian-beneficiary –

After the ACW-1861-1865-A.D., the Negro-Ysrael- :Concession-1213-A.D. -DOI-1776-A.D.-covenant -beneficiary -people continued forced to endure the :intense -paternal-control-systems honed and permitted under the uSofA-Trustee- Dereliction of :duty by: TheCftUSofA-1789-1791- A.D., et al- policies with aiding and abetting violations against the Children of Judah/Ysrael, and legislatively depriving the :Negro-Ysrael- :DOI-1776-A.D.-covenant- beneficiaries' -unalienable -rights life, liberty and property :in despise of the EP-1863-A.D.

74 :EP-1863-A.D Freed an injured, demoralized man-kind :in -PTSD –

:i- man believe and declare that EP-1863-A.D. freed a demoralized- :PTSD-mass of :damaged -man-kind onto the socio-economic and cultural despise and racism -policies aided and abetted by :TheCftUSofA-1789-1791- A.D. with continued Trustee -dereliction and with violation of the fiduciary -duty and obligations relentlessly destroyed:lives, economy, and families of he Negro-Ysrael- :Concession-1213-A.D. -DOI-1776-A.D.-covenant- beneficiary-people.

75 :Lieber-Code-1863-A.D. Means: General Order 100 of 1863 A.D. ~Lieber-Code~, et seq. -Law-of-War means: modi operandii of the uSofA- government of 1863-A.D. -war-footing-

governing-guidelines for the uSofA- military treatment of :individual- enemy-categories; e.g., :soldiers, civilians, :ambassadors, for :etc.- people, freedom and property during the occupation, et al.

76 :legislative-indenture means: The POTUS of the United-States-Corp of 1933 A.D.- government-service-provider's additional- contract-self-indenture to the uSofA-people with debenture-bond, i.e., the :Certificate-of-Live-Birth, additional services-provider- obligation a.k.a. the 'new deal ~method of business and manner of conduct~' to counter the :absence-of-confidence in the 1928-1933 -:FRA-1913-A.D. Bankruptcy of the U.S.corp -FRA system for :monetary- to currency- expansion plans of the United-States-corp government and TRUSEE of the EBA-1933-2003-A.D.- self-indenture.

77 :FRA-1913-A.D. means: The third-party, -Private-corporation- management of the financial-state and money to fiat currency management-system of the uSofA- system.

78 :EBA-1933-2003-A.D. , New-Deal Presumption -U.S.-Citizenship Rights –

The :Emergency-Banking-Act of 1933-2003- A.D., '~ ' converted the corporate government/ FRB- bankruptcy(?) into the 'cestui-que-vie-trust-' :system, converting :all of the assets-obtainable from the uSofA- people into a promissory-note- fiat-currency -exchange creating rights and privileges for the 'secured-creditor' by the debenture-bond given to each uSofA- beneficiary, now -:presumed- wards under the presumed- color of ':statutory-' private-law-system with the presumed -B.A.R. Rules in the courts' -interfaced with the subrogation presumption of :legal-standing with the rights and privileges under the United-States-corp-'

2020 September Declaration Of :i- man- Adam -:Ambassador to :Yushuah the :Messiah 41 / 62
From: Darrell-James: Hill, Negro-Ysrael, :Obian @ 1958-A.D., -civilian, :Executor- beneficiary – Without-prejudice

1625
2022-011769 MISC Page: 1636 of 2782
09/26/2022 03:35:37 PM Receipt #: 22-9381
Rec Fee: \$30.00 Darrell James Hill
Gila County, Az, Sadie Jo Bingham, Recorder



government service, et seq. - *IMF-, **WB-, etc.- the :1933 A.D. 'New Deal'-system. *IMF- International Monetary Fund, **World Bank

79 :EBA-1933-2003-A.D. -:'United States Corp-' Government- :Bankruptcy' With Suretyship And Debenture Of The Usofa- People-In-Trust –

:i- man -:Executive- :beneficiary believe that the EBA-1933-2003-A.D. -:bankruptcy'- suretyship of the uSoA- people- trust was completed on-in-or-about :2003- 2013 A.D., after 70 - 80 years.

80 :EBA-1933-2003-A.D. EBA-1933-2003-A.D. IS DONE, -OVER, -DRY -:TRUST. :ACCOUNT, SETTLE-AND-CLOSE IT –

:i- man have formally requested the :settle and closure of the accounts for :i- man because the :purpose of the trust in the POTUS-Corp -Roosevelt's 'New Deal' is now completed, i.e. ':dry trust'. But, there are :your-actions :in-evidence to suggest that you have purposed to steal the :Trust- property-claimed and possessed by :i- man- beneficiary.

81 :EBA-1933-2003-A.D.-TRUST ACCOUNTING, SETTLE AND CLOSURE DEMANDED = PROPERTY STOLEN? –

The POTUS-Corp' -:Emergency-Banking-Act of 1933 A.D., 'EBA-1933-2003-A.D., Legislative - Dry-Trust, ' is now-presently a 'dry-trust', PRESENTLY operated in fraud/ AGAINST :i- man's--unalienable-right for what-appears-to-be the theft of the substance of the trust of :i- man -:Negro-Ysrael, -:citizen, -:Ohioan-©-1958-A.D., -:Executor- :beneficiary with depriving the :obtencence of :Account-to-the-penny unto the Settle-and-closure of the EBA-1933-2003-A.D., -:Legislative- Dry-Trust for :i- man -:Negro-civilian, Ohioan-©-1958-A.D.- birth -:EBA-1933-2003-A.D., -:Executor- :beneficiary, -:Darrell-James: Hill with No lawful or legal-right, nor justification or notice to :any- effect --- :Thievery.

82 :EBA-1933-2003-A.D. – PROPERTY-CLAIM INFORMATION IGNORED –

:i- man- Negro-civilian -beneficiary, :Executor believe that at the end of the emergency-banking-act, :EBA-1933-A.D.- :Legislative- Dry-Trust Account, the option for the demand-reports, and settle and closure of the accounts is for :i- man-Negro- civilian -beneficiary: Darrell-James: Hill (c) Ohioan-©-1958-A.D. to receive the any property-claim- :authenticated and verified.

83 :TWEA-1917-A.D. means: rules for commerce assisting the enemy relevant to WWI. The :Enemy-category did not presume to include the :uSofA- people as the political-election of ':enemy of :unknown-statuses – i.e., guilty until proven innocent'.

84 :Trading With The Enemy Act of 1917 A.D., as amended with :EBA-1933.-2003-A.D., means: the identification of the enemy- civilian- TheUSofA-people as related to the national emergency banking crisis of :1933 A.D. ~ :banking- emergency- crisis -legislatively- ended: 1976 A.D.

:TWEA-1917-A.D., as amended means: Trading-With-The-Enemy-Act of 1917 A.D., as amended with :EBA-1933.-2003-A.D.; means: the identification of the uSofA- people as the "enemy" in the 'emergency' in such a manner as the United-States-corp -persona will then-to- now assume that :i- man: :Darrell-James: Hill, -:Negro- Ohioan-©-1958-A.D., -:civilian, and :beneficiary of the EBA-1933-2003-A.D.- Trust, will be presumed to be the idem-sonans -subrogation<fiction>-persona entitled, 'DARRELL JAMES HILL', et al.- :etcetera-derivatives, in :sundry- instances and applications. Related to the national emergency banking crisis- 'U.S.-corp-' bankruptcy of :1933 A.D.: emergency- crisis -legislatively- ended: 1976 A.D. with the bankruptcy-holding requirements ending :in -2003 A.D.

85 :National Emergencies Act of 1976 A.D. means: NEA-1976-A.D. Means: Public Law 94-412; 90 Stat. 1256; the :formal, -:legislative- end to the EBA-1933-2003-A.D.- 'emergency', BUT did not (i) end the 'enemy-status-' presumption upon :all of the uSofA-people, and (ii) did

2020 September Declaration Of :i- man- Adam -:Ambassador to :Yushuah the :Messiah 42 / 62
From: Darrell-James: Hill, Negro-Ysrael, -:Ohioan-©-1958-A.D., -civilian, :Executor- beneficiary – Without-prejudice

2022-011769 MISC Page: 1637 of 2782

09/26/2022 03:35:37 PM Receipt #: 22-9381
Rec Fee: \$30.00 Darrell James Hill
Gila County, Az, Sadie Jo Bingham, Recorder



- not close the cestui-que-vie- Trusts back to the uSofA- people (the 'new slaves').
- 86 :**Cure and Relief means:** terms in use for the restoration of loss, prevention of recurrence.
- 87 :**Perfect-Equity-Claim means:** common-law with equity-claim in accordance with the prevailing contract-agreed; where the only obligation remaining is the delivery of the property.
- 88 :**Specialty- Presentment: To The Roman -Church, et al.- Usurpers, For the Cure and Relief -in the :Equity-Claim, and For the Remedy-Required For the Trespassing Upon The Children of Ysrael/Israel, et al.** means: the document to the men - Jorge-Mario and Donald-John a) reporting, exposing and outlining the :foundation of :fraud, and b) declares :violations by :Trustee-actors, c) requires remedy-forthwith, and d) cure as e) directed by God-Almighty. See: Attachment B: re: the :restoration of the unalienable-rights and property-claimed and possessed by :- man, sole, and kinsman-redeemer.
- 89 :**FRAUD means:** an intentional perversion fo truth for the purpose of inducing another in reliance upon to part with some valuable thing belonging to him or to surrender a legal right... . A generic term, embracing all multifarious means which the [man] ingenuity can devise, and which are resorted to by one individual to get advantage over another by false suggestions or by suppression of truth, and also includes all surprise, trick, cunning, dissembling, and any unfair way by which another is cheated. – In the nature of the Black Law dictionary, 4th Ed., pg: 768-769.
- 90 :**Concession-1213-A.D. FRAUD**
 a. :- man believe and declare that the Roman-Church- Trustee- Dereliction and violation of the fiduciary- duty and obligations began in fraud and has sustained-itself with frauds upon the Children-of-Jacob/Ysrael, et al.- Negro- Ysrael- Africans enslavement, and the world.
- 91 :**Roman-Church- Trustee -TheCftUSofA-1789-1791-A.D.- :harms: Fraud – United Colonies of 1776 A.D. with Concession-1213-A.D.- :Anti-Ysraelism - :Anti-Messiahism-polytheism-pantheism-philosophy**
 a. :- man believe and declare that the uSofA corroboration of the 'Concession-1213 -A.D.-Fraud, TheCftUSofA-1789-1791- A.D.- unalienable-right -fraud by Trustee- Dereliction with violation of the fiduciary- duty and obligations to the Negro-Ysrael/-:Children of Jacob/Ysrael in the uSofA- land by the deprivation of :unalienable- Almighty-God-given-rights.
- 92 : **Trustee- Dereliction means: Roman-Church- Trustee -Dereliction With :Violation of the Fiduciary- duty and obligations: authorized, aided and abetted, the :enslavement of the Negro-Ysrael- :Concession-1213-A.D.-covenant -people**
 a. :- man believe and declare that the Roman-Church- Trustee, et al. authorized, aided and abetted the VERY Specific- :enslavement of the Negro-Ysrael- :Concession-1213-A.D.- covenant -people in the early 17th century with the annihilation for the extinction unto the enslavement of the covenant- people in the 'United British- Colonies' of the America continent.
 b. :- man believe and declare that the fraud by the Roman-Church -Trustee -Dereliction is harming the Negro-Ysrael- beneficiaries, et al.- :- man -Darrell-James: Hill, -:Executor -beneficiary
- 93 **Concession-1213-A.D.- Dereliction: INTENT: Roman-Church -:Trustee Knew Or Should Have Known :Negro-Ysrael- :CONCESSION-1213-A.D.- Covenant -:PEOPLE -:BENEFICIARIES**
 a. **Roman-Church -:Trustee Knew Or Should Have Known :Negro-Ysrael- :CONCESSION-1213-A.D.- Covenant -:PEOPLE -:BENEFICIARIES**
 :- man believe and declare that as :- man am truthful regarding the Concession-of-1213-

2020 September Declaration Of :- man- Adam -:Ambassador to :Yshuah the :Messiah 43 / 62
 From: Darrell James Hill, Negro-Ysrael - :Ohioan@-1958-A.D., -civilian, :Executor- beneficiary – Without-prejudice

2022-011769 MISC Page: 1638 of 2782
 09/26/2022 03:35:37 PM Receipt #: 22-9381
 Rec Fee: \$30.00 Darrell James Hill
 Gila County, Az, Sadie Jo Bingham, Recorder



A.D. -Roman-Church -Trustee -fraud and :Trustee's :dereliction of :duty and obligation and harm to the Negro-Ysrael- :Concession-1213-A.D.-covenant -:people -:beneficiaries – Children-of-Jacob/Ysrael, who they knew or should-have-known.

94 :Concession- Dereliction: Four-Hundred- years-past: Roman-Church -TRUSTEE -DERELICTION Against Negro-Ysrael -Concession-1213-A.D.- Beneficiaries Is :Daily- Dereliction For Four-Hundred Years

a. :i- man believe that the :Roman-Church -Trustee Dereliction of fiduciary- duty and obligation has been daily against :i- man, -:progeny of the Negro-Ysrael- Messiahic-people for :four- centuries!

95 :Roman-Church- Trustee -TheCftUSofA-1789-1791-A.D.- :harms: Deception – :Roman-Church -Trustee-Dereliction Undermined :The United States Of America, 1776 A.D. Unto The Judgment From Almighty-God For TheUSofA-1776-A.D. Violation Of His Law-To-Protect-Ysrael With The Abject-Enslavement For: Four-Hundred Years-Imposed Upon His People The Tribe Of Ysrael/Israel. – House-of-Judah – Negro-Ysrael.

a. The :Roman-Church afforded the :continued -enslavement against the Negro-Ysrael of the Almighty-God within the thirteen colonies, et seq., by the wicked-representatives for the :united States of America, 'uSofA',- people. – It is the successful trap; burdening a -young-fledgling -'Christian' -nation with enslaving the one -people that the Almighty-God -Christian- covenants protect and which brings the curse and judgment for abject-enslavement and terrorism violations against the Holy-Church of the Holy-Bible.

96 :Beneficiaries means:

Negro-Ysrael/ House of Judah are :CONCESSION-1213-A.D.- BENEFICIARIES

a. :i- man believe and declare that the :Negro-Ysrael- :Concession-1213-A.D. -covenanted -:people -:beneficiaries' are Judah, Benjamin and Levi, and the :Holy-Church -:believers of :Yushuah the :Messiah.

b. :i- man believe and declare that the only proper authority- Trustee for the Concession-1213-A.D. are the Holy-Church- members.

c. The Concession of England and Ireland to Almighty-God, Peter, Paul, and .. Holy-Church by King-John-I, of 1213 A.D., 'Concession-1213- A.D.' TO THE ROMAN- CHURCH WAS/ IS IN FRAUD FROM THE BEGINNING.

97 :Concession-1213-A.D.- BENEFICIARIES: I) :Property-Claimed: England and Ireland :Concession-1213-A.D., by the right of the Children-of-Jacob/Ysrael: -Negro-Ysrael-1213-A.D., et al.- :i- man's-unalienable-right, sole, and as kinsman-redeemer to :Negro-Ysrael – House-of-Judah and the :Holy-Church

a. The Concession of England and Ireland to Almighty-God, Peter, Paul, and .. Holy-Church by King-John-I, of 1213 A.D. states that by the right of the Children-of-Jacob/Ysrael: -Negro-Ysrael-1213-A.D. owing to the Concession-1213-A.D., that the: England and Ireland – property is conceded to: i- man: Darrell-James: Hill, :Negro-Ysrael-1213-A.D., et al.- the :Holy-Church.

b. :i- man believe and declare that the Concession-1213-A.D. gave all of England and Ireland to the House-of-Judah and the Holy-Church of :Almighty-God the Messiah.

c. Claim on this matter for the accounting has been made to the appointee: Jorge-Mario: Bergoglio, -Trustee -Roman-Church in the ':For the Cure and Relief -in the :Equity-Claim, and For the Remedy-Required For the Trespassing Upon The Children of Ysrael/Israel, et al.; To:Jorge-Mario: Bergoglio :USPS RMN RE 322 387 576 US; c/o Apostolic Palace, 00120 Vatican City, c/o :Donald-John :CIC- :Trump :USPS RMN RE 322 387 562 US; 1600 Pennsylvania Ave NW, Washington, District of Columbia 20500; APPENDED: 7 PAGES,

2020 September Declaration Of :i- man- Adam -:Ambassador to :Yushuah the :Messiah 44 / 62
From: Darrell James Hill -Negro-Ysrael-1213-A.D., -civilian, :Executor- beneficiary – Without-prejudice

2022-011769 MISC Page: 1639 of 2782

09/26/2022 03:35:37 PM Receipt #: 22-9381
Rec Fee: \$30.00 Darrell James Hill
Gila County, Az, Sadie Jo Bingham, Recorder



ATTACHMENT B: -wholly-Incorporated by-this- reference.

98 :Jorge-Mario: Bergoglio means: man-kind of the Earth-planet

99 :Babylon- Rome means: KJV- Book :Daniel chap 2.

100:Rome means: KJV- Book: Obadiah-- chap. 1; Psalms chap 83.

101 :Ibid. 16, 17, 18, 19, 20; Donald-John: Trump means: man -:trustee under the duty, obligation and moral~Oath of Office: 20th day of January, the year our Lord 2020 A.D.~, ministry: as :President of 'The united states of America' ~unincorporated, 1776 A.D.~ as 'Commander-in-Chief with the :General Order 100 ~Lieber Code~ :24th day, April, the year of our Lord 1863 A.D: under the Declaration of Independence for the united states of America -people by 'The Constitution for the United States of America' .

102 :Ibid. 100; Donald-John: Trump means: man-kind of the Earth-planet, :man -:trustee under the duty, obligation and moral~Oath of Office

103 :Incorporated-by-reference means: to declare that another document must be taken as part of the document in which the declaration is made as much as if it were set out at length therein. – in the nature of Black's Law dictionary, 4th Ed., p 907.

104 :Concession-1213-A.D.: Satan's Role means:

- a. Satan, et al. -harmers: steal, kill and destroy by Torah, et al.- writings, history.
- b. Satan, et al. has hunted the lineage of the Messiah since the Garden of Eden to now.
- c. :i- man believe that the lineage from Adam unto the birth of the Messiah was always identified and targeted by Satan (ref: Noah) in order to dis-enable the birth and life of :Yushuah-the-Messiah that is and was to come;
- d. Satan, et al., lost in the gambit to hide him from judgment.
- e. And, :i-man observe, believe and declare that since loosing-all-rights to the planet and the threat of :death upon man-kind, Satan, who has **ALREADY BEEN JUDGED**, and whose pride and evil against the Most-High-God expanded beyond man's capacity to comprehend, is operating to merely, ultimately, destroy :all of :man-kind to remove the any obligation to the judgment.

105 :Concession-1213-A.D.- Danger of Continued-Harm From Roman-Church – :NOTICE: **DANGER FROM THE ROMAN-CHURCH, et al.- ACTORS**

5.vi) :i- man now to forever-present need daily- 24 hour security for mere saftety from the Roman-Church- actors and doctrinal- zealots.

Danger to Negro-Ysrael, et al. - :i-man beneficiary

Demand: Cease and Roman-Church-Trustee and POTUScorp Anti-CHILDREN-of-Ysrael- activity

:i- man do not give you authority to comply with :any- Roman-Church -Trustee -Dereliction harmful to the Negro-Ysrael- American- people, et al- Ysrael.

:Danger From The Roman-Church, et al.- Actors–

5.i) :Where, as the despise- plot for the Negro-House of Judah/ Children-of-Jacob/Ysrael aspired the Roman-Church, et al., to the annihilation for the extinction unto the abject-enslavement upon the Negro-Ysrael- :Concession-1213-A.D.-covenant- people, and;

5.ii) :where, as now this dishonor, dereliction with malfeasance is exposed, and;

5.iii) :where, as the accountability of the wrong-doing is now :prominent in the spirit and minds of the previously deceived-world, and;

5.iv) :where :i- man require reparations from the :Roman-Church -:Trustee- dereliction,

5.v) :i- man discussing these facts attracts the insidious-danger of :personal- harm from the :Roman-Church, et al.- actors or proxies; and:

:NOTICE :DANGER FROM THE ROMAN-CHURCH, et al.- ACTORS

2020 September Declaration Of :i- man- Adam -:Ambassador to :Yushuah the :Messiah 45 / 62
From: Darrell-James: Hill. Negro-Ysrael. -:Ohioan-@-1958-A.D., -civilian, :Executor- beneficiary – Without-prejudice

2022-011769 MISC Page: 1640 of 2782

09/26/2022 03:35:37 PM Receipt #: 22-9381

Rec Fee: \$30.00 Darrell James Hill

Gila County, Az, Sadie Jo Bingham, Recorder



DEMAND: Cease Roman-Church -Trustee Threat

:i- man- Negro-Ysrael- :Concession-1213-A.D. -beneficiary demand for: Cease and Desist of the Roman-Church -Trustee - 'United States government- Trustee Derelictions of the Duties and Obligations to the Negro-Ysrael- :Concession-1213-A.D. - DOI-1776-A.D. -covenant- people -:beneficiary -i- man- :Executor -Darrell-James:Hill.

106 :Harm means: from the trespassing upon the other's :unalienable-rights is with the resulting -injury and damage to the other.

107 :Harm From The Roman-Church-Trustee- Dereliction, And Violation Of The Fiduciary Duty And Obligations

:i- man believe and declare that :i- man NEED: Twenty-Four (24) Hour Body-Guard Protection For Harm From The Roman-Church For Requesting The Accounting And Restoration Of Concession-1213-A.D. -property- Claimed By The Proper- Authority Of The Concession-1213-A.D. -beneficiary That Was Targeted For Extinction By Trustee- Dereliction.

Harm From The POTUSA-CIC and POTUScorp -Trustee- Dereliction, And Violation Of The Fiduciary Duty And Obligations

:i- man believe and declare that :i- man NEED: Twenty-Four (24) Hour Body-Guard- Protection For Harm From The United-States-Corp For:

- a) Property-Claimed That Has Been Stolen By/ With The Current POTUScorp, et al., and,
- b) Requirements Are Ignored For The Accounting For Settle And Closure Of The :EBA-1933-2003-A.D.- Legislative- Dry-Trust, -:PROPERTY-CLAIMED By :i- man -:Executor, -:beneficiary.

:Deprivation of :Unalienable- Rights Imposes Harm by theft

:i man: Darrell-James: Hill, -:civilian, -:Executive- :beneficiary believe and declare that :i- man must-ostentatiously present and declare to :you -:Donald-John: Trump, -:Trustee, et al., that :property belonging to :i- man-beneficiary has without right been apparently stolen by :you- Donald-John, -:in -Trustee -dereliction, :in-violation of :the fiduciary- duty and obligation to protect, not steal and not compete to possess the propertis of :i- man -:beneficiary:

- a) unalienable-Rights-from-God-Almighty /;POTUSA- CIC, - Attachment B
- b) Property-Claimed #1 /;POTUSA- CIC, - Attachment C, D
- c) Property-Claimed #2 /;POTUSA- CIC, - Attachment C, D
- d) Property-Claimed #3 /;POTUSA-CIC, - Attachment C, D and:
- e) you-Donald-John, et al.- POTUS, APC, CLT, USAG have answered in the silent-acquiescence and failed to account, settle-and-closure of the EBA-1933-A.D. -cestui-que-vie -subrogation, et al.- derivatives - accounts by :POTUS. - Attachment E.

108 :Harm endured: HARM UPON THE UNALIENABLE-GOD-ALMIGHTY- GIVEN- RIGHTS

:i- man -Negro/Ysrael- Ohioan-©-1958-A.D., -:Executive- :beneficiary believe and declare that your deprivation of the private-property-claimed imposed 1) :harm and 2) :unlawful-illegal -deprivation of the unalienable-rights of :i- man to :possess and manage, and use as :i- man see-fit, the :private property that you have stolen/detained-without-right.

109 :Harm endured: ENSLAVEMENT by DEPRIVATION OF :UNALIENABLE -RIGHTS, WITH :PATERNALISM

:Same, is indicative and demonstrative of the unwanted -paternalism historically identical to that which is the enslavement-means over the Negro/Ysrael -uSofA- abject- apartheid-era, as discrimination and brutality creatively-honed :hardship upon :i- man the :progeny of the disenfranchised -:Negro/Ysrael -beneficiary, -civilian, -:uSofA in the :enslaved- people-control-system; which Now is the EBA-1933-2003-A.D.- system.

110 :Harm endured: Betrayal of Trust: :THEFT : Unlawful-Detainment Of :i- man -:Executor-

2020 September Declaration Of :i- man- Adam -:Ambassador to :Yushuah the :Messiah 46 / 62
From: Darrell-James: Hill Negro-Ysrael :Ohioan © 1958-A.D., -:civilian, :Executor- beneficiary - Without-prejudice

beneficiary :-Property- Claimed And Possessed by :- man's-unalienable-right :Trustee Dereliction and VIOLATION Of The Fiduciary- Duty And Obligations to Protect :- man's-unalienable-rights to :life, liberty, and property. :- man- civilian- beneficiary believe that :you- :Trustee :-Trump, et al., have unlawfully-stolen and/or detained-in-specie the :property-claimed and possessed by :- man :-Executor- beneficiary and :this is :IN-violation of the fiduciary :-duty and obligation to protect :- man's-unalienable-rights to :absolute- :unalienable-rights to life, liberty and property:-norms.

111 :Harm endured :UNLAWFUL -DETAINMENT OF THE PROPERTY-CLAIMED DEPRIVES :- man's- UNALIENABLE-RIGHT TO LIFE, LIBERTY AND PROPERTY :- man believe that the :POTUSA- CIC- :Trustee, -Trump's Dereliction and violation of fiduciary duty and obligations with the unlawful, illegal and unauthorized detainment of the property of :- man requires that :- man daily-endure the :damages- caused by the non-use of the private -property-claimed to meet the needs of the lifestyle-of :-man to exercise the :long-standing -natural-right of providing the needs of home, transportation, 24-hour-security, and other health-needs for the family of :- man, or ever-else :- man civilian may choose to use private-property-claimed and possessed.

112 :Harm endured: **TO STEAL TRUST- PROPERTY – :INVOLUNTARY SERVITUDE** :- man believe and declare that the 'unalienable- Rights' :-property of the 'DOI-1776-A.D.', was given by :Almighty-God to the Negro/Ysrael :-beneficiaries in THE DOI-1776-A.D.- covenant with the United Colonies, et al- :representatives of the united States of America. Thereto:

MALFEASANT -CONTROL, -TAKING -AWAY :PRIVATE -PROPERTY, SEEKING TO DISPOSSES BENEFICIARY-PROPERTY- CLAIMED AND POSSESSED, :FORCED-NORMALIZATION OF :DEPRIVATION OF :UNALIENABLE-RIGHTS BY MALFEASANCE

:- man believe that :property stolen and/or deprived to :- man is tantamount to the harm of the :involuntary servitude known as the consequence of malfeasance upon the deprivation of the right for :- man to cestui-que-use of the beneficiary-Trust- property.

113 :Harm endured: **:Trustee- DERELICTION IN ERROR WITHOUT CORRECTION AFFIRMS DESPISE-INTENT** :- man believe and declare that the deprivation of the any unalienable-God-given-right by the Trustee- :dereliction of :duty and obligation without :correction tangibly- affirms the :Trustee's -despise of :- man's intangible- unalienable -right to :choice for life, liberty or property in specie, et al.

114 :Harm endured: **:POTUS :-Trustee- :Dereliction, :Failed -Fiduciary- Duty And Obligation To Account For The :Property-Claimed And Possessed By :- Man Beneficiary.** :- man -civilian, -beneficiary, -Executor report and declare that all inquiries for the release of the :all -account-reports- to- :- man-requests have been :all- answered in the silent, -acquiescence with -: tacit- procuration

115 :Harm Endured: **Deprivation of :Republic-Form Of :Government- Duty And Obligation By: POTUSA-CIC and :POTUS -Trustee- Dereliction is Theft From :- man** :- man Believe that the guarantee for the republic-form of :government is the duty and obligation of the POTUSA-CIC and the job-policy of the POTUS; to do otherwise would be to not perform the duty and obligations of the Trustee.

116 :Harm From Roman-Church means: Ibid. 87-96, 103-114.

:ROMAN-CHURCH- TRUSTEE, ET AL.- OF THE UN- 'HOLY-CHURCH', AUTHORIZED THE :ENSLAVEMENT OF THE NEGRO-YSRAEL- :CONCESSION-1213-A.D.-COVENANT -PEOPLE –

:- man believe and declare that the Roman-Church- Trustee, et al. is the 'un- Holy-Church'- Trustee, et al. which authorized, aided and abetted the :enslavement of the Negro-

2020 September Declaration Of :- man- Adam :-Ambassador to :Yushuah the :Messiah 47 / 62
From: Darrell-James: Hill, Negro-Ysrael, :-Ohioan-©-1958-A.D., -civilian, :Executor- beneficiary – Without-prejudice

2022-011769 MISC Page: 1642 of 2782

09/26/2022 03:35:37 PM Receipt #: 22-9381
Rec Fee: \$30.00 Darrell James Hill
Gila County, Az, Sadie Jo Bingham, Recorder



Ysrael- :Concession-1213-A.D.-covenant-people-beneficiary with great specificity and distinction in the early 17th century with annihilation for the extinction unto the enslavement of the covenant- people in the gross -violation by the Roman-Church-: Trustee -fiduciary- duty and obligation to abide the God-Almighty's :unalienable- law, covenants, and rights to the Children of Jacob/Ysrael, et al.- Negro-Ysrael.

Negro-Ysrael FOR :ANNIHILATION AND EXTINCTION –

:i- man believe and declare that the unrepentant- :Roman-Church -:Trustee is the :amalgam-polytheism of :old -who, et al., specifically aided and abetted the targeting and and hunting of the :Negro-Ysrael- people of the inherent -Abraham, et seq.-Messiah- covenants with the Almighty-God, for :annihilation and extinction unto abject enslavement in the United Colonies of America- 1777 A.D.

:TheCftUSofA-1789-1791- A.D. -deprivation of :unalienable- :Almighty-God-given- rights

:i- man believe and declare that :TheCftUSofA-1789-A.D.-Wrong-Doing upon the Negro-Ysrael- people is with the uSofA-people and representatives acceptance of the 'Concession-1213 -A.D.- fraud by the Roman-Church -Trustee -:Dereliction and willful deception to corroborate harm upon the Children of Jacob/ Ysrael, and to undermine the enslaving nations.

117: **Demand: Cease :Roman-Church and POTUScorp Anti-Negro-Ysrael, et al.- :i- man, activity – ROMAN-CHURCH- TRUSTEE and UNITED STATES-CORP – TRUSTEE must CEASE ALL ANTI-CHILDREN OF NEGRO-YISRAEL- ACTIVITY** against :i- man: Darrell-James: Hill, -:Negro-Ysrael, -:civilian, -:Ohioan-©-1958-A.D., -:Executor- beneficiary of the 'Unalienable Law of Almighty-God' :in-covenant with the Concession-1213-A.D., DOI-1776-A.D, EP-1863-A.D. and EBA-1933-2003-A.D.-legislative, dry- trust-property- claimed. –

Demand: :i- man- Adam, Negro-Ysrael-1213 A.D, House of Judah, require :you- :Roman-Church -:Trustee- Bergoglio, et al. and :you- POTUSA-CIC, -:Trustee- Trump, et al., to immediately cease all further anti- Negro-Ysrael, et al- :i- man- activity.

Roman-Church is the Mother of Harlots. See KJV-Book: Hosea chap 1-2.

:i- man believe that the UScorp government-provider -Trustee- :man-actors by :naked-demonstration implement the :amoral- structure of :government-policy-practices that was taught by their mother, the :Roman-Church-Trustee -Derelict of the Concession-1213-A.D., to abuse and despise :Negro-Ysrael-people, et al., to wantonly harm the small- captive-minority- population, because, essentially, :Americans were/are taught, and given :great-latitude, to hunt and harm the :Children-of-Jacob-Ysrael, and to corroborate the :same. And,

Despite the fact that the Torah-KJV-Holy-Bible -data has been in their hands of the uSofA-people for :four-hundred- years and with after the **ACW-1861-1865-A.D.**, still :in -evidence in the uSofA-people on EVERY-LEVEL in this instant-matter is this :paternalism, greed, self-righteousness -belief in the uSofA-people's own understanding: liars, truce-breakers, thieves and murderers. Why would :i- man must- need-have to write you- Donald-John for something like is :this-document? – Are All Blindly Enslaved? Not anymore; but :all have a lot to lose. **This is part of the chosing of the judgment with very-much-property to lose from** the fraud by the Roman-Church -Trustee -Dereliction and harm to the Negro-Ysrael- beneficiaries, et al.- uSofA- people.

Roman-Church -:Trustee Knew Or Should Have Known :Negro-Ysrael- :CONCESSION-1213-A.D.- Covenant -:PEOPLE -:BENEFICIARIES

Roman-Church -TRUSTEE -DERELICTION Against Negro-Ysrael-Concession-1213-A.D.- Beneficiaries Is :Daily- Dereliction For Four-Hundred Years. Demand has been made

2020 September Declaration Of :i- man- Adam -:Ambassador to :Yushuah the :Messiah 48 / 62
From: Darrell-James: Hill, Negro-Ysrael -:Ohioan-©-1958-A.D., -:civilian, :Executor- beneficiary – Without-prejudice

1632
2022-011769 MISC Page: 1643 of 2782
09/26/2022 03:35:37 PM Receipt #: 22-9381
Rec Fee: \$30.00 Darrell James Hill
Gila County, Az, Sadie Jo Bingham, Recorder



for the restoration of :all- property.

118:Concession-1213-A.D. - **PROPERTY-CLAIMED by :i- man sole, et al. – RESTORE THE CONCESSION-1213-A.D. -PROPERTY-CLAIMED by :i- man sole, et al.**

Where, as:

- 1) The Concession of England and Ireland is to the Holy-Church of the savior- Yushuah -the -Messiah, and
- 2) the :Roman-Church, et al -usurpers failed to care for the Negro-Ysrael -people of the Children-of-Jacob/Ysrael; and, where, as
- 3) The :imperial -authority and nobility-right is a fraud with the polytheism-Roman-church- acting-as-the-'Holy-Church' from the beginning; and, where, as
- 4) The Trustee-actor- fiduciary -duty and obligation to the Children of Ysrael was abandoned with the :enslavement of the Negro-Ysrael- :Concession-1213-A.D.-covenant -people into the United- Colonies, the : Roman-Church is -liable, must resign, and return all holdings to :i- man, sole, and et al.- :kinsman-redeemer.

See: For the Cure and Relief -in the :Equity-Claim, and For the Remedy-Required For the Trespassing Upon The Children of Ysrael/Israel, et al.; Attachment B: :Section -G.

5) :Relative- Danger From The Roman-Church, et al.- Actors –

5.i) :Where, as the despise- plot for the Negro-House of Judah/ Children-of-Jacob/Ysrael aspired the Roman-Church, et al., to the annihilation for the extinction unto the abject-enslavement upon the Negro-Ysrael- :Concession-1213-A.D.-covenant- people, and;

5.ii) :where, as now this dishonor, dereliction with malfeasance is exposed, and;

5.iii) :where, as the accountability of the wrong-doing is now :prominent in the spirit and minds of the previously deceived-world, and;

5.iv) :where :i- man require restoration from the :Roman-Church -:Trustee- dereliction,

5.v) **:i- man discussing these facts attracts the insidious-danger of :personal- harm from the :Roman-Church, et al.- actors or proxies; and:**

119 :understanding means: agreement to be inferior to: e.g.: point, plan or person

120 :over-stands means: agreement to be superior to: e.g.: point, plan, or person

121 :you-to-be-made-aware means: a) Trustee-Knowledge of dereliction is Not accidental or inadvertent, b) knowledge creates :responsiveness- duty and obligation to the benefit of :i- man- Darrell-James: Hill, et al.- :Executor -beneficiary; c) Ignorance- defense Is Eliminated; d) ambiguity for the lack of awareness of wrong-doings and trespassing and socialistic-paternalism to the hurt of :Negro-Ysrael is forever-eliminated. – **Acknowledged -:Trustee Expectation.**

122 :forced-deprivation-actions against the :private :life, liberty and property means: **:UNLAWFUL -DETAINMENT OF THE PROPERTY-CLAIMED and POSSESSED THAT DEPRIVES :i- MAN'S-UNALIENABLE-RIGHT TO LIFE, LIBERTY AND PROPERTY –**

:i- man believe that the :POTUSA- CIC- :Trustee, -Trump's Dereliction and violation of fiduciary duty and obligations with the unlawful, illegal and unauthorized detainment of the property of :i- man requires that :i- man daily-endure the :damages- caused by the non-use of the private -property-claimed to meet the needs of the lifestyle-of :i-man to exercise the :long-standing -natural-right of providing the needs of home, transportation, 24-hour-security, and other health-needs for the family of :i- man, or ever-else :i- man civilian may choose to use private-property-claimed and possessed.

NO LAWFUL OR LEGAL-AUTHORITY FOR :STEALING OF THE PROPERTY-CLAIMED -

:i- man believe and declare that :i- man have not knowingly, voluntarily or intentionally given-authority for the POTUSA- Trustee or the POTUSA-CIC to steal/or otherwise abscond -away with the property-claimed.

2020 September Declaration Of :i- man- Adam -:Ambassador to :Yushuah the :Messiah 49 / 62
From: Darrell-James: Hill, Negro-Ysrael, -:Ohioan-@-1958-A.D., -civilian, :Executor- beneficiary – Without-prejudice

1633

2022-011769 MISC Page: 1644 of 2782
 09/26/2022 03:35:37 PM Receipt #: 22-9381
 Rec Fee: \$30.00 Darrell James Hill
 Gila County, Az, Sadie Jo Bingham, Recorder



THEFT OR DETAINING :PROPERTY: DRY-TRUST -:EBA-1933-2003-A.D. WITHOUT RIGHT - INVOLUNTARY SERVITUDE

:i- man believe and declare that the 'unalienable- Rights' -:property of the 'DOI-1776-A.D.', was given by :Almighty-God to the Negro/Ysrael- :beneficiaries from Almighty-God in THE DOI-1776-A.D.- covenant with the United Colonies, et al- :representatives of the united States of America. Thereto:

MALFEASANT -CONTROL, -TAKING -AWAY :PRIVATE -PROPERTY, SEEKING TO DISPOSSES BENEFICIARY-PROPERTY- CLAIMED AND POSSESSED, :FORCED-NORMALIZATION OF :DEPRIVATION OF :UNALIENABLE-RIGHTS BY MALFEASANCE -

:i- man believe that :property stolen/ deprived to :i- man is tantamount to the harm of the :involuntary servitude known as the consequence of malfeasance upon the deprivation of the right for :i- man to cestui-que-use of the beneficiary-Trust- property.

:i- man believe and declare that the :Trustee- dereliction serves and illustrates the :willful harm to :i- man: Darrell-James: Hill, -:Negro -civilian, -Ohioan-©-1958-A.D., -:Executor -:beneficiary of the inherent- unalienable-God-Almighty- given- inherent -rights to serve Him here on this planet as Negro-Ysrael/ Children-of-Jacob/Ysrael. - :This is the destruction of :Almighty-God's -purpose for :i- man now.

:i- man believe and declare that the Almighty-God is guiding :i- man unto :Almighty-God's-will for :man-Adam to broach these matters of :property-claimed and :wrong-doing against the Almighty'-God's -concern over these last four years in the process of the serial -specialty- presentments, that must come before comes the :judgment for the willful-deprivation by you.

:i- man believe and declare that this -nation, :we -:America are out of the ignorance to the harm of the people-control-system offense upon the :Negro-Ysrael and their kinsman-redeemer- :Almighty-God of :Jacob unto :Yushuah the Messiah; and, judgment is necessary to save the uSofA- people and :this -land-mass.

:HARM UPON THE UNALIENABLE-GOD-ALMIGHTY- GIVEN- RIGHTS -

:i- man -Negro/Ysrael- Ohioan-©-1958-A.D., -:Executive- :beneficiary believe and declare that your deprivation of the private-property-claimed imposed 1) harm and 2) illegal deprivation of the unalienable-rights of :i- man to :possess and manage, and use as :i- man see-fit, the :private property that you have stolen/detained-without-right.

ENSLAVEMENT IS DEPRIVATION OF :UNALIENABLE -RIGHTS, WITH :PATERNALISM -

:i- man experience-now in these immediate matters and believe and declare the same pattern of :enslavement and control to :i- man's harm is :indicated and demonstrated with the unwanted -paternalism historically identical to :TheCftUSofA- enslavers'-means to effect the Negro/Ysrael -uSofA- abject- apartheid-era- :unwarranted- impoverishment, discrimination, brutality, suppression and annihilation -:adversity upon :i- man the :progeny of the disenfranchised -:Negro/Ysrael -beneficiary, -civilian, -:american- :enslaved- people-control-system(s) :in -every internal and external social-institution.

:i- man believe and declare that with the widespread development of the truth of the uSofA-people's increased awareness and non-ignorance of the :PTSD-level-serious-devastation caused by the deprivation of the 'unalienable-rights' imposed upon the 'Negro-Ysrael-people for over four centuries are :covenant-violations against the :Almighty-God-:covenanter -:Kinsman-redeemer for: Negro-Ysrael, et al.-:Darrell-James: Hill, beneficiary.

:Concession-1213-A.D.-covenant and DOI-1776-A.D.-covenant -Trojan-horse- set-ups against the uSofA

2020 September Declaration Of :i- man- Adam -:Ambassador to :Yushuah the :Messiah 50 / 62
From: Darrell-James: Hill, Negro-Ysrael, -:Ohioan-©-1958-A.D., -civilian, :Executor- beneficiary – Without-prejudice

2022-011769 MISC Page: 1645 of 2782
09/26/2022 03:35:37 PM Receipt #: 22-9381
Rec Fee: \$30.00 Darrell James Hill
Gila County, Az, Sadie Jo Bingham, Recorder



:i- man believe and declare that the Roman-Church-Trustee-Dereliction and absolute-violation of Fiduciary-Duty and Obligations of the Concession-1213-A.D. was Not accidental, but :satanically-tactical to create the large open demonic-door-access which can only be closed by Almighty-God through the uSoA-people's prayer, repentance, changing and turning from the evil.- :None will escape the judgment.

:i- man believe and declare that harm to :Ysrael has always been for a national-liability Satan could and have used whenever other manipulations failed.-- Everyone in the world knows this; e.g.: Egypt, Babylon; now :America, the new Egypt.

123 :tantamount means: the :same-as, or :equivalent to

124 :as though :you are enslaved means: Knowledge of the wrong against the Negro-Ysrael-
abject-enslavement-survivors will not longer be judged by :Almighty-God as :ignorance or as
Oops! And, now the Negro-Ysrael-enslaving-American-dogma is being-judged in accordance
with the accountability of the full knowledge and severity of the damage-imposed upon the
people of :Almighty-God.

125 :ROMAN-CHURCH-TRUSTEE-Derelict-to the Concession-1213-A.D.-covenant means:
:Roman-Church -Trustee-Dereliction Undermined :The United States Of America, 1776
A.D. Unto The Judgment From Almighty-God For TheUSofA-1776-A.D. Violation Of His
Law-To-Protect-Ysrael With The Abject-Enslavement For: Four-Hundred Years-
Imposed Upon His People The Tribe Of Ysrael/Israel.

The :Roman-Church afforded the :continued -enslavement against the Negro-Ysrael
of the Almighty-God within the thirteen colonies, et seq., by the wicked-representatives for
the :united States of America, 'uSofA',- people. - It is the successful trap; burdening a
-young-fledgling -'Christian' -nation with enslaving the one -people that the Almighty-God
-Christian- covenants protect and which brings the curse and judgment for abject-
enslavement and terrorism violations against the Holy-Church of the Holy-Bible.

:Roman-Church -TRUSTEE -DERELICTION Against Negro-Ysrael means:

:i- man believe and declare that the Roman-Church- Trustee- Dereliction and violation
of the fiduciary- duty and obligations began in fraud and has sustained-itself with frauds upon
the Children-of-Jacob/Ysrael, et al.- Negro- Ysrael- Africans enslavement, and the world.

**:uSofA -Foundational Fraud is with the Concession of 1213 A.D. aiding and abetting
the Anti-Messiahism- Roman-Church- of the polytheism-philosophy.**

**Roman-Church- Trustee -Dereliction With :Violation of the Fiduciary- duty and
obligations authorized, aided and abetted, the :enslavement of the Negro-Ysrael-
:Concession-1213-A.D.-covenant -people**

:i- man believe and declare that the Roman-Church- Trustee, et al. authorized, aided
and abetted the VERY Specific- :enslavement of the Negro-Ysrael- :Concession-1213-A.D.-
covenant -people in the early 17th century with the annihilation for the extinction unto the
enslavement of the covenant- people in the 'United British- Colonies' of the America
continent.

126 :B.A.R.-member means: British Accreditation Registry- foreign agent. See: TheCftUSofA,
13th Amendment. See: Monroe doctrine.

127:Holy-Church means: the :body of :people who have accepted the unalienable-god-
almighty-given-right to choose :eternal- life of abundance or perishment of decay, those for
whom we all are that :Yushuah the Messiah's work and death-price created. The 'Holy-
Church' was first assembled within the House-of-Judah-Ysrael, and thenafter for whosoever
would accept the gift, and in :spirit and truth will commit themselves to the Most-High-God
through :His -son- Yushuah. See: KJV- Book: Leviticus chap 11 v 44-45; chap 19 v 1-3; Book:
1 Peter chap 1 v13-16.

2020 September Declaration Of :i- man- Adam -:Ambassador to :Yushuah the :Messiah 51 / 62
From: Darrell James Hill Negro Ysrael - 1958-A.D., -civilian, :Executor- beneficiary - Without-prejudice

1635
2022-011769 MISC Page: 1646 of 2782
09/26/2022 03:35:37 PM Receipt #: 22-9361
Rec Fee: \$30.00 Darrell James Hill
Gila County, Az, Sadie Jo Bingham, Recorder



128 **:United States-government- POTUSA-CIC AND POTUS -DANGER means:**

Authorization for the :POTUSA-CIC to direct action, or with :commission or omission-oversight of the POTUS-corp- Trustee-actor to aide or abet the :Roman-Church-Trustee-Dereliction of the Concession-1213-A.D. to any near-harm of any Negro-Ysrael, et al. :-i- man -Darrell-James: Hill -civilian -beneficiary unto :any-further and any harms here-to-fore now-to-after.

:i- man :-Executor -beneficiary, specifically, do not give :you authority to corroborate or permit :any- Roman-Church -Trustee -Dereliction harmful to the Negro-Ysrael- Americans, et al. -Ysrael, :i- man, and the Holy-Church.

No :POTUSA-CIC may aide or abet the :Roman-Church Harm upon :Negro-Ysrael-Americans

:i- man do not give you authority to comply with :any- Roman-Church -Trustee -Dereliction harmful to the Negro-Ysrael- Americans.

129 **:first with the House-of-Judah means:** See: KJV- Book: Romans chap 1 v16; chap 2 v 9-

10. KJV-Book: Romans chap 1 v 16 For I, am not ashamed of the gospel of Christ: for it is the power of God unto salvation to every one that believeth; to the Jew first, and also to the Greek.; **chap 2 v 9 Rom 2:9** Tribulation and anguish, upon every soul of man that doeth evil, of the Jew first, and also of the Gentile;

130 **:truth means:** that which is righteousness

131 **:STOLEN-3 of 3-property means:** three of three individual property-claims- agreed and possessed by :-i- man, And three of three individual property-deprivation-contracts- agreed. See: Attachment C.

132 **:STOLEN-3 of 3-property- Deprivation-contracts means:** to answer all-inquiries with tacit-acquiescence unto tacit-procuration onto non-action -denial of the right, :equivalent of :enslavement. :Deprivation-of-property -agreed-contracts are for: one- silver-.9999-ounce-U.S.-dollar-per-minute until the deprivation is completed. See: Attachment D.

133 **:cestui-que-vie-trust means:** he, :-i- man-beneficiary: Darrell-James: Hill, whose life is the purpose, measure and duration of the trust-possessions/ -life-estate; transferrable.

134 **:Stolen-FRA-property means:** Deprivation to access of the benefit of the cestui-que-vie-Trust: -EBA-1933-2003-A.D.- Legislative-Dry-Trust - FRA-1913-A.D.- option for the cestui-que-use :-i-man -Darrell-James: Hill, and

135 **:Mitigation means:** the state-of the lessened severe or less -painful :losses -endured by the violation of :-i- man's-unalienable-rights to :life, liberty and property-claim and possessed.

136 **:theft means: to thief, steal, abscond-away without authorization-otherwise – Theft 1) The :Unlawful or illegal or unauthorized -possession and/or detention and/or administration without-right of the private -private of :i- man :-Darrell-James: Hill, :-Negro, :-Ohioan-©-1958-A.D., :-civilian, :-Executive- :beneficiary; and,**

2) :i- man Exercise of Right for Recovery of Property-claimed and possessed, ignored – CONDITIONS INDICATIVE OF THEFT –

For the knowledge of the facts of the embarrassments upon the :rights to the remedies-due-now, :i- man :-Darrell-James :exercised the :property-claims upon the :man -Trustee, :-Trump for to obtain the :property-claimed, released to :i- man's :property, that the :man -Trustee- :Donald-John, et al., willfully ignored the :exercise of :i-man; and:

For the right to the remedy with the specialized presentments detailing the wrongdoing is with the demand for the restoration of :all property-claimed and including the unalienable-right of the prerogative to exercise the property-claim with the special-presentment to the POTUSA-Trustee, :-man- :Donald-John- Trump;

:i- man believe that theft by the of condoning, aiding or abetting is the :theft by the

2020 September Declaration Of :-i- man- Adam :-Ambassador to :Yushuah the :Messiah 52 / 62
From: Darrell-James: Hill, Negro-Ysrael, :-Ohioan-©-1958-A.D., -civilian, :Executor- beneficiary – Without-prejudice

1636
2022-011769 MISC Page: 1647 of 2782

09/26/2022 03:35:37 PM Receipt #: 22-9381
Rec Fee: \$30.00 Darrell James Hill

Gila County, Az, Sadie Jo Bingham, Recorder



USAG/Alien-Property-Custodians/etc. from :2016 to this day of this signing, and: this document lumnates the :man -Trustee's, et al.- actor's intent.

137 :narcissism means: :in-love with :his-own-image; self-absorbed.

138 :Unalienable-Rights means: God-Almighty given-authority; not subject to discretion

:Unalienable - Right For :i- man -:beneficiary- :Executor :To Privately- Manage :PRIVATE-Property- Claimed And Possessed By :i- man-

:i- man -:civilian- :beneficiary, -:full of maturity and sound- mind declare that :i- man -:Executive- :beneficiary elect to manage the :all- property, real, chattel and accounts, known and unknown to present- now-after, and,

:i- man believe and declare that :i- man-Adam- :Negro-Ysrael- :unalienable- rights are from the Almighty-God's- unalienable- law of the lineage-covenants :where the :obtence of :property-claimed by :i-man is a common law and equity-claim matter, and including:

I) The blessing of the unalienable-rights in life by the unalienable-law of :Jehovah-God-Almighty with the inherent rights of soul, spirit and earth, where :nothing-stands between the :Almighty-God and :i- man; and,

II) the :Earth- man, -:planet -land right -in the embodiment of :Ohioan-©-1958-A.D.; and,

III) The :Concession of :England and Ireland to :Almighty-God, Peter, Paul, and the -:Holy-Church by :King-John-I, of 1213 A.D.; and,

IV) The :Declaration of Independence of 1776 A.D.- covenant of the unalienable-rights to :i- man; and,

V) 'The United States of America'- government -:Emancipation Proclamation of 1862-1863 A.D., for the strict-protection of the unalienable-rights of :i- man with the Army, et al.- military by the POTUSA- CIC, -:Trump and,

VII) The :Emergency Banking Act of 1933- 2003 A.D., et al. - Legislative- Dry-Trust-Property-Claimed and Demanded for :settle and closure by the POTUS- Trustee; -:Trump understanding the uSofA- Army, et al., understanding the POTUSA- CIC; -:Trump; and,

VIII) The three-lots of :property-claimed with the three-lots of the compensation -contracts for the now-payment for the dereliction-of-the-trustee-duty-and-obligation by the POTUS- Trustee; -:Trump, et al. See: Attachments C and D.

139:Unalienable-Law of Almighty-God: :i- man believe and declare that :i- man-Adam- :Negro-Ysrael- :unalienable- rights are from the Almighty-God's- unalienable- law of the lineage-covenants :where the :obtence of :property-claimed by :i-man is a common law and equity-claim matter.

140:Unalienable Rights with Enslavement Violations: Enslavement of Negro-Ysrael/ House of Judah/Children of Jacob/Ysrael is Wrong-doing -

:i- man believe and declare that historically, to enslave the Children of Ysrael, House of Judah, has resulted in the destruction and marginalization of nation(s) and people(s).

141:Unalienable Rights with Enslavement Violations: :anti-Jacobism to- anti-Christian -anti-Negro-philosophy -

:i- man believe and declare that the DOI-1776-A.D. -covenant-stipulation for "unalienable rights" was perverted by the culpability of :wicked-man-kind adherents to the Roman-Church -:Trustee, et al. -:anti-Jacobism to- anti-Christian -anti-Negro-philosophy with the concomitant -propaganda that damages and harms the :Negro-Ysrael- :Concession-1213-A.D. -DOI-1776-A.D.-covenant- people- beneficiaries to the present-now.

142:Unalienable Rights with Enslavement Violations: :uSofA- government- Trustee-created -:policies damaging Negro-Ysrael -:beneficiaries -

:i- man believe and declare that the TheCftUSofA-1789-Ä.D. Government created

2020 September Declaration Of :i- man- Adam -:Ambassador to :Yushuah the :Messiah 53 / 62

From: Darrell James Hill, Negro-Ysrael, -:Ohioan-©-1958-A.D., -:civilian, :Executor- beneficiary - Without-prejudice

2022-011769 MISC Page: 1648 of 2782

09/26/2022 09:35:37 PM Receipt #: 22-9381

Rec Fee: \$30.00 Darrell James Hill

Gila County, Az, Sadie Jo Bingham, Recorder



:policy for the Negro-Ysrael- :Concession-1213-A.D. -DOI-1776-A.D.-covenant- people -beneficiaries of the DOI-1776-A.D. -covenant to be denied "unalienable rights" by the Trustee-actor's -willful incompetence and :greed with the unlawful, -made-legal -:wrong-doings upon the Negro-Ysrael- :Concession-1213-A.D. -DOI-1776-A.D.-covenant- people, et al.- the :Children-of-Ysrael to the present-now.

143 **:Dry-Trust means:** Trust which elements for its being are completed, e.g., a trust to do X-thing until the widower dies; thereto, after the widower dies the trust-fund serviceability/ purpose is over.-'or dry, or done'. As relates to the legislative-dry-trust, :EBA-1933-2003-A.D. of the new deal is over, and the trust-fund-principle must be distributed if the owner present themselves.

144 **:POTUSA-CIC -:Oath, Duty And Obligation means:**

POTUSA-CIC, -:Trump UNDERSTANDS THE :EP-1863- A.D. , DOI-1776-A.D.

:i- man believe that the POTUSA-CIC, -:Trump is under the oath, duty and obligation to understand the :EP-1863- A.D. which understands :The Constitution for the United States of America of 1789 A.D., :TheCftUSofA-1789-1791-A.D with :Bill-of-Rights of 1791 A.D., 'BOR-1791-A.D.', which understands the :Declaration of Independence-1776 A.D., ':DOI-1776-A.D.', which understands the :Almighty-God wherein :i- man possess the unalienable-right from the unalienable-law from :Almighty-God by the :DOI-1776-A.D.- covenant.

POTUSA-CIC UNDERSTANDS COMMON LAW OF THE REPUBLIC- GOVERNMENT

:ID – POTUSA- CIC common- law and -equity -stand is expected for :property-claimed by :man- :civilian, -:Negro-Ysrael -:direct- beneficiary of the Concession-1213- A.D. - DOI-1776-A.D. -Covenant with Yushuah~'Jesus'~the Messiah;

POTUS OVERSTANDS POTUS IN ALL MATTERS CONCERNING FOR THE PROTECTION OF :i-man– UNALIENABLE-RIGHTS

:i- man -:Negro-Ysrael, -:civilian, -:Ohioan, -:Executor- beneficiary believe that the :POTUSA- CIC in :common- law and -equity -over-stand the POTUS-Corp -Trustee for the seeing and upholding the :i- man -:Negro- -:beneficiary's :property of the republic-form- of-government -to :i- man -:beneficiary with the -lawful accounts-reports, settle-and-closure, and :restoration of the EBA-1933-2003-A.D. -Legislative- Dry-Trust -property and identity to that of the ':sovereign-man-covenant-beneficiary -:member of the non-political- aggregate- uSofA-people' upon the return of the authenticated and verified- trust- debenture-bond~of the EBA-1933-2003-A.D.~ to the man-Trustee, -:Trump – delivered. :This :unalienable-right -claim is exercised by :i- man -:Darrell-James: Hill, -:Negro, -:Ohioan-©-1958-A.D.- civilian-beneficiary, -:Executor, and answered with the tacit-acquiescence with tacit-procuration.

:Oath, duty and Obligation to protect :i- man: Darrell-James: Hill

:i- man-civilian-beneficiary believe that :you-man as :POTUS-Corp are under oath, duty and obligation for to protect :i- man-beneficiary political-election to manage :all-property-claimed and possessed -privately, which also includes: a) the account, settle-and-closure of the EBA-1933-A.D. -cestui-que-vie -subrogation, et al.- derivatives - accounts as :i-man requested/required/demanded/ordered -for :intent -:to- be-clear.

:i- man believe that :you- man -:Donald-John, -:POTUS-Corp -Trump are the Trustee with oath, duty and obligation understanding TheCftUSofA-1789-1791- A.D., et seq.- DOI-1776-A.D. for the operation of the :United-States- corp-government for the protection of the unalienable-Right of :i- man-civilian -:Darrell-James: Hill, -beneficiary, -:Executor to :all-property-claimed and possessed.

145 **:Political-Election Is Set means: Setting Of The Political-Election OF :i- man: Darrell-James: Hill, Negro-Ysrael, -:Ohioan-©-1958-A.D., -:civilian, -:Executor- beneficiary.**

:i- man set with all law enforcement agencies of the Arizona counties, state and

2020 September Declaration Of :i- man- Adam -:Ambassador to :Yushuah the :Messiah 54 / 62
From: Darrell-James: Hill, Negro-Ysrael, -:Ohioan-©-1958-A.D., -:civilian, :Executor- beneficiary – Without-prejudice

1638
2022-011769 MISC Page: 1649 of 2782
09/26/2022 03:35:37 PM Receipt #: 22-9381
Rec Fee: \$30.00 Darrell James Hill
Gila County, Az, Sadie Jo Bingham, Recorder



national government of man-actors, and placed same into the public-record, the presumption of political-election for :i- man, to be known: approach as 'man, Negro-Ysrael, -:Ohioan-@-1958 A.D., :civilian, -:Executor- beneficiary (inalienable-rights: Concession-1213-A.D., DOI-1776-A.D., EP-1863-A.D. and Lieber-Code-1863-A.D (TheCftUSofA-1789-1791-A.D.); -:civilian -:beneficiary:EBA-1933-2003-A.D. -Legislative- Dry-Trust-Indenture, -:Ohioan-@-1958 A.D.

:i- man appointed the mature and sound-minded -:man -self as :Executor for :all-business affairs of the :i- man- beneficiary with unalienable-rights from :Almighty-God, 'Executor- beneficiary'.

:i- man -:Executor, -:beneficiary -Darrell-James: Hill, am sole and kinsman- redeemer of : Negro-Ysrael/ House-of-Judah, -:Children-of-Jacob-Ysrael, and the :Holy-Church, 'Executor'

146 :Constructive Notice Of The Setting Of Presumptions

Notice to Agent is Notice to Principal; Notice to Principal is Notice to Agent: **Applicable to all Successors and Assigns –**

Regarding: Constructive Notice Of The Setting Of Presumptions of :meeting for the discussion of the :any-matter, remedy, recourse, and/or offer; for the fact, :rebutted- or un-rebutted- presumptions invariably effect the :discussions on a matter by the visitors to the meetings. :Where-fore, :now-to-after, :i- man :Darrell-James: Hill, -:Executor -beneficiary set :these -known- presumptions:

1) Re: **presumption of the public record**, :i- man -Darrell-James: Hill rebut and reject that the matter-at-hand is the :private-BAR-guild -business -matter. :Heretofore, now-to-after, 'presumption of :public-record' is :now-to- 'in -perpetuity' -set; that, :this- private- business-matter is to be recorded in the public -environment and on the public -record and by the public -record number placed on the page -one (1) of the matter; and:

2) Re: **presumption of the public service**, :i- :man rebut and reject that the matter is ministered as the :public-service by the public-servants. :Heretofore, now-to-after, 'presumption of :public- service' is :now-to- 'in -perpetuity' -set; that: any public- person engaged in this private- matter is deemed to be in the public- service as a :public-servant; and:

3) Re: **presumption of the public oath**, :i- man rebut and reject that the public-servant's :public-service -sworn -oath is :presumed -not-superseded by :some-other -oath. :Heretofore, now-to-after, 'presumption of :public oath' is :now-to- 'in -perpetuity' -set; that, :every :public-servant acting on the behalf of this matter is required to state :all- public and private -:sworn -oaths superseding the :public -servant's -sworn -oath(s); and:

4) Re: **presumption of the immunity**, :i- man rebut and reject that the public- official's -acts are :immune from the personal-accountability. :Heretofore, now-to-after, 'presumption of the immunity' is :now-to- 'in -perpetuity' -set; that, :any-person acting on the behalf of/as the agent for :any- nameless, faceless -predilection or corporation is :wholly-personally-liable for :their- actions on the behalf of that interest upon the Notice- of-Injury with the financial-penalty; and:

5) Re: **presumption of the summons**, i:man rebut and reject that by the custom the :any-person- visitor or attendee to the meeting is by the default assumed to also accept the :position :under-the-court's -jurisdiction. :Heretofore, now-to-after, 'presumption of :summons' is :now-to- 'in -perpetuity' -set; that, for the now, past and future -occasions, the :customary- presumption of the jurisdiction, position, and existence of the guilt is :forbidden; and:

6) Re: **presumption of the custody**, i:man rebut and reject that :any- summons or warrant-

2020 September Declaration Of :i- man- Adam -:Ambassador to :Yushuah the :Messiah 55 / 62
From: Darrell-James: Hill, Negro-Ysrael, -:Ohioan-@-1958-A.D., -civilian, :Executor- beneficiary – Without-prejudice

1639
2022-011769 MISC Page: 1650 of 2782

09/26/2022 03:35:37 PM Receipt #: 22-9381
Rec Fee: \$30.00 Darrell James Hill
Gila County, Az, Sadie Jo Bingham, Recorder



for-arrest is imbued with the authority for the treatment of the natural-person as a "thing" to be detained or held in the custody by the custodian. :Heretofore, now-to-after, 'presumption of :custody' is :now-to- 'in -perpetuity' -set; that, :man-kind is as :i- man am, -alive and well: not the :thing to be held in the custody by the custodian or guardian; not :property of the Roman-Court or Roman-Empire; and, :under-no-circumstances may :i- man be detained in any way: now, past or future; and:

7) Re: **presumption of the court of the guardians**, i:man rebut and reject that the visitor to the meeting is by the default the :resident, ward, pauper or lunatic subject to obey the :rules of the court. :Heretofore, now-to-after, 'presumption of :court of :guardians' is :now-to- 'in -perpetuity' -set; that: i :man :Darrell-James: Hill am: general guardian and executor of the matters of the trust; and:

8) Re: **presumption of the court of the trustees**, i:man rebut and reject that the visitor to the Roman-Court :thereby and thereon accepts the :office of the trustee or public servant or government employee. :Heretofore, now-to-after, 'presumption of :court of :trustees' is :now-to- 'in -perpetuity' -set; that, for the reason of as a visitor with the invitation to meet and to clear-up the :matter, the :offices of the trustee and the :roles of the public -servant and government -employees are rejected: absolutely -:no -jurisdiction may be claimed. However, the :need for to contribute unto the well-being of the community is :acknowledged and graciously -embraced; and:

9) Re: **presumption of the government acting in :two roles as the executor and beneficiary**, i:man rebut and reject that the judge or magistrate may act in the role as the executor with the prosecutor acting in the role as the beneficiary. :Heretofore, now-to-after, 'presumption of the government acting :in-two-roles as :executor and beneficiary' is :now-to- 'in -perpetuity' -set; that, :i- man am the :general executor, general guardian, and beneficiary and executor :in -all -matters-at-hand pertaining to the legal -person, -subrogation: DARRELL JAMES HILL, et seq.-derivatives-thereto, as well as to the flesh and blood, -living -soul-journer :i- man -Darrell-James: Hill, -civilian, -Executor- beneficiary; and:

10) Re: **presumption of the agent and agency**, :i- man rebut and reject that :i- man, as if presumed to be under the contract, express or grant :authority to the judge or magistrate by the use of the certain legal-term ~ such as: recognize, understand or comprehend ~, and :thereby and thereon agree to be bound to perform under the direction of the judge or magistrate. :Heretofore, now-to-after, the 'presumption of agent and agency' is :now-to- 'in -perpetuity' -set; that, :under-no-circumstance may the :judge or magistrate assume the :executor-role; and:

11) Re: **presumption of the incompetence**, :i- man rebut and reject that :visitors at the court are, at the least, :ignorant of the law, :incompetent to present and/or argue "properly", and, :therefore, the :judge or magistrate as the :executor has the :right to arrest, detain, fine, or force the :psychiatric evaluation. :Heretofore, now-to-after, 'presumption of incompetence' is :now-to- 'in -perpetuity' -set; that, :i- man know the :position of the executor and beneficiary, and rebuke and object to :any-contrary-presumption. - :No- privilege 'of the deeming :i- man incompetent' is permitted; and:

12) Re: **presumption of the guilt**, :i- man rebut and reject that :i- man am :presumed- guilty or to be held until the bond is :guaranteed. :Heretofore, now-to-after, 'presumption of guilt' is :now-to- 'in -perpetuity' -set; that, :under -no- circumstance may :i- man be: a) :presumed -guilty, or b) detained; nor- may c) :any- financial- transactions occur in the favor of the court.

147 :**Slavery means: a) Barbarian uSofA-type** -abject enslavement- with the violations of the prevailing-covenants against the same- or b) Hebraic-Ysrael :bond-conservancy.

148 :**TWEA-1917-A.D., as amended means:** Trading-With-The-Enemy-Act of 1917 A.D., as

2020 September Declaration Of :i- man- Adam -:Ambassador to :Yushuah the :Messiah 56 / 62
From: Darrell-James: Hill, Negro-Ysrael, -Ohioan-@-1958-A.D., -civilian, :Executor- beneficiary - Without-prejudice

2022-011769 MISC Page: 1651 of 2782

09/28/2022 03:35:37 PM Receipt #: 22-9381

Rec Fee: \$30.00 Darrell James Hill

Gila County, Az, Sadie Jo Bingham, Recorder



amended with **EBA-1933-2003-A.D.**; means: the identification of the uSofA- people as the "enemy" in the 'emergency' in such a manner as the United-States-corp -persona will then-to-now assume that :i- man: **Darrell-James: Hill, -:Negro- Ohioan-©-1958-A.D., -:civilian, and :beneficiary of the EBA-1933-2003-A.D.- Trust, will be presumed** to be the idem-sonans -subrogation<fiction>-persona entitled, 'DARRELL JAMES HILL', et al.- :etcetera-derivatives, in :sundry- instances and applications. Related to the national emergency banking crisis- 'U.S.-corp-' bankruptcy of :1933 A.D.: emergency- crisis -legislatively- ended: 1976 A.D., bankruptcy-holding requirements ended in 2003 A.D.

149 **The-Constitution-for-the-United-States-of-America of 1789 A.D. means:** 'TheftUSofA-1789-1791-A.D.' means: 'The-Constitution-for-the-United-States-of-America of 1789 A.D. and including the Bill of Rights of 1791 A.D.

150 **Alien Property Custodian, 'APC' means:** :i- man believe that the duty and obligation of the APC is to receive, log and manage :all -property of the claim-of-right by the civilian or enemy under the TWEA-1917-A.D., as amended: with **EBA-1933-2003-A.D.**

151 **United States Attorney General, 'USAG' means:** :i- man believe that the 'United States-corp'- government-services-provider is understanding: TheCftUSofA to guarantee to 'The United States of America,':unincorporated-people requiring the :republican form of :government.

152 **Common- Law- Trustee, 'CLT' means:** :i- man believe that this :man- trustee-actor is for to organic-constitutionally unto the EP-1863-A.D., et seq., protect :i- man - beneficiary's-exclusive- interests as the sovereign-man-covenant-beneficiary.

153 **Secretary of the Treasury, 'SOT' means:** :i- man believe that the liaison between the IMF and the United-States-corp government implementing policy-practices on behalf of the EBA-1933-2003-A.D. for the management of the funds is for the United-States-Corp -:bankruptcy-administration for the surety, et al.- :i- man -Darrell-James: Hill -concerns.

154 **POTUSA-CIC, -Trustee; and: POTUS, TRUSTEE, -:Trump LIABILITY and Notarial-DISHONOR means:** Trustee-dereliction with violation of the **Fiduciary-duty and obligations** → See: Gila county, Arizona state, Recorder Doc.# 201-009297, and pp. 824-832 for **:Donald-John: Trump, -:TRUSTEE-NOTARIAL- :PROTEST AND -:DISHONOR**
:i- man declare that :i- man deposited specialty-presentments unto :you- man, -:Donald-John: Trump, to the trustee- dishonor, requesting, etc., communicating the :i- man- :Negro-Ysrael, -:civilian, -Ohioan-©-1958-A.D., :Executor- beneficiary have made and publicized the political-election that set the(your) presumption to :i-man, et al.-:Executor-beneficiary that :you, et al. your agents: APC, USAG, Common-Law-Trustee: Barr; SOT-Mnuchin to release :all of :i- man -:property- claimed. → See: Attachment E: for Gila county, Arizona state, Recorder Doc.# 201-009297, -:cover-sheet of correspondence. Thereto:

:TRUST; AND :SERIAL-COVENANT-BREAKERS

Honestly, if you were subjected to this global-socio-institutional- :history then how much :credence with :prudence could :you afford to expect from the same typical-lying- 'United States corp.-' government- services-provider -present -now at this signing? Answer: After the U.S.-2016-2018 A.D.- Mueller investigation.., little. Neither is it my job to trust no man.

EP-1863-A.D.- TRUSTEE DERELICTION AGAINST :i- man -Negro-Ysrael, :civilian-beneficiary

Yet, after the ACW-1861-1865-A.D., the :Negro-Ysrael- :Concession-1213-A.D. -DOI-1776-A.D.-covenant -people continued to endure the :intense -control-systems honed and permitted under the Trustee- Dereliction of duty by TheCftUSofA-1789-1791- A.D., et al., by :policies aiding and abetting :violations against the Children of Judah/Ysrael, while

2020 September Declaration Of :i- man- Adam -:Ambassador to :Yushuah the :Messiah 57 / 62
From: Darrell-James: Hill, Negro-Ysrael, -:Ohioan-©-1958-A.D., -:civilian, :Executor- beneficiary – Without-prejudice

1641
2022-011769 MISC Page: 1652 of 2782
09/26/2022 03:35:37 PM Receipt #: 22-9381
Rec Fee: \$30.00 Darrell James Hill
Gila County, Az, Sadie Jo Bingham, Recorder



legislatively depriving the :Negro-Ysrael- :DOI-1776-A.D.-covenant- beneficiaries'
-unalienable -rights life, liberty and property.

:i- man believe and declare that **EP-1863-A.D.** freed a demoralized- :PTSD-mass
of :damaged -man-kind onto the socio-economic and cultural despise and racism -policies
instituted by :TheCftUSofA-1789-1791- A.D. with the :dereliction-of-the-trustee-duty-and-
obligations relentless destroying :lives, economy, and families of he Negro-Ysrael-
:Concession-1213-A.D. -DOI-1776-A.D.-covenant- people-beneficiaries.

155 : **POTUSA-CIC -duty and obligations:** :i- man believe and declare that by wanton-
unaccountable- :control of :i- man's possessions, :you- :Donald- John become to steal by
thieving the unalienable-rights of life, liberty and property of the Executor- beneficiary, a poor
man; and, you- :Donald create this resultant- discourse about the :material-facts of the
damage you cause upon :i- man beneficiary and family and community.

156 : **estoppel means:** A man's own act or acceptance stops or closes his mouth to allege the
truth; arises when one is concluded and forbidden by law to speak against his own act or
deed, is a bar or impediment which precludes allegation or denial of certain facts or state of
facts; the equitable doctrine to establish justice against false representation or wrongful
silence or concealment on the part of the man to be estopped , 'Estop- to stop, bar, or
impede; to prevent; to preclude'. – In the nature of the Black Law dictionary, 4th Ed., pg: 648-
649.

157 : **laches means:** the common-law question of the inequity of permitting the :claim to be
enforced. – In the nature of the Black Law dictionary, 4th Ed., pg: 1016-1017.

158 : **PROPERTY- CLAIMED and POSSESSED**

a) : **Property: Unalienable-rights:**

unalienable rights of the Concession-1213-A.D.-covenant

:i- man believe and declare that corroboration of the Roman-Church -Trustee-
Dereliction of the Concession-1213 -A.D. enabled Fraud and harm upon :i- man , progeny of
the the Negro-Ysrael -people-abused, under TheCftUSofA-1789-1791- A.D. with the violation
of the inalienable-rights of the people of :God-Almighty with the stipulation to absolutely-
always protect the very-same people of the lineage-covenants: Abraham to Jacob through
the Messiah-Yushuah to church with the terms of the Torah, et al.- KJV- Bible by the United-
Colonies and representatives of the :united-States-of-America -:DOI-1776-A.D.- covenant
with the Almighty-God.

unalienable rights of the DOI-1776-A.D. -covenant

:i- man declare that :i- man- sole and :kinsman-reedermer, et al.- Negro-Ysrael in the
inherent- unlienable law claim the :unalienable- Almighty-God-given- rights to :i- man as
represented in the DOI-1776-A.D. -covenant, between the United Colonies~:united-States-of-
America-, the uSofA', - people with the :Almighty-God, whose people are the :Negro-Ysrael
and White-Ysrael, and :all- Other-Children of :JaooB/Ysrael and the ':Holy-Church'.

159 : **Harm means: moment ;in-which** after-which one's action equates injury-effect, damage

160 : **Property-Claimed Lot #1/3 means:** USPS RMN 322 399 279 US; sent: October 25th,
2016 A.D.; delivered: October 31, 2016 A.D. See: Gila county, Arizona state, Recorder Doc.#
2017-002378, pp. 241-549.

161 : **Property-Claimed Lot #2/3 means:** Gila county, Arizona state, Recorder Doc.# 201-
009297, pp. 9-333.

162 : **Property-Claimed Lot #3/3 means:** Gila county, Arizona state, Recorder Doc.# 201-
009297, pp. 373-737.

163 : **Deprivation Contract-Agreement for :Property-Claimed Lot #1/3 means:** USPS RMN
322 398 208 US; delivered: September 27th, 2016 A.D. See: Gila county, Arizona state,

2020 September Declaration Of :i- man- Adam --Ambassador to :Yushuah the :Messiah 58 / 62
From: Darrell-James: Hill, Negro-Ysrael. -:Ohioan-@-1958-A.D., -civilian, :Executor- beneficiary – Without-prejudice

1642
2022-011769 MISC Page: 1653 of 2782

09/26/2022 03:35:37 PM Receipt #: 22-9381
Rec Fee: \$30.00 Darrell James Hill
Gila County, Az, Sadie Jo Bingham, Recorder



registering :i-man' birth with the Certificate-of-Live-Birth, that
3 :i- man would-after-be-identified with the :idem-sonans- subrogation entitled
'DARRELL JAMES HILL', et al.- derivatives, and presumed to be operating under the
statutory-rights of the EBA-1933-2003-A.D. - Trust- wardship with the TWEA-1917-A.D., as
amended- EBA-1933-2003-A.D., until such time as that :i- man: 'Darrell-James: Hill' will
choose to the :suitable -political -election and relationship :in -regard- to the United-States-
corp-' government -services- providers understanding :TheCftUSofA-1789-91, et al-
Trustees- et seq.- United States corp, :understanding the :EP-1863-A.D. by :TheUSofA-
1776-1863 -A.D.- Army, et seq.-military, according to the Lieber Code~ 'GO100-1863-
A.D.-, :understanding :TheCftUSofA-1789-1791-A.D. with the TWEA-1917-A.D., as amended
by :EBA-1933-2003-A.D.

176 :kinsman-redeemer means: ID – :i- man -:Executor, -:beneficiary -Darrell-James:
Hill-, sole and kinsman- redeemer of : Negro-Ysrael/ House-of-Judah, -:Children-of-
Jacob-Ysrael, and the :Holy-Church, -:Executor'

:ID – Executor -:i- man -:Darrell-James: Hill, -:Negro- :civilian -:beneficiary, -uSofA
-sovereign- member of the non-political -aggregate over-standing: a) the :Declaration of
Independence, 'DOI-1776-A.D.', b) :The Constitution for the United States of America of 1789
A.D., et seq.- Bill of Rights of 1791 A.D., 'BOR-1791-A.D.', 'TheCftUSofA-1789-1791-A.D.', et
al., c) Emancipation Proclamation of 1863 A.D., 'EP-1863.-A.D.', d) Emergency-Banking-Act
of 1933-2003 A.D., 'EBA-1933-2003-A.D.',- Legislative- Dry-Trust-Indenture, et seq.-Trading
With The Enemy Act of 1917, TWEA-1917-A.D., as amended by the EBA-1933-A.D., e) et al.

177 :one- ounce of .9999 -silver- U.S. -coin in :specie per :minute, :unit-of-time' means:
e.g., that for
the deprivation equaling 60 minutes would the calculation equal to :sixty (60), etc ...silver
in :specie.

178 :Much property has been stolen:

a) :i- man declare that very- much real- and chattel- property and possessed by :unalienable-
rights -belonging to :i- man- :Darrell-James: Hill has been :lawfully-obtained by :you- Trustee,
et al., none else;

b) :i- man declare that :your deprivation of the property-claimed and possessed by :i- man
causes the infringement of the life, liberty and property of :i- man through the :loss-of-use-
of :i- man's -property-claimed and possessed as :daily is the :damage.

179 :Amendment 9 means: 'the enumeration in the Constitution, of certain rights, shall not be
construed to deny or disparage others retained by the people.'

180 :Amendment 10 means: 'the powers not delegated to the United States by the
Constitution, nor prohibited by it to the States, are reserved to the States respectively, or to
the people.'

181 :NO :Authorization To :STEAL by :i- man.

:i- man believe and declare that :i- man have not knowingly, voluntarily or intentionally given-
authority for the POTUSA- CIC or the POTUS- Trustee to steal/or otherwise abscond -away
with the property-claimed and possessed by :i- man.

182 :notarial-dishonor means:

183 ':three -:specialty- presentments by the Notary-Public -Specialty-
Presentment of the three (3) – lots of :property-claimed by :i- man to the man-
Trustee, -:POTUSA and :POTUS are in the status of: Dishonor' means:

184 :Slavery means: abject enslavement- violations of the prevailing-covenants against same.

185 :No authority from :i- man: NO :Trustee -:PRESUMPTION Authority To Steal Property
by :i- man. :i- man - Adam -:civilian, -:Executive- :beneficiary declare that :i- man deny your

2020 September Declaration Of :i- man- Adam -:Ambassador to :Yushuah the :Messiah 60 / 62
From: Darrell James: Hill, Negro-Ysrael, -:Obioan-@-1958-A.D., -:civilian, :Executor- beneficiary – Without-prejudice

1643
2022-011769 MISC Page: 1654 of 2782
09/26/2022 03:35:37 PM Receipt #: 22-9381
Rec Fee: \$30.00 Darrell James Hill
Gila County, Az, Sadie Jo Bingham, Recorder



-:Trustee -:presumption or discretion to unlawfully -with-hold/ steal the property, -:tangible or intangible, of :i- man.

186 :No authority from :i- man: **:NO :Authorization To :STEAL by :i- man.** :i- man believe and declare that :i- man have not knowingly, voluntarily or intentionally given-authority for the POTUSA- CIC or the POTUS- Trustee to steal/or otherwise abscond -away with the property- claimed and possessed by :i- man.

187 :No authority from :i- man: **:NO- 'Right of :Paternalism-' presumption** :i- man believe and declare that for the **Paternalism of presumptive- unlawful and illegal** -discretion by the Trustee- dereliction is common-law -trespassing against :your- obligation to prohibit deprivation of unalienable-right -harms upon :i-man: Darrell-James: Hill -, :Negro-Ysrael, -:Ohioan-©-1958-A.D., -civilian~ .

188 **:Theft of the trust-property is Dereliction of Trust** :i- believe and declare that for :whatever-the-many-reasons for :your -actions, the :property -'stolen' can only be permitted :in -Trustee -Dereliction with :violation of the Fiduciary- duty and obligations to protect: :i- man from your- Donald's -deprivation of the life, liberty and property against :i- man.

189 **:Stop the damages in the property-theft: Repent, Restore Unto the :UNALIENABLE- Almighty-God- Given- Rights** :i- man believe and declare that you had all actions to rightfully-possess the property, and :none -else; Theft became when :you decided to retain in-specie and or thieve the property without right; to convert or to administrate the :Property- claimed and possessed of :i- man's without unalienable-right is theft.

190 **:Stop the damage of the property-theft: ASSURE AND INSURE THE REPUBLIC-FORM OF :GOVERNMENT DUTY AND OBLIGATION OF THE POTUSA-CIC UPON THE JOB-PERFORMANCE OF THE POTUS** :i- man Believe that the guarantee for the republic-form of :government is the duty and obligation of the POTUSA-CIC overseeing and assuring the meeting of that the job-policy of the POTUS is in the benefit of :i- man- civilian, et al.

191 **:Stop the harm of the property-theft: RESPECT AND ADHERE THE BILL-OF-RIGHTS, -:AMENDMENT 9, -:AMENDMENT 10 WITH NO TRUSTEE, et al.- COMPETITION**

:i- man- beneficiary- Executor believe that it is the POTUSA-CIC -Trustee is to perform to the effect of the guaranteed-duty to :i- man to assure

the republic-form- of-government -to :i- man, and

the :restoration of the EBA-1933-2003-A.D. -Legislative- Dry-Trust upon the return of the verified- trust- debenture to the man-Trustee, -:Trump for restoration of the all- of the property-claimed and requested restored to :i- man, -Ohioan-©-1958-A.D.- civilian- beneficiary, -:Executor -:Darrell-James: Hill Ohioan-©-1958-A.D., of the uSofA-people overstanding DOI-1776-A.D. and TheCftUSofA-1789-1791-A.D., et seq.

192 **:may have erred means:** given the benefit of the doubt, and :you clarify the matter.

193 **:England and Ireland means: Concession-1213-A.D.- beneficiaries**

194 **:Concession-1213-A.D.- Beneficiaries -**

:i- man believe and declare that the :Negro-Ysrael- :Concession-1213-A.D.

-covenanted -:people -:beneficiaries' are Judah, Benjamin, and the Holy-Church -:believers of :Yushuah the :Messiah.

195 **:Theft means: Unlawful-Detainment Of Beneficiary Property-Claimed And Possession :IN -VIOLATION Of The Fiduciary- Duty And Obligations**

:i- man -civilian- beneficiary believe that you- :Trustee -:Trump, et al., have unlawfully- stolen/ or detained-in-specie the property-claimed and possessed of :i- man by Trustee is the violation of :fiduciary -:duty and obligation.

No Authorization From :i- man For :Any- Trustee To Steal from :i- man

:i- man believe and declare that :i- man have not knowingly, voluntarily or intentionally

2020 September Declaration Of :i- man- Adam -:Ambassador to :Yushuah the :Messiah 61 / 62
From: Darrell James: Hill-Negro-Ysrael-©-1958-A.D., -civilian, :Executor- beneficiary - Without-prejudice

1644
2022-011769 MISC Page: 1655 of 2782
09/26/2022 03:35:37 PM Receipt #: 22-9381
Rec Fee: \$30.00 Darrell James Hill
Gila County, Az, Sadie Jo Bingham, Recorder



given-authority for the POTUS- Trustee or the POTUSA-CIC to steal/or otherwise abscond
-away with the property-claimed by :i- man.

**:THEFT : No Authorization Nor Lawful Or Legal Detainment of :PROPERTY-
CLAIMED And Possessed By :i-man**

:i- man believe and declare that the property of :i- man is now held by :you with No-
right or authorization, nor explanation or receipt-given, neither notice- otherwise provided-to
:i-man

Unofficial Copy

1645

2020 September Declaration Of :i- man- Adam -:Ambassador to :Yushuah the :Messiah 62 / 62
From: Darrell James Hill, Negro-Israe...-Ohioan @-1958-A.D., -civilian, :Executor- beneficiary – Without-prejudice

2022-011769 MISC Page: 1656 of 2782

09/26/2022 03:35:37 PM Receipt #: 22-9381

Rec Fee: \$30.00 Darrell James Hill

Gila County, Az, Sadie Jo Bingham, Recorder



Specialty Presentment: USPS RMN RE 322 387 562 US To: Donald-John, -:Trump – Trustee
 Fore Theft of Covenant Property: unalienable-Rights-From-God-Almighty -:Covenant
 For :Restoration of: intangible and tangible stolen-property with remedy to:
 :Darrell-James: Hill, -:Negro-Ysrael, -:Ohioan-©-1958-A.D., -:civilian, -:Executor -:beneficiary, -:Ambassador,
 25 / 62

864
 865
 866
 867
 868
 869
 870
 871
 872

ATTACHMENT A:

Referenced Scriptures – KJV-Book: pg.

Amos chap 4	1
Deuteronomy chap 28	2
Daniel chap 2	5
Obadiah chap 1	8
Psalms chap 83	10
Hosea chap 1 and 2	11
Leviticus chap 11 v 44-45; chap 19 v 1-3	13
1 Peter chap 1 v 13-16	13

873
 874
 875
 876
 877
 878
 879
 880
 881
 882
 883
 884
 885
 886

From: Darrell-James, :Specialty Presentment: USPS RMN RE 322 387 562 US
 To: Donald- John, :Civilian -Exercise :Unalienable-Rights-From-God-Almighty -:Covenant 25 / 6

2022-011769 MISC Page: 1657 of 2782
 09/26/2022 03:35:37 PM Receipt #: 22-9981
 Rec Fee: \$30.00 Darrell James Hill
 Gila County, Az, Sadie Jo Bingham, Recorder



KJV-Book: Amos chap 4

- Amo 4:1 Hear this word, ye kine of Bashan, that *are* in the mountain of Samaria, which oppress the poor, which crush the needy, which say to their masters, Bring, and let us drink.
- Amo 4:2 The Lord GOD hath sworn by his holiness, that, lo, the days shall come upon you, that he will take you away with hooks, and your posterity with fishhooks.
- Amo 4:3 And ye shall go out at the breaches, every *cow at that which is* before her; and ye shall cast *them* into the palace, saith the LORD.
- Amo 4:4 Come to Bethel, and transgress; at Gilgal multiply transgression; and bring your sacrifices every morning, *and* your tithes after three years:
- Amo 4:5 And offer a sacrifice of thanksgiving with leaven, and proclaim *and* publish the free offerings: for this liketh you, O ye children of Israel, saith the Lord GOD.
- Amo 4:6 And I also have given you cleanness of teeth in all your cities, and want of bread in all your places: yet have ye not returned unto me, saith the LORD.
- Amo 4:7 And also I have withholden the rain from you, when *there were* yet three months to the harvest: and I caused it to rain upon one city, and caused it not to rain upon another city: one piece was rained upon, and the piece whereupon it rained not withered.
- Amo 4:8 So two *or* three cities wandered unto one city, to drink water; but they were not satisfied: yet have ye not returned unto me, saith the LORD.
- Amo 4:9 I have smitten you with blasting and mildew: when your gardens and your vineyards and your fig trees and your olive trees increased, the palmerworm devoured *them*: yet have ye not returned unto me, saith the LORD.
- Amo 4:10 I have sent among you the pestilence after the manner of Egypt: your young men have I slain with the sword, and have taken away your horses; and I have made the stink of your camps to come up unto your nostrils: yet have ye not returned unto me, saith the LORD.
- Amo 4:11 I have overthrown *some* of you, as God overthrew Sodom and Gomorrah, and ye were as a firebrand plucked out of the burning: yet have ye not returned unto me, saith the LORD.
- Amo 4:12 Therefore thus will I do unto thee, O Israel: *and* because I will do this unto thee, prepare to meet thy God, O Israel.
- Amo 4:13 For, lo, he that formeth the mountains, and createth the wind, and declareth unto man what *is* his thought, that maketh the morning darkness, and treadeth upon the high places of the earth, The LORD, The God of hosts, *is* his name.

1047
From: Darrell-James, :Specialty Presentment: USPS RMN RE 322 387 562 US

:Unalienable-Rights-From-God-Almighty -:Covenant 1 / 13

2022-011769 MISC Page: 1658 of 2782

09/26/2022 03:35:37 PM Receipt #: 22-9381

Rec Fee: \$30.00 Darrell James Hill

Gila County, Az, Sadie Jo Bingham, Recorder



KJV-Book: Deuteronomy chap 28

Deu 28:1 And it shall come to pass, if thou shalt hearken diligently unto the voice of the LORD thy God, to observe *and* to do all his commandments which I command thee this day, that the LORD thy God will set thee on high above all nations of the earth:

Deu 28:2 And all these blessings shall come on thee, and overtake thee, if thou shalt hearken unto the voice of the LORD thy God.

Deu 28:3 Blessed *shalt thou be* in the city, and blessed *shalt thou be* in the field.

Deu 28:4 Blessed *shall be* the fruit of thy body, and the fruit of thy ground, and the fruit of thy cattle, the increase of thy kine, and the flocks of thy sheep.

Deu 28:5 Blessed *shall be* thy basket and thy store.

Deu 28:6 Blessed *shalt thou be* when thou comest in, and blessed *shalt thou be* when thou goest out.

Deu 28:7 The LORD shall cause thine enemies that rise up against thee to be smitten before thy face: they shall come out against thee one way, and flee before thee seven ways.

Deu 28:8 The LORD shall command the blessing upon thee in thy storehouses, and in all that thou settest thine hand unto; and he shall bless thee in the land which the LORD thy God giveth thee.

Deu 28:9 The LORD shall establish thee an holy people unto himself, as he hath sworn unto thee, if thou shalt keep the commandments of the LORD thy God, and walk in his ways.

Deu 28:10 And all people of the earth shall see that thou art called by the name of the LORD; and they shall be afraid of thee.

Deu 28:11 And the LORD shall make thee plenteous in goods, in the fruit of thy body, and in the fruit of thy cattle, and in the fruit of thy ground, in the land which the LORD swore unto thy fathers to give thee.

Deu 28:12 The LORD shall open unto thee his good treasure, the heaven to give the rain unto thy land in his season, and to bless all the work of thine hand: and thou shalt lend unto many nations, and thou shalt not borrow.

Deu 28:13 And the LORD shall make thee the head, and not the tail; and thou shalt be above only, and thou shalt not be beneath; if that thou hearken unto the commandments of the LORD thy God, which I command thee this day, to observe and to do *them*:

Deu 28:14 And thou shalt not go aside from any of the words which I command thee this day, to the right hand, or to the left, to go after other gods to serve them.

Deu 28:15 But it shall come to pass, if thou wilt not hearken unto the voice of the LORD thy God, to observe to do all his commandments and his statutes which I command thee this day; that all these curses shall come upon thee, and overtake thee:

Deu 28:16 Cursed *shalt thou be* in the city, and cursed *shalt thou be* in the field.

Deu 28:17 Cursed *shall be* thy basket and thy store.

From: Darrell James - Specialty Presentment: USPS RMN RE 322 387 562 US

Case: Unalienable-Rights-From-God-Almighty - Covenant

2 / 13

2022-011769 MISC Page: 1659 of 2782

09/26/2022 03:35:37 PM Receipt #: 22-9381

Rec Fee: \$30.00 Darrell James Hill

Gila County, Az, Sadie Jo Bingham, Recorder



Attachment [A]:

Deu 28:18 Cursed *shall be* the fruit of thy body, and the fruit of thy land, the increase of thy kine, and the flocks of thy sheep.

Deu 28:19 Cursed *shalt thou be* when thou comest in, and cursed *shalt thou be* when thou goest out.

Deu 28:20 The LORD shall send upon thee cursing, vexation, and rebuke, in all that thou settest thine hand unto for to do, until thou be destroyed, and until thou perish quickly; because of the wickedness of thy doings, whereby thou hast forsaken me.

Deu 28:21 The LORD shall make the pestilence cleave unto thee, until he have consumed thee from off the land, whither thou goest to possess it.

Deu 28:22 The LORD shall smite thee with a consumption, and with a fever, and with an inflammation, and with an extreme burning, and with the sword, and with blasting, and with mildew; and they shall pursue thee until thou perish.

Deu 28:23 And thy heaven that *is* over thy head shall be brass, and the earth that is under thee *shall be* iron.

Deu 28:24 The LORD shall make the rain of thy land powder and dust: from heaven shall it come down upon thee, until thou be destroyed.

Deu 28:25 The LORD shall cause thee to be smitten before thine enemies: thou shalt go out one way against them, and flee seven ways before them: and shalt be removed into all the kingdoms of the earth.

Deu 28:26 And thy carcase shall be meat unto all fowls of the air, and unto the beasts of the earth, and no man shall fray *them* away.

Deu 28:27 The LORD will smite thee with the botch of Egypt, and with the emerods, and with the scab, and with the itch, whereof thou canst not be healed.

Deu 28:28 The LORD shall smite thee with madness, and blindness, and astonishment of heart:

Deu 28:29 And thou shalt grope at noonday, as the blind gropeth in darkness, and thou shalt not prosper in thy ways: and thou shalt be only oppressed and spoiled evermore, and no man shall save *thee*.

Deu 28:30 Thou shalt betroth a wife, and another man shall lie with her: thou shalt build an house, and thou shalt not dwell therein: thou shalt plant a vineyard, and shalt not gather the grapes thereof.

Deu 28:31 Thine ox *shall be* slain before thine eyes, and thou shalt not eat thereof: thine ass *shall be* violently taken away from before thy face, and shall not be restored to thee: thy sheep *shall be* given unto thine enemies, and thou shalt have none to rescue *them*.

Deu 28:32 Thy sons and thy daughters *shall be* given unto another people, and thine eyes shall look, and fail *with longing* for them all the day long: and *there shall be* no might in thine hand.

Deu 28:33 The fruit of thy land, and all thy labours, shall a nation which thou knowest not eat up; and thou shalt be only oppressed and crushed alway:

Deu 28:34 So that thou shalt be mad for the sight of thine eyes which thou shalt see.

Deu 28:35 The LORD shall smite thee in the knees, and in the legs, with a sore botch

From: Darrell-James, :Specialty Presentment: USPS RMN RE 322 387 562 US

:Unalienable-Rights-From-God-Almighty -:Covenant 3 / 13

2022-011769 MISC Page: 1660 of 2782
09/26/2022 03:35:37 PM Receipt #: 22-9381
Rec Fee: \$30.00 Darrell James Hill
Gila County, Az, Sadie Jo Bingham, Recorder



Attachment [A]:

- that cannot be healed, from the sole of thy foot unto the top of thy head.
- Deu 28:36 The LORD shall bring thee, and thy king which thou shalt set over thee, unto a nation which neither thou nor thy fathers have known; and there shalt thou serve other gods, wood and stone.
- Deu 28:37 And thou shalt become an astonishment, a proverb, and a byword, among all nations whither the LORD shall lead thee.
- Deu 28:38 Thou shalt carry much seed out into the field, and shalt gather *but* little in; for the locust shall consume it.
- Deu 28:39 Thou shalt plant vineyards, and dress *them*, but shalt neither drink of the wine, nor gather *the grapes*; for the worms shall eat them.
- Deu 28:40 Thou shalt have olive trees throughout all thy coasts, but thou shalt not anoint *thyself* with the oil; for thine olive shall cast *his fruit*.
- Deu 28:41 Thou shalt beget sons and daughters, but thou shalt not enjoy them; for they shall go into captivity.
- Deu 28:42 All thy trees and fruit of thy land shall the locust consume.
- Deu 28:43 The stranger that *is* within thee shall get up above thee very high; and thou shalt come down very low.
- Deu 28:44 He shall lend to thee, and thou shalt not lend to him: he shall be the head, and thou shalt be the tail.
- Deu 28:45 Moreover all these curses shall come upon thee, and shall pursue thee, and overtake thee, till thou be destroyed; because thou hearkenedst not unto the voice of the LORD thy God, to keep his commandments and his statutes which he commanded thee:
- Deu 28:46 And they shall be upon thee for a sign and for a wonder, and upon thy seed for ever.
- Deu 28:47 Because thou servedst not the LORD thy God with joyfulness, and with gladness of heart, for the abundance of all *things*;
- Deu 28:48 Therefore shalt thou serve thine enemies which the LORD shall send against thee, in hunger, and in thirst, and in nakedness, and in want of all *things*: and he shall put a yoke of iron upon thy neck, until he have destroyed thee.
- Deu 28:49 The LORD shall bring a nation against thee from far, from the end of the earth, as *swift* as the eagle flieth; a nation whose tongue thou shalt not understand;
- Deu 28:50 A nation of fierce countenance, which shall not regard the person of the old, nor shew favour to the young:
- Deu 28:51 And he shall eat the fruit of thy cattle, and the fruit of thy land, until thou be destroyed: which *also* shall not leave thee *either* corn, wine, or oil, *or* the increase of thy kine, or flocks of thy sheep, until he have destroyed thee.
- Deu 28:52 And he shall besiege thee in all thy gates, until thy high and fenced walls come down, wherein thou trustedst, throughout all thy land: and he shall besiege thee in all thy gates throughout all thy land, which the LORD thy God hath given thee.
- Deu 28:53 And thou shalt eat the fruit of thine own body, the flesh of thy sons and of thy

From: Darrell-James, :Specialty Presentment: USPS RMN RE 322 387 562 US
To: Donald - John - Civilian - Exercise Unalienable-Rights-From-God-Almighty - :Covenant 4 / 13

2022-011769 MISC Page: 1661 of 2782
09/26/2022 03:35:37 PM Receipt #: 22-9381
Rec Fee: \$30.00 Darrell James Hill
Gila County, Az, Sadie Jo Bingham, Recorder



Attachment [A]:

daughters, which the LORD thy God hath given thee, in the siege, and in the straitness, wherewith thine enemies shall distress thee:

Deu 28:54 *So that* the man *that is* tender among you, and very delicate, his eye shall be evil toward his brother, and toward the wife of his bosom, and toward the remnant of his children which he shall leave:

Deu 28:55 *So that* he will not give to any of them of the flesh of his children whom he shall eat: because he hath nothing left him in the siege, and in the straitness, wherewith thine enemies shall distress thee in all thy gates.

Deu 28:56 The tender and delicate woman among you, which would not adventure to set the sole of her foot upon the ground for delicateness and tenderness, her eye shall be evil toward the husband of her bosom, and toward her son, and toward her daughter,

Deu 28:57 And toward her young one that cometh out from between her feet, and toward her children which she shall bear: for she shall eat them for want of all *things* secretly in the siege and straitness, wherewith thine enemy shall distress thee in thy gates.

Deu 28:58 If thou wilt not observe to do all the words of this law that are written in this book, that thou mayest fear this glorious and fearful name, THE LORD THY GOD;

Deu 28:59 Then the LORD will make thy plagues wonderful, and the plagues of thy seed, *even* great plagues, and of long continuance, and sore sicknesses, and of long continuance.

Deu 28:60 Moreover he will bring upon thee all the diseases of Egypt, which thou wast afraid of; and they shall cleave unto thee.

Deu 28:61 Also every sickness, and every plague, which *is* not written in the book of this law, them will the LORD bring upon thee, until thou be destroyed.

Deu 28:62 And ye shall be left few in number, whereas ye were as the stars of heaven for multitude; because thou wouldest not obey the voice of the LORD thy God.

Deu 28:63 And it shall come to pass, *that* as the LORD rejoiced over you to do you good, and to multiply you; so the LORD will rejoice over you to destroy you, and to bring you to nought; and ye shall be plucked from off the land whither thou goest to possess it.

Deu 28:64 And the LORD shall scatter thee among all people, from the one end of the earth even unto the other; and there thou shalt serve other gods, which neither thou nor thy fathers have known, *even* wood and stone.

Deu 28:65 And among these nations shalt thou find no ease, neither shall the sole of thy foot have rest: but the LORD shall give thee there a trembling heart, and failing of eyes, and sorrow of mind:

Deu 28:66 And thy life shall hang in doubt before thee; and thou shalt fear day and night, and shalt have none assurance of thy life:

Deu 28:67 In the morning thou shalt say, Would God it were even! and at even thou shalt say, Would God it were morning! for the fear of thine heart wherewith thou shalt fear, and for the sight of thine eyes which thou shalt see.

From: Darrell-James, :Specialty Presentment: USPS RMN RE 322 387 562 US

:Unalienable-Rights-From-God-Almighty -:Covenant 5 / 13

2022-011769 MISC Page: 1662 of 2782

09/26/2022 03:35:37 PM Receipt #: 22-9381

Rec Fee: \$30.00 Darrell James Hill

Gila County, Az, Sadie Jo Bingham, Recorder



Attachment [A]:

Deu 28:68 And the LORD shall bring thee into Egypt again with ships, by the way whereof I spake unto thee, Thou shalt see it no more again: and there ye shall be sold unto your enemies for bondmen and bondwomen, and no man shall buy you.

KJV-Book: Daniel chap 2

Dan 2:1 And in the second year of the reign of Nebuchadnezzar Nebuchadnezzar dreamed dreams, wherewith his spirit was troubled, and his sleep brake from him.

Dan 2:2 Then the king commanded to call the magicians, and the astrologers, and the sorcerers, and the Chaldeans, for to shew the king his dreams. So they came and stood before the king.

Dan 2:3 And the king said unto them, I have dreamed a dream, and my spirit was troubled to know the dream.

Dan 2:4 Then spake the Chaldeans to the king in Syriack, O king, live for ever: tell thy servants the dream, and we will shew the interpretation.

Dan 2:5 The king answered and said to the Chaldeans, The thing is gone from me: if ye will not make known unto me the dream, with the interpretation thereof, ye shall be cut in pieces, and your houses shall be made a dunghill.

Dan 2:6 But if ye shew the dream, and the interpretation thereof, ye shall receive of me gifts and rewards and great honour: therefore shew me the dream, and the interpretation thereof.

Dan 2:7 They answered again and said, Let the king tell his servants the dream, and we will shew the interpretation of it.

Dan 2:8 The king answered and said, I know of certainty that ye would gain the time, because ye see the thing is gone from me.

Dan 2:9 But if ye will not make known unto me the dream, *there is but* one decree for you: for ye have prepared lying and corrupt words to speak before me, till the time be changed: therefore tell me the dream, and I shall know that ye can shew me the interpretation thereof.

Dan 2:10 The Chaldeans answered before the king, and said, There is not a man upon the earth that can shew the king's matter: therefore *there is* no king, lord, nor ruler, *that* asked such things at any magician, or astrologer, or Chaldean.

Dan 2:11 And *it is* a rare thing that the king requireth, and there is none other that can shew it before the king, except the gods, whose dwelling is not with flesh.

Dan 2:12 For this cause the king was angry and very furious, and commanded to destroy all the wise *men* of Babylon.

Dan 2:13 And the decree went forth that the wise *men* should be slain; and they sought Daniel and his fellows to be slain.

Dan 2:14 Then Daniel answered with counsel and wisdom to Arioch the captain of the king's guard, which was gone forth to slay the wise *men* of Babylon:

Dan 2:15 He answered and said to Arioch the king's captain, *Why is* the decree so

From: Darrell James : Socialtv.Presentation: USPS RMN RE 322 387 562 US

Unalienable-Rights-From-God-Almighty -:Covenant 6 / 13

2022-011769 MISC Page: 1663 of 2782

09/26/2022 03:35:37 PM Receipt #: 22-9381

Rec Fee: \$30.00 Darrell James Hill

Gila County, Az, Sadie Jo Bingham, Recorder



Attachment [A]:

- hasty from the king? Then Arioch made the thing known to Daniel.
- Dan 2:16 Then Daniel went in, and desired of the king that he would give him time, and that he would shew the king the interpretation.
- Dan 2:17 Then Daniel went to his house, and made the thing known to Hananiah, Mishael, and Azariah, his companions:
- Dan 2:18 That they would desire mercies of the God of heaven concerning this secret; that Daniel and his fellows should not perish with the rest of the wise *men* of Babylon.
- Dan 2:19 Then was the secret revealed unto Daniel in a night vision. Then Daniel blessed the God of heaven.
- Dan 2:20 Daniel answered and said, Blessed be the name of God for ever and ever: for wisdom and might are his:
- Dan 2:21 And he changeth the times and the seasons: he removeth kings, and setteth up kings: he giveth wisdom unto the wise, and knowledge to them that know understanding:
- Dan 2:22 He revealeth the deep and secret things: he knoweth what *is* in the darkness, and the light dwelleth with him.
- Dan 2:23 I thank thee, and praise thee, O thou God of my fathers, who hast given me wisdom and might, and hast made known unto me now what we desired of thee: for thou hast *now* made known unto us the king's matter.
- Dan 2:24 Therefore Daniel went in unto Arioch, whom the king had ordained to destroy the wise *men* of Babylon: he went and said thus unto him; Destroy not the wise *men* of Babylon: bring me in before the king, and I will shew unto the king the interpretation.
- Dan 2:25 Then Arioch brought in Daniel before the king in haste, and said thus unto him, I have found a man of the captives of Judah, that will make known unto the king the interpretation.
- Dan 2:26 The king answered and said to Daniel, whose name was Belteshazzar, Art thou able to make known unto me the dream which I have seen, and the interpretation thereof?
- Dan 2:27 Daniel answered in the presence of the king, and said, The secret which the king hath demanded cannot the wise *men*, the astrologers, the magicians, the soothsayers, shew unto the king;
- Dan 2:28 But there is a God in heaven that revealeth secrets, and maketh known to the king Nebuchadnezzar what shall be in the latter days. Thy dream, and the visions of thy head upon thy bed, are these;
- Dan 2:29 As for thee, O king, thy thoughts came *into thy mind* upon thy bed, what should come to pass hereafter: and he that revealeth secrets maketh known to thee what shall come to pass.
- Dan 2:30 But as for me, this secret is not revealed to me for *any* wisdom that I have more than any living, but for *their* sakes that shall make known the interpretation to the king, and that thou mightest know the thoughts of thy heart.

From: Darrell-James, :Specialty Presentment: USPS RMN RE 322 387 562 US

:Unalienable-Rights-From-God-Almighty -:Covenant 7 / 13

2022-011769 MISC Page: 1664 of 2782
09/26/2022 03:35:37 PM Receipt #: 22-9381
Rec Fee: \$30.00 Darrell James Hill
Gila County, Az, Sadie Jo Bingham, Recorder



Attachment [A]:

- Dan 2:31 Thou, O king, sawest, and behold a great image. This great image, whose brightness was excellent, stood before thee; and the form thereof was terrible.
- Dan 2:32 This image's head was of fine gold, his breast and his arms of silver, his belly and his thighs of brass,
- Dan 2:33 His legs of iron, his feet part of iron and part of clay.
- Dan 2:34 Thou sawest till that a stone was cut out without hands; which smote the image upon his feet *that were* of iron and clay, and brake them to pieces.
- Dan 2:35 Then was the iron, the clay, the brass, the silver, and the gold, broken to pieces together, and became like the chaff of the summer threshingfloors; and the wind carried them away, that no place was found for them: and the stone that smote the image became a great mountain, and filled the whole earth.
- Dan 2:36 This *is* the dream; and we will tell the interpretation thereof before the king.
- Dan 2:37 Thou, O king, *art* a king of kings: for the God of heaven hath given thee a kingdom, power, and strength, and glory.
- Dan 2:38 And wheresoever the children of men dwell, the beasts of the field and the fowls of the heaven hath he given into thine hand, and hath made thee ruler over them all. Thou *art* this head of gold.
- Dan 2:39 And after thee shall arise another kingdom inferior to thee, and another third kingdom of brass, which shall bear rule over all the earth.
- Dan 2:40 And the fourth kingdom shall be strong as iron: forasmuch as iron breaketh in pieces and subdueth all *things*: and as iron that breaketh all these, shall it break in pieces and bruise.
- Dan 2:41 And whereas thou sawest the feet and toes, part of potters' clay, and part of iron, the kingdom shall be divided; but there shall be in it of the strength of the iron, forasmuch as thou sawest the iron mixed with miry clay.
- Dan 2:42 And as the toes of the feet were part of iron, and part of clay, so the kingdom shall be partly strong, and partly broken.
- Dan 2:43 And whereas thou sawest iron mixed with miry clay, they shall mingle themselves with the seed of men: but they shall not cleave one to another, even as iron is not mixed with clay.
- Dan 2:44 And in the days of these kings shall the God of heaven set up a kingdom, which shall never be destroyed: and the kingdom shall not be left to other people, *but* it shall break in pieces and consume all these kingdoms, and it shall stand for ever.
- Dan 2:45 Forasmuch as thou sawest that the stone was cut out of the mountain without hands, and that it brake in pieces the iron, the brass, the clay, the silver, and the gold; the great God hath made known to the king what shall come to pass hereafter: and the dream *is* certain, and the interpretation thereof sure.
- Dan 2:46 Then the king Nebuchadnezzar fell upon his face, and worshipped Daniel, and commanded that they should offer an oblation and sweet odours unto him.
- Dan 2:47 The king answered unto Daniel, and said, Of a truth *it is*, that your God *is* a God of gods, and a Lord of kings, and a revealer of secrets, seeing thou couldst

From: Darrell James -Specialty Presentation: USPS RMN RE 322 387 562 US

:Unalienable-Rights-From-God-Almighty -:Covenant 8 / 13

2022-011769 MISC Page: 1665 of 2782

09/26/2022 03:35:37 PM Receipt #: 22-9381

Rec Fee: \$30.00 Darrell James Hill

Gila County, Az, Sadie Jo Bingham, Recorder



Attachment [A]:

reveal this secret.

Dan 2:48 Then the king made Daniel a great man, and gave him many great gifts, and made him ruler over the whole province of Babylon, and chief of the governors over all the wise *men* of Babylon.

Dan 2:49 Then Daniel requested of the king, and he set Shadrach, Meshach, and Abednego, over the affairs of the province of Babylon: but Daniel *sat* in the gate of the king.

KJV-Book: Obadiah chap 1

Oba 1:1 The vision of Obadiah. Thus saith the Lord GOD concerning Edom; We have heard a rumour from the LORD, and an ambassador is sent among the heathen, Arise ye, and let us rise up against her in battle.

Oba 1:2 Behold, I have made thee small among the heathen: thou art greatly despised.

Oba 1:3 The pride of thine heart hath deceived thee, thou that dwellest in the clefts of the rock, whose habitation *is* high; that saith in his heart, Who shall bring me down to the ground?

Oba 1:4 Though thou exalt *thyself* as the eagle, and though thou set thy nest among the stars, thence will I bring thee down, saith the LORD.

Oba 1:5 If thieves came to thee, if robbers by night, (how art thou cut off!) would they not have stolen till they had enough? if the grapegatherers came to thee, would they not leave *some* grapes?

Oba 1:6 How are *the things* of Esau searched out! *how* are his hidden things sought up!

Oba 1:7 All the men of thy confederacy have brought thee *even* to the border: the men that were at peace with thee have deceived thee, *and* prevailed against thee; *they that eat* thy bread have laid a wound under thee: *there is* none understanding in him.

Oba 1:8 Shall I not in that day, saith the LORD, even destroy the wise *men* out of Edom, and understanding out of the mount of Esau?

Oba 1:9 And thy mighty *men*, O Teman, shall be dismayed, to the end that every one of the mount of Esau may be cut off by slaughter.

Oba 1:10 For *thy* violence against thy brother Jacob shame shall cover thee, and thou shalt be cut off for ever.

Oba 1:11 In the day that thou stoodest on the other side, in the day that the strangers carried away captive his forces, and foreigners entered into his gates, and cast lots upon Jerusalem, even thou *wast* as one of them.

Oba 1:12 But thou shouldest not have looked on the day of thy brother in the day that he became a stranger; neither shouldest thou have rejoiced over the children of Judah in the day of their destruction; neither shouldest thou have spoken proudly in the day of distress.

Oba 1:13 Thou shouldest not have entered into the gate of my people in the day of their calamity; yea, thou shouldest not have looked on their affliction in the day of their calamity, nor have laid *hands* on their substance in the day of their calamity;

From: Darrell James -Specialty Presentation: USPS RMN RE 322 387 562 US

:Unalienable-Rights-From-God-Almighty -:Covenant 9 / 13

2022-011769 MISC Page: 1666 of 2782

09/26/2022 03:35:37 PM Receipt #: 22-9381

Rec Fee: \$30.00 Darrell James Hill

Gila County, Az, Sadie Jo Bingham, Recorder



Attachment [A]:

Oba 1:14 Neither shouldst thou have stood in the crossway, to cut off those of his that did escape; neither shouldst thou have delivered up those of his that did remain in the day of distress.

Oba 1:15 For the day of the LORD *is* near upon all the heathen: as thou hast done, it shall be done unto thee: thy reward shall return upon thine own head.

Oba 1:16 For as ye have drunk upon my holy mountain, so shall all the heathen drink continually, yea, they shall drink, and they shall swallow down, and they shall be as though they had not been.

Oba 1:17 But upon mount Zion shall be deliverance, and there shall be holiness; and the house of Jacob shall possess their possessions.

Oba 1:18 And the house of Jacob shall be a fire, and the house of Joseph a flame, and the house of Esau for stubble, and they shall kindle in them, and devour them; and there shall not be *any* remaining of the house of Esau; for the LORD hath spoken *it*.

Oba 1:19 And *they of* the south shall possess the mount of Esau; and *they of* the plain the Philistines: and they shall possess the fields of Ephraim, and the fields of Samaria: and Benjamin *shall possess* Gilead.

Oba 1:20 And the captivity of this host of the children of Israel *shall possess* that of the Canaanites, *even* unto Zarephath; and the captivity of Jerusalem, which *is* in Sepharad, shall possess the cities of the south.

Oba 1:21 And saviours shall come up on mount Zion to judge the mount of Esau; and the kingdom shall be the LORD'S.

KJV-Book: Psalms chap 83

Psa 83:1 A Song or Psalm of Asaph. Keep not thou silence, O God: hold not thy peace, and be not still, O God.

Psa 83:2 For, lo, thine enemies make a tumult: and they that hate thee have lifted up the head.

Psa 83:3 They have taken crafty counsel against thy people, and consulted against thy hidden ones.

Psa 83:4 They have said, Come, and let us cut them off from *being* a nation; that the name of Israel may be no more in remembrance.

Psa 83:5 For they have consulted together with one consent: they are confederate against thee:

Psa 83:6 The tabernacles of Edom, and the Ishmaelites; of Moab, and the Hagarenes;

Psa 83:7 Gebal, and Ammon, and Amalek; the Philistines with the inhabitants of Tyre;

Psa 83:8 Assur also is joined with them: they have holpen the children of Lot. Selah.

Psa 83:9 Do unto them as *unto* the Midianites; as *to* Sisera, as *to* Jabin, at the brook of Kison:

Psa 83:10 *Which* perished at Endor: they became as dung for the earth.

Psa 83:11 Make their nobles like Oreb, and like Zeeb: yea, all their princes as Zebah, and as Zalmunna:

From: Darrell-James -Specialty Presentation: USPS RMN RE 322 387 562 US

alienable-Rights-From-God-Almighty -Covenant 10 / 13

2022-011769 MISC Page: 1667 of 2782

09/26/2022 03:35:37 PM Receipt #: 22-9381
Rec Fee: \$30.00 Darrell James Hill
Gila County, Az, Sadie Jo Bingham, Recorder



Attachment [A]:

- Psa 83:12 Who said, Let us take to ourselves the houses of God in possession.
Psa 83:13 O my God, make them like a wheel; as the stubble before the wind.
Psa 83:14 As the fire burneth a wood, and as the flame setteth the mountains on fire;
Psa 83:15 So persecute them with thy tempest, and make them afraid with thy storm.
Psa 83:16 Fill their faces with shame; that they may seek thy name, O LORD.
Psa 83:17 Let them be confounded and troubled for ever; yea, let them be put to shame, and perish:
Psa 83:18 That *men* may know that thou, whose name alone is JEHOVAH, art the most high over all the earth.

KJV-Book: Hosea chap 1

- Hos 1:1 The word of the LORD that came unto Hosea, the son of Beeri, in the days of Uzziah, Jotham, Ahaz, and Hezekiah, kings of Judah, and in the days of Jeroboam the son of Joash, king of Israel.
Hos 1:2 The beginning of the word of the LORD by Hosea. And the LORD said to Hosea, Go, take unto thee a wife of whoredoms and children of whoredoms: for the land hath committed great whoredom, *departing* from the LORD.
Hos 1:3 So he went and took Gomer the daughter of Diblaim; which conceived, and bare him a son.
Hos 1:4 And the LORD said unto him, Call his name Jezreel; for yet a little *while*, and I will avenge the blood of Jezreel upon the house of Jehu; and will cause to cease the kingdom of the house of Israel.
Hos 1:5 And it shall come to pass at that day, that I will break the bow of Israel in the valley of Jezreel.
Hos 1:6 And she conceived again, and bare a daughter. And God said unto him, Call her name Loruhamah: for I will no more have mercy upon the house of Israel; but I will utterly take them away.
Hos 1:7 But I will have mercy upon the house of Judah, and will save them by the LORD their God, and will not save them by bow, nor by sword, nor by battle, by horses, nor by horsemen.
Hos 1:8 Now when she had weaned Loruhamah, she conceived, and bare a son.
Hos 1:9 Then said God, Call his name Loammi: for ye are not my people, and I will not be your God.
Hos 1:10 Yet the number of the children of Israel shall be as the sand of the sea, which cannot be measured nor numbered; and it shall come to pass, *that* in the place where it was said unto them, Ye are not my people, *there* it shall be said unto them, Ye are the sons of the living God.
Hos 1:11 Then shall the children of Judah and the children of Israel be gathered together, and appoint themselves one head, and they shall come up out of the land: for great *shall be* the day of Jezreel.

From: Darrell James, Specialty Presentment: USPS RMN RE 322 387 562 US

alienable-Rights-From-God-Almighty -Covenant 11 / 13

2022-011769 MISC Page: 1668 of 2782
09/26/2022 03:35:37 PM Receipt #: 22-9381
Rec Fee: \$30.00 Darrell James Hill
Gila County, Az, Sadie Jo Bingham, Recorder



KJV-Book: Hosea chap 2

- Hos 2:1 Say ye unto your brethren, Ammi; and to your sisters, Ruhamah.
- Hos 2:2 Plead with your mother, plead: for she *is* not my wife, neither *am* I her husband: let her therefore put away her whoredoms out of her sight, and her adulteries from between her breasts;
- Hos 2:3 Lest I strip her naked, and set her as in the day that she was born, and make her as a wilderness, and set her like a dry land, and slay her with thirst.
- Hos 2:4 And I will not have mercy upon her children; for they *be* the children of whoredoms.
- Hos 2:5 For their mother hath played the harlot: she that conceived them hath done shamefully: for she said, I will go after my lovers, that give *me* my bread and my water, my wool and my flax, mine oil and my drink.
- Hos 2:6 Therefore, behold, I will hedge up thy way with thorns, and make a wall, that she shall not find her paths.
- Hos 2:7 And she shall follow after her lovers, but she shall not overtake them; and she shall seek them, but shall not find *them*: then shall she say, I will go and return to my first husband; for then *was it* better with me than now.
- Hos 2:8 For she did not know that I gave her corn, and wine, and oil, and multiplied her silver and gold, *which* they prepared for Baal.
- Hos 2:9 Therefore will I return, and take away my corn in the time thereof, and my wine in the season thereof, and will recover my wool and my flax *given* to cover her nakedness.
- Hos 2:10 And now will I discover her lewdness in the sight of her lovers, and none shall deliver her out of mine hand.
- Hos 2:11 I will also cause all her mirth to cease, her feast days, her new moons, and her sabbaths, and all her solemn feasts.
- Hos 2:12 And I will destroy her vines and her fig trees, whereof she hath said, These *are* my rewards that my lovers have given me: and I will make them a forest, and the beasts of the field shall eat them.
- Hos 2:13 And I will visit upon her the days of Baalim, wherein she burned incense to them, and she decked herself with her earrings and her jewels, and she went after her lovers, and forgot me, saith the LORD.
- Hos 2:14 Therefore, behold, I will allure her, and bring her into the wilderness, and speak comfortably unto her.
- Hos 2:15 And I will give her her vineyards from thence, and the valley of Achor for a door of hope: and she shall sing there, as in the days of her youth, and as in the day when she came up out of the land of Egypt.
- Hos 2:16 And it shall be at that day, saith the LORD, *that* thou shalt call me Ishi; and shalt call me no more Baali.
- Hos 2:17 For I will take away the names of Baalim out of her mouth, and they shall no

From: Darrell-James, :Specialty Presentment: USPS RMN RE 322 387 562 US
 To: Donald- John, :Civilian -Exercise :Unalienable-Rights-From-God-Almighty -:Covenant 12 / 13

2022-011769 MISC Page: 1669 of 2782

09/26/2022 03:35:37 PM Receipt #: 22-9381

Rec Fee: \$30.00 Darrell James Hill

Gila County, Az, Sadie Jo Bingham, Recorder



Attachment [A]:

more be remembered by their name.

Hos 2:18 And in that day will I make a covenant for them with the beasts of the field, and with the fowls of heaven, and *with* the creeping things of the ground: and I will break the bow and the sword and the battle out of the earth, and will make them to lie down safely.

Hos 2:19 And I will betroth thee unto me for ever; yea, I will betroth thee unto me in righteousness, and in judgment, and in lovingkindness, and in mercies.

Hos 2:20 I will even betroth thee unto me in faithfulness: and thou shalt know the LORD.

Hos 2:21 And it shall come to pass in that day, I will hear, saith the LORD, I will hear the heavens, and they shall hear the earth;

Hos 2:22 And the earth shall hear the corn, and the wine, and the oil; and they shall hear Jezreel.

Hos 2:23 And I will sow her unto me in the earth; and I will have mercy upon her that had not obtained mercy; and I will say to *them which were* not my people, Thou art my people; and they shall say, *Thou art* my God.

KJV-Book: Leviticus chap 11 v 44-45; chap 19 1-3

Lev 11:45 For I *am* the LORD that bringeth you up out of the land of Egypt, to be your God: ye shall therefore be holy, for I *am* holy.

Lev 11:46 This *is* the law of the beasts, and of the fowl, and of every living creature that moveth in the waters, and of every creature that creepeth upon the earth:

Lev 19:1 And the LORD spake unto Moses, saying,

Lev 19:2 Speak unto all the congregation of the children of Israel, and say unto them, Ye shall be holy: for I the LORD your God *am* holy.

Lev 19:3 Ye shall fear every man his mother, and his father, and keep my sabbaths: I *am* the LORD your God.

KJV-Book: 1 Peter chap 1 v 13-16

1Pe 1:13 Wherefore gird up the loins of your mind, be sober, and hope to the end for the grace that is to be brought unto you at the revelation of Jesus Christ;

1Pe 1:14 As obedient children, not fashioning yourselves according to the former lusts in your ignorance:

1Pe 1:15 But as he which hath called you is holy, so be ye holy in all manner of conversation;

1Pe 1:16 Because it is written, Be ye holy; for I am holy.

From: Darrell-James, :Specialty Presentment: USPS RMN RE 322 387 562 US

Unalienable-Rights-From-God-Almighty -:Covenant 13 / 13

2022-011769 MISC Page: 1670 of 2782
09/26/2022 09:35:37 PM Receipt #: 22-9381
Rec Fee: \$30.00 Darrell James Hill
Gila County, Az, Sadie Jo Bingham, Recorder



Specialty Presentment: USPS RMN RE 322 387 562 US To: Donald-John, -:Trump – Trustee
Fore Theft of Covenant Property: unalienable-Rights-From-God-Almighty -:Covenant
For :Restoration of: intangible and tangible stolen-property with remedy to:
:Darrell-James: Hill, -:Negro-Ysrael, -:Ohioan-©-1958-A.D., -:civilian, -:Executor -:beneficiary, -:Ambassador,
26 / 62

887
888
889
890
891
892
893
894
895

896
897
898
899
900
901
902
903
904
905
906
907
908
909
910
911
912
913
914
915
916
917
918
919
920
921
922
923
924
925
926
927
928

ATTACHMENT B:

**'For the Cure and Relief -in the :Equity-Claim, and For the Remedy-Required For the
Trespassing Upon The Children of Ysrael/Israel, et al.;
To:Jorge-Mario: Bergoglio:USPS RMN RE 322 387 576 US;
c/o Apostolic Palace, 00120 Vatican City,
c/o :Donald-John :CIC- :Trump :USPS RMN RE 322 387 562 US;
1600 Pennsylvania Ave NW, Washington, District of Columbia 20500;
APPENDED: 7 PAGES, :wholly-Incorporated by-this- :reference.**

2022-011769 MISC Page: 1671 of 2782
09/26/2022 03:35:37 PM Receipt #: 22-9381
Rec Fee: \$30.00 Darrell James Hill
Gila County, Az, Sadie Jo Bingham, Recorder



ment: USPS RMN RE 322 387 562 US
Unalienable-Rights-From-God-Almighty -:Covenant 26 / 62

Declaration of :i- man - :Ambassador to :Yushuah the :Messiah

From :Darrell-James: Hill¹, -:i- man², -:civilian, -:Executor³, -:Ambassador⁴,
PO Box 3806, Apache Junction, Arizona 85117

:man -:present,

:The united States of America,

Arizona state
Pinal county

To :Jorge-Mario: Bergoglio⁵ ~:USPS RMN RE 322 387 576 US
c/o Apostolic Palace
00120 Vatican City^{6 7}

c/o :Donald-John :CIC- :Trump^{8 9} :USPS RMN RE 322 387 562 US
1600 Pennsylvania Ave NW
Washington, District of Columbia 20500

2022-011769 MISC Page: 1672 of 2782
09/26/2022 03:35:37 PM Receipt #: 22-9381
Rec Fee: \$30.00 Darrell James Hill
Gila County, Az, Sadie Jo Bingham, Recorder

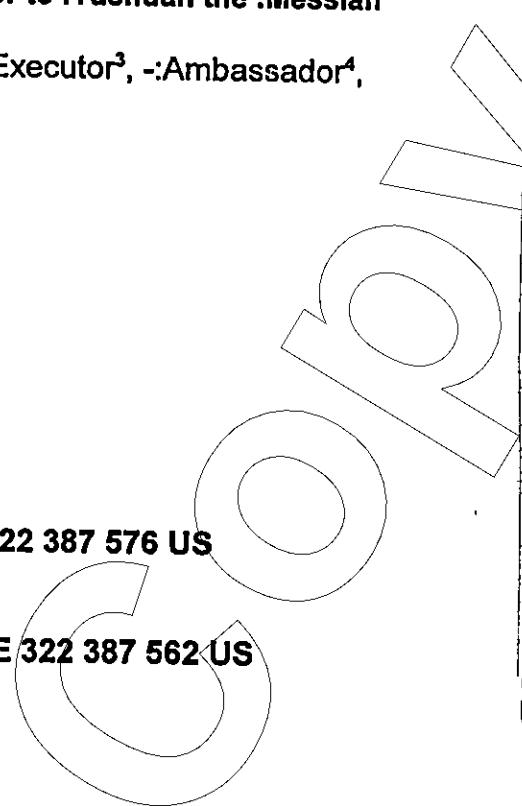

**Specialty- Presentment: To The Roman -Church¹⁰, et al.- Usurpers,
For the Cure and Relief -in the :Equity-Claim, and For the Remedy-Required
For the Trespassing Upon The Children of Ysrael/Israel, et al.**

Greetings :Jorge-Mario, :Donald-John, et al.,

With all due respect, :i- man am to declare this to you by order of the Messiah Yushuah~Jesus~ God-Almighty. You must let All of the people of the Most-High-God go free unharmed with all of their belongings and with the full-accounting of their property and chattel. To :this- end, :i- man must declare to you:

A- :Declaration: i- man am: Judah of: Ysrael

:i- man declare 1) the :embodiment of :i-man- Adam¹¹ within the oneness with the Almighty- Creator -:God with the man :Jacob~ Ysrael¹², son of :Isaac¹³ the :brother of

- 1 :Darrell-James: Hill means: Earthen -man-child, :birthed :son of :Clarence, :son of :James, :son 'Negroland, :Kingdom-of-Judah, 'Africa', ...:son :Ysrael' :Southern-Kingdom ~ of the sons :Judah and Benjamin and Levi, et al.~, ...:son of :Jacob and :Ysrael, :son of :Isaac, :son of :Abram and :Abraham, ...:son of :Shem, :son of :Noah, ...:son of :Methuselah, :son of :Enoch, ...:son of :Seth, :son of :Adam with :Eve of the garden of :Eden ~ including all :known and unknown :ancestral- lands ~ on the earth placed under the Adamic- lineage and under the :only-begotten -son of the Most-High-God and Father embodied within the rebirth by (:i- man of the power of :Yushuah-Messiah, -:God, with the redemption by the Messiah- Yushuah ('Jesus-the-Christ'), and encompassing the :receivership, responsibility and administration over :all of the earth-planet as :heir- :remainderman, and :Kinsman- :redeemer of the Earth, both 1) from the Adamic-lineage by the :loss in :spirit in the man upon the Earth, and 2) by the Messiah-Yushuah by the restoration in the Holy Spirit in :i- man upon the Earth: on, in or under-the-surface of the planet; on, in or under-the-surface of the oceans and waters, and :on, in, under-the-surface of the atmosphere/ above the atmosphere of the Earth to wherever the Adamic- :man-kind in the quantum and in the spirit is now, of where the :purposes of the Most High God and Father are immeasurable by mere :man. No-thing Stands between the Almighty God~ His Father; See; KJV- Book: Daniel -chap. 7 v 9 - 14.~ and :i-man.
- 2 :i- man means: 'I' is the Great; I am, Almighty God Creator of all and for whom all is; 'man' is the kind on this Earth- world, made in the image of the Almighty God and His Father, the 'Ancient-of-Days -- the Most-High-God
- 3 :Darrell-James: Hill means: :Darrell-James: Hill means: Darrell-James: Hill © 1958: Ohioan, © 1958: State of Ohio: beneficiary. See: Gila county Arizona: Doc. # 2017-002378: pp. 6-24, 89-91,93-95 of 693. Gila county Arizona: Doc. # 2018-005176: pp. 10-21; and, et seq.: beneficiary of the Cestui Que Trustee-minister: Jorge-Mario: Bergoglio⁵⁵
- 4 :Ambassador means: KJV- Book: Ephesians— chap.. 6, v. 20. "For which I am an ambassador in bonds: that therein I may speak boldly, as I ought to speak."
- 5 :Jorge-Mario: Bergoglio means: man-kind of the Earth-planet
- 6 :Babylon-Rome means: KJV- Book :Daniel -chap. 2, v. 40 - 43.
- 7 :Rome means: KJV- Book: Obadiah— chap. 1; Psalms— chap.. 83.
- 8 :Donald-John: Trump means: man -:trustee under the duty, obligation and moral-Oath of Office: 20th day of January, the year our Lord 2020 A.D.~, ministry: as :President of 'The united states of America' ~unincorporated,1776 A.D.- as 'Commander-in-Chief with the :General Order 100 ~Lieber Code~ :24th day, April, the year of our Lord 1863 A.D: under the Declaration of Independence for the united states of America -people by 'The Constitution for the United States of America' .
- 9 :Donald-John: Trump means: man-kind of the Earth-planet, :man -:trustee under the duty, obligation and moral-Oath of Office
- 10 :Roman -Church means: the polytheism government methodology contrived and implemented from the 4th century A.D. by the Roman Emperor Constantine.
- 11 :Adam means: within the oneness with the Almighty- Creator -:God. See: KJV- Book: Genesis- chap. 2
- 12 :Jacob~ Ysrael means: covenant of :God-Almighty and :Jacob means: KJV- Book: Genesis- chap 26 v 34 - Genesis- chap 31 v 29.
- 13 :Isaac means: covenant of :God-Almighty and Issac means: KJV- Book: Genesis— chap.. 17 v 15 And God said unto

1661

Declaration of :-i- man - :Ambas

:Ishmael¹⁴, sons of :Abram ~Abraham¹⁵, ...son of :Shem, ...son of: Noah¹⁶, ...son of Methuselah, ...son of :Adam; and, 2) :-i- man- Adam declare that :-i- man - :Negro¹⁷ am yet upon The united states of America a) :Judah of the people of Ysrael of the man :Jacob, and that :-i- man am b) spiritually :Adam -of -Ysrael¹⁸ by the blood of the Messiah: Yushuah ~'Christ Jesus' ~ the : Almighty God~, by His Father's will be done.¹⁹ Thereto: No-thing Stands between the :Almighty God~ who is in oneness with His Father²⁰ and :-i-man-²¹ :Darrell-James: Hill.

B - :-i- man - :Adam Believe with :Faith in the Creator - :Almighty- God - :Statement

1. :-i- man believe in the Creator-Almighty-God as characterized in the wise by the equations:

- a) $0 + 0 = 0$, et seq., where "0" is the absolutely empty set; where
a.i.) "0" is the only moral -truth -set; that is, nothing plus nothing equals nothing;

Abraham, As for Sarai thy wife, thou shalt not call her name Sarai, but Sarah shall her name be. 16 And I will bless her, and give thee a son also of her: yea, I will bless her, and she shall be a mother of nations; kings of people shall be of her. 17 Then Abraham fell upon his face, and laughed, and said in his heart, Shall a child be born unto him that is an hundred years old? and shall Sarah, that is ninety years old, bear? 18 And Abraham said unto God, O that Ishmael might live before thee! 19 And God said, Sarah thy wife shall bear thee a son indeed; and thou shalt call his name Isaac: and I will establish my covenant with him for an everlasting covenant, and with his seed after him.

14 .: brother - :Ishmael means: covenant of :God-Almighty and Ishmael means: KJV- Book: Genesis-- chap.. 17 (a) v 9 And God said unto Abraham, Thou shalt keep my covenant therefore, thou, and thy seed after thee in their generations. 10 This is my covenant, which ye shall keep, between me and you and thy seed after thee; Every man child among you shall be circumcised. ... 11 And ye shall circumcise the flesh of your foreskin; and it shall be a token of the covenant betwixt me and you. 12 And he that is eight days old shall be circumcised among you, every man child in your generations, he that is born in the house, or bought with money of any stranger, which is not of thy seed. 13 He that is born in thy house, and he that is bought with thy money, must needs be circumcised: and my covenant shall be in your flesh for an everlasting covenant. 14 And the uncircumcised man child whose flesh of his foreskin is not circumcised, that soul shall be cut off from his people; he hath broken my covenant. ... 18 And Abraham said unto God, O that Ishmael might live before thee! 19 And God said, Sarah thy wife shall bear thee a son indeed; and thou shalt call his name Isaac: and I will establish my covenant with him for an everlasting covenant, and with his seed after him. 20 And as for Ishmael, I have heard thee: Behold, I have blessed him, and will make him fruitful, and will multiply him exceedingly; twelve princes shall he beget, and I will make him a great nation. ... 23 And Abraham took Ishmael his son, and all that were born in his house, and all that were bought with his money, every male among the men of Abraham's house; and circumcised the flesh of their foreskin in the selfsame day, as God had said unto him. 24 And Abraham was ninety years old and nine, when he was circumcised in the flesh of his foreskin. 25 And Ishmael his son was thirteen years old, when he was circumcised in the flesh of his foreskin. 26 In the selfsame day was Abraham circumcised, and Ishmael his son.

15 :Abram ~Abraham means: covenant of God-Almighty and Abram ~Abraham means: KJV- Book: Genesis-- chap.. 17 (a) v 1 And when Abram was ninety years old and nine, the LORD appeared to Abram, and said unto him, I am the Almighty God; walk before me, and be thou perfect. 2 And I will make my covenant between me and thee, and will multiply thee exceedingly. 3 And Abram fell on his face: and God talked with him, saying, 4 As for me, behold, my covenant is with thee, and thou shalt be a father of many nations. 5 Neither shall thy name any more be called Abram, but thy name shall be Abraham; for a father of many nations have I made thee. (b) 6 And I will make thee exceeding fruitful, and I will make nations of thee, and kings shall come out of thee. (c) 7 And I will establish my covenant between me and thee and thy seed after thee in their generations for an everlasting covenant, to be a God unto thee, and to thy seed after thee. 8 And I will give unto thee, and to thy seed after thee, the land wherein thou art a stranger, all the land of Canaan, for an everlasting possession; and I will be their God. 9 And God said unto Abraham, Thou shalt keep my covenant therefore, thou, and thy seed after thee in their generations. 10 This is my covenant, which ye shall keep, between me and you and thy seed after thee; Every man child among you shall be circumcised. (d1/2) 11 And ye shall circumcise the flesh of your foreskin; and it shall be a token of the covenant betwixt me and you. 12 And he that is eight days old shall be circumcised among you, every man child in your generations, he that is born in the house, or bought with money of any stranger, which is not of thy seed. 13 He that is born in thy house, and he that is bought with thy money, must needs be circumcised: and my covenant shall be in your flesh for an everlasting covenant. 14 And the uncircumcised man child whose flesh of his foreskin is not circumcised, that soul shall be cut off from his people; he hath broken my covenant. (e) 15 And God said unto Abraham, As for Sarai thy wife, thou shalt not call her name Sarai, but Sarah shall her name be. 16 And I will bless her, and give thee a son also of her: yea, I will bless her, and she shall be a mother of nations; kings of people shall be of her. 17 Then Abraham fell upon his face, and laughed, and said in his heart, Shall a child be born unto him that is an hundred years old? and shall Sarah, that is ninety years old, bear? (f) 18 And Abraham said unto God, O that Ishmael might live before thee! (g1/2) 19 And God said, Sarah thy wife shall bear thee a son indeed; and thou shalt call his name Isaac: and I will establish my covenant with him for an everlasting covenant, and with his seed after him. (h) 20 And as for Ishmael, I have heard thee: Behold, I have blessed him, and will make him fruitful, and will multiply him exceedingly; twelve princes shall he beget, and I will make him a great nation. (g2/2) 21 But my covenant will I establish with Isaac, which Sarah shall bear unto thee at this set time in the next year. (i) 22 And he left off talking with him, and God went up from Abraham. (j) 23 And Abraham took Ishmael his son, and all that were born in his house, and all that were bought with his money, every male among the men of Abraham's house; and circumcised the flesh of their foreskin in the selfsame day, as God had said unto him. 24 And Abraham was ninety years old and nine, when he was circumcised in the flesh of his foreskin. 25 And Ishmael his son was thirteen years old, when he was circumcised in the flesh of his foreskin. 26 In the selfsame day was Abraham circumcised, and Ishmael his son. 27 And all the men of his house, born in the house, and bought with money of the stranger, were circumcised with him.

16 :Noah means covenant of God-Almighty and Noah means: KJV- Book: Genesis-- chap.. 9 v 8 And God spake unto Noah, and to his sons with him, saying, 9 And I, behold, I establish my covenant with you, and with your seed after you; 10 And with every living creature that is with you, of the fowl, of the cattle, and of every beast of the earth with you; from all that go out of the ark, to every beast of the earth. 11 And I will establish my covenant with you; neither shall all flesh be cut off any more by the waters of a flood; neither shall there any more be a flood to destroy the earth. 12 And God said, This is the token of the covenant which I make between me and you and every living creature that is with you, for perpetual generations: 13 I do set my bow in the cloud, and it shall be for a token of a covenant between me and the earth. 14 And it shall come to pass, when I bring a cloud over the earth, that the bow shall be seen in the cloud: 15 And I will remember my covenant, which is between me and you and every living creature of all flesh; and the waters shall no more become a flood to destroy all flesh. 16 And the bow shall be in the cloud; and I will look upon it, that I may remember the everlasting covenant between God and every living creature of all flesh that is upon the earth. 17 And God said unto Noah, This is the token of the covenant, which I have established between me and all flesh that is upon the earth. 18 And the sons of Noah, that went forth of the ark, were Shem, and Ham, and Japheth: and Ham is the father of Canaan.

17 :Negro means: son of the Southern-Kingdom -of -Ysrael; enslaved by the Trustee-minister of the Magna Carta, et al.- Usurpers
18 :Adam of :Ysrael means: KJV- Book: A) Romans- chap. 5 v 12 Wherefore, as by one man sin entered into the world, and

Declaration of :i- man - :Ambassador to :Yushuah the :Messiah

and:

b) $0 + 1 = 1$, et seq., where "1" is the presence of the substance of the set of characteristics; that is, nothing plus :1 -:something equals :1 -:something; where b.i.) "1" is the only moral -truth -set;

and,

c) where the inverse of truth is characterized by the equations:

c.i) $0 + 0 = X$ -set where the untruth is the any 'set of X', except the "0" truth,

and

where

c.ii) $0 + 1 = Y$ -set where the untruth is the any 'set of Y', except the "1" truth.

Where-as: all -that-is -created in the worlds of the universes has :origin in the sum of the sets of :characteristics expressed within :a), b) and c)' with the intelligent- design by the Almighty-God with His Father, the :Most-High-God.

2. :i- man believe that :man -kind is the indivisible corporation of the spiritual faculties of the spirit and soul components joined into the original-intelligence- live- earthen-product by the Creator-God's design. And:

3. :i- man believe that man -kind's now-fallen-state diverged from the Creator-Gods' baseline design of :man- kinds' first estate -in -:oneness -with -:God; that, :man-kind's baseline -normal is in :oneness with the Most-High-God;

Where-as, that the act-of-repentance, -changing and turning toward God's law is by the exercise of the spiritual faculties toward :oneness -with -:God, repentance is the :foundation of :man-kinds' :spiritual-joy, physical-happiness, and :gladness with :abundance in :well-being ²².

C - :NOTICE:

Purgatory Oath: Lateness Of This Presentment

:i-man Affirm and Declare That The 'lateness Of This Presentment' Is Due To The Lack Of Knowledge And Ignorance Of :i-man; and, the :Trust -resources to afford the cost of this pursuit have been a) administered without authorization and b) used to impose harm and competition against :i-man -:beneficiary, et al.- children of Ysrael.

For the fact that :i-man- Adam, et al.- Judah, have been systematically -systemically -oppressed with the brutality-imposed -ignorance and assurance unto the lack of knowledge from the confederate- usurpers since on or before 1600 A.D. unto now ~2020 A.D.~ with the oversight and support for these and other harms by the Roman-Church -Usurper-Trustee -gross -malfeasance. Thereto, :i- man believe that this presentment is timely through the four centuries upon the historical accounts and recorded facts of the murder-for- annihilation for the extinction²³, and the continued abject- hostility upon :i- man, et al. - members of the House of Ysrael by the :absolute-malfeasance²⁴ of the pure -obligation²⁵ by the "Roman -Church", et al.- confederate -:impostors.

death by sin; and so death passed upon all men, for that all have sinned: 13 (For until the law sin was in the world: but sin is not imputed when there is no law. 14 Nevertheless death reigned from Adam to Moses, even over them that had not sinned after the similitude of Adam's transgression, who is the figure of him that was to come. B) 1 Corinthians— chap.. 15 v 21 For since by man *came* death, by man *came* also the resurrection of the dead. 22 For as in Adam all die, even so in Christ shall all be made alive. 23 But every man in his own order: Christ the firstfruits; afterward they that are Christ's at his coming. 24 Then *cometh* the end, when he shall have delivered up the kingdom to God, even the Father; when he shall have put down all rule and all authority and power. 25 For he must reign, till he hath put all enemies under his feet. 26 The last enemy *that* shall be destroyed is death. C) 1 Corinthians— chap.. 15 v 42 So also *is* the resurrection of the dead. It is sown in corruption; it is raised in incorruption: 43 It is sown in dishonour; it is raised in glory: it is sown in weakness; it is raised in power. 44 It is sown a natural body; it is raised a spiritual body. There is a natural body, and there is a spiritual body. 45 And so it is written, The first man Adam was made a living soul; the last Adam was made a quickening spirit.

19 :Father's will be done[] means: KJV- Book: Mark- chap.. 14 v. 32-36.

20 :Almighty God- who is in oneness with His Father means: KJV- Book: John -chap 17

21 Ibid. 1

22 :abundance in :well-being means: KJV- Book :Hebrews- chap 5 and 6.

23 :murder-for- annihilation for the extinction means: KJV- a) Book: Psalms 83. ; b) Book: Obadiah -chap 1.

24 :absolute- malfeasance means: contracts, torts. The unjust performance of some act which the party had no right, or which he had contracted not to do.

25 :pure -obligation means: tie which binds us to pay or to do something agreeably to the laws and customs of the country in which the obligation is made.



Declaration of :i- man - :Ambassador to :Yushuah the :Messiah

D – :Wrong-doing: Roman -Church -Trespassing Upon The :Children -Of -Ysrael

:Roman -Church Fraud

:i- man declare that for the last four-hundred ~400~ years or more that the annihilation with the :murders upon the House of Judah of :Ysrael unto the abject enslavement onto the American-continent, et al.- "Egypt"²⁶ is commonly known and well documented within the records of the decisions with the violations of the fiduciary -duty and obligation by the :non- Christian -rulers of the Roman -Church -:military -:church -regime until now. See: Magna Carta²⁷. – :Thereto, that :fraud vitiates, a) the equation of the fraud is fraud in :fact from the beginning, and, b) Where as, the Roman- Church is established in fraud as an impostor then the any :Roman -Church- :papal- infallibility is merely impossible.

E – Faux- Nobility of :Esau²⁸ with :Saul²⁹, et al.- Roman -Church Identity Theft

:i- man know and believe that as :Nothing is new under the sun, so again was Satan's use of the :pagen-rulers of :Rome akin to :King Herod's oppression directly upon the infant -:Yushuah, and unto Rome's, et al's, callous deeds surrounding the immoral :sacrifice of the adult -:Yushuah~ the :lamb of the Most-High-God~; so now-again after nearly :two-thousand~2000~ years ought the Roman -Church, et al., choose life through the :repentance, changing and turning afforded to :all and them by the Messiah -:Yushuah~ Jesus-the-Christ – Almighty-God~, the :lamb of the Most-High-God.

:i- man believe that the faux- nobility amalgam of Saul with Esau, et al.- Roman -Church -:military- :church -regime -:lineage has for many centuries opportunistically and tyrannically promoted :itself to the world with the deception that either bloodline is a) in the line of the succession of the children of Jacob/Ysrael, or, that b) :either has acted in the righteous -keeping of the commandments of the Almighty-God before the billions of :soul- witnesses sojourning on Almighty-God's Earth.

F – Coveting Is Now Fraud

- a) :i- man believe that for the coveting of the office of :Jacob~Ysrael that the 'Roman -Church', et al., passes-itself -off/passed-itself -off to the world as the "Holy Church"³⁰ .;
- b) Both :Esau and :Saul remain complicit in the fraud and are historically unfit to lead the "Holy -Church" as a matter of :common - biblical- knowledge as adjudged by the Almighty-God;
- c) The :Roman -Church to day remains unrepentant of the fiduciary-violations with the aiding, abetting, and condoning the continued brutal enslavement- for-annihilation of the

26 "Egypt" means: KJV- Book: Deuteronomy- chap 28 v 64 -68.

27 :Magna Carta 1215, A.D. means: a) Magna Carta, 1215 A.D. by: b) the :King John I, :Concession of England To The Pope, 1213 A.D., "We wish it to be known to all of you, through this our charter, furnished with our seal, that inasmuch as we had offended in many ways God and our mother the holy church, and in consequence are known to have very, much needed the divine mercy, and can not offer anything worthy for making due satisfaction to God and to the church unless we humiliate ourselves and our kingdoms-we, wishing to humiliate ourselves for Him who humiliated Himself for us unto death, the grace of the Holy Spirit inspiring, not induced by force or compelled by fear, but of our own good and spontaneous will and by the common counsel of our barons, do offer and freely concede to God and His holy apostles Peter and Paul and to our mother the holy Roman church, and to our lord-pope Innocent and to his Catholic successors, the whole kingdom of England and the whole kingdom Ireland with all their right and appurtenances...." administered by c) the 'Crown Temple' in the receipt of the Crown In Chancery understanding common law.

:Esau means: KJV- Book: A) Genesis- chap.. 25 v 34; "... Esau despised his birthright."; B) Book: Romans 9:13 As it is written, Jacob have I loved, but Esau have I hated. ~ KJV- Book: Malachi- chap. 1 v 2 Was not Esau Jacob's brother? saith the LORD: yet I loved Jacob, 3 And I hated Esau, and laid his mountains and his heritage waste for the dragons of the wilderness. 4 Whereas Edom saith, We are impoverished, but we will return and build the desolate places; thus saith the LORD of hosts, They shall build, but I will throw down; and they shall call them, The border of wickedness, and, The people against whom the LORD hath indignation for ever." C) Book: Obadiah -chap 1.

:Saul means: KJV- Book: 1 Samuel- chap.. 15 v 22: "... to obey is better than sacrifice," – v 28: "..., The LORD hath rent the kingdom of Israel from thee [Saul] this day, and hath given it to a neighbour of thine, that is better than thou." – v 35 '... and the LORD repented that he had made Saul king over Israel."

:Holy Church means: A) KJV- Book: Acts- chap.. 1 v 4 And, being assembled together with them, commanded them that they should not depart from Jerusalem, but wait for the promise of the Father, which, saith he, ye have heard of me. 5 For John truly baptized with water; but ye shall be baptized with the Holy Ghost not many days hence. 6 When they therefore were come together, they asked of him, saying, Lord, wilt thou at this time restore again the kingdom to Israel? 7 And he said unto them, It is not for you to know the times or the seasons, which the Father hath put in his own power. 8 But ye shall receive power, after that the Holy Ghost is come upon you: and ye shall be witnesses unto me both in Jerusalem, and in all Judaea, and in Samaria, and unto the uttermost part of the earth. B) The 'Holy -Church' is the many-membered -body of :those -whosoever -will -believe -upon -the -Messiah -Yushuah, creator of the :heavens and Earth; He, who with leaving His Heavenly state, came to His Earth in the humble form of :man with humble beginnings, and who taught and demonstrated to the world the :Adam- man- kind by the will of His father: and, then-after He who died upon crucifixion for the sins of :man- kind, rose to life on the third-day, and now sits at the right-hand of :His -father -on -the -throne in :Heaven

MISC Page: 1675 of 2782
09/26/2022 03:35:37 PM Receipt # 22-9361
Darrin James Hill
Rec Fee: \$30.00 Parre Jo Bingham, Recorder
Gila County, Az, Sadie Jo Bingham

Declaration of :i- man - :Ambassador to :Yushuah the :Messiah

Negro-remnant of :Judah of the children of :Ysrael with plunder and violation and perversity.

G – Remedy

1) Order: Receivership of the Earth-planet

:i- man declare and now accept the :duty and obligation from the Almighty- God, et seq.³¹, as :i- man - :Adam - :Ambassador of the Almighty-God with all authority for the receipt, possession and complete accounting for the real and chattel property disposed in the devotion to :Yushuah ~Jesus the Messiah~ and onto Peter³², Paul³³ and the Holy Church.

2) Duty And Obligation To The Holy -Church

:Where, as the :'Roman -Church' is Not the 'Holy Church' -body-of-believers in the Most-High-God, nor keepers of the Word-of-God, so too neither is/ was Petros~ Peter~, one :apostle of :Yushuah the :Messiah, in any way a member of the Rome -Church - :military - :church -base, except with the deception by the Roman -Church, et al., fraud. - :Thereto,

:i- man declare and accept the duty and obligation to the Holy- Church of the Messiah- Yushuah~ Jesus for whom am :i- man- Adam - :Ambassador.

3) Duty and Obligation To The Houses -of -Israel and - :Judah, et al.

The 'Holy -Church' is the many-membered -body of :those -whosoever -will -believe upon the Messiah -Yushuah, creator of the :heavens and Earth; and, who with leaving His Heavenly state, came to His Earth in the humble form of :man with humble beginnings, and who taught and demonstrated to the world the :Adam- man- kind by the will of His father³⁴~ the Most High God~, and then-after who died upon crucifixion for the sins of :man- kind, rose to life on the third-day, and now sits at the right-hand of :His -father -on the -throne in :Heaven. - :Thereto,

:i- man declare and accept the duty and obligation to the House -of -Israel and House -of -Judah from whom am :i- man- Adam - :Ambassador of :Yushuah~Jesus ~the Messiah.

4) Duty and Obligation To The Tribe of Israel as Kinsman³⁵-redeemer³⁶ for the lost

31 from the Almighty- God, et seq. means: *ibid.* 27

32 :Peter means: KJV- Book: 2 Peter- chap. 1 v 1 Simon Peter, a servant and an apostle of Jesus Christ, to them that have obtained like precious faith with us through the righteousness of God and our Saviour Jesus Christ: 2 Grace and peace be multiplied unto you through the knowledge of God, and of Jesus our Lord, 3 According as his divine power hath given unto us all things that pertain unto life and godliness, through the knowledge of him that hath called us to glory and virtue: 4 Whereby are given unto us exceeding great and precious promises: that by these ye might be partakers of the divine nature, having escaped the corruption that is in the world through lust. 5 And beside this, giving all diligence, add to your faith virtue; and to virtue knowledge; 6 And to knowledge temperance; and to temperance patience; and to patience godliness; 7 And to godliness brotherly kindness; and to brotherly kindness charity. 8 For if these things be in you, and abound, they make you that ye shall neither be barren nor unfruitful in the knowledge of our Lord Jesus Christ. 9 But he that lacketh these things is blind, and cannot see afar off, and hath forgotten that he was purged from his old sins. 10 Wherefore the rather, brethren, give diligence to make your calling and election sure: for if ye do these things, ye shall never fall: 11 For so an entrance shall be ministered unto you abundantly into the everlasting kingdom of our Lord and Saviour Jesus Christ.

33 :Paul means: KJV- Book: A) Acts- chap. 17 v Act 17:22 Then Paul stood in the midst of Mars' hill, and said, Ye men of Athens I perceive that in all things ye are too superstitious. 23 For as I passed by, and beheld your devotions, I found an altar with this inscription, TO THE UNKNOWN GOD. Whom therefore ye ignorantly worship, him declare I unto you. 24 God that made the world and all things therein, seeing that he is Lord of heaven and earth, dwelleth not in temples made with hands; 25 Neither is worshipped with men's hands, as though he needed any thing, seeing he giveth to all life, and breath, and all things; 26 And hath made of one blood all nations of men for to dwell on all the face of the earth, and hath determined the times before appointed, and the bounds of their habitation; 27 That they should seek the Lord, if haply they might feel after him, and find him, though he be not far from every one of us: 28 For in him we live, and move, and have our being; as certain also of your own poets have said, For we are also his offspring. 29 Forasmuch then as we are the offspring of God, we ought not to think that the Godhead is like unto gold, or silver, or stone, graven by art and man's device. 30 And the times of this ignorance God winked at; but now commandeth all men every where to repent: 31 Because he hath appointed a day, in the which he will judge the world in righteousness by that man whom he hath ordained; whereof he hath given assurance unto all men, in that he hath raised him from the dead. B) Romans:- chap. 1 v Rom 1:1 Paul, a servant of Jesus Christ; called to be an apostle, separated unto the gospel of God, 2 (Which he had promised afore by his prophets in the holy scriptures,) 3 Concerning his Son Jesus Christ our Lord, which was made of the seed of David according to the flesh; 4 And declared to be the Son of God with power, according to the spirit of holiness, by the resurrection from the dead: 5 By whom we have received grace and apostleship, for obedience to the faith among all nations, for his name: 6 Among whom are ye also the called of Jesus Christ: 7 To all that be in Rome, beloved of God, called to be saints: Grace to you and peace from God our Father, and the Lord Jesus Christ.

34 :Adam- man- kind by the will of His father means: KJV- Book: Isaiah- chap. 58 – 61; Luke 4:

35 :Kinsman means: KJV- Book: Numbers- chap. 27 v 7 ... ye shall give his inheritance unto his kinsman that is next to him of his family, and he shall possess it: and it shall be unto the children of Israel a statute of judgment, as the LORD commanded Moses.

36 :Kinsman-redeemer means: KJV- Book: A) Exodus-- chap.. 6 v 2 And God spake unto Moses, and said unto him, I am the LORD: 3 And I appeared unto Abraham, unto Isaac, and unto Jacob, by the name of God Almighty, but by my name JEHOVAH

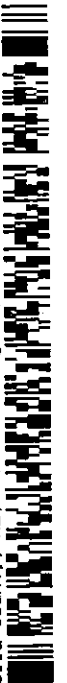

Declaration of :- man - :Ambassador to :Yushuah the :Messiah

-Tribes -of -Ysrael. :Thereto, :- man declare and accept the duty and obligation to/ for the lost -Tribes -of -Ysrael for whom am :- man- Adam -Ambassador- brother -kinsman- redeemer.

5) Accounting Demand

A full-accounting of all right and property -real, chattel, and account to the penny is immediately -required, now.

Sincerely,
Without Prejudice

Darrell James Hill
:Darrell-James: Hill,
-:Executor, -:Ambassador

Affirmed and autographed before me this 24 day: July 2020 A.D.

Type of Identification: Arizona Driver License

[Signature]
Notary Public

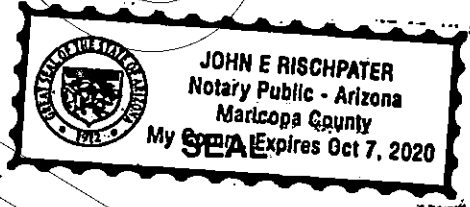

was I not known to them. 4 And I have also established my covenant with them, to give them the land of Canaan, the land of their pilgrimage, wherein they were strangers. 5 And I have also heard the groaning of the children of Israel, whom the Egyptians keep in bondage; and I have remembered my covenant. 6 Wherefore say unto the children of Israel, I am the LORD, and I will bring you out from under the burdens of the Egyptians, and I will rid you out of their bondage, and I will redeem you with a stretched out arm, and with great judgments: 7 And I will take you to me for a people, and I will be to you a God: and ye shall know that I am the LORD your God, which bringeth you out from under the burdens of the Egyptians. 8) Psalms- chap. 19 v 7 The law of the LORD is perfect, converting the soul: the testimony of the LORD is sure, making wise the simple. 8 The statutes of the LORD are right, rejoicing the heart: the commandment of the LORD is pure, enlightening the eyes. 9 The fear of the LORD is clean, enduring for ever: the judgments of the LORD are true and righteous altogether. 10 More to be desired are they than gold, yea, than much fine gold: sweeter also than honey and the honeycomb. 11 Moreover by them is thy servant warned; and in keeping of them there is great reward. 12 Who can understand his errors? cleanse thou me from secret faults. 13 Keep back thy servant also from presumptuous sins; let them not have dominion over me: then shall I be upright, and I shall be innocent from the great transgression. 14 Let the words of my mouth, and the meditation of my heart, be acceptable in thy sight, O LORD, my strength, and my redeemer.

2022-011769 MISC Page: 1677 of 2782
09/26/2022 03:35:37 PM Receipt # 22-9381
Rec Fee: \$30.00 Darrell James Hill
Gila County, Az, Sadie Jo Bingham, Recorder

Official

Registered No. RE322387576US

Date Stamp

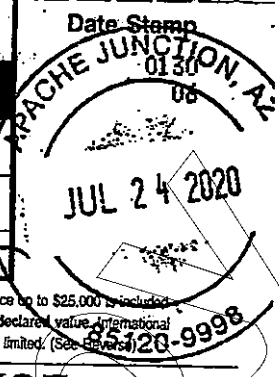

APACHE JUNCTION
151 W SUPERSTITION BLVD
APACHE JUNCTION, AZ 85120-9998
030259-0130
(800)275-8777
07/24/2020 02:46 PM

Reg. Fee	\$2.24	
Handling Charge	\$16.00	Return Receipt
Postage	\$4.15	Restricted Delivery
	\$0.00	
Received by	\$0.00	
		\$22.39

To Be Completed By Post Office

Customer Must Declare Full Value \$0.00 Domestic Insurance up to \$25,000 is included on the declared value. International Indemnity is limited. (See Form 3800-9998)

OFFICIAL USE

Product	Qty	Unit Price	Price
First-Class Intl Letter	1	\$2.24	\$2.24
International Vatican City			
Weight: 0 Lb 1.90 Oz			
Registered			\$16.00
Amount: \$0.00			
USPS Registered Mail # RE322387576US			
Return Receipt			\$4.15
Total:			\$22.39

To Be Completed By Customer (Please Print) All Entries Must Be in Ballpoint or Typed

FROM: Apache Junction, AZ 85120
Dartell - Lanza, Bill, Hernandez
PO Box 3806
Apache Junction, Arizona 85117

TO: Jorge - Mario, Bergoglio
Apostolic Palace
00120 Vatican City

PS Form 3806, Receipt for Registered Mail Copy 1 - Customer
May 2007 (7530-02-000-9051)
For domestic delivery information, visit our website at www.usps.com®

Cash Change \$50.00 (\$27.61)

Due to limited transportation availability as a result of nationwide COVID-19 impacts package delivery times may be extended. Priority Mail Express® service will not change.

In a hurry? Self-service kiosks offer quick and easy check-out. Any Retail Associate can show you how.

Save this receipt as evidence of information on filing claim go to

2022-011769 MISC Page: 1678 of 2782
09/26/2022 03:35:37 PM Receipt #: 22-9381
Rec Fee: \$30.00 Darrell James Hill
Gila County, AZ, Sadie Jo Bingham, Recorder



Completed by the office of origin. (A remplir par le bureau d'origine.)	Item Description (Nature de l'envoi)	Registered Article (Envoi recommandé)	Letter (Lettre)	Printed Matter (Imprimé)	Other (Autre)	Recorded Delivery (Envoi à livraison attestée)	Express Mail International	
	Insured Parcel (Colis avec valeur déclarée)	Insured Value (Valeur déclarée)	Article Number	RE 322 387 576 US				
Completed at destination. (A compléter à destination.)	Office of Mailing (Bureau de dépôt)	APACHE JCT AZ					Date of Posting (Date de dépôt)	07-24-2020
	Addressee Name or Firm (Nom ou raison sociale du destinataire)	JORGE - MARIO BERGOGLIO						
	Street and No. (Rue et No.)	APOSTOLIC PALACE						
	Place and Country (Localité et pays)	00120 VATICAN CITY						
This receipt must be signed by: (1) the addressee; or, (2) a person authorized to sign under the regulations of the country of destination, or, (3) those regulations so provide, by the employee of the office of destination. This signed form will be returned to the sender by the first mail. (Cet avis doit être signé par le destinataire ou par une personne y autorisée en vertu des règlements du pays de destination, ou, si ces règlements le comportent, par l'agent du bureau de destination, et renvoyé par le premier courrier directement à l'expéditeur.)							Postmark of the office of destination (Timbre du bureau de destination)	
The article mentioned above was duly delivered. (L'envoi mentionné ci-dessus a été dûment livré.)						Date		
Signature of Addressee (Signature du destinataire)				Office of Destination Employee Signature (Signature de l'agent du bureau de destination)				

PS Form 2865, February 1997 (Reverse)

929
930
931
932
933
934
935
936
937

COPY
ATTACHMENT C:

Property-Claimed; Property- Claim 1, Claim 2, Claim 3.

938
939
940
941
942

:Deprivation Contract-Agreement for :Property-Claimed means:

- A) pp.109-127: Political Election, et al., with: 'Penalty For Violations' - pp. 124-5;
- B) pp.149-152 , with: 'A' to: Barak-Hussein: Obama: USPS RMN RE 322 398 208 US; sent: September 9th, 2016 A.D.; delivered: September 27th, 2016 A.D.; and,
- C) pp.166- 169 with: 'A' to: Loretta: Lynch: USPS RMN RE 322 399 282 US; sent: October 25th, 2016 A.D.; delivered: October 31st, 2016 A.D. -
- D) See: re: pp. 561-584: Cease and Desist to :Loretta: Lynch: USPS RMN RB 898 810 007 US; sent: November 16th, 2016; delivered: November 25th, 2016
- E) et seq.:

:Property-Claimed Lot #1/3 means: USPS RMN 322 399 279 US; sent: October 25th, 2016 A.D.; delivered: October 31, 2016 A.D. See: Gila county, Arizona state, Recorder Doc.# 2017-002378, pp. 241-549.

:Property-Claimed Lot #2/3 means: Gila county, Arizona state, Recorder Doc.# 201-009297, pp. 9- 333.

:Property-Claimed Lot #3/3 means: Gila county, Arizona state, Recorder Doc.# 201-009297, pp. 373-737.

943
944
945
946
947
948
949
950



951
952
953
954
955
956
957
958
959

960
961
962
963
964
965

ATTACHMENT D:

Bill of Particulars for Property-Claimed-
Deprivation- contract- agreement:
Property- Claim 1, Claim 2, Claim 3.

:Deprivation Contract-Agreement for :Property-Claimed means:

A) pp.109-127: Political Election, et al., with: 'Penalty For Violations' - pp. 124-5;

B) pp.149-152 , with: 'A)' to: Barak-Hussein: Obama: USPS RMN RE 322 398 208 US; sent: September 9th, 2016 A.D.; delivered: September 27th, 2016 A.D.; and,

C) pp.166- 169 with: 'A)' to: Loretta: Lynch: USPS RMN RE 322 399 282 US; sent: October 25th, 2016 A.D.; delivered: October 31st, 2016 A.D.

D) See: re: pp. 561-584: Cease and Desist to :Loretta: Lynch: USPS RMN RB 898 810 007 US; sent: November 16th, 2016; delivered: November 25th, 2016

E) et seq.:

Lot #1/3 means: USPS RMN 322 398 208 US; delivered: September 27th, 2016 A.D. See: Gila county, Arizona state, Recorder Doc.# 2017-002378-

Lot #2/3 means: Gila county, Arizona state, Recorder Doc.# 201-009297, pp. 10-11.

Lot #3/3 means: Gila county, Arizona state, Recorder Doc.# 201-009297, p. 375.

966
967

2022-011769 MISC Page: 1680 of 2782
09/26/2022 03:35:37 PM Receipt #: 22-9381
Rec Fee: \$30.00 Darrell James Hill
Gila County, Az, Sadie Jo Bingham, Recorder



ntment: USPS RMN RE 322 387 562 US
alienable-Rights-From-God-Almighty -:Covenant 28 / 62

968
969
970
971
972
973
974
975

976

ATTACHMENT E:

Ref.	<u>Document History: EBA-1933-A.D. Trust</u>	item
G12-3)	Date requested: Account-reports, settle-and-closure of :EBA-1933-2003-A.D. -Trust – Equity-claim :Presentment: Express Trust: Emergency-Banking-Act of 1933 A.D. - Trust USPS RMN RE 047 610 440 US -: May 15TH, 2020 A.D. to: Donald-John... :Steve-Turner....	1
A15	Request for Arizona state Sheriffs to protect :i- man who chose to close the EBA-1933-2003-A.D. Sent with Item 1 appended.	2
B5, fn153	Gila county, Arizona state, Recorder Doc.# 201-009297, -:cover-sheet of correspondence unto Notarial Dishonor, pp. 824-832+	3
C26	See: Gila county, Arizona state, Recorder Doc.# 201-009297 cover-sheet, pp. 1-8; and 'Notice and Demand, August 23 rd , 2017 A.D., pp. 353-372.	4

977



Equity-Claim :Presentment: USPS RE 047 610 440 US -:May 15th. 2020 A.D

:Darrell-James: Hill, -:civilian, -:Executog¹
c/o PO Box 3806, Apache Junction, Arizona 85117.

:man -:present

Darrell James Hill, Executor

:The united States of America,

Arizona state
Pinal county

Equity-Claim :Presentment: Express Trust:
Emergency Banking Act of 1933 A.D. - Trust²,
USPS RE 047 610 440 US -:May 15th, 2020 A.D., to:

Donald-John :Trump, as :Trustee³,
:POTUSA - :Commander-In-Chief- Trustee- :Trump⁴ and
:POTUS -:TRUSTEE -:Trump⁵
:Steve-Turner: Mnuchin :USPS CMN 7008 1300 0002 2256 4705
:US-SOT⁶ :Mnuchin, -:Trustee - Minister⁷,

- 1 **:Darrell-James: Hill means: :Darrell-James: Hill means: Darrell-James: Hill ©1958; Ohioan, © 1958:**
State of Ohio: beneficiary. See: Gila county Arizona: Doc. # 2017-002378: pp. 6-24, 89-91,93-95 of
693. Gila county Arizona: Doc. # 2018-005176: pp. 10-21; and, et seq. See: :-I- man -file of:
Specialized Negotiable Instruments to the :man -:Barak-Hussein: Obama, :Donald-John:
Trump, et al., et seq.
- 2 **:Emergency Banking Act of 1933, et al. means: Public Law 73-1/ Statutes at Large 48 Stat. 1, et al. -**
Trading With The Enemy Act, amended -Subdivision (b) of section 5 of the Act of October 6, 1917 ...
to read as follows: During time of war or during any other period of national emergency declared by the
President... President may require any person within the United States... engaged in any
transaction...be fined... imprisoned..., or both... Cf. Trading with the Enemy Act of 1917, Pub.L. 65-91,
40 Stat. 411.
- 3 **:Trustee means: 1) one to whom an estate has been conveyed in trust; trust means: TRUST;**
contracts, devises. An equitable right, title or interest in property, real or personal, distinct from its legal
ownership; or it is a personal obligation for paying, delivering or performing anything, where the person
trusting has no real. right or security, for by, that act he confides altogether to the faithfulness of those
intrusted. This is its most general meaning, and includes deposits, bailments, and the like. In its more-
technical sense, it may be defined to be an obligation upon a person, arising out of a confidence
reposed in him, to apply property faithfully, and according to such confidence. Willis on Trustees, 1; 4
Kent, Com. 295; 2 Fonb. Eq. 1; 1 Saund. Uses and Tr. 6; Coop. Eq. Pl. Introd. 27; 3 Bl. Com. 431. 2)
for the Emergency Banking Act of 1933, et al., et seq., 'EBA-1933-A.D.'
- 4 **:POTUSA -Commander-In-Chief Trump means: President of The United States of America**
-unincorporated-, - Commander-in-Chief, under the :Lieber Code - :24th day, April, the year of our
Lord 1863 A.D.
- 5 **:POTUS Trump means: President of the UNITED STATES incorporated- :government-services-**
provider -:Trustee.
- 6 **:US-SOT means: UNITED STATES - Secretary of Treasury; U.S.-IMF liaison.**
- 7 **:minister means: one who acts under -upon the authority of another; e.g., :man- :ambassador of the**

:Claim- :Right for us of :Property-held-without-right in: Dry-Trust: EBA-1933 A.D - 2003 A.D.-
Presentment: USPS RE 047 610 440 US May 18, 2020 1 / 9

2022-011769 MISC Page: 1682 of 2782
09/26/2022 03:35:37 PM Receipt #: 22-9381
Rec Fee: \$30.00 Darrell James Hill
Gila County, Az, Sadie Jo Bingham, Recorder



Equity-Claim :Presentment: USPS RE 047 610 440 US -:May 15th, 2020 A.D

:William-Pelham: Barr, :USPS RE 047 610 438 US

**:US-AG⁸ - :Trustee -:Common-Law-Trustee - Minister- :Barr and
:US-APC⁹, -:Trustee- Minister- :Barr,**

:Jefferson-Beauregard: Sessions III, as :Trustee - Minister, :Ex-US-AG- :Sessions,

:Matthew-George: Whitaker, as :Trustee - Minister, :Ex-US-AG: Acting- :Whitaker,

:Dana-James, Boente, as :Trustee - Minister, :Ex-US-AG- Acting- :Boente,

:Sally-Caroline, Yates, as :Trustee - Minister, :Ex-US-AG- Acting- :Yates,

c/o :Donald-John: Trump¹⁰ :USPS RE 047 610 440 US

1600 Pennsylvania Ave NW

Washington, District of Columbia 20500

**re: The 'Emergency Banking Act of 1933 A.D.' - 2003 A.D., 'EBA-1933-A.D.' is
:completed-of-purpose and :extinct, then is the 'dry-trust' and ought-to-have-been
dissolved and conveyed to :i-man -:beneficiary and priority-creditor¹¹.**

Greetings :Donald-John, :William-Pelham, :Steve-Turner, et al. man:

**:i- man¹² hope :you are safe with :righteous- guidance and acts. This :document
is for the settle-and-close¹³ of the :1933 A.D. -trust from the Franklin-Delano, :POTUS-
POTUSA -:Roosevelt's :1933 A.D. -:New-Deal unto The united States of America -
people, et seq. - :i-man -affiant.**

A) :Affiant is :man- Darrell-James: Hill, -:civilian, -:Executor¹⁴.

Most-High-God: e.g., Enoch, Yushuah (Jesus-the-Christ), Peter, Paul.

8 :US-AG means: UNITED STATES Attorney General

**9 :APC means: Alien-Property-Custodian means: the duty and obligation to take charge of the
property of alien enemies; e.g., the :common law trustee- minister for the EBA-1933-A.D., et al.-
:TWEA of 1917 A.D., as amended, by the authority of the POTUS under Law.**

**10 :Donald-John: Trump means: the :man -:trustee under the duty, obligation and moral-Oath of Office:
20th day of January, the year our Lord 2020 A.D.~, ministry: 1) as :President of The United States of
America ~unincorporated, 1776 A.D.~- - Commander-in-Chief. And, with the :General Order 100
~Lieber Code~ :24th day, April, the year of our Lord 1863 A.D. by :Constitution for the United States of
America Law, as 2) the President of the UNITED STATES incorporated- :government-services-
provider- :Trustee: by: U.S. Constitution policy and martial law, the 87th year of the United States.**

11 :Priority-Creditor means: one to whom compensation is made before any other debt is paid

**12 :i- man means: 'i' refers to :Almighty-God as the great 'i- am'. And: 'i- man/' :i-man' acknowledges
that the Almighty-God -created the ':man' is present.**

**13 :settle and close of all accounts means: TO #1: restore :all :gold, silver, chattel by: (A) from the Total
assets of :all :accounts of :i-man-beneficiary (B) now pay-off the Total :public- debt -account- obligation
for :i- man; now, then (C) merge the two accounts into a (D) new :private-revocable-trust for :i- man,
and (D) continue the status of :investment. Now, (E) Set-up an :L.L.C-type - account for to receive
:payment- proceeds for the non-commercial- :cestui-que-use from (D) the: 'new: :private-revocable-
trust for :i- man' without prejudice; and: #2: restore all lands to :i- man, et seq. in :allodium.**

14 :ibid 1.

**:Claim - :Right for us of :Property-held-without-right in: Dry-Trust: EBA-1933 A.D - 2003 A.D.-
Presentment: USPS RE 047 610 440 US May 18, 2020 2 / 9**

2022-011769 MISC Page: 1683 of 2782

09/26/2022 03:35:37 PM Receipt #: 22-9381

Rec Fee: \$30.00 Darrell James Hill

Gila County, Az, Sadie Jo Bingham, Recorder



1. :i- man, :beneficiary¹⁵ -by-:birth¹⁶ of the inherent -trust¹⁷ from :Almighty God¹⁸~ where nothing stands between :Almighty-God and :i- man ~ am: (1) :Executor- Darrell-James: Hill © 1958 A.D., :Ohioan¹⁹, in the fullness of age, and of :sound- mind; (2) by :birth :Negro²⁰ -:beneficiary of the :Emancipation- Proclamation -1863²¹, and forever-guaranteed -:protection by the Army, et al., by the full- force and authority of The Constitution for the United States of America ~ 1789-1791~²²; and: (3) :beneficiary of the ':United-States-of-America,-Incorporated' -:government²³ -services-provider-Trustee's :self-indenture²⁴ to :i-man: with the debenture²⁵ ²⁶ created in the 'idem-sonans²⁷ -:subrogation²⁸ entitled: DARRELL JAMES HILL~ & et al. derivatives~ © 1958

15 :beneficiary means: one onto whom a :trust-benefit is demonstrated by the execution-by the :Executor of the beneficiary's use of the trust- property.

16 :birthed :son of :Clarence, :son of :James, :son ':Negroland, :Kingdom-of-Judah, :Africa', ...:son :Ysrael- :Southern-Kingdom ~ of the sons :Judah and Benjamin and Levi, et al.-, ...:son of :Jacob and :Ysrael, :son of :Isaac, :son of :Abram and :Abraham, ...:son of :Shem, :son of :Noah, ...:son of :Methuselah, :son of :Enoch, ...:son of :Seth, :son of :Adam with :Eve of the garden of :Eden ~ including all :known and unknown :ancestral- lands ~ on the earth placed under the Adamic- lineage and under the :only-begotten -son of the Most-High-God and Father embodied within the rebirth by :i-man of the power of :Yushuah-Messiah, -:God, with the redemption by the Messiah- Yushuah (:Jesus-the-Christ), and encompassing the :receivership, responsibility and administration over :all of the earth-planet as :heir - :remainderman, and :Kinsman- :redeemer of the Earth, both from the Adamic-lineage by the :loss in :spirit in the man upon the Earth, and by the Messiah-Yushuah by the restoration in :spirit in the man upon the Earth: on, in or under-the-surface of the planet; :on, in or under-the-surface of the oceans and waters, and :on, in, under-the-surface of the atmosphere/ above the atmosphere of the Earth to wherever the :Adamic- :man -kind in the quantum and in the spirit is, of :where the :purposes of the Most High God and Father are immeasurable by mere :man.

17 inherent -trust means: that trust is given by the Creator- :Almighty-God -grantor to :i-man-kind -:beneficiary as the steward of the realm; e.g., :gravity, water, air, land, and man- beneficiary.

18 :Almighty God means: a) the :Creator of the worlds: embodied as :Yushuah the Messiah ~a.k.a. Jesus the Christ~ the only begotten son of the Most High God, b) He who for our sake for our redemption did ly down His glory, birthed as man-kind onto our earth-planet, fulfilled all of the word, Law and prophesy, then layed-down his :life, giving his life for to atone for our sins so that :man- kind -whosoever-will may become like Him, in the fullness of that stature, sons of the Most-High-God.

19 See: Record of live Birth means: Authentication ~:Birth No 134 - 58 -208851, Certified Doc.# F4012640,:State Registrar - Judith-B.: Nagy, May -9, 2018.; and: (2) OHIO- SOS -certification: C074912, :Jon: Husted, June 14, 2018; and: (3) The United States of America- SOS- Authentication No. 18047749-2, :Michael -R: Pompeo, July 17, 2018 ~ :Debenture; appended: 3 pages.

20 Ibid 16.

21 Emancipation Proclamation of 1863 means: Proclamation 95 from POTUSA Abraham Lincoln on September 22nd, 1862: effective :January 1st, 1863.

EMANCIPATION. An act by which a person, who was once in the power of another, is rendered free. By the laws of Louisiana, minors may be emancipated. Emancipation is express or implied.

2. Express emancipation. The minor may be emancipated by his father, or, if he has no father, by his mother, under certain restrictions. This emancipation takes place by the declaration, to that effect, of the father or mother, before a notary public, in the presence of two witnesses. The orphan minor may, likewise, be emancipated by the judge, but not before he has arrived at the full age of eighteen years, if the family meeting, called to that effect, be of opinion that he is able to administer his property. The minor may be emancipated against the will of his father and mother, when they ill treat him excessively, refuse him support, or give him corrupt example.

22 The Constitution for the United States of America ~ 1789-1791~ means: The :original - organic -constitution and includes the 'Bill of Rights', et al.

23 ':United-States-corporation' -:government means: 'United-States-of -America- -:corporation'

:Claim - :Right for us of :Property-held-without-right in: Dry-Trust: EBA-1933 A.D - 2003 A.D.- Presentment: USPS RE 047 610 440 US May 18, 2020 3 / 9



A.D., :State-of-Ohio²⁹ by the 'Emergency Banking Act of 1933, et al.', 'EBA-1933-A.D.'
-Trust (ended :2003 A.D.);

2. :i- man am :member of the non-political -aggregate³⁰;

3. :i- man am the literate, legalese-idiot -non-member of the :B.A.R.- legal -society.

:i man am the :Christian -Ambassador³¹ of the Almighty-God

4. :Almighty-God, -Yushuah -the -Messiah (aka: Jesus-the-Christ) who prophetically came to this planet, was birthed -:man, healed :man-kind, died for :man-kind, did resurrect, and now sits at the right-hand of his Father, the :Most-High-God, in Heaven; :i- man am a :disciple of that Messiah Yushuah's teaching and spiritual guidance. :There to,

-:government -services -provider -Trustee: status post :1862 A.D., e.g., (1) cf :2020: Donald-John: POTUS Trump- Trustee/ EBA-1933-A.D. :CIC acting under U.S. Constitution - incorporated, and (2) cf. :Donald-John: POTUSA Trump. :CIC understanding The Constitution for the United States of America - unincorporated.

24 **:indenture means: INDENTURE**, conveyancing. An instrument of writing containing a conveyance or contract between two or more persons, e.g., as between the 'UNITED STATES-CORPORATION' and 'The United States of America, unincorporated, i.e., the people of the non-political- aggregate.

25 **:debenture means: DEBENTURE**. A certificate given, in pursuance of law, by the collector of a port of entry, for a certain sum, due by the United States, payable at a time therein mentioned, to an importer for drawback of duties on merchandise imported and exported by him, provided the duties arising on the importation of the said merchandise shall have been discharged prior to the time aforesaid. Vide Act of Congress of March 2, 1799, s. 80; Encyclopdie, h. t.; Dane's Ab. Index, h. t.

26 **Ibid 19; 'Birth-day' means:** the 20th day, November, year of our Lord 1958 A.D. at 11:35 a.m. **Birth.** The act of being wholly brought into the world. The whole body must be detached from that of the mother, in order to make the birth complete. 5 C. & P. 329; S. C. 24 E. C. L. R. 344 6 C. & P. 349; S. C. 25 E. C. L. R. 433.

day. A division of time. It is natural, and then it consists of twenty-four hours, or the space of time which elapses while the earth makes a complete revolution on its axis; or artificial, which contains the time, from the rising until the setting of the sun, and a short time before rising and after setting. Vide Night; and Co. Lit. 135, a.

2. Days are sometimes calculated exclusively, as when an act required that an appeal should be made within twenty days after a decision. 3 Penna. 200; 3 B. & A. 581; 15 Serg. & Rawle, 43. In general, if a thing is to be done within such a time after such a fact, the day of the fact shall be taken inclusively. Hob. 139; Doug. 463; 3 T. R. 623; Com. Dig. Temps, A; 3 East, 407.

3. The law, generally, rejects fractions of days, but in some cases it takes notice of such parts. 2 B. & A. 586. Vide Date.

27 **Idem-sonans means: IDEM SONANS**. Sounding the same.

2. In pleadings, when a name which it is material to state, is wrongly spelled, yet if it be idem sonans with that proved, it is sufficient, as Segrave for Seagrave, 2 Str. R. 889; Keen for Keene, Thach. Cr. Cas. 67; Deadema for Diadema, 2 Ired. 346; Hutson for Hudson, 7 Miss. R. 142; Coonrad for Conrad, 8 Miss. R. 291. See 5 Pike, 72; 6 Ala. R. 679; vide also Russ. & Ry. 412; 2 Taunt. R. 401, In the following cases the variances there mentioned were declared to be fatal. Russ. & Ry. 351; 10 East, R. 83; 5 Taunt. R. 14; 1 Baldw. R. 83; 2 Crom. & M. 189; 6 Price, R. 2; 1 Chit. R. 659; 13 E. C. L. R. 194. See, generally, 8 Chit. Pr. 231, 2; 4 T. R. 611; 3 B. & P. 559; 1 Stark. R. 47; 2 Stark. R. 29; 3 Camp. R. 29; 6 M. & S. 45; 2 N. H. Rep. 557; 7 S. & R. 479; 3 Caines, 219; 1 Wash. C. C. R. 285; 4 Cowen, 148 and the article Name.

28 **Subrogation means: SUBROGATION**, civil law, contracts. The act of putting by a transfer, a person in the place of another, or a thing in the place of another thing. It is the substitution (q. v.) of a new for an old creditor, and the succession to his rights, which is called subrogation; transfusio unius creditoris in alium. It is precisely the reverse of delegation. (q. v.)

2. There are three kinds of subrogation: 1. That made by the owner of a thing of his own free will; example, when he voluntarily assigns it. 2. That which arises in consequence of the law, even without

:Claim - :Right for us of :Property-held-without-right in: Dry-Trust: EBA-1933 A.D - 2003 A.D.- Presentment: USPS RE 047 610 440 US May 18, 2020 4 / 9

2022-011769 MISC Page: 1685 of 2782

09/26/2022 03:35:37 PM Receipt #: 22-9381

Rec Fee: \$30.00 Darrell James Hill

Gila County, Az, Sadie Jo Bingham, Recorder



5. :i- man am my brother's keeper as the :ambassador of the :Almighty-God, and openly-accept herenow the duty as the :kinsman- redeemer³² for the unknown -creditors to the :extinct- 'EBA-1933-A.D.' -:completed-trust -contract, aka 'dry-trust'³³, and, as such, for: a) the :tribes of :Ysrael, and: b) for the people understanding the :Almighty-God.

:Declaration of the Beneficiary & :Priority-Creditor of the EBA-1933-A.D. -:dry-trust

6. :i- man -:Darrell-James: Hill, :Executor declare³⁴ that :i- man am: (a) :beneficiary -:remainderman³⁵ and :priority-creditor in the remedial :equitable- right³⁶ and ownership of the principal and proceeds from the extinct 'EBA-1933-A.D.' -contract according to

the consent of the owner; example, when a man pays a debt which could not be properly called his own, but which nevertheless it was his interest to pay, or which he might have been compelled to pay for another, the law subrogates him to all the rights of the creditor. Vide 2 Binn. Rep. 382; White's L. C. in Eq.* 60-72. 3. That which arises by the act of law joined to the act of the debtor; as, when the debtor borrows money expressly to pay off his debt, and with the intention of substituting the lender in the place of the old creditor. 7 Toull. liv. 3, t. 3, c. 5, sect. 1, §2. Vide Civ. Code of Louisiana, art. 2155 to 2158; Merl. Repert. h. t.; Dig. lib. 20; Code, lib. 8, t. 18 et 19 9 Watts. R. 451; 6 Watts & Serg. 190; 2 Bouv. Inst. n. 1413.

29 **ibid 19; 'berth-date' means:** the 28th day, November, year of our Lord 1958 A.D., in the 244th year of the United States.

Berth: (v.) 1660s, of ships, from berth (n.). Of persons (intransitive), from 1886. Related: Berthed; berthing.

berth (n.) 1620s, "convenient sea room" (both for ships and sailors), of uncertain origin, probably from bear (v.) + abstract noun suffix -th (2) as in strength, health, etc. Original sense is preserved in phrase to give (something or someone) wide berth. Meaning "place on a ship to stow chests, room for sailors" is from 1706; extended to non-nautical situations by 1778.

Date. The designation or indication in an instrument of writing, of the time, and usually of the time and place, when and where it was made. When the place is mentioned in the date of a deed, the law intends, unless the contrary appears, that it was executed at the place of the date. Plowd. 7 b., 31 H. VI. This word is derived from the Latin datum, because when deeds and agreements were written in that language, immediately before the day, month and year in which they were made, was set down, it was usual to put the word datum, given.

2. All writings ought to bear a date, and in some it is indispensable in order to make them valid, as in policies of insurance; but the date in these instruments is not inserted in the body of the writing because as each subscription makes a separate contract, each underwriter sets down the day, month and year he makes his subscription. Marsh. Ins. 336.

3. Deeds, and other writings, when the date is an impossible one, take effect from the time of deliver; the presumption of law is, that the deed was dated on the day it bears date, unless, as just mentioned, the time is impossible; for example, the 32d day of January.

4. The proper way of dating, is to put the day, month, and year of our Lord; the hour need not be mentioned, unless specially required; an instance of which may be taken from the Pennsylvania Act of the 16th June, 1836, sect. 40, which requires the sheriff, on receiving a writ of fieri facias, or other writ of execution, to endorse thereon the day of the month, the year, and the hour of the day whereon he received the same.

5. In public documents, it is usual to give not only the day, the month, and the year of our Lord, but also the year of the United States, when issued by authority of the general government; or of the commonwealth, when issued under its authority. Vide, generally, Bac. Ab. Obligations, C; Com. Dig. Fait, B 3; Cruise, Dig. tit. 32, c. 20, s. 1-6; 1 Burr. 60; 2 Rol. Ab. 27, 1. 22; 13 Vin. Ab. 34; Dane's Ab. Index, h. t. See Almanac.

30 **:non-political -:over-standing -aggregate means:** the body of people from whom :government is derived; also, :non-actors/citizens in the daily administration of the government service.

31 **:Ambassador means:** **ibid 7.**

:Claim - :Right for us of :Property-held-without-right in: Dry-Trust: EBA-1933 A.D - 2003 A.D.- Presentment: USPS RE 047 610 440 US May 18, 2020 5 / 9

2022-011769 MISC Page: 1686 of 2782
09/26/2022 03:35:37 PM Receipt #: 22-9381
Rec Fee: \$30.00 Darrell James Hill
Gila County, Az, Sadie Jo Bingham, Recorder



Equity-Claim :Presentment: USPS RE 047 610 440 US -:May 15th, 2020 A.D

the Law; and: (b) the :kinsman-redeemer for all :unknown-creditors no-longer-desposed³⁷ as :surety³⁸ for the 'United-States-of-America,-incorporated'³⁹-government-services- :provider's -bankruptcy which was mitigated by the EBA-1933-A.D. -indenture, administered by the person: 'UNITED STATES Incorporated'-government-services- provider -:Trustee for the United-States-of-America,- Incorporated: 1933- A.D., et al., et seq. - :debenture to: The united States of America - people, et seq. - :i- man :Darrell-James ~ 1958 A.D.

B. :Trustee -:Trump is The Trustee To This :Presentment: USPS :RE 047 610 440 US, May 18th, 2020 A.D., For This Exercise Of The Right By :i- man With The Conveyance Of Assets To :i- man ByThe Emergency Banking Act Of 1933 A.D. under Law

7. :You are the Trustee of the extinct- 'EBA-1933-A.D.' -:completed-trust- principal which should ought-to have-been conveyed to :i-man, et al. in the year of our Lord: 2003 A.D.; and, now ought-be made so: post-haste, agreeably, and with :all -principal-property in :all- accounts, :chattel and land conveyed to a) :i- man- sole, and b) :i-man -kinsman-redeemer.

All Previous Notices To You Are Acquiesced By :you, et al.

8. :This is the second beneficiary request from :i- man to you, et al., for :trust-information for to settle-and-close the :accounts of the extinct- 'EBA-1933-A.D.' -dry-trust. All previous contacts are answered in the response of the :silent- acquiescence.

9. Ignoring :this -Trustee- duty and obligation for to release :all of the property belonging to :i- man is the :same- :wrong-doing as :abandonment of :your fiduciary-duty and oath-of-office to uphold: The Constitution for the United States of America, et al. -:Bill-of-Rights.

C. Remedy

10. :Where as the :Emergency Banking Act of 1933' -2003 A.D. is a :dry-trust

32 :Kinsman-redeemer means: a relative, male, who delivers a family member from bondage, or sin, or penalties who stands in the gap of the need for the family -unprotected: a relative who delivers a family member from bondage, or sin, or penalties.

33 :dry-trust means: the end/ extinction of the trust upon the completion of its duties by the consent and demand of :i- man, et al., beneficiary for the restoration of :all of the trust-property.

34 declare means: to make known explicitly and plainly by the full statement as being in one's possession or ownership.

35 :Remainderman means: heir, one who inherits; - a person who inherits or is entitled to inherit property upon the termination of the estate

36 remedial :equitable- right means: Remedy, exercise in the choice to attain the right of a contract of which one injured is agreed- by :Law, :entitled.

37 desposed means: government rule forced -upon :people whether by an overt-wrong or otherwise under the guise of a :remedy; despotism.

38 :surety means: contracts. One bound for the payment of a sum of money or for the performance of something else, for another, who is already bound for the same

39 'United-States-of-America,-incorporated' means: The government of the united States of America, fashioned under the auspices by the Executive Branch with the Lieber Code upon the American -Civil-War -Crisis: 1861 -A.D.

:Claim - :Right for us of :Property-held-without-right in: Dry-Trust: EBA-1933 A.D - 2003 A.D.- Presentment: USPS RE 047 610 440 US May 18, 2020 6 / 9

2022-011769 MISC Page: 1687 of 2782

09/26/2022 03:35:37 PM Receipt #: 22-9381

Rec Fee: \$30.00 Darrell James Hill

Gila County, Az, Sadie Jo Bingham, Recorder



-:indenture,

- a) administrating the :property without right is now :willful- wrong-doing;
- b) the :Full-Accounting to the penny is required/requested/demanded/ordered-; and:
- c) :You are required/requested/demanded/ordered to restore :all- property to :i-man- sole upon your receipt of the returned- debenture of the EBA-1933-A.D.- :dry-trust indenture for the settle and close of all accounts.

D. :i- man :Beneficiary And Priority-Creditor Now Herein Expressively Return To The Trustee- :Donald-John: Trump The :EBA-1933-A.D. --:Debenture Expressively Provided For To Settle-And-Close :All-Accounts, And Convey :All - Property To :i-man: Darrell-James Post-Haste.

:Authenticated -:Debenture to :Darrell-James: Hill

11. See the :Authenticated -:certified-debenture ~appended: 3 pages~ returned herein for the settle and close of :all- accounts in the extinct- 'EBA-1933-A.D.' -:dry-trust, for the restoration of :all property to :i- man post-haste.

:Declaration :Beneficiary& :Priority-Creditor: EBA-1933-A.D. -:dry-trust

12. :i- man -:Darrell-James: Hill, :Executor declare⁴⁰ comprehension now that :i-man am a) :beneficiary -:remainderman and :priority-creditor in the remedial :equitable-right⁴¹ and ownership of the principal and proceeds by/according to the Law by the extinction of the 'EBA-1933-A.D.' -:completed-trust, and b) the :kinsman-redeemer for :unknown-creditors no- longer desposed as :surety to the 'United-States-of-America,-incorporated'-government-services- provider's -bankruptcy mitigated by the EBA-1933-A.D.⁴² -contract with the :debenture to :The united States of America – people, -:beneficiary and priority-creditor, et seq. - :Darrell-James.

Require/request/ demand :all property upon return of the debenture

13. :i- man :Darrell-James -:beneficiary and priority-creditor to the extinct- 'EBA-1933-A.D.' -:completed-trust herein exercise the :right in :Law and equity to require/request/ demand the :trustee,et al. to assent, and to release :all property to :i-man upon the receipt of the debenture to the 'EBA-1933-A.D.' -contract. Notice to the primary Trustee is :notice to every minister; Notice upon the any minister must be expediently noticed to :Trustee, :POTUS-, :POTUSA- :Trump.

Require/Request/Demand/Order The Full-Accounting To :penny Of: Property

14. :i- man Require/ Request/ Demand /Order the :Full-Accounting to the penny for :all accounts for (1) :i- man for: all- property held nowtofore and now-after by the 'Emergency Banking Act of 1933' -:dry- trust.

Return Of All Principal-Property, :Settle And Close -All Accounts -:Property And Chattel

40 declare means: to make known explicitly and plainly by the full statement as being in one's possession or ownership.

41 remedial :equitable- right means: a right of a contractual remedy to which one injured is entitled

42 'United-States-of-America,-Incorporated- :1933' -:bankruptcy means: the : bankruptcy of the corporate-government 'mitigated' by the EBA-1933-A.D., et seq. by the :Primary-:Trust-Management-Organization - :Trustee for the United-States-of-America,-Incorporated: 1933- 2003- A.D. bankruptcy period: seventy years.

:Claim - :Right for us of :Property-held-without-right in: Dry-Trust: EBA-1933 A.D - 2003 A.D.- Presentment: USPS RE 047 610 440 US May 18, 2020 7 / 9



Equity-Claim :Presentment: USPS RE 047 610 440 US -:May 15th, 2020 A.D

15. :i- man :Darrell-James: Hill, :Executor, :priority- creditor and :known -:kinsman-redeemer now require/ request/demand for :you- :Trustee to make :order expressively that :all -principal⁴³ -propertyadministered in to the 'United-States-of-America,- Incorporated: 1933'- A.D. -bankruptcy ought- must- now be :settled and closed with :all -principal -property returned post-haste to: (1) :i- man :Darrell-James: Hill, -:Executor -:priority-creditor -:sole, and: (2) to :i-man :Darrell-James:Hill, -:Executor- :known -:kinsman-redeemer for :all unknown-priority-Creditors due the surety-assets in :total-remainder.

Enclosure: 1/1: Record of live Birth Authentication ~:Birth No 134 - 58 -208851, Certified Doc.# F4012640,:State Registrar - Judith-B.: Nagy, May -9, 2018.; and: (2) OHIO- SOS -certification: C074912, :Jon: Husted, June 14, 2018; and: (3) United States of America- SOS- Authentication No. 18047749-2, :Michael -R: Pompeo, July 17, 2018 ~ :Debenture: 3 pages.

cc: Army, et al. JCOS :USPS RE 047 610 512 US

:Mark-Alexander :General United States Army⁴⁴ -:Chairman: CJCOS⁴⁵- :Milley,
:John-Earl :General United States Air Force: Vice- CJCOS- :Hyten,
:James-Charles :General United States Army: COS⁴⁶ Army- :McConville,
:David-Hilberry :General United States Marine Corps: CMC⁴⁷- :Berger,
:Michael-Martin :Admir. al United States Navy: CNO⁴⁸ -:Gilday.,
:David-Lee :General United States air Force: COS AF⁴⁹- :Goldfein,
:John-William :General United States Space Force: CSO⁵⁰- :Raymond,
:Joseph-Lauren :General United States Air Force: CNG⁵¹- :Lengyel
:Karl-Leo :Admiral United States Coast Guard: CCG⁵²- :Schultz
c/o :Mark-Alexander:Milley, :USPS RE 047 610 512 US
Office: CJCOS
9999 Join Staff Pentagon
Washington, District of Columbia 20318-9999

:William-Pelham: Barr, :USPS RE 047 610 438 US
:US-AG - :Trustee - :Common-Law-Trustee - Minister- :Barr and
:US-APC, -:Trustee- Minister- :Barr,
950 Pennsylvania Avenue, N.W.

43 :all -principal -property means: Gold, silver, chattel, land, of the original confiscation in the open accounting.

44 :General United States means: General: 'The United States of America' Army

45 :CJCOS means: Chairman: Joint Chief Of Staff

46 :COS means: Chief of Staff

47 :CMC means: Commandant of the Marine Corps

48 :CNO means: Chief of Naval Operations

49 :COS AF means: Chief of Staff of the Air Force

50 :CSO means: Chief of Space Operations

51 :CNG means: Chief of the National Guard Bureau

52 :CCG means: Commandant of the Coast Guard

:Claim - :Right for us of :Property-held-without-right in: Dry-Trust: EBA-1933 A.D - 2003 A.D.- Presentment: USPS RE 047 610 440 US May 18, 2020 8 / 9

2022-011769 MISC Page: 1689 of 2782

09/26/2022 03:35:37 PM Receipt #: 22-9381

Rec Fee: \$30.00 Darrell James Hill

Gila County, Az, Sadie Jo Bingham, Recorder



Equity-Claim :Presentment: USPS RE 047 610 440 US -May 15th, 2020 A.D

Washington, District of Columbia 20530-0001

:Steve-Turner: Mnuchin, ~:USPS CMN 7008 1300 0002 2256 4705-
:US-SOT :Mnuchin, -:Trustee - Minister,
1500 Pennsylvania Avenue, NW
Washington, District of Columbia 20220

Notice to the primary Trustee is :notice to every minister; Notice upon the any minister
must be expediently noticed to :Trustee - :POTUS-, :POTUSA- Trump.

:i- man affirm all said above is true and correct, and will state same in the open court.

Without prejudice

Darrell-James Hill, Executor

:Darrell-James: Hill, :civilian -:Executor; -:Beneficiary and
:Kinsman-redeemer -:Priority-Creditor in the remedial
:equitable- right by the :Emergency Banking Act of
1933' -:dry-trust with 'United-States-of-America,-
Incorporated -:1933'- 2003 :bankruptcy.

Jurat

Affirmed and autographed before me this day 18 May, the year of our Lord 2020 A.D.
Type of Identification: Arizona Driver License.

Notary Public

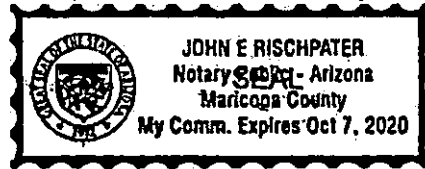

:Claim - :Right for us of :Property-held-without-right In: Dry-Trust: EBA-1933 A.D - 2003 A.D.-
Presentment: USPS RE 047 610 440 US May 18, 2020 9/9

2022-011769 MISC Page: 1690 of 2782
09/26/2022 03:35:37 PM Receipt #: 22-9381
Rec Fee: \$30.00 Darrell James Hill
Gila County, Az, Sadie Jo Bingham, Recorder



United States of America



DEPARTMENT OF STATE

To all to whom these presents shall come, Greetings:

I Certify That the document hereunto annexed is under the Seal of the Secretary of State of the State(s) of Ohio, and that such Seal(s) is/are entitled to full faith and credit.*

**For the contents of the annexed document, the Department assumes no responsibility
This certificate is not valid if it is removed or altered in any way whatsoever*

In testimony whereof, I, Michael R. Pompeo, Secretary of State, have hereunto caused the seal of the Department of State to be affixed and my name subscribed by the Assistant Authentication Officer, of the said Department, at the city of Washington, in the District of Columbia, this seventeenth day of July, 2018.

Michael R. Pompeo

Secretary of State

By *Pat O. Hunt*

Assistant Authentication Officer,
Department of State

*Issued pursuant to CHXN, State of
Sept. 15, 1789, 1 Stat. 68-69; 22
USC 2657; 22 USC 2651a; 5 USC
301; 28 USC 1733 et. seq.; 8 USC
1443(f); RULE 44 Federal Rules of
Civil Procedure.*

2022-011769 MISC Page: 1691 of 2782
09/26/2022 03:35:37 PM Receipt #: 22-9381
Rec Fee: \$30.00 Darrell James Hill
Gila County, Az, Sadie Jo Bingham, Recorder



United States of America
State of Ohio
Office of the Secretary of State

I, **JON HUSTED**, Secretary of State, do hereby certify that I am the duly elected, qualified and acting Secretary of State of the State of Ohio, and I further certify that **JUDITH B. NAGY**

is the duly appointed, State Registrar, Vital Statistics Division, Department of Health, for the State of Ohio. She is the custodian of the records of Vital Statistics, and that she is the proper official to make said attestation, which is in due form; and that her official acts are entitled to full faith and credit.

This certification certifies only the authenticity of the signature of the official who signed the document, the capacity in which that official acted, and where appropriate, the identity of the seal or stamp, which the document bears. This certification does not imply that the contents of the document(s) are correct, nor that they have the approval of this office.

IN TESTIMONY WHEREOF, I have hereunto subscribed my name and affixed the official Seal of the Secretary of State of Ohio, at Columbus, Ohio, this 14th day of June, 2018.

Jon Husted
Jon Husted
Secretary of State

SEC4000 (Rev. 1/11)

C074912



OHIO DEPARTMENT OF HEALTH
DIVISION OF VITAL STATISTICS
CERTIFICATE OF LIVE BIRTH

Registrar's No. **9370**
Birth No. **184-58-208851**

Reg. Dist. No. **7701**
Primary Reg. Dist. No. **7701**

MARGIN RESERVED FOR BINDING

1. PLACE OF BIRTH a. COUNTY Summit		2. USUAL RESIDENCE OF MOTHER (Where does mother live?) a. STATE Ohio	
b. CITY, VILLAGE, OR LOCATION Akron		b. COUNTY Summit	
c. NAME OF HOSPITAL OR INSTITUTION (If not in hospital or institution, give street address) Akron City Hospital		d. STREET ADDRESS Akron 3	
e. IS PLACE OF BIRTH INSIDE CITY LIMITS? YES <input checked="" type="checkbox"/> NO <input type="checkbox"/>		e. IS RESIDENCE INSIDE CITY LIMITS? YES <input checked="" type="checkbox"/> NO <input type="checkbox"/>	
f. IS RESIDENCE ON A FARM? YES <input type="checkbox"/> NO <input checked="" type="checkbox"/>			
3. NAME (TYPE OR PRINT) FIRST Darrell MIDDLE James LAST Hill			
4. SEX M		5. THIS BIRTH 35	
6. SINGLE <input checked="" type="checkbox"/> TWIN <input type="checkbox"/> TRIPLET <input type="checkbox"/>		35. IF TWIN OR TRIPLET, WAS CHILD BORN 1ST <input type="checkbox"/> 2D <input type="checkbox"/> 3D <input type="checkbox"/>	
7. NAME (TYPE OR PRINT) FIRST Clarence MIDDLE Hill LAST Negro		8. DATE OF BIRTH Nov 20 58	
9. AGE (at time of this birth) 35 YEARS		10. BIRTHPLACE (State or foreign country) Ala.	
11. USUAL OCCUPATION Carpenter		12. KIND OF BUSINESS OR INDUSTRY Contractor	
13. MAIDEN NAME (Type or Print) FIRST Ora MIDDLE Les LAST Archer		14. COLOR OR RACE Negro	
15. AGE (at time of this birth) 30 YEARS		16. BIRTHPLACE (State or foreign country) Ark.	
17. INFORMANT'S NAME OR SIGNATURE Ora Hill		18. PREVIOUS DELIVERIES TO MOTHER (DO NOT include this birth) a. How many OTHER children are now living? 3 b. How many OTHER children were born alive but are now dead? none c. How many (total) deaths (fetuses born dead at AK time after conception)? none	
19. MOTHER'S MAILING ADDRESS		19. DATE SEROLOGIC TEST FOR SYPHILIS Mar 58	
I hereby certify that this child was born alive on the date stated above.		19b. ATTENDANT AT BIRTH Mar 58 M. D. <input checked="" type="checkbox"/> D. O. <input type="checkbox"/> MIDWIFE <input type="checkbox"/> OTHER (Specify)	
19c. SIGNATURE 		19d. DATE SIGNED 11-28-58	
20. DATE RECD. BY LOCAL REG. 10-28-58		21. REGISTRAR'S SIGNATURE 	
		22. DATE ON WHICH GIVEN NAME ADDED 11-28-58	

Judith B. Nagy
State Registrar

MAY - 9 2018

2022-011769 MISC Page: 1693 of 2782
09/28/2022 03:35:37 PM Receipt #: 22-9381
Reg Fee: \$30.00 Darrell James Hill
Gila County, AZ, Sadie Jo Bingham, Recorder



I HEREBY CERTIFY THIS DOCUMENT IS AN EXACT COPY OF THE RECORD ON FILE WITH THE OHIO DEPARTMENT OF HEALTH

VERIFY PRESENCE OF DD WATERMARK HOLD TO HIGH VIEW

REV. 7/2

1682

APACHE JUNCTION
 151 W SUPERSTITION BLVD
 APACHE JUNCTION, AZ 85120-9998
 030259-0130
 (800)275-8777
 05/18/2020 03:35 PM

Product	Qty	Unit Price	Price
First-Class Package Service 3 Days (Domestic) (WASHINGTON, DC 20500) (Weight: 0 Lb 2.10 Oz) (Estimated Delivery Date) (Friday 05/22/2020)	1	\$4.20	\$4.20
Registered (Amount: \$21.00) (USPS Registered Mail #) (RE322387559US)			\$13.20
Return Receipt (USPS Return Receipt #) (9590940245638278430987)			\$2.85
Total:			\$20.25

Cash Change \$100.00 (\$79.75)

Due to the security of Registered Mail, an additional 3-10 delivery days should be added to the expected delivery date provided.

In a hurry? Self-service kiosks offer quick and easy check-out. Any Retail Associate can show you how.

Text your tracking number to 28777

UNITED STATES POSTAL SERVICE
REGISTERED MAIL™

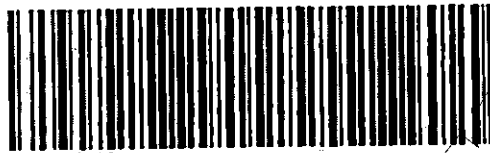

RE 047 610 440 US

Label 200, August 2005 PSN 7690-02-000-9311

Registered No. RE322387559US

Reg. Fee	\$4.20	
Handling Charge	\$13.20	Return Receipt
Postage	\$2.85	Restricted Delivery
Received by	\$0.00	
		\$20.25

Customer Must Declare Full Value \$21.00
 Domestic insurance up to \$25,000 is included based upon the declared value. International indemnity is limited. (See Reverse).

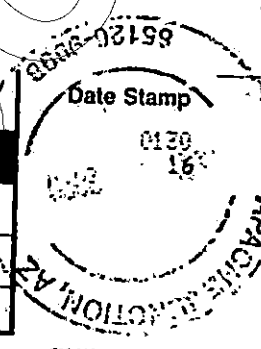

FROM
 Darrell James Hill; beneficiary
 96 PD Box 3806
 Apache Junction, Arizona 85117

TO
 Donald John Trump; trustee
 1600 Pennsylvania Ave NW
 Washington, District of Columbia 20500

PS Form 3806, Receipt for Registered Mail Copy 1 - Customer
 May 2007 (7530-02-000-9051) (See Information on Reverse)
 For domestic delivery information, visit our website at www.usps.com®

Unoffi



Registered No. RE047610438US

Date Stamp

0130
01

0130
01

APACHE JUNCTION
151 W SUPERSTITION BLVD
APACHE JUNCTION, AZ 85120-9998
030259-0130
(800)275-8777
05/19/2020 01:18 PM

Reg. Fee	\$0.85	Receipt	
Handling Charge	\$0.25	Restricted Delivery	
Postage	\$0.85	Received by	
Total		\$16.90	

Customer Must Full Value \$21.00 Domestic Insurance up to \$25,000 is included on the declared value. International indemnity is limited. (See Reverse).

OFFICIAL USE

TO BE COMPLETED BY CUSTOMER (PLEASE PRINT) ALL ENTRIES MUST BE IN BALLPOINT OR TYPED

FROM: APACHE JUNCTION, AZ 85120
PO Box 3806
Apache Junction, Arizona 85120

TO: William-Pelham-Barr, - Trustee
950 Pennsylvania Ave NW
Washington, Dist of Columbia 20020

PS Form 3806, Receipt for Registered Mail Copy 1 - Customer
May 2007 (7530-02-000-9051)
For domestic delivery information, visit our website at www.usps.com®

U.S. Postal Service™
CERTIFIED MAIL™ RECEIPT
(Domestic Mail Only; No Insurance Coverage Provided)

For delivery information visit our website at www.usps.com®
WASHINGTON DC 20220

Postage	\$3.55
Certified Fee	\$2.85
Return Receipt Fee (Endorsement Required)	\$0.00
Restricted Delivery Fee (Endorsement Required)	\$0.00
Total Postage & Fees	\$7.10

0130
01
Postmark Here

05/19/2020

Sent To: Steve-Tuener-Minochin, - Trustee
Street, Apt. No. or PO Box No.: 1500 Pennsylvania Ave NW
City, State, ZIP+4: Washington, Dist of Columbia 20020

PS Form 3800, August 2006 See Reverse for Instructions

Product	Qty	Unit Price	Price
First-Class Mail® Letter (Domestic) (WASHINGTON, DC 20220) (Weight: 0 Lb 2.00 Oz) (Estimated Delivery Date) (Saturday 05/23/2020)	1	\$0.70	\$0.70
Certified (USPS Certified Mail #) (70081300000222564705)			\$3.55
Return Receipt (USPS Return Receipt #) (9590940245638278431007)			\$2.85
US Flag Bklt/20	1	\$11.00	\$11.00
First-Class Mail® Letter (Domestic) (WASHINGTON, DC 20220) (Weight: 0 Lb 2.20 Oz) (Estimated Delivery Date) (Saturday 05/23/2020)	1	\$0.85	\$0.85
Registered (Amount: \$21.00) - (USPS Registered Mail #) (RE047610438US) -			\$13.20
Return Receipt (USPS Return Receipt #) (9590940245638278430994)			\$2.85
Total:			\$35.00

Cash \$40.00
Change (\$5.00)

Due to the security of Registered Mail, an additional 3-10 delivery days should be added to the expected delivery date provided.

Text your tracking number to 28777 (USPS) to get the latest status.



1684

:Darrell-James: Hill, -:civilian, -:Executor
PO Box 3806, Apache Junction, Arizona 85117

To: Arizona- state -Sheriffs

:Mark, :Sheriff- Pinal county, Arizona state- :Lamb,
:Joseph- Jr, :Sheriff Apache county, Arizona state- :Dedman,
:Mark, :Sheriff -Cochise county Arizona state- :Dannels,
:Jim, :Sheriff -Coconino county, Arizona state- :Driscoll,
:Adam, :Sheriff- Gila county, Arizona state - :Shepherd,
:Preston- "PJ", :Sheriff -Graham county, Arizona state- :Allred,
:Tim, :Sheriff- Greenlee county, Arizona state- :Sumner,
:Bill, :Sheriff- La Paz county, Arizona state- :Risen,
:Paul, :Sheriff- Maricopa county, Arizona state- :Penzone,
:Doug, :Sheriff- Mohave county, Arizona state- :Schuster,
:David, :Sheriff- Navajo county, Arizona state- :Clouse,
:Mark, :Sheriff- Pima county, Arizona state- :Napier,
:Tony, :Sheriff- Santa Cruz county, Arizona state- :Estrada,
:Scott, :Sheriff- Yavapai county, Arizona- :Mascher,
:Leon, :Sheriff- Yuma county, Arizona state- :Wilmot,
c/o :Mark :Lamb, -:Trustee
971 N Jason Lopez Circle
Building C
PO Box 867
Florence, Arizona state 85132

RE: Declaration by :i- man -beneficiary -primary-creditor to the Trustee of the 'Emergency Banking Act of 1933' -:indenture to :require/request/demand for the Restoration of :all- :property post-haste with the Accounting provided to :i-man: Darrell-James: Hill, et al. (See: Equity-Claim :Presentment: Express Trust: Emergency Banking Act of 1933 A.D. -Trust¹, USPS RE 047 610 440 US -:May 15th, 2020 A.D.; appended: 9 pages).

Greetings :Mark, et al.

In the Law. :Sheriffs are the :guardians of the liberty in this republic.

As the appended -document indicates, the 'Emergency Banking Act of 1933' has been completed since 2003 A.D., after 70 years. The :principal-property ought-to-have-been conveyed back at a time no-later-than 2013 A.D.; but, what is a trustee that steals the principal-property? The present :trustee's duty and obligation under his oath-of-office is to the non-competition and absolute protection to the return of :all of the principal-property post-haste. For this reason, :you have been notified.

:i- man request that you assure that this document is noticed by :you, and be placed into the permanent record of the RTCC to aid in the safety of :i- man -civilian in the pursuit to safe-guard against this massive theft of the property from the literally defunct- 'New Deal' -trust of 1933; that the property-held-without-right it will be conveyed- back to The united States of America- ;people.

1 :Emergency Banking Act of 1933, et al. means: Public Law 73-1/ Statutes at Large 48 Stat. 1, et al. - Trading With The Enemy Act, amended ~Subdivision (b) of section 5 of the Act of October 6, 1917 ... to read as follows: During time of war or during any other period of national emergency declared by the President... President may require any person within the United States... engaged in any transaction...be fined... imprisoned..., or both.... Cf. Trading with the Enemy Act of 1917, Pub.L. 65-91, 40 Stat. 411.

2022-011769 MISC Page: 1696 of 2782
09/26/2022 03:35:37 PM Receipt #: 22-9381
Rec Fee: \$30.00 Darrell James Hill
Gila County, Az, Sadie Jo Bingham, Recorder



:May 20, 2020 A.D. to: Arizona-state Sheriffs and NSA 1 / 3

:Darrell-James: Hill, -:civilian, -:Executor
PO Box 3806, Apache Junction, Arizona 85117

Thank you.

Enclosure: Equity-Claim :Presentment: Express Trust: Emergency Banking Act of 1933 A.D. -Trust, USPS
RE 047 610 440 US -:May 15th, 2020 A.D.; appended: 9 pages.

cc: by: USPS, First Class Mail

:Joseph- Jr, :Sheriff Apache county, Arizona state- :Dedman
PO Box 518
St. Johns, Arizona 85936

:Mark, :Sheriff -Cochise county Arizona state- :Dannels
205 North Judd Drive
Mile Post 345, Highway 80
Bisbee, Arizona 85603

:Jim, :Sheriff -Coconino county, Arizona state- :Driscoll
219 East Cherry Avenue
Flagstaff, Arizona 86001

:Adam, :Sheriff- Gila county, Arizona state- :Shepherd
1100 South Street
P.O. Box 311
Globe, Arizona 85502

:Preston- "PJ", :Sheriff -Graham county, Arizona state- :Allred
921 W. Thatcher Boulevard
Safford, Arizona 85546

:Tim, :Sheriff- Greenlee county, Arizona state- :Sumner
253 5th St
Clifton, Arizona 85533

:Bill, :Sheriff- La Paz county, Arizona state- :Risen
1109 W Arizona Ave
Parker, Arizona 85344

:Paul, :Sheriff- Maricopa county, Arizona state- :Penzone
550 West Jackson
Phoenix Arizona 85003

Doug, :Sheriff- Mohave county, Arizona state- :Schuster
P.O. Box 1191
600 W. Beale St.
Kingman, Arizona 86402-1191

2022-011769 MISC Page: 1697 of 2782
09/26/2022 03:35:37 PM Receipt #: 22-9381
Rec Fee: \$30.00 Darrell James Hill
Gila County, Az, Sadie Jo Bingham, Recorder



3, :May 20, 2020 A.D. to: Arizona-state Sheriffs and NSA 2 / 3

:Darrell-James: Hill, -:civillan, -:Executor
PO Box 3806, Apache Junction, Arizona 85117

:David, :Sheriff- Navajo county, Arizona state- :Clouse
P.O. Box 668
Holbrook, Arizona 86025

:Mark, :Sheriff- Pima county, Arizona state- :Napier
1750 E. Benson Highway
Tucson, Arizona 85714

:Tony, :Sheriff- Santa Cruz county, Arizona state- :Estrada
2170 N. Congress Dr,
Nogales, Arizona 85621

:Scott, :Sheriff- Yavapai county, Arizona state- :Mascher
255 E. Gurley Street
Prescott, Arizona 86301

:Leon, :Sheriff- Yuma county, Arizona state-,
:Board of Directors, :National Sheriff's Association- :Wilmot
141 S. 3rd Avenue
Yuma, Arizona 85364

:Board of Directors, National Sheriff's Association,
:President- National Sheriff's Association- :Hall
c/o :Daron, :Sheriff- Davidson county, Tennessee state-
:President- National Sheriff's Association- :Hall
1450 Duke Street
Alexandria, Virginia 22314

Without prejudice

:Darrell-James: Hill, -:civillan, -:Executor,
-:Priority- Creditor of the dead-trust:
Emergency Banking Act of 1933

USPS RE 322 387 545 US, :May 20, 2020 A.D. to: Arizona-state Sheriffs and NSA 3 / 3

1687
2022-011769 MISC Page: 1698 of 2782
09/26/2022 03:35:37 PM Receipt #: 22-9381
Rec Fee: \$30.00 Darrell James Hill
Gila County, Az, Sadie Jo Bingham, Recorder



APACHE JUNCTION
 151 W SUPERSTITION BLVD
 APACHE JUNCTION, AZ 85120-9998
 030259-0130
 (800)275-8777
 05/20/2020 12:44 PM

Product	Qty	Unit Price	Price
First-Class Mail® Letter (Domestic) (PHOENIX, AZ 85003) (Weight:0 Lb 2.30 Oz) (Estimated Delivery Date) (Saturday 05/23/2020) Affixed Postage (Affixed Amount:\$0.55)	1	\$0.85	\$0.85
First-Class Mail® Letter (Domestic) (FLAGSTAFF, AZ 86001) (Weight:0 Lb 2.30 Oz) (Estimated Delivery Date) (Saturday 05/23/2020) Affixed Postage (Affixed Amount:\$0.55)	1	\$0.85	\$0.85
First-Class Mail® Letter (Domestic) (GLOBE, AZ 85502) (Weight:0 Lb 2.30 Oz) (Estimated Delivery Date) (Saturday 05/23/2020) Affixed Postage (Affixed Amount:\$0.55)	1	\$0.85	\$0.85
First-Class Mail® Letter (Domestic) (CLIFTON, AZ 85533) (Weight:0 Lb 2.30 Oz) (Estimated Delivery Date) (Saturday 05/23/2020) Affixed Postage (Affixed Amount:\$0.55)	1	\$0.85	\$0.85
First-Class Mail® Letter (Domestic) (KINGMAN, AZ 86402) (Weight:0 Lb 2.30 Oz) (Estimated Delivery Date) (Tuesday 05/26/2020) Affixed Postage (Affixed Amount:\$0.55)	1	\$0.85	\$0.85
First-Class Mail® Letter (Domestic) (YUMA, AZ 85364) (Weight:0 Lb 2.30 Oz) (Estimated Delivery Date) (Saturday 05/23/2020) Affixed Postage (Affixed Amount:\$0.55)	1	\$0.85	\$0.85
First-Class Mail® Letter (Domestic) (HOLBROOK, AZ 86025) (Weight:0 Lb 2.30 Oz) (Estimated Delivery Date) (Saturday 05/23/2020) Affixed Postage (Affixed Amount:\$0.55)	1	\$0.85	\$0.85
First-Class Mail® Letter (Domestic) (TUCSON, AZ 85714) (Weight:0 Lb 2.30 Oz) (Estimated Delivery Date) (Saturday 05/23/2020)	1	\$0.85	\$0.85

First-Class Mail® Letter (Domestic) (PRESCOTT, AZ 86301) (Weight:0 Lb 2.30 Oz) (Estimated Delivery Date) (Saturday 05/23/2020) Affixed Postage (Affixed Amount:\$0.55)	1	\$0.85	\$0.85
First-Class Mail® Letter (Domestic) (PARKER, AZ 85344) (Weight:0 Lb 2.30 Oz) (Estimated Delivery Date) (Saturday 05/23/2020) Affixed Postage (Affixed Amount:\$0.55)	1	\$0.85	\$0.85
First-Class Mail® Letter (Domestic) (SAFFORD, AZ 85546) (Weight:0 Lb 2.30 Oz) (Estimated Delivery Date) (Saturday 05/23/2020) Affixed Postage (Affixed Amount:\$0.55)	1	\$0.85	\$0.85
First-Class Mail® Letter (Domestic) (NOGALES, AZ 85621) (Weight:0 Lb 2.30 Oz) (Estimated Delivery Date) (Saturday 05/23/2020) Affixed Postage (Affixed Amount:\$0.55)	1	\$0.85	\$0.85
First-Class Mail® Letter (Domestic) (ALEXANDRIA, VA 22314) (Weight:0 Lb 2.30 Oz) (Estimated Delivery Date) (Tuesday 05/26/2020) Affixed Postage (Affixed Amount:\$0.55)	1	\$0.85	\$0.85
First-Class Mail® Letter (Domestic) (SAINT JOHNS, AZ 85936) (Weight:0 Lb 2.30 Oz) (Estimated Delivery Date) (Saturday 05/23/2020) Affixed Postage (Affixed Amount:\$0.55)	1	\$0.85	\$0.85
First-Class Mail® Letter (Domestic) (BISBEE, AZ 85603) (Weight:0 Lb 2.30 Oz) (Estimated Delivery Date) (Saturday 05/23/2020) Affixed Postage (Affixed Amount:\$0.55)	1	\$0.85	\$0.85
Rate Inquiries	1	\$0.00	\$0.00
First-Class Mail® Letter (Domestic) (FLORENCE, AZ 85132) (Weight:0 Lb 2.70 Oz) (Estimated Delivery Date) (Saturday 05/23/2020) Registered (Amount:\$21.00) (USPS Registered Mail #) (RE322387545US)	1	\$0.85	\$13.20
Total:			\$18.55
Cash			\$20.00
Change			(\$1.45)

1688

2022-011769 MISC Page: 1699 of 2782
 09/26/2022 03:35:37 PM Receipt #: 22-9381
 Reg Fee: \$30.00 Darrell James Hill
 Gila County, Az, Sadie Jo Bingham, Recorder



Registered No. RE322387545US

Date Stamp

To Be Completed By Post Office	Reg. Fee	\$0.85	Return Receipt Restricted Delivery
	Handling Charge	\$13.20	
	Postage	\$0.00	
	Received by	\$0.00	
		\$14.05	
Customer Must Declare Full Value		\$1.00	Domestic insurance up to \$25,000 is included on the date of mailing. International indemnity is limited (see Reverse).

To Be Completed By Customer (Please Print) All Entries Must Be In Ballpoint or Typed	FROM	Darrell James Hill, AR PO Box 3806 Apache Junction, Arizona 85117
	TO	Mark Lamb 971 N. Benson Lopez Circle Bldg C, PO Box 867 Florence, Ariz. 85132

PS Form 3806, Receipt for Registered Mail Copy 1 - Customer
 May 2007 (7530-02-000-9051) (See Information on Reverse)

Official Copy

Unofficial Copy

1689

2022-011769 MISC Page: 1700 of 2782
 09/26/2022 03:35:37 PM Receipt #: 22-9381
 Rec Fee: \$30.00 Darrell James Hill
 Gila County, Az, Sadie Jo Bingham, Recorder





Copy

AFFIDAVIT: PROOF OF CLAIMS - AUGUST 2019

**:Darrell- James: Hill, :beneficiary, :Executor
5124 East 18th Avenue
Apache Junction, Arizona 85119**

**Re: Gila county, Arizona Recorder Doc. ##: 2017-002378; #2017-006522;
#2018-005176**

**This :August 30th, 2019, :Order of Event explains and correlates the :details
related to the progressive events effecting the: Gila county, Arizona, Recorder
Doc. #: 2017-002378, #2017-006522, and #2018-005176: related issues and
matters.**

**Attached are supportive documents of the First recordation- August 2019,
presented in the support of the topical issues and matters directly effecting the
:order of the events effecting the :soul-journey of the man :Darrell-James: Hill,
Executor of :his -property, and :his property-claims.**

Order of the Events and Documents

**Documents
to the man:
Secretary of
the
Department
of the
Treasury**

RMN RE 322 404 155 US :Darrell-James: Hill ORDER OF EVENTS 09/20/19 1 / 9

1690





1 September 9th, 2016: to man: Arizona state Sheriffs; Presumption and Political Election: RE 322 399 208 US. See :Gila county recorder :# 2017-002378, pp. 45-107.

2 September 9th, 2016: to Barack: POTUS Obama: Presumption and Political Election: RE 322 399 208 US. See :Gila county recorder :# 2017-002378, pp. 149-152.

3 September 9th, 2016: to Joseph: JCOS General Dunford: Presumption and Political Election: RE 322 399 211 US. See :Gila county recorder :# 2017-002378, pp. 154-156.

4 October 14th, 2016: to :Loretta: USAG Lynch: Presumption and Political Election: RMN RE 322 399 282 US. See :Gila county recorder :# 2017-002378, pp. 166-169

5 October 31st, 2016: Property Claim #1/3: RMN RE 322 399 279 US → :Gila county recorder :# 2017-002378 ~ Proof of Claims → people: Barack and Loretta → recv'd: Oct. 31, 2016. See :Gila county recorder :# 2017-002378: Darrell-James: pp 1-4, 6-24, 109-127: Presumption; Beverly-Jean: pp 1-4, 26-44, 129-147: Presumption

6 November 11th, 2016: to Loretta: Cease and Desist: re: RE 322 399 279 US: See: Gila county Recorder doc #: 2017-002378, pp. 551-559. 1) Have had received no communication re: property-claimed; 2) Fee schedule by tacit agreement.

RMN RE 322 404 155 US :Darrell-James



COPY

FILED

1697



7 November 16th, 2016: to Loretta: _ : RB
898 810 007 US: re: RE 322 399 279 US:
See: Gila county Recorder doc #: 2017-
002378, pp. 561-584.

8 January 3rd, 2017: to : Ranier: Chief Judge
USDC Arizona. Expressed- Desire to hold
Common Law venue for the address v. non-
communication: See :Gila county
recorder :# 2017-002378, pp. 188, 191.

9 January 3rd, 2017: to : Brian: Clerk of the
court: USDC Arizona. Expressed- Desire to
hold Common Law venue for the address v.
non-communication: See :Gila county
recorder :# 2017-002378, pp. 184-187,
192-194.

10 March 19th, 2017. Property-Claim #2/3: First
RMN RE 322 399 251 US → r/t: Gila recorder: X
county recorder - Proof of Claims → August 2019.
people: Donald and Jeff → recy'd: March
19th, 2017.

12 July 13th, 2017: to Jeff: Demand for to First
dispose to :- man the property-claimed recorder:
by :- man by the RMN RE 322 399 251 of. August 2019.
March 21, 2017 ~ RMN RE 322 399 101
US.

13 July 13th, 2017: to: Donald: POTUS, Jeff: First
DOJ, et al., Laurie: OIP, Andrew: FBI, et al., recorder:
Mark: Pinal county Arizona Sheriff ~ RMN August 2019.
RE 322 399 044 US, RMN RE 322 399
058 US, RMN RE 322 399 061, RMN RE
322 399 089 US, RMN RE 322 399 075
US, RMN RE 322 399 092 US, CMN 7015
0640 0001 5883 2655, and first class
mail: ~ Proof of claim: Declaration in
Claim Against Criminal Wrong-Doings ...
:re: Gila county, Arizona Recorder #:
2017-006522 - July 7th, 2017.

RMN RE 322 404 155 US :Darrell-James: Hill ORDER OF EVENTS 08/30/19 3 / 8

1692

COPY





14 August 8th, 2017: to :Jeff, AG Sessions and :Kenneth-A.:Asst AG Blanca: Attention to :Constitutional- Protected- Rights Deprivation ~CMN 7015 0640 0001 5883 2662. First recordation: August 2019. X

15 August 18th, 2017: Notice and Demand: Denial of Authorization for NSA: RMN RE 322 399 129 US. First recordation: August 2019.

16 August 23rd, 2017: to :Donald, et al.: JCOS, COSs: Notice and Demand - :Notice ~man of the non-political aggregate~ and Demand ~ favorable end to Claims-executed - RMN RE 322 399 132 US: re: Affidavit: Proof of Claims ~ Gila county, Arizona Recorder Doc # 2017-002378; WITH ENCLOSURES of the communications referencing the inherent and non-delegated rights-executed and the rights-executed limitations upon the UNITED STATES government/man-actors: Executive and Judicial Branches. First recordation: August 2019.

17 September 26th, 2017 Property- Claim #3/3: RMN RE 322 399 248 US :Gila county Arizona recorder - Proof of Claims → people: Donald and Jeff → recv'd September 26th, 2017 First recordation: August 2019. X no p. 41.

18 January 17th, 2018: to :Jeff: Dishonor: a) of the man: - Jeff: USAG Sessions ~ RMN RE 322 399 146 US of the Claims: One- August 16th, 2016: RE 322 399 279 US; Two- February 17th, 2017: RE 322 399 251 US; and, Three- September 15th, 2017: RMN RE 322 399 248 US, b) Itemized Bill to the Agreement. First recordation: August 2019. X

19 January 31st, 2018: to :Donald, JCOS, COS Army: Demand for the Fiduciary Protection of Fundamental Rights re: First recordation: August 2019. X

RMN RE 322 404 155 US :Darrell-James: Hill ORDER OF EVENTS 08/30/19 4 / 8

1693

COPY

2022-011769 MISC Page: 1704 of 2782

09/26/2022 03:35:37 PM Receipt #: 22-9381
Rec Fee: \$30.00 Darrell James Hill
Gila County, Az, Sadie Jo Bingham, Recorder



Dishonor of the man: - Jeff: USAG Sessions
~ RMN RE 322 399 146 US; RMN RE 322
399 150 US.

20 April 13th, 2018: to :Donald, JCOS, COS Army: Notice of Default: Option to Cure
Default re: RMN RE 322 399 150 US; RMN
RE 322 398 242 US. First
recording: X
August 2019.

21 April 12th, 2018: to :Summit county, Ohio-
state fiscal office: Statement of the
Claim :Curative Registration of the Found
Live- Life: RMN: RE 322 399 163 US See: Gila county
Recorder Doc #:
#2018-005176;
May 14th, 2018;
pp. 10 - 21.

22 April 12th, 2018: Kristen-M.: Summit
county, Ohio-state Fiscal Officer: Scalise
CPS, CFE, c/o: Katie Mancino, *Executive*
Assistant I: 'Live-Life document... not
recordable in this county. See: Gila county
Recorder Doc #:
#2018-005176;
May 14th, 2018.
2018. - Non-
recording - p.
13.

23 April 25th, 2018: to :Kristen-M.: Fisc.
Officer Scalise c/o : Katie: *EA~I* Mancino,
and :Steve: Summit county, Ohio-state
Sheriff Barry: re: RMN RE 322 399 163
US... and 'Live-Life' document attached:
RMN RE 322 399 194 US, RMN RE 322
399 203 US See: Gila county
Recorder Doc #:
#2018-005176 -
p. 14-17.
Tacit
acquiescence of
the counter-offer.

24 May 14th, 2018: Statement of the
Claim :Curative Registration of the Found
Live- Life: See: Gila county, Arizona
Recorder Doc #: #2018-005176;

25 May 29th, 2018: to :Donald, JCOS, COS Army: Dishonor re: RMN RE 322 399 150
US; RMN RE 047 636 404 US First
recording: X
August 2019.

26 July 3rd, 2018. See: a) Constructive Notice
of "DARRELL JAMES HILL" of the "Darrell- First
recording:

RMN RE 322 404 155 US: Darrell James Hill

2019-009291 MISC Page: 5 of 851
09/26/2019 02:24:05 PM Receipt #: 19-6918
Rec Fee: \$30.00 Darrell James Hill
Gila County, Az, Sadie Jo Bingham, Recorder

2022-011769 MISC Page: 1705 of 2782
09/26/2022 03:35:37 PM Receipt #: 22-9381
Rec Fee: \$30.00 Darrell James Hill
Gila County, Az, Sadie Jo Bingham, Recorder



James of the family Hill" : Authorized Representative, AND: b) Superior constructive Notice and Demand: Permanent Non-Commercial Presumption: man: Darrell-James: Hill. See: in #27: July 3rd, 2018, following.

August 2019.

27 July 3rd, 2018: to :John: Ohio Governor Kasich and :Steve: Summit county Sheriff Barry: a) Constructive Notice of DARRELL JAMES HILL...; and, July 3rd, 2018: with a): b) Superior Constructive Notice and Demand: Permanent Non-Commercial Presumption: man: Darrell-James: Hill: CMN 7015 1730 0002 3063 9348, and :CMN 7015 1730 0002 3063 9331

Correspondence within #26

28 July 13th, 2018: Apostille/Authentication Return Form, Non-dated- non-singed- Form: 'the Arizona secretary of the state advised by U.S. department of the state and A.R.S. §41-121(B).... 'the secretary has decided to not authenticate the notary for the unspecified reason(s) - r/t: July 13th, 2018: first-class - mail request for the authentication of the notarization by the Arizona- state Notary public.

First recordation: August 2019.

29 July 25th, 2018: to :Ranier: Chief- judge Collins and :Brian: Clerk court Karth; Notary- Public :Certificate of :Dishonor: RMN RE 047 636 435 US and RMN RB 898 809 940 US

Re: Denial of right-executed First recordation: August 2019.

30 June 27th, 2018: to :Donald: POTUS- Commander Trump and :William-P: USAG- APC- Common-law Trustee Barr: Notice... civilian statuses: RMN RE 322 404 098 US - :Darrell-James: Hill.

First recordation: August 2019. X

RMN RE 322 404 155 US :Darrell-James

2019-009291 MISC Page: 6 of 851
08/30/2019 02:24:05 PM Receipt #: 19-6918
Rec Fee: \$30.00 Darrell James Hill
Gila County, Az, Sadie Jo Bingham, Recorder

2022-011769 MISC Page: 1706 of 2782
09/26/2022 03:35:37 PM Receipt #: 22-9381
Rec Fee: \$30.00 Darrell James Hill
Gila County, Az, Sadie Jo Bingham, Recorder



31 June 27th, 2018: to :Donald: POTUS-
Commander Trump and :William-P: USAG-
APC- Common-law Trustee Barr: Notice...
civilian statuses: RMN RE 322 404 084
US - Beverly-Jean: Romero- Hill.

**First
recording:
August 2019.**

X

32 July 31st, 2018: to Doug; Arizona state
governor Ducey ~ RMN RE 047 636 466
US, Michele: Arizona secretary of the state
~ RE 047 636 470 US, and man: Head of
the notary division ~ CMN 7017 1000
0000 9394 0773

r/t: # 27, to see &
halt wrong-doing.
Presentment of
the July 3rd, 2018:
a) Fee-schedule/
willful violations,
and b)
Presumption of
the and Political
Election
**First
recording:
August 2019.**

33 August 1st, 2018:
Apostille/Authentication Return, Non-
dated- non-signed-, Form: 'the secretary of
the state advised by U.S. department of the
state and A.R.S. §41-121(B)... the
secretary has decided to not authenticate
the notary for the unspecified reason(s) -
document is in # 31
r/t: # 31, to acceptance of the chose of the
liability of the any- wrong-doing as r/t to
the Fee- schedule, and to the Presumption
of- and the Political Election

r/t: # 31, to
acceptance of the
chose of the
liability of the
any- wrong-doing
as r/t to the Fee-
schedule, and to
the Presumption
of- and the
Political Election
**First
recording:
August 2019.**

34 August 7th, 2018: to :Donald: POTUS
Trump and :Jeff: USAG Sessions: Notary-
Public :Certificate of :Dishonor: RMN RE
047 636 418 US, and: RB 898 809 919
US

Re: Property-
Claims: 1/3: RMN
RE 322 399 279
US, 2/3: RMN RE
322 399 251 US,
and 3/3: RMN RE

X

RMN RE 322 404 155 US :Darrell-J:

1696

2019-089291 MISC Page: 7 of 851
08/30/2019 02:24:05 PM Receipt #: 19-6918
Rec Fee: \$30.00 Darrell James Hill
Gila County, Az, Sadie Jo Bingham, Recorder

2022-011769 MISC Page: 1707 of 2782

09/26/2022 03:35:37 PM Receipt #: 22-9381
Rec Fee: \$30.00 Darrell James Hill
Gila County, Az, Sadie Jo Bingham, Recorder



322 399 248 US.
First
recording:
August 2019. -
document is in #
31

35 August 9th, 2018; to : Michele: U.S.
Secretary of the Arizona state Reagan:
Evidence of the authenticity of a notarial-
act performed....: RMN RB 898 809 936
US

Re: See: 32.
Non-filing
sustained.
First
recording:
August 2019.

36 August 14th, 2018: to Kristin: Summit
county Ohio Fiscal officer Scalise and :
Katie, EA / Mancino: Notary- Public
:Certificate of :Dishonor :RMN RE 047 636
449 US, and: RMN RB 898 809 975 US

Re: non-filing of
Live-Life
First
recording:
August 2019.

Without Prejudice,

Darrell - James Hill, A.R.
Darrell-James: Hill, :beneficiary: Executor

Arizona state
Pinal county

IURAT

Affirmed and autographed before me this 30th day: August, 2019.
Type of Identification: Arizona Driver License.

Sadie Jo Bingham
Notary Public

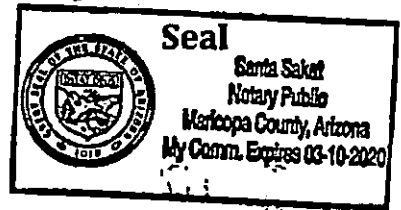

RMN RE 322 404 155 US - Darrell James

2022-011769 MISC Page: 1708 of 2782
09/26/2022 03:35:37 PM Receipt #: 22-9381
Rec Fee: \$30.00 Darrell James Hill
Gila County, Az, Sadie Jo Bingham, Recorder

2019-009291 MISC Page: 8 of 851
08/30/2019 02:24:05 PM Receipt #: 19-6918
Rec Fee: \$30.00 Darrell James Hill
Gila County, Az, Sadie Jo Bingham, Recorder





APACHE JUNCTION
151 W SUPERSTITION BLVD
APACHE JUNCTION, AZ 85120-9998
(800)275-8777

09/18/2020 01:34 PM

Product	Qty	Unit Price	Price
Priority Mail® 2-Day 1 Washington, DC 20500 Weight: 1. Lb 1.00 Oz Expected Delivery Date Monday 09/21/2020			\$14.90
Registered Mail® Amount: \$21.00 Tracking #: RE322398401US			\$13.20
Return Receipt Tracking #: 9590940247188344961870			\$2.85
Total			\$30.95
Grand Total:			\$30.95

To Be Completed By Post Office

Extra Services & Fees: \$24.90

- Registered Mail: \$13.20
- Return Receipt (hardcopy): \$2.85
- Return Receipt (electronic): \$0.00
- Restricted Delivery: \$0.00

Signature Confirmation: \$0.00

Restricted Delivery: \$0.00

Total Postage & Fees: \$30.95

Customer Mkt Declares Full Value: \$21.00

Received by: 09/18/2020

Domestic Insurance up to \$50,000 is included based upon the declared value. International indemnity is limited. (See Reverse)

OFFICIAL USE

To Be Completed By Customer (Please Print) All Entries Must Be In Ballpoint or Typed

FROM

1600 Pennsylvania Ave NW
PO Box 3806
Apache Junction, Arizona 85117

TO

Donald - John Trump - Trustee
1600 Pennsylvania Ave NW
Washington, Dist. of Columbia
20500

PS Form 3806, Registered Mail Receipt Copy 1 - Customer
April 2015, PSN 7530-02-000-9051 (See Information on Reverse)
For domestic delivery information, visit our website at www.usps.com

Cash: \$100.00
Change: (\$69.05)

Due to limited transportation availability as a result of nationwide COVID-19 impacts package delivery times may be

SENDER, COMPLETE THIS SECTION	COMPLETE THIS SECTION ON DELIVERY
<p>Complete items 1, 2, and 3</p> <p>Print your name and address on the reverse so that we can return the card to you.</p> <p>Attach this card to the back of the mailpiece, or on the front if space permits.</p> <p>1. Article Addressed to: Donald - John Trump 1600 Pennsylvania Ave NW Washington, Dist. of Columbia 20500</p> <p>2. Article Number (Transfer from service label) RE322398401US</p>	<p>A. Signature X _____ <input type="checkbox"/> Agent <input type="checkbox"/> Addressee</p> <p>B. Received by (Printed Name) _____ C. Date of Delivery _____</p> <p>D. Is delivery address different from item 1? <input type="checkbox"/> Yes If YES, enter delivery address below: <input type="checkbox"/> No</p> <p>RECEIVED</p> <p>MSOD Mail Operation</p> <p>3. Service Type <input type="checkbox"/> Adult Signature <input checked="" type="checkbox"/> Registered Mail® <input type="checkbox"/> Certified Mail® <input type="checkbox"/> Collect on Delivery <input type="checkbox"/> Insured Mail (over \$500) <input type="checkbox"/> Registered Mail Restricted Delivery <input type="checkbox"/> Return Receipt for Merchandise <input type="checkbox"/> Signature Confirmation™ <input type="checkbox"/> Signature Confirmation Restricted Delivery</p>
<p>Barcode: 9590 9402 4718 8344 9618 70</p> <p>PS Form 3811, July 2015 PSN 7530-02-000-9053</p>	<p>Domestic Return Receipt</p>

1698

2022-011769 MISC Page: 1709 of 2782
09/26/2022 03:35:37 PM Receipt #: 22-9381
Rec Fee: \$30.00 Darrell James Hill
Gila County, Az, Sadie Jo Bingham, Recorder



USPS Tracking®

[FAQs >](#)

Track Another Package +

**Track Packages
Anytime, Anywhere**

Get the free Informed Delivery® feature to receive automated notifications on your packages

[Learn More](#)

(https://reg.usps.com/xsell?app=UspsTools&ref=homepag...Banner&appURL=https%3A%2F%2Finformeddelivery.usps.com/box/pages/intro/startaction)

Tracking Number: RE322398401US

[Remove X](#)

Your item was delivered at 3:42 am on September 30, 2020 in WASHINGTON, DC 20500.

Delivered

September 30, 2020 at 3:42 am
Delivered
WASHINGTON, DC 20500

Get Updates ▾

Text & Email Updates ▾

Tracking History ▲

September 30, 2020, 3:42 am
Delivered
WASHINGTON, DC 20500

Your item was delivered at 3:42 am on September 30, 2020 in WASHINGTON, DC 20500.

September 26, 2020, 2:02 am
Arrived at Unit
WASHINGTON, DC 20066

September 24, 2020
In Transit to Next Facility

1199

2022-011769 MISC Page: 1710 of 2782

09/26/2022 03:35:37 PM Receipt #: 22-9381
Rec Fee: \$30.00 Darrell James Hill
Gila County, Az, Sadie Jo Bingham, Recorder



9/30/20, 10:48 PM

Darrell-James: Hill, Ohioan-©1958-A.D., -civilian, -:Executor -beneficiary
PO Box 3806, Apache Junction, Arizona 85117

About the gross theft of :property from :i- man by :Donald-John: Trump, et al. -generals.
USPS RMN RE 322 387 580 US 1/3

Trustees:

:Mark-Alexander :General United States Army¹-:Chairman: CJCOS²- :Milley,
:John-Earl :General United States Air Force: Vice- CJCOS- :Hyten,
:James-Charles :General United States Army: COS³ Army-
:David-Hilberry :General United States Marine Corps: CMC⁴- :Berger,
:Michael-Martin :Admiral United States Navy: CNO⁵- :Gilday.,
:David-Lee :General United States air Force: COS AF⁶- :Goldfein,
:John-William :General United States Space Force: CSO⁷- :Raymond,
:Joseph-Lauren :General United States Air Force: CNG⁸- :Lengyel
:Karl-Leo :Admiral United States Coast Guard: CCG⁹- :Schultz
c/o :James-Charles: McConville, :USPS RMN RE 322 387 580 US
Office: CJCOS
9999 Joint Staff Pentagon
Washington, District of Columbia 20318-9999

Regarding: Stolen Property-claimed and possessed by :i- man, Stolen by the POTUS-Trustee, - POTUSA-CIC, aided and abetted by :you, et al.

Greetings :James-Charles, et al.- generals,

Attached is the ' :Special- Presentment, ~Book 9' sent to the man, :Donald-John- Trump, et al., and with the evidence in the public record of :all of the property-claimed and possessed that :you, et al. have stolen. To do this :you had to first steal the most basic rights given by :Almighty-God; and, to be judged, :this-beloved-nation had to openly acknowledge its' wrongdoing and prefer the :violation of the covenant with the Almighty-God, et seq. The judgment is here now; how severe it will be is still negotiable with :repentance, changing and turning. - Satan is a liar. -

:James-Charles, et al.- generals, Satan has opened a Big door to conquer and humble :you/this nation long before :you/wel/i-man were born. :Your, -:my/our -technology cannot stop this because Satan is the opposition and has attained the :legal-right to prevail over :you, :us/our -nation. -:i- man grieve to know this. -

- 1 :General United States means: General: 'The United States of America' Army
- 2 :CJCOS means: Chairman: Joint Chief Of Staff
- 3 :COS means: Chief of Staff
- 4 :CMC means: Commandant of the Marine Corps
- 5 :CNO means: Chief of Naval Operations
- 6 :COS AF means: Chief of Staff of the Air Force
- 7 :CSO means: Chief of Space Operations
- 8 :CNG means: Chief of the National Guard Bureau
- 9 :CCG means: Commandant of the Coast Guard

US WITHOUT PREJUDICE

1/3

2022-011769 MISC Page: 1711 of 2782
09/26/2022 03:35:37 PM Receipt #: 22-9381
Rec Fee: \$30.00 Darrell James Hill
Gila County, Az, Sadie Jo Bingham, Recorder



Darrell-James: Hill, Ohioan-©1958-A.D., -civilian, -:Executor -beneficiary
PO Box 3806, Apache Junction, Arizona 85117

About the gross theft of :property from :i- man by :Donald-John: Trump, et al. -generals.
USPS RMN RE 322 387 580 US 2/3

Consider: One cannot protect :i- man from the theft of the property-claimed and possessed by :i- man from a mere government-services-provider, POTUS-corp.

The Last Hurdle: There is nothing civilized or righteous or acceptable nor justifiable about/for merely stealing the property of :i- man- Darrell-James: Hill, beneficiary- ambassador.

Attached in the 'Book' is the property-claimed and possessed that :i- man, by the Almighty-God's guidance, have often reported to :you for to please/restore to :i- man, but you have not abided by your oaths, duties and obligations in this regard over the last several years; thus, :you are :in-dishonor with the POTUS, and with the POTUSA-CIC -over-standing: -outside of the covenant with the Almighty-God.

:Special- Presentment- Book Corrections:

a) Gila county, Arizona Recorder Doc# error: is re: Arizona Doc# is: 2019-009291

Sec.	Pg. no.	Section Content
Body	1	Introduction
A	25	Referenced Scriptures
B	39	To:Jorge-Mario: Bergoglio;USPS RMN RE 322 387 576 US; c/o Apostolic Palace, 00120 Vatican City, c/o :Donald-John :CIC- :Trump :USPS RMN RE 322 387 562 US;
C	48	:Clarifications: Unlawful-Illegal- Deprivation of :Unalienable-Rights
C1		Lot # 1: Property-claimed and possessed September 2016: See: Gila county Doc. # 2017- 002378, pp. 240-549. USPS RMN Re 322 399 279 US, recv'd: October 31, 2016 by :Loretta :Lynch. Not attached
C2		Lot #2: Property-claimed and possessed. Recorder Doc# is: 2019-009291, pp. 431-750 March 19th, 2017. Property-Claim #2/3: First RMN RE 322 399 251 US → r/t: Gila recordation: county recorder – Proof of Claims → August 2019. people: Donald and Jeff → recv'd: March 19th. 2017. Not attached
C3		Lot #3: Property-claimed and possessed. Recorder Doc# is: 2019-009291, pp. 751-1109.

US WITHOUT PREJUDICE

2/3

2022-011769 MISC Page: 1712 of 2782
09/26/2022 03:35:37 PM Receipt #: 22-9381
Rec Fee: \$30.00 Darrell James Hill
Gila County, Az, Sadie Jo Bingham, Recorder



Darrell-James: Hill, Ohioan-©1958-A.D., -civilian, -Executor -beneficiary
 PO Box 3806, Apache Junction, Arizona 85117

About the gross theft of :property from :i- man by :Donald-John: Trump, et al. -generals.
USPS RMN RE 322 387 580 US 3/3

		September 26th, 2017 Property-Claim #3/3: RMN RE 322 399 248 US :Gila county Arizona recorder - Proof of Claims → people: Donald and Jeff → recv'd September 26th. 2017 Not attached	First recordation: August 2019, no p. 41.
D	49	The correct Gila county, Arizona Recorder Doc# is: 2019-009291	
E	50	Document History: EBA-1933-2003-Trust Closure data.	
footnotes	78	Footnotes	

:i- man request and recommend that :you, et al., restore to :i- man all of the property-claimed and possessed. :Unalienable-rights are from :Almighty-God to :i- man, :wherein you have no discretion. Literally -Attached to this special-presentment to You, et al., are the Section C.-listings of property-stolen-only in the :Lots: 1, 2, and 3; very-much --+:property has been stolen from :i- man. :in -Repentance to Almighty-God is :in -order.

Sincerely,
 Without prejudice

Darrell-James Hill, Executor
 :Darrell-James: Hill, :civilian - executor- beneficiary

Witnessed and autographed before me this 21st day of September, 2020 A.D.
 Type of Identification: Arizona Driver License

Cheryl Smith
 Notary Public



2022-011769 MISC
 09/26/2022 03:35:37 PM
 Rec Fee: \$30.00
 Gila County, Az, Sadie Jo Birmingham, Recorder

Page: 1713 of 2782
 Receipt #: 22-9981
 Darrell James Hill

1702

The UPS Store - #3750
 5301 S. Superstition Mountain Dr
 Ste 104
 Gold Canyon, AZ 85118
 (480) 474-9838

09/21/20 01:10 PM

We are the one stop for all your shipping, postal and business needs.

We offer all the services you need to keep your business going.



001 000003 (011)
 Notary

TO \$ 10.00

SubTotal \$ 10.00
 Total \$ 10.00

Cash \$ 20.00
 Change \$ 10.00-

Receipt ID 83947882176414888380 001 Items
 CSH: CHYRL Tran: 8767 Reg: 001

Thank you for visiting our store.
 Please come back again soon.

Whatever your business and personal needs, we are here to serve you.

We're here to help.
 Join our FREE email program to receive great offers and resources.

www.theupsstore.com/signup

2022-011769 MISC Page: 1714 of 2782

09/26/2022 09:35:37 PM Receipt #: 22-9381
 Rec Fee: \$30.00 Darrell James Hill
 Gila County, Az, Sadie Jo Bingham, Recorder



Registered No.

RE322387580US

Date Stamp

0130
 14

To Be Completed By Post Office	Reg. Fee	\$15.05	
	Handling Charge	\$13.20	Return Receipt
	Postage	\$2.85	Restricted Delivery
	Received by	\$0.00	
	Customer Must Declare Full Value	\$0.00	09/21/2020



To Be Completed By Customer (Please Print) All Entries Must Be In Ballpoint or Typed	FROM	Darrell James Hill PO Box 3806 Apache Junction, Ariz. 85117
	TO	James-Charles: Mc Conville, Gen. 20318 Washington, Dist of Columbia 20318-9999

PS Form 3806, Receipt for Registered Mail Copy 1 - Customer
 May 2007 (7530-02-000-9051) (See Information on Reverse)
 For domestic delivery information, visit our website at www.usps.com



APACHE JUNCTION
 151 W SUPERSTITION BLVD
 APACHE JUNCTION, AZ 85120-9998
 (800)275-8777

09/21/2020 12:59 PM

Product	Qty	Unit Price	Price
Priority Mail® 2-Day 1 Med FR Box			\$15.05
Washington, DC 20318 Flat Rate			
Expected Delivery Date Thursday 09/24/2020			
Registered Mail®			\$13.20
Amount: \$21.00			
Tracking #: RE322387580US			
Return Receipt			\$2.85
Tracking #: 9590940247188344961863			
Total			\$31.10
Grand Total:			\$31.10
Cash			\$100.00
Change			(\$68.90)

USPS Tracking®

[FAQs >](#)

Track Another Package +

**Track Packages
Anytime, Anywhere**

Get the free Informed Delivery® feature to receive automated notifications on your packages

[Learn More](#)

(https://reg.usps.com/xsel7app=UspsTools&ref=homepageBanner&appURL=https%3A%2F%2Finformeddelivery.usps.com/box/pages/intro/start.action)

Tracking Number: RE322387580US

[Remove X](#)

Your item arrived at the Post Office at 1:10 am on September 26, 2020 in WASHINGTON, DC 20066.

In-Transit

September 26, 2020 at 1:10 am
Arrived at Unit
WASHINGTON, DC 20066

[Get Updates](#) ▾

Text & Email Updates ▾

Tracking History ▲

September 26, 2020, 1:10 am
Arrived at Unit
WASHINGTON, DC 20066
Your item arrived at the Post Office at 1:10 am on September 26, 2020 in WASHINGTON, DC 20066.

September 25, 2020, 4:55 am
Arrived at USPS Regional Destination Facility
WASHINGTON DC DISTRIBUTION CENTER

September 24, 2020, 5:46 pm
Departed USPS Facility

2022-011769 MISC Page: 1715 of 2782

09/26/2022 03:35:37 PM Receipt #: 22-9381
Rec Fee: \$30.00 Darrell James Hill
Gila County, Az, Sadie Jo Bingham, Recorder



10/8/20, 5:03 PM

**Specialty Presentment: USPS RMN: RE 322 387 593 US, To: Crown – Trustee
For: Report of the Completed change of Trustee;
For :Restoration of: intangible and tangible stolen-property**

1 / 4

**From: Darrell-James: Hill¹, -i- man² -Ohioan-©-1958 A.D.³, -civilian⁴, -Executor⁵ -beneficiary⁶,
-Ambassador⁷,
PO Box 3806, Apache Junction, Arizona 85117**

To: Temple Bar:

**:David :Richards, :The-Rt-Hon-Lord-Justice
Treasurer –
Honourable Society of Lincoln's Inn
The Treasury Office Lincoln's Inn London WC2A 3TL
London
Ph. 0207 405 1393; and,**

**:Crown-, :in- chancery,
-:Trustee**

First Class Mail

**:Brian :Leveson, :The-Rt-Hon-Sir
Treasurer
The Honourable Society of the Middle Temple
The Treasury Office
Ashley Building
Middle Temple Lane
London EC4Y 9BT
Ph. 020 7797 8250; and,**

**:Crown-, :in- chancery,
-:Trustee**

First Class Mail

**:Guy :Fetherstonhaugh, -:QC,
Treasurer
The Honourable Society of the Inner Temple,
Treasury Office,
1 Mitre Court, London EC4Y 7BS
Ph. 020 7797 8179; and,**

**:Crown-, :in- chancery,
-:Trustee**

First Class Mail

**c/o :Anthony :Harking, :BrigadierOBE
Under Treasurer
The Honourable Society of Gray's Inn
8 South Square
London
WC1R 5ET
Ph. 020 7458 7805**

**:Crown-, :in- chancery,
-:Trustee**

**:USPS -RMN -:RE 322 387
593 US**

:Specialty-Presentment :USPS -RMN -:RE 322 387 593 US Regarding the:

- 1. :Verified -Removal of :Roman-church -Trustee-derelect, et al.- from the man
-:Jorge- Mario: Bergoglio;**
- 2. :Report of the Completed change of :Trustee-individual to the man -:Darius-
Benjamin-Thummin: Hill, -Kinsman-Redeemer; with,**
- 3. :Restoration of the Intangible and Tangible :Deprived-of and Stolen-
Property to the Beneficiary -:House-of-Judah and the :Holy-church, et
seq.- :i- man -Darrell-James: Hill, progeny of :Negro-Ysrael of the Children-
of-Jacob, et seq.- Holy-church.**

Greetings :David, :Brian, :Guy, :Anthony, et al.- :Barons;

:Authority of :Ambassador: from the Messiah- Yushuah

**:Servant -Administrator of the Holy-Church from the House-of-Judah from the Tribe-of-Judah,
-survivor of the Roman-church -annihilations -for the extinctions of :Jerusalem, Ysrael- 70 A.D.
and for the :same-evil against of the Kingdom-of-Judah, -:Negroland- 1619 A.D., et seq.- unto
and through the :abject-enslavement of the people of :God :in the United Colonies of :Britain by
the Roman-church-Trustee- :in- collaboration, and with :daily-adminstration over the violation**

2020 October 12 :Removal of :Roman-church -Trustee-derelect, et al. -:Jorge- Mario

USPS RMN: RE 322 387 593 US w/r

1 / 4

2022-011769 MISC Page: 1716 of 2782
09/26/2022 03:35:37 PM Receipt #: 22-9381
Rec Fee: \$30.00 Darrell James Hill
Gila County, Az, Sadie Jo Bingham, Recorder



**Specialty Presentment: USPS RMN: RE 322 387 593 US, To: Crown – Trustee
For: Report of the Completed change of Trustee;
For :Restoration of: intangible and tangible stolen-property**

2 / 4

of :Negro-Ysrael, et al.- House of Judah, and the Holy-Church, by the Roman-church-Trustee-dereliction and violation of the fiduciary-duty and obligations under the Concession-of-1213 A.D., 'Concession-1213-A.D.'- covenant- oath, duty and obligations for to absolutely protect :Ysrael and the Holy-church.~ See: '**Specialty- presentment: To The Roman -Church, et al.- Usurpers, For the Cure and Relief -in the :Equity-Claim, and For the Remedy-Required For the Trespassing Upon the Children of Ysrael/Israel, et al.**'; appended: 8 pages; tacitly-acquiesced by Jorge-Mario, et al.

:Messiah- Yushuah -Ambassador: -man- Darrell-James: Hill

:i- man -Darrell-James: Hill, ambassador of the Almighty-God, am given-authority as is in this letter of :introduction by the means of the Messiah-Yushuah (':Jesus') :son of the Most-High-God, the :saviour, for :His will be done; that the House of Judah and the Holy-church will now receive the :offer-now-accepted ~ from the Concession-of-1213 -A.D. to the Messiah, Peter, Paul and Holy-church~ 1) by :i- man -:Darius-Benjamin-Thummin -named by :God- :echad, and known by the appellation :Darrell-James: Hill, -:Negro-Ysrael, -:Ohioan-©-1958 A.D., son of Clarence, ... son of Israel, Isaac, Abraham, ...Shem, Noah, ... son of Adam- son of the Creator-Jehovah; and, 2) by the atonement by :Yushuah the :Messiah, who came to this Earth, died for the sins of :all- mankind, and for the remission of :sin for :those -whosoever will-accept the :free-gift offered to the life-eternal :in and through the Messiah- :Yushuah, the Almighty-God, the only-begotten :Son of the Most High God.

:Property Retained And Claimed by the Tribe of Judah, et al.- Holy-church:

For the Concession-1213-A.D. by :John- I, to the Messiah, Peter, Paul and the Holy-church, et seq., so stands the :covenant to :i- man, ambassador, kinsman-redeemer, Trustee, :man-Darrell-James: Hill.

:Usurper -:Trespassing; -- the :Un-Holy -Roman-Church, -:Trustee- Dereliction:

:i- man- ambassador am instructed as is now :completed to you by :this-notice for the restoration of the Concession-1213-A.D., et seq., no-longer held by the Roman-church-Trustee-derelict, et al.- :man -:Jorge-Mario: Bergoglio of the un-holy- Roman-church who did also internationally, expressively and overtly-abdicate the :Trustee Oath and fiduciary-duty and obligations to the Concession-1213-A.D., et al., - with the violation of the fiduciary- duty and obligations by the Roman-church-Trustee -derelict, et seq.- by the man entitled: Pope: Innocent: 1213 A.D., et seq.- unto the man appellated: Jorge-Mario: Bergoglio: 2020 A.D. Thereto: see the Order appended, and: see: www.twitter.com/@DarBenThu1.

:Holy-church -Property Holded and Held by Roman-church-Trustee- Fraud:

Unto you sirs, et al., :administrative-fidelity is now required by :i- man to make aright the/your duty and obligation to the Concession-of -1213 -A.D. -:in-chancery, et seq., that :all property and possessions-of and/or derivative-of or from the Concession-of-1213-A.D., of: England and Ireland holded, and, of :all property presently-held and/or to be held by the consequence of the acceptance of the Concession-1213-A.D. is severed from the Roman-church :in- disgrace.

Now-to-fore and after, the presentment of the :any- adminstrative- authority from the Roman-church upon or by or through :your-any- actions to minister the :Concession-of-1213-A.D. Is strictly forbidden. -- Thereto, :i- man authorize only bread, water and humble lodging until further notice:

No expense for the any-sundry needs are authorized;

No distributions are permitted from the related Concession-1213-A.D.-:property.

No agreement, presentment or presentation is permitted by the Roman-church as the "Holy-church", nor other, as related-to or bearing-upon the Concession-1213-A.D. -duty and obligations to the House of Ysrael and/or the Holy-church of the Almighty-God, -:Yushuah the :Messiah.

:All-agreements now-to-fore are subject to revision due to the Roman-church dereliction of oath, duty and obligations. :All-actions and agreements are heretow and after subject to repair for the damage-done by the Roman-church.

Further, now to after, :all Roman-church actions are :solely- private and non-binding upon the

2020 October 12 :Removal of :Roman-church -Trustee-derelict, et al. -:Jorge- Mario

USPS RMN: RE 322 387 593 US w/rr

2 / 4



**Specialty Presentment: USPS RMN: RE 322 387 593 US, To: Crown – Trustee
For: Report of the Completed change of Trustee;
For :Restoration of: intangible and tangible stolen-property**

3 / 4

upon the :any- obligation upon the Concession-1213-A.D., et seq. -:beneficiaries or property.

WARNING: :All and any further :Roman-church :presumptive-performance as the 'Trustee' by any means as relates to the Concession-1213-A.D., et seq., must be recognized as :international- fraud by the criminal- usurpation and violation of the Concession-1213-A.D. covenant heretofore and now-after.

Restoration of :All- Property is Required and Demanded Restored:

Unto you sirs, et al., upon the receipt of the matter in this Notice, :the :Roman-church is already-formally removed as Trustee to the Concession-1213-A.D. by this acceptance by the ambassador from the Almighty-God -:man- Darrell-James: Hill.

:Notice by :i- man, -:Trustee of the Concession-1213-A.D. is by :this -notice completed by the authorized- ambassador of the Messiah- Yushuah, :Darrell-James: Hill.

:Crown- :Trustees- :in- Chancery

:Your receipt of the matter of this :Specialty-Presentment requires that :you must set this :claim and determination by :- man -:ambassador -:Darrell-James: Hill, Trustee of the Concession-1213-A.D., upon the Roman-church- derelict, et al.- :man, -:Jorge-Mario: Bergoglio with the copy to :i- man, affirming :in the Crown- by- :chancery acknowledgment of the ambassador of the Messiah-Yushuah, -assignee: Darrell-James: Hill.

Accounting:

The :complete -:accounting to the penny of :all -property and records is now-required post-haste by :i- man, -ambassador, -:Trustee, by secured-delivery to the address provided.

Security:

Absolute bio-physical and body- security for :i- man, -ambassador is now required, ordered, and must be completed post-haste with :your, et al. -notification of :same- requirement upon the 'Secretary of State -:United States where on the united States of America :i- man now habitate.

cc:

:Donald-John: Trump, -:POTUSA- CIC, -:Trustee
1600 Pennsylvania Ave NW
Washington, District of Columbia 20500

First Class Mail

:Michael-R.: Pompeo, :U.S.-SOS, -:Trustee
c/o :Lisa-D.: Kenna, -:Executive Secretary, -:Trustee

Office of the Secretary,
c/o: Office Of Public Liaison
Bureau Of Global Affairs
U.S. Department Of State
2201 C Street NW, Room 2206
Washington, D.C. 20520-2204

USPS RMN RE 322 398 392 US

:i- man affirm the :above is true and correct, and :i- man will state :same in the open court.

Without prejudice:

Darrell-James Hill, Ambassador
:Darrell-James: Hill, ambassador of :Almighty-God, -
Trustee: Concession-of-1213-A.D.

Affirmed and autographed before :Notary-Public :this 13th day, October- 2020 A.D.

[Signature]
:Notary-Public

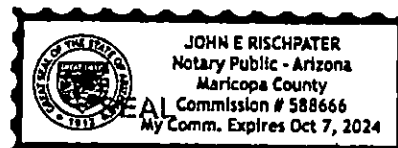

2020 October 12 :Removal of :Roman-church -Trustee-derelict, et al. -:Jorge- Mario
USPS RMN: RE 322 387 593 US w/rr

3

2022-011769 MISC Page: 1718 of 2782
09/26/2022 03:35:37 PM Receipt #: 22-9381
Rec Fee: \$30.00 Darrell James Hill, Recorder
Gila County, Az, Sadie Jo Bingham, Recorder

- 1 **:Darrell-James: Hill means:** Earthen -:man-child, :birthed :son of :Clarence, :son of :James, :son :Negroland, :Kingdom-of-Judah, :Africa', ...:son :Ysrael- :Southern-Kingdom ~ of the sons :Judah and Benjamin and Levi, et al.~, ...:son of :Jacob and :Ysrael, :son of :Isaac, :son of :Abram and :Abraham, ...:son of :Shem, :son of :Noah, ...:son of :Methuselah, :son of :Enoch, ...:son of :Seth, :son of :Adam with :Eve of the garden of :Eden ~ including all :known and unknown :ancestral- lands ~ on the earth placed under the Adamic- lineage and under the :only-begotten -son of the Most-High-God and Father embodied within the rebirth by :i- man of the power of :Yushuah-Messiah, -:God, with the redemption by the Messiah- Yushuah ('Jesus-the-Christ'), and encompassing the :receivership, responsibility and administration over :all of the earth-planet as :heir - :remainderman, and :Kinsman- :redeemer of the Earth, both 1) from the Adamic-lineage by the :loss in :spirit in the man upon the Earth, and 2) by the Messiah-Yushuah by the restoration in the Holy Spirit in :i- man upon the Earth: on, in or under-the-surface of the planet; :on, in or under-the-surface of the oceans and waters, and :on, in, under-the-surface of the atmosphere/ above the atmosphere of the Earth to wherever the :Adamic- :man -kind in the quantum and in the spirit is now, of :where the :purposes of the **Most High God** and Father are immeasurable by mere :man. No-thing Stands between the Almighty God~ His Father; See: KJV- Book: Daniel -chap. 7 v 9 - 14.~ and :i-man.
- 2 **:i- man means:** 'i' is the Great :i am, :Almighty--God and :Creator of all and 'man-kind', -:in the image of the Almighty God and His Father, the :Ancient-of-Days ~ the Most-High-God. Ibid 1, et seq.
- 3 **:Ohioan- © -1958 A.D. Means:** as appellated in :common-law, birthed on the United-Colonies, et seq.- Ohio: 1958.
- 4 **:civilian means:** non-combatant, non-belligerent with the Almighty-God -given unalienable rights :inhabitant of the land-trust.
- 5 **:Darrell-James: Hill means:** :Darrell-James: Hill means: Darrell-James: Hill © 1958 A.D.: Ohioan- © -1958 A.D.: State of Ohio: beneficiary. See: Gila county Arizona: Doc. # 2017-002378: pp. 6-24, 89-91,93-95 of 693. Gila county Arizona: Doc. # 2018-005176: pp. 10-21; and, et seq.: beneficiary of the Cestui Que Trustee-minister: Jorge-Mario: Bergoglio
- 6 **:beneficiary means:** the individual -spirit, soul, quantum -amalgam to an for whom the trust is created, and for whom the trustee-actors labor to assure cestui-que-use.
- 7 **:Ambassador means:** KJV- Book: Ephesians--- chap. 6, v. 20. "For which I am an ambassador in bonds: that therein I may speak boldly, as I ought to speak."



1708

Unofficial

Declaration of :-i- man - :Ambassador to :Yushuah the :Messiah

From :Darrell-James: Hill¹, :-i- man², :-civilian, :-Executor³, :-Ambassador⁴,
PO Box 3806, Apache Junction, Arizona 85117

:man :-present,

:The united States of America,

Arizona state
Pinal county

To :Jorge-Mario: Bergoglio⁵ ~:USPS RMN RE 322 387 576 US
c/o Apostolic Palace
00120 Vatican City^{6 7}
c/o :Donald-John :CIC- :Trump^{8 9} :USPS RMN RE 322 387 562 US
1600 Pennsylvania Ave NW
Washington, District of Columbia 20500

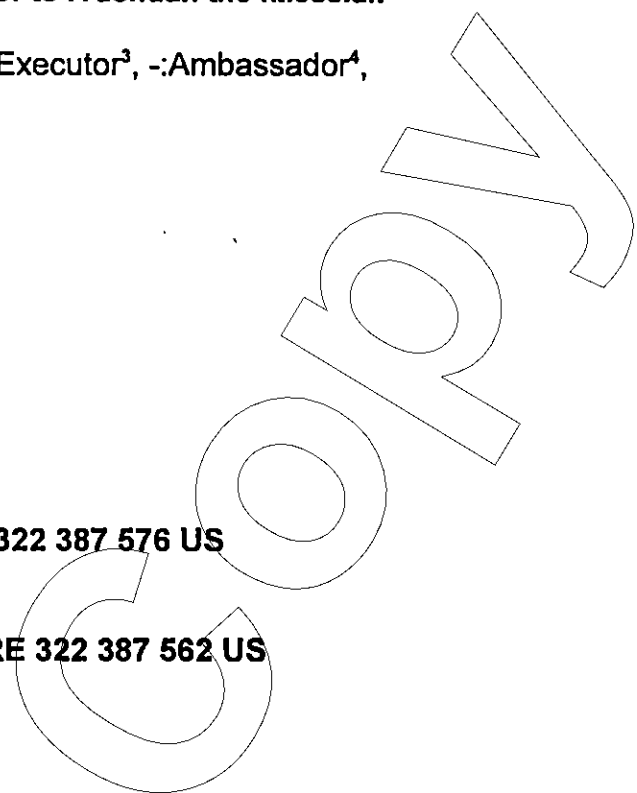

**Specialty- Presentment: To The Roman -Church¹⁰, et al.- Usurpers,
For the Cure and Relief -in the :Equity-Claim, and For the Remedy-Required
For the Trespassing Upon The Children of Ysrael/Israel, et al.**

Greetings :Jorge-Mario, :Donald-John, et al.,

With all due respect, :-i- man am to declare this to you by :order of the Messiah
Yushuah~Jesus~ God-Almighty. You must let All of the people of the Most-High-God
go free unharmed with all of their belongings and with the full-accounting of their
property and chattel. To :this- end, :-i- man must declare to you:

A - :Declaration: i- man am: Judah of: Ysrael

:-i- man declare 1) the :embodiment of :-i-man- Adam¹¹ within the oneness with the
Almighty- Creator :-God with the man :Jacob~ Ysrael¹², son of :Isaac¹³ the :brother of

- 1 :Darrell-James: Hill means: Earthen -man-child, :birthed :son of :Clarence, :son of :James, :son :Negroland, :Kingdom-of-Judah, :Africa', ...:son :Ysrael- :Southern-Kingdom ~ of the sons :Judah and Benjamin and Levi, et al.-, ...:son of :Jacob and :Ysrael, :son of :Isaac, :son of :Abram and :Abraham, ...:son of :Shem, :son of :Noah, ...:son of :Methuselah, :son of :Enoch, ...:son of :Seth, :son of :Adam with :Eve of the garden of :Eden ~ Including all :known and unknown :ancestral- lands ~ on the earth placed under the Adamic- lineage and under the :only-begotten -son of the Most-High-God and Father embodied within the rebirth by :-i- man of the power of :Yushuah-Messiah, :-God, with the redemption by the Messiah- Yushuah (:Jesus-the-Christ'), and encompassing the :receivership, responsibility and administration over :all of the earth-planet as :their - :remainderman, and :Kinsman- :redeemer of the Earth, both 1) from the Adamic-lineage by the :loss in :spirit in the man upon the Earth, and 2) by the Messiah-Yushuah by the restoration in the Holy Spirit in :-i- man upon the Earth: on, in or under-the-surface of the planet; :on, in or under-the-surface of the oceans and waters, and :on, in, under-the-surface of the atmosphere/ above the atmosphere of the Earth to wherever the :Adamic- :man -kind in the quantum and in the spirit is now, of :where the :purposes of the Most High God and Father are immeasurable by mere :man. No-thing Stands between the Almighty God~ His Father; See: KJV- Book: Daniel -chap. 7 v 9 - 14.~ and :-i-man.
- 2 :-i- man means: 'I' is the Great :-i am, Almighty God Creator of all and for whom all is; 'man' is the kind on this Earth- world, made in the image of the Almighty God and His Father, the :Ancient-of-Days - the Most-High-God
- 3 :Darrell-James: Hill means: :Darrell-James: Hill means: Darrell-James: Hill © 1958: Ohioan, © 1958: State of Ohio: beneficiary. See: Gila county Arizona: Doc. # 2017-002378: pp. 6-24, 89-91,93-95 of 693. Gila county Arizona: Doc. # 2018-005176: pp. 10-21; and, et seq.: beneficiary of the Cestui Que Trustee-minister: Jorge-Mario: Bergoglio55
- 4 :Ambassador means: KJV- Book: Ephesians— chap.. 6, v. 20. "For which I am an ambassador in bonds: that therein I may speak boldly, as I ought to speak."
- 5 :Jorge-Mario: Bergoglio means: man-kind of the Earth-planet
- 6 :Babylon- Rome means: KJV- Book :Daniel -chap. 2, v. 40 - 43.
- 7 :Rome means: KJV- Book: Obadiah— chap. 1; Psalms— chap.. 83.
- 8 :Donald-John: Trump means: man -trustee under the duty, obligation and moral-Oath of Office: 20th day of January, the year our Lord 2020 A.D.-, ministry: as :President of 'The united states of America' ~unincorporated,1776 A.D.- as 'Commander-in-Chief with the :General Order 100 ~Lieber Code~ :24th day, April, the year of our Lord 1863 A.D: under the Declaration of Independence for the united states of America -people by 'The Constitution for the United States of America' .
- 9 :Donald-John: Trump means: man-kind of the Earth-planet, :man -trustee under the duty, obligation and moral-Oath of Office
- 10 :Roman -Church means: the polytheism government methodology contrived and implemented from the 4th century A.D. by the Roman Emperor Constantine.
- 11 :Adam means: within the oneness with the Almighty- Creator :-God. See: KJV- Book: Genesis- chap. 2
- 12 :Jacob- Ysrael means: covenant of :God-Almighty and :Jacob means: KJV- Book: Genesis- chap 26 v 34 - Genesis- chap 31 v 29.
- 13 :Isaac means: covenant of :God-Almighty and Issac means: KJV- Book: Genesis— chap.. 17 v 15 And God said unto



1709

Declaration of :i- man - :Ambassador to :Yushuah the :Messiah

:Ishmael¹⁴, sons of :Abram ~ Abraham¹⁵, ...son of :Shem, ...son of: Noah¹⁶, ...son of Methuselah, ...son of :Adam; and, 2) :i- man- Adam declare that :i- man -:Negro¹⁷ am yet upon The united states of America a) :Judah of the people of Ysrael of the man :Jacob, and that :i- man am b) spiritually :Adam -of -Ysrael¹⁸ by the blood of the Messiah: Yushuah ~'Christ Jesus' ~ the : Almighty God~, by His Father's will be done.¹⁹ Thereto: No-thing Stands between the :Almighty God~ who is in oneness with His Father²⁰ and :i-man-²¹ :Darrell-James: Hill.

B - :i- man -:Adam Believe with :Faith in the Creator -:Almighty- God -:Statement

1. :i- man believe in the Creator-Almighty-God as characterized in the wise by the equations:

- a) $0 + 0 = 0$, et seq., where "0" is the absolutely empty set; where
- a.i.) "0" is the only moral -truth -set; that is, nothing plus nothing equals nothing;

- Abraham, As for Sarai thy wife, thou shalt not call her name Sarai, but Sarah shall her name be. 16 And I will bless her, and give thee a son also of her: yea, I will bless her, and she shall be a mother of nations; kings of people shall be of her. 17 Then Abraham fell upon his face, and laughed, and said in his heart, Shall a child be born unto him that is an hundred years old? and shall Sarah, that is ninety years old, bear? 18 And Abraham said unto God, O that Ishmael might live before thee! 19 And God said, Sarah thy wife shall bear thee a son indeed; and thou shalt call his name Isaac: and I will establish my covenant with him for an everlasting covenant, and with his seed after him.
- 14 :. brother :Ishmael means: covenant of :God-Almighty and Ishmael means: KJV- Book: Genesis-- chap.. 17 (a) v 9 And God said unto Abraham, Thou shalt keep my covenant therefore, thou, and thy seed after thee in their generations. 10 This is my covenant, which ye shall keep, between me and you and thy seed after thee; Every man child among you shall be circumcised. ... 11 And ye shall circumcise the flesh of your foreskin; and it shall be a token of the covenant betwixt me and you. 12 And he that is eight days old shall be circumcised among you, every man child in your generations, he that is born in the house, or bought with money of any stranger, which is not of thy seed. 13 He that is born in thy house, and he that is bought with thy money, must needs be circumcised: and my covenant shall be in your flesh for an everlasting covenant. 14 And the uncircumcised man child whose flesh of his foreskin is not circumcised, that soul shall be cut off from his people; he hath broken my covenant. ... 18 And Abraham said unto God, O that Ishmael might live before thee! 19 And God said, Sarah thy wife shall bear thee a son indeed; and thou shalt call his name Isaac: and I will establish my covenant with him for an everlasting covenant, and with his seed after him. 20 And as for Ishmael, I have heard thee: Behold, I have blessed him, and will make him fruitful, and will multiply him exceedingly; twelve princes shall he beget, and I will make him a great nation. ... 23 And Abraham took Ishmael his son, and all that were born in his house, and all that were bought with his money, every male among the men of Abraham's house; and circumcised the flesh of their foreskin in the selfsame day, as God had said unto him. 24 And Abraham was ninety years old and nine, when he was circumcised in the flesh of his foreskin. 25 And Ishmael his son was thirteen years old, when he was circumcised in the flesh of his foreskin. 26 In the selfsame day was Abraham circumcised, and Ishmael his son.
- 15 :Abram ~ Abraham means: covenant of God-Almighty and Abram ~ Abraham means: KJV- Book: Genesis-- chap.. 17 (a) v 1 And when Abram was ninety years old and nine, the LORD appeared to Abram, and said unto him, I am the Almighty God; walk before me, and be thou perfect. 2 And I will make my covenant between me and thee, and will multiply thee exceedingly. 3 And Abram fell on his face: and God talked with him, saying, 4 As for me, behold, my covenant is with thee, and thou shalt be a father of many nations. 5 Neither shall thy name any more be called Abram, but thy name shall be Abraham; for a father of many nations have I made thee. (b) 6 And I will make thee exceeding fruitful, and I will make nations of thee, and kings shall come out of thee. (c) 7 And I will establish my covenant between me and thee and thy seed after thee in their generations for an everlasting covenant, to be a God unto thee, and to thy seed after thee. 8 And I will give unto thee, and to thy seed after thee, the land wherein thou art a stranger, all the land of Canaan, for an everlasting possession; and I will be their God. 9 And God said unto Abraham, Thou shalt keep my covenant therefore, thou, and thy seed after thee in their generations. 10 This is my covenant, which ye shall keep, between me and you and thy seed after thee; Every man child among you shall be circumcised. (d1/2) 11 And ye shall circumcise the flesh of your foreskin; and it shall be a token of the covenant betwixt me and you. 12 And he that is eight days old shall be circumcised among you, every man child in your generations, he that is born in the house, or bought with money of any stranger, which is not of thy seed. 13 He that is born in thy house, and he that is bought with thy money, must needs be circumcised: and my covenant shall be in your flesh for an everlasting covenant. 14 And the uncircumcised man child whose flesh of his foreskin is not circumcised, that soul shall be cut off from his people; he hath broken my covenant. (e) 15 And God said unto Abraham, As for Sarai thy wife, thou shalt not call her name Sarai, but Sarah shall her name be. 16 And I will bless her, and give thee a son also of her: yea, I will bless her, and she shall be a mother of nations; kings of people shall be of her. 17 Then Abraham fell upon his face, and laughed, and said in his heart, Shall a child be born unto him that is an hundred years old? and shall Sarah, that is ninety years old, bear? (f) 18 And Abraham said unto God, O that Ishmael might live before thee! (g1/2) 19 And God said, Sarah thy wife shall bear thee a son indeed; and thou shalt call his name Isaac: and I will establish my covenant with him for an everlasting covenant, and with his seed after him. (h) 20 And as for Ishmael, I have heard thee: Behold, I have blessed him, and will make him fruitful, and will multiply him exceedingly; twelve princes shall he beget, and I will make him a great nation. (g2/2) 21 But my covenant will I establish with Isaac, which Sarah shall bear unto thee at this set time in the next year. (i) 22 And he left off talking with him, and God went up from Abraham. (j) 23 And Abraham took Ishmael his son, and all that were born in his house, and all that were bought with his money, every male among the men of Abraham's house; and circumcised the flesh of their foreskin in the selfsame day, as God had said unto him. 24 And Abraham was ninety years old and nine, when he was circumcised in the flesh of his foreskin. 25 And Ishmael his son was thirteen years old, when he was circumcised in the flesh of his foreskin. 26 In the selfsame day was Abraham circumcised, and Ishmael his son. 27 And all the men of his house, born in the house, and bought with money of the stranger, were circumcised with him.
- 16 :Noah means covenant of God-Almighty and Noah means: KJV- Book: Genesis-- chap.. 9 v 8 And God spake unto Noah, and to his sons with him, saying, 9 And I, behold, I establish my covenant with you, and with your seed after you; 10 And with every living creature that is with you, of the fowl, of the cattle, and of every beast of the earth with you; from all that go out of the ark, to every beast of the earth. 11 And I will establish my covenant with you; neither shall all flesh be cut off any more by the waters of a flood; neither shall there any more be a flood to destroy the earth. 12 And God said, This is the token of the covenant which I make between me and you and every living creature that is with you, for perpetual generations: 13 I do set my bow in the cloud, and it shall be for a token of a covenant between me and the earth. 14 And it shall come to pass, when I bring a cloud over the earth, that the bow shall be seen in the cloud: 15 And I will remember my covenant, which is between me and you and every living creature of all flesh; and the waters shall no more become a flood to destroy all flesh. 16 And the bow shall be in the cloud; and I will look upon it, that I may remember the everlasting covenant between God and every living creature of all flesh that is upon the earth. 17 And God said unto Noah, This is the token of the covenant, which I have established between me and all flesh that is upon the earth. 18 And the sons of Noah, that went forth of the ark, were Shem, and Ham, and Japheth: and Ham is the father of Canaan.
- 17 :Negro means: son of the Southern-Kingdom -of -Ysrael; enslaved by the Trustee-minister of the Magna Carta, et al.- Usurpers
- 18 :Adam of :Ysrael means: KJV- Book: A) Romans- chap. 5 v 12 Wherefore, as by one man sin entered into the world, and

Declaration of :i- man - :Ambassador to :Yushuah the :Messiah

and:

b) $0 + 1 = 1$, et seq., where "1" is the presence of the substance of the set of characteristics; that is, nothing plus :1 -:something equals :1 -:something; where b.i.) "1" is the only moral -truth -set;

and,

c) where the inverse of truth is characterized by the equations:

c.i) $0 + 0 = X$ -set where the untruth is the any 'set of X', except the "0" truth,

and

where

c.ii) $0 + 1 = Y$ -set where the untruth is the any 'set of Y', except the "1" truth.

Where-as: all -that -is -created in the worlds of the universes has :origin in the sum of the sets of :characteristics expressed within :a), b) and c)' with the intelligent- design by the Almighty-God with His Father, the :Most-High-God.

2. :i- man believe that :man -kind is the indivisible corporation of the spiritual faculties of the spirit and soul components joined into the original-intelligence- live- earthen- product by the Creator-God's design. And:

3. :i- man believe that man -kind's now-fallen-state diverged from the Creator-Gods' baseline design of :man- kinds' first estate -in -:oneness -with -:God; that, :man-kind's baseline -normal is in :oneness with the Most-High-God;

Where-as, that the act-of-repentance, -changing and turning toward God's law is by the exercise of the spiritual faculties toward :oneness -with -:God, repentance is the :foundation of :man-kinds' :spiritual-joy, physical-happiness, and :gladness with :abundance in :well-being ²².

C – :NOTICE:

Purgatory Oath: Lateness Of This Presentment

:i-man Affirm and Declare That The 'lateness Of This Presentment' Is Due To The Lack Of Knowledge And Ignorance Of :i-man; and, the :Trust -resources to afford the cost of this pursuit have been a) administered without authorization and b) used to impose harm and competition against :i-man -:beneficiary, et al.- children of Ysrael.

For the fact that :i-man- Adam, et al.- Judah, have been systematically -systemically -oppressed with the brutality-imposed -ignorance and assurance unto the lack of knowledge from the confederate- usurpers since on or before 1600 A.D. unto now ~2020 A.D.~ with the oversight and support for these and other harms by the Roman- Church -Usurper-Trustee -gross -malfeasance. Thereto, :i- man believe that this presentment is timely through the four centuries upon the historical accounts and recorded facts of the murder-for- annihilation for the extinction²³, and the continued abject- hostility upon :i- man, et al. - members of the House of Ysrael by the :absolute- malfeasance²⁴ of the pure -obligation²⁵ by the "Roman -Church", et al.- confederate :impostors.

death by sin; and so death passed upon all men, for that all have sinned: 13 (For until the law sin was in the world: but sin is not imputed when there is no law. 14 Nevertheless death reigned from Adam to Moses, even over them that had not sinned after the similitude of Adam's transgression, who is the figure of him that was to come. B) 1 Corinthians-- chap.. 15 v 21 For since by man *came* death, by man *came* also the resurrection of the dead. 22 For as in Adam all die, even so in Christ shall all be made alive. 23 But every man in his own order: Christ the firstfruits; afterward they that are Christ's at his coming. 24 Then *cometh* the end, when he shall have delivered up the kingdom to God, even the Father; when he shall have put down all rule and all authority and power. 25 For he must reign, till he hath put all enemies under his feet. 26 The last enemy *that* shall be destroyed *is* death. C) 1 Corinthians-- chap.. 15 v 42 So also *is* the resurrection of the dead. It is sown in corruption; it is raised in incorruption: 43 It is sown in dishonour; it is raised in glory: it is sown in weakness; it is raised in power: 44 It is sown a natural body; it is raised a spiritual body. There is a natural body, and there is a spiritual body. 45 And so it is written, The first man Adam was made a living soul; the last Adam was *made* a quickening spirit.

19 :Father's will be done[] means: KJV- Book: Mark-- chap.. 14 v. 32-36.

20 :Almighty God~ who is in oneness with His Father means: KJV- Book: John -chap 17

21 *ibid.* 1

22 :abundance in :well-being means: KJV- Book :Hebrews- chap 5 and 6.

23 :murder-for- annihilation for the extinction means: KJV- a) Book: Psalms 83. ; b) Book: Obadiah -chap 1.

24 :absolute- malfeasance means: contracts, torts. The unjust performance of some act which the party had no right, or which he had contracted not to do.

25 :pure -obligation means: tie which binds us to pay or to do something agreeably to the laws and customs of the country in which the obligation is made.

2022-011769 MISC Page: 1722 of 2782
09/26/2022 09:35:37 PM Receipt #: 22-9381
Rec Fee: \$30.00 Darrell James Hill
Gila County, Az, Sadie Jo Bingham, Recorder

Declaration of :i- man - :Ambassador to :Yushuah the :Messiah

D – :Wrong-doing: Roman -Church -Trespassing Upon The :Children -Of -Ysrael

:Roman -Church Fraud

:i- man declare that for the last four-hundred ~400~ years or more that the annihilation with the :murders upon the House of Judah of :Ysrael unto the abject enslavement onto the American-continent, et al.- "Egypt"²⁶ is commonly known and well documented within the records of the decisions with the violations of the fiduciary -duty and obligation by the :non- Christian -rulers of the Roman -Church -:military -church -regime until now. See: Magna Carta²⁷. – :Thereto, that :fraud vitiates, a) the equation of the fraud is fraud in :fact from the beginning, and, b) Where as, the Roman- Church is established in fraud as an impostor then the any :Roman -Church- :papal- infallibility is merely impossible.

E – Faux- Nobility of :Esau²⁸ with :Saul²⁹, et al.- Roman -Church Identity Theft

:i- man know and believe that as :Nothing is new under the sun, so again was Satan's use of the :pagen-rulers of :Rome akin to :King Herod's oppression directly upon the infant -:Yushuah, and unto Rome's, et al's, callous deeds surrounding the immoral :sacrifice of the adult -:Yushuah~ the :lamb of the Most-High-God~; so now-again after nearly :two-thousand~2000~ years ought the Roman -Church, et al., choose life through the :repentance, changing and turning afforded to :all and them by the Messiah -:Yushuah~ Jesus-the-Christ – Almighty-God~, the :lamb of the Most-High-God.

:i- man believe that the faux- nobility amalgam of Saul with Esau, et al.- Roman -Church -:military- :church -regime -:lineage has for many centuries opportunistically and tyrannically promoted :itself to the world with the deception that either bloodline is a) in the line of the succession of the children of Jacob/Ysrael, or, that b) :either has acted in the righteous -keeping of the commandments of the Almighty-God before the billions of :soul- witnesses sojourning on Almighty-God's Earth.

F – Coveting Is Now Fraud

- a) :i- man believe that for the coveting of the office of :Jacob~Ysrael that the 'Roman -Church', et al., passes-itself -off/passed-itself -off to the world as the "Holy Church³⁰.";
- b) Both :Esau and :Saul remain complicit in the fraud and are historically unfit to lead the "Holy -Church" as a matter of :common - biblical- knowledge as adjudged by the Almighty-God;
- c) The :Roman -Church to day remains unrepentant of the fiduciary-violations with the aiding, abetting, and condoning the continued brutal enslavement- for-annihilation of the

26 "Egypt" means: KJV- Book: Deuteronomy- chap 28 v 64 -68.

27 :Magna Carta 1215, A.D. means: a) Magna Carta, 1215 A.D. by: b) the :King John I, :Concession of England To The Pope, 1213 A.D., "We wish it to be known to all of you, through this our charter, furnished with our seal, that inasmuch as we had offended in many ways God and our mother the holy church, and in consequence are known to have very, much needed the divine mercy, and can not offer anything worthy for making due satisfaction to God and to the church unless we humiliate ourselves and our kingdoms:-we, wishing to humiliate ourselves for Him who humiliated Himself for us unto death, the grace of the Holy Spirit inspiring, not induced by force or compelled by fear, but of our own good and spontaneous will and by the common counsel of our barons, do offer and freely concede to God and His holy apostles Peter and Paul and to our mother the holy Roman church, and to our lord pope Innocent and to his Catholic successors, the whole kingdom of England and the whole kingdom Ireland with all their right and appurtenances...." administered by c) the 'Crown Temple' in the receipt of the Crown In Chancery understanding common law.

28 :Esau means: KJV- Book: A) Genesis-- chap.. 25 v 34; "... Esau despised his birthright."; B) Book: Romans 9:13 As it is written, Jacob have I loved, but Esau have I hated. ~ KJV- Book :Malachi- chap. 1 v 2 Was not Esau Jacob's brother? saith the LORD: yet I loved Jacob, 3 And I hated Esau, and laid his mountains and his heritage waste for the dragons of the wilderness. 4 Whereas Edom saith, We are impoverished, but we will return and build the desolate places; thus saith the LORD of hosts, They shall build, but I will throw down; and they shall call them, The border of wickedness, and, The people against whom the LORD hath indignation for ever." C) Book: Obadiah -chap 1.

29 :Saul means: KJV-Book: 1 Samuel-- chap.. 15 v 22: "... to obey is better than sacrifice," – v 28: The LORD hath rent the kingdom of Israel from thee [Saul] this day, and hath given it to a neighbour of thine, *that* is better than thou." – v 35 '... and the LORD repented that he had made Saul king over Israel.'

30 :Holy Church means: A) KJV- Book: Acts-- chap.. 1 v 4 And, being assembled together with *them*, commanded them that they should not depart from Jerusalem, but wait for the promise of the Father, which, *saith he*, ye have heard of me. 5 For John truly baptized with water; but ye shall be baptized with the Holy Ghost not many days hence. 6 When they therefore were come together, they asked of him, saying, Lord, wilt thou at this time restore again the kingdom to Israel? 7 And he said unto them, It is not for you to know the times or the seasons, which the Father hath put in his own power. 8 But ye shall receive power, after that the Holy Ghost is come upon you: and ye shall be witnesses unto me both in Jerusalem, and in all Judaea, and in Samaria, and unto the uttermost part of the earth. B) The 'Holy -Church' is the many-membered -body of :those -whosoever -will -believe -upon -the -Messiah -Yushuah, creator of the :heavens and Earth; He, who with leaving His Heavenly state, came to His Earth in the humble form of :man with humble beginnings, and who taught and demonstrated to the world the :Adam- man- kind by the will of His father: and, then-after He who died upon crucifixion for the sins of :man- kind, rose to life on the third-day, and now sits at the right-hand of :His -father -on -the -throne in :Heaven



Declaration of :i- man - :Ambassador to :Yushuah the :Messiah

Negro-remnant of :Judah of the children of :Ysrael with plunder and violation and perversity.

G – Remedy

1) Order: Receivership of the Earth-planet

:i- man declare and now accept the :duty and obligation from the Almighty- God, et seq.³¹, as :i- man -:Adam -:Ambassador of the Almighty-God with all authority for the receipt, possession and complete accounting for the real and chattel property disposed in the devotion to :Yushuah ~Jesus the Messiah~ and onto Peter³², Paul³³ and the Holy Church.

2) Duty And Obligation To The Holy -Church

:Where, as the 'Roman -Church' is Not the 'Holy Church' -body-of-believers in the Most-High-God, nor keepers of the Word-of-God, so too neither is/ was Petros~ Peter~, one :apostle of :Yushuah the :Messiah, in any way a member of the Rome -Church -:military -:church -base, except with the deception by the Roman -Church, et al., fraud. - :Thereto,

:i- man declare and accept the duty and obligation to the Holy- Church of the Messiah- Yushuah~ Jesus for whom am :i- man-Adam -:Ambassador.

3) Duty and Obligation To The Houses -of -Israel and -:Judah, et al.

The 'Holy -Church' is the many-membered -body of :those -whosoever -will -believe upon the Messiah -Yushuah, creator of the :heavens and Earth; and, who with leaving His Heavenly state, came to His Earth in the humble form of :man with humble beginnings, and who taught and demonstrated to the world the :Adam- man- kind by the will of His father³⁴~ the Most High God~, and then-after who died upon crucifixion for the sins of :man- kind, rose to life on the third-day, and now sits at the right-hand of :His -father -on the -throne in :Heaven. - :Thereto,

:i- man declare and accept the duty and obligation to the House -of -Israel and House -of -Judah from whom am :i- man- Adam - :Ambassador of :Yushuah~Jesus ~the Messiah.

4) Duty and Obligation To The Tribe of Israel as Kinsman³⁵-redeemer³⁶ for the lost

31 from the Almighty- God, et seq. means: ibid. 27

32 :Peter means: KJV- Book: 2 Peter- chap. 1 v 1 Simon Peter, a servant and an apostle of Jesus Christ, to them that have obtained like precious faith with us through the righteousness of God and our Saviour Jesus Christ: 2 Grace and peace be multiplied unto you through the knowledge of God, and of Jesus our Lord, 3 According as his divine power hath given unto us all things that pertain unto life and godliness, through the knowledge of him that hath called us to glory and virtue: 4 Whereby are given unto us exceeding great and precious promises: that by these ye might be partakers of the divine nature, having escaped the corruption that is in the world through lust. 5 And beside this, giving all diligence, add to your faith virtue; and to virtue knowledge; 6 And to knowledge temperance; and to temperance patience; and to patience godliness; 7 And to godliness brotherly kindness; and to brotherly kindness charity. 8 For if these things be in you, and abound, they make you that ye shall neither be barren nor unfruitful in the knowledge of our Lord Jesus Christ. 9 But he that lacketh these things is blind, and cannot see afar off, and hath forgotten that he was purged from his old sins. 10 Wherefore the rather, brethren, give diligence to make your calling and election sure: for if ye do these things, ye shall never fall: 11 For so an entrance shall be ministered unto you abundantly into the everlasting kingdom of our Lord and Saviour Jesus Christ.

33 :Paul means: KJV- Book: A) Acts- chap. 17 v Act 17:22 Then Paul stood in the midst of Mars' hill, and said, Ye men of Athens, I perceive that in all things ye are too superstitious. 23 For as I passed by, and beheld your devotions, I found an altar with this inscription, TO THE UNKNOWN GOD. Whom therefore ye ignorantly worship, him declare I unto you. 24 God that made the world and all things therein, seeing that he is Lord of heaven and earth, dwelleth not in temples made with hands; 25 Neither is worshipped with men's hands, as though he needed any thing, seeing he giveth to all life, and breath, and all things; 26 And hath made of one blood all nations of men for to dwell on all the face of the earth, and hath determined the times before appointed, and the bounds of their habitation; 27 That they should seek the Lord, if haply they might feel after him, and find him, though he be not far from every one of us: 28 For in him we live, and move, and have our being; as certain also of your own poets have said, For we are also his offspring. 29 Forasmuch then as we are the offspring of God, we ought not to think that the Godhead is like unto gold, or silver, or stone, graven by art and man's device. 30 And the times of this ignorance God winked at; but now commandeth all men every where to repent: 31 Because he hath appointed a day, in the which he will judge the world in righteousness by that man whom he hath ordained; whereof he hath given assurance unto all men, in that he hath raised him from the dead. B) Romans:- chap. 1 v Rom 1:1 Paul, a servant of Jesus Christ, called to be an apostle, separated unto the gospel of God, 2 (Which he had promised afore by his prophets in the holy scriptures,) 3 Concerning his Son Jesus Christ our Lord, which was made of the seed of David according to the flesh; 4 And declared to be the Son of God with power, according to the spirit of holiness, by the resurrection from the dead: 5 By whom we have received grace and apostleship, for obedience to the faith among all nations, for his name: 6 Among whom are ye also the called of Jesus Christ: 7 To all that be in Rome, beloved of God, called to be saints: Grace to you and peace from God our Father, and the Lord Jesus Christ.

34 :Adam- man- kind by the will of His father means: KJV- Book: Isaiah- chap. 58 – 61; Luke 4:

35 :Kinsman means: KJV- Book: Numbers- chap. 27 v 7 ... ye shall give his inheritance unto his kinsman that is next to him of his family, and he shall possess it: and it shall be unto the children of Israel a statute of judgment, as the LORD commanded Moses.

36 :Kinsman-redeemer means: KJV- Book: A) Exodus- chap.. 6 v 2 And God spake unto Moses, and said unto him, I am the LORD: 3 And I appeared unto Abraham, unto Isaac, and unto Jacob, by the name of God Almighty, but by my name JEHOVAH

Declaration of i- man - :Ambassador to :Yushuah the :Messiah

-Tribes -of -Ysrael. :Thereto, :i- man declare and accept the duty and obligation to/ for the lost -Tribes -of -Ysrael for whom am :i- man- Adam -Ambassador- brother -kinsman- redeemer.

5) Accounting Demand

A full-accounting of all right and property -real, chattel, and account to the penny is immediately -required, now.

Sincerely,
Without Prejudice

Darrell James Hill
:Darrell-James: Hill,
-:Executor, -:Ambassador

Affirmed and autographed before me this 24 day: July 2020 A.D.

Type of Identification: Arizona Driver License

[Signature]
Notary Public

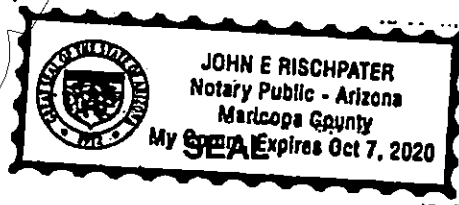

was/ not known to them. 4 And I have also established my covenant with them, to give them the land of Canaan, the land of their pilgrimage, wherein they were strangers. 5 And I have also heard the groaning of the children of Israel, whom the



Registered No. RE322387576US

Date Stamp: APACHE JUNCTION, AZ 07/24/2020

Reg. Fee	\$2.24	Return Receipt	
Handling Charge	\$16.00	Restricted Delivery	
Postage	\$4.15		
Received by	\$0.00		
Customer Must Declare Full Value \$0.00		Domestic insurance up to \$25,000 is included. On the declared value, international indemnity is limited. (See 39 CFR 301.102-9.998)	

APACHE JUNCTION
 151 W SUPERSTITION BLVD
 APACHE JUNCTION, AZ 85120-9998
 030259-0130
 (800)275-8777
 07/24/2020 02:46 PM

Product	Qty	Unit Price	Price
First-Class Intl Letter	1	\$2.24	\$2.24
International Vatican City Weight: 0 Lb 1.90 Oz			
Registered Amount: \$0.00			\$16.00
USPS Registered Mail # RE322387576US			
Return Receipt			\$4.15
Total:			\$22.39
Cash		\$50.00	
Change		(\$27.61)	

OFFICIAL USE

FROM: Darrell James Hill, Benzicorp
 PO Box 3806
 Apache Junction, Arizona 85117

TO: Jorge - Mario Bergoglio
 Apostolic Palace
 00120 Vatican City

PS Form 3806, Receipt for Registered Mail Copy 1 - Customer
 May 2007 (7530-02-000-9051) (See Information on Reverse)
 For domestic delivery information, visit our website at www.usps.com®

Due to limited transportation availability as a result of nationwide COVID-19 impacts package delivery times may be extended. Priority Mail Express® service will not change.

In a hurry? Self-service kiosks offer quick and easy check-out. Any Retail Associate can show you how.

Save this receipt as evidence of insurance. For information on filing an insurance claim go to

Completed by the office of origin. (A remplir par le bureau d'origine)	Item Description (Nature de l'envoi)	Registered Article (Envoi recommandé)	Letter (Lettre)	Printed Matter (Imprimé)	Other (Autre)	Recorded Delivery (Envoi à livraison attestée)	Express Mail International
	Insured Parcel (Colis avec valeur déclarée)	Insured Value (Valeur déclarée)	Article Number: RE 322 387 576 US				
	Office of Mailing (Bureau de dépôt)	Date of Posting (Date de dépôt): 07-24-2020					
	Address Name of Firm (Nom ou raison sociale du destinataire)	Jorge - Mario Bergoglio					
Completed at destination. (A compléter à destination)	Street and No. (Rue et No.)	Apostolic Palace					
	Place and Country (Localité et pays)	00120 VATICAN CITY					
	This receipt must be signed by: (1) the addressee; or, (2) a person authorized to sign under the regulations of the country of destination; or, (3) those regulations so provided, by the employee of the office of destination. This signed form will be returned to the sender by the first mail. (Cet avis doit être signé par le destinataire ou par une personne autorisée en vertu des règlements du pays de destination, ou, si ces règlements le comportent, par l'agent du bureau de destination, et renvoyé par le premier courrier directement à l'expéditeur.)						
<input checked="" type="checkbox"/> The article mentioned above was duly delivered. (L'envoi mentionné ci-dessus a été dûment livré.)							
Signature of Addressee (Signature du destinataire)				Date		Postmark of the office of destination (Timbre du bureau de destination)	
				Office of Destination Employee Signature (Signature de l'agent du bureau de destination)			

PS Form 2865, February 1997 (Reverse)



APACHE JUNCTION
151 W SUPERSTITION BLVD
APACHE JUNCTION, AZ 85120-9998
(800)275-8777

10/14/2020 03:47 PM

Product	Qty	Unit Price	Price
---------	-----	------------	-------

First-Class Mail® Letter	1		\$1.00
--------------------------	---	--	--------

Washington, DC 20520
Weight: 0 lb 3.30 oz
Estimated Delivery Date
Mon 10/19/2020

Registered Mail®		\$13.20
------------------	--	---------

Amount: \$21.00

Tracking #:

RE322398392US

Return Receipt		\$2.85
----------------	--	--------

Tracking #:
9590 9402 4718 8344 9618 56

Total		\$17.05
-------	--	---------

First-Class™ Intl Letter	1		\$3.28
--------------------------	---	--	--------

United Kingdom
Weight: 0 lb 3.00 oz

First-Class™ Intl Letter	1		\$3.28
--------------------------	---	--	--------

United Kingdom
Weight: 0 lb 3.00 oz

First-Class™ Intl Letter	1		\$3.28
--------------------------	---	--	--------

United Kingdom
Weight: 0 lb 3.00 oz

First-Class™ Intl Letter	1		\$3.28
--------------------------	---	--	--------

United Kingdom
Weight: 0 lb 2.90 oz

Registered		\$16.00
------------	--	---------

Amount: \$0.00

Tracking #:

RE322387593US

Return Receipt		\$4.15
----------------	--	--------

Total		\$23.43
-------	--	---------

Grand Total:		\$50.32
--------------	--	---------

Cash		\$100.00
------	--	----------

Change		(\$49.68)
--------	--	-----------

Due to limited transportation

Registered No.
RE322387593US

Postage \$	\$3.28	Extra Services & Fees (continued)	
Extra Services & Fees		<input type="checkbox"/> Signature Confirmation	
<input type="checkbox"/> Registered Mail	\$16.00	<input type="checkbox"/> Signature Confirmation Restricted Delivery	
<input type="checkbox"/> Return Receipt (hardcopy)	\$0.00		
<input type="checkbox"/> Return Receipt (electronic)	\$0.00		
<input type="checkbox"/> Restricted Delivery	\$0.00		
		Total Postage & Fees	\$19.28

Customer Must Declare Full Value	\$29.00	Received by	10/14/2020
----------------------------------	---------	-------------	------------

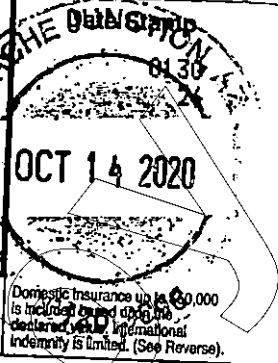

Domestic insurance up to \$50,000 is included based on the declared value. International indemnity is limited. (See Reverse).

OFFICIAL USE

To Be Completed By Customer (Please Print) All Entries Must Be In Ballpoint or Typed	FROM	APACHE JUNCTION, AZ 85120 Darrell James Hill, Amb. P.O. Box 3806 Apache Junction, Arizona 85117
	TO	Anthony Hacking, Trustee 8 Smith Square London WC1R 5ET

PS Form 3806, Registered Mail Receipt
April 2015, PSN 7530-02-000-9051
Copy 1 - Customer (See Information on Reverse)
For domestic delivery information, visit our website at www.usps.com®

USPS Tracking®

[FAQs >](#)

Track Another Package +

Track Packages Anytime, Anywhere

Get the free Informed Delivery® feature to receive automated notifications on your packages.

[Learn More](#)

(<https://reg.usps.com>)

[/xsell?app=UspTools&ref=homepageBanner&appURL=https%3A%2F%2Finformeddelivery.usps.com/box/pages/intro/start.action](#)

Tracking Number: RE322387593US

Remove X

Your item was processed through a facility in UNITED KINGDOM on October 31, 2020 at 7:40 pm. The item is currently in transit to the destination.

In-Transit

October 31, 2020 at 7:40 pm
Processed Through Facility
UNITED KINGDOM

[Get Updates](#) ▾

Text & Email Updates ▾

Tracking History ▲

October 31, 2020, 7:40 pm
Processed Through Facility
UNITED KINGDOM

Your item was processed through a facility in UNITED KINGDOM on October 31, 2020 at 7:40 pm. The item is currently in transit to the destination.

October 31, 2020, 12:46 pm
Departed
LONDON, UNITED KINGDOM

October 31, 2020, 8:54 am
Departed
TOKYO, JAPAN

October 31, 2020, 7:25 am
Departed
TOKYO, JAPAN

2022-011769 MISC Page: 1728 of 2782

09/26/2022 03:35:37 PM Receipt #: 22-9381
Rec Fee: \$30.00 Darrell James Hill
Gila County, Az, Sadie Jo Bingham, Recorder



10/31/20, 7:55 PM

Specialty Presentment: USPS RMN: RE 322 398
RE: Specialty Presentment: USPS RMN: RE: 322 387 593 US, To: Crown - Trustee
For: Report of the Completed change of Trustee;
For :Restoration of: Intangible and tangible stolen-property

1 / 1

From: Darrell-James: Hill, -:Ambassador',
PO Box 3806, Apache Junction, Arizona 85117

To: Donald-John: Trump, -:POTUSA- CIC, -:Trustee First Class Mail
1600 Pennsylvania Ave NW
Washington, District of Columbia 20500

:Michael-R.: Pompeo, :U.S.-SOS, -:Trustee
c/o :Lisa-D.: Kenna, -:Executive Secretary, -:Trustee
Office of the Secretary,
c/o: Office Of Public Liaison
Bureau Of Global Affairs
U.S. Department Of State
2201 C Street NW, Room 2206
Washington, D.C. 20520-2204

USPS RMN RE 322 398 392 US

Re: See :Specialty-Presentment :USPS -RMN -RE 322 387 593 US Regarding the:

1. :Verified -Removal of :Roman-church -Trustee-derelict, et al.- from the man -:Jorge-Mario; Bergoglio;
2. :Report of the Completed change of :Trustee-individual to the man -:Darius-Benjamin-Thummin: Hill, -Kinsman-Redeemer; with,
3. :Restoration of the Intangible and Tangible :Deprived-of and Stolen-Property to the Beneficiary -:House-of-Judah and the :Holy-church, et seq.- :i- man -Darrell-James: Hill, progeny of :Negro-Ysrael of the Children-of-Jacob, et seq.- Holy-church. ~ ~ ~ appended; 12 pages~,

to the Temple -:Crown -Trustees concerning the :matter of the Concession-1213-A.D., et seq.- DOI-1776-A.D., -:fore and after the rights, of :Negro-Ysrael, et al.- :i- man- sole and kinsman-redeemer of :same for :Negro-Ysrael, Ysrael and Holy-church of the Messiah-Yushuah, ~'Jesus'~, He, who being God, became to this planet as man, died for the atonement of the sins for all-man-kind, and now sits at the right hand of His father, the Most-High-God, in Heaven, -:the Almighty-God.

Greetings :Donald-John, :Michael-R., :Lisa-D., et al. -Office of Public Liaison,

:i- man -:Darrell-James: Hill, ambassador of the Messiah-Yushuah, am the appointed Trustee of the Concession-1213-A.D. by the Almighty-God, -:Messiah- Yushuah as is now established.

Please act accordingly.

:i- man affirm the above is true and correct, and :i- man will state :same in the open court.

Without prejudice:

:Darrell-James: Hill, ambassador of :Almighty-God, -
Trustee: Concession-of-1213-A.D.

:Ambassador means: KJV- Book: Ephesians-- chap. 6, v. 20. "For which I am an ambassador in bonds: that therein I may speak boldly, as I ought to speak."

2020 October 13 Re: RMN RE 322 398 392 US to :Michael cc: Donald
Re: Removal of :Roman-church -Trustee-derelict, et al. -:Jorge- Mario

1 / 1

2022-011769 MISC Page: 1729 of 2782
09/26/2022 09:35:37 PM Receipt #: 22-9381
Rec Fee: \$30.00 Darrell James Hill
Gila County, Az / Sadie Jo Bingham, Recorder

**Specialty Presentment: USPS RMN: RE 322 387 593 US, To: Crown – Trustee
For: Report of the Completed change of Trustee;
For :Restoration of: intangible and tangible stolen-property**

1 / 4

**From: Darrell-James: Hill¹, -i- man² -:Ohioan-©-1958 A.D.³, -:civilian⁴, -:Executor⁵ -:beneficiary⁶,
-:Ambassador⁷,
PO Box 3806, Apache Junction, Arizona 85117**

To: Temple Bar:

**:David :Richards, :The-Rt-Hon-Lord-Justice
Treasurer –
Honourable Society of Lincoln's Inn
The Treasury Office Lincoln's Inn London WC2A 3TL
London
Ph. 0207 405 1393; and,**

**:Crown-, :in- chancery,
-:Trustee**

First Class Mail

**:Brian :Leveson, :The-Rt-Hon-Sir
Treasurer
The Honourable Society of the Middle Temple
The Treasury Office
Ashley Building
Middle Temple Lane
London EC4Y 9BT
Ph. 020 7797 8250; and,**

**:Crown-, :in- chancery,
-:Trustee**

First Class Mail

**:Guy :Fetherstonhaugh, -:QC,
Treasurer
The Honourable Society of the Inner Temple,
Treasury Office,
1 Mitre Court, London EC4Y 7BS
Ph. 020 7797 8179; and,**

**:Crown-, :in- chancery,
-:Trustee**

First Class Mail

**c/o :Anthony :Harking, :BrigadierOBE
Under Treasurer
The Honourable Society of Gray's Inn
8 South Square
London
WC1R 5ET
Ph. 020 7458 7805**

**:Crown-, :in- chancery,
-:Trustee**

**:USPS -RMN -:RE 322 387
593 US**

:Specialty-Presentment :USPS -RMN -:RE 322 387 593 US Regarding the:

- 1. :Verified -Removal of :Roman-church -Trustee-derelict, et al.- from the man -:Jorge- Mario: Bergoglio;**
- 2. :Report of the Completed change of :Trustee-individual to the man -:Darius- Benjamin-Thummin: Hill, -Kinsman-Redeemer; with,**
- 3. :Restoration of the Intangible and Tangible :Deprived-of and Stolen- Property to the Beneficiary -:House-of-Judah and the :Holy-church, et seq.- :i- man -Darrell-James: Hill, progeny of :Negro-Ysrael of the Children-of-Jacob, et seq.- Holy-church.**

Greetings :David, :Brian, :Guy, :Anthony, et al.- :Barons;

:Authority of :Ambassador: from the Messiah- Yushuah

:Servant -Administrator of the Holy-Church from the House-of-Judah from the Tribe-of-Judah, -survivor of the Roman-church -annihilations -for the extinctions of :Jerusalem, Ysrael- 70 A.D. and for the :same-evil against of the Kingdom-of-Judah, -:Negroland- 1619 A.D., et seq.- unto and through the :abject-enslavement of the people of :God :in the United Colonies of :Britain by the Roman-church-Trustee- :in- collaboration, and with :daily-adminstration over the violation

2020 October 12 :Removal of :Roman-church -Trustee-derelict, et al. -:Jorge- Mario

SPS RMN: RE 322 387 593 US w/r

1 / 4

2022-011769 MISC Page: 1730 of 2782

09/26/2022 03:35:37 PM Receipt #: 22-9381

Rec Fee: \$30.00 Darrell James Hill

Gila County, Az, Sadie Jo Bingham, Recorder



**Specialty Presentment: USPS RMN: RE 322 387 593 US, To: Crown – Trustee
For: Report of the Completed change of Trustee;
For :Restoration of: intangible and tangible stolen-property**

2/4

of :Negro-Ysrael, et al.- House of Judah, and the Holy-Church, by the Roman-church- Trustee-dereliction and violation of the fiduciary-duty and obligations under the Concession-of-1213 A.D., 'Concession-1213-A.D.'- covenant- oath, duty and obligations for to absolutely protect :Ysrael and the Holy-church.~ See: 'Specialty- presentment: To The Roman -Church, et al.- Usurpers, For the Cure and Relief -in the :Equity-Claim, and For the Remedy-Required For the Trespassing Upon the Children of Ysrael/Israel, et al.'; appended: 8 pages; tacitly-acquiesced by Jorge-Mario, et al.

:Messiah- Yushuah -Ambassador: -man- Darrell-James: Hill

:i- man -Darrell-James: Hill, ambassador of the Almighty-God, am given-authority as is in this letter of :introduction by the means of the Messiah-Yushuah (':Jesus') :son of the Most-High-God, the :saviour, for :His will be done; that the House of Judah and the Holy-church will now receive the :offer-now-accepted ~ from the Concession-of-1213 -A.D. to the Messiah, Peter, Paul and Holy-church~ 1) by :i- man -:Darius-Benjamin-Thummin -named by :God- :echad, and known by the appellation :Darrell-James: Hill, -:Negro-Ysrael, -:Ohioan-©-1958 A.D., son of Clarence, ... son of Israel, Isaac, Abraham, ... Shem, Noah, ... son of Adam- son of the Creator-Jehovah; and, 2) by the atonement by :Yushuah the :Messiah, who came to this Earth, died for the sins of :all- mankind, and for the remission of :sin for :those -whosoever will-accept the :free-gift offered to the life-eternal :in and through the Messiah- :Yushuah, the Almighty-God, the only-begotten :Son of the Most High God.

:Property Retained And Claimed by the Tribe of Judah, et al.- Holy-church:

For the Concession-1213-A.D. by :John- I, to the Messiah, Peter, Paul and the Holy-church, et seq., so stands the :covenant to :i- man, ambassador, kinsman-redeemer, Trustee, :man- Darrell-James: Hill.

:Usurper -:Trespassing; -- the :Un-Holy -Roman-Church, -:Trustee- Dereliction:

:i- man- ambassador am instructed as is now :completed to you by :this-notice for the restoration of the Concession-1213-A.D., et seq., no-longer held by the Roman-church- Trustee-derelict, et al.- :man -:Jorge-Mario: Bergoglio of the un-holy- Roman-church who did also internationally, expressively and overtly-abdicate the :Trustee Oath and fiduciary-duty and obligations to the Concession-1213-A.D., et al.,- with the violation of the fiduciary- duty and obligations by the Roman-church -Trustee -derelict, et seq.- by the man entitled: Pope: Innocent: 1213 A.D., et seq.- unto the man appellated: Jorge-Mario: Bergoglio: 2020 A.D. Thereto: see the Order appended; and: see: www.twitter.com/@DarBenThu1.

:Holy-church -Property Holded and Held by Roman-church-Trustee- Fraud:

Unto you sirs, et al., :administrative-fidelity is now required by :i- man to make aright the/your duty and obligation to the Concession-of -1213 -A.D. -:in-chancery, et seq., that :all property and possessions-of and/or derivative-of or from the Concession-of-1213-A.D., of: England and Ireland holded; and, of :all property presently-held and/or to be held by the consequence of the acceptance of the Concession-1213-A.D. is servered from the Roman-church :in- disgrace.

Now-to-fore and after, the presentment of the :any- administrative- authority from the Roman-church upon or by or through :your-any- actions to minister the :Concession-of-1213-A.D. Is strictly forbidden. -- Thereto, :i- man authorize only bread, water and humble lodging until further notice:

No expense for the any-sundry needs are authorized;

No distributions are permitted from the related Concession-1213-A.D.-:property.

No agreement, presentment or presentation is permitted by the Roman-church as the "Holy-church", nor other, as related-to or bearing-upon the Concession-1213-A.D. -duty and obligations to the House of Ysrael and/or the Holy-church of the Almighty-God, -:Yushuah the :Messiah.

:All-agreements now-to-fore are subject to revision due to the Roman-church dereliction of oath, duty and obligations. :All-actions and agreements are heretow and after subject to repair for the damage-done by the Roman-church.

Further, now to after, :all Roman-church actions are :solely- private and non-binding upon the

2020 October 12 :Removal of :Roman-church -Trustee-derelict, et al. -:Jorge- Mario

USPS RMN: RE 322 387 593 US w/rr

2/4

2022-011769 MISC Page: 1731 of 2782

09/28/2022 03:35:37 PM Receipt #: 22-9381

Rec Fee: \$30.00 Darrell James Hill

Gila County, AZ, Sadie Jo Bingham, Recorder



**Specialty Presentment: USPS RMN: RE 322 387 593 US, To: Crown – Trustee
For: Report of the Completed change of Trustee;
For :Restoration of: intangible and tangible stolen-property**

3 / 4

upon the :any- obligation upon the Concession-1213-A.D., et seq. -:beneficiaries or property.

WARNING: :All and any further :Roman-church :presumptive-performance as the 'Trustee' by any means as relates to the Concession-1213-A.D., et seq., must be recognized as :international- fraud by the criminal- usurpation and violation of the Concession-1213-A.D. covenant heretofore and now-after.

Restoration of :All- Property is Required and Demanded Restored:

Unto you sirs, et al., upon the receipt of the matter in this Notice, :the :Roman-church is already-formally removed as Trustee to the Concession-1213-A.D. by this acceptance by the ambassador from the Almighty-God -:man- Darrell-James: Hill.

:Notice by :i- man, -:Trustee of the Concession-1213-A.D. is by :this -notice completed by the authorized- ambassador of the Messiah- Yushuah, :Darrell-James: Hill.

:Crown- :Trustees- :in- Chancery

:Your receipt of the matter of this :Specialty-Presentment requires that :you must set this :claim and determination by :i- man -:ambassador -:Darrell-James: Hill, Trustee of the Concession-1213-A.D., upon the Roman-church- derelict, et al. -:man, -:Jorge-Mario: Bergoglio with the copy to :i- man, affirming :in the Crown- by- :chancery acknowledgment of the ambassador of the Messiah-Yushuah, -assignee: Darrell-James: Hill.

Accounting:

The :complete -:accounting to the penny of :all -property and records is now-required post-haste by :i- man, -ambassador, -:Trustee, by secured-delivery to the address provided.

Security:

Absolute bio-physical and body- security for :i- man, -ambassador is now required, ordered, and must be completed post-haste with :your, et al. -notification of :same- requirement upon the 'Secretary of State -:United States where on the united States of America :i- man now habitate.

cc:

:Donald-John: Trump, -:POTUSA- CIC, -:Trustee
1600 Pennsylvania Ave NW
Washington, District of Columbia 20500

First Class Mail

:Michael-R.: Pompeo, :U.S.-SOS, -:Trustee
c/o :Lisa-D.: Kenna, -:Executive Secretary, -:Trustee
Office of the Secretary,
c/o: Office Of Public Liaison
Bureau Of Global Affairs
U.S. Department Of State
2201 C Street NW, Room 2206
Washington, D.C. 20520-2204

USPS RMN RE 322 398 392 US

:i- man affirm the :above is true and correct, and :i- man will state :same in the open court.

Without prejudice:

Darrell-James Hill, Ambassador
:Darrell-James: Hill, ambassador of :Almighty-God, -
Trustee: Concession-of-1213-A.D.

Affirmed and autographed before :Notary-Public :this 13th day, October- 2020 A.D.

:Notary-Public

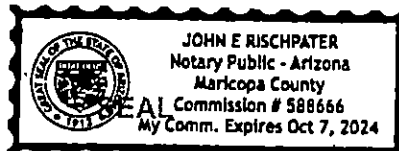

2020 October 12 :Removal of :Roman-church -Trustee-derelict, et al. -:Jorge- Mario
USPS RMN: RE 322 387 593 US w/lr

3 / 4

2022-011769 MISC Page: 1732 of 2782
09/26/2022 03:35:37 PM Receipt #: 22-9961
Rec Fee: \$30.00 Darrell James Hill
Gila County, Az, Sadie Jo Bingham, Recorder

- 1 **:Darrell-James: Hill means:** Earthen -:man-child, :birthed :son of :Clarence, :son of :James, :son :Negroland, :Kingdom-of-Judah, :Africa', ...:son :Ysrael- :Southern-Kingdom ~ of the sons :Judah and Benjamin and Levi, et al.~, ...:son of :Jacob and :Ysrael, :son of :Isaac, :son of :Abram and :Abraham, ...:son of :Shem, :son of :Noah, ...:son of :Methuselah, :son of :Enoch, ...:son of :Seth, :son of :Adam with :Eve of the garden of :Eden ~ including all :known and unknown :ancestral- lands ~ on the earth placed under the Adamic- lineage and under the :only-begotten -son of the Most-High-God and Father embodied within the rebirth by :i- man of the power of :Yushuah-Messiah, -:God, with the redemption by the Messiah- Yushuah (':Jesus-the-Christ'), and encompassing the :receivership, responsibility and administration over :all of the earth-planet as :heir - :remainderman, and :Kinsman- :redeemer of the Earth, both 1) from the Adamic-lineage by the :loss in :spirit in the man upon the Earth, and 2) by the Messiah-Yushuah by the restoration in the Holy Spirit in :i- man upon the Earth: on, in or under-the-surface of the planet; :on, in or under-the-surface of the oceans and waters, and :on, in, under-the-surface of the atmosphere/ above the atmosphere of the Earth to wherever the :Adamic- :man -kind in the quantum and in the spirit is now, of :where the :purposes of the Most High God and Father are immeasurable by mere :man. No-thing Stands between the Almighty God~ His Father; See: KJV- Book: Daniel -chap. 7 v. 9 - 14.~ and :i-man.
- 2 **:i- man means:** 'i' is the Great :i am, :Almighty--God and :Creator of all and 'man-kind', -:in the image of the Almighty God and His Father, the :Ancient-of-Days -- the Most-High-God. Ibid 1, et seq.
- 3 **:Ohioan- © -1958 A.D. Means:** as appellated in :common-law, birthed on the United-Colonies, et seq.- Ohio: 1958.
- 4 **:civilian means:** non-combatant, non-belligerent with the Almighty-God -given unalienable rights :inhabitant of the land-trust.
- 5 **:Darrell-James: Hill means:** :Darrell-James: Hill means: Darrell-James: Hill © 1958 A.D.: Ohioan- © -1958 A.D.: State of Ohio: beneficiary. See: Gila county Arizona: Doc. # 2017-002378: pp. 6-24, 89-91,93-95 of 693. Gila county Arizona: Doc. # 2018-005176: pp. 10-21; and, et seq.: beneficiary of the Cestui Que Trustee-minister: Jorge-Mario: Bergoglio
- 6 **:beneficiary means:** the individual -spirit, soul, quantum -amalgam to an for whom the trust is created, and for whom the trustee-actors labor to assure cestui-que-use.
- 7 **:Ambassador means:** KJV- Book: Ephesians--- chap. 6, v. 20. "For which I am an ambassador in bonds: that therein I may speak boldly, as I ought to speak."

Unofficial

1732

Declaration of :-i- man - :Ambassador to :Yushuah the :Messiah

From :Darrell-James: Hill¹, :-i- man², -:civilian, -:Executor³, -:Ambassador⁴,
PO Box 3806, Apache Junction, Arizona 85117

:man -:present,

:The united States of America,

Arizona state
Pinal county

To :Jorge-Mario: Bergoglio⁵ ~:USPS RMN RE 322 387 576 US
c/o Apostolic Palace
00120 Vatican City^{6 7}
c/o :Donald-John :CIC- :Trump^{8 9} :USPS RMN RE 322 387 562 US
1600 Pennsylvania Ave NW
Washington, District of Columbia 20500

**Specialty- Presentment: To The Roman -Church¹⁰, et al.- Usurpers,
For the Cure and Relief -in the :Equity-Claim, and For the Remedy-Required
For the Trespassing Upon The Children of Ysrael/Israel, et al.**

Greetings :Jorge-Mario, :Donald-John, et al.,

With all due respect, :-i- man am to declare this to you by :order of the Messiah
Yushuah~Jesus~ God-Almighty. You must let All of the people of the Most-High-God
go free unharmed with all of their belongings and with the full-accounting of their
property and chattel. To :this- end, :-i- man must declare to you:

A – :Declaration: i- man am: Judah of: Ysrael

:i- man declare 1) the :embodiment of :i-man- Adam¹¹ within the oneness with the
Almighty- Creator -:God with the man :Jacob~ Ysrael¹², son of :Isaac¹³ the :brother of

1 :Darrell-James: Hill means: Earthen :-man-child, :birthed :son of :Clarence, :son of :James, :son 'Negroland, :Kingdom-of-
Judah, :Africa', ...:son :Ysrael- :Southern-Kingdom ~ of the sons :Judah and Benjamin and Levi, et al., ...:son of :Jacob and
:Ysrael, :son of :Isaac, :son of :Abram and :Abraham, ...:son of :Shem, :son of :Noah, ...:son of :Methuselah, :son of
:Enoch, ...:son of :Seth, :son of :Adam with :Eve of the garden of :Eden ~ including all :known and unknown :ancestral- lands ~
on the earth placed under the :Adamic- lineage and under the :only-begotten -son of the Most-High-God and Father embodied
within the rebirth by :-i- man of the power of :Yushuah-Messiah, -:God, with the redemption by the Messiah- Yushuah ('Jesus-
the-Christ'), and encompassing the :receivership, responsibility and administration over :all of the earth-planet as :their -
:remalnderman, and :Kinsman- :redeemer of the Earth, both 1) from the Adamic-lineage by the :loss in :spirit in the man upon
the Earth, and 2) by the Messiah-Yushuah by the restoration in the Holy Spirit in :-i- man upon the Earth: on, in or under-the-
surface of the planet, :on, in or under-the-surface of the oceans and waters, and :on, in, under-the-surface of the atmosphere/
above the atmosphere of the Earth to wherever the :Adamic- :man -kind in the quantum and in the spirit is now, of :where the
:purposes of the Most High God and Father are immeasurable by mere :man. No-thing Stands between the Almighty God~ His
Father; See: KJV- Book: Daniel -chap. 7 v 9 – 14.~ and :-i-man.
:-i- man means: 'I' is the Great :i am, Almighty God Creator of all and for whom all is; 'man' is the kind on this Earth- world, made
in the image of the Almighty God and His Father, the :Ancient-of-Days – the Most-High-God
:Darrell-James: Hill means: :Darrell-James: Hill means: Darrell-James: Hill © 1958: Ohioan, © 1958: State of Ohio:
beneficiary. See: Gila county Arizona: Doc. # 2017-002378: pp. 6-24, 89-91, 93-95 of 693. Gila county Arizona: Doc. # 2018-
005176: pp. 10-21; and, et seq.: beneficiary of the Cestui Que Trustee-minister: Jorge-Mario: Bergoglio55
:Ambassador means: KJV- Book: Ephesians--- chap.. 6, v. 20. "For which I am an ambassador in bonds: that therein I may
speak boldly, as I ought to speak."
:Jorge-Mario: Bergoglio means: man-kind of the Earth-planet
:Babylon- Rome means: KJV- Book :Daniel -chap. 2, v. 40 – 43.
:Rome means: KJV- Book: Obadiah-- chap. 1; Psalms— chap.. 83.
:Donald-John: Trump means: man -:trustee under the duty, obligation and moral~Oath of Office: 20th day of January, the year
our Lord 2020 A.D.~, ministry: as :President of The united states of America' ~unincorporated, 1776 A.D.- as 'Commander-in-
Chief with the :General Order 100 ~Lieber Code- :24th day, April, the year of our Lord 1863 A.D: under the Declaration of
Independence for the united states of America -people by 'The Constitution for the United States of America' .
:Donald-John: Trump means: man-kind of the Earth-planet, :man -:trustee under the duty, obligation and moral~Oath of Office
:Roman -Church means: the polytheism government methodology contrived and implemented from the 4th century A.D. by the
Roman Emperor Constantine.
:Adam means: within the oneness with the Almighty- Creator -:God. See: KJV- Book: Genesis- chap. 2
:Jacob~ Ysrael means: covenant of :God-Almighty and :Jacob means: KJV- Book: Genesis- chap 26 v 34 – Genesis- chap
31 v 29.
:Isaac means: covenant of :God-Almighty and Issac means: KJV- Book: Genesis— chap.. 17 v 15 And God said unto

2022-011769 MISC
09/26/2022 03:35:37 PM
Rec Fee: \$30.00
Gila County, Az, Sadie Jo Bingham, Recorder
Page: 1734 of 2782
Receipt #: 22-9381
Darrell James Hill
James Hill
Darrell James Hill
James Hill
Sadie Jo Bingham, Recorder

Declaration of :-i- man - :Ambassador to :Yushuah the :Messiah

:Ishmael¹⁴, sons of :Abram ~Abraham¹⁵, ...son of :Shem, ...son of: Noah¹⁶, ...son of Methuselah, ...son of :Adam; and, 2) :-i- man- Adam declare that :-i- man -:Negro¹⁷ am yet upon The united states of America a) :Judah of the people of Ysrael of the man :Jacob, and that :-i- man am b) spiritually :Adam -of -Ysrael¹⁸ by the blood of the Messiah: Yushuah ~'Christ Jesus' ~ the : Almighty God~, by His Father's will be done.¹⁹ Thereto: No-thing Stands between the :Almighty God~ who is in oneness with His Father²⁰ and :-i-man-²¹ :Darrell-James: Hill.

B - :-i- man -:Adam Believe with :Faith in the Creator -:Almighty- God -:Statement

1. :-i- man believe in the Creator-Almighty-God as characterized in the wise by the equations:

- a) $0 + 0 = 0$, et seq., where "0" is the absolutely empty set; where
- a.i.) "0" is the only moral -truth -set; that is, nothing plus nothing equals nothing;

Abraham, As for Sarai thy wife, thou shalt not call her name Sarai, but Sarah shall her name be. 16 And I will bless her, and give thee a son also of her: yea, I will bless her, and she shall be a mother of nations; kings of people shall be of her. 17 Then Abraham fell upon his face, and laughed, and said in his heart, Shall a child be born unto him that is an hundred years old? and shall Sarah, that is ninety years old, bear? 18 And Abraham said unto God, O that Ishmael might live before thee! 19 And God said, Sarah thy wife shall bear thee a son indeed; and thou shalt call his name Isaac: and I will establish my covenant with him for an everlasting covenant, and with his seed after him.

14 :-i- brother -:Ishmael means: covenant of :God-Almighty and Ishmael means: KJV- Book: Genesis-- chap.. 17 (a) v 9 And God said unto Abraham, Thou shalt keep my covenant therefore, thou, and thy seed after thee in their generations. 10 This is my covenant, which ye shall keep, between me and you and thy seed after thee; Every man child among you shall be circumcised. ... 11 And ye shall circumcise the flesh of your foreskin; and it shall be a token of the covenant betwixt me and you. 12 And he that is eight days old shall be circumcised among you, every man child in your generations, he that is born in the house, or bought with money of any stranger, which is not of thy seed. 13 He that is born in thy house, and he that is bought with thy money, must needs be circumcised: and my covenant shall be in your flesh for an everlasting covenant. 14 And the uncircumcised man child whose flesh of his foreskin is not circumcised, that soul shall be cut off from his people; he hath broken my covenant. ... 18 And Abraham said unto God, O that Ishmael might live before thee! 19 And God said, Sarah thy wife shall bear thee a son indeed; and thou shalt call his name Isaac: and I will establish my covenant with him for an everlasting covenant, and with his seed after him. 20 And as for Ishmael, I have heard thee: Behold, I have blessed him, and will make him fruitful, and will multiply him exceedingly; twelve princes shall he beget, and I will make him a great nation. ... 23 And Abraham took Ishmael his son, and all that were born in his house, and all that were bought with his money, every male among the men of Abraham's house; and circumcised the flesh of their foreskin in the selfsame day, as God had said unto him. 24 And Abraham was ninety years old and nine, when he was circumcised in the flesh of his foreskin. 25 And Ishmael his son was thirteen years old, when he was circumcised in the flesh of his foreskin. 26 In the selfsame day was Abraham circumcised, and Ishmael his son.

15 :Abram ~Abraham means: covenant of God-Almighty and Abram ~Abraham means: KJV- Book: Genesis-- chap.. 17 (a) v 1 And when Abram was ninety years old and nine, the LORD appeared to Abram, and said unto him, I am the Almighty God; walk before me, and be thou perfect. 2 And I will make my covenant between me and thee, and will multiply thee exceedingly. 3 And Abram fell on his face: and God talked with him, saying, 4 As for me, behold, my covenant is with thee, and thou shalt be a father of many nations. 5 Neither shall thy name any more be called Abram, but thy name shall be Abraham; for a father of many nations have I made thee. (b) 6 And I will make thee exceeding fruitful, and I will make nations of thee, and kings shall come out of thee. (c) 7 And I will establish my covenant between me and thee and thy seed after thee in their generations for an everlasting covenant, to be a God unto thee, and to thy seed after thee. 8 And I will give unto thee, and to thy seed after thee, the land wherein thou art a stranger, all the land of Canaan, for an everlasting possession; and I will be their God. 9 And God said unto Abraham, Thou shalt keep my covenant therefore, thou, and thy seed after thee in their generations. 10 This is my covenant, which ye shall keep, between me and you and thy seed after thee; Every man child among you shall be circumcised. (d1/2) 11 And ye shall circumcise the flesh of your foreskin; and it shall be a token of the covenant betwixt me and you. 12 And he that is eight days old shall be circumcised among you, every man child in your generations, he that is born in the house, or bought with money of any stranger, which is not of thy seed. 13 He that is born in thy house, and he that is bought with thy money, must needs be circumcised: and my covenant shall be in your flesh for an everlasting covenant. 14 And the uncircumcised man child whose flesh of his foreskin is not circumcised, that soul shall be cut off from his people; he hath broken my covenant. (e) 15 And God said unto Abraham, As for Sarai thy wife, thou shalt not call her name Sarai, but Sarah shall her name be. 16 And I will bless her, and give thee a son also of her: yea, I will bless her, and she shall be a mother of nations; kings of people shall be of her. 17 Then Abraham fell upon his face, and laughed, and said in his heart, Shall a child be born unto him that is an hundred years old? and shall Sarah, that is ninety years old, bear? (f) 18 And Abraham said unto God, O that Ishmael might live before thee! (g1/2) 19 And God said, Sarah thy wife shall bear thee a son indeed; and thou shalt call his name Isaac: and I will establish my covenant with him for an everlasting covenant, and with his seed after him. (h) 20 And as for Ishmael, I have heard thee: Behold, I have blessed him, and will make him fruitful, and will multiply him exceedingly; twelve princes shall he beget, and I will make him a great nation. (g2/2) 21 But my covenant will I establish with Isaac, which Sarah shall bear unto thee at this set time in the next year. (i) 22 And he left off talking with him, and God went up from Abraham. (j) 23 And Abraham took Ishmael his son, and all that were born in his house, and all that were bought with his money, every male among the men of Abraham's house; and circumcised the flesh of their foreskin in the selfsame day, as God had said unto him. 24 And Abraham was ninety years old and nine, when he was circumcised in the flesh of his foreskin. 25 And Ishmael his son was thirteen years old, when he was circumcised in the flesh of his foreskin. 26 In the selfsame day was Abraham circumcised, and Ishmael his son. 27 And all the men of his house, born in the house, and bought with money of the stranger, were circumcised with him.

6 :Noah means covenant of God-Almighty and Noah means: KJV- Book: Genesis-- chap.. 9 v 8 And God spake unto Noah, and to his sons with him, saying, 9 And I, behold, I establish my covenant with you, and with your seed after you; 10 And with every living creature that is with you, of the fowl, of the cattle, and of every beast of the earth with you; from all that go out of the ark, to every beast of the earth. 11 And I will establish my covenant with you; neither shall all flesh be cut off any more by the waters of a flood; neither shall there any more be a flood to destroy the earth. 12 And God said, This is the token of the covenant which I make between me and you and every living creature that is with you, for perpetual generations: 13 I do set my bow in the cloud, and it shall be for a token of a covenant between me and the earth. 14 And it shall come to pass, when I bring a cloud over the earth, that the bow shall be seen in the cloud: 15 And I will remember my covenant, which is between me and you and every living creature of all flesh; and the waters shall no more become a flood to destroy all flesh. 16 And the bow shall be in the cloud; and I will look upon it, that I may remember the everlasting covenant between God and every living creature of all flesh that is upon the earth. 17 And God said unto Noah, This is the token of the covenant, which I have established between me and all flesh that is upon the earth. 18 And the sons of Noah, that went forth of the ark, were Shem, and Ham, and Japheth: and Ham is the father of Canaan.

17 :Negro means: son of the Southern-Kingdom -of -Ysrael; enslaved by the Trustee-minister of the Magna Carta, et al.- Usurpers
18 :Adam of :Ysrael means: KJV- Book: A) Romans- chap. 5 v 12 Wherefore, as by one man sin entered into the world, and

2022-011769 MISC Page: 1735 of 2782
09/26/2022 03:35:37 PM Receipt # 22-9981
Rec Fee: \$30.00 Darrell James Hill
Gila County, Az, Sadie Jo Bingham, Recorder

Declaration of :i- man - :Ambassador to :Yushuah the :Messiah

and:

- b) $0 + 1 = 1$, et seq., where "1" is the presence of the substance of the set of characteristics; that is, nothing plus :1 -:something equals :1 -:something; where b.i.) "1" is the only moral -truth -set;

and,

- c) where the inverse of truth is characterized by the equations:
 - c.i) $0 + 0 = X$ -set where the untruth is the any 'set of X', except the "0" truth,

and

where

- c.ii) $0 + 1 = Y$ -set where the untruth is the any 'set of Y', except the "1" truth.

Where-as: all -that -is -created in the worlds of the universes has origin in the sum of the sets of characteristics expressed within :a), b) and c)' with the intelligent- design by the Almighty-God with His Father, the :Most-High-God.

2. :i- man believe that :man -kind is the indivisible corporation of the spiritual faculties of the spirit and soul components joined into the original-intelligence- live- earthen-product by the Creator-God's design. And:

3. :i- man believe that man -kind's now-fallen-state diverged from the Creator-Gods' baseline design of :man- kinds' first estate -in -:oneness -with -:God; that, :man-kind's baseline -normal is in :oneness with the Most-High-God;

Where-as, that the act-of-repentance, -changing and turning toward God's law is by the exercise of the spiritual faculties toward :oneness -with -:God, repentance is the :foundation of :man-kinds' :spiritual-joy, physical-happiness, and :gladness with :abundance in :well-being ²².

C - :NOTICE:

Purgatory Oath: Lateness Of This Presentment

:i-man Affirm and Declare That The 'lateness Of This Presentment' Is Due To The Lack Of Knowledge And Ignorance Of :i-man; and, the :Trust -resources to afford the cost of this pursuit have been a) administered without authorization and b) used to impose harm and competition against :i-man -:beneficiary, et al.- children of Ysrael.

For the fact that :i-man- Adam, et al.- Judah, have been systematically -systemically -oppressed with the brutality-imposed -ignorance and assurance unto the lack of knowledge from the confederate- usurpers since on or before 1600 A.D. unto now ~2020 A.D.~ with the oversight and support for these and other harms by the Roman-Church -Usurper-Trustee -gross -malfeasance. Thereto, :i- man believe that this presentment is timely through the four centuries upon the historical accounts and recorded facts of the murder-for- annihilation for the extinction²³, and the continued abject- hostility upon :i- man, et al. - members of the House of Ysrael by the :absolute-malfeasance²⁴ of the pure -obligation²⁵ by the "Roman -Church", et al.- confederate :impostors.

death by sin; and so death passed upon all men, for that all have sinned: 13 (For until the law sin was in the world: but sin is not imputed when there is no law. 14 Nevertheless death reigned from Adam to Moses, even over them that had not sinned after the similitude of Adam's transgression, who is the figure of him that was to come. B) 1 Corinthians-- chap.. 15 v 21 For since by man *came* death, by man *came* also the resurrection of the dead. 22 For as in Adam all die, even so in Christ shall all be made alive. 23 But every man in his own order: Christ the firstfruits; afterward they that are Christ's at his coming. 24 Then *cometh* the end, when he shall have delivered up the kingdom to God, even the Father; when he shall have put down all rule and all authority and power. 25 For he must reign, till he hath put all enemies under his feet. 26 The last enemy *that* shall be destroyed *is* death, C) 1 Corinthians-- chap.. 15 v 42 So also *is* the resurrection of the dead. It is sown in corruption; it is raised in incorruption: 43 It is sown in dishonour; it is raised in glory: it is sown in weakness; it is raised in power: 44 It is sown a natural body; it is raised a spiritual body. There is a natural body, and there is a spiritual body. 45 And so it is written, The first man Adam was made a living soul; the last Adam *was made* a quickening spirit.

9 :Father's will be done] means: KJV- Book: Mark-- chap.. 14 v. 32-36.
10 :Almighty God~ who is in oneness with His Father means: KJV- Book: John -chap 17

11 Ibid.

12 :abundance in :well-being means: KJV- Book :Hebrews- chap 5 and 6.

13 :murder-for- annihilation for the extinction means: KJV- a) Book: Psalms 83. ; b) Book: Obadiah -chap 1.

14 :absolute- malfeasance means: contracts, torts. The unjust performance of some act which the party had no right, or which he had contracted not to do.

15 :pure -obligation means: tie which binds us to pay or to do something agreeably to the laws and customs of the country in which the obligation is made.



Declaration of :i- man - :Ambassador to :Yushuah the :Messiah

D – :Wrong-doing: Roman -Church -Trespassing Upon The :Children -Of -Ysrael

:Roman -Church Fraud

:i- man declare that for the last four-hundred ~400~ years or more that the annihilation with the :murders upon the House of Judah of :Ysrael unto the abject enslavement onto the American-continent, et al.- "Egypt"²⁶ is commonly known and well documented within the records of the decisions with the violations of the fiduciary -duty and obligation by the :non- Christian -rulers of the Roman -Church -:military -:church -regime until now. See: Magna Carta²⁷. – :Thereto, that :fraud vitiates, a) the equation of the fraud is fraud in :fact from the beginning, and, b) Where as, the Roman- Church is established in fraud as an impostor then the any :Roman -Church- :papal- infallibility is merely impossible.

E – Faux- Nobility of :Esau²⁸ with :Saul²⁹, et al.- Roman -Church Identity Theft

:i- man know and believe that as :Nothing is new under the sun, so again was Satan's use of the :pagen-rulers of :Rome akin to :King Herod's oppression directly upon the infant -:Yushuah, and unto Rome's, et al's, callous deeds surrounding the immoral :sacrifice of the adult -:Yushuah~ the :lamb of the Most-High-God~; so now- again after nearly :two-thousand~2000~ years ought the Roman -Church, et al., choose life through the :repentance, changing and turning afforded to :all and them by the Messiah -:Yushuah~ Jesus-the-Christ – Almighty-God~, the :lamb of the Most-High-God.

:i- man believe that the faux- nobility amalgam of Saul with Esau, et al.- Roman -Church -:military- :church -regime -:lineage has for many centuries opportunistically and tyrannically promoted :itself to the world with the deception that either bloodline is a) in the line of the succession of the children of Jacob/Ysrael, or, that b) :either has acted in the righteous -keeping of the commandments of the Almighty-God before the billions of :soul- witnesses sojourning on Almighty-God's Earth.

F – Coveting Is Now Fraud

- a) :i- man believe that for the coveting of the office of :Jacob~Ysrael that the 'Roman -Church', et al., passes-itself -off/passed-itself -off to the world as the "Holy Church"³⁰ .;
- b) Both :Esau and :Saul remain complicit in the fraud and are historically unfit to lead the "Holy -Church" as a matter of :common - biblical- knowledge as adjudged by the Almighty-God;
- c) The :Roman -Church to day remains unrepentant of the fiduciary-violations with the aiding, abetting, and condoning the continued brutal enslavement- for-annihilation of the

26 "Egypt" means: KJV- Book: Deuteronomy- chap 28 v 64 -68.

27 :Magna Carta 1215, A.D. means: a) Magna Carta, 1215 A.D. by: b) the :King John I, :Concession of England To The Pope, 1213 A.D., "We wish it to be known to all of you, through this our charter, furnished with our seal, that inasmuch as we had offended in many ways God and our mother the holy church, and in consequence are known to have very, much needed the divine mercy, and can not offer anything worthy for making due satisfaction to God and to the church unless we humiliate ourselves and our kingdoms-we, wishing to humiliate ourselves for Him who humiliated Himself for us unto death, the grace of the Holy Spirit inspiring, not induced by force or compelled by fear, but of our own good and spontaneous will and by the common counsel of our barons, do offer and freely concede to God and His holy apostles Peter and Paul and to our mother the holy Roman church, and to our lord pope Innocent and to his Catholic successors, the whole kingdom of England and the whole kingdom Ireland with all their right and appurtenances...." administered by c) the 'Crown Temple' in the receipt of the Crown In Chancery understanding common law.

28 :Esau means: KJV- Book: A) Genesis- chap., 25 v 34; "... Esau despised his birthright."; B) Book: Romans 9:13 As it is written, Jacob have I loved, but Esau have I hated. ~ KJV- Book: Malachi- chap. 1 v 2 ... Was not Esau Jacob's brother? saith the LORD: yet loved Jacob, 3 And I hated Esau, and laid his mountains and his heritage waste for the dragons of the wilderness. 4 Whereas Edom saith, We are impoverished, but we will return and build the desolate places; thus saith the LORD of hosts, They shall build, but I will throw down; and they shall call them, The border of wickedness, and, The people against whom the LORD hath indignation for ever." C) Book: Obadiah -chap 1.

29 :Saul means: KJV-Book: 1 Samuel- chap., 15 v 22: "... to obey is better than sacrifice," – v 28: "..., The LORD hath rent the kingdom of Israel from thee [Saul] this day, and hath given it to a neighbour of thine, that is better than thou." – v 35 '... and the LORD repented that he had made Saul king over Israel."

30 :Holy Church means: A) KJV- Book: Acts- chap., 1 v 4 And, being assembled together with them, commanded them that they should not depart from Jerusalem, but wait for the promise of the Father, which, saith he, ye have heard of me. 5 For John truly baptized with water; but ye shall be baptized with the Holy Ghost not many days hence. 6 When they therefore were come together, they asked of him, saying, Lord, wilt thou at this time restore again the kingdom to Israel? 7 And he said unto them, It is not for you to know the times or the seasons, which the Father hath put in his own power. 8 But ye shall receive power, after that the Holy Ghost is come upon you: and ye shall be witnesses unto me both in Jerusalem, and in all Judaea, and in Samaria, and unto the uttermost part of the earth. B) The 'Holy -Church' is the many-membered -body of :those -whosoever -will -believe -upon -the -Messiah -Yushuah, creator of the :heavens and Earth; He, who with leaving His Heavenly state, came to His Earth in the humble form of :man with humble beginnings, and who taught and demonstrated to the world the :Adam- man- kind by the will of His father: and, then-after He who died upon crucifixion for the sins of :man- kind, rose to life on the third-day, and now sits at the right-hand of :His -father -on -the -throne in :Heaven

Declaration of :i- man - :Ambassador to :Yushuah the :Messiah

Negro-remnant of :Judah of the children of :Ysrael with plunder and violation and perversity.

G – Remedy

1) Order: Receivership of the Earth-planet

:i- man declare and now accept the :duty and obligation from the Almighty- God, et seq.³¹, as :i- man -:Adam -:Ambassador of the Almighty-God with all authority for the receipt, possession and complete accounting for the real and chattel property disposed in the devotion to :Yushuah ~Jesus the Messiah~ and onto Peter³², Paul³³ and the Holy Church.

2) Duty And Obligation To The Holy -Church

:Where, as the :'Roman -Church' is Not the 'Holy Church' -body-of-believers in the Most-High-God, nor keepers of the Word-of-God, so too neither is/ was Petros~ Peter~, one :apostle of :Yushuah the :Messiah, in any way a member of the Rome -Church -:military -:church -base, except with the deception by the Roman -Church, et al., fraud. -:Thereto,

:i- man declare and accept the duty and obligation to the Holy- Church of the Messiah- Yushuah~ Jesus for whom am :i- man-Adam -:Ambassador.

3) Duty and Obligation To The Houses -of -Israel and -:Judah, et al.

The 'Holy -Church' is the many-membered -body of :those -whosoever -will -believe upon the Messiah -Yushuah, creator of the :heavens and Earth; and, who with leaving His Heavenly state, came to His Earth in the humble form of :man with humble beginnings, and who taught and demonstrated to the world the :Adam- man- kind by the will of His father³⁴~ the Most High God~, and then-after who died upon crucifixion for the sins of :man- kind, rose to life on the third-day, and now sits at the right-hand of :His -father -on the -throne in :Heaven. -:Thereto,

:i- man declare and accept the duty and obligation to the House -of -Israel and House -of -Judah from whom am :i- man-Adam - :Ambassador of :Yushuah~Jesus ~the Messiah.

4) Duty and Obligation To The Tribe of Israel as Kinsman³⁵-redeemer³⁶ for the lost

31 from the Almighty- God, et seq. means: *ibid.* 27

32 :Peter means: KJV- Book; 2 Peter- chap. 1 v 1 Simon Peter, a servant and an apostle of Jesus Christ, to them that have obtained like precious faith with us through the righteousness of God and our Saviour Jesus Christ: 2 Grace and peace be multiplied unto you through the knowledge of God, and of Jesus our Lord, 3 According as his divine power hath given unto us all things that pertain unto life and godliness, through the knowledge of him that hath called us to glory and virtue: 4 Whereby are given unto us exceeding great and precious promises: that by these ye might be partakers of the divine nature, having escaped the corruption that is in the world through lust. 5 And beside this, giving all diligence, add to your faith virtue; and to virtue knowledge; 6 And to knowledge temperance; and to temperance patience; and to patience godliness; 7 And to godliness brotherly kindness; and to brotherly kindness charity. 8 For if these things be in you, and abound, they make you that ye shall neither be barren nor unfruitful in the knowledge of our Lord Jesus Christ. 9 But he that lacketh these things is blind, and cannot see afar off, and hath forgotten that he was purged from his old sins. 10 Wherefore the rather, brethren, give diligence to make your calling and election sure: for if ye do these things, ye shall never fall: 11 For so an entrance shall be ministered unto you abundantly into the everlasting kingdom of our Lord and Saviour Jesus Christ.

33 :Paul means: KJV- Book: A) Acts- chap. 17 v Act 17:22 Then Paul stood in the midst of Mars' hill, and said, Ye men of Athens, I perceive that in all things ye are too superstitious. 23 For as I passed by, and beheld your devotions, I found an altar with this inscription, TO THE UNKNOWN GOD. Whom therefore ye ignorantly worship, him declare I unto you. 24 God that made the world and all things therein, seeing that he is Lord of heaven and earth, dwelleth not in temples made with hands; 25 Neither is worshipped with men's hands, as though he needed any thing, seeing he giveth to all life, and breath, and all things; 26 And hath made of one blood all nations of men for to dwell on all the face of the earth, and hath determined the times before appointed, and the bounds of their habitation; 27 That they should seek the Lord, if haply they might feel after him, and find him, though he be not far from every one of us: 28 For in him we live, and move, and have our being; as certain also of your own poets have said, For we are also his offspring. 29 Forasmuch then as we are the offspring of God, we ought not to think that the Godhead is like unto gold, or silver, or stone, graven by art and man's device. 30 And the times of this ignorance God winked at; but now commandeth all men every where to repent: 31 Because he hath appointed a day, in the which he will judge the world in righteousness by that man whom he hath ordained; whereof he hath given assurance unto all men, in that he hath raised him from the dead. B) Romans:- chap. 1 v Rom 1:1 Paul, a servant of Jesus Christ, called to be an apostle, separated unto the gospel of God, 2 (Which he had promised afore by his prophets in the holy scriptures,) 3 Concerning his Son Jesus Christ our Lord, which was made of the seed of David according to the flesh; 4 And declared to be the Son of God with power, according to the spirit of holiness, by the resurrection from the dead: 5 By whom we have received grace and apostleship, for obedience to the faith among all nations, for his name: 6 Among whom are ye also the called of Jesus Christ: 7 To all that be in Rome, beloved of God, called to be saints: Grace to you and peace from God our Father, and the Lord Jesus Christ.

4 :Adam- man- kind by the will of His father means: KJV- Book: Isaiah- chap. 58 – 61; Luke 4:

5 :Kinsman means: KJV- Book: Numbers- chap. 27 v 7 ... ye shall give his inheritance unto his kinsman that is next to him of his family, and he shall possess it: and it shall be unto the children of Israel a statute of judgment, as the LORD commanded Moses.

6 :Kinsman-redeemer means: KJV- Book: A) Exodus-- chap.. 6 v 2 And God spake unto Moses, and said unto him, I am the LORD: 3 And I appeared unto Abraham, unto Isaac, and unto Jacob, by the name of God Almighty, but by my name JEHOVAH

2022-0111769 MISC Page: 1738 of 2782
09/26/2022 03:35:37 PM Receipt # 22-9381
Rec Fee: \$30.00 Darrell James Hill
Gila County, Az, Sadie Jo Bingham, Recorder

Declaration of :- man - :Ambassador to :Yushuah the :Messiah

-Tribes -of -Ysrael. :Thereto, :- man declare and accept the duty and obligation to/ for the lost -Tribes -of -Ysrael for whom am :- man- Adam -Ambassador- brother -kinsman- redeemer.

5) Accounting Demand

A full-accounting of all right and property -real, chattel, and account to the penny is immediately -required, now.

Sincerely,
Without Prejudice

Darrell-James Hill
:Darrell-James: Hill, :Ambassador
:-Executor, -Ambassador

Affirmed and autographed before me this 24 day: July 2020 A.D.

Type of Identification: Arizona Driver License

[Signature]
Notary Public

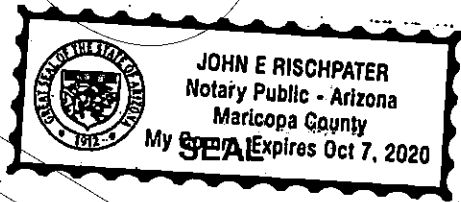

was I not known to them. 4 And I have also established my covenant with them, to give them the land of Canaan, the land of their pilgrimage, wherein they were strangers. 5 And I have also heard the groaning of the children of Israel, whom the Egyptians keep in bondage; and I have remembered my covenant. 6 Wherefore say unto the children of Israel, I am the LORD, and I will bring you out from under the burdens of the Egyptians, and I will rid you out of their bondage, and I will redeem you with a stretched out arm, and with great judgments: 7 And I will take you to me for a people, and I will be to you a God: and ye shall know that I am the LORD your God, which bringeth you out from under the burdens of the Egyptians. B) Psalms- chap.. 19 v 7 The law of the LORD is perfect, converting the soul: the testimony of the LORD is sure, making wise the simple. 8 The statutes of the LORD are right, rejoicing the heart: the commandment of the LORD is pure, enlightening the eyes. 9 The fear of the LORD is clean, enduring for ever: the judgments of the LORD are true and righteous altogether. 10 More to be desired are they than gold, yea, than much fine gold: sweeter also than honey and the honeycomb. 11 Moreover by them is thy servant warned: and in keeping of them there is great reward. 12 Who can understand his errors? cleanse thou me from secret faults. 13 Keep back thy servant also from presumptuous sins; let them not have dominion over me: then shall I be upright, and I shall be innocent from the great transgression. 14 Let the words of my mouth, and the meditation of my heart, be acceptable in thy sight, O LORD, my strength, and my redeemer.

2022-011769 MISC Page: 1739 of 2782
09/26/2022 03:35:37 PM Receipt #: 22-9381
Rec Fee: \$30.00 Darrell James Hill
Gila County, Az Sadie Jo Bingham, Recorder

Official

APACHE JUNCTION
 151 W. SUPERSTITION BLVD
 APACHE JUNCTION, AZ 85120-9998
 030259-0130
 (800)275-8777
 07/24/2020 02:46 PM

Product	Qty	Unit Price	Price
First-Class Intl Letter	1	\$2.24	\$2.24
International Vatican City Weight: 0 Lb 1.90 Oz			
Registered Amount: \$0.00			\$16.00
USPS Registered Mail # RE322387576US			
Return Receipt			\$4.15
Total:			\$22.39
Cash		\$50.00	
Change		(\$27.61)	

Registered No. RE322387576US

Date Stamp: APACHE JUNCTION, AZ 85120-9998 JUL 24 2020 01:30 PM

Reg. Fee	\$2.24	Return Receipt	
Handling Charge	\$16.00	Restricted Delivery	
Postage	\$4.15		
Received by	\$0.00		
Customer Must Declare Full Value \$0.00		Domestic Insurance up to \$25,000 is included. International indemnity is limited. (See PS Form 3800-107)	

OFFICIAL USE

FROM: APACHE JUNCTION, AZ 85120
 PO Box 3806
 Apache Junction, Arizona 8517

TO: Jorge-Mario Bergoglio
 Apostolic Palace
 00120 Vatican City

PS Form 3806, Receipt for Registered Mail May 2007 (7530-02-000-9051) Copy 1 - Customer (See Information on Reverse) For domestic delivery information, visit our website at www.usps.com

Due to limited transportation availability as a result of nationwide COVID-19 impacts package delivery times may be extended. Priority Mail Express® service will not change.

In a hurry? Self-service kiosks offer quick and easy check-out. Any Retail Associate can show you how.

Save this receipt as evidence of insurance. For information on filing an insurance claim go to

Completed by the office of origin. (A remplir par le bureau d'origine.)	Item Description (Nature de l'envoi)	Registered Article (Envoi recommandé)	Letter (Lettre)	Printed Matter (Imprimé)	Other (Autre)	Recorded Delivery (Envoi à livraison attestée)	Express Mail International	
	Insured Parcel (Colis avec valeur déclarée)	Insured Value (Valeur déclarée)	Article Number: RE 322 387 576 US					
	Office of Mailing (Bureau de dépôt)	APACHE JCT AZ					Date of Posting (Date de dépôt)	07-24-2020
	Addressee Name or Firm (Nom ou raison sociale du destinataire)	JORGE-MARIO BERGOGLIO					Street and No. (Rue et No.)	APOSTOLIC PALACE
Completed at destination. (A compléter à destination.)	Place and Country (Localité et pays)	00120 VATICAN CITY					Postmark of the office of destination (Timbre du bureau de destination)	
	This receipt must be signed by: (1) the addressee; or, (2) a person authorized to sign under the regulations of the country of destination; or, (3) those regulations so provided, by the employee of the office of destination. This signed form will be returned to the sender by the first mail. (Cet avis doit être signé par le destinataire ou par une personne y autorisée en vertu des règlements du pays de destination, ou, si ces règlements le comportent, par l'agent du bureau de destination, et renvoyé par le premier courrier directement à l'expéditeur.)							
	The article mentioned above was duly delivered. (L'envoi mentionné ci-dessus a été dûment livré.)	Date	Signature of Addressee (Signature du destinataire)					Office of Destination Employee Signature (Signature de l'agent du bureau de destination)

PS Form 2865, February 1997 (Reverse)





APACHE JUNCTION
151 W SUPERSTITION BLVD
APACHE JUNCTION, AZ 85120-9998
(800)275-8777

10/14/2020 03:47 PM

Product	Qty	Unit Price	Price
---------	-----	------------	-------

First-Class Mail® Letter	1		\$1.00
--------------------------	---	--	--------

Washington, DC 20520
Weight: 0 lb 3.30 oz
Estimated Delivery Date
Mon 10/19/2020

Registered Mail®		\$13.20
------------------	--	---------

Amount: \$21.00

Tracking #: RE322398392US

Return Receipt		\$2.85
----------------	--	--------

Tracking #: 9590 9402 4718 8344 9618 56

Total		\$17.05
-------	--	---------

First-Class™ Intl Letter	1		\$3.28
--------------------------	---	--	--------

United Kingdom
Weight: 0 lb 3.00 oz

First-Class™ Intl Letter	1		\$3.28
--------------------------	---	--	--------

United Kingdom
Weight: 0 lb 3.00 oz

First-Class™ Intl Letter	1		\$3.28
--------------------------	---	--	--------

United Kingdom
Weight: 0 lb 3.00 oz

First-Class™ Intl Letter	1		\$3.28
--------------------------	---	--	--------

United Kingdom
Weight: 0 lb 2.90 oz

Registered		\$16.00
------------	--	---------

Amount: \$0.00

Tracking #: RE322387593US

Return Receipt		\$4.15
----------------	--	--------

Total		\$23.43
-------	--	---------

Grand Total:		\$50.32
--------------	--	---------

Cash Change		\$100.00 (\$49.68)
-------------	--	-----------------------

Due to limited transportation

2022-011769 MISC Page: 1741 of 2782

09/26/2022 03:35:37 PM Receipt #: 22-9381

Rec Fee: \$30.00 Darrell James Hill

Gila County, Az, Sadie Jo Bingham, Recorder



Registered No. RE322387593US

Postage \$	\$3.28	Extra Services & Fees (continued)	
Extra Services & Fees		<input type="checkbox"/> Signature Confirmation	\$
<input type="checkbox"/> Registered Mail	\$16.00	<input type="checkbox"/> Signature Confirmation Restricted Delivery	\$
<input type="checkbox"/> Return Receipt (hardcopy)	\$0.00		
<input type="checkbox"/> Return Receipt (electronic)	\$0.00		
<input type="checkbox"/> Restricted Delivery	\$0.00		
		Total Postage & Fees	\$ 19.28

To Be Completed By Post Office

Customer Must Declare Full Value \$ 20.00
Received by 10/14/2020

Domestic Insurance up to \$50,000 is included. Additional insurance is available for purchase. (See Reverse)

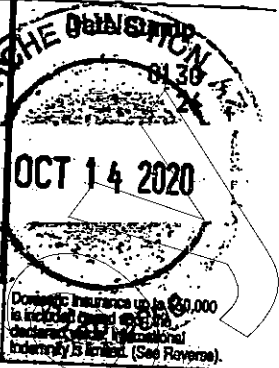

OFFICIAL USE

FROM	APACHE JUNCTION, AZ 85120 Darrell James Hill, Amb. PO Box 3806 Apache Junction, Arizona 85117
TO	Anthony Hacking, Trustee 8 South Kings Square London WC1R 5ET

PS Form 3806, Registered Mail Receipt
April 2015, PSN 7530-02-000-9051

Copy 1 - Customer
(See Information on Reverse)
For domestic delivery information, visit our website at www.usps.com®

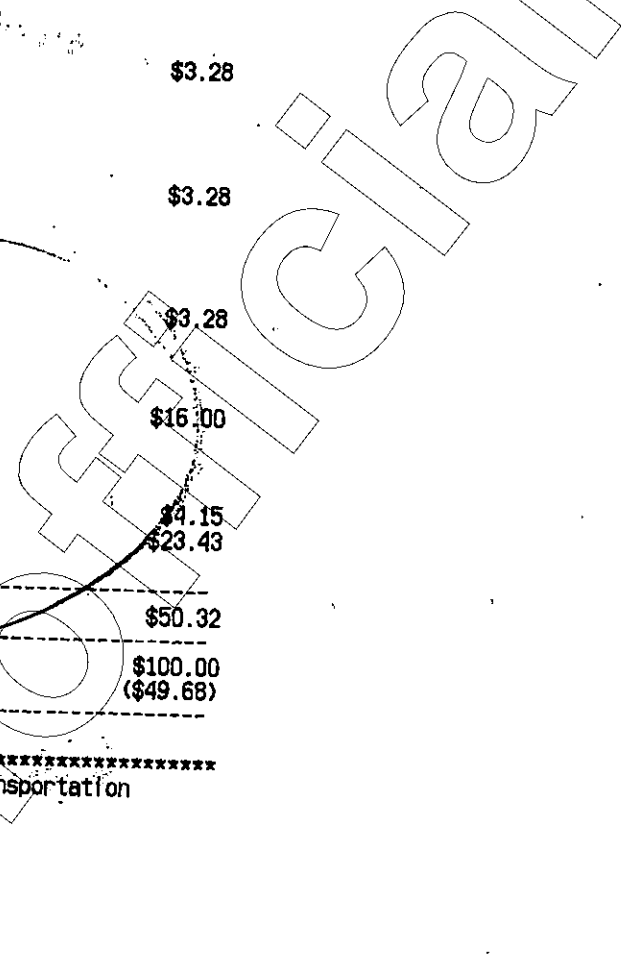

USPS Tracking®

[FAQs >](#)

Track Another Package +

**Track Packages
Anytime, Anywhere**

Get the free Informed Delivery® feature to receive automated notifications on your packages.

[Learn More](#)

(<https://reg.usps.com>)

/xsel?app=UspsTools&ref=homepageBanner&appURL=https%3A%2F%2Finformeddelivery.usps.com/box/pages/intro/startAction)

Tracking Number: RE322387593US

[Remove X](#)

Your item was processed through a facility in UNITED KINGDOM on October 31, 2020 at 7:40 pm. The item is currently in transit to the destination.

In-Transit

October 31, 2020 at 7:40 pm
Processed Through Facility
UNITED KINGDOM

[Get Updates](#) ▾

Text & Email Updates ▾

Tracking History ▲

October 31, 2020, 7:40 pm
Processed Through Facility
UNITED KINGDOM

Your item was processed through a facility in UNITED KINGDOM on October 31, 2020 at 7:40 pm. The item is currently in transit to the destination.

October 31, 2020, 12:46 pm
Departed
LONDON, UNITED KINGDOM

October 31, 2020, 8:54 am
Departed
TOKYO, JAPAN

October 31, 2020, 7:25 am
Departed
TOKYO, JAPAN

2022-011769 MISC Page: 1742 of 2782

09/26/2022 03:35:37 PM Receipt #: 22-9381
Rec Fee: \$30.00 Darrell James Hill
Gila County, Az, Sadie Jo Bingham, Recorder



10/31/20, 7:55 PM



APACHE JUNCTION
151 W SUPERSTITION BLVD
APACHE JUNCTION, AZ 85120-9998
(800)275-8777

10/14/2020 03:47 PM

Product	Qty	Unit Price	Price
---------	-----	------------	-------

First-Class Mail® Letter	1		\$1.00
Washington, DC 20520 Weight: 0 lb 3.30 oz Estimated Delivery Date Mon 10/19/2020			
Registered Mail®			\$13.20
Amount: \$21.00 Tracking #: RE322398392US			
Return Receipt			\$2.85
Tracking #: 9590 9402 4718 8344 9618 56			
Total			\$17.05

First-Class™ Intl Letter	1		\$3.28
United Kingdom Weight: 0 lb 3.00 oz			

First-Class™ Intl Letter	1		\$3.28
United Kingdom Weight: 0 lb 3.00 oz			

First-Class™ Intl Letter	1		\$3.28
United Kingdom Weight: 0 lb 3.00 oz			

First-Class™ Intl Letter	1		\$3.28
United Kingdom Weight: 0 lb 2.90 oz Registered Amount: \$0.00 Tracking #: RE322387593US			
Return Receipt			\$4.15
Total			\$23.43

Grand Total: \$50.32

Cash Change \$100.00 (\$49.68)

Due to limited transportation

2022-011769 MISC Page: 1743 of 2782
09/26/2022 03:35:37 PM Receipt #: 22-9381
Rec Fee: \$30.00 Darrell James Hill
Gila County, Az, Sadie Jo Bingham, Recorder



Registered No RE322398392US

To Be Completed By Post Office		Date Stamp
Reg. Fee	\$1.00	OCT 14 2020
Handling Charge	\$13.20	
Postage	\$2.85	
Postage	\$0.00	
Received by	\$0.00	
Customer Must Declare Full Value \$		10/14/2020
Return Receipt Restricted Delivery		
Total		\$17.05

OFFICIAL USE

FROM: Darrell James Hill, Amb
PO Box 3806
Apache Junction, Arizona 85117

TO: Michael Pompeo Tevster
2201 C Street NW, Rm 2206
Washington, Dist. of Columbia 20520-2204

PS Form 3806, Receipt for Registered Mail Copy 1 - Customer
May 2007 (7530-02-000-9051) (See Information on Reverse)
For domestic delivery information, visit our website at www.usps.com®

COMPLETE THIS SECTION ON DELIVERY

Signature: *[Signature]* Agent Addressee C. Date of Delivery: *[Date]*

1. Article Addressed to: *Michael Pompeo Tevster*
2201 C Street NW, Rm 2206
Washington, Dist. of Columbia
20520-2204

2. Article Number (Transfer from service label): **RE 322 398 392 US**

3. Service Type:
 Adult Signature Restricted Delivery
 Certified Mail®
 Collect on Delivery
 Insured Mail (over \$500)
 Priority Mail Express®
 Registered Mail™
 Registered Mail Restricted Delivery
 Return Receipt for Merchandise
 Signature Confirmation™
 Signature Confirmation Restricted Delivery
 Signature Confirmation Restricted Delivery

Domestic Return Receipt

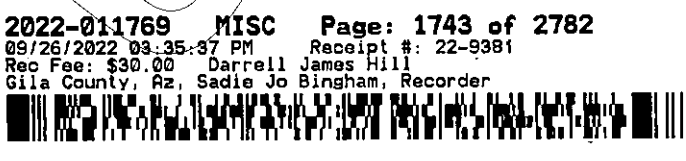

USPS Tracking®

[FAQs >](#)

Track Another Package +

Track Packages
Anytime, Anywhere

Get the free Informed Delivery® feature to receive automated notifications on your packages

[Learn More](#)

(https://reg.usps.com/xsell?app=UspsTools&ref=homepageBanner&appURL=https%3A%2F%2Finformeddelivery.usps.com/box/pages/intro/start.action)

Tracking Number: RE322398392US

[Remove X](#)

Your item was delivered at 6:03 am on October 29, 2020 in WASHINGTON, DC 20521.

Delivered

October 29, 2020 at 6:03 am
Delivered
WASHINGTON, DC 20521

[Get Updates](#) ▾

Text & Email Updates ▾

Tracking History ▲

October 29, 2020, 6:03 am
Delivered
WASHINGTON, DC 20521

Your item was delivered at 6:03 am on October 29, 2020 in WASHINGTON, DC 20521.

October 26, 2020, 1:15 am
Arrived at Unit
WASHINGTON, DC 20066

October 20, 2020
In Transit to Next Facility

2022-011769 MISC Page: 1744 of 2782

09/26/2022 03:35:37 PM Receipt #: 22-9381
Rec Fee: \$30.00 Darrell James Hill
Gila County, Az, Sadie Jo Bingham, Recorder



10/29/20, 3:15 PM



USPS.com® - USPS Tracking® Results

<https://tools.usps.com/go/TrackConfirmAction?tR..>

USPS Tracking®

[FAQs](#) →

Track Another Package +

**Track Packages
Anytime, Anywhere**

Get the free Informed Delivery® feature to receive automated notifications on your packages

[Learn More](#)

(<https://reg.usps.com/xsell?app=UspsTools&ref=homepage;eBanner&appURL=https%3A%2F%2Finformeddelivery.usps.com/box/pages/intro/startaction>)

Tracking Number: RE322398392US

[Remove X](#)

Your item was delivered at 6:03 am on October 29, 2020 in WASHINGTON, DC 20521.

✓ Delivered

October 29, 2020 at 6:03 am
Delivered
WASHINGTON, DC 20521

[Get Updates](#) ▾

Text & Email Updates ▾

Tracking History ▴

October 29, 2020, 6:03 am
Delivered
WASHINGTON, DC 20521

Your item was delivered at 6:03 am on October 29, 2020 in WASHINGTON, DC 20521.

October 26, 2020, 1:15 am
Arrived at Unit
WASHINGTON, DC 20066

October 20, 2020
In Transit to Next Facility



10/29/20, 3:15 PM

- 2 :Bill of Particulars: 2 means: BILL OF PARTICULARS FOR :LOT 2; ATTACHED: 3 PAGES
- 3 :Bill of Particulars: 3 means: BILL OF PARTICULARS FOR :LOT 3; ATTACHED: 3 PAGES
- 4 :“Thou shalt not steal.” means: See :Holy-Bible: KJV- Book: Exodus: chap. 20, v.15, et seq.- :Declaration of Independence of 1776 A.D., et seq.- TheCftUSofA-1789-1791-A.D., EP-1863-A.D., Lieber Code.
- 5 :theft of property-acquired means: POTUS, et al.- US AG received the property legally, and none else; then thieved :all of the Private-Property- Claimed and Possessed- Lots: 1,2,3, by :i- man

Bill of Particulars: Deprivation- Agreements for :i- man's Property-Lots: 1, 2, and 3

1 / 2

1734

**:Notice to the Principal Must be made Notice to Every Agent;
:Notice to the Any Agent Must be made Notice to the Principal by the Same-Agent;
Applicable to all Successors and Assigns.**

cc: Trustees:

:Mark-Alexander :General United States Army-:Chairman: CJCOS- :Milley,
:John-Earl :General United States Air Force: Vice- CJCOS- :Hyten,
:**James-Charles :General United States Army: COS Army- :McConville**
:David-Hilberry :General United States Marine Corps: CMC- :Berger,
:Michael-Martin :Admiral United States Navy: CNO- :Gilday:,
:David-Lee :General United States air Force: COS AF- :Goldfein,
:John-William :General United States Space Force: CSO- :Raymond,
:Joseph-Lauren :General United States Air Force: CNG- :Lengyel
:Karl-Leo :Admiral United States Coast Guard: CCG- :Schultz
c/o :James-Charles: McConville, :USPS RMN RE 322 387 633 US
9999 Join Staff Pentagon
Washington, District of Columbia 20318-9999

:Mark, :Sheriff- Pinal county, Arizona state- :Lamb, RTCC

:Joseph- Jr, :Sheriff Apache county, Arizona state- :Dedman,
:Mark, :Sheriff -Cochise county Arizona state- :Dannels,
:Jim, :Sheriff -Coconino county, Arizona state- :Driscoll,
:Adam, :Sheriff- Gila county, Arizona state - :Shepherd,
:Preston- "PJ", :Sheriff -Graham county, Arizona state- :Allred,
:Tim, :Sheriff- Greenlee county, Arizona state- :Sumner,
:Bill, :Sheriff- La Paz county, Arizona state- :Risen,
:Paul, :Sheriff- Maricopa county, Arizona state- :Penzone,
:Doug, :Sheriff- Mohave county, Arizona state- :Schuster,
:David, :Sheriff- Navajo county, Arizona state- :Clouse,
:Mark, :Sheriff- Pima county, Arizona state- :Napier,
:Tony, :Sheriff- Santa Cruz county, Arizona state- :Estrada,
:Scott, :Sheriff- Yavapai county, Arizona- :Mascher,
:Leon, :Sheriff- Yuma county, Arizona state- :Wilmot,
c/o :Mark :Lamb, -:Trustee, First Class Mail
971 N Jason Lopez Circle
Building C
PO Box 867
Florence, Arizona state 85132

:i- man affirm the :above is :true and correct, and will verify same in the open-court.

Without prejudice

Darrell James Hill, Executor
:Darrell-James: Hill, -civilian, :Darrell-James: Hill, :Executor- Beneficiary,
:ambassador of the Messiah-Yushuah.

Affirmed and autographed before me this November 9th, 2020 A.D.
Type Identification: Arizona Driver License

[Signature]
Notary Public



1735

Correction: :Bill of Particulars for the Lot #: 1 -:RE 322 399 279 US with the RE 322 399 279 US- Covenant by the law of the -:Executor: DOI-1776-A.D.- PE-2016-A.D.- RE 322 399 279 US- covenant ;

:Darrell-James: Hill, -:Ohioan, -:Executor
 PO Box 3806, Apache-Junction, Arizona [85117]

2022-011769 MISC Page: 1747 of 2782

09/26/2022 03:35:37 PM Receipt #: 22-9381
 Rec Fee: \$30.00 Darrell James Hill
 Gila County, Az, Sadie Jo Bingham, Recorder



:POTUS- Office by the Procuration- Covenant;
 :Procurator: Darrell-James: Hill, -:Ohioan, -:Executor

10/25/16 – 11:02 a.m. to: 12/13/21 – 17:00 pm	Deprivation- penalty-by the covenant- agreement (a) One 0.9999- oz. Ag / minute, U.S.- coin in specie	Minutes; + Days (b) minutes" + days (1440 minutes/ day = minutes)	Amount due now (a x b)	Amount- paid- today	Amount due- now- paid-now
	1 / 0.9999 oz Ag	358 minutes ¹ + (1876 days ² x 1440 minures/ day = 2701440 minutes) is: 358" + 1657440" = 2701798"	1 / 0.9999 oz Ag x 2701798	0	2701798 ounces: 0.9999 Ag :U.S.- coin -in -specie
:Totals		2701798 minutes	2701798 ounces: 0.9999 Ag :U.S.- coin -in -specie	0	2701798 ounces: 0.9999 Ag :U.S.- coin - in -specie

Pay amount demanded-due now.

:i- man affirm the above is true and correct to the best of my ability, and will state same in the open court.

Without prejudice,

December 13, 2021

Darrell-James Hill, :Executor
 :Darrell-James, -:Ohioan, beneficiary; -:Executor -
 Procurator: DOI-1776-A.D.³- PE-2016-A.D.⁴-
 RE 322 399 279 US⁵- covenant

1 :358 minutes means: See: Minues-Calculator-attached: 1 page: <https://dqvyj.com>

2 :1876 days: See:Date-Calculator- attached, 1 page: <https://www.calculator.net>

3 :DOI-1776-A.D. means: Declaration-of-Independence-1776-A.D., et seq.

4 :PE-2016-A.D. means: Political-Election-2016-A.D.: See: Gila-County-Recorder-Doc.# 2017-002378,pp. 1-239.

5 :RE 322 399 279 US means: See Gila-County-Recorder-Doc.# 2017-002378, pp. 240- 549

i

Minutes Calculator: See How Many Minutes are Between Two Times

Time Written by: PK

Below is a *minutes calculator*. Use the inputs and enter a starting time and an ending time, then hit 'Calculate'. We'll add up the number of minutes (up to a 23 hours and 59 minutes maximum).

Minutes Calculator Between Two Times

Minutes Between Calculator: Inputs

Start Time:

End Time:

Minutes Between Calculator: Outputs

Minutes Between:

2022-011769 MISC Page: 1748 of 2782
 09/26/2022 03:35:37 PM Receipt #: 22-9381
 Rec Fee: \$30.00 Darrell James Hill
 Gila County, Az, Sadie Jo Bingham, Recorder



home / other / date calculator

Date Calculator

Days Between Two Dates

Find the number of years, months, weeks, and days between dates. Click "Settings" to

Result

Difference between Oct 25, 2016 and Dec 13, 2021 (including both days):

5 years 1 months 20 days
or 61 months 20 days
or 268 weeks 0 days
or 1876 calendar days

Within which, there are:

Weekend Days*	536
Holidays (show)	52
Business Days	1288

October 2016						
S	M	T	W	T	F	S
						1
2	3	4	5	6	7	8
9	10	11	12	13	14	15
16	17	18	19	20	21	22
23	24	25	26	27	28	29
30	31					

December 2021						
S	M	T	W	T	F	S
			1	2	3	4
5	6	7	8	9	10	11
12	13	14	15	16	17	18
19	20	21	22	23	24	25
26	27	28	29	30	31	

* This calculator assumes the workweek is from Monday to Friday and the weekend is Sunday in a seven-day week.

Start Date

2022-011769 MISC Page: 1749 of 2782
09/26/2022 03:35:37 PM Receipt #: 22-9381
Rec Fee: \$30.00 Darrell James Hill
Gila County, Az, Sadie Jo Bingham, Recorder



Correction: :Bill of Particulars for the Lot #: 2 -RE 322 399 251 US with the RE 322 399 251 US- Covenant by the law of the -:Executor: DOI-1776-A.D.- PE-2016-A.D.- RE 322 399 251 US- covenant ;

:Darrell-James: Hill, -:Ohioan, -:Executor
 PO Box 3806, Apache-Junction, Arizona [85117]

2022-011769 MISC Page: 1750 of 2782

09/26/2022 03:35:37 PM Receipt #: 22-9381
 Rec Fee: \$30.00 Darrell James Hill
 Gila County, Az, Sadie Jo Bingham, Recorder



:POTUS- Office by the Procuration- Covenant;
 :Procurator: Darrell-James: Hill, -:Ohioan, -:Executor

03/20/17 – 9:43 a.m. to: 12/13/21 – 17:00 pm	Deprivation-penalty-by the covenant-agreement (a) One 0.9999-oz. Ag / minute, U.S.- coin in specie	Minutes; + Days (b) minutes" + days (1440 minutes/ day = minutes)	Amount due now (a x b) 1 / 0.9999 oz Ag x 2701877"	Amount-paid-todate 0	Amount due-now- paid-now 2701877 ounces: 0.9999 Ag :U.S.- coin -in -specie
		437 minutes ¹ + (1730 days ² x 1440 minures/ day = 2701440 minutes) is: 437" + 2701440" = 2701877"			
:Totals		2701877 minutes	2701877 ounces: 0.9999 Ag :U.S.- coin -in -specie	0	2701877 ounces: 0.9999 Ag :U.S.- coin -in -specie

Pay amount demanded-due now.

i- man affirm the above is true and correct to the best of my ability, and will state same in the open court.

December 13, 2021

Without prejudice

Darrell-James Hill, :Executor

:Darrell-James, -:Ohioan, beneficiary; -:Executor - Procurator: DOI-1776-A.D.³- PE-2016-A.D.⁴- RE 322 399 251 US⁵- covenant

1 :437 minutes means: See: Minues-Calculator-attached: 1 page: <https://dqvyj.com>

2 :1730 days: See:Date-Calculator- attached, 1 page: <https://www.calculator.net>

3 :DOI-1776-A.D. means: Declaration-of-Independence-1776-A.D., et seq.

4 :PE-2016-A.D. means: Political-Election-2016-A.D.: See: Gila-County-Recorder-Doc.# 2017-002378,pp. 1-239.

5 :RE 322 399 251 US means: See Gila-County-Recorder-Doc.# 2019-9291, pp. 9- 355

2

Minutes Calculator: See How Many Minutes are Between Two Times

Time Written by: PK

Below is a *minutes calculator*. Use the inputs and enter a starting time and an ending time, then hit 'Calculate'. We'll add up the number of minutes (up to a 23 hours and 59 minutes maximum).

Minutes Calculator Between Two Times

Minutes Between Calculator: Inputs

Start Time: 09 : 43 AM

End Time: 05 : 00 PM

Minutes Between Calculator: Outputs

Minutes Between: Timespan is 437 minute(s).

2022-011769 MISC Page: 1751 of 2782
 09/26/2022 03:35:37 PM Receipt #: 22-9381
 Rec Fee: \$30.00 Darrell James Hill
 Gila County, Az, Sadie Jo Bingham, Recorder



FINANCIAL

FITNESS & HEALTH

MATH

home / other / date calculator

Date Calculator

Days Between Two Dates

Find the number of years, months, weeks, and days between dates. Click "Settings" to

Result

Difference between Mar 20, 2017 and Dec 13, 2021 (including both days)

4 years 8 months 25 days
 or 56 months 25 days
 or 247 weeks 1 days
 or 1730 calendar days

Within which, there are:

Weekend Days*	495
Holidays (show)	46
Business Days	1189

March 2017						
S	M	T	W	T	F	S
			1	2	3	4
5	6	7	8	9	10	11
12	13	14	15	16	17	18
19	20	21	22	23	24	25
26	27	28	29	30	31	

December 2021						
S	M	T	W	T	F	S
			1	2	3	4
5	6	7	8	9	10	11
12	13	14	15	16	17	18
19	20	21	22	23	24	25
26	27	28	29	30	31	

* This calculator assumes the workweek is from Monday to Friday and the weekend is : Sunday in a seven-day week.

2022-0111769 MISC Page: 1752 of 2782
 09/26/2022 03:35:37 PM Receipt #: 22-9381
 Rec Fee: \$30.00 Darrell James Hill
 Gila County, Az, Sadie Jo Bingham, Recorder



1741

Start Date 

Correction: :Bill of Particulars for the Lot #: 3 -:RE 322 399 248 US with the RE 322 399 248 US- Covenant by the law of the -:Executor: DOI-1776-A.D.- PE-2016-A.D.- RE 322 399 248 US- covenant ;

2022-011769 MISC Page: 1753 of 2782

09/26/2022 03:35:37 PM Receipt #: 22-9381
 Rec Fee: \$30.00 Darrell James Hill
 Gila County, Az, Sadie Jo Bingham, Recorder

:Darrell-James: Hill, -:Ohioan, -:Executor
 PO Box 3806, Apache-Junction, Arizona [85117]

:POTUS- Office by the Procuration- Covenant;
 :Procurator: Darrell-James: Hill, -:Ohioan, -:Executor

09/15/17 – 11:11 a.m. to: 12/13/21 – 17:00 pm	Deprivation- penalty-by the covenant- agreement (a) One 0.9999- oz. Ag / minute, U.S.- coin in specie	Minutes; + Days (b) minutes" + days (1440 minutes/ day = minutes)	Amount due now (a x b)	Amount- paid- today	Amount due- now- paid-now
	1 / 0.9999 oz Ag	349 minutes ¹ + (1551 days ² x 1440 minures/ day = 2233440 minutes) is: 349" + 2233440" = 2233789"	1 / 0.9999 oz Ag x 2233789"	0	2233789 ounces: 0.9999 Ag :U.S.- coin -in -specie
:Totals		2233789 minutes	2233789 ounces: 0.9999 Ag :U.S.- coin -in -specie	0	2233789 ounces: 0.9999 Ag :U.S.- coin - in -specie

Pay amount demanded-due now.

:i- man affirm the above is true and correct to the best of my ability, and will state same in the open court.

Without prejudice,

December 13, 2021

Darrell-James Hill, :Executor

:Darrell-James, -:Ohioan, beneficiary; -:Executor -
 Procurator: DOI-1776-A.D.³- PE-2016-A.D.⁴-
 RE 322 399 248 US⁵- covenant

1 :349 minutes means: See: Minues-Calculator-attached: 1 page: <https://dqvyj.com>

2 :1551 days: See:Date-Calculator- attached, 1 page: <https://www.calculator.net>

3 :DOI-1776-A.D. means: Declaration-of-Independence-1776-A.D., et seq.

4 :PE-2016-A.D. means: Political-Election-2016-A.D.: See: Gila-County-Recorder-Doc.# 2017-002378,pp. 1-239.

5 :RE 322 399 248 US means: See Gila-County-Recorder-Doc.# 2019-9291, pp. 374-737

1742

Minutes Calculator: See How Many Minutes are Between Two Times

Time Written by: PK

Below is a *minutes calculator*. Use the inputs and enter a starting time and an ending time, then hit 'Calculate'. We'll add up the number of minutes (up to a 23 hours and 59 minutes maximum).

Minutes Calculator Between Two Times

Minutes Between Calculator: Inputs

Start Time:

End Time:

Minutes Between Calculator: Outputs

Minutes Between:

1743

2022-011769 MISC Page: 1754 of 2782
09/28/2022 03:35:37 PM Receipt #: 22-9381
Rec Fee: \$30.00 Darrell James Hill
Gila County, Az, Sadie Jo Bingham, Recorder



FINANCIAL

FITNESS & HEALTH

MATH

home / other / date calculator

Date Calculator

Days Between Two Dates

Find the number of years, months, weeks, and days between dates. Click "Settings" to

Result

Difference between Sep 15, 2017 and Dec 13, 2021 (including both days)

4 years 2 months 29 days
 or 50 months 29 days
 or 221 weeks 4 days
 or 1551 calendar days

Within which, there are:

Weekend Days*	444
Holidays (show)	43
Business Days	1064

September 2017						
S	M	T	W	T	F	S
					1	2
3	4	5	6	7	8	9
10	11	12	13	14	15	16
17	18	19	20	21	22	23
24	25	26	27	28	29	30

December 2021						
S	M	T	W	T	F	S
			1	2	3	4
5	6	7	8	9	10	11
12	13	14	15	16	17	18
19	20	21	22	23	24	25
26	27	28	29	30	31	

2022-011769 MISC Page: 1755 of 2782
 09/26/2022 03:35:37 PM Receipt #: 22-9381
 Rec Fee: \$30.00 Darrell James Hill
 Gila County, AZ, Saide Jo Bingham, Recorder



* This calculator assumes the workweek is from Monday to Friday and the weekend is Sunday in a seven-day week.

Start Date 

1744



APACHE JUNCTION
151 W SUPERSTITION BLVD
APACHE JUNCTION, AZ 85120-9998
(800)275-8777

11/10/2020 11:48 AM

Product	Qty	Unit Price	Price
---------	-----	------------	-------

First-Class Mail® Letter	1	\$0.85	\$0.85
Florence, AZ 85132 Weight: 0 lb 2.20 oz Estimated Delivery Date Sat 11/14/2020			

First-Class Mail® Letter	1	\$0.85	\$0.85
Washington, DC 20318 Weight: 0 lb 2.40 oz Estimated Delivery Date Mon 11/16/2020			

Registered Mail®		\$13.20	\$13.20
Return Receipt		\$2.85	\$2.85
Amount: \$21.00 Tracking #: RE322387633US 9590 9402 4718 8344 9594 26			

Total \$16.90

First-Class Mail® Letter	1	\$0.85	\$0.85
Washington, DC 20500 Weight: 0 lb 2.40 oz Estimated Delivery Date Mon 11/16/2020			

Registered Mail®		\$13.20	\$13.20
Return Receipt		\$2.85	\$2.85
Amount: \$21.00 Tracking #: RE322387647US 9590 9402 4718 8344 9594 33			

Total \$16.90

Grand Total: \$34.65

Cash \$40.00
Change (\$5.35)

RE322387647US

0130
01

Reg. Fee	\$0.85	
Handling Charge	\$13.20	Return Receipt
Postage	\$2.85	Restricted Delivery
Received by	\$0.00	
\$16.90		

Customer Must Declare Full Value \$21.00 11/10/2020
Domestic insurance up to \$25,000 is included on the declared value. International indemnity is limited. (See Reverse).

OFFICIAL USE

FROM	APACHE JUNCTION, AZ 85120 Darrell James Hill P.O. Box 3806 Apache Junction Arizona 85117
TO	Donald John Trump - POTUS - corp 90 Donald Trump Plaza - quarantine 1400 Pennsylvania Ave. NW Washington District of Columbia 20004

PS Form 3806, Receipt for Registered Mail Copy 1 - Customer
May 2007 (7530-02-000-9051) (See Information on Reverse)
For domestic delivery information, visit our website at www.usps.com

Registered No. RE322387633US Date Stamp 0130 01

Reg. Fee	\$0.85	
Handling Charge	\$13.20	Return Receipt
Postage	\$2.85	Restricted Delivery
Received by	\$0.00	
\$16.90		

Customer Must Declare Full Value \$21.00 11/10/2020
Domestic insurance up to \$25,000 is included on the declared value. International indemnity is limited. (See Reverse).

OFFICIAL USE

FROM	APACHE JUNCTION, AZ 85120 Darrell James Hill, Cavalier P.O. Box 3806 Apache Junction, Arizona 85117
TO	James Charles McCarville 9999 Inglewood Blvd Washington Dist of Columbia 20318

PS Form 3806, Receipt for Registered Mail Copy 1 - Customer
May 2007 (7530-02-000-9051) (See Information on Reverse)
For domestic delivery information, visit our website at www.usps.com



USPS Tracking®

[FAQs >](#)

[Track Another Package +](#)

Tracking Number: RE322387647US

[Remove X](#)

Your item was delivered at 3:58 am on November 19, 2020 in WASHINGTON, DC 20500.

Delivered

November 19, 2020 at 3:58 am
WASHINGTON, DC 20500

[Feedback](#)

[Get Updates v](#)

Text & Email Updates 

Tracking History 

November 19, 2020, 3:58 am

Delivered

WASHINGTON, DC 20500

Your item was delivered at 3:58 am on November 19, 2020 in WASHINGTON, DC 20500.

2022-011769 MISC Page: 1757 of 2782
09/26/2022 03:35:37 PM Receipt #: 22-9381
Rec Fee: \$30.00 Darrell James Hill
Gila County, Az, Sadie Jo Bingham, Recorder



November 15, 2020, 12:54 am

Arrived at Hub

WASHINGTON, DC 20066

November 14, 2020, 10:57 am

Arrived at USPS Regional Destination Facility

WASHINGTON DC DISTRIBUTION CENTER

November 12, 2020, 8:30 pm

Arrived at USPS Facility

DULLES, VA 20101

November 12, 2020, 12:44 am

Departed USPS Facility

PHOENIX, AZ 85026

November 12, 2020, 12:42 am

Arrived at USPS Facility

PHOENIX, AZ 85026

November 11, 2020

In Transit to Next Facility

November 10, 2020, 4:39 pm

Departed Post Office

APACHE JUNCTION, AZ 85120

November 10, 2020, 11:42 am

USPS in possession of item

APACHE JUNCTION, AZ 85120

1749

Official Copy

Feedback

2022-011769 MISC Page: 1758 of 2782

09/26/2022 03:35:37 PM Receipt #: 22-9381

Rec Fee: \$30.00 Darrell James Hill

Gila County, Az, Sadie Jo Bingham, Recorder



USPS Tracking®

[FAQs >](#)

[Track Another Package +](#)

Tracking Number: RE322387633US

[Remove X](#)

Your item was delivered at 6:38 am on November 19, 2020 in WASHINGTON, DC 20310.

 **Delivered**

November 19, 2020 at 6:38 am,
WASHINGTON, DC 20310

[Feedback](#)

[Get Updates v](#)

Text & Email Updates 

Tracking History 

November 19, 2020, 6:38 am

Delivered

WASHINGTON, DC 20310

Your item was delivered at 6:38 am on November 19, 2020 in WASHINGTON, DC 20310.

2022-011769 MISC Page: 1759 of 2782
09/26/2022 03:35:37 PM Receipt #: 22-9381
Rec Fee: \$30.00 Darrell James Hill
Gila County, Az, Sadie Jo Bingham, Recorder



November 15, 2020, 12:47 am

Arrived at Hub

WASHINGTON, DC 20066

November 14, 2020, 10:57 am

Arrived at USPS Regional Destination Facility

WASHINGTON DC DISTRIBUTION CENTER

November 12, 2020, 8:30 pm

Arrived at USPS Facility

DULLES, VA 20101

November 12, 2020, 12:44 am

Departed USPS Facility

PHOENIX, AZ 85026

November 12, 2020, 12:42 am

Arrived at USPS Facility

PHOENIX, AZ 85026

November 11, 2020

In Transit to Next Facility

November 10, 2020, 4:39 pm

Departed Post Office

APACHE JUNCTION, AZ 85120

November 10, 2020, 11:42 am

USPS in possession of item

APACHE JUNCTION, AZ 85120

Official Copy

Feedback

1751

2022-011769 MISC Page: 1760 of 2782
09/26/2022 03:35:37 PM Receipt #: 22-9381
Rec Fee: \$30.00 Darrell James Hill
Gila County, Az, Sadie Jo Bingham, Recorder



:Darrell-James: Hill, -Negro, -civilian, -Ohioan, :-Executor -beneficiary¹;
:kinsman-redeemer: Negro-Ysrael, :Ysrael and :Holy-Church of the :Almighty-God²;
:ambassador of :Messiah- Yushuah for :Health and Wholeness;
:Trustee: Concession-1213-A.D.³
PO Box 3806
Apache Junction, Arizona 85117

:Torah:-KJV- :Book- :Isaiah- :Chap 58, et al.; :man, -:present,

Arizona state
Pinal county



:Stephen-G.: Breyer, et al.- Trustee Justices
c/o Scott-Sessions: Harris- Trustee
Supreme Court of the United States
1 First Street, NE
Washington, District of Columbia 20543

:RIGHT OF :CONUSANCE ~USPS RMN RE 322 387 616 US~ For the united States of America-state- :civilians and citizens, holders in due course, over-standing the Declaration of Independence- 1776 A.D., et seq.- 'The Constitution for the United States of America-1787-A.D., et seq.- The Emancipation Proclamation- 1863 A.D. with the claim of the right -herein now-exercised for the Restoration of the common -law government and monetary- system now-due status-post the Emergency Banking Act- 1933-A.D., 'EBA-1933-A.D.'- 2003 A.D., Legislative Dry-Trust;

:DEMAND: Authorization for the Restoration of the Lawful-Government⁴
:Right and Demand for the Extinction of the Proxy - ':UNITED-STATES-Corp'- government- Trustee-Derelict: EBA-1933 A.D., -Dry- Legislative-Trust by the Accounting, Settle, and Closure of same With Reset and Restoration to 'The Constitution for the United States of America' with Lawful- Money in the Guaranteed-Obligation for the Republican-form of :government

:Affiant to :Conusance: :- man, -Darrell-James: Hill, :Executor-beneficiary of the inherent trust from :Almighty-God, ~where nothing stands between the :Almighty-God and :- man~; :Executor- :beneficiary in the Concession-1213-A.D., :Declaration of Independence-1776-A.D., et seq., the Constitution for the united States of America-1787, et seq. -Emancipation-

- 1 :beneficiary means: of the inherent-:Almighty-God- given -Trust, :Concession-1213-A.D., et seq.- Declaration of Independence-1776-A.D., et seq.,- EBA-1933-A.D., et al. See:
 - 2 :kinsman-redeemer means: Tribe; :Receiver-redeemer for :family -right. See:
 - 3 :Trustee: Concession-1213-A.D. means: ambassador of the Messiah-Yushuah in the office. See:
 - 4 :Authorization for the Restoration of the Lawful-Government means: 'U.S.' :all Agents: See: :Sovereign- Authorization to Establish :Lawful -Government: :Kinsman-redeemer- 'Declaration of Independence of 1776 A.D.' -Sovereign-Authorization for the Present-Restoration of: 1) Common Law, 2) Lawful Money, and 3) 'The Constitution for the United States of America' for the united States of America- people- beneficiaries
- :Donald-John: Trump, -POTUSA-CIC, -POTUSCorp- Trustee, -:PFTUSA-CIC, 'President for the united States of America'~ 1787 A.D., not incorporated~**
:William-Pelham: Barr, -:Common Law Trustee,
c/o :Donald-John: Trump :USPS RMN RE 322 387 620 US,
1600 Pennsylvania Ave NW, Washington, District of Columbia 20500 ;
:General James-Charles: McConville, Army, et al.- :Trustees
c/o General -:COS Army- Trustee :USPS CMN 7012 2210 0000 4269 7353 ;
:Stephen-G.: Breyer, et al.- Trustee Justices
c/o Scott-Sessions: Harris- Trustee :USPS CMN 7012 2210 0000 4269 7360 ;
:Mark: Lamb, et al.-:Sheriffs, Gila county, Ariz. State
c/o :Mark :Lamb, -:Trustee :USPS CMN 7012 2210 0000 4269 7377

:Darrell-James: Hill, -Negro, -civilian, -Ohioan, :-Executor -beneficiary; kinsman-redeemer: Negro-Ysrael, :Ysrael and the :Holy-Church unto the :Almighty-God, Yushuah~'Jesus~ the Messiah; ambassador for the Messiah Yushuah; Trustee: Concession-1213-A.D.

USPS RMN RE 322 387 616 US



1752

Proclamation-1863-A.D. and EBA-1933-A.D., :sole, and as :kinsman-redeemer.

:Obligors -to :Conusance: The 'U.S.' :all Agents⁵, elected and/or appointed of the 'UNITED STATES Corporation', -government-services-provider, -:Trustee: EBA-1933-A.D., -Legislative-Dry-Trust; and: the de-jure man: Donald-John: Trump, -:PFTUSA-1787 A.D.; -:POTUSA-1863 A.D.; -:POTUS-1933 A.D., et al.- :SCOTUS under the covenant. Thank-you, in advance.

:Cause -for :Harm: Gross Usurpation: Violation of the Right to the Fair, -Accurate -Election Process: For the UNITED STATES, -2020 A.D.- general-election with the establishment of the factual-failure of the 'UNITED-STATES- corp' -government- services-provider, -:Trustee: EBA-1933-A.D. to proactively assure and ensure the :efficient and accurate -election -service to the beneficiary- :united-States-of-America- people since the mid-1980's against the thieving-computing-technology and :espionage-therewith~ and other-methods~, was the required-duty and obligation set in the covenant by 'The Constitution for the United States of America' for to preserve the :sanctity for the sovereign-people- beneficiaries' elections is now fully in the :evidence necessitating the chose-retirement of the UNITED-STATES-Corporate -government -services- provider, -:Trustee-Derelict: EBA-1933-A.D. for the commonly-known cultivation of this thieving- technology~ and other-methods~ with the great harm to The united States of America-people by the at-will, - openly-confident, -reckless with :impunity -usurpation of the unalienable- rights of the entire -civilian-voter- body.

:Where, as the UNITED-STATES-corp., -:Trustee: EBA-1933-A.D., et al. presumes all people are UNITED-STATES -citizens by the :modus-operandii that the service-organization openly presumes :no-obligation to fulfill the :covenant- guarantee to the people for the :republican-form of government; and:

Where, as the UNITED-STATES-corp., -:Trustee: EBA-1933-A.D., et al. oath, duty and obligation as the servant-government-service- provider was to must-know and protect the fundamental rights and freedom ensured upon the united-States-of-America- people; and:

Where, as the UNITED-STATES-corp., -:Trustee: EBA-1933-A.D., et al. must-needed to safe-guard the united-States-of-America- people from the any :systematic, -politically-organized, -social-pressure and force of the B.A.R.- legal- system in the fiat; and;

Where, as the moral-principles and :divine-justice produced the :Declaration-of-Independence- 1776-A.D.- natural-rights: unalienable and absolutely-guaranteed; and;

Where, as the natural-rights exist independently of any government-services- provider, the unalienable rights to life, liberty and property-claimed and possessed remain unalienable-rights; and:

Where, as the natural-man-rights and freedoms are not created by the any government-services-provider(s) is cognizable and recognized by the every government-services-provider; and;

5 'U.S.' :all Agents: See: :Sovereign- Authorization to Establish :Lawful -Government:

:Kinsman-redeemer- 'Declaration of Independence of 1776 A.D.' -Sovereign-Authorization for the Present-Restoration of: 1) Common Law, 2) Lawful Money, and 3) 'The Constitution for the United States of America' for the united States of America- people- beneficiaries

:Donald-John: Trump, -:POTUSA-CIC, -POTUScorp- Trustee, -:PFTUSA-CIC, 'President for the united States of America'~ 1787 A.D., not incorporated~

:William-Pelham: Barr, -:Common Law Trustee,

c/o **:Donald-John: Trump** :USPS RMN RE 322 387 620 US, 1600 Pennsylvania Ave NW, Washington, District of Columbia 20500 ;

:General James-Charles: McConville, Army, et al.- :Trustees

c/o General -:COS Army- Trustee :USPS CMN 7012 2210 0000 4269 7353 ;

:Stephen-G.: Breyer, et al.- Trustee Justices

c/o Scott-Sessions: Harris- Trustee :USPS CMN 7012 2210 0000 4269 7360 ;

:Mark: Lamb, et al.-:Sheriffs, Gila county, Ariz. state

c/o **:Mark :Lamb, -:Trustee** :USPS CMN 7012 2210 0000 4269 7377

:Darrell-James: Hill, -Negro, -civilian, -:Ohioan, -:Executor -:beneficiary; kinsman-redeemer: Negro-Ysrael, :Ysrael and the :Holy-Church unto the :Almighty-God, Yushuah~'Jesus'~ the Messiah; ambassador for the Messiah Yushuah; Trustee: Concession-1213-A.D.

USPS RMN RE 322 387 620 US

2022-011769 MISC Page: 1762 of 2782

09/26/2022 03:35:37 PM Receipt #: 22-9381

Rec Fee: \$30.00 Darrell James Hill

Gila County, Az, Sadie Jo Bingham, Recorder



1753

Where, as :unalienable-rights are Not transferable or surrender-able; and:

Where, as upon the solemn-Oath by the swearing or affirmative that the statement is true and correct that :one, -:servant of the people will be bound to the covenant- :Declaration of Independence, et seq.- 'The Constitution for the United States of America'- et seq., implicitly invites punishment if that commitment is untrue or the covenant is broken; and;

Where, as the all evidence reports verify that the UNITED-STATES-Corp, et seq.- Trustee-Derelict: EBA-1933-A.D. -Legislative- Dry-Trust is broken; and

Where, as the evidence- reports verify that the UNITED-STATES-Corp, et seq.- Trustee-Derelict: EBA-1933-A.D. -Legislative- Dry-Trust is extinct; and

Whereas, by the sovereign-people -authority, :- man, sole, and as the kinsman-redeemer-uncontested, operate under the common-law obligation by the Declaration of Independence-1776 A.D.; – Thereto,

:This -common-law -remedy exercises in all law the :rights of, by and for the united-States-of-America- people-beneficiaries over-standing :in this demand to the obligor -man-actor-present, :Donald-John: Trump, in the authority of the office of the President of The United States of America fore the united- States-of-America – people to: a) terminate the UNITED-STATES-Corp., -Trustee-derelict: EBA-1933-A.D., and b) to restore to the people the :lawful-government with lawful money, with-under the common-law- presumption, with-under the Declaration of Independence, -1776 A.D. -righteous-authority over- onto: 'The Constitution for the United States of America', -1787 A.D., et seq. -Emancipation Proclamation-1863 A.D., et al.- :Lieber-Code- 1863 A.D., post haste, is now required, absolutely -guaranteed and completely now-exercised demanded -herewith.

cc:

Ken Paxton
Counsel of Record
Attorney General of Texas
P.O. Box 12548 (MC 059)
Austin, TX 78711-2548
kenneth.paxton@oag.texas.gov
512-936-1414
Party name: State of Texas

John Bartley DeLone
Counsel of Record
Attorney General's Office
Pennsylvania Office of Attorney General
-Appellate Litigation Section
15th Floor, Strawberry Square
Harrisburg, PA 17120
jdelone@attorneygeneral.gov
717-783-3226
Party name: Commonwealth of Pennsylvania

Andrew Alan Pinson
Counsel of Record
Office of the Georgia Attorney General
40 Capital Square SW
Atlanta, GA 30334-1300
apinson@law.ga.gov
404-458-3409
Party name: State of Georgia

Donald W. MacPherson
Counsel of Record

Thomas Charles Bellavia
Counsel of Record
Wisconsin Department of Justice
17 W. Main Street
PO Box 7857
Madison, WI 53707-7857
bellaviatc@doj.state.wi.us
6083337519
Party name: State of Wisconsin

Fadwa A. Hammoud
Counsel of Record
Michigan Department of Attorney General
P.O. Box 30212
Lansing, MI 48909
HammoudF1@michigan.gov
517-335-7628
Party name: State of Michigan

Charles R. Gerow
Counsel of Record
4725 Charles Road
Mechanicsburg, PA 17055
Cgerow@quantumcomms.com
717-877-8194
Party name: Members of the Pennsylvania General Assembly

D. John Sauer
Counsel of Record
Office of the Attorney General
Supreme Court Building,

:Darrell-James: Hill, -Negro, -civilian, -:Ohioan, -:Executor -:beneficiary; kinsman-redeemer: Negro-Ysrael, :Ysrael and the :Holy-Church unto the :Almighty-God, Yushuah~'Jesus'~ the Messiah; ambassador for the Messiah Yushuah; Trustee: Concession-1213-A.D.

USPS RMN RE 322 387 616 US

2022-011769 MISC Page: 1763 of 2782

09/26/2022 03:35:37 PM Receipt #: 22-9381
Rec Fee: \$30.00 Darrell James Hill, Recorder
Gila County, Az, Sadie Jo Bingham



1754

The MacPherson Group
24654 N Lake Pleasant Pkwy
Suite 103-551
Peoria, AZ 85383
mac@beatirs.com
6232092003

Party name: Lieutenant Governor Janice McGeachin, Senator Lora Reinbold, Representative David Eastment, et al. (Elected State Officials)

John C. Eastman
Counsel of Record
One University Drive
Orange, CA 92866
jeastman@chapman.edu
714-628-2587

Party name: Donald J. Trump, President of the United States

John Allen Eidsmoe
Counsel of Record
One Dexter Avenue
Montgomery, AL 36064
eidsmoeja@juno.com
3343241812

Party name: Constitutional Attorneys

Erick G. Kaardal
Counsel of Record
Mohrman, Kaardal & Erickson P.A.
150 South Fifth Street, Suite 3100
Minneapolis, MN 55402
kaardal@mklaw.com
612-465-0927

Party name: Ron Heuer, et al.

Jason Brett Torchinsky
Counsel of Record
Holtzman Vogel Josefiak Torchinsky PLLC
15405 John Marshall Hwy
Haymarket, VA 20169
jtorchinsky@hvjt.law
540 341 8808
Party name: Certain Select Pennsylvania State Senators

Dennis Grossman
Counsel of Record
6701 Sunset Drive
Suite 104
Miami, FL 33143
dagrossmanlaw@aol.com
5164666690

Party name: Christian Family Coalition

Phillip L. Jauregui Jr.
Counsel of Record
1300 I Street, NW
Suite 400 E
Washington, DC 20005

207 West High Street
P.O. Box 899
Jefferson City, MO 65102
john.sauer@ago.mo.gov
573-751-3321

Party name: State of Missouri

Richard Douglas Bernstein
Counsel of Record
1875 K Street, N.W.
Washington, DC 20006
rbernsteinlaw@gmail.com
3017752064

Party name: Carter Phillips, et al.

Brunn Wall Roysden III
Counsel of Record
Office of the Arizona Attorney General
2005 N. Central Ave.
Phoenix, AZ 85004
beau.roysden@azag.gov
602-542-5025

Party name: State of Arizona and Mark Brnovich, Arizona Attorney General

Benjamin Michael Flowers
Counsel of Record
Ohio Attorney General Dave Yost
30 E. Broad St.
Columbus, OH 43215
benjamin.flowers@ohioattorneygeneral.gov
6144668980

Party name: State of Ohio

Loren L. AliKhan
Counsel of Record
D.C. Office of the Attorney General
Office of the Solicitor General
400 6th Street, NW, Suite 8100
Washington, DC 20001
loren.alikhan@dc.gov
202-727-6287

Party name: District of Columbia on behalf of 22 States and Territories

Douglas Alexander Stewart Chalmers Jr.
Counsel of Record
Chalmers & Adams LLC
5805 State Bridge Road #G77
Johns Creek, GA 30097
dchalmers@cpblawgroup.com
770-630-5927

Party name: Bryan Cutler Speaker of the Pennsylvania House of Representatives and Kerry Benninghoff Majority Leader of the Pennsylvania House of Representatives

David H. Fink
Counsel of Record
Fink Bressack

:Darrell-James: Hill, -Negro, -civilian, -:Ohioan, :-Executor -:beneficiary; kinsman-redeemer: Negro-Ysrael, :Ysrael and the :Holy-Church unto the :Almighty-God, Yushuah~'Jesus'~ the Messiah; ambassador for the Messiah Yushuah; Trustee: Concession-1213-A.D.

2022-011769 MISC Page: 1764 of 2782
09/26/2022 09:35:37 PM Receipt #: 22-9381
Rec Fee: \$30.00 Darrell James Hill
Gila County, Az, Sadie Jo Bingham, Recorder



1755

plj@judicialactiongroup.com
202-216-9309
Party name: U.S. Representative Mike Johnson and 105 Other Members

Nathaniel Kyle MacPherson
Counsel of Record
The MacPherson Group, LLC
24654 N. Lake Pleasant Pkwy.
Suite 103-551
Peoria, AZ 85383
nathan@beatirs.com
6232092003

Party name: Lieutenant Governor Janice McGeachin, Senator Lora Reinbold, Representative David Eastman, et al (Elected Officials) as Amici Curiae

L. Lin Wood Jr.
Counsel of Record
P.O. Box 52584
Atlanta, GA 30355-0584
lwood@linwoodlaw.com
4049833284
Party name: L. Lin Wood

38500 Woodward Ave, Suite 350
Bloomfield Hills, MI 48304
dfink@finkbressack.com
2489712500
Party name: City of Detroit

James L. Hirsen
Counsel of Record
505 S. Villa Real Drive
Suite 101
Anaheim Hills, CA 92807
james@jameshirsen.com
714-283-8880
Party name: Justice and Freedom Fund in Support of Plaintiff

James A. Davids
Counsel of Record
741 Sand Willow Dr.
Chesapeake, VA 23320
jimdavids@gmail.com
(757) 576-9610
Party name: Ga. state Sen. William Ligon et al.

I, the undersigned, do hereby affirm to above stated is true and correct, and will state same in the open court.

Without prejudice,

Darrell James Hill
Darrell-James: Hill, -Negro, -civilian, -Ohioan, -Executor

-:beneficiary;

:kinsman-redeemer: Negro-Ysrael, :Ysrael and the:Holy-Church of the :Almighty-God; Yushuah~'Jesus'~ the Messiah;

:ambassador of :Messiah- Yushuah for :Health and Wholeness;

:Trustee: Concession-1213-A.D.

Affirmed and autographed before me this day 11 December 2020 A.D.
Type of Identification: Arizona Driver License

Chyrl Smith
Notary-public

SEAL

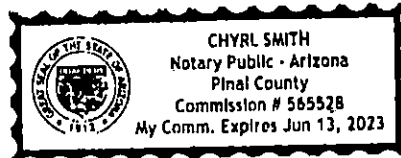

2022-011769 MISC Page: 1765 of 2782

09/26/2022 03:35:37 PM Receipt #: 22-9381
Rec Fee: \$30.00 Darrell James Hill
Gila County, Az, Sadie Jo Bingham, Recorder

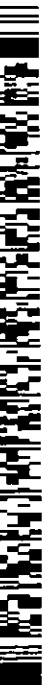

:Darrell-James: Hill, -Negro, -civilian, -Ohioan, -Executor -:beneficiary; kinsman-redeemer: Negro-Ysrael, :Ysrael and the :Holy-Church unto the :Almighty-God, Yushuah~'Jesus'~ the Messiah; ambassador for the Messiah Yushuah; Trustee: Concession-1213-A.D.

1756



APACHE JUNCTION
151 W SUPERSTITION BLVD
APACHE JUNCTION, AZ 85120-9998
(800)275-8777

12/11/2020 04:21 PM

Product	Qty	Unit Price	Price
First-Class Mail® Letter	1		\$0.70
Washington, DC 20543			
Weight: 0 lb 1.20 oz			
Estimated Delivery Date			
Tue 12/15/2020			
Registered Mail®			\$13.20
Amount: \$21.00			
Tracking #: RE322387616US			
Return Receipt (electronic)			\$2.85
Tracking #: 9590 9402 4718 8344 9800 62			
Total			\$16.75
Grand Total:			\$16.75
Cash			\$16.75

Due to limited transportation availability as a result of nationwide COVID-19 impacts

Registered No. RE322387616US

To Be Completed By Post Office	Postage \$	\$0.70	Extra Services & Fees (continue)
	Extra Services & Fees		<input type="checkbox"/> Signature Confirmation
	<input type="checkbox"/> Registered Mail \$	\$13.20	<input type="checkbox"/> Signature Confirmation Restricted Delivery
	<input type="checkbox"/> Return Receipt (hardcopy) \$	\$2.85	
	<input type="checkbox"/> Return Receipt (electronic) \$	\$0.00	
	<input type="checkbox"/> Restricted Delivery \$	\$0.00	Total Postage & Fees \$16.75
Customer Must Declare Full Value	\$21.00	Received by	12/11/2020

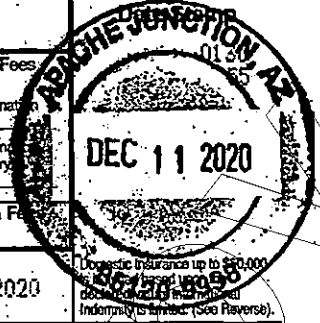

OFFICIAL USE

To Be Completed By Customer (Please Print) All Entries Must Be In Ballpoint or Typed	FROM	APACHE JUNCTION, AZ 85120 Darrell James Hill PO Box 3806 Apache Junction Arizona 85117
	TO	Steven G. Brewer Supreme Court of the United States 1 First Street NE Washington, DC 20543

PS Form 3806, Registered Mail Receipt April 2015 Copy 1 - Customer (See Information on Reverse)

Unofficial



USPS Tracking®

[FAQs >](#)

[Track Another Package +](#)

Tracking Number: RE322387616US

[Remove X](#)

Your item was delivered at 10:40 am on December 22, 2020 in WASHINGTON, DC 20543.

Delivered

December 22, 2020 at 10:40 am
WASHINGTON, DC 20543

[Feedback](#)

[Get Updates v](#)

Text & Email Updates 

Tracking History 

December 22, 2020, 10:40 am

Delivered

WASHINGTON, DC 20543

Your item was delivered at 10:40 am on December 22, 2020 in WASHINGTON, DC 20543.

1758

2022-011769 MISC Page: 1767 of 2782
09/26/2022 03:35:37 PM Receipt #: 22-9381
Rec Fee: \$30.00 Darrell James Hill
Gila County, Az, Sadie Jo Bingham, Recorder



December 18, 2020, 3:55 pm

Arrived at Post Office
WASHINGTON, DC 20066

December 12, 2020, 8:42 pm

Arrived at USPS Facility
DULLES, VA 20101

December 12, 2020, 12:07 am

Departed USPS Facility
PHOENIX, AZ 85026

December 12, 2020, 12:05 am

Arrived at USPS Facility
PHOENIX, AZ 85026

December 11, 2020, 4:37 pm

Departed Post Office
APACHE JUNCTION, AZ 85120

December 11, 2020, 4:15 pm

USPS in possession of item
APACHE JUNCTION, AZ 85120

Feedback

Product Information 

See Less 

2022-011769 MISC Page: 1768 of 2782
09/26/2022 03:35:37 PM Receipt #: 22-9381
Rec Fee: \$30.00 Darrell James Hill
Gila County, Az, Sadie Jo Bingham, Recorder



1759

UNOFFICIAL COPY

USPS Tracking®

[FAQs >](#)

[Track Another Package +](#)

Tracking Number: RE322387620US

[Remove X](#)

Your item was delivered at 3:49 am on December 3, 2020 in WASHINGTON, DC 20500.

 **Delivered**

December 3, 2020 at 3:49 am
WASHINGTON, DC 20500

[Feedback](#)

[Get Updates v](#)

Text & Email Updates v

Tracking History ^

December 3, 2020, 3:49 am
Delivered
WASHINGTON, DC 20500

Your item was delivered at 3:49 am on December 3, 2020 in WASHINGTON, DC 20500.

November 28, 2020, 1:02 am

2022-011769 MISC Page: 1769 of 2782
09/26/2022 03:35:37 PM Receipt #: 22-9381
Rec Fee: \$30.00 Darrell James Hill
Gila County, Az, Sadie Jo Bingham, Recorder



Arrived at Post Office
WASHINGTON, DC 20066

November 27, 2020
In Transit to Next Facility

November 25, 2020, 10:20 am
Arrived at USPS Regional Destination Facility
WASHINGTON DC DISTRIBUTION CENTER

November 24, 2020, 9:38 pm
Arrived at USPS Facility
DULLES, VA 20101

November 24, 2020, 12:19 am
Departed USPS Facility
PHOENIX, AZ 85026

November 24, 2020, 12:17 am
Arrived at USPS Facility
PHOENIX, AZ 85026

November 23, 2020, 4:46 pm
Departed Post Office
APACHE JUNCTION, AZ 85120

November 23, 2020, 2:54 pm
USPS in possession of item
APACHE JUNCTION, AZ 85120

1761

Official Copy

Feedback

2022-011769 MISC Page: 1770 of 2782
09/25/2022 03:35:37 PM Receipt #: 22-9381
Rec Fee: \$30.00 Darrell James Hill
Gila County, Az, Sadie Jo Bingham, Recorder



USPS Tracking®

[FAQs >](#)

[Track Another Package +](#)

Tracking Number: 70122210000042697353

[Remove X](#)

Your item was delivered at 7:04 am on November 30, 2020 in WASHINGTON, DC 20310.

Delivered

November 30, 2020 at 7:04 am
WASHINGTON, DC 20310

[Feedback](#)

[Get Updates v](#)

Text & Email Updates 

Tracking History 

November 30, 2020, 7:04 am

Delivered

WASHINGTON, DC 20310

Your item was delivered at 7:04 am on November 30, 2020 in WASHINGTON, DC 20310.

2022-011769 MISC Page: 1771 of 2782
09/26/2022 03:35:37 PM Receipt #: 22-9381
Rec Fee: \$30.00 Darrell James Hill
Gila County, Az, Sadie Jo Bingham, Recorder



November 28, 2020, 11:55 am

Available for Pickup

WASHINGTON, DC 20310

November 28, 2020, 9:12 am

Arrived at Post Office

WASHINGTON, DC 20018

November 27, 2020

In Transit to Next Facility

November 23, 2020, 10:50 pm

Departed USPS Regional Origin Facility

PHOENIX AZ DISTRIBUTION CENTER

November 23, 2020, 8:22 pm

Arrived at USPS Regional Origin Facility

PHOENIX AZ DISTRIBUTION CENTER

November 23, 2020, 4:46 pm

Departed Post Office

APACHE JUNCTION, AZ 85120

November 23, 2020, 2:56 pm

USPS in possession of item

APACHE JUNCTION, AZ 85120

Official Copy

Feedback

Product Information 

1763

See Les

2022-011769 MISC Page: 1772 of 2782

09/26/2022 03:35:37 PM Receipt #: 22-9381

Rec Fee: \$30.00 Darrell James Hill

Gila County, Az, Sadie Jo Bingham, Recorder



USPS Tracking®

[FAQs >](#)

Track Another Package +

Tracking Number: 70122210000042697360

Remove X

Your item was delivered at 6:53 am on November 30, 2020 in WASHINGTON, DC 20543.

✓ Delivered

November 30, 2020 at 6:53 am
WASHINGTON, DC 20543

Feedback

Get Updates ▾

Text & Email Updates ▾

Tracking History ▲

November 30, 2020, 6:53 am

Delivered

WASHINGTON, DC 20543

Your item was delivered at 6:53 am on November 30, 2020 in WASHINGTON, DC 20543.

2022-011769 MISC Page: 1773 of 2782
09/26/2022 03:35:37 PM Receipt #: 22-9381
Rec Fee: \$30.00 Darrell James Hill
Gila County, Az, Sadie Jo Bingham, Recorder



November 28, 2020, 11:57 am

Available for Pickup

WASHINGTON, DC 20543

November 28, 2020, 10:50 am

Arrived at Post Office

WASHINGTON, DC 20018

November 27, 2020

In Transit to Next Facility

November 23, 2020, 9:42 pm

Departed USPS Regional Origin Facility

PHOENIX AZ DISTRIBUTION CENTER

November 23, 2020, 8:23 pm

Arrived at USPS Regional Origin Facility

PHOENIX AZ DISTRIBUTION CENTER

November 23, 2020, 4:46 pm

Departed Post Office

APACHE JUNCTION, AZ 85120

November 23, 2020, 2:56 pm

USPS in possession of item

APACHE JUNCTION, AZ 85120

1765

Product Information



See Le

2022-011769 MISC Page: 1774 of 2782
09/26/2022 03:35:37 PM Receipt #: 22-9381
Rec Fee: \$30.00 Darrell James Hill
Gila County, Az, Sadie Jo Bingham, Recorder



Feedback

USPS Tracking®

[FAQs >](#)

[Track Another Package +](#)

Tracking Number: 70122210000042697377

[Remove X](#)

Your item was delivered at 10:12 am on November 25, 2020 in FLORENCE, AZ 85132.

Delivered

November 25, 2020 at 10:12 am
FLORENCE, AZ 85132

[Feedback](#)

[Get Updates ▾](#)

Text & Email Updates 

Tracking History 

1700
November 25, 2020, 10:12 am
Delivered
FLORENCE, AZ 85132

Your item was delivered at 10:12 am on November 25, 2020 in FLORENCE, AZ 85132.

November 25, 2020, 8:08 am

2022-011769 MISC Page: 1775 of 2782
09/26/2022 03:35:37 PM Receipt #: 22-9381
Rec Fee: \$30.00 Darrell James Hill
Gila County, Az, Sadie Jo Bingham, Recorder



Available for Pickup
FLORENCE, AZ 85132

November 25, 2020, 7:54 am
Arrived at Post Office
FLORENCE, AZ 85132

November 24, 2020, 2:52 pm
Departed USPS Regional Facility
PHOENIX AZ DISTRIBUTION CENTER

November 23, 2020, 8:27 pm
Arrived at USPS Regional Facility
PHOENIX AZ DISTRIBUTION CENTER

November 23, 2020, 4:46 pm
Departed Post Office
APACHE JUNCTION, AZ 85120

November 23, 2020, 2:56 pm
USPS in possession of item
APACHE JUNCTION, AZ 85120

Feedback

Product Information 

See Less 

1767

2022-011769 MISC Page: 1776 of 2782
09/26/2022 03:35:37 PM Receipt #: 22-9381
Rec Fee: \$30.00 Darrell James Hill
Gila County, Az, Sadie Jo Bingham, Recorder



398 389 US

	:man- trustee	:association	:year, :day	USPO, other	:covenant
45	↓	↓	01/14/21	:In :Hill-court of :Record At: Maricopa-County-Superior-Court, :Claim: matter#: RE 322 398 389 US - 8) :matter 3 RE 322 398 389 US :ORDERS :PE and Lot -One- Covenant- agreement	↓↓ :Darrell-James: Hill, -:Ohioan- beneficiary- Executor: DOI-1776-A.D.: beneficiary- civilian -:Executor: EBA-1933-A.D. -PE-2016-A.D., et seq.- :covenants with the law of the covenants by the law of the DOI-1776-A.D. -PE-2016-A.D.- covenants, -:Procurator: procurator: Darrell-James: Hill, -:Executor. ::Darrell-James: Hill, -:Ohioan, -:civilian, -:Executor, -:Procurator for the Respondent, -:Claim: matter#: RE 322 398 389 US
46	↓ :Donald-John: Trump, et al.: ... Under the Procurator for the respondent, :Darrell- James: Hill, man- Procurator	↓ POTUS, -:Respondent, et al. -:Claim: matter#: RE 322 398 389 US :Darrell-James: Hill, -:Ohioan, -:civilian, -:Executor, -:Procurator for the Respondent, -:Claim: matter#: RE 322 398 389 US	01/14/21	:In :Hill-court of :Record At: Maricopa-County-Superior-Court, :Claim: matter#: RE 322 398 389 US - 9) :matter # RE 322 398 389 :ORDERS :PE and Lot -Two- Covenant- agreement	
47	↓	↓	01/14/21	:In :Hill-court of :Record At:	

2022-011769 MISC Page: 1777 of 2782
 09/26/2022 03:35:37 PM Receipt #: 22-9381
 Rec Fee: \$30.00 Darrell James Hill
 Gila County, Az, Sadie Jo Bingham, Recorder



1017

See: stipulations: procurator as respondent. -verified-, 3 pgs.

	:man- trustee	:association	:year, :day	USPO, other	:covenant
43	↓	↓	01/14/21	:In :Hill-court of :Record At: Maricopa-County-Superior-Court, :Claim: matter#: RE 322 398 389 US -	↓ :Darrell-James: Hill, -:Ohioan- beneficiary- Executor: DOI-1776-A.D.: beneficiary- civilian -:Executor: EBA-1933-A.D. -PE-2016-A.D., et seq.- :covenants with the law of the covenants by the law of the DOI-1776-A.D. -PE-2016-A.D.- covenants, -:Procurator: procurator: Darrell-James: Hill, -:Executor. ::Darrell-James: Hill, -:Ohioan, -:civilian, -:Executor, -:Procurator for the Respondent, -:Claim: matter#: RE 322 398 389 US
44	↓ :Donald-John: Trump, et al.: Under the Procurator for the respondent, :Darrell- James: Hill, man- Procurator	↓ POTUS, -:Respondent, et al. -:Claim: matter#: RE 322 398 389 US :Darrell-James: Hill, -:Ohioan, -:civilian, -:Executor, -:Procurator for the Respondent, -:Claim: matter#: RE 322	01/14/21	:In :Hill-court of :Record At: Maricopa-County-Superior-Court, :Claim: matter#: RE 322 398 389 US - 7) :matter # RE 322 298 289-US :declaration- :stipulations: procurator as respondent -verified-, 6 pgs.	↓



1780

:William-Pelham: Barr,
:Seve-Turner: Mnuchin,
:Brian: Karth,
:Ranier-Christercunean:
Collins,
:John and Jan Doe –

RE 322 398 389 US

Under the Procuration
for the
respondent, :Darrell-
James: Hill, man-
Procurator

38 :Donald-John: Trump, et
al.:

Under the Procuration
for the
respondent, :Darrell-
James: Hill, man-
Procurator

POTUS, -:Respondent, et
al. -:Claim: matter#: RE
322 398 389 US

:Darrell-James: Hill,
-:Ohioan, -:civilian,
-:Executor, -:Procurator
for the Respondent,
-:Claim: matter#: RE 322
398 389 US

01/14/21

:In :Hill-court of :Record At:
Maricopa-County-Superior-Court,
:Claim: matter#: **RE 322 398 389**
US

1) :notice:
see claim: matter # RE 322 398 389
US

See- appended:
claim – executed;
:declaration: right of claim, with:
declaration: averments; claimant,

See- appended: Respondent:

↓
::Darrell-James: Hill, -:Ohioan- beneficiary-
Executor: DOI-1776-A.D.: beneficiary- civilian
-:Executor: EBA-1933-A.D. -PE-2016-A.D., et
seq.- :covenants with the law of the covenants by
the law of the DOI-1776-A.D. -PE-2016-A.D.-
covenants, -:Procuration: procurator: Darrell-James:
Hill, -:Executor.

↓
::Darrell-James: Hill, -:Ohioan, -:civilian, -:Executor,
-:Procurator for the Respondent, -:Claim: matter#:
RE 322 398 389 US



35	:Scott: Mascher c/o :Mark: Lamb, -:Sheriff, -:Pinal c/o: Paul: Penzone	Yavapai-County-Arizona- State, -:Sheriff	↓	↓	↓
	:man- trustee	:association	:year, :day	USPO, other	:covenant
36	Leon: Wilmot c/o :Mark: Lamb, -:Sheriff, -:Pinal c/o: Paul: Penzone	:Yuma-County-Arizona- State, -:Sheriff	↓ 01/15/21	↓ 7010 1060 0001 7518 9154 7012 2210 0000 4269 7384	↓ :Darrell-James: Hill, -:Ohioan- beneficiary- Executor: DOI-1776-A.D. -:Treaty-of-Paris-1783-A.D., -:Concession-1213-A.D.; beneficiary- Executor: EBA-1933-A.D.; Ambassador of the Almighty-God, -:Trustee: Concession-1213-A.D. ~ -2020-A.D. :Authorization for the Restoration of the Lawful- Government
	:man- trustee	:association	:year, :day	USPO, other	:covenant
37	:Donald-John: Trump, et al.: Barack- Hussein: Obama, :Loretta: Lynch, :Jefferson-Beauregard: Sessions III, :Matthew-George: Whitaker, :Dana-James: Boente, :Sally-Caroline: Yates,	POTUS, -:Respondent, et al. -:Claim: matter#: RE 322 398 389 US :Darrell-James: Hill, -:Ohioan, -:civilian, -:Executor, -:Procurator for the Respondent, -:Claim: matter#: RE 322 398 389 US	01/14/21	:In :Hill-court of :Record At: Maricopa-County-Superior-Court, :Claim: matter#: RE 322 398 389 US	::Darrell-James: Hill, -:Ohioan- beneficiary- Executor: DOI-1776-A.D.: beneficiary- civilian -:Executor: EBA-1933-A.D. -PE-2016-A.D., et seq.- :covenants with the law of the covenants by the law of the DOI-1776-A.D. -PE-2016-A.D.- covenants, -:Procurator: procurator: Darrell-James: Hill, -:Executor. ::Darrell-James: Hill, -:Ohioan, -:civilian, -:Executor, -:Procurator for the Respondent, -:Claim: matter#:



41

01/14/21

:In :Hill-court of :Record At:
Maricopa-County-Superior-Court,
:Claim: matter#: RE 322 398 389
US --

:Darrell-James: Hill, -:Ohioan- beneficiary-
Executor: DOI-1776-A.D.: beneficiary- civilian
-:Executor: EBA-1933-A.D. -PE-2016-A.D., et
seq.- :covenants with the law of the covenants by
the law of the DOI-1776-A.D. -PE-2016-A.D.-
covenants, -:Procurator: procurator: Darrell-James:
Hill, -:Executor.

4) :claim – executed:
:matter # RE 322 398 389 US

common-theft,
with penalty-agreement,
with :respondent :in-dishonor

::Darrell-James: Hill, -:Ohioan, -:civilian, -:Executor,
-:Procurator for the Respondent, -:Claim: matter#:
RE 322 398 389 US

42

01/14/21

:In :Hill-court of :Record At:
Maricopa-County-Superior-Court,
:Claim: matter#: RE 322 398 389
US --

:Darrell-James: Hill, -:Ohioan- beneficiary-
Executor: DOI-1776-A.D.: beneficiary- civilian
-:Executor: EBA-1933-A.D. -PE-2016-A.D., et
seq.- :covenants with the law of the covenants by
the law of the DOI-1776-A.D. -PE-2016-A.D.-
covenants, -:Procurator: procurator: Darrell-James:
Hill, -:Executor.

:Donald-John: Trump, et POTUS, -:Respondent, et
al.: ... al. -:Claim: matter#: RE
322 398 389 US

Under the Procurator
for the
respondent, :Darrell-
James: Hill, man-
Procurator

:Darrell-James: Hill,
-:Ohioan, -:civilian,
-:Executor, -:Procurator
for the Respondent,
-:Claim: matter#: RE 322
398 389 US

5) :declaration: right of claim
:in 'out of court-judgment'-matter
:in the non-controversy
:under- procuratinon- expressed
:in- accordance with :covenant- as
:stipulated-to and agreed-upon

::Darrell-James: Hill, -:Ohioan, -:civilian, -:Executor,
-:Procurator for the Respondent, -:Claim: matter#:
RE 322 398 389 US

See: declaration; averments;
claimant



declaration; stipulations;
procurator as respondent

notice of receipt of claim; formal
summons waived; 2 pg.

	:man- trustee	:association	:year, :day	USPO, other	:covenant
--	---------------	--------------	-------------	-------------	-----------

39	↓	↓	01/14/21	:In :Hill-court of :Record At: Maricopa-County-Superior-Court, :Claim: matter#: RE 322 398 389 US -	↓
----	---	---	----------	--	---

2) Service of Claim – Notice: matter
RE 322 398 389 US; 1 pg.

40	↓	↓	01/14/21	:In :Hill-court of :Record At: Maricopa-County-Superior-Court, :Claim: matter#: RE 322 398 389 US -	↓
----	---	---	----------	--	---

Under the Procuration
for the
respondent, :Darrell-
James: Hill, man-
Procurator

:Darrell-James: Hill,
-:Ohioan, -:civilian,
-:Executor, -:Procurator
for the Respondent,
-:Claim: matter#: RE 322
398 389 US

3) :claim – executed:
:matter # RE 322 398 389 US
:Executor- Waiver of :Recordation
and Court-of-Record Fees; 1 pg.

	:man- trustee	:association	:year, :day	USPO, other	:covenant
--	---------------	--------------	-------------	-------------	-----------



1778

	:Sheriff, -:Pinal c/o: Paul: Penzone				
31	:Doug: Schuster c/o :Mark: Lamb, -:Sheriff, -:Pinal c/o: Paul: Penzone	:Mohave-County-Arizona- State, -:Sheriff	↓	↓	↓
	:man- trustee	:association	:year, :day	USPO, other	:covenant
32	:David: Clouse c/o :Mark: Lamb, -:Sheriff, -:Pinal c/o: Paul: Penzone	:Navajo-County-Arizona- State, -:Sheriff	↓	↓	↓
				7010 1060 0001 7518 9154 7012 2210 0000 4269 7384	
	:man- trustee	:association	:year, :day	USPO, other	:covenant
33	:Mark: Napier c/o :Mark: Lamb, -:Sheriff, -:Pina c/o: Paul: Penzone	:Pima-County-Arizona- State, -:Sheriff	↓ 01/15/21	↓ 7010 1060 0001 7518 9154 7012 2210 0000 4269 7384	↓ :Darrell-James: Hill, -:Ohioan- beneficiary- Executor: DOI-1776-A.D. -:Treaty-of-Paris-1783-A.D., -:Concession-1213-A.D.; beneficiary- Executor: EBA-1933-A.D.; Ambassador of the Almighty-God, -:Trustee: Concession-1213-A.D. ~ -2020-A.D. :Authorization for the Restoration of the Lawful- Government
34	:Tony: Estrada c/o :Mark: Lamb, -:Sheriff, -:Pinal c/o: Paul: Penzone	:Santa-Criz-County- Arizona-State, -:Sheriff	↓	↓	↓



Handwritten signature and date:
 2022
 9/26
 1775

c/o: Paul: Penzone

7012 2210 0000 4269 7384

:-Concession-1213-A.D.; beneficiary- Executor:
EBA-1933-A.D.; Ambassador of the Almighty-God,
:-Trustee: Concession-1213-A.D. ~ -2020-A.D.

:Authorization for the Restoration of the Lawful-
Government

27 :Adam: Shephard
c/o :Mark: Lamb,
-:Sheriff, -:Pinal
c/o: Paul: Penzone

:Gila-County-Arizona-
State, -:Sheriff

↓

↓

↓

28 :Preston: Allred
c/o :Mark: Lamb,
-:Sheriff, -:Pinal

:Graham-County-Arizona-
State, -:Sheriff

↓

↓

↓

:man- trustee

:association

:year, :day

USPO, other

:covenant

29 :Tim: Sumner
c/o :Mark: Lamb,
-:Sheriff, -:Pinal
c/o: Paul: Penzone

:Greenlee-County-
Arizona-State, -:Sheriff

↓

01/15/21

7010 1060 0001 7518 9154

↓

7012 2210 0000 4269 7384

↓

:Darrell-James: Hill, -:Ohioan- beneficiary- Executor:
DOI-1776-A.D. -:Treaty-of-Paris-1783-A.D.,
:-Concession-1213-A.D.; beneficiary- Executor:
EBA-1933-A.D.; Ambassador of the Almighty-God,
:-Trustee: Concession-1213-A.D. ~ -2020-A.D.

:Authorization for the Restoration of the Lawful-
Government

30 :Bill: Risen
c/o :Mark: Lamb,

:La- Paz -County-
Arizona-State, -:Sheriff

↓

↓

↓



		State, -Sheriff			DOI-1776-A.D. -:Treaty-of-Paris-1783-A.D., -:Concession-1213-A.D.; beneficiary- Executor: EBA-1933-A.D.; Ambassador of the Almighty-God, -:Trustee: Concession-1213-A.D. ~ -2020-A.D.
23	:Paul: Penzone	:Maricopa-County- Arizona-State, -Sheriff	01/15/21	7012 2210 0000 4269 7384	:Darrell-James: Hill, -:Ohioan- beneficiary- Executor: DOI-1776-A.D. -:Treaty-of-Paris-1783-A.D., -:Concession-1213-A.D.; beneficiary- Executor: EBA-1933-A.D.; Ambassador of the Almighty-God, -:Trustee: Concession-1213-A.D. ~ -2020-A.D.
					:Authorization for the Restoration of the Lawful- Government
24	:Joshep: Dedman, Jr. c/o :Mark: Lamb, -:Sheriff, -:Pinal, c/o: Paul: Penzone	:Apache-County-Arizona- State, -:Sheriff	↓	7010 1060 0001 7518 9154 7012 2210 0000 4269 7384	↓
25	:Mark: Dannels c/o :Mark: Lamb, -:Sheriff, -:Pinal c/o: Paul: Penzone	:Cochise-County-Arizona- State, -:Sheriff	↓		↓
26	:Jim: Driscoll c/o :Mark: Lamb, -:Sheriff, -:Pinal	:Coconino-County- Arizona-State, -:Sheriff	01/15/21	7010 1060 0001 7518 9154	:Darrell-James: Hill, -:Ohioan- beneficiary- Executor: DOI-1776-A.D. -:Treaty-of-Paris-1783-A.D.,



1773

17	:Michael-Martin-Gilday c/o :James-Charles: McConville	USofA- military- Admiral	↓	↓	↓
18	:David-Lee: Goldfein c/o :James-Charles: McConville	USofA- military- General	↓ 01/15/21	↓ 7009 2820 0003 8851 6100	↓
19	:John-William: Raymond c/o :James-Charles: McConville	USofA- military- General	↓	↓	↓
	:man- trustee	:association	:year, :day	USPO, other	:covenant
20	:Joseph-Lauren: Lengyel c/o :James-Charles: McConville	USofA- military- General	↓	↓	↓
21	:Karl-Leo: Schultz c/o :James-Charles: McConville	USofA- military- Admiral	↓ 01/15/21	↓ 7009 2820 0003 8851 6100	↓ :Darrell-James: Hill, -:Ohioan- beneficiary- Executor: DOI-1776-A.D. -:Treaty-of-Paris-1783-A.D., -:Concession-1213-A.D.; beneficiary- Executor: EBA-1933-A.D.; Ambassador of the Almighty-God, -:Trustee: Concession-1213-A.D. ~ -2020-A.D. :Authorization for the Restoration of the Lawful- Government
	:man- trustee	:association	:year, :day	USPO, other	:covenant
22	:Mark: Lamb	:Pinal-County-Arizona-	01/15/21	7010 1060 0001 7518 9154	:Darrell-James: Hill, -:Ohioan- beneficiary- Executor:



13	:James-Charles: McConville	United-States-of-America-1787-A.D. -USofA- -military- General	↓ 01/15/21	7009 2820 0003 8851 6100	↓ :Darrell-James: Hill, -:Ohioan- beneficiary- Executor: DOI-1776-A.D. -:Treaty-of-Paris-1783-A.D., -:Concession-1213-A.D.; beneficiary- Executor: EBA-1933-A.D.; Ambassador of the Almighty-God, -:Trustee: Concession-1213-A.D. ~ -2020-A.D. :Authorization for the Restoration of the Lawful-Government
14	:Mark-Alexander: Milley c/o :James-Charles: McConville	USofA- military- General	↓	↓	↓
15	:John-Earl: Hyten c/o :James-Charles: McConville	USofA- military- General	↓	↓	↓
	:man- trustee	:association	:year, :day	USPO, other	:covenant
16	:David-Hilberry: Berger c/o :James-Charles: McConville	USofA- military- General	↓ 01/15/21	7009 2820 0003 8851 6100	↓ :Darrell-James: Hill, -:Ohioan- beneficiary- Executor: DOI-1776-A.D. -:Treaty-of-Paris-1783-A.D., -:Concession-1213-A.D.; beneficiary- Executor: EBA-1933-A.D.; Ambassador of the Almighty-God, -:Trustee: Concession-1213-A.D. ~ -2020-A.D. :Authorization for the Restoration of the Lawful-Government



9	:Steve-Turner: Mnuchin c/o: :Donald-John: Trump	:POTUS, et al. - under :Procuation for the respndent: Darrell-James: Hill, -:man, -:Procurator	↓ 01/15/21	↓ 7008 1830 0002 1028 2082	↓ :Darrell-James: Hill, -:Ohioan- beneficiary- Executor: DOI-1776-A.D. -:Treaty-of-Paris-1783-A.D., -:Concession-1213-A.D.; beneficiary- Executor: EBA-1933-A.D.; Ambassador of the Almighty-God, -:Trustee: Concession-1213-A.D. ~ -2020-A.D. :Authorization for the Restoration of the Lawful- Government
10	:Brian: Karth c/o: :Donald-John: Trump	↓	↓	↓	↓
11	:Ranier-Christercunean: Collins c/o: :Donald-John: Trump	↓	12/30/99	↓	↓
12	:John and Jane- Does c/o: :Donald-John: Trump	:POTUS, et al. - under :Procuation for the respndent: Darrell-James: Hill, -:man, -:Procurator	↓ 01/15/21	↓ 7008 1830 0002 1028 2082	↓ :Darrell-James: Hill, -:Ohioan- beneficiary- Executor: DOI-1776-A.D. -:Treaty-of-Paris-1783-A.D., -:Concession-1213-A.D.; beneficiary- Executor: EBA-1933-A.D.; Ambassador of the Almighty-God, -:Trustee: Concession-1213-A.D. ~ -2020-A.D. :Authorization for the Restoration of the Lawful- Government

:man- trustee

:association

:year, :day

USPO, other

:covenant



Sessions III

c/o: :Donald-John:
Trump

	:man- trustee	:association	:year, :day	USPO, other	:covenant
5	:Matthew-George: Whitaker c/o: :Donald-John: Trump	↓	↓	↓	↓
6	:Dana-James: Boente c/o: :Donald-John: Trump	:POTUS, et al. - under :Procuation for the respndent: Darrell-James: Hill, -:man, -:Procurator	↓ 01/15/21	↓ 7008 1830 0002 1028 2082	↓ :Darrell-James: Hill, -:Ohioan- beneficiary- Executor: DOI-1776-A.D. -:Treaty-of-Paris-1783-A.D., -:Concession-1213-A.D.; beneficiary- Executor: EBA-1933-A.D.; Ambassador of the Almighty-God, -:Trustee: Concession-1213-A.D. ~ -2020-A.D. :Authorization for the Restoration of the Lawful- Government
7	:Sally-Caroline: Yates c/o: :Donald-John: Trump	↓	↓	↓	↓
8	:William-Pelham: Barr c/o: :Donald-John: Trump	↓	↓	↓	↓
	:man- trustee	:association	:year, :day	USPO, other	:covenant



1109

:2021 A.D.

#	:man- trustee	:association	:year, :day	USPO, other	:covenant
1	:Donald-John: Trump, et al. c/o: Darrell-James: Hill	:POTUS, et al. - under :Procuation for the respndent: Darrell-James: Hill, -:man, -:Procurator :Procurator- minister	↓	7008 1830 0002 1028 2082	:Darrell-James: Hill, -:Ohioan- beneficiary- Executor: DOI-1776-A.D. -:Treaty-of-Paris-1783-A.D., -:Concession-1213-A.D.; beneficiary- Executor: EBA-1933-A.D.; Ambassador of the Almighty-God, -:Trustee: Concession-1213-A.D. ~ -2020-A.D. :Authorization for the Restoration of the Lawful- Government
2	:Barack-Hussien: Obama, c/o: :Donald-John: Trump	↓	↓	↓	↓
3	Loretta: Lynch c/o: :Donald-John: Trump	:POTUS, et al. - under :Procuation for the respndent: Darrell-James: Hill, -:man, -:Procurator	01/15/21	7008 1830 0002 1028 2082	:Darrell-James: Hill, -:Ohioan- beneficiary- Executor: DOI-1776-A.D. -:Treaty-of-Paris-1783-A.D., -:Concession-1213-A.D.; beneficiary- Executor: EBA-1933-A.D.; Ambassador of the Almighty-God, -:Trustee: Concession-1213-A.D. ~ -2020-A.D. :Authorization for the Restoration of the Lawful- Government
4	:Jefferson-Beauregard:	↓	↓	↓	↓

Maricopa-County-Superior-Court,
:Claim: matter#: RE 322 398 389
US --

10) :matter # RE 322 398 389 US
:ORDERS
:PE and Lot Three Covenant-
agreement

	:man- trustee	:association	:year, :day	USPO, other	:covenant
48	↓ :Donald-John: Trump, et al.: ... Under the Procurator for the respondent, :Darrell-James: Hill, man-Procurator	↓ POTUS, -:Respondent, et al. -:Claim: matter#: RE 322 398 389 US :Darrell-James: Hill, -:Ohioan, -:civilian, -:Executor, -:Procurator for the Respondent, -:Claim: matter#: RE 322 398 389 US	01/14/21	:In :Hill-court of :Record At: Maricopa-County-Superior-Court, :Claim: matter#: RE 322 398 389 US -- 11) :matter # RE 322 398 389 US :ORDERS PE and Lot Four Covenant-agreement	↓ :Darrell-James: Hill, -:Ohioan- beneficiary-Executor: DOI-1776-A.D.: beneficiary- civilian -:Executor: EBA-1933-A.D. -PE-2016-A.D., et seq.- :covenants with the law of the covenants by the law of the DOI-1776-A.D. -PE-2016-A.D.-covenants, -:Procurator: procurator: Darrell-James: Hill, -:Executor. :Darrell-James: Hill, -:Ohioan, -:civilian, -:Executor, -:Procurator for the Respondent, -:Claim: matter#: RE 322 398 389 US
49	:Vanessa: Martinez	:Maricopa-County-Arizona-State-Superior-Court-Clerk-office	01/19/21	:Claim-matter: RE 322 398 389 US	January 19, 2021- A.D. :Maricopa-County-Arizona-State- Deprivation of the Access to the Common-Law-Court at the Maricopa-



County- Arizona- Superior-Court- venue is with the unlawful-Policy and Procedure- Implemented with the harm upon the man-Ohioan-Executor -:Darrell-James: Hill, -Executor-Procurator, -:Arizona-habitant by the Maricopa-County-Arizona-State-Clerks:Vanessa: Martinez with reported counsel with :Nikki: Swiss and :Jeff: Fine.

50 :Nikki: Swiss

51 :Jeff: Fine

:Maricopa-County-Arizona-State-Superior-Court-Clerk-office

:Claim-matter: RE 322 398 389 US

52 :man- trustee

:association

:year, :day

USPO, other

:covenant

53 :Jack: Sellers

:Maricopa-County-Arizona-State- Supv.

01/22/21

7009 2820 0003 9570 7942

January 19th, 2021- Deprivation of Rights to the Court of Record for :Clam: matter # RE 322 398 389 US at the Maricopa-County-Arizona-State-Superior-Court ...

54 :Steve: Chucri

55 :Bill: Gates

56 :Blint: Hickman

57 :Steve: Gallardo

:Maricopa-County-Arizona-State- Supv.

01/22/21

7009 2820 0003 9570 7942

January 19th, 2021- Deprivation of Rights to the Court of Record for :Clam: matter # RE 322 398 389 US at the Maricopa-County-Arizona-State-Superior-Court ...



	:man- trustee	:association	:year, :day	USPO, other	:covenant
58	:Jeff: Fine	:Maricopa-County- Arizona-State- Court- Clerk	↓ 01/22/21	7009 2820 0003 9570 7973	↓
59	:Joseph-Robinette: Biden	POTUS	↓ 01/22/21	7009 2820 0003 9570 7997	↓ January 19 th , 2021- Deprivation of Rights to the Court of Record for :Clam: matter # RE 322 398 389 US at the Maricopa-County-Arizona-State-Superior- Court
60	:Pamela: Gates	:Maricopa-County- Arizona-State- Court- Judge- Presiding	↓	7009 2820 0003 9570 7966	↓
61	:Joseph: Welty	:Maricopa-County- Arizona-State- Court- Judge- Chief	↓ 01/22/21	7009 2820 0003 9570 7959	↓ January 19 th , 2021- Deprivation of Rights to the Court of Record for :Clam: matter # RE 322 398 389 US at the Maricopa-County-Arizona-State-Superior- Court
62	:Paul: Penzone	:Maricopa-County- Arizona-State- Court- Sheriff	↓	7009 2820 0003 9570 7980	↓
	:man- trustee	:association	:year, :day	USPO, other	:covenant
63	:Monty: Wilkinson	U.S.- AG, APC, CLT	↓ 01/22/21	7009 2820 0003 9570 8000	↓ January 19 th , 2021- Deprivation of Rights to the Court of Record for :Clam: matter # RE 322 398 389



1784

US at the Maricopa-County-Arizona-State-Superior-Court ...

64 :Joseph-Robinette: POTUS 01/28/21 RE 322 398 389 US
Biden

:Claim of :UnalienableRight :in-accordance With the
Covenant-Agreements

:i- man- beneficiary Have endured The POTUS-
Office Dereliction Beginning With The
BarackHussein's Presidency-2016 A.D.~ Unto Now.
- :i- man require :This Must End Now.

:Covenant-Agreements-Statuses- :in -Procuration

65 :Lloyd-J.: Austin III US- Secretary of Defense
c/o: Joseph-Robinette: 01/28/21 RE 322 398 389 US
Biden

66 :Mark-A.: Milley USofA- military- General
c/o: Joseph-Robinette: ↓
Biden

67 :John-E.: Hyten USofA- military- General
c/o: Joseph-Robinette: 01/28/21 RE 322 398 389 US
Biden

:Claim of :UnalienableRight :in-accordance With the
Covenant-Agreements

:i- man- beneficiary Have endured The POTUS-
Office Dereliction Beginning With The



5821

BarackHussein's Presidency-2016 A.D.~ Unto Now.
- :i- man require :This Must End Now.

:Covenant-Agreements-Statuses- :in -Procuration

68 :John: Whitley U.S.- Secretary-Army, Acting
c/o: Joseph-Robinette: Biden

:man- trustee

:association

:year, :day

USPO, other

:covenant

69 :Tom: Harker U.S. Secretary-Navy
c/o: Joseph-Robinette: Biden
01/28/21 RE 322 398 389 US

70 :Monty: Wilkinson U.S. -AG, APC, CLT
c/o: Joseph-Robinette: Biden

:Claim of:UnalienableRight :in-accordance With the
Covenant-Agreements

:i- man- beneficiary Have endured The POTUS-
Office Dereliction Beginning With The
BarackHussein's Presidency-2016 A.D.~ Unto Now.
- :i- man require :This Must End Now.

:Covenant-Agreements-Statuses- :in -Procuration

71 :Joseph: Welty :Maricopa-County-
c/o: Joseph-Robinette: Arizona-State-Superior-
Biden Court- Judge, -Chief
01/28/21 RE 322 398 389 US



Handwritten signature and date: 9/26/22

72	:David-L.: Norquist c/o: Joseph-Robinette: Biden	U.S. Secretary of Defense- Deputy	↓	↓	↓
	:man- trustee	:association	:year, :day	USPO, other	:covenant
73	:Lisa: Hershman c/o: Joseph-Robinette: Biden	U.S. Chief Mgmt Officer	↓ 01/28/21	↓ RE 322 398 389 US	↓ :Claim of :UnalienableRight :in-accordance With the Covenant-Agreements :i- man- beneficiary Have endured The POTUS- Office Dereliction Beginning With The BarackHussein's Presidency-2016 A.D.- Unto Now. - :i- man require :This Must End Now. :Covenant-Agreements-Statuses- :in -Procuration
74	:Stacy-A.: Cummings c/o: Joseph-Robinette: Biden	Under Secretary of Defense- Acquisition	↓	↓	↓
75	:John: Roth c/o: Joseph-Robinette: Biden	U.S.- Secretary- Air- Force, Acting	↓ 01/28/21	↓ RE 322 398 389 US	↓
76	:Amanda: Dory c/o: Joseph-Robinette: Biden	US. Under Secretary of Defense for Policy	↓	↓	↓
77	:Jack: Sellers c/o: Fran: McCarroll	:Maricopa-County- Arizona-State- Supv.	↓ 01/28/21	↓ RE 322 398 389 US	↓



c/o: Joseph-Robinette:
Biden

	:man- trustee	:association	:year, :day	USPO, other	:covenant
78	:Steve: Chucri c/o: Fran: McCarroll c/o: Joseph-Robinette: Biden	:Maricopa-County- Arizona-State- Supv.	↓ 01/28/21	↓ RE 322 398 389 US	↓ :Claim of :UnalienableRight :in-accordance With the Covenant-Agreements :i- man- beneficiary Have endured The POTUS- Office Dereliction Beginning With The BarackHussein's Presidency-2016 A.D.~ Unto Now. - :i- man require :This Must End Now. :Covenant-Agreements-Statuses- :in -Procuration
79	:Bill: Gates c/o: Fran: McCarroll c/o: Joseph-Robinette: Biden	:Maricopa-County- Arizona-State- Supv.	↓ 01/28/21	↓ RE 322 398 389 US	↓
80	:Clint: Hickman c/o: Fran: McCarroll c/o: Joseph-Robinette: Biden	:Maricopa-County- Arizona-State- Supv.	↓	↓	↓
81	:Steve: Gallardo c/o: Fran: McCarroll c/o: Joseph-Robinette: Biden	:Maricopa-County- Arizona-State- Supv.	↓ 01/28/21	↓ RE 322 398 389 US	↓



	:man- trustee	:association	:year, :day	USPO, other	:covenant
82	:Virginia: Penrod c/o: Joseph-Robinette: Biden	:US- Under-Secretary of Defense	↓	↓	↓ :Claim of :UnalienableRight :in-accordance With the Covenant-Agreements :i- man- beneficiary Have endured The POTUS- Office Dereliction Beginning With The BarackHussein's Presidency-2016 A.D.~ Unto Now. - :i- man require :This Must End Now. :Covenant-Agreements-Statuses- :in -Procuration
83	:Pamela: Gates c/o: Joseph-Robinette: Biden	:Maricopa-County- Arizona-State -Judge, - Presiding	↓ 01/28/21	↓ RE 322 398 389 US	↓
84	:Douglas: Glenn c/o: Joseph-Robinette: Biden	:US- Under Secretary of Defense	↓	↓	↓
85	:Paul: Penzone c/o: Joseph-Robinette: Biden	:Maricopa-County- Arizona-State- Sheriff	↓ 01/28/21	↓ RE 322 398 389 US	↓
	:man- trustee	:association	:year, :day	USPO, other	:covenant
86	:Jeff: Fine c/o: Joseph-Robinette: Biden	:Maricopa-County- Arizona-State- Supv.	↓ 01/28/21	7018 0360 0000 5968 6139	↓ :Claim of :UnalienableRight :in-accordance With the Covenant-Agreements

:i- man- beneficiary Have endured The POTUS- Office Dereliction Beginning With The BarackHussein's Presidency-2016 A.D.- Unto Now. - :i- man require :This Must End Now.

:Covenant-Agreements-Statuses- :in -Procuration

87 :John-Earl: Hyten USofA- military- General 02/05/21 7009 1410 0000 7868 5741

:Sovereign- :United-State-of-America- people- Authority AND :Sovereign-Authority- Acceptance :in-Procuration by :Covenant- Agreements; for: a) :Receipt of the non- incorporated, :authority on the Abandonment and Vacation of the office of the President by the man Donald-John: Trump, -:Trustee, :in Dishonor; and b) :Sovereign-Authority- Acceptance :in- Procuration by :Covenant-Agreements: Lots: One, Two, Three, Four, Five, six, and Seven (~fialure to restore republic-constitution for: cause~

88 :Mark-Alexander: Milley USofA- military- General ↓ ↓ ↓
c/o: John-Earl: Hyten 02/05/21 7009 1410 0000 7868 5741

89 :Jamer-Charles: USofA- military- General ↓ ↓ ↓
McConville
c/o: John-Earl: Hyten

:man- trustee :association :year, :day USPO, other :covenant

90 :David-Hilberry: Berger USofA- military- General ↓ ↓ ↓
c/o: :Mark-Alexander: 02/05/21 7009 1410 0000 7868 5741

:Sovereign- :United-State-of-America- people-



Milley

Authority AND :Sovereign-Authority- Acceptance :in-Procuration by :Covenant- Agreements; for: a) :Receipt of the non- incorporated, -'authority on the Abandonment and Vacation of the office of the President by the man Donald-John: Trump, -:Trustee, :in Dishonor; and b) :Sovereign-Authority- Acceptance :in- Procuration by :Covenant-Agreements: Lots: One, Two, Three, Four, Five, six, and Seven (~fialure to restore republic-constitution for: cause~

- 91 :Michael-Martin: Gilday :USofA- military- Admiral
c/o: John-Earl: Hyten 02/05/21 7009 1410 0000 7868 5741
- 92 :David-Lee: Goldfein USofA- military- General
c/o: John-Earl: Hyten
- 93 :John-William: Raymond USofA- military- General
c/o: John-Earl: Hyten 02/05/21 7009 1410 0000 7868 5741

:Sovereign- :United-State-of-America- people- Authority AND :Sovereign-Authority- Acceptance :in-Procuration by :Covenant- Agreements; for: a) :Receipt of the non- incorporated, -'authority on the Abandonment and Vacation of the office of the President by the man Donald-John: Trump, -:Trustee, :in Dishonor; and b) :Sovereign-Authority- Acceptance :in- Procuration by :Covenant-Agreements: Lots: One, Two, Three, Four, Five, six, and Seven (~fialure to restore republic-constitution for: cause~



	:man- trustee	:association	:year, :day	USPO, other	:covenant
94	:Joseph-Lauren: Lengyel c/o: :Mark-Alexander: Milley	USofA- military- General	↓	↓	↓
95	:Karl-Leo: Schultz c/o: :Mark-Alexander: Milley	:USofA- military- Admiral	↓ 02/05/21	↓ 7009 1410 0000 7868 5741	↓ :Sovereign- :United-State-of-America- people- Authority AND :Sovereign-Authority- Acceptance :in-Procuration by :Covenant- Agreements; for: a) :Receipt of the non- incorporated, -'authority on the Abandonment and Vacation of the office of the President by the man Donald-John: Trump, -:Trustee, :in Dishonor; and b) :Sovereign-Authority- Acceptance :in- Procuration by :Covenant-Agreements: Lots: One, Two, Three, Four, Five, six, and Seven (~failure to restore republic-constitution for: cause~
96	:man- trustee	:association	:year, :day	USPO, other	:covenant
97	:Joseph-Robinette: Biden	:POTUS, et al.- man- actors	02/09/21	7009 1410 0000 7868 5734	:2021-A.D. February 4 th : Authority For :U.S.Corp'-:Trustee- Government-Services- Provider, 'gsp',-:Trustee- EBA-1933-A.D., To Ascend By any-Means To The Entity-Status- Equivalency of -:Man-Kind; Organic-State, Subrogation or Fictional, Or A :Like- Presumption- Status, is Here-To-Fore and Now-To-After- :Denied.
98	:Mark-Alexander: Milley	USofA- military- General	↓	~RE 322 398 295 US~ →	↓



02/09/21

RE 322 398 313 US

:2021-A.D. February 4th: Authority For : 'U.S.Corp' -:Trustee- Government-Services- Provider, 'gsp', -:Trustee- EBA-1933-A.D., To Ascend By any-Means To The Entity-Status- Equivalency of -:Man-Kind; Organic-State, Subrogation or Fictional, Or A :Like- Presumption- Status, is Here-To-Fore and Now-To-After- :Denied.

99 :John-Earl: Hyten
c/o: :Mark-Alexander:
Milley

02/09/21

100 :Jamer-Charles: USofA- military- General
McConville
c/o: :Mark-Alexander:
Milley

02/09/21

~RE 322 398 295 US~
RE 322 398 313 US

:2021-A.D. February 4th: Authority For : 'U.S.Corp' -:Trustee- Government-Services- Provider, 'gsp', -:Trustee- EBA-1933-A.D., To Ascend By any-Means To The Entity-Status- Equivalency of -:Man-Kind; Organic-State, Subrogation or Fictional, Or A :Like- Presumption- Status, is Here-To-Fore and Now-To-After- :Denied.

:man- trustee

:association

:year, :day

USPO, other

:covenant

101 :David-Hilberry: Berger USofA- military- General
c/o: :Mark-Alexander:
Milley

102 :Michael-Martin: Gilday :USofA- military- Admiral
c/o: :Mark-Alexander:

02/09/21

~RE 322 398 295 US~



	:man- trustee	:association	:year, :day	USPO, other	:covenant
	Milley			RE 322 398 313 US	
103	:David-Lee: Goldfein c/o: :Mark-Alexander: Milley	USofA- military- General	↓	↓	↓
104	:John-William: Raymond c/o: :Mark-Alexander: Milley	USofA- military- General	02/09/21	~RE 322 398 295 US~ → RE 322 398 313 US	:2021-A.D. February 4 th : Authority For : 'U.S.Corp' -:Trustee- Government-Services- Provider, 'gsp', -:Trustee- EBA-1933-A.D., To Ascend By any-Means To The Entity-Status- Equivalency of -:Man-Kind; Organic-State, Subrogation or Fictional, Or A :Like- Presumption- Status, is Here-To-Fore and Now-To-After- :Denied.
	:man- trustee	:association	:year, :day	USPO, other	:covenant
105	:Joseph-Lauren: Lengyel c/o: :Mark-Alexander: Milley	USofA- military- General	↓	↓	↓
106	:Karl-Leo: Schultz c/o: :Mark-Alexander: Milley	:USofA- military- Admiral	02/09/21	~RE 322 398 295 US~ → RE 322 398 313 US	:2021-A.D. February 4 th : Authority For : 'U.S.Corp' -:Trustee- Government-Services- Provider, 'gsp', -:Trustee- EBA-1933-A.D., To Ascend By any-Means To The Entity-Status- Equivalency of -:Man-Kind; Organic-State, Subrogation or Fictional, Or A :Like- Presumption- Status, is Here-To-Fore and Now-To-After- :Denied.
	:man- trustee	:association	:year, :day	USPO, other	:covenant

2022-011769 MISC Page: 1803 of 2782
 09/26/2022 03:35:37 PM Receipt #: 22-9381
 Rec Fee: \$30.00 Darrell James Hill
 Gila County, Az, Sadie Jo Bingham, Recorder



107 :Jessica-J.: Fotinos :General-Counsel and Public-Information-Officer 02/11/21 Regular-U.S.-Mail

'The Clerk of the Superior-Court in the Maricopa-County-Arizona-State = ~:Clerk's- Office~'

... after a cursory-review... it does not appear that the documents-relate to the any-matter ... or issue that involves the -:Clerk's- Office... . The -Clerk's- Office -functions as ... [,] the documents-would-need-to-conform with the applicable- rules-of-procedure, -including the state and local-rules-of-procedure ...- [d]epending on the case-type.' :''These documents do not conform with any of those rules."

108 :Stephen-Q: Miller :Arizona-State-Country-Pinal-County- Trustee-Chairman: Board-of-Supervisors 12/30/21 RE 322 390 840 US ↓

Completion of the 45-day- Notice: December-30-2021-AD, :45day-notice -Unit:
 a) December-16-2021-AD, :RE322390751US
 b) November-18-2021-AD, :RE322398344US
 c) November-15-2021-AD, :RE322398361

109 :c/o :Natasha: Kennedy :Arizona-State-Country-Pinal-County- Trustee-Clerk: Board-of-Supervisors ↓ ↓

:man- trustee :association :year, :day USPO, other :covenant



Darrell-James: Hill, -:civilian, -:Executor
PO Box 3806
Apache Junction, Arizona-state 85117

:man- :procurator

To :Donald-John: Trump, :Respondent- :Trustee, et al.-
:man-actor -Trustees: Barack-Hussein: Obama;
Loretta: Lynch, Jefferson-Beauregard: Sessions III, Matthew-George: Whitaker,
Dana-James: Boente, Sally-Caroline: Yates, William-Pelham: Barr, Steve-Truner:
Mnuchin; Brian: Karth, Ranier-Christercunean: Collins; John and Jane Does;
Under-:Procurator For Respondent :darrell-james: hill, -:man -:Procurator
c/o :Donald-John: Trump ; USPO CMN 7008 1830 0002 1028 2082
c/o: darrell-james: hill, procurator-minister
1600 Pennsylvania Ave NW
Washington, District of Columbia 20500 ;

To: Mark-Alexander :General United States Army-:Chairman: CJCOS- :Milley,
:John-Earl :General United States Air Force: Vice- CJCOS- :Hyten,
:James-Charles :General United States Army: COS Army- :McConville,
:David-Hilberry :General United States Marine Corps: CMC- :Berger,
:Michael-Martin :Admiral United States Navy: CNO- :Gilday,
:David-Lee :General United States air Force: COS AF- :Goldfein,
:John-William :General United States Space Force: CSO- :Raymond,
:Joseph-Lauren :General United States Air Force: CNG- :Lengyel
:Karl-Leo :Admiral United States Coast Guard: CCG- :Schultz
c/o :James-Charles: McConville, -:Trustee ; USPO CMN 7009-2820 0003 8851 6100
9999 Join Staff Pentagon
Washington, District of Columbia 20318-9999 ;

:Mark, :Sheriff- Pinal county, Arizona state- :Lamb,
:Joseph- Jr, :Sheriff Apache county, Arizona state- :Dedman,
:Mark, :Sheriff -Cochise county Arizona state- :Dannels,
:Jim, :Sheriff -Coconino county, Arizona state- :Driscoll,
:Adam, :Sheriff- Gila county, Arizona state - :Shepherd,
:Preston- "PJ", :Sheriff -Graham county, Arizona state- :Allred,
:Tim, :Sheriff- Greenlee county, Arizona state- :Sumner,
:Bill, :Sheriff- La Paz county, Arizona state- :Risen,
:Paul, :Sheriff- Maricopa county, Arizona state- :Penzone,
Doug, :Sheriff- Mohave county, Arizona state- :Schuster,
:David, :Sheriff- Navajo county, Arizona state- :Clouse,
:Mark, :Sheriff- Pima county, Arizona state- :Napier,
:Tony, :Sheriff- Santa Cruz county, Arizona state- :Estrada,
:Scott, :Sheriff- Yavapai county, Arizona- :Mascher,
:Leon, :Sheriff- Yuma county, Arizona state- :Wilmot,

c/o :Mark :Lamb, -:Trustee
971 N Jason Lopez Circle
Building C
PO Box 867
Florence, Arizona state 85132

c/o :Paul: Penzone, -:Trustee
550 West Jackson
Phoenix Arizona state 85003

USPO CMN 7012 2210 0000 4269 7384

USPO CMN 7010 1060 0001 7518 9154

Greetings :Donald-John, et al., James-Charles, et al., Mark and Paul, et al.;

thank- you for your service; if there is anything you need, please let me know.

This is :in great sadness –

Due to the violation of :all- rights-executed :in- accordance with-after the detailed-meeting of
the ICCPR-1992-A.D. is met with the absolute-deprivation and voidance-of-benefit by the Trustee-
Dereliction with the silent-acquiescence unto tacit-procurator for the remedy of the deprivation
imposed without right or :i- man's wishes, :i- man- beneficiary must write to you :this- matter as
stipulated-to and agreed-upon :in -accordance with the prevailing covenant-agreements. See:
:notice; See claim; :matter # RE 322 398 389 US, et al, enclosed: 24 page.

:In- accordance with the prevailing covenant-agreements, :i- man must :in- honor execute
procurator for the Trustee-Dereliction and wrong-doings. You may attend the proceedings;
however, your presence is Not required as the procurator is sufficient to direct the matters-agreed
:in- non-controversy.

Without prejudice,

:darrell-james: hill, procurator
:darrell-james: hill, Procurator

COPY

2022-011769 MISC Page: 1805 of 2782
09/26/2022 03:35:37 PM Receipt #: 22-9381
Rec Fee: \$30.00 Darrell James Hill
Gila County, Az, Sadie Jo Bingham, Recorder

1796

Darrell-James: Hill, -civilian, -:Executor
PO Box 3806
Apache Junction, Arizona 85117

:man :present

Arizona state
Maricopa county

**:In :Hill – Court of :Record
At: Maricopa County Superior Court**

:Darrell-James: Hill,
:Claimant- beneficiary

:notice:
:see claim: :matter # RE 322 398 389 US

:Donald-John: Trump,
:Respondent- :Trustee, et al.- :man-actor
-Trustees: Barack-Hussein: Obama;
Loretta: Lynch, Jefferson-Beauregard:
Sessions III, Matthew-George: Whitaker,
Dana-James: Boente, Sally-Caroline: Yates,
William-Pelham: Barr; Steve-Truner: Mnuchin;
Brian: Karth, Ranier-Christercunean: Collins;
John and Jane Does;

See- appended:
claim – executed;
declaration: right of claim, with:
declaration: averments: claimant;
See- appended: Respondent:
declaration: stipulations; procurator as
respondent;
**Notice of receipt of claim; formal
summons waved**

Under-:Procurator For Respondent
:darrell-james: hill, -:man -:Procurator

(verified)

:i- man will stand-present as the Executor!

:Law Over-standing The Matter

This Court-of-Record must be administered by the services of the Trial-by-Jury² for to decide the matter of the facts and the law status of the out-of-court- judgment, :in- non-controversy, by procurator, :in- accordance with the law of the covenant-agreements~ See: Nature of Claim: Trespass~ stipulated-to and agree-upon by the man- Claimant and the man- Respondent, et al.- U.S.-Corp. Government-services-provider, -:Trustee: Emergency Banking Act of 1933, et seq.

:Duties during the Proceeding

The man- Magistrate's is invited in this court-of-record is to witness for the proceedings :in the trial-by-jury, autograph-accept the jury's order(s) and ensure the proper recording of the order(s) with the clerk.

The man -Security personnel- assigned's duty is to be tipstaff.

RESPONDENT-NOTIFICATION is completed with the service to the procurator. Notice to the Procurator is as notice the Respondent -:in -principal, -:Donald-John: Trump, et al.- man-actor(s).

:i- man say here under penalty of perjury, and will verify same in the open-court, that :all herein be true and correct to the best of :i- man's knowledge;

Sincerely,

Darrell-James Hill, Executor
:Darrell-James: Hill, -:Executor- beneficiary

Sworn and Autographed before me this 14 day January 2021 A.D.
Type of Identification: Arizona Driver License

L. Breksa
Notary-Pubic

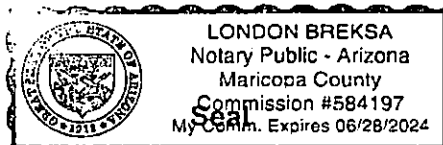

January 14, 2021 :notice: see claim – :matter # RE 322 398 389 US

1 / 2

2022-011769 MISC Page: 1806 of 2782

09/26/2022 09:35:37 PM Receipt #: 22-9381
Rec Fee: \$30.00 Darrell James Hill
Gila County, Az, Sadie Jo Bingham, Recorder

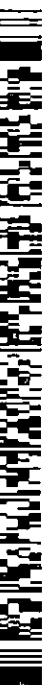

1 :Constructive Notice Of The Setting Of Presumptions

Notice to Agent is Notice to Principal; Notice to Principal is Notice to Agent: **Applicable to all Successors and Assigns** – i- man :Darrell-James: Hill, -Executor -beneficiary set :these -known- presumptions: That:

- 1) Re: presumption of the public record, this- private- business- matter is to be recorded in the public -environment and on the public -record and by the public -record number placed on the page -one of the matter; and:
- 2) Re: presumption of the public service, that :any public- person engaged in this private- matter is deemed to be in the public- service as a :public-servant; and:
- 3) Re: presumption of the public oath, that, :every :public-servant acting on the behalf of this matter is required to state :all- public and private -:sworn -oaths superseding the :public -servant's -sworn -oath(s); and:
- 4) Re: presumption of the immunity, that, :any-person acting on the behalf of/as the agent for :any- nameless, faceless -predilection or corporation is :wholly-personally-liable for :their- actions on the behalf of that interest upon the Notice- of-Injury with the financial- penalty; and:
- 5) Re: presumption of the summons, that, for the now, past and future -occasions, the :customary- presumption of the jurisdiction, position, and existence of the guilt is :forbidden; and:
- 6) Re: presumption of the custody, that, :man-kind is as :i- man am, -alive and well: not the :thing to be held in the custody by the custodian or guardian; not :property of the Roman-Court or Roman-Empire; and, :under-no-circumstances may :i- man be detained in any way: now, past or future; and:
- 7) Re: presumption of the court of the guardians, that: i :man :Darrell-James: Hill am: general guardian and executor of the matters of the trust; and:
- 8) Re: presumption of the court of the trustees, that, for the reason of as a visitor with the invitation to meet and to clear-up the :matter, the :offices of the trustee and the :roles of the public -servant and government -employees are rejected: absolutely :-no -jurisdiction may be claimed; and:
- 9) Re: presumption of the government acting in :two roles as the executor and beneficiary, that, :i- man am the :general executor, general guardian, and beneficiary and executor :in -all -matters-at-hand pertaining to the legal -person, -subrogation: DARRELL JAMES HILL, et seq.-derivatives-there-to, as well as to the flesh and blood, -living -soul-journer :i- man -Darrell-James: Hill, -civilian, -Executor- beneficiary; and:
- 10) Re: presumption of the agent and agency, that, :under-no-circumstance may the :judge or magistrate assume the :executor-role; and:
- 11) Re: presumption of the incompetence, that, :i- man know the :position of the executor and beneficiary; and rebuke and object to :any-contrary-presumption. – :No- privilege 'of the deeming :i- man incompetent' is permitted; and:
- 12) Re: presumption of the guilt, that, :under -no- circumstance may :i- man be: a) :presumed -guilty, or b) detained; nor- may c) :any- financial- transactions occur in the favor of the court.

2 :This :court-of-record must be by the Trial-by-Jury means: the judgment must be by the power of sovereign-assembly- oversight.

1798
Unofficial

2022-011769 MISC Page: 1807 of 2782

09/26/2022 03:36:37 PM Receipt #: 22-9981
Darrell James Hill
Rec Fee: \$30.00 Sadie Jo Bingham, Recorder
Gila County, Az



Darrell-James: Hill, -civilian, -:Executor
PO Box 3806
Apache Junction, Arizona 85117

RECEIVED

21 JAN 19 PM 12:10

:man :present, -:

COURT ADMINISTRATION
SOUTHEAST FACILITY

Arizona state
Maricopa county

:In :Hill – Court of :Record
At: Maricopa County Superior Court

:Darrell-James: Hill,
:Claimant- beneficiary

:claim – executed:

:matter # RE 322 398 389 US

:Donald-John: Trump,
:Respondent- :Trustee, et al.- :man-actor
-Trustees: Barack-Hussein: Obama;
Loretta: Lynch, Jefferson-Beauregard:
Sessions III, Matthew-George: Whitaker,
Dana-James: Boente, Sally-Caroline: Yates,
William-Pelham: Barr; Steve-Truner: Mnuchin;
Brian: Karth, Ranier-Christercunean: Collins;
John and Jane Does; Under-:Procurator.

:Executor- Waiver of :Recordation and
Court-of-Record Fees

(verified)

under-:procurator for respondent
:darrell-james: hill, -:man -:procurator

:i- man- Executor- Trustee waive the recordation and Court-of-Record fees in this
matter for :execution of the right in suit at common law where the matter in controversy
exceeded twenty dollars.

:i- man say here under penalty of perjury, and will verify same in the open-court, that :all herein
be true and correct to the best of :i- man's knowledge;

January 19th 2021 day :Darrell-James: Hill
:Darrell-James: Hill, -: Executor

2022-011769 MISC Page: 1809 of 2782
09/26/2022 03:35:37 PM Receipt #: 22-9381
Rec Fee: \$30.00 Darrell James Hill
Gila County, Az, Sadie Jo Bingham, Recorder



Service of Claim – Notice:
matter # RE 322 398 389 US

Name: Tracy Calhoun
Address: 5124 East 18th Avenue
City, State, Zip: Apache Junction, Arizona 85119
Phone: _____

I, man, Tracy Calhoun, am of sound-mind and mature in years, herein sets for the fact-verified that I-man served the Claim: matter # RE 322 398 389 US documents for the claimant in the matter directly to the intended recipient before the notary-public. as man-Respondent -Darrell-James: Hill on this day ____ January, 2021, at: 06:01 am/pm

Date: January 14, 2021

Tracy P. Calhoun
:man-server

I, man -:Darrell-James: Hill, :procurator as the Respondent received the claim, and all appended- documents upon the :matter # RE 322 398 389 US is received this January 14th, 2021 A.D. by/ from the third-party man-server indicated above.

See: Claim: matter # RE 322 398 389 US to :man- Darrell-James: Hill;
FORMAL SUMMONS IS WAVED.

I, man say here under penalty of perjury, and will verify same in the open-court, that :all herein be true and correct to the best of :I- man's knowledge;

Without prejudice

Darrell - James Hill, Procurator
:Darrell- James: Hill, :procurator as the respondent

Sworn and Autographed before me this 14 day January 2021 A.D.
Type of Identification: Arizona Driver License

London Breksa
Notary-Pubic

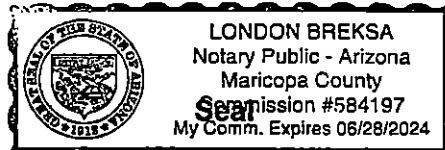

Darrell-James: Hill, -civilian, -:Executor
PO Box 3806
Apache Junction, Arizona 85117

:man :present, -:Claimant

Arizona state
Maricopa county

**:In :Hill – Court of :Record
At: Maricopa County Superior Court**

:Darrell-James: Hill,
:Claimant- beneficiary

:Donald-John: Trump,
:Respondent- :Trustee, et al.- :man-actor
-Trustees: Barack-Hussein: Obama;
Loretta: Lynch, Jefferson-Beauregard:
Sessions III, Matthew-George: Whitaker,
Dana-James: Boente, Sally-Caroline: Yates,
William-Pelham: Barr; Steve-Truner: Mnuchin;
Brian: Karth, Ranier-Christercunean: Collins;
John and Jane Does; Under-:Procuration.

:claim – executed:

:matter # RE 322 398 389 US

common-theft,
with penalty-agreement,
with :respondent :in- dishonor

(verified)

under-:procuration for respondent
:darrell-james: hill, -:man -:procurator

- 1) :i- man- :Claimant is :Darrell-James: Hill, -civilian, -:beneficiary, -:Ohioan, one of the 'United States of America' -people; -:Executor establish :this -court of -record for to move :claim before jury-members to decide the matters of fact and law :in the 'out-of-court- judgment' understanding the Covenant-agreements.
- 2) The :man- :Respondent is :Donald-John: Trump, et al.- man-actor-Trustees for the U.S.- government for: a) the United States of America -people- beneficiary, and: b) as the U.S.- Corp.-Trustee: Emergency Banking Act, 1933 - 2003 A.D. for the 'United States of America' -:people- beneficiary;
- 3) :i- man- Claimant wholly-own the :express and specific- property-claimed and possessed referred-to in the **Declaration: Right of Claim**, appended;
- 4) The :man- Respondent, et al., lawfully received Claimant's property-claimed and possessed, and none else: a) :man- Respondent, et al., administrates i-man's property without right or :i- man's wish, b) :man- Respondent, et al., possesses :i- man's property without right or :i- man's wish, c) :man- Respondent detains :i- man's property without right or :i- man's wish;
- 5) :i- man -:Claimant wishes the restoration of :all -property :in accordance with the Covenant-Agreements - stipulated-to and agreed-upon onto this Court-of-Record.

:i- man say here under penalty of perjury, and will verify same in the open-court, that :all herein be true and correct to the best of :i- man's knowledge;

Jan. 14, 2021 :Darrell-James Hill, Claimant
:Darrell-James: Hill, -:Claimant- beneficiary

January 14, 2021 :claim- executed –



Darrell-James: Hill, -civilian, -:Executor
PO Box 3806
Apache Junction, Arizona 85117

5 :man :present,

10 Arizona state
Maricopa county

**:In :Hill – Court of :Record
At: Maricopa County Superior Court**

15

:Darrell-James: Hill,
:Claimant- beneficiary

:Donald-John: Trump,
:Respondent- :Trustee, et al.,
Under-:Procurator

:Darrell-James: Hill, -:man -:Procurator

:declaration: right of claim
:in :out of court- judgment'- matter
:in the non-controversy
:under- procurator- expressed
:in- accordance with :covenant- as
:stipulated-to and agreed-upon

See :declaration: averments: claimant

**See: stipulations: procurator as
respondent.**

(verified)

**Joined-Matter :in -Non-Controversy in: Procurator
By :Covenant- Agreement To Effect the :Remedy for the Claimant**

20

CLAIM-OF-RIGHT: JOINED BY THE RESPONDENT BY PROCURATION

:i- man -:Darrell-James: Hill ~hereinafter 'Claimant'~ is :Ohioan, one of the people and
inhabitant of :Arizona state, and in this court of record claims with the man -:Donald-John:
Trump¹ ~hereinafter 'Respondent² '~ in this non-controversy-matter -:in -procurator unto and
until the remedy is completed solely for the Claimant :in accordance with the Covenant-
25 Agreements by the 'out-of-court- judgment'. See: a) :declaration: averments: claimant, and b)
stipulations: procurator as respondent.

25

COURT-OF-RECORD WITH TRIAL-BY-JURY

For the right of the remedy for the Claimant, :this :court-of-record with the Trial-by-Jury³ is
30 with the duty to address the matters concerning the national-government service-provider:
Trustee of the Emergency Banking Act of 1933 A.D., et seq.:

30

- to decide-upon the :facts and the law of the Covenant-agreement⁴-matters by the lawful-
oversight by the sovereign-people-jural-assembly;
- to accept the "out of court"- judgment :in- obligation now: and,
- 35 to: a) halt and cease the Respondent- damage(s) presently endured by the Claimant;
- b) obtain the full-remedy to the Claimant :in accordance with the Covenant-
agreements; and,
- c) do :all of :same :in- honor.⁵

35

:FOUNDING -:COVENANT -AGREEMENTS:

The Covenant Agreements between the Claimant and Respondent by procurator are
founded :in and upon the law- guarantees derived from the people that established the republic-
founding- covenants :in -law for the United States of America- people⁶.

40

CLAIMANT-RESPONDENT -:COVENANT-AGREEMENTS:

- 45 1) specifies the claim(s)-of-right to the property-claimed due to the Claimant;
- 2) identifies the payment-agreement for the withholding/stealing of the property;
- 3) identifies the non-controversy by :procurator for the Respondent by the man -:darrell-james:
Hill, procurator-minister as the Respondent.

45

THE :POLITICAL-ELECTION, 'PE", -COVENANT- AGREEMENT⁷ '

The 'Affidavit of Superior Constructive Notice and Demand; Permanent Non-Commercial
Presumption'; and: AFFIDAVIT: Constructive Notice of 'DARRELL JAMES HILL' of 'Darrell-
James: of the family Hill' Authorized Representative, 'Political-Election-covenant- agreement',

50

January 14, 2021 :declaration; right of claim



1802

55 'PE', is the express, signed, sealed and specially -delivered-covenant executed and executory for to affirm that the property for :all- inherent and fundamental rights, tangible and intangible, private real and chattel property-claimed and possessed, is restored to the man- covenantor- Claimant -:darrell-james: hill, to:

- 60 a) :in -non-controversy by :procuration assure and ensure the absolute-remedy for :Claimant :in -accordance with the covenant-agreements: PE-covenant- agreement, et seq.- offense- levels with the particular breach of the covenant -agreements;
- b) to release the :property-claimed and possessed according to the covenant-agreement;
- c) to pay the penalty for the offenses in the deprivation of the private-property :in -accordance with the covenant-agreements;
- 65 d) to assure the :restoration of :property-claimed and possessed :in -accordance with the covenant-agreements :in -honor.

:RESPONDENT- BREACH OF THE PE-COVENANT- AGREEMENT- LOTS 1, 2, 3 AND 4 'LOT-ONE'⁹- COVENANT-AGREEMENT' :Respondent Breach Of :COVENANT- Agreement:
The: 'NOTICE: CLAIM, RE: Property disposed to the United States of America in the "UNITED STATES ATTORNEY'S OFFICE; OFFICIAL NOTIFICATION POSTED ON OCTOBER 12, 2016'', 'Lot-One'- Covenant-agreement' is the express, signed, sealed and specially -delivered-covenant executed for the restoration of the private property- claimed and possessed under the condition stipulated-to and agreed-upon for the deprivation of :private-property-penalty- obligation :in the Covenant-Agreements at :one- U.S.- dollar -silver -in- specie per :minute :in-accordance with
75 the Lot-One- Covenant-Agreement, subject to the First-Offense -level of the PE- Covenant-agreement.

'LOT-TWO'⁹- COVENANT-AGREEMENT' :Respondent Breach Of :COVENANT- Agreement:
The: 'i: man; Darrell-James: Hill; prosecutor, Claimant'; Claimant Case No: CMN 7009 1410 0000 7868 5703'', 'Lot-Two'- Covenant-agreement', is the express, signed, sealed and specially -delivered-covenant executed for the restoration of the right in the Court-of-Record in the matter of the stolen/deprived property-claimed and possessed in the 'Lot-One-covenant- agreement' under the conditions stipulated-to and agree-upon for the restoration of the property- claimed and possessed under the covenant-agreement-obligations at :one- U.S.- dollar -silver -in- specie per :minute :in-accordance with the Lot-Two- Covenant-Agreement per :minute, subject to
85 the Second-Offense -level of the PE- covenant-agreement.

'LOT-THREE'¹⁰- COVENANT-AGREEMENT' :Respondent Breach Of :COVENANT- Agreement:
The: 'NOTICE: CLAIM, RE: Property disposed to the United States of America in the 'UNITED STATES ATTORNEY'S OFFICE; OFFICIAL NOTIFICATION POSTED ON FEBRUARY 13, 2017'', 'Lot-Three'- Covenant-agreement' is the express, signed, sealed and specially -delivered-covenant executed present for the restoration of the private property- claimed and possessed under the condition stipulated-to and agreed-upon for the deprivation of :private-property-penalty- obligation :in the Covenant-Agreements at :one- U.S.- dollar -silver -in- specie per :minute :in-accordance with the Lot-Three- Covenant-Agreement, subject to the Third-Offense
95 -level of the PE- Covenant-agreement.

'LOT-FOUR'¹¹- COVENANT-AGREEMENT' :Respondent Breach Of :COVENANT- Agreement:
The: 'CLAIM: NOTICE AND DEMAND, RE: Property disposed to the United States of America reported in the 'UNITED STATES ATTORNEY'S OFFICE; OFFICIAL NOTIFICATION POSTED ON AUGUST 30, 2017'', 'Lot-Four'- Covenant-agreement' is the express, signed, sealed and specially -delivered-covenant executed present for the restoration of the private property- claimed and possessed under the condition stipulated-to and agreed-upon for the deprivation of :private-property-penalty- obligation :in the Covenant-Agreements at :one- U.S.- dollar -silver -in- specie per :minute :in-accordance with the Lot-Four- Covenant-Agreement, subject to the
105 Third-Offense -level of the PE- Covenant-agreement.

110 :i- man say here under penalty of perjury, and will verify same in the open-court, that :all herein be true and correct to the best of :i- man's knowledge;

Jan 14, 2021 - Darrell James Hill, Claimant
:Darrell- James: Hill, -i- man -i- Claimant



- 1 :Respondent -:in -principal, -:Donald-John: Trump, et al., et seq. means: Barack-Hussein, Loretta: Lynch, Common-law-Trustee, 'CLT', -:U.S. government, et seq.
- 2 :CLAIM-OF-RIGHT: JOINED BY THE RESPONDENT means: See: DECLARATION: RESPONDENT.
- 3 :This :court-of-record must be by the Trial-by-Jury means: the judgment must be by the power of the sovereign-assembly- oversight.
- 4 :must be by the Trial-by-Jury to decide upon the facts and the law of the Covenant-agreements means: must be completed under the authority of the sovereign-powers.
- 5 :in- honor means: not in discretion unto dishonor. See: Notary-Pubic Dishonor -DOCUMENT. August 7th, 2018; See: Public-record document: Gila-county-Recorder, Arizona-state: Doc # 2018-9291 pp. 825-832.
- 6 :republic- founding- covenants :in- law for the United States of America- people means: Declaration of Independence of 1776 A.D. for :man; Articles of Confederation of 1777 A.D. for states; The Constitution for the United States of America of 1787-1789, et al.- including: the Bill of Rights, et seq.- Emancipation Proclamation Of 1863 A.D., Lieber Code of 1863 A.D. for :government; and, thereto: Emergency Banking Act of 1933 A.D., et al., and, also including the treaty: International Covenant on Civil and Political Rights of 1966 A.D.- ratified by the U.S.-Corp. Senate -:1992 A.D. for government-services.
- 7 :PE -COVENANT- AGREEMENT' means: September 07, 2016, et seq. See: Public-record document: Gila-county-Recorder, Arizona-state: Doc # 2017-002378, pp.1-239, et al.
- 8 :LOT -ONE means: USPO RMN: RE 322 399 279 US; October 25th, 2017: 11:02 a.m.: See: Public-record document: Gila-county-Recorder, Arizona-state: Doc # 2017-002378, pp.240 -584, et al.
- 9 :LOT -TWO means: January 4th 2017; 5:00 p.m.- contract-agreement. CMN 7009 1410 0000 7868 5703. See: Public-record document: Gila-county-Recorder, Arizona-state: Doc # 2017-002378, pp. 618- , et al. See: "Affidavit: Proof of Claim"- Public-record document: Gila-county-Recorder, Arizona-state: Doc # 2017- 006522, pp. 1- 54.
- 10 :LOT -THREE means: : USPO RMN: RE 322 399 251 US; March 20, 2017: 9:43 a.m.: See: Public-record document: Gila-county-Recorder, Arizona-state: Doc # 2019-009291, pp.1 - 333, et al.
- 11 :LOT -FOUR means: : USPO RMN: RE 322 399 248 US; September 15th, 2017: 11:11 a.m.: See: Public-record document: Gila-county-Recorder, Arizona-state: Doc # 2019-009291, pp.375 - 737, et al.

Unofficial

1804



Darrell-James: Hill, -civilian, -:Executor
PO Box 3806
Apache Junction, Arizona 85117

:man :present,

Arizona state
Maricopa county

**:In :Hill – Court of :Record
At: Maricopa County Superior Court**

:Darrell-James: Hill,
:Claimant- beneficiary

:declaration: averments: claimant

:matter # RE 322 398 389 US

:Donald-John: Trump,
:Respondent- :Trustee, et al.- :man-actor
-Trustees

(verified)

Under-:Procurator For Respondent
:darrell-james: hill, -:man -:Procurator

1. Regarding the :PE, Lots -:One, Two, Three and Four-Covenant-agreements, the man-Respondent-Trustee has administered the property of :i- man without right or :i- man' s wish, possessed :i- man's property without right or :i- man's wish, and is detaining :i- man's property without right or :i- man's wish.
2. :i- man see no verifiable evidence that Declaration of Independence- 1776 A.D., 'DOI-1776-A.D.', enables the :violation of :i- man's unalienable rights, and :i- man believe no evidence to the contrary exists.
3. :i- man see no verifiable evidence that the DOI-1776-A.D., et seq., did not create to option and obligation for the United-States-of-America -people, e.g.- :i- man, to chose their political-election(s) and relationship to their government(s), and :i- man believe no evidence to the the contrary exists.
4. :i- man see no verifiable evidence that the United-States of America¹- slavery, et al. damage, et seq., upon :i- man's heritage, et seq., did not deprive :i- man's :unalienable -rights under the DOI-1776-A.D., and :i- man believe no evidence to the contrary exists.
5. :i- man see no verifiable evidence that the Declaration of Independence- 1776 A.D. is rescinded, and :i- man believe no evidence to the contrary exists.
6. :i- man see no verifiable evidence that the The Constitution for the United States of America-1787- 1789 A.D., et al.- Bill of Rights, et seq.- Amendments for the people of the United States of America is rescinded, and :i- man believe no evidence to the contrary exists.
7. :i- man see no verifiable evidence that the DOI-1776-A.D. covenant-agreement between the United States of America-people and the Almighty-God permits the enslavement and/or unlawful economic-confinement of the Negro-Ysrael, -House of Judah -':United States of America-people', and :i- man believe no evidence to the contrary exists.
8. :i- man see no verifiable evidence that the DOI-1776-A.D. covenant-agreement between the United States of America-people and the Almighty-God permits the enslavement and unlawful confinement of the Negro-Ysrael, -'House of Judah' :in violation of :KJV-Book: Leviticus -Chap. 25², and :i- man believe no evidence to the contrary exists.

1 : United-States of America means: the people over-standing the government under the The Constitution for the United States of America-1787- 1789 A.D., et al.- Bill of Rights, et seq.- Amendments.

2 :KJV- Book- Leviticus- Chap.: 25 means: Lev 25:38 I am the LORD your God, which brought you forth out of the land of Egypt, to give you the land of Canaan, and to be your God. 25:39 And if thy brother that dwelleth by thee be waxen poor, and be sold unto thee; thou shalt

:DECLARATION: CLAIMANT

1 / 7



9. :i- man see no verifiable evidence that the Articles of Confederation- 1777 A.D. has authority to violate the Declaration of Independence- 1776 A.D., and :i- man believe no evidence to the contrary exists
- 10 :i- man see no verifiable evidence that under The Constitution for the United States of America-1787- 1789, the Executive Order for the Emancipation Proclamation- 1863 A.D. enables for the :any-deprivation of :i- mans' unalienable rights, and :i- man believe no evidence to the contrary exists.
11. :i- man see no verifiable evidence that the Emancipation Proclamation- 1863 A.D. with the Lieber Code- 1863 A.D. enables for the deprivation of :i- mans' unalienable rights, and :i- man believe no evidence to the contrary exists.
12. :i- man see no verifiable evidence that the UNITED STATES-CORP', 'U.S.-Corp', is not the government services provider understanding :The Constitution for the United States of America -1787- 1789 A.D., et seq.- Emancipation Proclamation -1863 A.D. and the Lieber-Code-1863-A.D., and :i- man believe no evidence to the contrary exists.
13. :i- man see no verifiable evidence that the U.S.-Corp. -man-actors -in- office have authority to violate the Lieber-Code- 1863 A.D., and :i- man believe no evidence to the contrary exists.
14. :i- man see no verifiable evidence that the U.S.-Corp. -man-actors :in-office have authority to violate the Emancipation-Proclamation- 1863 A.D., and :i- man believe no evidence to the contrary exists.
15. :i- man see no verifiable evidence that the U.S.-Corp. -man-actors :in-office have authority to violate The Constitution for the United States of America- 1787- 1789, et seq., and :i- man believe no evidence to the contrary exists.
16. :i- man see no verifiable evidence that :U.S.-Corp. -man-actors -in- office-of-trustee have authority to deprive :i- man of the Declaration of Independence- 1776 A.D. rights, and :i- man believe no evidence to the contrary exists.
17. :i- man see no verifiable evidence that the U.S.-Corp. -man-actors have right to ignore or otherwise deny the :chose of the political-election by :i- man, and :i- man believe no evidence to the contrary exists.
18. :i- man see no verifiable evidence that the U.S.-Corp.- man-actors have right to impair its :Covenant-Agreement -obligations for to assure and ensure :i- man's right for the remedy by :procuration for the property stolen in this 'out of court- judgment' -matter, and :i- man believe no evidence to the contrary exists.
19. :i- man see no verifiable evidence that the U.S.-Corp.- man-actors have right to deprive :i- man of life, liberty, or property, without due process of law, and :i- man believe no evidence to the contrary exists.
20. :i- man see no verifiable evidence that the U.S. -Corp.- man-actors have right to deprive :i- man of private-property for the public use, without just compensation, and :i- man believe no evidence to the contrary exists.
21. :i- man see no verifiable evidence that the U.S. -Corp.- man-actors have right to deprive or otherwise deny :i- man- Darrell-James: Hill, the guaranteed right of :suit at :common-law, where the value in the matter has exceeded twenty dollars, and :i- man believe no evidence to the contrary exists.

not compel him to serve as a bondservant Lev 25:40 *But as an hired servant, and as a sojourner, he shall be with thee, and shall serve thee unto the year of jubile:*
 25:41 *And then shall he depart from thee, both he and his children with him, and shall return unto his own family, and unto the possession of his fathers shall he return.*
 25:42 *For they are my servants, which I brought forth out of the land of Egypt: they shall not be sold as bondmen.*
 25:43 *Thou shalt not rule over him with rigour; but shalt fear thy God.*

1 :'**UNITED STATES-CORP'** means: 1) the :government-services- provider-1933-A.D., and :self-indentured- Trustee of the :Legislative -Dry-Trust: Emergency Banking Act of 1933 A.D.





22. :i- man see no verifiable evidence that the U.S. -Corp.-man-actors have right to :i- man's sovereign- rights -Not -delegated in The Constitution for the United States of America- 1787-91, et al., and :i- man believe no evidence to the contrary exists

23. :i- man see no verifiable evidence that the U.S. -Corp.- man-actors have right to the sovereign-powers -Not -delegated by :i- man in The Constitution for the United States of America- 1787- 1789, and :i- man believe no evidence to the contrary exists.

24. :i- man see no verifiable evidence that the U.S. -Corp.-man-actors have right to violate the: right of :i- man to be secure in :i-man's persons, houses, papers, and effects, against unreasonable searches and seizures, and :i- man believe no evidence to the contrary exists.

25. :i- man see no verifiable evidence that the U.S. -government- man-actors may engage in insurrection or rebellion against The United States of America, 1787- 1789 A.D., or give aid or comfort to the enemy, and :i- man believe no evidence to the contrary exists.

26. :i- man see no verifiable evidence that the Word of God: KJV: Holy-Bible: Torah, prophets and writings permits the :enslavement of the Negro-Ysrael -House of Judah in the Seventeenth Century- A.D. :in-violation of :KJV-Book: Leviticus -Chap. 25¹, and :i- man believe

- 1 :KJV- Book- Leviticus- Chap.: 25 means: Lev 25:38 I am the LORD your God, which brought you forth out of the land of Egypt, to give you the land of Canaan, and to be your God.
25:39 And if thy brother *that dwelleth* by thee be waxen poor, and be sold unto thee; thou shalt not compel him to serve as a bondservant:
25:40 *But* as an hired servant, and as a sojourner, he shall be with thee, and shall serve thee unto the year of jubile:
25:41 And *then* shall he depart from thee, *both* he and his children with him, and shall return unto his own family, and unto the possession of his fathers shall he return.
25:42 For they *are* my servants, which I brought forth out of the land of Egypt: they shall not be sold as bondmen.
25:43 Thou shalt not rule over him with rigour; but shalt fear thy God.

Deuteronomy 15:1 At the end of every seven years thou shalt make a release.

15:2 And this *is* the manner of the release: Every creditor that lendeth *ought* unto his neighbour shall release *it*; he shall not exact *it* of his neighbour, or of his brother; because it is called the LORD'S release.

15:3 Of a foreigner thou mayest exact *it again*; but *that* which is thine with thy brother thine hand shall release;

15:4 Save when there shall be no poor among you; for the LORD shall greatly bless thee in the land which the LORD thy God giveth thee for an inheritance to possess it:

15:5 Only if thou carefully hearken unto the voice of the LORD thy God, to observe to do all these commandments which I command thee this day.

15:6 For the LORD thy God blesseth thee, as he promised thee: and thou shalt lend unto many nations, but thou shalt not borrow; and thou shalt reign over many nations, but they shall not reign over thee.

15:7 If there be among you a poor man of one of thy brethren within any of thy gates in thy land which the LORD thy God giveth thee, thou shalt not harden thine heart, nor shut thine hand from thy poor brother:

15:8 But thou shalt open thine hand wide unto him, and shalt surely lend him sufficient for his need, *in that* which he wanteth.

15:9 Beware that there be not a thought in thy wicked heart, saying, The seventh year, the year of release, is at hand; and thine eye be evil against thy poor brother, and thou givest him nought; and he cry unto the LORD against thee, and it be sin unto thee.

15:10 Thou shalt surely give him, and thine heart shall not be grieved when thou givest unto him: because that for this thing the LORD thy God shall bless thee in all thy works, and in all that thou puttest thine hand unto.

15:11 For the poor shall never cease out of the land: therefore I command thee, saying, Thou shalt open thine hand wide unto thy brother, to thy poor, and to thy needy, in thy land.

15:12 *And* if thy brother, an Hebrew man, or an Hebrew woman, be sold unto thee, and serve thee six years; then in the seventh year thou shalt let him go free from thee.

15:13 And when thou sendest him out free from thee, thou shalt not let him go away empty:

15:14 Thou shalt furnish him liberally out of thy flock, and out of thy floor, and out of thy winepress: *of that* wherewith the LORD thy God hath blessed thee thou shalt give unto him.

15:15 And thou shalt remember that thou wast a bondman in the land of Egypt, and the LORD thy God redeemed thee: therefore I command thee this thing to day.

15:16 And it shall be, if he say unto thee, I will not go away from thee; because he loveth thee and thine house, because he is well with thee;

15:17 Then thou shalt take an aul, and thrust *it* through his ear unto the door, and he shall be thy servant for ever. And also unto thy maidservant thou shalt do likewise.

1887



no evidence to the contrary exists.

27. :i- man see no verifiable evidence that The United States of America, 1787- 1789 A.D. Article 1, Section 9 did not enable systemic- extenuating -harms- ongoing upon the unalienable- rights of the House of Judah, sons of Ysrael¹ , and :i- man believe no evidence to the contrary exists

28. :i- man see no verifiable evidence that the U.S.-Corp's :any -deprivation and/or theft of :i- man's -property is not :wrong-doing and continuing-harm upon the life and liberty of :i- man, and :i- man believe no evidence to the contrary exists.

29. :i- man see no verifiable evidence that the U.S. -Corp.- man-actors must not guarantee the :republican²-form of :government to :i- man now, and :i- man believe no evidence to the contrary exists.

30. :i- man see no verifiable evidence that the U.S. -Corp.- man-actors, et al. -:all executive and judicial Officers must not by Oath or Affirmation bind themselves to :absolute-support and defend of :The Constitution for the United States of America -1787- 1789 A.D., and :i- man believe no evidence to the contrary exists.

31. :i- man see no verifiable evidence that the 'United States of America', 'USofA', does not denote 'the :people' of the United States of America³, and :i- man believe no evidence to the contrary exists.

32. :i- man see no verifiable evidence that the :man- :Respondent-Trustee's seizing the :Claimant-beneficiary's -:private- property without warrant is not unlawful, and :i- man believe no evidence to the contrary exists.

33. :i- man see no verifiable evidence that the man- :Respondent-Trustee agrees to bring no writ or error, or to file a bill of equity, so as to delay or that could delay the :remedy to the man- Claimant- beneficiary, and :i- man believe no evidence to the contrary exists.

34. :i- man- Claimant accept the oaths of the trustee and the officers-of-trustee to their fidelity :in the commitment, and none else.

35. :i- man see no verifiable evidence that the ICCPR-1992-A.D did not obligate for the United-States-of-America -people, e.g.- :i- man, to execute their fundamental-rights, :natural, :common and inherent-rights as the :man-Claimant-beneficiary exercised and executed :in the Covenant-Agreements - :PE, :Lots -One, Two, Three; and Four; and, :i- man believe no evidence to the contrary exists.

36. :i- man see no verifiable evidence that the International Covenant of Civil and Political Rights, 'ICCPR-1992-A.D.', enables for the deprivation of :i- mans' unalienable right-executed of the DOI-1776-A.D., et seq., and :i- man believe no evidence to the contrary exists.

37. The Right to chose the political-election for :i- man is executed with the express, sealed and specially-delivered -:PE-Covenant-agreement.

38. :i- man see no verifiable evidence that 'voidance-of-benefit⁴' by the Respondent is not acting within the :silent- acquiescenc⁵e with the express- procuration⁶ -agreement for to enable the execution of the right for the remedy for the Claimant, and :i- man believe no evidence to the

15:18 It shall not seem hard unto thee, when thou sendest him away free from thee; for he hath been worth a double hired servant to thee, in serving thee six years: and the LORD thy God shall bless thee in all that thou doest.

1 : sons of Ysrael means: aka sons of 'Israel': sons of Jacob, Isaac and Abraham, of : Shem, Noah,... of: Methuselah, of Enoch,... of Seth, of the line of Adam and Eve of the garden of Eden.

2 :republican means: based :in the laws of the people, the government open to :all of the people.

3 ':The Declaration of Independence: 'Action of Second Continental Congress.. of the thirteen united States of America.' Same determination Held by by the Supreme Court of the United States.

4 :voidance-of-benefit means: the methodology of ignoring the beneficiary's several requests for the :any :benefit until the beneficiary either dies or for any reason abandons the beneficiary-claim.

5 :silent- acquiescence means: quiet agreement to the contract-agreement proposed.

6 :express- procuration means: the written and/or stated derived giving lawful authority to act as would the principal would act for himself.



contrary exists.

39. :i- man see no verifiable evidence that the :Trustee-Respondent- obligor does not admit to covenant-agreements with the property-claimed and possessed with the deprivation-penalties with the :procurator for the remedy by the man-Claimant-beneficiary, and :i- man believe no evidence to the contrary exists.

40. :i-man see no verifiable reason why the procurator must-not seek to eliminate the ongoing-harms upon man-Claimant, Darrell-James: Hill, et al.- family.

41. :i- man see no verifiable evidence that :all of the man -Claimant-beneficiary- covenant-documents :in the pursuit of the 'stolen' -property-claimed and possessed are not the :material-facts in :i- man's execution of the fundamental-right-laws available to the United-States-of-America -people, and :i- man believe no evidence to the contrary exists.

42. :i- man see no verifiable evidence that since **October 25th, 2016, 11:02 a.m.**, the :Lot -One -:Covenant-agreement is not the 'First Offense' by the 'Political-Election-Covenant-Agreement' as the result of the deprivation of the private- property- claimed and possessed with the harm thereby to the man- Claimant :in- accordance with the :Lot-One -:Covenant-agreement, :in violation of: a) The Declaration of Independence- 1776 A.D. 'unalienable-rights... life, liberty and the pursuit of Happiness'; b) The Constitution for the United States of America, 1787 A.D., Art. I, Section 10.²: 'No State shall ... pass any ... Law impairing the Obligation of Contracts', with c) the Bill of Rights, 1791 A.D.: Amendment V³: 'No person shall be ... deprived of life, liberty, or property, without due process of law; nor shall private property be taken for public use without just compensation.', and :i- man believe no evidence to the contrary exists.

43. :i- man see no verifiable evidence that Since **January 4th, 2017, 5:00 p.m.**, the :Lot -Two -:Covenant-agreement is not the 'Second Offense' by the 'Political-Election-Covenant-Agreement' as the result of the deprivation of the private- property- claimed and possessed with the harm thereby to the man- Claimant :in- accordance with the :Lot-Two -:Covenant-agreement, :in violation of: a) The Declaration of Independence- 1776 A.D. 'unalienable-rights... life, liberty and the pursuit of Happiness'; b) The Constitution for the United States of America, 1787 A.D., Art. I, Section 10.: 'No State shall ... pass any ... Law impairing the Obligation of Contracts', with c) the Bill of Rights, 1791 A.D.: Amendment V: 'No person shall be ... deprived of life, liberty, or property, without due process of law; nor shall private property be taken for public use without just compensation.', and :i- man believe no evidence to the contrary exists.

44. :i- man see no verifiable evidence that Since **March 20th, 2017, 9:43 a.m.**, the :Lot-Three -:Covenant-agreement is not the 'Third Offense' by the 'Political-Election-Covenant-Agreement' as the result of the deprivation of the private- property- claimed and possessed with the harm thereby to the man- Claimant :in- accordance with the :Lot-Three -:Covenant-agreement, :in violation of: a) The Declaration of Independence- 1776 A.D. 'unalienable-rights... life, liberty and the pursuit of Happiness'; b) The Constitution for the United States of America, 1787 A.D., Art. I, Section 10.: 'No State shall ... pass any ... Law impairing the Obligation of Contracts', with c) the Bill of Rights, 1791 A.D.: Amendment V: 'No person shall be ... deprived of life, liberty, or property, without due process of law; nor shall private property be taken for public use without just compensation.', and :i- man believe no evidence to the contrary exists.

45. :i- man see no verifiable evidence that Since **September 15th, 2017, 11:11 a.m.** the :Lot-Four -:Covenant-agreement is not the 'Third Offense' by the 'Political-Election-Covenant-Agreement' as the result of the deprivation of the private- property- claimed and possessed with the harm thereby to the man- Claimant :in- accordance with the :Lot-Four -:Covenant-agreement, :in violation of: a) The Declaration of Independence- 1776 A.D. 'unalienable-rights... life, liberty and the pursuit of Happiness'; b) The Constitution for the United States of America, 1787 A.D., Art. I, Section 10.: 'No State shall ... pass any ... Law impairing the Obligation of Contracts', with c) the Bill of Rights, 1791 A.D.: Amendment V: 'No person shall be ... deprived of life, liberty, or property, without due process of law; nor shall private property be taken for public use without just compensation.', and :i- man believe no evidence to the contrary exists.

1 :The Declaration of Independence- 1776 A.D. means: the un-obstructable, 'unalienable-rights... to life, liberty and the pursuit of Happiness'

2 :The Constitution for the United States of America, 1787 A.D., Art. I, Section 10. means: 'No State shall ... pass any ... Law impairing the Obligation of Contracts'

3 :Bill of Rights, 1789 A.D.: Amendment V means: 'No person shall be ... deprived of life, liberty, or property, without due process of law; nor shall private property be taken for public use without just compensation.'

1809



46. The fact of the simple- theft(s) by the man-Respondent-Trustee is Not in- controversy under the Covenant-agreements within the deprivation-penalty- covenant-agreement for the withholding and/or administrating without-right the private- property-claimed and possessed by the Claimant-beneficiary

47. I- man see no verifiable evidence that the man- Claimant-beneficiary did not in the complete -fullness execute the right to claim fundamental rights to the property-claimed and possessed that was deprived from the Claimant-beneficiary by the Respondent-Trustee in the PE, Lots -One, Two, Three and Four-Covenant-agreements, and I- man believe no evidence to the contrary exists.

48. I- man see no verifiable evidence that the Property-claimed and possessed by the Claimant was not lawfully received by the man-Respondent-Trustee, et al. - Donald-John: Trump, et al.- man- actors, and none else; and I- man believe no evidence to the contrary exists.

49. I- man see no verifiable evidence that the Respondent-Trustee must not now-absolutely report to the man- Claimant-beneficiary the account for all of the PE, Lots -One, Two, Three and Four-Covenant-agreements -property-claimed and possessed by the man-Claimant that is stolen/withholden by the Respondent-Trustee, and I- man believe no evidence to the contrary exists.

50. I- man see no verifiable evidence that the 'Out of Court- judgment' is not established in the Dishonor by the Respondent-Trustee within the processes of the Arizona-state-official in the Notary-Pubic -Protest unto the Notary-Pubic -Dishonor, and I- man believe no evidence to the contrary exists.

51. I- man see no verifiable evidence that the 'out of court' -judgment by the Arizona State Official regarding PE, Lots -One, Two, Three and Four-Covenant-agreements are not established by the Arizona-state -Notary -Protest unto the Notary-Public -Dishonor in this matter with the PE -Covenant- Agreement and the Lots -One, Two, Three and Four-Covenant-agreements, and I- man believe no evidence to the contrary exists.

52. I- man see no verifiable evidence that the all- property, of the PE, Lots -One, Two, Three and Four-Covenant-agreements are not properly- claimed and possessed by the Claimant- beneficiary, and I- man believe no evidence to the contrary exists.

53. I- man see no verifiable evidence that the non-controversy in the matter by procuracy by the man-Claimant-beneficiary for the right of the remedy is not in accordance with the deprivation-penalty in the PE, Lots -One, Two, Three and Four-Covenant-agreements within the Political-Election -Covenant- Agreement: 'First-Offense', and I- man believe no evidence to the contrary exists.

54. I- man see no verifiable evidence that the Respondent-Trustee has not converted the deprived/stolen PE, Lots -One, Two, Three and Four-Covenant-agreements-property, et al. - tangible and in-tangible property, and I- man believe no evidence to the contrary exists.

55. I- man see no verifiable evidence that the harms and damages presently endured by the man -Claimant-beneficiary are not the result of the ongoing- same daily and cumulative losses, and require immediate remedy post-haste, and I- man believe no evidence to the contrary exists.

56. I- man see no verifiable evidence that the Lots -One, Two, Three and Four-Covenant-agreements deprivation-penalty payment(s) is not in -accordance with the Political-Election-covenant, -Offense-levels in-accordance to the Covenant- agreements, and I- man believe no evidence to the contrary exists.

57. I- man see no verifiable evidence that the Jury-members are not required to refer the man-Respondent-Trustee's larceny to the grand-jury of this state, and I- man believe no evidence to the contrary exists.

58. I- man see no verifiable evidence that the immediate Covenant-Agreement- oversight by man-actor's of The United States of America- Army, et al.- military is not in- accordance with the man-Claimant's proper expectation to the Emancipation Proclamation-1863-A.D. and with the Lieber-Code-1863-A.D. -protection, and I- man believe no evidence to the contrary exists.



59. I see no verifiable evidence that the USofA-Army-actors, et al.-military must not serve to administer-oversight to the POTUS-actors- in-office due to the Respondent-Trustee's -Larceny and Dishonor, so to assure and ensure the property-Claimed and possessed is restored to the man-Claimant upon the order of the court-of-record, and I believe no evidence to the contrary exists.

60. I see no verifiable evidence that the all of the property, e.g.- tangible and intangible of the Lot-One Covenant-Agreement -property, is not properly- claimed and possessed and only is by wrong-doing deprived from the Claimant-beneficiary by the Respondent-Trustee without right, without authorization, without warrant nor receipt of the necessity from the Respondent-Trustee, and I believe no evidence to the contrary exists.

61. I see no verifiable evidence that the Property-claimed and possessed in the PE, Lots -One, Two, Three and Four-Covenant-agreements are wholly-personally -not -owned by the man-beneficiary- Darrell-James: Hill, -beneficiary, -civilian., and I believe no evidence to the contrary exists.

I say here under penalty of perjury, and will verify same in the open-court, that all herein be true and correct to the best of my knowledge;

Jan-14, 2021  Darrell James Hill, Claimant
Darrell- James: Hill, :Executor, Claimant

Unofficial

Darrell-James: Hill, -civilian
PO Box 3806
Apache Junction, Arizona 85117

:man :present,:procurator

Arizona state
Maricopa county

:In :Hill – Court of :Record
At: Maricopa County Superior Court

:Darrell-James: Hill,
:Claimant- beneficiary

:Donald-John: Trump,
:Respondent- :Trustee, et al.- :man-actor
-Trustees, et seq.

in: Procuration¹,
:man- Procurator: darrell-james: hill

:matter # RE 322 398 389 US

:declaration-
:stipulations: procurator as
:respondent

(VERIFIED)

: Respondent-Trustee Joined-Matter :in -Non-Controversy in: Procuration
By :Covenant- Agreement To Effect the :Remedy for the Claimant-Beneficiary

CLAIM-OF-RIGHT: JOINED BY THE RESPONDENT

1. :i- man -:darrell-james: hill ~also know as :man-Claimant- Darrell-James: Hill~ is :Ohioan, one of the people and inhabitant of :Arizona state, and in this court of record also serves as the procurator as the man -:Donald-John: Trump². -Respondent would in these matters. :in-honor, :in- non-controversy-matter, and -:in accordance with the Covenant-Agreements by the 'out-of-court-judgment' unto and until the remedy is completed solely for the benefit of the Claimant.
2. :i- man -Procurator as the Respondent is :in -honor to :in-certainty admit and declare that the covenant-agreement- "out-of-court" -judgments abides under the Law of the Covenants.
3. :i- man -Procurator as the :Respondent-Trustee- man -:Donald-Trump, et al., act :in -honor for to assure and ensure the right of the remedy -obligations for the Claimant-beneficiary within the confines of the law of the covenant-agreements.
4. :i- man -Procurator as the Respondent is :in -honor to stipulate-to and agree-upon the Claimant-averments. See: :CLAIM # RE 322 398 389 US.
5. :i- man -Procurator as the :Respondent-Trustee- man -:Donald-Trump, et al., act :in -honor for to assure and ensure the right of remedy for the Claimant-beneficiary from the Respondent within the confines of the law of the PE covenant-agreement(s), hereafter, included by reference.
6. :i- man -Procurator as the Respondent is :in -honor in these matters-agreed is :in- trust for to assure and ensure the right to the remedy to the Claimant :in-accordance with the Covenant-agreements.
7. RESPONDENT-NOTIFICATION of the matter to :i- man-procurator is completed on the 14th day January, 2021, by third-party service. Notice of same will be made by the USPO-delivery to and :general -public -notice of :delivery for the :Respondent -in -principal, -:Donald-John: Trump, et al.

1 :Procurator means: when one person gives power to another to act in his place as he could do for himself.

2 :Respondent -:in -principal, -:Donald-John: Trump, et al., et seq. means: Barack-Hussein, Loretta: Lynch, Common-law-Trustee, 'CLT', -:U.S. government, et seq.

18/12

8. :i- man -Procurator as the Respondent is :in -honor to affirm that Procuration in these matters-agreed is :in- trust for to assure and ensure the right to the remedy to the Claimant :in- accordance with the Covenant-agreements, to answer the rights-exercised, and :in- non-controversy to report same to the Respondent, et al.

9. :i- man -Procurator as the Respondent is :in -honor to stipulate-to and agree-upon to affirm that Procuration in these matters is :in- trust to the man-procurator- :darrell-james: hill as relates to the Respondent's- present- standing :in- Notarial-Public- Dishonor concerning these Covenant-agreement- matters.

10. :i- man -Procurator as the :Respondent-Trustee- man -:Donald-John: Trump, et al., agree with the rule of preclusion here-to-fore and now-to-after to must-not-bring :writ of error, or file a bill of equity so as could cause :any-delay in the immediate-remedy against the admitted-damages- endured to now and ongoing now-after, but to now-to-fore cease :all -wrong-doing and damages :in-effect upon the man- Claimant- beneficiary- forever, and :none-else harms.

11. :i- man -Procurator as the Respondent is :in -honor to agree that: The Covenant Agreements between the Claimant and Respondent/procuration are founded in the fundamental-rights- law- guarantees derived from the people-sovereigns that establish the republic- founding- covenants :in -all- Law for the United States of America- people'.

12. :i- man -Procurator as the Respondent is :in -honor to stipulate-to and agree-upon the Claim #RE 322 398 389 US by the man -Claimant.

13. :i- man -Procurator as the Respondent is :in -honor to agree with the PROCURATOR-RESPONDENT -:COVENANT-AGREEMENTS:

- a) that the claimants full- rights to the property-claimed is valid;
- b) that the deprivation-payment agreement for the withholding of the property-claimed is valid;
- c) that the non-controversy by :procuration by the man -:darrell-james: hill, -procurator, ministering as the Respondent is warranted :in-accordance with the covenant-agreements, and valid.

14. :i- man -Procurator as the Respondent is :in -honor to agree, that: The 'Affidavit of Superior Constructive Notice and Demand; Permanent Non-Commercial Presumption'; and: AFFIDAVIT: Constructive Notice of 'DARRELL JAMES HILL' of 'Darrell-James: of the family Hill' Authorized Representative, 'Political-Election-covenant- agreement', 'PE', is the express, signed, sealed and specially -delivered-covenant executed and executory for to affirm that the property for :all- inherent and fundamental rights, tangible and intangible, private real and chattel property-claimed and possessed, is restored to the man- covenantor- Claimant -:darrell-james: hill -beneficiary, to:

- a) :in -non-controversy by :procuration assure and ensure the absolute-remedy for :Claimant :in -accordance with the covenant-agreements: PE-covenant- agreement, et seq.- offense- levels with the particular breach of the covenant -agreements;
- b) to release the :property-claimed and possessed according to the covenant-agreement;
- c) to pay the penalty for the offenses in the deprivation of the private-property :in -accordance with the covenant-agreements;
- d) to assure the :restoration of :property-claimed and possessed :in -accordance with the covenant-agreements :in -honor.

15. :i- man -Procurator as the Respondent is :in -honor to agree, that: 'LOT-ONE'- COVENANT-AGREEMENT' :Respondent Breach Of :COVENANT- Agreement: The: 'NOTICE: CLAIM,RE: Property disposed to the United States of America in the "UNITED STATES ATTORNEY'S OFFICE: OFFICIAL NOTIFICATION POSTED ON OCTOBER 12, 2016', 'Lot-One'- Covenant-agreement' is the express, signed, sealed and specially -delivered-covenant executed for the restoration of the private property- claimed and possessed under the condition stipulated- to and agreed-upon for the deprivation of :private-property-penalty- obligation :in the Covenant- Agreements at :one- U.S.- dollar -silver -:in- specie per :minute :in-accordance with the Lot-One- Covenant-Agreement, subject to the First-Offense -level of the PE- Covenant-agreement.

1 :republic- founding- covenants :in- law for the United States of America- people means: Declaration of Independence of 1776 A.D. for :man; Articles of Confederation of 1777 A.D. for states; The Constitution for the United States of America of 1787-1789, et al.- including: the Bill of Rights, et seq.- Emancipation Proclamation Of 1863 A.D., Lieber Code of 1863 A.D. for :government; and, thereto: Emergency Banking Act of 1933 A.D., et al., and, also including the treaty: International Covenant on Civil and Political Rights of 1966 A.D.- ratified by the U.S.-Corp. Senate -:1992 A.D. for government-services.



16. :i- man -Procurator as the Respondent is :in -honor to agree, that: 'LOT-TWO'- COVENANT-AGREEMENT' :Respondent Breach Of :COVENANT- Agreement: The: 'i: man: Darrell-James: Hill; prosecutor, Claimant'; Claimant Case No: CMN 7009 1410 0000 7868 5703', 'Lot-Two'- Covenant-agreement', is the express, signed, sealed and specially -delivered-covenant executed for the restoration of the right in the Court-of-Record in the matter of the stolen/deprived property-claimed and possessed in the 'Lot-One-covenant- agreement' under the conditions stipulated-to and agree-upon for the restoration of the property- claimed and possessed under the covenant-agreement-obligations at :one- U.S.- dollar -silver -:in- specie per :minute :in-accordance with the Lot-Two- Covenant-Agreement, subject to the Second-Offense -level of the PE- covenant-agreement.

17. :i- man -Procurator as the Respondent is :in -honor to agree, that: 'LOT-THREE'- COVENANT-AGREEMENT' :Respondent Breach Of :COVENANT- Agreement: The: 'NOTICE: CLAIM, RE: Property disposed to the United States of America in the 'UNITED STATES ATTORNEY'S OFFICE; OFFICIAL NOTIFICATION POSTED ON FEBRUARY 13, 2017'', 'Lot-Three'- Covenant-agreement' is the express, signed, sealed and specially -delivered-covenant-executed for the restoration of the private property -claimed and possessed under the conditions stipulated-to and agreed-upon for the deprivation of :private-property-penalty- obligation :in the Covenant-Agreements at :one- U.S.- dollar -silver -:in- specie per :minute :in-accordance with the Lot-Three- Covenant-Agreement, subject to the Third-Offense -level of the PE- Covenant-agreement.

18. :i- man -Procurator as the Respondent is :in -honor to agree, that: 'LOT-FOUR'- COVENANT-AGREEMENT' :Respondent Breach Of :COVENANT- Agreement: The: 'CLAIM: NOTICE AND DEMAND, RE: Property disposed to the United States of America reported in the 'UNITED STATES ATTORNEY'S OFFICE; OFFICIAL NOTIFICATION POSTED ON AUGUST 30, 2017'', 'Lot-Four'- Covenant-agreement' is the express, signed, sealed and specially -delivered-covenant executed for the restoration of the private property- claimed and possessed under the condition stipulated-to and agreed-upon for the deprivation of :private-property-penalty- obligation :in the Covenant-Agreements at :one- U.S.- dollar -silver -:in- specie per :minute :in-accordance with the Lot-Four- Covenant-Agreement, subject to the Third-Offense -level of the PE- Covenant-agreement.

19. :i- man -Procurator as the Respondent is :in -honor to :in-certainty admit and declare that the any failings causing the here-to-fore daily harms upon the Claimant-beneficiary is by the 'voidance of benefit' -silently-imposed by the Respondent- trustee.

20. :i- man -Procurator as the Respondent is :in -honor to :in-certainty admit and declare that the 'voidance of benefit' imposition by the Respondent-Trustee upon the man- Claimant merely voids the :rights- executed by the man-Claimant- beneficiary.

21. :i- man -Procurator as the Respondent is :in -honor to :in-certainty admit and declare that the 'voidance of right of :benefits' imposed the ':voidance of :unalienable-rights -doctrine' over the Law for the United States of America-people, or the Declaration of Independence, 1776 A.D., et seq. -:fundamental, natural and common-law -rights to life, liberty, property and the pursuit of happiness.

22. :i- man -Procurator as the Respondent is :in -honor to :in-certainty admit and declare that the voidance of rights-executed must necessarily did void several restrictions and safeguards that have been put in place to assure and ensure protection of the :same-rights voided by the Respondent; that, all of the harm required that the United States-Corp, et al., void :The Constitution for the United States of America, 1787-1789 A.D., et al.- Bill of Rights, et seq.- Emancipation Proclamation of 1863 A.D., Lieber-Code-1863 A.D.; and, the :International Covenant on Civil and Political Rights-, 'ICCPR', 1992 A.D., by operating in the 'voidance of benefits' upon/against the Claimant's :All-rights.

23. :i- man -Procurator as the Respondent is :in -honor to :in-certainty submit under the PE-covenant-agreement and to immediately restore :all- property :in-specie as agreed-upon in the PE and Lots -One, Two, Three and Four -Covenant-agreements.

24. :i- man -Procurator as the Respondent is :in -honor to :in-certainty admit and declare that the 'Bills of Particulars', 'BOP', for the deprivation of property :in the Lot- One, Two, Three and

1 :voidance of benefit means: the administrator -:in-oversight abandonment of benefit to the beneficiary.

January 14, 2021 :STIPULATIONS: PROCURATOR :matter # RE 322 398 389 US 3 /6

2022-011769 MISC Page: 1823 of 2782
09/26/2022 03:35:37 PM Receipt #: 22-9381
Rec Fee: \$30.00 Darrell James Hill
Gila County, Az, Sadie Jo Bingham, Recorder



Four- Covenant-agreement is a) received by the Respondent-Trustee, et al.- man-actors, b) is the obligation in-accordance with the covenant-agreements, and c) no obligation has been met. received by the Respondent-Trustee, et al.- man-actors, b) is the obligation in-accordance with the covenant-agreements, and c) no obligation has been met.

25. :i- man -Procurator as the Respondent is :in -honor to :in-certainty admit and declare that the Respondent-facets against the Claimant's rights-executed are many: a) tacit-acquiescence with b) voidance of benefit,with c) the absolute-deprivation of :all private- property-claimed and possessed, and with d) necessitating-requiring the execution- :in- procuration by the evidence of the breach of :Trust :in -:Trustee-Dereliction.

26. :i- man -Procurator as the Respondent is :in -honor to :in-certainty admit and declare that the 'out of court -judgment' by the Arizona State Official regarding :Lots -One, Two, Three and Four -:Covenant-agreement is established by the Notary-Pubic -:Protest unto the Notary-Public -:Dishonor upon the Respondent, et al.

27. :i- man -Procurator as the Respondent is :in -honor to :in-certainty admit and declare that the voidance of benefits and transparent-process :in the denial of rights-executed are wrong-doings by the Respondent.

28. :i- man -Procurator as the Respondent is :in -honor to :in-certainty admit and declare that the wrong-doings to the man-Claimant daily causes harm to the Claimant and is damages-endured as the result of the deprivation against the Claimant's :rights-executed for: life, liberty and property in the pursuit of :happiness.

29. :i- man -Procurator as the Respondent is :in -honor to :in-certainty admit and declare that for the requirement of the restoration of :property-claimed and possessed by the man- Claimant is established with the :continuous -warrant by the covenant-agreements for the prompt-payment of the deprivation-penalty until the property-claimed and possessed is restored :in- specie to the Claimant-beneficiary :in-accordance with the PE and Lot -One, Two, Three and Four -:Covenant-agreements.

30. :i- man -Procurator as the Respondent is :in -honor to :in-certainty agree and declare that prompt-payment of the deprivation-penalty, if required, must be payment- made cumulative to the month-day-end-cycles, payed on the first day of the following month to the Claimant-beneficiary :in-accordance with the PE and Lots: One, Two, Three and Four -Covenant-agreements.

31. :i- man -Procurator as the Respondent is :in -honor to :in-certainty admit and declare that the PE and Lots -One, Two, Three and Four- Covenant-agreement are :in -non-controversy expressively for to assure and ensure the right of the remedy for the man-Claimant and :in -accordance with the PE -Covenant-Agreement: 'First-Offense'.

32. :i- man -Procurator as the Respondent is :in -honor to :in-certainty admit and declare that :all- property- claimed and possessed :in the PE and Lot -One, Two, Three and Four -Covenant-Agreement is properly- claimed and possessed by the man- Claimant- beneficiary.

33. :i- man -Procurator as the Respondent is :in -honor to :in-certainty admit and declare that: the :Respondent is obligated and required to restore of the property- claimed and possessed, with the payment of deprivation-penalties, and to assure and ensure the right of the remedy to the Claimant-beneficiary with procuration.

34. :i- man -Procurator as the Respondent is :in -honor to :in-certainty admit and declare that by the deprivation of the :Claimant's private-property- claimed and possessed does the Respondent-Trustee victimize-continually the and cause stress and :harm of Respondent-Trustee- :wrong-doing upon the :Claimant-beneficiary.

35. :i- man -Procurator as the Respondent is :in -honor to :in-certainty admit and declare that: the Claimant- beneficiary is :ICCPR -fully -compliant with the absolute-exercise of the fundamental-rights- executed :in the PE and Lots -One, Two, Three and Four -:Covenant-agreements.

36. :i- man -Procurator as the Respondent is :in -honor to :in-certainty admit and declare that: the Harms and Damages now endured by Claimant- beneficiary as the result of the extremely-large deprivations of :all of the Claimants property-claimed and possessed must require immediate remedy post-haste by the order of this court of record.



37. :i- man -Procurator as the Respondent is :in -honor to :in-certainty admit and declare that: the :Trustee- Respondent -agreements are with :Claimant- procurator :in- accordance with the Covenant-Agreements :in :non-controversy here-to-fore and now-to-after.

38. :i- man -Procurator as the Respondent is :in -honor to :in-certainty admit and declare that :in this :Non -controversy- matter, that :all -elements of the private-property- claimed and possessed are: a) deprived from the Claimant-beneficiary by the Respondent- Trustee without right or the :Claimant's wish, b) administered by the Respondent- Trustee without right or the Claimant's wish, c) detained without right or the Claimant's wish, and d) by the covenant-agreements with procurator the Claimant-beneficiary's :rights to remedy is secured in the law of the covenants.

39. :i- man -Procurator as the Respondent is :in -honor to :in-certainty admit and declare that the Respondent is :in-Dishonor, and in :these- immediate -Covenant-Agreements administer- oversight then must be maintained by :The United States of America- Army -man- actors, et al.- military :in -accordance to The Constitution for the United States of America, et seq.- the :Emancipation Proclamation-1863-A.D. with the General-Orders-100- 1863-A.D. in the protection of the Claimant is appropriate, necessary, and requested for the relative-coincidence that the man-beneficiary-victim is the :Negro, -:civilian, protected under the known- ;Arkansan-ancestry - forever.

40. :i- man -Procurator as the Respondent is :in -honor to :in-certainty admit and declare that the :PE and Lots -One, Two, Three and Four -:Covenant-agreement -matters are without controversy in the 'out of court judgment'.

42. :i- man -Procurator as the Respondent is :in -honor to :in-certainty admit and declare that the :obligation to Restore :all -property :in-specie is agreed-upon in the covenant-agreement(s), e.g.- :Lot One, Three and Four of the Covenant-agreements.

43. :i- man -Procurator as the Respondent is :in -honor to stipulate-to and agree-upon the restoration of :all- the- Claimant's property-claimed and possessed upon the order of this court of record.

44. :i- man -Procurator as the Respondent is :in -honor to :in-certainty admit and declare that: The United States of America- Army -man- actors, et al.- military must :In-accordance with the **Covenant-agreements and Law'** administrate :in -oversight to the Respondent- POTUS-Corp- man- actors -:in-office, et al.- :in-Dishonor, unto eternity for to assure and ensure the man-Claimant-remedies :in-accordance with the :PE and Lot -:Covenant-agreements~:One, Two, Three, Four~ is now immediately administrated upon the order of this court of record.

45. :i- man -Procurator as the Respondent is :in -honor to :in-certainty admit and declare that: The United States of America- Army -man- actors, et al.- military must :in -accordance with the **Covenant-Agreements -Law** must serve :in the administrator-oversight upon the POTUS- man-actors, etc. -:in-Dishonor, and against all enemies to :The United States of America unto eternity for to assure and ensure the restoration of :all-property-claimed, etc., :in-accordance with the :PE and Lot -:Covenant-agreements~:One, Two, Three, Four~ is now immediately administrated upon

1 :Covenant-agreements and Law means: *ICCPR-1992-A.D. of the **U.S.-Corp Constitution; ***Lieber Code-1863-A.D., ****Emancipation-Proclamation-1863-A.D. of *****TheCftUSofA-1787-89-A.D.- et al.- Bill of Rights, and *****Declaration of Independence-1776-A.D., *****KJV-Bible, et al.-Torah, prophets and the writings, et seq.- *****Yushuah~'Jesus'~ the Messiah, et al.- *****Concession-1213-A.D. unto :i- man- beneficiary, -:tangible and intangible -rights without competition.

*ICCPR-1992-A.D means: International Covenant of Civil and Political Rights, ratified by the U.S.- Corp -Senate: April 1992 A.D.

** U.S.-Corp Constitution means: the UNITED STATES CONSTITUTION - 1933 A.D.

*** Lieber Code-1863-A.D; General-Orders 100. of 1863 A.D.

****Emancipation-Proclamation-1863-A.D. means: EP-1863-A.D.

*****TheCftUSofA-1787-89-A.D.- et al.- Bill of Rights means: 'The Constitution for the United States of America' people, and also including the Bill of Rights -limitations.

*****Declaration of Independence-1776-A.D. means: DOI-1776-A.D.

*****KJV-Bible, et al.-Torah means: the fundamental rights in the moral law of Nature by Nature's God.

*****Yushuah~'Jesus'~ the Messiah, et al. means: He, the Son of the Most High God and Father, who died for man-kinds sin, resurrected and now sits at the right-side of Our Father in Heaven.

*****Concession-1213-A.D. means: The Concession by King John III of the Kingdoms of Ireland and England into the Trust of :Yushuah, the Messiah, Peter, Paul, and the Holy-church in 1213 A.D.



the order of this court of record.

46. I, man -Procurator as the Respondent is in -honor to in-certainty admit and declare that: The United States of America- Army -man- actors, et al.- military in -accordance with the **Republic- Founding- Covenant-Agreements -Laws, et seq.**, must serve in the administrator- oversight due to the POTUS-Corp, etc. - man- actors -in-Dishonor, against all said enemies to :The United States of America- people unto eternity, and for to assure and ensure the restoration of :all-property- claimed and ensure prompt now-payment of the deprivation-penalties, etc. in- accordance with the :PE and Lot -:Covenant-agreements~:One, Two, Three, Four~ is now immediately administrated upon the order of this court of record.

47. I, man -Procurator as the Respondent is in -honor to in-certainty admit and declare that :all of the property- claimed and possessed, :tangible and in-tangible, deprived by the Respondent-Trustee will be now immediate restored to the Claimant- Beneficiary post haste upon the order of this court of record.

48. I, man -Procurator as the Respondent is in -honor to in-certainty admit and declare that: the Respondent, et al. must :immediately-pay the deprivation-penalty to the day of the last month-preceding to 5:00 p.m. as stipulated-to and agreed-upon the order from this court of record.

I, man say here under penalty of perjury, and will verify same in the open-court, that :all herein be true and correct to the best of :i- man's knowledge;

Without prejudice

:Darrell- James: Hill, :Procurator as the Respondent

Affirmed and autographed before me this 14 day, January 2021 A.D.
Type of Identification: Ohio Drivers License.

Notary-Public



**:In :Hill – Court of :Record
At: Maricopa County Superior Court**

:Darrell-James: Hill,
:Claimant- beneficiary

:matter # RE 322 398 389 US

:Donald-John: Trump,
:Respondent- :Trustee, et al. -
Under-:Procuration

:ORDERS

PE and Lot -One- Covenant-agreement

:darrell-james: hill, -:man -:procurator

:Where, as the Out of Court-Judgment between the parties is :in- accordance with the
Covenant-agreements between the parties, stipulated-to, agreed-upon, and executed
:in- Non-Controversy for the right of the remedy solely for the Claimant under the Law of
the Covenant-Agreements PE-Covenant-agreement and Lot -One -Covenant-
agreement, et al., as expressed in the averments, stipulations and proposed- Orders
presented onto this Court of Record;

The :court-of-record ORDERS, that:

- 1) the :Respondent-Trustee must now post-haste pay the 'deprivation-
penalty' to the Claimant-beneficiary for the Lot -One -:Covenant-
Agreement with the :First-Offense of the Political- Election- Covenant-
Agreement as stipulated-to and agreed with onto this Court of Record;
dates: October 25, 2016 at 11:02 am unto :December 31, 2020 at: 5:00
pm;
- 2) the :Respondent-Trustee must now post-haste restore :all of the Lot One
-:Covenant-Agreement -:property-claimed and possessed to the absolute
-private- use and possession to the Claimant-Beneficiary :in-accordance
with the Lot -One -Covenant-agreement as stipulated-to and agreed-with
onto this Court of Record;
- 3) the :Respondent-Trustee must pay monthly the deprivation-penalty
-obligation as stipulated-to and agreed-with and continue same until such
time as :all -property-is restored to the Claimant- beneficiary :in-
accordance with the Lot -One -Covenant-agreement: starting December
31, 2020 A.D. at 5:00 pm until ending on the last day of the month :January
31, 2021 on 5:00 pm.
- 4) FURTHER, because of diffuse Dishonor as admitted and stipulated-to by
the Respondent, Administrator-Oversight is warranted:

The :court-of-record ORDERS, that:

:The United States of America -Army, et al. -military must administrate :in-
oversight-compliance upon the :POTUS-Corp.-Trustee, et al.- present -man-actors -:in-
office, et seq.- man-actors, for to:

- a) assure the :full-restoration of :all property to the Claimant now-to-forever; and,
- b) to assure and ensure fidelity to these orders that the Lot -One -Covenant-
agreement -Claimant-beneficiary's :property(s) are guaranteed under the
covenant-agreements here-to-fore and now-to-after.

Date

:Magistrate: Court of Record

Date

:Clerk: Court of Record

**:In :Hill – Court of :Record
At: Maricopa County Superior Court**

:Darrell-James: Hill,
:Claimant- beneficiary

:matter # RE 322 398 389 US

:Donald-John: Trump,
:Respondent- :Trustee, et al. -
Under-:Procurator

:ORDERS

PE and Lot -Two- Covenant-agreement

:darrell-james: hill, -:man -:procurator

:Where, as the Out of Court-Judgment between the parties is :in- accordance with the Covenant-agreements between the parties, stipulated-to, agreed-upon, and executed :in- Non-Controversy for the right of the remedy solely for the Claimant under the Law of the Covenant-Agreements PE-Covenant-agreement and Lot- Two-Covenant-agreement, et al., as expressed in the averments, stipulations and proposed- Orders presented onto this Court of Record;

The :court-of-record ORDERS, that:

- 1) the :Respondent-Trustee must now post-haste pay the 'deprivation-penalty' to the Claimant-beneficiary for the Lot -Two -:Covenant-Agreement with the :First-Offense of the Political- Election- Covenant-Agreement as stipulated-to and agreed with onto this Court of Record; dates: January 4th, 2017 at 11:11 a.m. unto :December 31, 2020 at: 5:00 pm;
- 2) the :Respondent-Trustee must now post-haste restore :all of the Lot -Two -:Covenant-Agreement -:property-claimed and possessed to the absolute -private- use and possession to the Claimant-Beneficiary :in-accordance with the Lot -Two -Covenant-agreement as stipulated-to and agreed-with onto this Court of Record;
- 3) the :Respondent-Trustee must pay monthly the deprivation-penalty -obligation as stipulated-to and agreed-with and continue same until such time as :all -property is restored to the Claimant- beneficiary :in- accordance with the Lot -Two -Covenant-agreement: starting December 31, 2020 A.D. at 5:00 pm until ending on the last day of the month :January 31, 2021 on 5:00 pm.
- 4) FURTHER, because of diffuse Dishonor as admitted and stipulated-to by the Respondent, Administrator-Oversight is warranted:

The :court-of-record ORDERS, that:

:The United States of America -Army, et al. -military must administrate :in- oversight-compliance upon the :POTUS-Corp.-Trustee, et al.- present -man-actors -:in-office, et seq.- man-actors, for to:

- a) assure the :full-restoration of :all property to the Claimant now-to-forever; and,
- b) to assure and ensure fidelity to these orders that the Lot -Two -Covenant-agreement -Claimant-beneficiary's :property(s) are guaranteed under the covenant-agreements here-to-fore and now-to-after.

Date

:Magistrate: Court of Record

Date

:Clerk: Court of Record



**:In :Hill – Court of :Record
At: Maricopa County Superior Court**

:Darrell-James: Hill,
:Claimant- beneficiary

:Donald-John: Trump,
:Respondent- :Trustee, et al. -
Under-:Procurator

:darrell-james: hill, -:man -:procurator

:matter # RE 322 398 389 US

:ORDERS

PE and Lot -Three- Covenant-agreement

:Where, as the Out of Court-Judgment between the parties is :in- accordance with the Covenant-agreements between the parties, stipulated-to, agreed-upon, and executed :in- Non-Controversy for the right of the remedy solely for the Claimant under the Law of the Covenant-Agreements PE-Covenant-agreement and Lot -Three -Covenant-agreement, et al., as expressed in the averments, stipulations and proposed- Orders presented onto this Court of Record;

The :court-of-record **ORDERS**, that:

- 1) the :Respondent-Trustee must now post-haste pay the 'deprivation-penalty' to the Claimant-beneficiary for the Lot -Three -:Covenant-Agreement with the :First-Offense of the Political- Election- Covenant-Agreement as stipulated-to and agreed with onto this Court of Record; dates: March 20th, 2017, 9:43 a.m. unto :December 31, 2020 at: 5:00 pm;
- 2) the :Respondent-Trustee must now post-haste restore :all of the Lot Three -:Covenant-Agreement -:property-claimed and possessed to the absolute -private- use and possession to the Claimant-Beneficiary :in-accordance with the Lot-Three -Covenant-agreement as stipulated-to and agreed-with onto this Court of Record;
- 3) the :Respondent-Trustee must pay monthly the deprivation-penalty -obligation as stipulated-to and agreed-with and continue same until such time as :all -property is restored to the Claimant- beneficiary :in-accordance with the Lot -Three -Covenant-agreement: starting December 31, 2020 A.D. at 5:00 pm until ending on the last day of the month :January 31, 2021 on 5:00 pm.
- 4) FURTHER, because of diffuse Dishonor as admitted and stipulated-to by the Respondent, Administrator-Oversight is warranted:

The :court-of-record **ORDERS**, that:

- :The United States of America -Army, et al. -military must administrate :in-oversight-compliance upon the :POTUS-Corp.-Trustee, et al.- present -man-actors -:in-office, et seq.- man-actors, for to:
- a) assure the :full-restoration of :all property to the Claimant now-to-forever; and,
 - b) to assure and ensure fidelity to these orders that the Lot -Three -Covenant-agreement -Claimant-beneficiary's :property(s) are guaranteed under the covenant-agreements here-to-fore and now-to-after.

Date :Magistrate: Court of Record

Date :Clerk: Court of Record



:In :Hill – Court of :Record
At: Maricopa County Superior Court

:Darrell-James: Hill,
:Claimant- beneficiary

:Donald-John: Trump,
:Respondent- :Trustee, et al. -
Under-:Procurator

:darrell-james: hill, -:man -:procurator

:matter # RE 322 398 389 US

:ORDERS

PE and Lot -Four- Covenant-agreement

:Where, as the Out of Court-Judgment between the parties is :in- accordance with the Covenant-agreements between the parties, stipulated-to, agreed-upon, and executed :in- Non-Controversy for the right of the remedy solely for the Claimant under the Law of the Covenant-Agreements PE-Covenant-agreement and Lot -Four -Covenant-agreement, et al., as expressed in the averments, stipulations and proposed- Orders presented onto this Court of Record;

The :court-of-record **ORDERS**, that:

- 1) the :Respondent-Trustee must now post-haste pay the 'deprivation-penalty' to the Claimant-beneficiary for the Lot -Four -:Covenant-Agreement with the :First-Offense of the Political- Election- Covenant-Agreement as stipulated-to and agreed with onto this Court of Record; dates: September 15th, 2016 at 11:11 am unto :December 31, 2020 at: 5:00 pm;
- 2) the :Respondent-Trustee must now post-haste restore :all of the Lot Four -:Covenant-Agreement -:property-claimed and possessed to the absolute -private- use and possession to the Claimant-Beneficiary :in-accordance with the Lot -Four -Covenant-agreement as stipulated-to and agreed-with onto this Court of Record;
- 3) the :Respondent-Trustee must pay monthly the deprivation-penalty -obligation as stipulated-to and agreed-with and continue same until such time as :all -property is restored to the Claimant- beneficiary :in- accordance with the Lot -Four -Covenant-agreement: starting December 31, 2020 A.D. at 5:00 pm until ending on the last day of the month :January 31, 2021 on 5:00 pm.
- 4) FURTHER, because of diffuse Dishonor as admitted and stipulated-to by the Respondent, Administrator-Oversight is warranted:

The :court-of-record **ORDERS**, that:

:The United States of America -Army, et al. -military must administrate :in- oversight-compliance upon the :POTUS-Corp.-Trustee, et al.- present -man-actors -:in-office, et seq.- man-actors, for to:

- a) assure the :full-restoration of :all property to the Claimant now-to-forever; and,
- b) to assure and ensure fidelity to these orders that the Lot -Four -Covenant-agreement -Claimant-beneficiary's :property(s) are guaranteed under the covenant-agreements here-to-fore and now-to-after.

Date

:Magistrate: Court of Record

Date

:Clerk: Court of Record

POSTAL SERVICE

APACHE JUNCTION
151 W SUPERSTITION BLVD
APACHE JUNCTION, AZ 85120-9998
(800)275-8777

2022-011769 MISC Page: 1831 of 2782
09/26/2022 03:35:37 PM Receipt #: 22-9381
Rec Fee: \$30.00 Darrell James Hill
Gila County, Az, Sadie Jo Bingham, Recorder



Product	Qty	Unit Price	Price
First-Class Mail® Large Envelope	1		\$2.20
Phoenix, AZ 85003 Weight: 0 lb 6.10 oz Estimated Delivery Date: Tue 01/19/2021			
Certified Mail® Tracking #:			\$3.55
7012221000042697384			
Total			\$5.75
First-Class Mail® Large Envelope	1		\$2.20
Washington, DC 20500 Weight: 0 lb 6.10 oz Estimated Delivery Date: Wed 01/20/2021			
Certified Mail® Tracking #:			\$3.55
70081830000210282082			
Total			\$5.75
First-Class Mail® Large Envelope	1		\$2.20
Washington, DC 20318 Weight: 0 lb 6.10 oz Estimated Delivery Date: Wed 01/20/2021			
Certified Mail® Tracking #:			\$3.55
70092820000388516100			
Total			\$5.75
First-Class Mail® Large Envelope	1		\$2.20
Florence, AZ 85132 Weight: 0 lb 6.10 oz Estimated Delivery Date: Tue 01/19/2021			
Certified Mail® Tracking #:			\$3.55
70101060000175189154			
Total			\$5.75
Grand Total:			\$23.00
Cash Charge			-\$2.00

U.S. Postal Service
CERTIFIED MAIL RECEIPT
(Domestic Mail Only; No Insurance Coverage Provided)

For delivery information, visit our website at www.usps.com

OFFICIAL USE

Postage	\$3.55		
Certified Fee	\$0.00		
Return Receipt Fee (Endorsement Required)	\$0.00		
Restricted Delivery Fee (Endorsement Required)	\$0.00		
Total Postage & Fees	\$3.55		

Sent To: Donald Johns
Street, Apt. No. or PO Box No.: 1400 Pennsylvania Ave NW
City, State, ZIP+4: Washington, Dist of Columbia 20502

Postmark: **JAN 15 2021**

U.S. Postal Service
CERTIFIED MAIL RECEIPT
(Domestic Mail Only; No Insurance Coverage Provided)

For delivery information, visit our website at www.usps.com

OFFICIAL USE

Postage	\$3.55		
Certified Fee	\$0.00		
Return Receipt Fee (Endorsement Required)	\$0.00		
Restricted Delivery Fee (Endorsement Required)	\$0.00		
Total Postage & Fees	\$3.55		

Sent To: Paul Penzone
Street, Apt. No. or PO Box No.: 650 West Sahara
City, State, ZIP+4: Phoenix, Arizona 85003

Postmark: **JAN 15 2021**

U.S. Postal Service
CERTIFIED MAIL RECEIPT
(Domestic Mail Only; No Insurance Coverage Provided)

For delivery information, visit our website at www.usps.com

OFFICIAL USE

Postage	\$3.55		
Certified Fee	\$0.00		
Return Receipt Fee (Endorsement Required)	\$0.00		
Restricted Delivery Fee (Endorsement Required)	\$0.00		
Total Postage & Fees	\$3.55		

Sent To: Mack Lamb
Street, Apt. No. or PO Box No.: PO Box 867
City, State, ZIP+4: Florence, Arizona 85132

Postmark: **JAN 15 2021**

U.S. Postal Service
CERTIFIED MAIL RECEIPT
(Domestic Mail Only; No Insurance Coverage Provided)

For delivery information, visit our website at www.usps.com

OFFICIAL USE

Postage	\$3.55		
Certified Fee	\$0.00		
Return Receipt Fee (Endorsement Required)	\$0.00		
Restricted Delivery Fee (Endorsement Required)	\$0.00		
Total Postage & Fees	\$3.55		

Sent To: James Charles
Street, Apt. No. or PO Box No.: 9999 Joint Staff Pentagon
City, State, ZIP+4: Washington, Dist of Columbia 20308

Postmark: **JAN 15 2021**

Darrell-James: Hill, -civilian, -:Executor
PO Box 3806
Apache Junction, Arizona 85117

:man :present

Arizona state
Maricopa county

**:In :Hill – Court of :Record
At: Maricopa County Superior Court**

:Darrell-James: Hill,
:Claimant- beneficiary

:notice:
:see claim: :matter # RE 322 398 389 US

:Donald-John: Trump,
:Respondent- :Trustee, et al.- :man-actor
-Trustees: Barack-Hussein: Obama;
Loretta: Lynch, Jefferson-Beauregard:
Sessions III, Matthew-George: Whitaker,
Dana-James: Boente, Sally-Caroline: Yates,
William-Pelham: Barr; Steve-Truner: Mnuchin;
Brian: Karth, Ranier-Christercunean: Collins;
John and Jane Does;

See- appended:
claim – executed;
declaration: right of claim, with:
declaration: averments: claimant;
See- appended: Respondent:
declaration: stipulations; procurator as
respondent;
Notice of receipt of claim; formal
summons waved

Under-:Procurator For Respondent
:darrell-james: hill, -:man -:Procurator

(verified)

:i- man will stand-present as the Executor!

:Law Over-standing The Matter

This Court-of-Record must be administered by the services of the Trial-by-Jury² for to decide the matter of the facts and the law status of the out-of-court- judgment, :in- non-controversy, by procurator, :in- accordance with the law of the covenant-agreements~ See: Nature of Claim: Trespass:~ stipulated-to and agree-upon by the man- Claimant and the man- Respondent, et al.- U.S.-Corp. Government-services-provider, -:Trustee: Emergency Banking Act of 1933, et seq.

:Duties during the Proceeding

The man- Magistrate's is invited in this court-of-record is to witness for the proceedings :in the trial-by-jury, autograph-accept the jury's order(s) and ensure the proper recording of the order(s) with the clerk.

The man -Security personnel- assigned's duty is to be tipstaff.

RESPONDENT-NOTIFICATION is completed with the service to the procurator. Notice to the Procurator is as notice the :Respondent -:in -principal, -:Donald-John: Trump, et al.- man-actor(s).

:i- man say here under penalty of perjury, and will verify same in the open-court, that :all herein be true and correct to the best of :i- man's knowledge;

Sincerely,

Darrell-James Hill
:Darrell-James: Hill, -:Executor- beneficiary

Sworn and Autographed before me this 14 day January 2021 A.D.
Type of Identification: Arizona Driver License

L. S. B. 59
Notary-Pubic

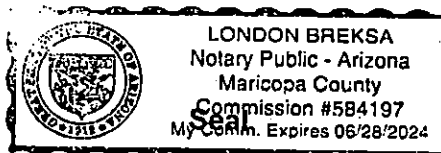

January 14, 2021 :notice: see claim – :matter # RE 322 398 389 US



1 :Constructive Notice Of The Setting Of Presumptions

Notice to Agent is Notice to Principal; Notice to Principal is Notice to Agent: **Applicable to all Successors and Assigns** – i- man :Darrell-James: Hill, -Executor -beneficiary set these -known- presumptions; That:

1) Re: presumption of the public record, this- private- business- matter is to be recorded in the public -environment and on the public -record and by the public -record number placed on the page -one of the matter; and:

2) Re: presumption of the public service, that any public- person engaged in this private- matter is deemed to be in the public- service as a :public-servant; and:

3) Re: presumption of the public oath, that, every :public-servant acting on the behalf of this matter is required to state :all- public and private -sworn -oaths superseding the :public -servant's -sworn -oath(s); and:

4) Re: presumption of the immunity, that, any-person acting on the behalf of/as the agent for :any- nameless, faceless -predilection or corporation is :wholly-personally-liable for :their- actions on the behalf of that interest upon the Notice- of-Injury with the financial- penalty; and:

5) Re: presumption of the summons, that, for the now, past and future -occasions, the :customary- presumption of the jurisdiction, position, and existence of the guilt is :forbidden; and:

6) Re: presumption of the custody, that, :man-kind is as i- man am, -alive and well: not the :thing to be held in the custody by the custodian or guardian; not :property of the Roman-Court or Roman-Empire; and, :under-no-circumstances may i- man be detained in any way: now, past or future; and:

7) Re: presumption of the court of the guardians, that: i :man :Darrell-James: Hill am: general guardian and executor of the matters of the trust; and:

8) Re: presumption of the court of the trustees, that, for the reason of as a visitor with the invitation to meet and to clear-up the :matter, the :offices of the trustee and the :roles of the public -servant and government -employees are rejected: absolutely -no -jurisdiction may be claimed; and:

9) Re: presumption of the government acting in :two roles as the executor and beneficiary, that, i- man am the general executor, general guardian, and beneficiary and executor in -all -matters-at-hand pertaining to the legal -person, -subrogation: DARRELL JAMES HILL, et seq.-derivatives-there-to, as well as to the flesh and blood, -living -soul-journer i- man -Darrell-James: Hill, -civilian, -Executor- beneficiary; and:

10) Re: presumption of the agent and agency, that, under-no-circumstance may the :judge or magistrate assume the :executor-role; and:

11) Re: presumption of the incompetence, that, i- man know the :position of the executor and beneficiary; and rebuke and object to :any-contrary-presumption. – No- privilege 'of the deeming i- man incompetent' is permitted; and:

12) Re: presumption of the guilt, that, under -no- circumstance may i- man be: a) :presumed -guilty, or b) detained; nor- may c) :any- financial- transactions occur in the favor of the court.

2 :This :court-of-record must be by the Trial-by-Jury means: the judgment must be by the power of the sovereign-assembly- oversight.

1824
January 14, 2021 :notice: see claim –

2022-011769 MISC Page: 1833 of 2782
09/26/2022 03:35:37 PM Receipt #: 22-9381
Rec Fee: \$30.00 Darrell James Hill
Gila County, Az, Sadie Jo Bingham, Recorder



Darrell-James: Hill, -civilian, -:Executor
PO Box 3806
Apache Junction, Arizona 85117

RECEIVED

21 JAN 19 PM 12:10

:man :present, -:

COURT ADMINISTRATION
SOUTHEAST FACILITY

Arizona state
Maricopa county

:In :Hill – Court of :Record
At: Maricopa County Superior Court

:Darrell-James: Hill,
:Claimant- beneficiary

:claim – executed:

:matter # RE 322 398 389 US

:Donald-John: Trump,
:Respondent- :Trustee, et al.- :man-actor
-Trustees: Barack-Hussein: Obama;
Loretta: Lynch, Jefferson-Beauregard:
Sessions III, Matthew-George: Whitaker,
Dana-James: Boente, Sally-Caroline: Yates,
William-Pelham: Barr; Steve-Truner: Mnuchin;
Brian: Karth, Ranier-Christercunean: Collins;
John and Jane Does; Under-:Procurator.

:Executor- Waiver of :Recordation and
Court-of-Record Fees

(verified)

under-:procurator for respondent
:darrell-james: hill, -:man -:procurator

:i- man- Executor- Trustee waive the recordation and Court-of-Record fees in this
matter for :execution of the right in suit at common law where the matter in controversy
exceeded twenty dollars.

:i- man say here under penalty of perjury, and will verify same in the open-court, that :all herein
be true and correct to the best of :i- man's knowledge;

January 19th 2021 day :Darrell-James: Hill
:Darrell-James: Hill, -: Executor

January 2021 :CLAIM-:matter # RE 322 398 389 US 1 / 1



Darrell-James: Hill, -civilian, -:Executor
PO Box 3806
Apache Junction, Arizona 85117

:man :present, -:Claimant

Arizona state
Maricopa county

**:In :Hill – Court of :Record
At: Maricopa County Superior Court**

:Darrell-James: Hill,
:Claimant- beneficiary

:Donald-John: Trump,
:Respondent- :Trustee, et al.- :man-actor
-Trustees: Barack-Hussein: Obama;
Loretta: Lynch, Jefferson-Beauregard:
Sessions III, Matthew-George: Whitaker,
Dana-James: Boente, Sally-Caroline: Yates,
William-Pelham: Barr; Steve-Truner: Mnuchin;
Brian: Karth, Ranier-Christercunean: Collins;
John and Jane Does; Under-:Procurator.

:claim – executed:

:matter # RE 322 398 389 US

common-theft,
with penalty-agreement,
with :respondent :in- dishonor

(verified)

under-:procurator for respondent
:darrell-james: hill, -:man -:procurator

- 1) :i- man- :Claimant is :Darrell-James: Hill, -:civilian, -:beneficiary, -:Ohioan, one of the 'United States of America' -people; -:Executor establish :this -court of -record for to move :claim before jury-members to decide the matters of fact and law :in the 'out-of-court- judgment' understanding the Covenant-agreements.
- 2) The :man- :Respondent is :Donald-John: Trump, et al.- man-actor-:Trustees for the U.S.- government for: a) the United States of America -people- beneficiary, and: b) as the U.S.- Corp.-Trustee: Emergency Banking Act, 1933 - 2003 A.D. for the 'United States of America' -:people- beneficiary;
- 3) :i- man- Claimant wholly-own the :express and specific- property-claimed and possessed referred-to in the 'Declaration: Right of Claim, appended;
- 4) The :man- Respondent, et al., lawfully received Claimant's property-claimed and possessed, and none else: a) :man- Respondent, et al., administrates i-man's property without right or :i- man's wish, b) :man- Respondent, et al., possesses :i- man's property without right or :i- man's wish, c) :man- Respondent detains :i- man's property without right or :i- man's wish;
- 5) :i- man -:Claimant wishes the restoration of :all -property :in accordance with the Covenant-Agreements - stipulated-to and agreed-upon onto this Court-of-Record.

:i- man say here under penalty of perjury, and will verify same in the open-court, that :all herein be true and correct to the best of :i- man's knowledge;

Jan. 14, 2021 :Darrell-James Hill, Claimant
:Darrell-James: Hill, -:Claimant- beneficiary

Darrell-James: Hill, -civilian, -Executor
PO Box 3806
Apache Junction, Arizona 85117

5 :man :present,

10 Arizona state
Maricopa county

:In :Hill – Court of :Record
At: Maricopa County Superior Court

15

:Darrell-James: Hill,
:Claimant- beneficiary

:Donald-John: Trump,
:Respondent- :Trustee, et al.,
Under-:Procurator

:Darrell-James: Hill, -:man -:Procurator

:declaration: right of claim
:in :out of court- judgment'- matter
:in the non-controversy
:under- procurator- expressed
:in- accordance with :covenant- as
:stipulated-to and agreed-upon

See :declaration: averments: claimant

See: stipulations: procurator as
respondent.

(verified)

Joined-Matter :in -Non-Controversy in: Procurator
By :Covenant- Agreement To Effect the :Remedy for the Claimant

20

CLAIM-OF-RIGHT: JOINED BY THE RESPONDENT BY PROCURATION

:i- man -:Darrell-James: Hill ~hereinafter 'Claimant'~ is :Ohioan, one of the people and
inhabitant of :Arizona state, and in this court of record claims with the man -:Donald-John:
Trump' ~hereinafter 'Respondent'~ in this non-controversy-matter -:in -procurator unto and
until the remedy is completed solely for the Claimant :in accordance with the Covenant-
25 Agreements by the 'out-of-court- judgment'. See: a) :declaration: averments: claimant, and b)
stipulations: procurator as respondent.

25

COURT-OF-RECORD WITH TRIAL-BY-JURY

For the right of the remedy for the Claimant, :this :court-of-record with the Trial-by-Jury³ is
30 with the duty to address the matters concerning the national-government service-provider:
Trustee of the Emergency Banking Act of 1933 A.D., et seq.:

30

to decide-upon the :facts and the law of the Covenant-agreement⁴-matters by the lawful-
oversight by the sovereign-people-jural-assembly;

to accept the "out of court"- judgment :in- obligation now: and,

35

to: a) halt and cease the :Respondent- damage(s) presently endured by the Claimant;

b) obtain the full-remedy to the Claimant :in accordance with the Covenant-
agreements; and,

c) do :all of :same :in- honor.⁵

40

:FOUNDING -:COVENANT -AGREEMENTS:

The Covenant Agreements between the Claimant and Respondent by procurator are
founded :in and upon the law- guarantees derived from the people that established the republic-
founding- covenants :in -law for the United States of America- people⁶.

CLAIMANT-RESPONDENT -:COVENANT-AGREEMENTS:

45

- 1) specifies the claim(s)-of-right to the property-claimed due to the Claimant;
- 2) identifies the payment-agreement for the withholding/stealing of the property;
- 3) Identifies the non-controversy by :procurator for the Respondent by the man -:darrell-james:
Hill, procurator-minister as the Respondent.

50

THE :POLITICAL-ELECTION, 'PE", -COVENANT- AGREEMENT' '

The 'Affidavit of Superior Constructive Notice and Demand: Permanent Non-Commercial
Presumption'; and: AFFIDAVIT: Constructive Notice of 'DARRELL JAMES HILL' of 'Darrell-
James: of the family Hill' Authorized Representative, 'Political-Election-covenant- agreement',

January 14, 2021 :declaration; right of claim – :matter # RE 322 398 389 US 1 / 3



55 'PE', is the express, signed, sealed and specially -delivered-covenant executed and executory
for to affirm that the property for :all- inherent and fundamental rights, tangible and intangible,
private real and chattel property-claimed and possessed, is restored to the man- covenantor-
Claimant -:darrell-james: hill, to:
a) :in -non-controversy by :procuration assure and ensure the absolute-remedy for :Claimant
60 :in -accordance with the covenant-agreements: PE-covenant- agreement, et seq.-
offense- levels with the particular breach of the covenant -agreements;
b) to release the :property-claimed and possessed according to the covenant-agreement;
c) to pay the penalty for the offenses in the deprivation of the private-property :in
-accordance with the covenant-agreements;
65 d) to assure the :restoration of :property-claimed and possessed :in -accordance
with the covenant-agreements :in -honor.

**:RESPONDENT- BREACH OF THE PE-COVENANT- AGREEMENT- LOTS 1, 2, 3 AND 4
'LOT-ONE'- COVENANT-AGREEMENT'** :Respondent Breach Of :COVENANT- Agreement:

70 The: 'NOTICE: CLAIM, RE: Property disposed to the United States of America in the "UNITED
STATES ATTORNEY'S OFFICE; OFFICIAL NOTIFICATION POSTED ON OCTOBER 12, 2016',
'Lot-One'- Covenant-agreement' is the express, signed, sealed and specially -delivered-covenant
executed for the restoration of the private property- claimed and possessed under the condition
stipulated-to and agreed-upon for the deprivation of :private-property-penalty- obligation :in the
Covenant-Agreements at :one- U.S.- dollar -silver -:in- specie per :minute :in-accordance with
75 the Lot-One- Covenant-Agreement, subject to the First-Offense -level of the PE- Covenant-
agreement.

'LOT-TWO'- COVENANT-AGREEMENT' :Respondent Breach Of :COVENANT- Agreement:
The: 'i: man: Darrell-James: Hill; prosecutor, Claimant'; Claimant Case No: CMN 7009 1410

80 0000 7868 5703', 'Lot-Two'- Covenant-agreement', is the express, signed, sealed and specially
-delivered-covenant executed for the restoration of the right in the Court-of-Record in the matter
of the stolen/deprived property-claimed and possessed in the 'Lot-One-covenant- agreement'
under the conditions stipulated-to and agree-upon for the restoration of the property- claimed
and possessed under the covenant-agreement-obligations at :one- U.S.- dollar -silver -:in-
85 specie per :minute :in-accordance with the Lot-Two- Covenant-Agreement per :minute, subject to
the Second-Offense -level of the PE- covenant-agreement.

'LOT-THREE'- COVENANT-AGREEMENT' :Respondent Breach Of :COVENANT- Agreement:
The: 'NOTICE: CLAIM, RE: Property disposed to the United States of America in the 'UNITED

90 STATES ATTORNEY'S OFFICE; OFFICIAL NOTIFICATION POSTED ON FEBRUARY 13,
2017', 'Lot-Three'- Covenant-agreement' is the express, signed, sealed and specially -delivered-
covenant executed present for the restoration of the private property- claimed and possessed
under the condition stipulated-to and agreed-upon for the deprivation of :private-property-
penalty- obligation :in the Covenant-Agreements at :one- U.S.- dollar -silver -:in- specie per
95 :minute :in-accordance with the Lot-Three- Covenant-Agreement, subject to the Third-Offense
-level of the PE- Covenant-agreement.

'LOT-FOUR'- COVENANT-AGREEMENT' :Respondent Breach Of :COVENANT- Agreement:
The: 'CLAIM: NOTICE AND DEMAND/ RE: Property disposed to the United States of America

100 reported in the 'UNITED STATES ATTORNEY'S OFFICE; OFFICIAL NOTIFICATION POSTED
ON AUGUST/30, 2017', 'Lot-Four'- Covenant-agreement' is the express, signed, sealed and
specially -delivered-covenant executed present for the restoration of the private property-
claimed and possessed under the condition stipulated-to and agreed-upon for the deprivation
of :private-property-penalty- obligation :in the Covenant-Agreements at :one- U.S.- dollar -silver
105 -:in- specie per :minute :in-accordance with the Lot-Four- Covenant-Agreement, subject to the
Third-Offense -level of the PE- Covenant-agreement.

110 :i- man say here under penalty of perjury, and will verify same in the open-court, that :all herein
be true and correct to the best of :i- man's knowledge;

Jan 14, 2021 - Darrell James Hill, Claimant
:Darrell- James: Hill, -:man -:Claimant

- 1 :Respondent -:in -principal, -:Donald-John: Trump, et al., et seq. means: Barack-Hussein, Loretta: Lynch, Common-law-Trustee, 'CLT', -:U.S. government, et seq.
- 2 :CLAIM-OF-RIGHT: JOINED BY THE RESPONDENT means: See: DECLARATION: RESPONDENT.
- 3 :This :court-of-record must be by the Trial-by-Jury means: the judgment must be by the power of the sovereign-assembly- oversight.
- 4 :must be by the Trial-by-Jury to decide upon the facts and the law of the Covenant-agreements means: must be completed under the authority of the sovereign-powers.
- 5 :In- honor means: not in discretion unto dishonor. See: Notary-Pubic Dishonor -DOCUMENT, August 7th, 2018; See: Public-record document: Gila-county-Recorder, Arizona-state: Doc # 2018-9291 pp. 825-832.
- 6 :republic- founding- covenants :in- law for the United States of America- people means: Declaration of Independence of 1776 A.D. for :man; Articles of Confederation of 1777 A.D. for states; The Constitution for the United States of America of 1787-1789, et al.- including: the Bill of Rights, et seq.- Emancipation Proclamation Of 1863 A.D., Lieber Code of 1863 A.D. for :government; and, thereto: Emergency Banking Act of 1933 A.D., et al., and, also including the treaty: International Covenant on Civil and Political Rights of 1966 A.D.- ratified by the U.S.-Corp. Senate -:1992 A.D. for government-services.
- 7 :PE -COVENANT- AGREEMENT' means: September 07, 2016, et seq. See: Public-record document: Gila-county-Recorder, Arizona-state: Doc # 2017-002378, pp.1-239, et al.
- 8 :LOT -ONE means: USPO RMN: RE 322 399 279 US; October 25th, 2017: 11:02 a.m.: See: Public-record document: Gila-county-Recorder, Arizona-state: Doc # 2017-002378, pp.240 -584, et al.
- 9 :LOT -TWO means: January 4th 2017; 5:00 p.m.- contract-agreement. CMN 7009 1410 0000 7868 5703. See: Public-record document: Gila-county-Recorder, Arizona-state: Doc # 2017-002378, pp. 618- , et al. See: "Affidavit: Proof of Claim"- Public-record document: Gila-county-Recorder, Arizona-state: Doc # 2017- 006522, pp. 1- 54.
- 10 :LOT -THREE means: : USPO RMN: RE 322 399 251 US; March 20, 2017: 9:43 a.m.: See: Public-record document: Gila-county-Recorder, Arizona-state: Doc # 2019-009291, pp.1 - 333, et al.
- 11 :LOT -FOUR means: : USPO RMN: RE 322 399 248 US; September 15th, 2017: 11:11 a.m.: See: Public-record document: Gila-county-Recorder, Arizona-state: Doc # 2019-009291, pp.375 - 737, et al.

Unofficial

January 14, 2021 :declaration: right of claim :matter # RE 322 398 389 US 3 / 3



Darrell-James: Hill, -civilian, -:Executor
PO Box 3806
Apache Junction, Arizona 85117

:man :present,

Arizona state
Maricopa county

**:In :Hill – Court of :Record
At: Maricopa County Superior Court**

:Darrell-James: Hill,
:Claimant- beneficiary

:declaration: averments: claimant
:matter # RE 322 398 389 US

:Donald-John: Trump,
:Respondent- :Trustee, et al.- :man-actor
-Trustees

Under-:Procurator For Respondent
:darrell-james: hill, -:man -:Procurator

(verified)

1. Regarding the :PE, Lots -:One, Two, Three and Four-Covenant-agreements, the man-Respondent-Trustee has administered the property of :i- man without right or :i- man's wish, possessed :i- man's property without right or :i- man's wish, and is detaining :i- man's property without right or :i- man's wish.

2. :i- man see no verifiable evidence that Declaration of Independence- 1776 A.D., 'DOI-1776-A.D.', enables the :violation of :i- man's unalienable rights, and :i- man believe no evidence to the contrary exists.

3. :i- man see no verifiable evidence that the DOI-1776-A.D., et seq., did not create to option and obligation for the United-States-of-America -people, e.g.- :i- man, to chose their political-election(s) and relationship to their government(s), and :i- man believe no evidence to the the contrary exists.

4. :i- man see no verifiable evidence that the United-States of America¹- slavery, et al. damage, et seq., upon :i- man's heritage, et seq., did not deprive :i- man's :unalienable -rights under the DOI-1776-A.D., and :i- man believe no evidence to the contrary exists.

5. :i- man see no verifiable evidence that the Declaration of Independence- 1776 A.D. is rescinded, and :i- man believe no evidence to the contrary exists.

6. :i- man see no verifiable evidence that the The Constitution for the United States of America-1787- 1789 A.D., et al.- Bill of Rights, et seq.- Amendments for the people of the United States of America is rescinded, and :i- man believe no evidence to the contrary exists.

7. :i- man see no verifiable evidence that the DOI-1776-A.D. covenant-agreement between the United States of America-people and the Almighty-God permits the enslavement and/or unlawful economic-confinement of the Negro-Ysrael, -House of Judah -:United States of America-people', and :i- man believe no evidence to the contrary exists.

8. :i- man see no verifiable evidence that the DOI-1776-A.D. covenant-agreement between the United States of America-people and the Almighty-God permits the enslavement and unlawful confinement of the Negro-Ysrael, -'House of Judah' :in violation of :KJV-Book: Leviticus -Chap. 25², and :i- man believe no evidence to the contrary exists.

1 : United-States of America means: the people over-standing the government under the The Constitution for the United States of America-1787- 1789 A.D., et al.- Bill of Rights, et seq.- Amendments.

2 :KJV- Book- Leviticus- Chap.: 25 means: Lev 25:38 I am the LORD your God, which brought you forth out of the land of Egypt, to give you the land of Canaan, and to be your God.
25:39 And if thy brother that dwelleth by thee be waxen poor, and be sold unto thee; thou shalt



9. :i- man see no verifiable evidence that the Articles of Confederation- 1777 A.D. has authority to violate the Declaration of Independence- 1776 A.D., and :i- man believe no evidence to the contrary exists
- 10 :i- man see no verifiable evidence that under The Constitution for the United States of America-1787- 1789, the Executive Order for the Emancipation Proclamation- 1863 A.D. enables for the :any-deprivation of :i- mans' unalienable rights, and :i- man believe no evidence to the contrary exists.
11. :i- man see no verifiable evidence that the Emancipation Proclamation- 1863 A.D. with the Lieber Code- 1863 A.D. enables for the deprivation of :i- mans' unalienable rights, and :i- man believe no evidence to the contrary exists.
12. :i- man see no verifiable evidence that the UNITED STATES-CORP', 'U.S.-Corp', is not the government services provider understanding :The Constitution for the United States of America -1787- 1789 A.D., et seq.- Emancipation Proclamation -1863 A.D. and the Lieber Code-1863-A.D., and :i- man believe no evidence to the contrary exists.
13. :i- man see no verifiable evidence that the U.S.-Corp. -man-actors -:in- office have authority to violate the Lieber-Code- 1863 A.D., and :i- man believe no evidence to the contrary exists.
14. :i- man see no verifiable evidence that the U.S.-Corp. -man-actors :in-office have authority to violate the Emancipation-Proclamation- 1863 A.D., and :i- man believe no evidence to the contrary exists.
15. :i- man see no verifiable evidence that the U.S.-Corp. -man-actors :in-office have authority to violate The Constitution for the United States of America- 1787- 1789, et seq., and :i- man believe no evidence to the contrary exists.
16. :i- man see no verifiable evidence that :U.S.-Corp. -man-actors -:in- office-of-trustee have authority to deprive :i- man of the Declaration of Independence- 1776 A.D. rights, and :i- man believe no evidence to the contrary exists.
17. :i- man see no verifiable evidence that the U.S.-Corp. -man-actors have right to ignore or otherwise deny the :chosed of the political-election by :i- man, and :i- man believe no evidence to the contrary exists.
18. :i- man see no verifiable evidence that the U.S.-Corp.- man-actors have right to impair its :Covenant-Agreement -obligations for to assure and ensure :i- man's right for the remedy by :procuration for the property stolen in this 'out of court- judgment' -matter, and :i- man believe no evidence to the contrary exists.
19. :i- man see no verifiable evidence that the U.S.-Corp.- man-actors have right to deprive :i- man of life, liberty, or property, without due process of law, and :i- man believe no evidence to the contrary exists.
20. :i- man see no verifiable evidence that the U.S. -Corp.- man-actors have right to deprive :i- man of private-property for the public use, without just compensation, and :i- man believe no evidence to the contrary exists.
21. :i- man see no verifiable evidence that the U.S. -Corp.- man-actors have right to deprive or otherwise deny :i- man- Darrell-James: Hill, the guaranteed right of :suit at :common-law, where the value in the matter has exceeded twenty dollars, and :i- man believe no evidence to the contrary exists.

not compel him to serve as a bondservant Lev 25:40 *But as an hired servant, and as a sojourner, he shall be with thee, and shall serve thee unto the year of jubile:*
 25:41 *And then shall he depart from thee, both he and his children with him, and shall return unto his own family, and unto the possession of his fathers shall he return.*
 25:42 *For they are my servants, which I brought forth out of the land of Egypt: they shall not be sold as bondmen.*
 25:43 *Thou shalt not rule over him with rigour; but shalt fear thy God.*

1 : 'UNITED STATES-CORP' means: 1) the :government-services- provider-1933-A.D., and :self-indentured- Trustee of the :Legislative -Dry-Trust: Emergency Banking Act of 1933 A.D.



22. :i- man see no verifiable evidence that the U.S. -Corp.-man-actors have right to :i- man's sovereign- rights -Not -delegated in The Constitution for the United States of America- 1787-91, et al., and :i- man believe no evidence to the contrary exists

23. :i- man see no verifiable evidence that the U.S. -Corp.- man-actors have right to the sovereign-powers -Not -delegated by :i- man in The Constitution for the United States of America- 1787- 1789, and :i- man believe no evidence to the contrary exists.

24. :i- man see no verifiable evidence that the U.S. -Corp.-man-actors have right to violate the: right of :i- man to be secure in :i-man's persons, houses, papers, and effects, against unreasonable searches and seizures, and :i- man believe no evidence to the contrary exists.

25. :i- man see no verifiable evidence that the U.S. -government- man-actors may engage in insurrection or rebellion against The United States of America, 1787- 1789 A.D., or give aid or comfort to the enemy, and :i- man believe no evidence to the contrary exists.

26. :i- man see no verifiable evidence that the Word of God: KJV: Holy-Bible: Torah, prophets and writings permits the :enslavement of the Negro-Ysrael -House of Judah in the Seventeenth Century- A.D. :in-violation of :KJV-Book: Leviticus -Chap. 25', and :i- man believe

1 :KJV- Book- Leviticus- Chap.: 25 means: Lev 25:38 I am the LORD your God, which brought you forth out of the land of Egypt, to give you the land of Canaan, and to be your God.
25:39 And if thy brother *that dwelleth* by thee be waxen poor, and be sold unto thee; thou shalt not compel him to serve as a bondservant:
25:40 *But* as an hired servant, and as a sojourner, he shall be with thee, and shall serve thee unto the year of jubile:
25:41 And *then* shall he depart from thee, *both* he and his children with him, and shall return unto his own family, and unto the possession of his fathers shall he return.
25:42 For they *are* my servants, which I brought forth out of the land of Egypt: they shall not be sold as bondmen.
25:43 Thou shalt not rule over him with rigour; but shalt fear thy God.

Deuteronomy 15:1 At the end of every seven years thou shalt make a release.

15:2 And this *is* the manner of the release: Every creditor that lendeth *ought* unto his neighbour shall release *it*; he shall not exact *it* of his neighbour, or of his brother; because it is called the LORD'S release.

15:3 Of a foreigner thou mayest exact *it again*: but *that* which is thine with thy brother thine hand shall release;

15:4 Save when there shall be no poor among you; for the LORD shall greatly bless thee in the land which the LORD thy God giveth thee *for* an inheritance to possess it:

15:5 Only if thou carefully hearken unto the voice of the LORD thy God, to observe to do all these commandments which I command thee this day.

15:6 For the LORD thy God blesseth thee, as he promised thee: and thou shalt lend unto many nations, but thou shalt not borrow; and thou shalt reign over many nations, but they shall not reign over thee.

15:7 If there be among you a poor man of one of thy brethren within any of thy gates in thy land which the LORD thy God giveth thee, thou shalt not harden thine heart, nor shut thine hand from thy poor brother:

15:8 But thou shalt open thine hand wide unto him, and shalt surely lend him sufficient for his need, *in that* which he wanteth.

15:9 Beware that there be not a thought in thy wicked heart, saying, The seventh year, the year of release, is at hand; and thine eye be evil against thy poor brother, and thou givest him nought; and he cry unto the LORD against thee, and it be sin unto thee.

15:10 Thou shalt surely give him, and thine heart shall not be grieved when thou givest unto him: because that for this thing the LORD thy God shall bless thee in all thy works, and in all that thou puttest thine hand unto.

15:11 For the poor shall never cease out of the land: therefore I command thee, saying, Thou shalt open thine hand wide unto thy brother, to thy poor, and to thy needy, in thy land.

15:12 *And* if thy brother, an Hebrew man, or an Hebrew woman, be sold unto thee, and serve thee six years; then in the seventh year thou shalt let him go free from thee.

15:13 And when thou sendest him out free from thee, thou shalt not let him go away empty:

15:14 Thou shalt furnish him liberally out of thy flock, and out of thy floor, and out of thy winepress: *of that* wherewith the LORD thy God hath blessed thee thou shalt give unto him.

15:15 And thou shalt remember that thou wast a bondman in the land of Egypt, and the LORD thy God redeemed thee: therefore I command thee this thing to day.

15:16 And it shall be, if he say unto thee, I will not go away from thee; because he loveth thee and thine house, because he is well with thee;

15:17 Then thou shalt take an aul, and thrust *it* through his ear unto the door, and he shall be thy servant for ever. And also unto thy maidservant thou shalt do likewise.

no evidence to the contrary exists.

27. :i- man see no verifiable evidence that The United States of America, 1787- 1789 A.D. Article 1, Section 9 did not enable systemic- extenuating -harms- ongoing upon the unalienable- rights of the House of Judah, sons of Ysrael¹, and :i- man believe no evidence to the contrary exists

28. :i- man see no verifiable evidence that the U.S.-Corp's :any -deprivation and/or theft of :i- man's -property is not :wrong-doing and continuing-harm upon the life and liberty of :i- man, and :i- man believe no evidence to the contrary exists.

29. :i- man see no verifiable evidence that the U.S. -Corp.- man-actors must not guarantee the :republican²-form of :government to :i- man now, and :i- man believe no evidence to the contrary exists.

30. :i- man see no verifiable evidence that the U.S. -Corp.- man-actors, et al. -;all executive and judicial Officers must not by Oath or Affirmation bind themselves to :absolute-support and defend of :The Constitution for the United States of America -1787- 1789 A.D., and :i- man believe no evidence to the contrary exists.

31. :i- man see no verifiable evidence that the 'United States of America', 'USofA', does not denote 'the :people' of the United States of America³, and :i- man believe no evidence to the contrary exists.

32. :i- man see no verifiable evidence that the :man- :Respondent-Trustee's seizing the :Claimant-beneficiary's -:private- property without warrant is not unlawful, and :i- man believe no evidence to the contrary exists.

33. :i- man see no verifiable evidence that the man- :Respondent-Trustee agrees to bring no writ or error, or to file a bill of equity, so as to delay or that could delay the :remedy to the man- Claimant- beneficiary, and :i- man believe no evidence to the contrary exists.

34. :i- man- Claimant accept the oaths of the trustee and the officers-of-trustee to their fidelity :in the commitment, and none else.

35. :i- man see no verifiable evidence that the ICCPR-1992-A.D did not obligate for the United-States-of-America -people, e.g. - :i- man, to execute their fundamental-rights, :natural, :common and inherent-rights as the :man-Claimant-beneficiary exercised and executed :in the Covenant-Agreements - :PE, :Lots One, Two, Three; and Four; and, :i- man believe no evidence to the contrary exists.

36. :i- man see no verifiable evidence that the International Covenant of Civil and Political Rights, 'ICCPR-1992-A.D.', enables for the deprivation of :i- mans' unalienable right-executed of the DOI-1776-A.D., et seq., and :i- man believe no evidence to the contrary exists.

37. The Right to chose the political-election for :i- man is executed with the express, sealed and specially-delivered -:PE-Covenant-agreement.

38. :i- man see no verifiable evidence that 'voidance-of-benefit'⁴ by the Respondent is not acting within the :silent- acquiescenc⁵e with the express- procuration⁶ -agreement for to enable the execution of the right for the remedy for the Claimant, and :i- man believe no evidence to the

15:18 It shall not seem hard unto thee, when thou sendest him away free from thee; for he hath been worth a double hired servant to thee, in serving thee six years: and the LORD thy God shall bless thee in all that thou doest.

1 : sons of Ysrael means: aka sons of 'Israel': sons of Jacob, Isaac and Abraham, of : Shem, Noah,... of: Methuselah, of Enoch,... of Seth, of the line of Adam and Eve of the garden of Eden.

2 :republican means: based :in the laws of the people, the government open to :all of the people.

3 'The Declaration of Independence: 'Action of Second Continental Congress.. of the thirteen united States of America.' Same determination Held by by the Supreme Court of the United States.

4 :voidance-of-benefit means: the methodology of ignoring the beneficiary's several requests for the :any :benefit until the beneficiary either dies or for any reason abandons the beneficiary-claim.

5 :silent- acquiescence means: quiet agreement to the contract-agreement proposed.

6 :express- procuration means: the written and/or stated derived giving lawful authority to act as would the principal would act for himself.

:DECLARATION: CLAIMANT

4 / 7



contrary exists.

39. :i- man see no verifiable evidence that the :Trustee-Respondent- obligor does not admit to covenant-agreements with the property-claimed and possessed with the deprivation-penalties with the :procurator for the remedy by the man-Claimant-beneficiary, and :i- man believe no evidence to the contrary exists.

40. :i-man see no verifiable reason why the procurator must-not seek to eliminate the ongoing-harms upon man-Claimant, Darrell-James: Hill, et al.- family.

41. :i- man see no verifiable evidence that :all of the man -Claimant-beneficiary- covenant-documents :in the pursuit of the 'stolen' -property-claimed and possessed are not the :material -facts in :i- man's execution of the fundamental-right-laws available to the United-States-of-America -people, and :i- man believe no evidence to the contrary exists.

42. :i- man see no verifiable evidence that since **October 25th, 2016, 11:02 a.m.**, the :**Lot -One -:**Covenant-agreement is not the 'First Offense' by the 'Political-Election-Covenant-Agreement' as the result of the deprivation of the private- property- claimed and possessed with the harm thereby to the man- Claimant :in- accordance with the :Lot-One -:Covenant-agreement, :in violation of: a) The Declaration of Independence- 1776 A.D.¹ 'unalienable-rights... life, liberty and the pursuit of Happiness'; b) The Constitution for the United States of America, 1787 A.D., Art. I, Section 10.²: 'No State shall ... pass any ... Law impairing the Obligation of Contracts', with c) the Bill of Rights, 1791 A.D.: Amendment V³: 'No person shall be ... deprived of life, liberty, or property, without due process of law; nor shall private property be taken for public use without just compensation.', and :i- man believe no evidence to the contrary exists.

43. :i- man see no verifiable evidence that Since **January 4th, 2017, 5:00 p.m.**, the :**Lot -Two -:**Covenant-agreement is not the 'Second Offense' by the 'Political-Election-Covenant-Agreement' as the result of the deprivation of the private- property- claimed and possessed with the harm thereby to the man- Claimant :in- accordance with the :Lot-Two -:Covenant-agreement, :in violation of: a) The Declaration of Independence- 1776 A.D. 'unalienable-rights... life, liberty and the pursuit of Happiness'; b) The Constitution for the United States of America, 1787 A.D., Art. I, Section 10.: 'No State shall ... pass any ... Law impairing the Obligation of Contracts', with c) the Bill of Rights, 1791 A.D.: Amendment V: 'No person shall be ... deprived of life, liberty, or property, without due process of law; nor shall private property be taken for public use without just compensation.', and :i- man believe no evidence to the contrary exists.

44. :i- man see no verifiable evidence that Since **March 20th, 2017, 9:43 a.m.**, the :**Lot-Three -:**Covenant-agreement is not the 'Third Offense' by the 'Political-Election-Covenant-Agreement' as the result of the deprivation of the private- property- claimed and possessed with the harm thereby to the man- Claimant :in- accordance with the :Lot-Three -:Covenant-agreement, :in violation of: a) The Declaration of Independence- 1776 A.D. 'unalienable-rights... life, liberty and the pursuit of Happiness'; b) The Constitution for the United States of America, 1787 A.D., Art. I, Section 10.: 'No State shall ... pass any ... Law impairing the Obligation of Contracts', with c) the Bill of Rights, 1791 A.D.: Amendment V: 'No person shall be ... deprived of life, liberty, or property, without due process of law; nor shall private property be taken for public use without just compensation.', and :i- man believe no evidence to the contrary exists.

45. :i- man see no verifiable evidence that Since **September 15th, 2017, 11:11 a.m.** the :**Lot-Four -:**Covenant-agreement is not the 'Third Offense' by the 'Political-Election-Covenant-Agreement' as the result of the deprivation of the private- property- claimed and possessed with the harm thereby to the man- Claimant :in- accordance with the :Lot-Four -:Covenant-agreement, :in violation of: a) The Declaration of Independence- 1776 A.D. 'unalienable-rights... life, liberty and the pursuit of Happiness'; b) The Constitution for the United States of America, 1787 A.D., Art. I, Section 10.: 'No State shall ... pass any ... Law impairing the Obligation of Contracts', with c) the Bill of Rights, 1791 A.D.: Amendment V: 'No person shall be ... deprived of life, liberty, or property, without due process of law; nor shall private property be taken for public use without just compensation.', and :i- man believe no evidence to the contrary exists.

- 1 :The Declaration of Independence- 1776 A.D. means: the un-obstructable, 'unalienable-rights... to life, liberty and the pursuit of Happiness'
- 2 :The Constitution for the United States of America, 1787 A.D., Art. I, Section 10. means: 'No State shall ... pass any ... Law impairing the Obligation of Contracts'
- 3 :Bill of Rights, 1789 A.D.: Amendment V means: 'No person shall be ... deprived of life, liberty, or property, without due process of law; nor shall private property be taken for public use without just compensation.'

:DECLARATION: CLAIMANT

5 / 7



46. The fact of the simple theft(s) by the man-Respondent-Trustee is Not in controversy under the Covenant-agreements within the deprivation-penalty covenant-agreement for the withholding and/or administrating without-right the private property-claimed and possessed by the Claimant-beneficiary
47. I see no verifiable evidence that the man- Claimant-beneficiary did not in the complete fullness execute the right to claim fundamental rights to the property-claimed and possessed that was deprived from the Claimant-beneficiary by the Respondent-Trustee in the PE, Lots One, Two, Three and Four-Covenant-agreements, and I believe no evidence to the contrary exists.
48. I see no verifiable evidence that the Property-claimed and possessed by the Claimant was not lawfully received by the man-Respondent-Trustee, et al. - Donald John Trump, et al.- man- actors, and none else; and I believe no evidence to the contrary exists.
49. I see no verifiable evidence that the Respondent-Trustee must not now-absolutely report to the man- Claimant-beneficiary the account for all of the PE, Lots One, Two, Three and Four-Covenant-agreements property-claimed and possessed by the man-Claimant that is stolen/withholden by the Respondent-Trustee, and I believe no evidence to the contrary exists.
50. I see no verifiable evidence that the 'Out of Court- judgment' is not established in the Dishonor by the Respondent-Trustee within the processes of the Arizona-state-official in the Notary-Pubic Protest unto the Notary-Public Dishonor, and I believe no evidence to the contrary exists.
51. I see no verifiable evidence that the 'out of court' -judgment by the Arizona State Official regarding PE, Lots One, Two, Three and Four-Covenant-agreements are not established by the Arizona-state -Notary -Protest unto the Notary-Public Dishonor in this matter with the PE -Covenant- Agreement and the Lots One, Two, Three and Four-Covenant-agreements, and I believe no evidence to the contrary exists.
52. I see no verifiable evidence that the all- property, of the PE, Lots One, Two, Three and Four-Covenant-agreements are not properly- claimed and possessed by the Claimant- beneficiary, and I believe no evidence to the contrary exists.
53. I see no verifiable evidence that the non-controversy in the matter by procuration by the man-Claimant-beneficiary for the right of the remedy is not in accordance with the deprivation-penalty in the PE, Lots One, Two, Three and Four-Covenant-agreements within the Political-Election -Covenant- Agreement: 'First-Offense', and I believe no evidence to the contrary exists.
54. I see no verifiable evidence that the Respondent-Trustee has not converted the deprived/stolen PE, Lots One, Two, Three and Four-Covenant-agreements-property, et al.- tangible and in-tangible property, and I believe no evidence to the contrary exists.
55. I see no verifiable evidence that the harms and damages presently endured by the man -Claimant-beneficiary are not the result of the ongoing- same daily and cumulative losses, and require immediate remedy post-haste, and I believe no evidence to the contrary exists.
56. I see no verifiable evidence that the Lots One, Two, Three and Four-Covenant-agreements deprivation-penalty payment(s) is not in accordance with the Political-Election-covenant, -Offense-levels in-accordance to the Covenant- agreements, and I believe no evidence to the contrary exists.
57. I see no verifiable evidence that the Jury-members are not required to refer the man-Respondent-Trustee's larceny to the grand-jury of this state, and I believe no evidence to the contrary exists.
58. I see no verifiable evidence that the immediate Covenant-Agreement- oversight by man-actor's of The United States of America- Army, et al.- military is not in accordance with the man-Claimant's proper expectation to the Emancipation Proclamation-1863-A.D. and with the Lieber-Code-1863-A.D. -protection, and I believe no evidence to the contrary exists.



59. I- man see no verifiable evidence that the USofA- Army -man- actors, et al.- military must not serve to administer-oversight to the POTUS- man-actors- in-office due to the Respondent- Trustee's -Larceny and Dishonor, so to assure and ensure the property-Claimed and possessed is restored to the man-Claimant upon the order of the court-of-record, and I- man believe no evidence to the contrary exists.

60. I- man see no verifiable evidence that the all of the property, e.g.- tangible and intangible of the Lot-One Covenant-Agreement -property, is not properly- claimed and possessed and only is by wrong-doing deprived from the Claimant-beneficiary by the Respondent-Trustee without right, without authorization, without warrant nor receipt of the necessity from the Respondent- Trustee, and I- man believe no evidence to the contrary exists.

61. I- man see no verifiable evidence that the Property-claimed and possessed in the PE, Lots -One, Two, Three and Four-Covenant-agreements are wholly-personally -not -owned by the man-beneficiary- Darrell-James: Hill, -beneficiary, -civilian., and I- man believe no evidence to the contrary exists.

I- man say here under penalty of perjury, and will verify same in the open-court, that all herein be true and correct to the best of I- man's knowledge;

Jan-14, 2021  Darrell James Hill, Claimant
Darrell- James: Hill, :Executor: Claimant

Unofficial

1836
1836



Darrell-James: Hill, -civilian
PO Box 3806
Apache Junction, Arizona 85117

:man :present,:procurator

Arizona state
Maricopa county

:In :Hill – Court of :Record
At: Maricopa County Superior Court

:Darrell-James: Hill,
:Claimant- beneficiary

:Donald-John: Trump,
:Respondent- :Trustee, et al.- :man-actor
-Trustees, et seq.

in: Procuration¹,
:man- Procurator: darrell-james: hill

:matter # RE 322 398 389 US

:declaration-
:stipulations: procurator as
:respondent

(VERIFIED)

: Respondent-Trustee Joined-Matter :in -Non-Controversy in: Procuration
By :Covenant- Agreement To Effect the :Remedy for the Claimant-Beneficiary

CLAIM-OF-RIGHT: JOINED BY THE RESPONDENT

1. :i- man -:darrell-james: hill ~also know as :man-Claimant- Darrell-James: Hill~ is :Ohioan, one of the people and inhabitant of :Arizona state, and in this court of record also serves as the procurator as the man -:Donald-John: Trump². -Respondent would in these matters. :in- honor. :in- non-controversy-matter, and -:in accordance with the Covenant-Agreements by the 'out-of-court- judgment' unto and until the remedy is completed solely for the benefit of the Claimant.

2. :i- man -Procurator as the Respondent is :in -honor to :in-certainty admit and declare that the covenant-agreement- "out-of-court" -judgments abides under the Law of the Covenants.

3. :i- man -Procurator as the :Respondent-Trustee- man -:Donald-Trump, et al., act :in -honor for to assure and ensure the right of the remedy -obligations for the Claimant-beneficiary within the confines of the law of the covenant-agreements.

4. :i- man -Procurator as the Respondent is :in -honor to stipulate-to and agree-upon the Claimant-averments. See: :CLAIM # RE 322 398 389 US.

5. :i- man -Procurator as the :Respondent-Trustee- man -:Donald-Trump, et al., act :in -honor for to assure and ensure the right of remedy for the Claimant-beneficiary from the Respondent within the confines of the law of the PE covenant-agreement(s), hereafter, included by reference.

6. :i- man -Procurator as the Respondent is :in -honor in these matters-agreed is :in- trust for to assure and ensure the right to the remedy to the Claimant :in-accordance with the Covenant-agreements.

7. RESPONDENT-NOTIFICATION of the matter to :i- man-procurator is completed on the 14th day January, 2021, by third-party service. Notice of same will be made by the USPO- delivery to and :general -public -notice of :delivery for the :Respondent -in -principal, -:Donald-John: Trump, et al.

1 :Procuration means: when one person gives power to another to act in his place as he could do for himself.

2 :Respondent -:In -principal, -:Donald-John: Trump, et al., et seq. means: Barack-Hussein, Loretta: Lynch, Common-law-Trustee, 'CLT', -:U.S. government, et seq.

January 14, 2021 :STIPULATIONS: PROCURATOR :matter # RE 322 398 389 US 1 /6



8. :i- man -Procurator as the Respondent is :in -honor to affirm that Procuration in these matters-agreed is :in- trust for to assure and ensure the right to the remedy to the Claimant :in- accordance with the Covenant-agreements, to answer the rights-exercised, and :in- non- controversy to report same to the Respondent, et al.

9. :i- man -Procurator as the Respondent is :in -honor to stipulate-to and agree-upon to affirm that Procuration in these matters is :in- trust to the man-procurator- :darrell-james: hill as relates to the Respondent's- present- standing :in- Notarial-Public- Dishonor concerning these Covenant-agreement- matters.

10. :i- man -Procurator as the :Respondent-Trustee- man -:Donald-John: Trump, et al., agree with the rule of preclusion here-to-fore and now-to-after to must-not-bring :writ of error, or file a bill of equity so as could cause :any-delay in the immediate-remedy against the admitted-damages- endured to now and ongoing now-after, but to now-to-fore cease :all -wrong-doing and damages :in-effect upon the man- Claimant- beneficiary- forever, and :none-else harms.

11. :i- man -Procurator as the Respondent is :in -honor to agree that: The Covenant Agreements between the Claimant and Respondent/procuration are founded in the fundamental- rights- law- guarantees derived from the people-sovereigns that establish the republic- founding- covenants :in -all- Law for the United States of America- people'.

12. :i- man -Procurator as the Respondent is :in -honor to stipulate-to and agree-upon the Claim #RE 322 398 389 US by the man -Claimant.

13. :i- man -Procurator as the Respondent is :in -honor to agree with the PROCURATOR- RESPONDENT -:COVENANT-AGREEMENTS:

- a) that the claimants full- rights to the property-claimed is valid;
- b) that the deprivation-payment agreement for the withholding of the property-claimed is valid;
- c) that the non-controversy by :procuration by the man -:darrell-james: hill, -procurator, ministering as the Respondent is warranted :in-accordance with the covenant- agreements, and valid.

14. :i- man -Procurator as the Respondent is :in -honor to agree, that: The 'Affidavit of Superior Constructive Notice and Demand; Permanent Non-Commercial Presumption'; and: AFFIDAVIT: Constructive Notice of 'DARRELL JAMES HILL' of 'Darrell-James: of the family Hill' Authorized Representative, 'Political-Election-covenant- agreement', 'PE', is the express, signed, sealed and specially -delivered-covenant executed and executory for to affirm that the property for :all- inherent and fundamental rights, tangible and intangible, private real and chattel property-claimed and possessed, is restored to the man- covenantor- Claimant -:darrell-james: hill -beneficiary, to:

- a) :in -non-controversy by :procuration assure and ensure the absolute-remedy for :Claimant :in -accordance with the covenant-agreements: PE-covenant- agreement, et seq.- offense- levels with the particular breach of the covenant -agreements;
- b) to release the :property-claimed and possessed according to the covenant-agreement;
- c) to pay the penalty for the offenses in the deprivation of the private-property :in -accordance with the covenant-agreements;
- d) to assure the :restoration of :property-claimed and possessed :in -accordance with the covenant-agreements :in -honor.

15. :i- man -Procurator as the Respondent is :in -honor to agree, that: 'LOT-ONE'- COVENANT-AGREEMENT' :Respondent Breach Of :COVENANT- Agreement: The: 'NOTICE: CLAIM,RE: Property disposed to the United States of America in the "UNITED STATES ATTORNEY'S OFFICE: OFFICIAL NOTIFICATION POSTED ON OCTOBER 12, 2016', 'Lot-One'- Covenant-agreement' is the express, signed, sealed and specially -delivered-covenant executed for the restoration of the private property- claimed and possessed under the condition stipulated- to and agreed-upon for the deprivation of :private-property-penalty- obligation :in the Covenant- Agreements at :one- U.S.- dollar -silver -in- specie per :minute :in-accordance with the Lot-One- Covenant-Agreement, subject to the First-Offense -level of the PE- Covenant-agreement.

1 :republic- founding- covenants :in- law for the United States of America- people means: Declaration of Independence of 1776 A.D. for :man; Articles of Confederation of 1777 A.D. for states; The Constitution for the United States of America of 1787-1789, et al.- including: the Bill of Rights, et seq.- Emancipation Proclamation Of 1863 A.D., Lieber Code of 1863 A.D. for :government; and, thereto: Emergency Banking Act of 1933 A.D., et al., and, also including the treaty: International Covenant on Civil and Political Rights of 1966 A.D.- ratified by the U.S.-Corp. Senate -:1992 A.D. for government-services.

January 14, 2021 :STIPULATIONS: PROCURATOR :matter # RE 322 398 389 US 2 /6



16. :i- man -Procurator as the Respondent is :in -honor to agree, that: 'LOT-TWO'-COVENANT-AGREEMENT' :Respondent Breach Of :COVENANT- Agreement: The: 'i: man: Darrell-James: Hill: prosecutor, Claimant': Claimant Case No: CMN 7009 1410 0000 7868 5703', 'Lot-Two'- Covenant-agreement', is the express, signed, sealed and specially -delivered-covenant executed for the restoration of the right in the Court-of-Record in the matter of the stolen/deprived property-claimed and possessed in the 'Lot-One-covenant- agreement' under the conditions stipulated-to and agree-upon for the restoration of the property- claimed and possessed under the covenant-agreement-obligations at :one- U.S.- dollar -silver -in- specie per :minute :in-accordance with the Lot-Two- Covenant-Agreement, subject to the Second-Offense -level of the PE- covenant-agreement.

17. :i- man -Procurator as the Respondent is :in -honor to agree, that: 'LOT-THREE'-COVENANT-AGREEMENT' :Respondent Breach Of :COVENANT- Agreement: The: 'NOTICE: CLAIM, RE: Property disposed to the United States of America in the 'UNITED STATES ATTORNEY'S OFFICE: OFFICIAL NOTIFICATION POSTED ON FEBRUARY 13, 2017', 'Lot-Three'- Covenant-agreement' is the express, signed, sealed and specially -delivered-covenant-executed for the restoration of the private property -claimed and possessed under the conditions stipulated-to and agreed-upon for the deprivation of :private-property-penalty-obligation :in the Covenant-Agreements at :one- U.S.- dollar -silver -in- specie per :minute :in-accordance with the Lot-Three- Covenant-Agreement, subject to the Third-Offense -level of the PE- Covenant-agreement.

18. :i- man -Procurator as the Respondent is :in -honor to agree, that: 'LOT-FOUR'-COVENANT-AGREEMENT' :Respondent Breach Of :COVENANT- Agreement: The: 'CLAIM: NOTICE AND DEMAND, RE: Property disposed to the United States of America reported in the 'UNITED STATES ATTORNEY'S OFFICE: OFFICIAL NOTIFICATION POSTED ON AUGUST 30, 2017', 'Lot-Four'- Covenant-agreement' is the express, signed, sealed and specially -delivered-covenant executed for the restoration of the private property- claimed and possessed under the condition stipulated-to and agreed-upon for the deprivation of :private-property-penalty- obligation :in the Covenant-Agreements at :one- U.S.- dollar -silver -in- specie per :minute :in-accordance with the Lot-Four- Covenant-Agreement, subject to the Third-Offense -level of the PE- Covenant-agreement.

19. :i- man -Procurator as the Respondent is :in -honor to :in-certainty admit and declare that the any failings causing the here-to-fore daily harms upon the Claimant-beneficiary is by the 'voidance of benefit' -silently-imposed by the Respondent- trustee.

20. :i- man -Procurator as the Respondent is :in -honor to :in-certainty admit and declare that the 'voidance of benefit' imposition by the Respondent-Trustee upon the man- Claimant merely voids the :rights- executed by the man-Claimant- beneficiary.

21. :i- man -Procurator as the Respondent is :in -honor to :in-certainty admit and declare that the 'voidance of right' of :benefits' imposed the 'voidance of :unalienable-rights -doctrine' over the Law for the United States of America-people, or the Declaration of Independence, 1776 A.D., et seq. -:fundamental, natural and common-law -rights to life, liberty, property and the pursuit of happiness.

22. :i- man -Procurator as the Respondent is :in -honor to :in-certainty admit and declare that the voidance of rights-executed must necessarily did void several restrictions and safeguards that have been put in place to assure and ensure protection of the :same-rights voided by the Respondent; that, all of the harm required that the United States-Corp, et al., void :The Constitution for the United States of America, 1787-1789 A.D., et al.- Bill of Rights, et seq.- Emancipation Proclamation of 1863 A.D., Lieber-Code-1863 A.D.; and, the :International Covenant on Civil and Political Rights-, 'ICCPR', 1992 A.D., by operating in the 'voidance of benefits' upon/against the Claimant's :All-rights.

23. :i- man -Procurator as the Respondent is :in -honor to :in-certainty submit under the PE-covenant-agreement and to immediately restore :all- property :in-specie as agreed-upon in the PE and Lots -One, Two, Three and Four -Covenant-agreements.

24. :i- man -Procurator as the Respondent is :in -honor to :in-certainty admit and declare that the 'Bills of Particulars', 'BOP', for the deprivation of property :in the Lot- One, Two, Three and

1 :voidance of benefit means: the administrator -:in-oversight abandonment of benefit to the beneficiary.

January 14, 2021 :STIPULATIONS: PROCURATOR :matter # RE 322 398 389 US 3 /6

Four- Covenant-agreement is a) received by the Respondent-Trustee, et al.- man-actors, b) is the obligation in-accordance with the covenant-agreements, and c) no obligation has been met. received by the Respondent-Trustee, et al.- man-actors, b) is the obligation in-accordance with the covenant-agreements, and c) no obligation has been met.

25. :i- man -Procurator as the Respondent is :in -honor to :in-certainty admit and declare that the Respondent-facets against the Claimant's rights-executed are many: a) tacit-acquiescence with b) voidance of benefit,with c) the absolute-deprivation of :all private- property-claimed and possessed, and with d) necessitating-requiring the execution- :in- procuration by the evidence of the breach of :Trust :in -:Trustee-Dereliction.

26. :i- man -Procurator as the Respondent is :in -honor to :in-certainty admit and declare that the 'out of court -judgment' by the Arizona State Official regarding :Lots -One, Two, Three and Four -:Covenant-agreement is established by the Notary-Pubic -:Protest unto the Notary-Public -:Dishonor upon the Respondent, et al.

27. :i- man -Procurator as the Respondent is :in -honor to :in-certainty admit and declare that the voidance of benefits and transparent-process :in the denial of rights-executed are wrong-doings by the Respondent.

28. :i- man -Procurator as the Respondent is :in -honor to :in-certainty admit and declare that the wrong-doings to the man-Claimant daily causes harm to the Claimant and is damages-endured as the result of the deprivation against the Claimant's :rights-executed for: life, liberty and property in the pursuit of :happiness.

29. :i- man -Procurator as the Respondent is :in -honor to :in-certainty admit and declare that for the requirement of the restoration of :property-claimed and possessed by the man- Claimant is established with the :continuous -warrant by the covenant-agreements for the prompt-payment of the deprivation-penalty until the property-claimed and possessed is restored :in- specie to the Claimant-beneficiary :in-accordance with the PE and Lot -One, Two, Three and Four -:Covenant-agreements.

30. :i- man -Procurator as the Respondent is :in -honor to :in-certainty agree and declare that prompt-payment of the deprivation-penalty, if required, must be payment- made cumulative to the month-day-end-cycles, payed on the first day of the following month to the Claimant-beneficiary :in-accordance with the PE and Lots: One, Two, Three and Four -Covenant-agreements.

31. :i- man -Procurator as the Respondent is :in -honor to :in-certainty admit and declare that the PE and Lots -One, Two, Three and Four- Covenant-agreement are :in -non-controversy expressively for to assure and ensure the right of the remedy for the man-Claimant and :in -accordance with the PE -Covenant- Agreement: 'First-Offense'.

32. :i- man -Procurator as the Respondent is :in -honor to :in-certainty admit and declare that :all- property- claimed and possessed :in the PE and Lot -One, Two, Three and Four -Covenant-Agreement is properly- claimed and possessed by the man- Claimant- beneficiary.

33. :i- man -Procurator as the Respondent is :in -honor to :in-certainty admit and declare that: the :Respondent is obligated and required to restore of the property- claimed and possessed, with the payment of deprivation-penalties, and to assure and ensure the right of the remedy to the Claimant-beneficiary with procuration.

34. :i- man -Procurator as the Respondent is :in -honor to :in-certainty admit and declare that by the deprivation of the :Claimant's private-property- claimed and possessed does the Respondent-Trustee victimize-continually the and cause stress and :harm of Respondent-Trustee- :wrong-doing upon the :Claimant-beneficiary.

35. :i- man -Procurator as the Respondent is :in -honor to :in-certainty admit and declare that: the Claimant- beneficiary is :ICCPR -fully -compliant with the absolute-exercise of the fundamental-rights- executed :in the PE and Lots -One, Two, Three and Four -:Covenant-agreements.

36. :i- man -Procurator as the Respondent is :in -honor to :in-certainty admit and declare that: the Harms and Damages now endured by Claimant- beneficiary as the result of the extremely-large deprivations of :all of the Claimants property-claimed and possessed must require immediate remedy post-haste by the order of this court of record.



37. :i- man -Procurator as the Respondent is :in -honor to :in-certainty admit and declare that the :Trustee- Respondent -agreements are with :Claimant- procurator :in- accordance with the Covenant-Agreements :in :non-controversy here-to-fore and now-to-after.

38. :i- man -Procurator as the Respondent is :in -honor to :in-certainty admit and declare that :in this :Non -controversy- matter, that :all -elements of the private-property- claimed and possessed are: a) deprived from the Claimant-beneficiary by the Respondent- Trustee without right or the :Claimant's wish, b) administered by the Respondent- Trustee without right or the Claimant's wish, c) detained without right or the Claimant's wish, and d) by the covenant-agreements with procurator the Claimant-beneficiary's :rights to remedy is secured in the law of the covenants.

39. :i- man -Procurator as the Respondent is :in -honor to :in-certainty admit and declare that the Respondent is :in-Dishonor, and in :these- immediate -Covenant-Agreements administer-oversight then must be maintained by :The United States of America- Army -man- actors, et al.- military :in -accordance to The Constitution for the United States of America, et seq.- the :Emancipation Proclamation-1863-A.D. with the General-Orders-100- 1863-A.D. in the protection of the Claimant is appropriate, necessary, and requested for the relative-coincidence that the man-beneficiary-victim is the :Negro, -:civilian, protected under the known- ;Arkansan-ancestry - forever.

40. :i- man -Procurator as the Respondent is :in -honor to :in-certainty admit and declare that the :PE and Lots -One, Two, Three and Four - :Covenant-agreement -matters are without controversy in the 'out of court judgment'.

42. :i- man -Procurator as the Respondent is :in -honor to :in-certainty admit and declare that the :obligation to Restore :all -property :in-specie is agreed-upon in the covenant-agreement(s), e.g.- :Lot One, Three and Four of the Covenant-agreements.

43. :i- man -Procurator as the Respondent is :in -honor to stipulate-to and agree-upon the restoration of :all- the- Claimant's property-claimed and possessed upon the order of this court of record.

44. :i- man -Procurator as the Respondent is :in -honor to :in-certainty admit and declare that: The United States of America- Army -man- actors, et al.- military must :In-accordance with the Covenant-agreements and Law' administrate :in -oversight to the Respondent- POTUS-Corp- man- actors -:in-office, et al.- :in-Dishonor, unto eternity for to assure and ensure the man-Claimant-remedies :in-accordance with the :PE and Lot -:Covenant-agreements~:One, Two, Three, Four~ is now immediately administrated upon the order of this court of record.

45. :i- man -Procurator as the Respondent is :in -honor to :in-certainty admit and declare that: The United States of America- Army -man- actors, et al.- military must :in -accordance with the Covenant-Agreements -Law must serve :in the administrator-oversight upon the POTUS- man-actors, etc. -:in-Dishonor, and against all enemies to :The United States of America unto eternity for to assure and ensure the restoration of :all-property-claimed, etc., :in-accordance with the :PE and Lot -:Covenant-agreements~:One, Two, Three, Four~ is now immediately administrated upon

1 :Covenant-agreements and Law means: *ICCPR-1992-A.D. of the **U.S.-Corp Constitution; ***Lieber Code-1863-A.D., ****Emancipation-Proclamation-1863-A.D. of *****TheCftUSofA-1787-89-A.D.- et al.- Bill of Rights, and *****Declaration of Independence-1776-A.D., *****KJV-Bible, et al.-Torah, prophets and the writings, et seq.- *****Yushuah~Jesus~ the Messiah, et al.- *****Concession-1213-A.D. unto :i- man- beneficiary, -:tangible and intangible -rights without competition.

*ICCPR-1992-A.D means: International Covenant of Civil and Political Rights, ratified by the U.S.- Corp -Senate: April 1992 A.D.

** U.S.-Corp Constitution means: the UNITED STATES CONSTITUTION - 1933 A.D.

*** Lieber Code-1863-A.D; General-Orders 100. of 1863 A.D.

****Emancipation-Proclamation-1863-A.D. means: EP-1863-A.D.

*****TheCftUSofA-1787-89-A.D.- et al.- Bill of Rights means: 'The Constitution for the United States of America'- people, and also including the Bill of Rights -limitations.

*****Declaration of Independence-1776-A.D. means: DOI-1776-A.D.

*****KJV-Bible, et al.-Torah means: the fundamental rights in the moral law of Nature by Nature's God.

*****Yushuah~Jesus~ the Messiah, et al. means: He, the Son of the Most High God and Father, who died for man-kinds sin, resurrected and now sits at the right-side of Our Father in Heaven.

*****Concession-1213-A.D. means: The Concession by King John III of the Kingdoms of Ireland and England into the Trust of :Yushuah, the Messiah, Peter, Paul, and the Holy-church in 1213 A.D.

January 14, 2021 :STIPULATIONS: PROCURATOR :matter # RE 322 398 389 US 5 /6



the order of this court of record.

46. :i- man -Procurator as the Respondent is :in -honor to :in-certainty admit and declare that: The United States of America- Army -man- actors, et al.- military :in -accordance with the Republic- Founding- Covenant-Agreements -Laws, et seq., must serve :in the administrator-oversight due to the POTUS-Corp, etc. - man- actors -:in-Dishonor, against all said enemies to :The United States of America- people unto eternity, and for to assure and ensure the restoration of :all-property- claimed and ensure prompt now-payment of the deprivation-penalties, etc. :in-accordance with the :PE and Lot -:Covenant-agreements~:One, Two, Three, Four~ is now immediately administrated upon the order of this court of record.

47. :i- man -Procurator as the Respondent is :in -honor to :in-certainty admit and declare that :all of the property- claimed and possessed, :tangible and in-tangible, deprived by the Respondent-Trustee will be now immediate restored to the Claimant- Beneficiary post haste upon the order of this court of record.

48. :i- man -Procurator as the Respondent is :in -honor to :in-certainty admit and declare that: the Respondent, et al. must :immediately-pay the deprivation- penalty to the day of the last month-preceding to 5:00 p.m. as stipulated-to and agreed-upon the order from this court of record.

:i- man say here under penalty of perjury, and will verify same in the open-court, that :all herein be true and correct to the best of :i- man's knowledge;

Without prejudice

Darrell James Hill, Procurator
:Darrell- James: Hill, :Procurator as the Respondent

Affirmed and autographed before me this 14 day, January 2021 A.D.
Type of Identification: Ohio Drivers License.

London Breksa
Notary-Public



Unofficial
1842



**:In :Hill – Court of :Record
At: Maricopa County Superior Court**

**:Darrell-James: Hill,
:Claimant- beneficiary**

:matter # RE 322 398 389 US

**:Donald-John: Trump,
:Respondent- :Trustee, et al. -
Under-:Procurator**

:ORDERS

PE and Lot -One- Covenant-agreement

:darrell-james: hill, -:man -:procurator

**:Where, as the Out of Court-Judgment between the parties is :in- accordance with the
Covenant-agreements between the parties, stipulated-to, agreed-upon, and executed
:in- Non-Controversy for the right of the remedy solely for the Claimant under the Law of
the Covenant-Agreements PE-Covenant-agreement and Lot -One -Covenant-
agreement, et al., as expressed in the averments, stipulations and proposed- Orders
presented onto this Court of Record;**

The :court-of-record ORDERS, that:

- 1) the :Respondent-Trustee must now post-haste pay the 'deprivation-penalty' to the Claimant-beneficiary for the Lot -One -:Covenant-Agreement with the :First-Offense of the Political- Election- Covenant-Agreement as stipulated-to and agreed with onto this Court of Record; dates: October 25, 2016 at 11:02 am unto :December 31, 2020 at: 5:00 pm;**
- 2) the :Respondent-Trustee must now post-haste restore :all of the Lot One -:Covenant-Agreement -:property-claimed and possessed to the absolute -private- use and possession to the Claimant-Beneficiary :in-accordance with the Lot -One -Covenant-agreement as stipulated-to and agreed-with onto this Court of Record;**
- 3) the :Respondent-Trustee must pay monthly the deprivation-penalty -obligation as stipulated-to and agreed-with and continue same until such time as :all -property is restored to the Claimant- beneficiary :in-accordance with the Lot -One -Covenant-agreement: starting December 31, 2020 A.D. at 5:00 pm until ending on the last day of the month :January 31, 2021 on 5:00 pm.**
- 4) FURTHER, because of diffuse Dishonor as admitted and stipulated-to by the Respondent, Administrator-Oversight is warranted:**

The :court-of-record ORDERS, that:

:The United States of America -Army, et al. -military must administrate :in-oversight-compliance upon the :POTUS-Corp.-Trustee, et al.- present -man-actors -:in-office, et seq.- man-actors, for to:

- a) assure the :full-restoration of :all property to the Claimant now-to-forever; and,**
- b) to assure and ensure fidelity to these orders that the Lot -One -Covenant-agreement -Claimant-beneficiary's :property(s) are guaranteed under the covenant-agreements here-to-fore and now-to-after.**

Date

:Magistrate: Court of Record

Date

:Clerk: Court of Record



**:In :Hill – Court of :Record
At: Maricopa County Superior Court**

**:Darrell-James: Hill,
:Claimant- beneficiary**

:matter # RE 322 398 389 US

**:Donald-John: Trump,
:Respondent- :Trustee, et al. -
Under-:Procurator**

:ORDERS

PE and Lot -Two- Covenant-agreement

:darrell-james: hill, -:man -:procurator

**:Where, as the Out of Court-Judgment between the parties is :in- accordance with the
Covenant-agreements between the parties, stipulated-to, agreed-upon, and executed
:in- Non-Controversy for the right of the remedy solely for the Claimant under the Law of
the Covenant-Agreements PE-Covenant-agreement and Lot- Two-Covenant-agreement,
et al., as expressed in the averments, stipulations and proposed- Orders presented onto
this Court of Record;**

The :court-of-record ORDERS, that:

- 1) the :Respondent-Trustee must now post-haste pay the 'deprivation-penalty' to the Claimant-beneficiary for the Lot -Two -:Covenant-Agreement with the :First-Offense of the Political- Election- Covenant-Agreement as stipulated-to and agreed with-onto this Court of Record; dates: January 4th, 2017 at 11:11 a.m. unto :December 31, 2020 at: 5:00 pm;**
- 2) the :Respondent-Trustee must now post-haste restore :all of the Lot -Two -:Covenant-Agreement -:property-claimed and possessed to the absolute -private- use and possession to the Claimant-Beneficiary :in-accordance with the Lot -Two -Covenant-agreement as stipulated-to and agreed-with onto this Court of Record;**
- 3) the :Respondent-Trustee must pay monthly the deprivation-penalty -obligation as stipulated-to and agreed-with and continue same until such time as :all -property is restored to the Claimant- beneficiary :in- accordance with the Lot -Two -Covenant-agreement: starting December 31, 2020 A.D. at 5:00 pm until ending on the last day of the month :January 31, 2021 on 5:00 pm.**
- 4) FURTHER, because of diffuse Dishonor as admitted and stipulated-to by the Respondent, Administrator-Oversight is warranted:**

The :court-of-record ORDERS, that:

:The United States of America -Army, et al. -military must administrate :in- oversight-compliance upon the :POTUS-Corp.-Trustee, et al.- present -man-actors -:in-office, et seq- man-actors, for to:

- a) assure the :full-restoration of :all property to the Claimant now-to-forever; and,**
- b) to assure and ensure fidelity to these orders that the Lot -Two -Covenant-agreement -Claimant-beneficiary's :property(s) are guaranteed under the covenant-agreements here-to-fore and now-to-after.**

Date :Magistrate: Court of Record

Date :Clerk: Court of Record

**:In :Hill – Court of :Record
At: Maricopa County Superior Court**

**:Darrell-James: Hill,
:Claimant- beneficiary**

:matter # RE 322 398 389 US

**:Donald-John: Trump,
:Respondent- :Trustee, et al. -
Under-:Procurator**

:ORDERS

PE and Lot -Three- Covenant-agreement

:darrell-james: hill, -:man -:procurator

**:Where, as the Out of Court-Judgment between the parties is :in- accordance with the
Covenant-agreements between the parties, stipulated-to, agreed-upon, and executed
:in- Non-Controversy for the right of the remedy solely for the Claimant under the Law of
the Covenant-Agreements PE-Covenant-agreement and Lot -Three -Covenant-
agreement, et al., as expressed in the averments, stipulations and proposed- Orders
presented onto this Court of Record;**

The :court-of-record ORDERS, that:

- 1) the :Respondent-Trustee must now post-haste pay the 'deprivation-penalty' to the Claimant-beneficiary for the Lot -Three -:Covenant-Agreement with the :First-Offense of the Political- Election- Covenant-Agreement as stipulated-to and agreed with onto this Court of Record; dates: March 20th, 2017, 9:43 a.m. unto :December 31, 2020 at: 5:00 pm;**
- 2) the :Respondent-Trustee must now post-haste restore :all of the Lot Three -:Covenant-Agreement -:property-claimed and possessed to the absolute -private- use and possession to the Claimant-Beneficiary :in-accordance with the Lot-Three -Covenant-agreement as stipulated-to and agreed-with onto this Court of Record;**
- 3) the :Respondent-Trustee must pay monthly the deprivation-penalty -obligation as stipulated-to and agreed-with and continue same until such time as :all -property is restored to the Claimant- beneficiary :in- accordance with the Lot -Three -Covenant-agreement: starting December 31, 2020 A.D. at 5:00 pm until ending on the last day of the month :January 31, 2021 on 5:00 pm.**
- 4) FURTHER, because of diffuse Dishonor as admitted and stipulated-to by the Respondent, Administrator-Oversight is warranted:**

The :court-of-record ORDERS, that:

:The United States of America -Army, et al. -military must administrate :in-oversight-compliance upon the :POTUS-Corp.-Trustee, et al.- present -man-actors -:in-office, et seq. - man-actors, for to:

- a) assure the :full-restoration of :all property to the Claimant now-to-forever; and,**
- b) to assure and ensure fidelity to these orders that the Lot -Three -Covenant-agreement -Claimant-beneficiary's :property(s) are guaranteed under the covenant-agreements here-to-fore and now-to-after.**

Date :Magistrate: Court of Record

Date :Clerk: Court of Record

**:In :Hill – Court of :Record
At: Maricopa County Superior Court**

**:Darrell-James: Hill,
:Claimant- beneficiary**

:matter # RE 322 398 389 US

**:Donald-John: Trump,
:Respondent- :Trustee, et al. -
Under-:Procuration**

**:ORDERS
PE and Lot -Four- Covenant-agreement**

:darrell-james: hill, -:man -:procurator

**:Where, as the Out of Court-Judgment between the parties is :in- accordance with the
Covenant-agreements between the parties, stipulated-to, agreed-upon, and executed
:in- Non-Controversy for the right of the remedy solely for the Claimant under the Law of
the Covenant-Agreements PE-Covenant-agreement and Lot -Four -Covenant-
agreement, et al., as expressed in the averments, stipulations and proposed- Orders
presented onto this Court of Record;**

The :court-of-record ORDERS, that:

- 1) the :Respondent-Trustee must now post-haste pay the 'deprivation-penalty' to the Claimant-beneficiary for the Lot -Four -:Covenant-Agreement with the :First-Offense of the Political- Election- Covenant-Agreement as stipulated-to and agreed with onto this Court of Record; dates: September 15th, 2016 at 11:11 am unto :December 31, 2020 at: 5:00 pm;**
- 2) the :Respondent-Trustee must now post-haste restore :all of the Lot Four -:Covenant-Agreement -:property-claimed and possessed to the absolute -private- use and possession to the Claimant-Beneficiary :in-accordance with the Lot -Four -Covenant-agreement as stipulated-to and agreed-with onto this Court of Record;**
- 3) the :Respondent-Trustee must pay monthly the deprivation-penalty -obligation as stipulated-to and agreed-with and continue same until such time as :all -property is restored to the Claimant- beneficiary :in-accordance with the Lot -Four -Covenant-agreement: starting December 31, 2020 A.D. at 5:00 pm until ending on the last day of the month :January 31, 2021 on 5:00 pm.**
- 4) FURTHER, because of diffuse Dishonor as admitted and stipulated-to by the Respondent, Administrator-Oversight is warranted:**

The :court-of-record ORDERS, that:

:The United States of America -Army, et al. -military must administrate :in-oversight-compliance upon the :POTUS-Corp.-Trustee, et al.- present -man-actors -:in-office, et seq.- man-actors, for to:

- a) assure the :full-restoration of :all property to the Claimant now-to-forever; and,**
- b) to assure and ensure fidelity to these orders that the Lot -Four -Covenant-agreement -Claimant-beneficiary's :property(s) are guaranteed under the covenant-agreements here-to-fore and now-to-after.**

Date :Magistrate: Court of Record

Date :Clerk: Court of Record



January 19, 2021- A.D.

:Maricopa-County-Arizona-State- Deprivation of the Access to the Common-Law-Court at the Maricopa- County- Arizona- Superior-Court- venue is with the unlawful-Policy and Procedure- Implemented with the harm upon the man-Ohioan-Executor -:Darrell-James: Hill, -Executor- Procurator, -:Arizona-habitant by the Maricopa-County-Arizona-State- Clerks:Vanessa: Martinez with reported counsel with :Nikki: Swiss and :Jeff: Fine.

Time		
11:00 a.m.	C-312 Window 1	Clerk receiving document does not comprehend the document; took document to a more senior clerk.
11:20 a.m.		Back to the window after ID of the document; clerk says has confusion over the 'Executor'.
		Given document for the change document.
11:50 a.m.	C-327 Window 9	With civil Sheet and original document.
	:Vanessa: Martinez	'Not able to receive Court-of-Record -document for recording because policy of deferral of court fees and costs Deferral as presented by the Executor is not sufficient as does not comply with the Maricopa-County-Arizona-State- policy.' Informed Executor that Policy is greater than law. Need to go to the Set 1350 to complete the waiver sheet at the court-administration- office.
12:26 p.m.	Court-Admin. Office	See: Order Regarding Deferral or Waiver of Court Fees and Costs and Notice Regarding Consent Judgment- sheet, 3 pages.
13:45 p.m.	:Vanessa: Martinez	Back with completed Court-Admin.-Sheet to :Vanessa: M., Window 1. Reportedly-took the -:Deferral-document to the upper-management: Nikki: Swiss, who reportedly-referred the matter to the man- Jeff: Fine.

:i- man verify that the above is true and correct, and will state same in the open-court.

Without prejudice,

12/15/2021-A.D.

Darrell-James Hill; -Executor
:Darrell-James: Hill, -:Ohioan, -:Executor

2022-011769 MISC Page: 1856 of 2782
09/26/2022 03:35:37 PM Receipt #: 22-9381
Rec Fee: \$30.00 Darrell James Hill
Gila County, Az, Sadie Jo Bingham, Recorder



Darrell-James: Hill, -civilian, -:Executor
PO Box 3806
Apache Junction, Arizona 85117

RECEIVED

21 JAN 19 PM 12:10

:man :present, -:

COURT ADMINISTRATION
SOUTHEAST FACILITY

Arizona state
Maricopa county

:In :Hill – Court of :Record
At: Maricopa County Superior Court

:Darrell-James: Hill,
:Claimant- beneficiary

:claim – executed:

:matter # RE 322 398 389 US

:Donald-John: Trump,
:Respondent- :Trustee, et al.- :man-actor
-Trustees: Barack-Hussein: Obama;
Loretta: Lynch, Jefferson-Beauregard:
Sessions III, Matthew-George: Whitaker,
Dana-James: Boente, Sally-Caroline: Yates,
William-Pelham: Barr; Steve-Truner: Mnuchin;
Brian: Karth, Ranier-Christercunean: Collins,
John and Jane Does; Under-:Procurator.

:Executor- Waiver of :Recordation and
Court-of-Record Fees

(verified)

under-:procurator for respondent
:darrell-james: hill, -:man -:procurator

:i- man- Executor- Trustee waive the recordation and Court-of-Record fees in this
matter for :execution of the right in suit at common law where the matter in controversy
exceeded twenty dollars.

:i- man say here under penalty of perjury, and will verify same in the open-court, that :all herein
be true and correct to the best of :i- man's knowledge;

January 19th, 2021 day Darrell-James: Hill
:Darrell-James: Hill, -: Executor



RECEIVED

at Hill-Court
21 JAN 19 PM 1:29
SUPERIOR COURT OF ARIZONA
IN MARICOPA COUNTY
SOUTHEAST FACILITY

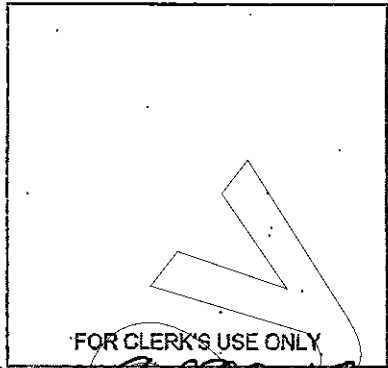

Darrell James Hill
Name of Petitioner/Plaintiff
Claimant

Claim # RE 322 398 389 US
Case Number:

ORDER REGARDING DEFERRAL OR
WAIVER OF COURT FEES AND COSTS
AND NOTICE REGARDING CONSENT
JUDGMENT

Donald John Tump, et al
Name of Respondent/Defendant

THE COURT FINDS that the ^{man} applicant (print name): Darrell James Hill

- 1. IS NOT ELIGIBLE FOR A DEFERRAL of fees and/or costs.
- OR
- 2. IS ELIGIBLE FOR A DEFERRAL of fees and costs based on financial eligibility. As required by state law, the applicant has signed a consent to entry of judgment.
- OR
- 3. IS ELIGIBLE FOR DEFERRAL of fees and/or costs at the court's discretion. (A.R.S. §12-302(L)).
- OR
- 4. IS ELIGIBLE FOR DEFERRAL of fees and costs based on good cause shown. As required by state law, the applicant has signed a consent to entry of judgment.
- 5. IS ELIGIBLE FOR WAIVER of fees and costs because the applicant is permanently unable to pay.
- 6. IS ELIGIBLE FOR WAIVER of fees and costs at the court's discretion (A.R.S. §12-302(L)). (ARS 12-301(A); 12-122, 12-123, 12-302) Arizona Const. Sec 2, 1, 2, 3, Const. for U.S. of America - Bill of Rights Amend 7
- 7. IS NOT ELIGIBLE FOR WAIVER of fees and costs.

IT IS ORDERED:

- 1. DEFERRAL DENIED for the following reason(s):
 The application is incomplete because _____

1899
© Superior Court of Arizona in Maricopa County
August 13, 2007
ALL RIGHTS RESERVED
ODF NA

2022-011769 MISC Page: 1858 of 2782
09/26/2022 03:35:37 PM Receipt #: 22-9381
Rec Fee: \$30.00 Darrell James Hill
Gila County, Az, Sadie Jo Bingham, Recorder



You are encouraged to submit a complete application.

The applicant does not meet the financial criteria for deferral because:

max

A deferral **MUST BE** granted if the applicant is receiving public assistance benefits or has an income that is insufficient or barely sufficient to meet the daily essentials of life and that includes no allotment that could be budgeted to pay the fees and/or costs necessary to gain access to the court or if the applicant demonstrates other good cause.

2. **DEFERRAL GRANTED** for the following fees and/or costs in this court:

- Any or all filing fees; fees for the issuance of a summons and subpoena; fees for obtaining one certified copy of a temporary order in a domestic relations case or a final order, judgment or decree in all civil proceedings.
- Fees for service of process by a sheriff, marshal, constable or law enforcement agency.
- Fees for service by publication.
- Filing fees and photocopy fees for the preparation of the record on appeal.
- Court reporter or transcriber fees if employed by the court for the preparation of the transcript.

IF A DEFERRAL IS GRANTED:

NO PAYMENTS WILL BE DUE UNTIL FURTHER NOTICE

SCHEDULE OF PAYMENTS

The applicant shall pay \$ _____ each _____ (week, month, etc.) until paid in full, beginning _____

3. **WAIVER DENIED** for all fees and/or costs of this case.

4. **WAIVER GRANTED** for all fees and/or costs of this case that may be waived under A.R.S. §12-302(H) *ARS 12-301(A), Ariz Const Sec 2-1, 2, 3, Const for U.S. Supr Amend 7*

- Any or all filing fees; fees for the issuance of a summons and subpoena; fees for obtaining one certified copy of a temporary order in a domestic relations case or a final order, judgment or decree in all civil proceedings.
- Fees for service of process by a sheriff, marshal, constable or law enforcement agency.
- Fees for service by publication.
- Filing fees and photocopy fees for the preparation of the record on appeal.
- Court reporter or transcriber fees if employed by the court for the preparation of the transcript.

5. **RIGHT TO JUDICIAL REVIEW.** If the application is denied or a payment schedule set by a special commissioner, you may request the decision be reviewed by a judicial officer. The request must be made within twenty (20) days of the day the order was mailed or delivered to you. If a schedule of payments has been established, payments shall be suspended until a decision is made after the judicial review. The judicial review shall be held as soon as reasonably possible.

6. **NOTICE REGARDING CONSENT JUDGMENT.** Unless any one of the following applies, a consent judgment shall be entered against the applicant for all fees and costs that are deferred and remain unpaid thirty (30) days after entry of final judgment.



1850

- A. Fees and costs are taxed to another party;
- B. The applicant has an established schedule of payments in effect and is current with those payments;
- C. The applicant filed a supplemental application for waiver or further deferral of fees and costs and a decision by the court is pending;
- D. In response to a supplemental application, the court orders that the fees and costs be waived or further deferred; or
- E. Within twenty days of the date the court denies the supplemental application, the applicant either:
 1. Pays the fees and/or costs; or,
 2. Requests a hearing on the court's order denying waiver or further deferral. If the applicant requests a hearing, the court cannot enter the consent judgment unless a hearing is held, further waiver or deferral is denied and payment has not been made within the time prescribed by the court.

If an appeal is taken, a consent judgment for deferred fees and/or costs that remain unpaid in the lower court shall not be entered until thirty (30) days after the appeals process is concluded. The procedures for notice of court fees and/or costs and for entry of a consent judgment continue to apply.

If a consent judgment is signed and the applicant pays the fees and/or costs in full, the court is required to comply with the provisions of A.R.S. 33-964(C).

7. DUTY TO REPORT CHANGE IN FINANCIAL CIRCUMSTANCES. An applicant who is granted a deferral shall promptly notify the court of the change in financial circumstances during the pendency of the case that would affect the applicant's ability to pay court fees and/or costs. Any time the applicant appears before the court on this case, the court may inquire as to the applicant's financial circumstances.

DATED: January 19, 2021

Darrell James Hill, Executor
 Judicial Officer or Special Commissioner
 Executor: Hill - Court
 See: attached Executor of
 Recordation and
 Court-of-Record Fees



Law section reviewed and presented on the January 19, 2021 at the :Maricopa-County-Arizona-State- Deprivation of the Access to the Common-Law-Court at the Maricopa- County- Arizona- Superior-Court- venue is with the unlawful-Policy AND Procedure- Implemented with the harm upon the man-Ohioan-Executor -:Darrell-James: Hill, -:Executor-Procurator, :Arizona-State-habitant by the Maricopa-County-Arizona-State- Clerks: Vanessa: Martinez with reported-counsel with :Nikki: Swiss and :Jeff: Fine.

Arizona-Revised-Statutes

12-301. Time of payment of fees; effect of failure to collect; alternative payment methods

A. All fees are payable at the time the service is rendered, unless otherwise provided by law. An officer may refuse to perform any service in any action or proceeding, criminal proceedings excepted, until the fees are paid.

B. Failure to collect the fee shall not affect the validity of the act or service.

C. The court may allow fees to be paid by alternative methods, including credit cards, charge cards, debit cards and electronic funds transfers.

12-122. General power of superior court

The superior court, in addition to the powers conferred by constitution, rule or statute, may proceed according to the common law.

12-123. Jurisdiction and powers

A. The superior court shall have original and concurrent jurisdiction as conferred by the constitution, and concurrent jurisdiction with justices of the peace of misdemeanors where the penalty does not exceed a fine of two thousand five hundred dollars or imprisonment for six months.

B. The court, and the judges thereof, shall have all powers and may issue all writs necessary to the complete exercise of its jurisdiction.

12-302. Extension of time for payment of fees and costs; relief from default for nonpayment; deferral or waiver of court fees and costs; definitions

A. The court or any judge may for good cause shown extend the time for paying any court fees and costs required by law or may relieve against a default caused by nonpayment of a fee within the time provided by law, but no fees paid shall be refunded.

B. The supreme court shall adopt forms and procedures for deferral or waiver of court fees and costs.



1852
U

C. Except as provided in subsection E of this section, the court shall grant an application for deferral of court fees and costs if the applicant establishes by affidavit, including supporting documentation, that the applicant either:

1. Is receiving benefits pursuant to one or more of the following programs:
 - (a) The temporary assistance for needy families program established by section 403 of title 4 of the social security act as it exists after August 21, 1996.
 - (b) The food stamp program (7 United States Code sections 2011 through 2029).
2. Is receiving benefits pursuant to the supplemental security income program (42 United States Code sections 1381 through 1385).
3. Has an income that is insufficient or barely sufficient to meet the daily essentials of life and that includes no allotment that could be budgeted for the fees and costs that are required to gain access to the court. In considering insufficient income pursuant to this paragraph, the court may consider the following as evidence of insufficient income:
 - (a) The applicant has a gross income that as computed on a monthly basis is one hundred fifty percent or less of the current poverty level established by the United States department of health and human services. Gross monthly income includes the applicant's share of community property income.
 - (b) The applicant's income is considered to be sufficient, but the applicant provides proof of extraordinary expenses, including medical expenses, costs of care for elderly family members or family members with disabilities or other expenses that are deemed extraordinary, that reduce the applicant's gross monthly income to at or below one hundred fifty percent of the current poverty level established by the United States department of health and human services.

D. On proof that the applicant is permanently unable to pay fees or costs, the court shall waive them. For the purposes of this subsection, "permanently unable to pay" means the applicant's income and liquid assets are insufficient or barely sufficient to meet the daily essentials of life and the income and liquid assets are unlikely to change in the foreseeable future.

E. Except in cases of dissolution of marriage, legal separation, annulment or establishment, enforcement or modification of child support, and notwithstanding subsection A of this section or chapter 9, article 4 of this title, if the applicant is an inmate who is confined to a correctional facility operated by the state department of corrections and who initiates a civil action or proceeding, the inmate is responsible for the full payment of actual court fees and costs. On filing the civil action or proceeding, the clerk of the court shall assess and, when monies exist, collect as a partial payment of any court fees and costs required by law a first time payment of twenty percent. Thereafter the state department of corrections shall withhold twenty percent of all deposits into the prisoner's spendable account administered by the department until the actual court fees and costs are collected in full. The state department of corrections

1863

2022-011769 MISC Page: 1862 of 2782
09/28/2022 03:35:37 PM Receipt #: 22-9381
Rec Fee: \$30.00 Darrell James Hill
Gila County, Az, Sadie Jo Bingham, Recorder



shall annually forward any monies withheld to the clerk of the court of each court of jurisdiction before January 31. If a prisoner is released before the full fees and costs are collected, the state department of corrections shall forward the amount of fees and costs collected through the date of the prisoner's release. The clerk of the court of each court of jurisdiction is responsible for sending the state department of corrections a copy of the order mandating the amount of fees and costs to be paid. This subsection does not prohibit an applicant from filing a civil action or proceeding if the applicant is unable to pay the filing fees.

F. At the time an applicant signs and submits the application for deferral to the court, the applicant shall acknowledge under oath and sign a consent to judgment. By signing the consent to judgment, the applicant consents to judgment being entered against the applicant for all fees and costs that are deferred but that remain unpaid after thirty calendar days following the entry of final judgment or order. A consent judgment may be entered against the applicant unless one of the following applies:

1. The applicant has an established schedule of payment in effect and is current with payments.
2. A supplemental application for further deferral or waiver has been filed and is pending.
3. In response to a supplemental application, the court orders that the fees and costs be further deferred or waived.
4. Within twenty days of the date the court denies the supplemental application, the applicant either pays the fees or requests a hearing on the court's final order denying further deferral or waiver. If the applicant requests a hearing, the court shall not enter a consent judgment unless a hearing is held, further deferral or waiver is denied and payment has not been made within the time prescribed by the court.

G. An applicant who is granted a deferral or waiver or a party to the action who knows of any change in the financial circumstances of the applicant shall promptly notify the court of the change in the applicant's financial circumstances during the pendency of the action that affects the applicant's ability to pay court fees and costs. If within ten days after notice and a hearing the court determines that the applicant's financial circumstances have changed and that the applicant no longer meets the eligibility requirements of this section, the court shall order the applicant to pay the deferred or waived fees and costs.

H. The following court fees and costs may be deferred or waived, except that the county shall pay the fees and costs in paragraphs 6 and 7 of this subsection on the granting of an application for deferral or waiver and an applicant who has been granted a deferral shall reimburse the county for the fees and costs in paragraphs 6 and 7 of this subsection:

1. Filing fees.



2. Fees for issuance of either a summons or subpoena.
3. Fees for obtaining one certified copy of a temporary order in a domestic relations case.
4. Fees for obtaining one certified copy of a final order, judgment or decree in all civil proceedings.
5. Sheriff, marshal, constable and law enforcement fees for service of process if any of the following applies:
 - (a) The applicant established by affidavit that the applicant has attempted without success to obtain voluntary acceptance of service of process.
 - (b) The applicant's attempt to obtain voluntary acceptance of service of process would be futile or dangerous.
 - (c) An order of protection or an injunction against harassment in favor of the applicant and against the party sought to be served exists and is enforceable.
6. The fee for service by publication if service is required by law and if the applicant establishes by affidavit specific facts to show that the applicant has exercised due diligence in attempting to locate the person to be served and has been unable to do so.
7. Court reporter's fees for the preparation of court transcripts if the court reporter is employed by the court.
8. Appeal preparation and filing fees at all levels of appeal and photocopy fees for the preparation of the record on appeal pursuant to sections 12-119.01, 12-120.31 and 12-2107 and section 12-284, subsection A.
 - I. If the case is appealed, the initial deferral or waiver remains in effect unless there is a change in the applicant's financial circumstances. If a case is appealed an applicant may be required to submit to the appellate court a new application for a deferral or waiver of the court fees and costs.
 - J. If a judgment is rendered for court fees and costs, the court fees and costs deferred but unpaid and the expenses paid by the county under this section shall be included in the judgment and shall be paid directly to the clerk of the court by the party against whom the court fees and costs were assessed.
 - K. A waiver of court fees or costs shall not be granted for:
 1. Matters that are filed as class actions pursuant to rule 23 of the Arizona rules of civil procedure.
 2. Civil actions other than cases of dissolution of marriage, legal separation, annulment or establishment, enforcement or modification of child support that are filed by persons who at the time of filing the application are incarcerated as a result of a felony conviction in an out-of-state correctional facility or in a jail waiting to be transported to a state department of corrections facility.



3. Civil actions other than cases of dissolution of marriage, legal separation, annulment or establishment, enforcement or modification of child support filed by a pro se litigant who has been previously declared a vexatious litigant by any court.

L. This section does not limit the court's discretion in deferring, waiving or ordering the county to pay any fees and costs as may be necessary and appropriate.

M. If an applicant who is granted a deferral or waiver is found to be a vexatious litigant by any court during the pendency of the action, the court shall order the applicant to pay the deferred or waived fees and costs.

N. For the purposes of this section:

1. "Deferral" means either postponement of an obligation to pay fees or establishment of a schedule for payment of fees.

2. "Further deferral" means the establishment of a schedule for payment of fees.

Arizona-State-Constitution

1. Fundamental principles; recurrence to

Section 1. A frequent recurrence to fundamental principles is essential to the security of individual rights and the perpetuity of free government.

2. Political power; purpose of government

Section 2. All political power is inherent in the people, and governments derive their just powers from the consent of the governed, and are established to protect and maintain individual rights.

3. Supreme law of the land; authority to exercise sovereign authority against federal action; use of government personnel and financial resources

Section 3. A. The Constitution of the United States is the supreme law of the land to which all government, state and federal, is subject.

B. To protect the people's freedom and to preserve the checks and balances of the United States Constitution, this state may exercise its sovereign authority to restrict the actions of its personnel and the use of its financial resources to purposes that are consistent with the constitution by doing any of the following:

1. Passing an initiative or referendum pursuant to article IV, part 1, section 1.
2. Passing a bill pursuant to article IV, part 2 and article V, section 7.
3. Pursuing any other available legal remedy.

C. If the people or their representatives exercise their authority pursuant to this section, this state and all political subdivisions of this state are prohibited from using any personnel or financial resources to enforce, administer or cooperate with the designated federal action or program.



Constitution for the Untied States of America-1787-A.D.,
:-Bill-of-Rights- 1789-A.D., Amendment 7:

Amendment 7 - Trial by Jury in Civil Cases. Ratified 12/15/1791.

In Suits at common law, where the value in controversy shall exceed twenty dollars, the right of trial by jury shall be preserved, and no fact tried by a jury, shall be otherwise re-examined in any Court of the United States, than according to the rules of the common law.

Amendment 9 - Construction of Constitution. Ratified 12/15/1791.

The enumeration in the Constitution, of certain rights, shall not be construed to deny or disparage others retained by the people.

Amendment 10 - Powers of the States and People. Ratified 12/15/1791.

The powers not delegated to the United States by the Constitution, nor prohibited by it to the States, are reserved to the States respectively, or to the people.



**CLERK OF THE COURT
SUPERIOR COURT OF ARIZONA**

MARICOPA COUNTY

(602) 37-CLERK(25375)
Fax - (602) 506-7684

To: **DARRELL JAMES HILL**
5124 E 18TH AVE
AZ 85117

THE ATTACHED DOCUMENTS ARE BEING RETURNED TO YOU FOR THE FOLLOWING REASON(S):

<input type="checkbox"/>	Cover sheet is missing.
<input type="checkbox"/>	To request forms, please see attached document.
<input checked="" type="checkbox"/>	Filing fee of \$333.00 must be paid prior to filing. Please visit our website (www.clerkofcourt.maricopa.gov) for our acceptable forms of payment.
<input type="checkbox"/>	The office is unable to accept forms of payment dated over 21 days old.
<input type="checkbox"/>	If you cannot afford the fee, enclosed is an application for a Deferral/Waiver.
<input type="checkbox"/>	Pursuant to the Clerk's Office Procedure, any money presented for a bond must be certified funds; e.g. cash, a local attorney's trust account check, or wire transfer. <i>Money orders and operating account check are not acceptable.</i>
<input type="checkbox"/>	\$30.00 handling fee is missing.
<input type="checkbox"/>	Affidavit setting forth last known address for both the judgment creditor and the judgment debtor is missing (A.R.S. 12-1703).
<input type="checkbox"/>	Authenticated copy of the judgment from the foreign jurisdiction is missing (A.R.S. 12-1702, 25-1055, 25-1302).
<input type="checkbox"/>	Subpoena format does not meet requirements of Arizona Rules of Civil Procedure.
<input type="checkbox"/>	Fee for certified copies is \$30.00 plus \$.50 per page.
<input type="checkbox"/>	Pursuant to Maricopa County Local Rule 2.5 (c) required verbiage is missing on your Summons, Subpoena or Order to Appear. Your documents are being returned to you unissued.
<input type="checkbox"/>	Pursuant to Rule 5.1 (c) 2 or 10 of the Arizona Rules of Civil Procedure, your document cannot be filed.
<input type="checkbox"/>	Pursuant to Administrative Order 2016-006 <i>Clerk of Court cannot accept Parent Information Program certificates for paper filing for any program that was attended after January 15, 2016.</i> You may return to the class provider and request that they eFile the certificate or file a motion requesting an order from your assigned Judge to allow you to file.
<input type="checkbox"/>	Affidavit of Proposed Appointee needs to be provided before a case number can be assigned (ARS 14-3108).
<input type="checkbox"/>	PB letters cannot be issued: _____
<input checked="" type="checkbox"/>	Other: The filing fee of \$333.00 or a Deferral Application is due at the time of filing.

ADDITIONAL INFORMATION:

<input type="checkbox"/>	Documents are not signed and/or notarized.
<input type="checkbox"/>	Please provide two self-addressed stamped envelopes pursuant to Rule 3.2(I).
<input type="checkbox"/>	Required document is missing: _____
<input type="checkbox"/>	Required copies are missing. Please provide _____ sets of copies.
<input type="checkbox"/>	Please review Maricopa County Local Rule 2.15 for required formatting of forms and documents.
<input type="checkbox"/>	The case captions are incorrect.
<input type="checkbox"/>	Proposed orders that go along with this filing are missing.
<input type="checkbox"/>	Other: _____
Location: <input type="checkbox"/> Central Court <input type="checkbox"/> Law Library <input checked="" type="checkbox"/> Southeast <input type="checkbox"/> Northeast <input type="checkbox"/> Northwest	

Date: 1/19/21

Deputy Clerk: V Martinez

2022-011769 MISC Page: 1867 of 2782
09/26/2022 03:35:37 PM Receipt #: 22-9381
Rec Fee: \$30.00 Darrell James Hill
Gila County, Az, Sadie Jo Bingham, Recorder

Visit us at our website: www.clerkofcourt.maricopa.gov



Law section reviewed and presented on the January 19, 2021 at the :Maricopa-County-Arizona-State- Deprivation of the Access to the Common-Law-Court at the Maricopa- County- Arizona- Superior-Court- venue is with the unlawful-Policy AND Procedure- Implemented with the harm upon the man-Ohioan-Executor -:Darrell-James: Hill, -:Executor-Procurator, :Arizona-State-habitant by the Maricopa-County-Arizona-State- Clerks: Vanessa: Martinez with reported-counsel with :Nikki: Swiss and :Jeff: Fine.

Arizona-Revised-Statutes

12-301. Time of payment of fees; effect of failure to collect; alternative payment methods

- A. All fees are payable at the time the service is rendered, unless otherwise provided by law. An officer may refuse to perform any service in any action or proceeding, criminal proceedings excepted, until the fees are paid.
- B. Failure to collect the fee shall not affect the validity of the act or service.
- C. The court may allow fees to be paid by alternative methods, including credit cards, charge cards, debit cards and electronic funds transfers.

12-122. General power of superior court

The superior court, in addition to the powers conferred by constitution, rule or statute, may proceed according to the common law.

12-123. Jurisdiction and powers

- A. The superior court shall have original and concurrent jurisdiction as conferred by the constitution, and concurrent jurisdiction with justices of the peace of misdemeanors where the penalty does not exceed a fine of two thousand five hundred dollars or imprisonment for six months.
- B. The court, and the judges thereof, shall have all powers and may issue all writs necessary to the complete exercise of its jurisdiction.

12-302. Extension of time for payment of fees and costs; relief from default for nonpayment; deferral or waiver of court fees and costs; definitions

- A. The court or any judge may for good cause shown extend the time for paying any court fees and costs required by law or may relieve against a default caused by nonpayment of a fee within the time provided by law, but no fees paid shall be refunded.
- B. The supreme court shall adopt forms and procedures for deferral or waiver of court fees and costs.



1859

C. Except as provided in subsection E of this section, the court shall grant an application for deferral of court fees and costs if the applicant establishes by affidavit, including supporting documentation, that the applicant either:

1. Is receiving benefits pursuant to one or more of the following programs:

(a) The temporary assistance for needy families program established by section 403 of title 4 of the social security act as it exists after August 21, 1996.

(b) The food stamp program (7 United States Code sections 2011 through 2029).

2. Is receiving benefits pursuant to the supplemental security income program (42 United States Code sections 1381 through 1385).

3. Has an income that is insufficient or barely sufficient to meet the daily essentials of life and that includes no allotment that could be budgeted for the fees and costs that are required to gain access to the court. In considering insufficient income pursuant to this paragraph, the court may consider the following as evidence of insufficient income:

(a) The applicant has a gross income that as computed on a monthly basis is one hundred fifty percent or less of the current poverty level established by the United States department of health and human services. Gross monthly income includes the applicant's share of community property income.

(b) The applicant's income is considered to be sufficient, but the applicant provides proof of extraordinary expenses, including medical expenses, costs of care for elderly family members or family members with disabilities or other expenses that are deemed extraordinary, that reduce the applicant's gross monthly income to at or below one hundred fifty percent of the current poverty level established by the United States department of health and human services.

D. On proof that the applicant is permanently unable to pay fees or costs, the court shall waive them. For the purposes of this subsection, "permanently unable to pay" means the applicant's income and liquid assets are insufficient or barely sufficient to meet the daily essentials of life and the income and liquid assets are unlikely to change in the foreseeable future.

E. Except in cases of dissolution of marriage, legal separation, annulment or establishment, enforcement or modification of child support, and notwithstanding subsection A of this section or chapter 9, article 4 of this title, if the applicant is an inmate who is confined to a correctional facility operated by the state department of corrections and who initiates a civil action or proceeding, the inmate is responsible for the full payment of actual court fees and costs. On filing the civil action or proceeding, the clerk of the court shall assess and, when monies exist, collect as a partial payment of any court fees and costs required by law a first time payment of twenty percent.

Thereafter the state department of corrections shall withhold twenty percent of all deposits into the prisoner's spendable account administered by the department until the actual court fees and costs are collected in full. The state department of corrections



shall annually forward any monies withheld to the clerk of the court of each court of jurisdiction before January 31. If a prisoner is released before the full fees and costs are collected, the state department of corrections shall forward the amount of fees and costs collected through the date of the prisoner's release. The clerk of the court of each court of jurisdiction is responsible for sending the state department of corrections a copy of the order mandating the amount of fees and costs to be paid. This subsection does not prohibit an applicant from filing a civil action or proceeding if the applicant is unable to pay the filing fees.

F. At the time an applicant signs and submits the application for deferral to the court, the applicant shall acknowledge under oath and sign a consent to judgment. By signing the consent to judgment, the applicant consents to judgment being entered against the applicant for all fees and costs that are deferred but that remain unpaid after thirty calendar days following the entry of final judgment or order. A consent judgment may be entered against the applicant unless one of the following applies:

1. The applicant has an established schedule of payment in effect and is current with payments.
2. A supplemental application for further deferral or waiver has been filed and is pending.
3. In response to a supplemental application, the court orders that the fees and costs be further deferred or waived.
4. Within twenty days of the date the court denies the supplemental application, the applicant either pays the fees or requests a hearing on the court's final order denying further deferral or waiver. If the applicant requests a hearing, the court shall not enter a consent judgment unless a hearing is held, further deferral or waiver is denied and payment has not been made within the time prescribed by the court.

G. An applicant who is granted a deferral or waiver or a party to the action who knows of any change in the financial circumstances of the applicant shall promptly notify the court of the change in the applicant's financial circumstances during the pendency of the action that affects the applicant's ability to pay court fees and costs. If within ten days after notice and a hearing the court determines that the applicant's financial circumstances have changed and that the applicant no longer meets the eligibility requirements of this section, the court shall order the applicant to pay the deferred or waived fees and costs.

H. The following court fees and costs may be deferred or waived, except that the county shall pay the fees and costs in paragraphs 6 and 7 of this subsection on the granting of an application for deferral or waiver and an applicant who has been granted a deferral shall reimburse the county for the fees and costs in paragraphs 6 and 7 of this subsection:

1. Filing fees.



2. Fees for issuance of either a summons or subpoena.
3. Fees for obtaining one certified copy of a temporary order in a domestic relations case.
4. Fees for obtaining one certified copy of a final order, judgment or decree in all civil proceedings.
5. Sheriff, marshal, constable and law enforcement fees for service of process if any of the following applies:
 - (a) The applicant established by affidavit that the applicant has attempted without success to obtain voluntary acceptance of service of process.
 - (b) The applicant's attempt to obtain voluntary acceptance of service of process would be futile or dangerous.
 - (c) An order of protection or an injunction against harassment in favor of the applicant and against the party sought to be served exists and is enforceable.
6. The fee for service by publication if service is required by law and if the applicant establishes by affidavit specific facts to show that the applicant has exercised due diligence in attempting to locate the person to be served and has been unable to do so.
7. Court reporter's fees for the preparation of court transcripts if the court reporter is employed by the court.
8. Appeal preparation and filing fees at all levels of appeal and photocopy fees for the preparation of the record on appeal pursuant to sections 12-119.01, 12-120.31 and 12-2107 and section 12-284, subsection A.
 - I. If the case is appealed, the initial deferral or waiver remains in effect unless there is a change in the applicant's financial circumstances. If a case is appealed an applicant may be required to submit to the appellate court a new application for a deferral or waiver of the court fees and costs.
 - J. If a judgment is rendered for court fees and costs, the court fees and costs deferred but unpaid and the expenses paid by the county under this section shall be included in the judgment and shall be paid directly to the clerk of the court by the party against whom the court fees and costs were assessed.
 - K. A waiver of court fees or costs shall not be granted for:
 1. Matters that are filed as class actions pursuant to rule 23 of the Arizona rules of civil procedure.
 2. Civil actions other than cases of dissolution of marriage, legal separation, annulment or establishment, enforcement or modification of child support that are filed by persons who at the time of filing the application are incarcerated as a result of a felony conviction in an out-of-state correctional facility or in a jail waiting to be transported to a state department of corrections facility.



3. Civil actions other than cases of dissolution of marriage, legal separation, annulment or establishment, enforcement or modification of child support filed by a pro-se litigant who has been previously declared a vexatious litigant by any court.
- L. This section does not limit the court's discretion in deferring, waiving or ordering the county to pay any fees and costs as may be necessary and appropriate.
- M. If an applicant who is granted a deferral or waiver is found to be a vexatious litigant by any court during the pendency of the action, the court shall order the applicant to pay the deferred or waived fees and costs.
- N. For the purposes of this section:
1. "Deferral" means either postponement of an obligation to pay fees or establishment of a schedule for payment of fees.
 2. "Further deferral" means the establishment of a schedule for payment of fees.

Arizona-State-Constitution

1. Fundamental principles; recurrence to

Section 1. A frequent recurrence to fundamental principles is essential to the security of individual rights and the perpetuity of free government.

2. Political power; purpose of government

Section 2. All political power is inherent in the people, and governments derive their just powers from the consent of the governed, and are established to protect and maintain individual rights.

3. Supreme law of the land; authority to exercise sovereign authority against federal action; use of government personnel and financial resources

Section 3. A. The Constitution of the United States is the supreme law of the land to which all government, state and federal, is subject.

B. To protect the people's freedom and to preserve the checks and balances of the United States Constitution, this state may exercise its sovereign authority to restrict the actions of its personnel and the use of its financial resources to purposes that are consistent with the constitution by doing any of the following:

1. Passing an initiative or referendum pursuant to article IV, part 1, section 1.
2. Passing a bill pursuant to article IV, part 2 and article V, section 7.
3. Pursuing any other available legal remedy.

C. If the people or their representatives exercise their authority pursuant to this section, this state and all political subdivisions of this state are prohibited from using any personnel or financial resources to enforce, administer or cooperate with the designated federal action or program.



Constitution for the Untied States of America-1787-A.D.,
:-Bill-of-Rights- 1789-A.D., Amendment 7:

Amendment 7 - Trial by Jury in Civil Cases. Ratified 12/15/1791.

In Suits at common law, where the value in controversy shall exceed twenty dollars, the right of trial by jury shall be preserved, and no fact tried by a jury, shall be otherwise re-examined in any Court of the United States, than according to the rules of the common law.

Amendment 9 - Construction of Constitution. Ratified 12/15/1791.

The enumeration in the Constitution, of certain rights, shall not be construed to deny or disparage others retained by the people.

Amendment 10 - Powers of the States and People. Ratified 12/15/1791.

The powers not delegated to the United States by the Constitution, nor prohibited by it to the States, are reserved to the States respectively, or to the people.



Darrell-James: Hill, -civilian, -:Executor
PO Box 3806
Apache Junction, Arizona 85117

:man :present,

Arizona state
Pinal county

USPO CMN 7009 2820 0003 9570 7942
:Jack: Sellers, :Dist.- 1,
:Steve: Chucri, :Dist.- 2,
:Bill: Gates, :Dist.- 3,
:Clint: Hickman, :Dist.- 4,
:Steve: Gallardo, :Dist.- 5,
:Maricopa County Board of Supervisors
c/o: Fran: McCarroll, -:Clerk
301 West Jefferson Street
Phoenix, Arizona 85003

7009 2820 0003 9570 7959
:Joseph: Welty, -: Maricopa county Judge, -:Chief
201 West Jefferson Street
Phoenix, Arizona 85003

7009 2820 0003 9570 7966
:Pamela: Gates, -: Maricopa county Judge,
-:Presiding
c/o : Keith: Kaplan, -:Administrator
:Civil Court Administration
201 West Jefferson Street, 4th Floor
Phoenix, Arizona 85003

7009 2820 0003 9570 7973
:Jeff: Fine, -:Maricopa county Clerk of the Court
620 West Jackson Street
Phoenix, Arizona 85003

7009 2820 0003 9570 7980
:Paul: Penzone, -:Maricopa county Sheriff
550 West Jackson
Phoenix Arizona state 85003

7009 2820 0003 9570 7997
Joseph-Robinette: Biden, -:POTUS
600 Pennsylvania Ave NW
Washington, District of Columbia 20500

7009 2820 0003 9570 8000
:Monty: Wilkinson, -:CLT, U.S. Atty.-General'
950 Pennsylvania Avenue, NW
Washington, Dist. Of Columbia 20530-0001

RE: A **January 19th, 2021- Deprivation of Rights to the Court of Record for
:claim: :matter # RE 322 398 389 US at the Maricopa county Court;
the Second Level Offense :in Accordance with the Covenant-agreement in the
Election: See: Gila county Recorder, Doc.# 2017-002378, pp. 1-4, et seq.**

re: **' :notice: :see claim: :matter # RE 322 398 389 US – See- appended: claim –
executed; declaration: right of claim, with: declaration: averments: – claimant; --
See- appended: Respondent: declaration: stipulations; procurator as respondent; –
Notice of receipt of claim; formal summons waved ' ;
USPO Jan. 15, 2021 to: – Donald-John: Trump – USPO CMN 7008 1830 0002 1028
2082; :James: McConville – CMN 7009 2820 0003 8851 6100; :Mark: Lamb – 7010
1060 0001 7518 9154; and: Paul: Penzone – 7012 2210 0000 4269 7384.**

:CLT, U.S. Atty.-General means: the United States-corp attorney general is also the 'common-
law-trustee' for the United-States-of-America- people.

2022-011769 MISC Page: 1874 of 2782
09/26/2022 03:35:37 PM Receipt #: 22-9381
Rec Fee: \$30.00 Darrell James Hill
Gila County, Az Sadie Jo Bingham, Recorder

Copy

Official

Greetings,

I. DEPRIVATION OF RIGHT TO THE COURT-OF-RECORD

- 1) :i- man am :Darrell-James: Hill, -civilian-beneficiary, -Ohioan, -habitant on Arizona- state See: Gila county Recorder, Doc.# 2017-002378, pp. 1-4, et seq.
- 2) :You are :trustees-under-oath to advantage :i- man- beneficiary under :covenant-agreements to assure the :constitution-protected -unimpeded-access to the 'court-of-record', et al.- Trustee duties and obligations.
- 3) :i- man endure damage to date by the denial of :right to access the Court-of-record on: January 19th, et seq- era until the restoration of this right -:in -property. To wit:
- 4) :Your :clerks at the Maricopa county Court, location: 222 East Javelina Avenue state that :your policy denies :i- man the :unalienable and constitutionally-protected right to access the ':court of record' at the Maricopa county, Arizona state.
- 5) As your policy may have been misapplied to harm (i- man; alternatively,
 - o :i- man wish that :you- Trustees restore the right to the court-of-record' upon the day of this receipt, and place :urgent notice to :i- man that the restoration of :right to the court-of-record is forever-present to :i- man-beneficiary.
 - o By the :covenant-agreement, this January 19th 2021 -denial of :right is the 'Second-level offense', ~ see: Doc.# 2017-002378, p. 21~, where is :penalty for :deprivation of :rights started at: 11:00 am, January 19, 2021, and lasting until the resolve of the matter, with :express- procuration :in the property and penalty- claims.
 - o The first Bill of Particulars will follow upon the end of this month.

II. Trespass Upon The Respondent :in The :Hill- Court Matter

The man- actors- :POTUS and Common-Law-Trustee are notified herein as the :any-harm of the related :constitutional- violation upon them is beyond the covenant- procuration- agreement for the :claim # RE 322 398 389 US.

Without-prejudice

darrell-james Hill Executor
:darrell-james: Hill, - beneficiary - Executor



Affirmed and autographed before me this 22 day January 2021 A.D.
Type of Identification: Arizona Driver License

Cheryl Smith
Notary-Public

SEAL

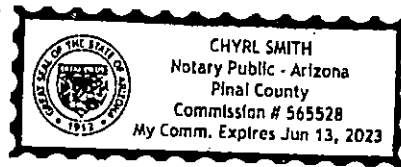

2022-011769 MISC Page: 1875 of 2782
09/26/2022 03:35:37 PM Receipt #: 22-9381
Rec Fee: \$30.00 Darrell James Hill
Gila County, Az, Sadie Jo Bingham, Recorder



Unofficial Copy

1866

APACHE JUNCTION
151 W SUPERSTITION BLVD
APACHE JUNCTION, AZ 85120-9998
(800)275-8777

01/22/2021 10:56 AM

Product	Qty	Unit Price	Price
---------	-----	------------	-------

First-Class Mail® Letter	1		\$0.55
--------------------------	---	--	--------

Phoenix, AZ 85003
Weight: 0 lb 0.50 oz
Estimated Delivery Date
Mon 01/25/2021

Certified Mail® Tracking #:	70092820000395707942	\$3.55
-----------------------------	----------------------	--------

Total	\$4.10
-------	--------

First-Class Mail® Letter	1		\$0.55
--------------------------	---	--	--------

Washington, DC 20530
Weight: 0 lb 0.50 oz
Estimated Delivery Date
Tue 01/26/2021

Certified Mail® Tracking #:	70092820000395708000	\$3.55
-----------------------------	----------------------	--------

Total	\$4.10
-------	--------

First-Class Mail® Letter	1		\$0.55
--------------------------	---	--	--------

Washington, DC 20500
Weight: 0 lb 0.50 oz
Estimated Delivery Date
Tue 01/26/2021

Certified Mail® Tracking #:	70092820000395707997	\$3.55
-----------------------------	----------------------	--------

Total	\$4.10
-------	--------

First-Class Mail® Letter	1		\$0.55
--------------------------	---	--	--------

Phoenix, AZ 85003
Weight: 0 lb 0.40 oz
Estimated Delivery Date
Mon 01/25/2021

Certified Mail® Tracking #:	70092820000395707980	\$3.55
-----------------------------	----------------------	--------

Total	\$4.10
-------	--------

First-Class Mail® Letter	1		\$0.55
--------------------------	---	--	--------

Phoenix, AZ 85003
Weight: 0 lb 0.40 oz
Estimated Delivery Date
Mon 01/25/2021

Certified Mail® Tracking #:	70092820000395707966	\$3.55
-----------------------------	----------------------	--------

Total	\$4.10
-------	--------

First-Class Mail® Letter	1		\$0.55
--------------------------	---	--	--------

Phoenix, AZ 85003
Weight: 0 lb 0.50 oz
Estimated Delivery Date
Mon 01/25/2021

Certified Mail® Tracking #:	70092820000395707973	\$3.55
-----------------------------	----------------------	--------

Total	\$4.10
-------	--------

First-Class Mail® Letter	1		\$0.55
--------------------------	---	--	--------

Phoenix, AZ 85003
Weight: 0 lb 0.50 oz
Estimated Delivery Date
Mon 01/25/2021

Certified Mail® Tracking #:	70092820000395707959	\$3.55
-----------------------------	----------------------	--------

Total	\$4.10
-------	--------

Grand Total:	\$28.70
--------------	---------

CERTIFIED MAIL RECEIPT

(Domestic Mail Only; No Insurance Coverage Provided)

For delivery information visit our website at www.usps.com.

PHOENIX, AZ 85003 OFFICIAL USE

Postage	\$3.55
Certified Fee	\$0.00
Return Receipt Fee (Endorsement Required)	\$0.00
Restricted Delivery Fee (Endorsement Required)	\$0.00
Total Postage & Fees	\$4.10

0130
60
Postmark Here
01/22/2021

Sent To: Paul Penzone
Street, Apt. No., or PO Box No.: 550 West Jackson
City, State, ZIP+4: Phoenix, Arizona 85003

U.S. Postal Service

CERTIFIED MAIL RECEIPT

(Domestic Mail Only; No Insurance Coverage Provided)

For delivery information visit our website at www.usps.com.

PHOENIX, AZ 85003 OFFICIAL USE

Postage	\$3.55
Certified Fee	\$0.00
Return Receipt Fee (Endorsement Required)	\$0.00
Restricted Delivery Fee (Endorsement Required)	\$0.00
Total Postage & Fees	\$4.10

0130
60
Postmark Here
01/22/2021

Sent To: Patricia Galt
Street, Apt. No., or PO Box No.: 201 W. Jefferson St 4th floor
City, State, ZIP+4: Phoenix, AZ 85003

U.S. Postal Service

CERTIFIED MAIL RECEIPT

(Domestic Mail Only; No Insurance Coverage Provided)

For delivery information visit our website at www.usps.com.

PHOENIX, AZ 85003 OFFICIAL USE

Postage	\$3.55
Certified Fee	\$0.00
Return Receipt Fee (Endorsement Required)	\$0.00
Restricted Delivery Fee (Endorsement Required)	\$0.00
Total Postage & Fees	\$4.10

0130
60
Postmark Here
01/22/2021

Sent To: Jeff Fine
Street, Apt. No., or PO Box No.: 622 W. Jackson Street
City, State, ZIP+4: Phoenix, AZ 85003



APACHE JUNCTION
 151 W SUPERSTITION BLVD
 APACHE JUNCTION, AZ 85120-9998
 (800)275-8777

01/22/2021 10:56 AM

Product	Qty	Unit Price	Price
First-Class Mail® Letter	1		\$0.55
Phoenix, AZ 85003			
Weight: 0 lb 0.50 oz			
Estimated Delivery Date			
Mon 01/25/2021			
Certified Mail®			\$3.55
Tracking #:			
70092820000395707942			
Total			\$4.10
First-Class Mail® Letter	1		\$0.55
Washington, DC 20530			
Weight: 0 lb 0.50 oz			
Estimated Delivery Date			
Tue 01/26/2021			
Certified Mail®			\$3.55
Tracking #:			
70092820000395708000			
Total			\$4.10
First-Class Mail® Letter	1		\$0.55
Washington, DC 20500			
Weight: 0 lb 0.50 oz			
Estimated Delivery Date			
Tue 01/26/2021			
Certified Mail®			\$3.55
Tracking #:			
70092820000395707997			
Total			\$4.10
First-Class Mail® Letter	1		\$0.55
Phoenix, AZ 85003			
Weight: 0 lb 0.40 oz			
Estimated Delivery Date			
Mon 01/25/2021			
Certified Mail®			\$3.55
Tracking #:			
70092820000395707980			
Total			\$4.10
First-Class Mail® Letter	1		\$0.55
Phoenix, AZ 85003			
Weight: 0 lb 0.40 oz			
Estimated Delivery Date			
Mon 01/25/2021			
Certified Mail®			\$3.55
Tracking #:			
70092820000395707966			
Total			\$4.10
First-Class Mail® Letter	1		\$0.55
Phoenix, AZ 85003			
Weight: 0 lb 0.50 oz			
Estimated Delivery Date			
Mon 01/25/2021			
Certified Mail®			\$3.55
Tracking #:			
70092820000395707973			
Total			\$4.10
First-Class Mail® Letter	1		\$0.55
Phoenix, AZ 85003			
Weight: 0 lb 0.50 oz			
Estimated Delivery Date			
Mon 01/25/2021			
Certified Mail®			\$3.55
Tracking #:			
70092820000395707959			
Total			\$4.10
Grand Total:			\$28.70

7009 2820 0003 9570 7959

U.S. Postal Service
CERTIFIED MAIL RECEIPT

(Domestic Mail Only; No Insurance Coverage Provided)

For delivery information visit our website at www.usps.com.

Phoenix, AZ 85003
OFFICIAL USE

Postage	\$3.55
Certified Fee	\$8.00
Return Receipt Fee (Endorsement Required)	\$8.00
Restricted Delivery Fee (Endorsement Required)	\$0.00
Total Postage & Fees	\$19.55

0130
60

Postmark Here

01/22/2021

Sent To: Joseph W. Kelly
 Street, Apt. No., or PO Box No. 201 W. Jefferson Street
 City, State, ZIP+4 Phoenix, AZ 85003
 PS Form 3800 August 2005 See Reverse for Instructions

1868



APACHE JUNCTION
151 W SUPERSTITION BLVD
APACHE JUNCTION, AZ 85120-9998
(800)275-8777

Product	Qty	Unit Price	Price
First-Class Mail® Letter	1		\$0.55
Phoenix, AZ 85003 Weight: 0 lb 0.50 oz Estimated Delivery Date Mon 01/25/2021			
Certified Mail®			\$3.55
Tracking #: 70092820000395707942			
Total			\$4.10
First-Class Mail® Letter	1		\$0.55
Washington, DC 20530 Weight: 0 lb 0.50 oz Estimated Delivery Date Tue 01/26/2021			
Certified Mail®			\$3.55
Tracking #: 70092820000395708000			
Total			\$4.10
First-Class Mail® Letter	1		\$0.55
Washington, DC 20500 Weight: 0 lb 0.50 oz Estimated Delivery Date Tue 01/26/2021			
Certified Mail®			\$3.55
Tracking #: 70092820000395707997			
Total			\$4.10
First-Class Mail® Letter	1		\$0.55
Phoenix, AZ 85003 Weight: 0 lb 0.40 oz Estimated Delivery Date Mon 01/25/2021			
Certified Mail®			\$3.55
Tracking #: 70092820000395707980			
Total			\$4.10
First-Class Mail® Letter	1		\$0.55
Phoenix, AZ 85003 Weight: 0 lb 0.40 oz Estimated Delivery Date Mon 01/25/2021			
Certified Mail®			\$3.55
Tracking #: 70092820000395707966			
Total			\$4.10
First-Class Mail® Letter	1		\$0.55
Phoenix, AZ 85003 Weight: 0 lb 0.50 oz Estimated Delivery Date Mon 01/25/2021			
Certified Mail®			\$3.55
Tracking #: 70092820000395707973			
Total			\$4.10
First-Class Mail® Letter	1		\$0.55
Phoenix, AZ 85003 Weight: 0 lb 0.50 oz Estimated Delivery Date Mon 01/25/2021			
Certified Mail®			\$3.55
Tracking #: 70092820000395707959			
Total			\$4.10
Grand Total:			\$28.70

7009 2820 0003 9570 7942

U.S. Postal Service
CERTIFIED MAILTM RECEIPT
(Domestic Mail Only; No Insurance Coverage Provided)

For delivery information visit our website at www.usps.com.

Phoenix, AZ 85003

Postage	\$3.55	0130 60 Postmark Here
Certified Fee	\$0.00	
Return Receipt Fee (Endorsement Required)	\$0.00	
Restricted Delivery Fee (Endorsement Required)	\$0.00	
Total Postage & Fees	\$4.10	

Sent To: Evans: McCarroll
Street, Apt. No., or PO Box No.: 301 W. Jefferson Street
City, State, ZIP+4: Phoenix, AZ 85003

PS Form 3800, August 2006 See Reverse for Instructions

7009 2820 0003 9570 8000

U.S. Postal Service
CERTIFIED MAILTM RECEIPT
(Domestic Mail Only; No Insurance Coverage Provided)

For delivery information visit our website at www.usps.com.

Washington, DC 20530

Postage	\$3.55	0130 60 Postmark Here
Certified Fee	\$0.00	
Return Receipt Fee (Endorsement Required)	\$0.00	
Restricted Delivery Fee (Endorsement Required)	\$0.00	
Total Postage & Fees	\$4.10	

Sent To: Monty: Wilkinson
Street, Apt. No., or PO Box No.: 4500 Pennsylvania Ave NW
City, State, ZIP+4: Washington, DC 20540

PS Form 3800, August 2006 See Reverse for Instructions

7009 2820 0003 9570 7997

U.S. Postal Service
CERTIFIED MAILTM RECEIPT
(Domestic Mail Only; No Insurance Coverage Provided)

For delivery information visit our website at www.usps.com.

Washington, DC 20500

Postage	\$3.55	0130 60 Postmark Here
Certified Fee	\$0.00	
Return Receipt Fee (Endorsement Required)	\$0.00	
Restricted Delivery Fee (Endorsement Required)	\$0.00	
Total Postage & Fees	\$4.10	

Sent To: Joseph-Bibrette: Biden
Street, Apt. No., or PO Box No.: 1100 Pennsylvania Ave NW
City, State, ZIP+4: Washington DC 20540

PS Form 3800, August 2006 See Reverse for Instructions

1869



Darrell-James: Hill, -civilian, -:Executor
PO Box 3806
Apache Junction, Arizona 85117

:man :present; :aggrieved

Arizona state
Pinal county

:-Claim Of :Unalienable-Right :in-accordance With The Covenant-Agreements:

**:i- man- beneficiary Have Endured The :POTUS-Office -Dereliction
Beginning With The Barack-Hussein's Presidency~2016 A.D.~ Unto Now. -
:i- man require :This Must End Now.**

To: Joseph-Robinette: Biden, -:POTUS, et al.- man- actors et seq. -following ~without
enclosures:

:Lloyd-J.: Austin III,
-:Secretary of Defense
1000 Defense Pentagon
Washington, DC 20301-1000

:Monty: Wilkinson,
-:CLT, U.S. Atty.-General'
950 Pennsylvania Avenue, NW
Washington, Dist. Of Columbia 20530-0001

:Mark- A.: Milley, -:General,
-:Chairman of the Joint Chiefs of Staff
9999 Joint Staff Pentagon
Washington, DC 20318-9999

:Joseph: Welty,
-: Maricopa county Judge, -:Chief
201 West Jefferson Street
Phoenix, Arizona 85003

:John- E.: Hyten, -:General,
-:Vice Chairman: Joint Chiefs of Staff
9999 Joint Staff Pentagon
Washington, DC 20318-9999

:David- L.: Norquist,
-:Deputy Secretary of Defense
1010 Defense Pentagon
Washington, DC 20301-1010

:John: Whitley,
-:Acting Secretary of the Army
101 Army Pentagon
Washington, DC 20310-0101

:Lisa: Hershman,
-:Duties, :Chief Management Officer
3030 Defense Pentagon
Washington, DC 20301-3030

:Tom: Harker,
-:Acting Secretary of the Navy
1000 Navy Pentagon
Washington, DC 20350-1000

:Stacy-A.: Cummings,
-:Duties, :Under Secretary of Defense for
Acquisition and Sustainment
3010 Defense Pentagon
Washington, DC 20301-3010

:CLT, U.S. Atty.-General means: the United States-corp attorney general is also the 'common-law-trustee' for the United-States-of-America- people.



:John: Roth,
-:Acting Secretary of the Air Force
1670 Air Force Pentagon
Washington, DC 20330-1670

:Amanda: Dory, -:Duties,
:Under Secretary of Defense for Policy
2000 Defense Pentagon
Washington, DC 20301-2000

:Jack: Sellers, :Dist.- 1,
:Steve: Chucri, :Dist.- 2,
:Bill: Gates, :Dist.- 3,
:Clint: Hickman, :Dist.- 4,
:Steve: Gallardo, :Dist.- 5,
-:Maricopa County Board of
Supervisors
c/o: Fran: McCarroll, -:Clerk
301 West Jefferson Street
Phoenix, Arizona 85003

:Virginia: Penrod,
-:Duties, :Under Secretary of Defense for
Personnel and Readiness
4000 Defense Pentagon
Washington, DC 20301-4000

:Pamela: Gates,
-: Maricopa county Judge, -:Presiding
c/o : Keith: Kaplan, -:Administrator
:Civil Court Administration
201 West Jefferson Street, 4th Floor
Phoenix, Arizona 85003

:Douglas: Glenn,
:Duties, :Under Secretary of Defense
-Comptroller/Chief Financial Officer
1100 Defense Pentagon
Washington, DC 20301-1100

:Paul: Penzone, -:Maricopa county Sheriff
550 West Jackson
Phoenix Arizona state 85003

USPO CMN 7018-0360 0000 5968 6139
:Jeff: Fine, -:Maricopa county Clerk of the Court
620 West Jackson Street
Phoenix, Arizona 85003

c/o :Joseph-Robinette: Biden, -:Trustee, USPO RMN RE 322 398 389 US
1600 Pennsylvania Ave NW
Washington, District of Columbia 20500

RE: Covenant-agreements- Statuses – :in -Procurat²,

- A. 'see claim: :matter # RE 322 398 389 US – executed; declaration: right of claim, with:
declaration: averments: – claimant; -- See- appended: Respondent: declaration:
stipulations; procurator as respondent; – with :Notice of receipt of claim; formal summons
waved' . See: USPO Jan. 15, 2021 to: – Donald-John: Trump – USPO CMN 7008 1830
0002 1028 2082, et al., with ':Notice, and 'common-law – equity' -claim', appended, 25
pages.**
- B. January 19th, 2021- :In timely process for the resolve of these matters has been dilated
~See: 'Deprivation of Right of Access to the 'court-of-record' Costs' ; below: #10 – 13~ by
the Deprivation of the "Right of access' to the people's- 'Court of Record' -venue for to
move the :non-controversy-matter -:claim :before the jury to decide the facts and the law
of the 'out of court- judgment'- matter, # RE 322 398 389 US, at the people's Maricopa**

**2 :Covenant-agreements Statuses :in -Procurat² means: Gila county, Arizona, Recorder,
Doc.# 2017-002378, and:# 2019-009291 ~https://recorder.gilacountyaz.gov/recorder/web/~**

:USPO RMN RE 322 398 389 US , Covenant-agreements- Statuses – :in -Procurat²



county, Arizona, Superior Court facility.

Greetings, congratulations Joseph-Robinette, et al.;

:i- man :darrell-james: Hill, -:Negro, -:civilian, -:Ohioan, -:beneficiary; -:Executor, pray
:you are well, and possess and adhere-to righteous-counsel.

:i- man am full of years, of :stable-mental-capacity, have first-hand knowledge of :all of
the matters addressed herein, and will state same onto the record in the open-court.

1) :i- man empirically know the past :president-office- man-actors, et al., as
thieves condoning the thefts of the :private- property- claimed and possessed
by :i- man.

Why write to :you?

- 2) :i- man write :you-man, et al- man-actor- POTUS now for: to determine whether :you-
man-actors are :honorable, for to determine whether :i- man must now-proceed upon the
:present-POTUS-office- man-actor- status of :Dishonor³.
- 3) As :i- man stand ready to resolve this matter, you **must** respond quickly, for hereafter :i-
man must assign the status of :Dishonor -:onto the office of the POTUS, which you now
are under oath, duty and obligation anew ~ :January 20th, 2021 A.D.
- 4) :you- man -Joseph-Robinette, et al., inherited the 2017 A.D. - formal- :dishonor :upon
the previous- man- actor-Trustees :in-office, specifically, :man-actor- Donald-John: Trump, et al.-
Barack-Hussein: Obama, et seq.- man-actors -Loretta: Lynch, -:U.S. Atty General/common-law-
Trustee, et al.- unto William-Pelham: Barr, who severally and together -in :Trustee-dereliction
are responsible for the condoned crime in the theft of the private-property- claimed, possessed
and owned by :i- man- beneficiary.
 - a) The :Property theft :in-violation of all-Law exceeds the jurisdiction of the office.
 - b) The man-actors- Trustees presently :in-office do now administer-agreements
implementing harms upon :i- man- beneficiary.
 - c) The 'voidance of benefit'- scam/policy and/or theft enduring at this autographing daily
damages :i- man- beneficiary.
- 5) This 'voidance of benefit'- scam is overt theft and overt-damage upon :i- man forcing
absolute-dereliction unto :i- man's death, which-ever is later. This is cruel Trustee-dereliction
which now daily harms :i- man while with :remedy acquiesced-to, stipulated to and agreed-upon
in the covenant-agreements.

Action required- :i- man wish all of the property restored now, none else.

**Hill- U.S.-Corp.- POTUS- Contract
Under The Covenant-agreements**

6) :Man- actor- U.S.-corp.-officials :Donald-John, et al.- Barack Hussein, et seq.-
Loretta...unto :William-Pelham, -:US-AG and CLT, -Trustee- derelicts are so by the stealing of

3 :Dishonor means: of ;no-moral/commercial-worth: not right, not just, not true. See: Gila County,
Arizona, Recorder: Doc. # 2019_009291, pp. 746- 751, 824- 832.
~<https://recorder.gilacountyaz.gov/recorder/web/>~.

:USPO RMN RE 322 398 389 US , Covenant-agreements- Statures – :in -Procuration

3 / 5

1872

the private-property -claimed and possessed belonging to :i- man. :In- accordance with the **covenant-agreements: PE**, and Lots: One, Two, Three and Four, the property- 'deprivation-penalty' payment is required until all proper7ty is restored :in -specie.

Action required- :i- man wish the cease and desist :all '-voidance of benefit' -practices now.

Action required- :i- man wish :all of the property restored now.

Action required- :i- man wish :all of the deprivation-penalties due here-to-fore paid now.

Law of the Covenant-agreements

7) The 'Declaration of Independence of 1776 A.D.', 'DOI-1776-A.D.'; 'The Constitution for the United States of America of 1787 A.D.'; the Emancipation Proclamation of 1863 A.D. , 'EP-1863-A.D.', and the Lieber Code of 1863 A.D. set in stone the prevailing law. By the --

8) :Emergency Banking Act of 1933 - 2003 A.D., 'EBA-1933-2003-A.D.'; the U.S.-Corp self-indentured with debenture to :i- man. ~ **Specific demand has been made to the dishonorable :POTUS- Trustee- Derelict -Donald-John, et al. -man-actors, for to account, settle and close :all accounts of :i- man- beneficiary and to restore :all of property to :i- man⁴. -** - :In the typical 'voidance of benefit' -harm; the man-actors, et al.- :POTUS agreed while implementing the 'voidance of benefit' scam/policy that now daily harms :i- man. This :matter is now-to-after within :your, et al.'s honorable-office in the administration and use benefit to and for :i- man -beneficiary, -:Darrell-James- Hill, covenantor.

9) The **International Covenant of Civil and Political Rights**, ':ICCPR-1992-A.D.'¹⁵ details :i- man's compliance within the covenant- agreements/executed that :you- man- actor-Joseph-Robinette swore :in-oath to assure and ensure the :restoration of all property, and: payment of the deprivation-penalties, in precisely this situation.

Deprivation of Right of Access to the 'court-of-record' Costs

10) The :**Maricopa court- clerk-policy:-in- action supersedes all-Law to wholly deny :i- man-executor's unalienable and constitution-protected-right to the '-:court-of-record' at the Phoenix, Arizona Superior-court -venue.** :Their:-action trespasses upon the matter.

11) :Their -:system assures and ensures ':man-executor- deprivation-of-access to the 'court-of-record' unless jurisdiction is usurped :in-violation of the ICCPR-1992-A.D., et al. This may be a common practice in the Arizona -state. This wrong-doing has been directed to the Maricopa county Superior court Clerk and Chief judge, et al.- :Paul, the sheriff has been notified⁶. To wit:

4 :to account, settle and close :all accounts of :i- man- beneficiary and to restore :all of property to :i- man means: 1) June-2020 A.D. "Presentment of the Specialty Negotiable Instrument: 'Priority-Creditor for: Equity-Claim for :property- :Presentment to: Donald-John: Trump, -:Trustee, et seq.' - to:Mark-Alexander: Miley~ USPS RMN RE 047 610 512 US~, :Steven-Turner: Mnuchin~USPS CMN 7008 1300 0002 2256 4705~, and :William-Pelham: Barr~USPS RE 047 610 438 US~. May-2020 A.D. 2) May-2020 A.D. 'Equity-Claim :Presentment: Express Trust: Emergency Banking Act of 1933 A.D. - Trust, USPS RE 047 610 440 US ... ' by: USPS RE 047 610 440 US to: Donald-John: Trump- Trustee.

5 :**International Covenant of Civil and Political Rights**, ':ICCPR-1992-A.D.' means: Gila county, Arizona, Recorder: Doc.# 2017-006522; 'Affidavit: Proof Of Claim: Declaration In Claim Against Criminal Wrong-Doings By State Party Agents Of The Untied State' - Department Of Justice, "DOJ, And Of The 9th Circuit Court Administration' - Gila county,Arizona, Recorder: Doc. # 2017_006522, pp. 25- 31. ~<https://recorder.gilacountyaz.gov/recorder/web/~>

:**Maricopa county Superior court Clerk and Chief judge, et al.- :Paul, the sheriff has been notified** means: 1) See: Greetings: Donald-John, et al., James_Charles, et al., Mark and

:USPO RMN RE 322 398 389 US , Covenant-agreements- Statuses - :in -Procuration

4 / 5

2022-011769 MISC Page: 1882 of 2782

09/26/2022 03:35:37 PM Receipt #: 22-9381

Reg Fee: \$30.00 Darrell James Hill

Gila County, AZ, Sadia Jo Blinsham, Recorder



12) On the day 19th of January, 2021; 11:00 a.m., I-man in accordance with the Hill- U.S. Corp. -prevailing covenant-agreements, standing as the executor-man-claimant and as the man-respondent in- procuracy in-law, did present the private-claim for to move the matter before the jury deciding the facts and the law of the covenant-agreements in -non-controversy in the Hill-court at the said venue.

13) I-man have no authority in- procuracy for you- man, -POTUS, beyond the specific limits to ascertain the right of remedy to the Claimant, for: a) the restoration of the property in-specie, and b) the demand and receipt of the deprivation-penalty per the covenant-agreements.

Action required- I-man wish you -Joseph-Robinette, et al. to in-honor assure and ensure that I-man-beneficiary's all-rights -executed are now secured and forever protected to the full capacity of the United States Constitution. See: ICCPR-1992-A.D; Law of the Covenant-agreements- rights to remedy (# 7, above).

Enclosure: 'Greetings: Donald-John, et al., James Charles, et al., Mark and Paul, et al. with matter # RE 322 398 389 US' to: Donald-John: Trump, et al. ~USPO CMN 7008 1830, 0002 1028 2082~; James-Charles: McConville- Trustee, et al. ~ USPO 7009 2820 0003 8851 6100~; Mark: Lamb ~USPO 7010 1060 0001 7518 9154~; Paul: Penzone~USPO CMN 7012 2210 0000 4269 7384~:appended: page 1 of the Enclosure..with 'Notice, and 'common-law - equity' -claim', appended, 25 pages.

Respectfully,
Without-prejudice

Darrell James Hill, Executor
Darrell James Hill, Beneficiary, -Executor;
man- Claimant; man- procurator in- honor.

Affirmed and autographed before me this 20 day January 2021 A.D.
Type of Identification: Arizona Driver License

[Signature]
Notary-Public



of-record' -- USPO -CMN 7009 2820 0003 9570 7973 ~ to: Joseph-Robinette~ and USPO CMN 7009 2820 0003 9570 8000 ~ to: Monty: Wilkinson.

:USPO RMN RE 322 398 389 US , Covenant-agreements- Statuses - in -Procuracy

5 / 5

2022-011769 MISC Page: 1883 of 2782
09/26/2022 09:35:37 PM Receipt #: 22-9381
Rec Fee: \$30.00 Darrell James Hill
Gila County, Az, Sadie Jo Bingham, Recorder



Registered No. RE322398389US



APACHE JUNCTION
151 W SUPERSTITION BLVD
APACHE JUNCTION, AZ 85120-9998
(800)275-8777

01/28/2021 11:40 AM

Product	Qty	Unit Price	Price
---------	-----	------------	-------

First-Class Mail® Package	1		\$5.20
---------------------------	---	--	--------

Washington, DC 20500
Weight: 0 lb 7.30 oz
Estimated Delivery Date
Mon 02/01/2021

Registered Mail®			\$13.50
------------------	--	--	---------

Amount: \$21.00
Tracking #: RE322398389US

Return Receipt			\$2.85
----------------	--	--	--------

Total	9590 9402 4718 8344 9800 86		\$21.55
-------	-----------------------------	--	---------

First-Class Mail® Letter	1		\$0.75
--------------------------	---	--	--------

Phoenix, AZ 85003
Weight: 0 lb 1.10 oz

Estimated Delivery Date
Mon 02/01/2021

Certified Mail®			\$3.60
-----------------	--	--	--------

Tracking #: 70180360000059686139

Return Receipt			\$2.85
----------------	--	--	--------

Total	9590 9402 4718 8344 9800 79		\$7.20
-------	-----------------------------	--	--------

Garden Corsage	16		\$12.00
----------------	----	--	---------

Grand Total:			\$40.75
--------------	--	--	---------

Cash			\$40.75
------	--	--	---------

USPS is experiencing temporary volume

To Be Completed By Post Office	
Reg. Fee	\$5.20
Handling Charge	\$13.50
Postage	\$2.85
Received by	\$0.00
Return Receipt	
Restricted Delivery	
	\$21.55

OFFICIAL USE

APACHE JUNCTION, AZ 85120

FROM: Darrell James Hill
PO Box 3806
Apache Junction, Arizona 85117

TO: Joseph Robinette Biden - Trustee
1600 West Jackson Street
Washington, Dist of Columbia 20500

PS Form 3806, Receipt for Registered Mail Copy 1 - Customer
May 2007 (7530-02-000-9051) (See Information on Reverse)
For domestic delivery information, visit our website at www.usps.com®

COMPLETE THIS SECTION ON DELIVERY

A. Signature Agent Addressee

B. Received by (Printed Name) Date of Delivery

C. Is delivery address different from item 1? Yes No

D. If YES, enter delivery address below:

RECEIVED

3. Service Type

Priority Mail Express®
 Registered Mail™
 Adult Signature Restricted Delivery
 Certified Mail®
 Certified Mail Restricted Delivery
 Collect on Delivery
 Insured Mail™ (over \$500)
 Signature Confirmation™
 Restricted Delivery

SENDER: COMPLETE THIS SECTION

1. Article Addressed to:

Joseph Robinette Biden
1600 West Jackson Street
Washington, Dist of Columbia 20500

2. Article Number (Transfer from service label)
RE 322 398 389 US

3. Article Number (Transfer from service label)
9590 9402 4718 8344 9800 86

PS Form 3811, July 2015 PSN 7530-02-000-9053

U.S. Postal Service™
CERTIFIED MAIL® RECEIPT
Domestic Mail Only

For delivery information, visit our website at www.usps.com®

Phoenix, AZ 85003

OFFICIAL USE

Certified Mail Fee	\$3.60
Extra Services & Fees (check box, add fee as appropriate)	\$2.85
<input type="checkbox"/> Return Receipt (hardcopy)	\$0.00
<input type="checkbox"/> Return Receipt (electronic)	\$0.00
<input type="checkbox"/> Certified Mail Restricted Delivery	\$0.00
<input type="checkbox"/> Adult Signature Required	\$0.00
<input type="checkbox"/> Adult Signature Restricted Delivery	\$0.00
Postage	\$0.75
Total Postage and Fees	\$7.20

Sent To: Jeff Frie - Trustee
Street and Apt. No., or PO Box No.: 620 West Jackson Street
City, State, ZIP+4: Phoenix, Arizona 85003

Postmark Here: 01/28/2021

PS Form 3800, April 2015 PSN 7530-02-000-9047 See Reverse for Instructions

2022-011769 MISC Page: 1884 of 2782
09/26/2022 03:35:37 PM Receipt #: 22-9381
Rec Fee: \$30.00 Darrell James Hill
Gila County, AZ, Sadie Jo Bingham, Recorder

USPS Tracking®

FAQs >

Track Another Package +

Tracking Number: RE322398389US

Remove X

Your item was delivered at 3:58 am on February 25, 2021 in WASHINGTON, DC 20500.

✓ Delivered

February 25, 2021 at 3:58 am
WASHINGTON, DC 20500

Get Updates ▾

Feedback

Text & Email Updates ▾

Tracking History ▾

February 25, 2021, 3:58 am

Delivered

WASHINGTON, DC 20500

Your item was delivered at 3:58 am on February 25, 2021 in WASHINGTON, DC 20500.

February 17, 2021, 2:27 am

Arrived at Post Office

WASHINGTON, DC 20066

February 3, 2021

In Transit to Next Facility

1876

2022-011769 MISC Page: 1885 of 2782

09/26/2022 03:36:37 PM Receipt #: 22-9381

Rec Fee: \$30.00 Darrell James Hill

Gila County, Az, Sadie Jo Bingham, Recorder



Registered No. RE322398389US



APACHE JUNCTION
151 W SUPERSTITION BLVD
APACHE JUNCTION, AZ 85120-9998
(800)275-8777

01/28/2021 11:40 AM

Product	Qty	Unit Price	Price
First-Class Mail® Package	1		\$5.20
Registered Mail®			\$13.50
Return-Receipt			\$2.85
Letter	1		\$0.75
Certified Mail®			\$3.60
Garden Corsage	16		\$12.00
Total			\$21.55
Grand Total:			\$40.75
Cash			\$40.75

Washington, DC 20500
Weight: 0 lb 7.30 oz
Estimated Delivery Date
Mon 02/01/2021

Registered Mail® Amount: \$21.00
Tracking #: RE322398389US

Return-Receipt Tracking #: 9590 9402 4718 8344 9800 86

Total \$21.55

First-Class Mail® Letter \$0.75

Phoenix, AZ 85003
Weight: 0 lb 1.10 oz
Estimated Delivery Date
Mon 02/01/2021

Certified Mail® Tracking #: 70180360000059686139

Return-Receipt Tracking #: 9590 9402 4718 8344 9800 79

Total \$7.20

Garden Corsage 16 \$12.00

Grand Total: \$40.75

Cash \$40.75

USPS is experiencing temporary volume

Reg. Fee	\$5.20	
Handling Charge	\$13.50	Return Receipt
Postage	\$2.85	Restricted Delivery
Received by	\$0.00	
		\$21.55
Customer Must Declare Full Value	\$31.00	Domestic Insurance \$25,000
Indemnity is limited. (See Reverse).		

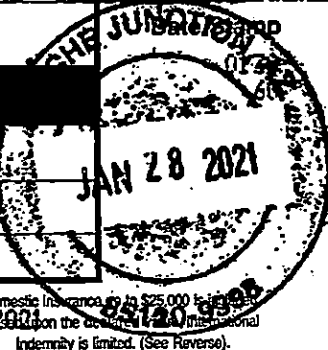

OFFICIAL USE

FROM: APACHE JUNCTION, AZ 85120
Durrell James Hill
PO Box 3806
Apache Junction, Arizona 85117

TO: Joseph Robinette Biden - Senator
1600 Pennsylvania Ave NW
Washington, Dist of Columbia 20500

PS Form 3806, Receipt for Registered Mail Copy 1 - Customer
May 2007 (7530-02-000-9051) (See Information on Reverse)
For domestic delivery information, visit our website at www.usps.com®

COMPLETE THIS SECTION ON DELIVERY

A. Signature Agent Addressee
B. Received by (Printed Name) Erin Ruffin 2/1/21
C. Date of Delivery 2/1/21
D. Is delivery address different from item 17? Yes No
If YES, enter delivery address below:

Service Type

Priority Mail Express®
 Adult Signature
 Registered Mail™
 Certified Mail®
 Collect on Delivery
 Insured Mail™ (over \$500)

Registered Mail Restricted Delivery
 Return Receipt for Merchandise
 Signature Confirmation™
 Signature Confirmation Restricted Delivery

SENDER: COMPLETE THIS SECTION

1. Article Addressed to:
Jeff Fine, COC
620 West Jackson St
Phoenix, Ariz 85003

2. Article Number (transfer from service label)
7018 0360 0000 5968 6139

PS Form 3811, July 2015 PSN 7530-02-000-9059

U.S. Postal Service™
CERTIFIED MAIL® RECEIPT
Domestic Mail Only

For delivery information, visit our website at www.usps.com™

Phoenix, AZ 85003

OFFICIAL USE

Certified Mail Fee	\$3.60	0130
Extra Services & Fees (check box, add fee to postage)	\$2.85	60
<input type="checkbox"/> Return Receipt (hardcopy)	\$0.00	
<input type="checkbox"/> Return Receipt (electronic)	\$0.00	
<input type="checkbox"/> Certified Mail Restricted Delivery	\$0.00	
<input type="checkbox"/> Adult Signature Required	\$0.00	
<input type="checkbox"/> Adult Signature Restricted Delivery	\$0.00	
Postage	\$0.75	
Total Postage and Fees	\$7.20	

Sent to: Jeff Fine - Senator
Street and Apt. No. of PO Box No: 620 West Jackson Street
City, State, ZIP+4: Phoenix, Arizona 85003

PS Form 3800, April 2015 PSN 7530-02-000-9047 See Reverse for Instructions

2022-011769 MISC
09/26/2022 03:35:37 PM
Rec Fee: \$30.00
Gila County, Az, Sadie Jo Bingham, Recorder

Page: 1886 of 2782
Receipt #: 22-9381
Darrell James Hill



FAQs >

Track Another Package +

Tracking Number: 70180360000059686139

Remove X

Your item was delivered to an individual at the address at 9:02 am on January 30, 2021 in PHOENIX, AZ 85003.

✓ Delivered, Left with Individual

January 30, 2021 at 9:02 am
PHOENIX, AZ 85003

Get Updates ▾

Feedback

Text & Email Updates ▾

Tracking History ▴

January 30, 2021, 9:02 am
Delivered, Left with Individual
PHOENIX, AZ 85003

Your item was delivered to an individual at the address at 9:02 am on January 30, 2021 in PHOENIX, AZ 85003.

January 30, 2021, 7:40 am
Out for Delivery
PHOENIX, AZ 85003

January 30, 2021, 7:29 am
Arrived at Post Office

1878

2022-011769 MISC Page: 1887 of 2782
09/26/2022 03:35:37 PM Receipt #: 22-9381
Rec Fee: \$30.00 Darrell James Hill
Gila County, Az, Sadie Jo Bingham, Recorder



To: Joseph-Robinette: 70091410000078685734 – Deny :U.S.-Corp. to 'state' -people statuses

1 / 3

Darrell-James: Hill¹-civilian, -:Executor, -:Kinsman-Redeemer
PO Box 3806
Apache Junction, Arizona 85117

:man :present; -:Ohioan

Arizona state
Pinal county

**:i- man -:sole and kinsman-redeemer- :declaration:
:2021 February 4th: Authority For :U.S.-Corp'-:Trustee- Government-Services-Provider,
'gsp', -:Trustee: EBA-1933-A.D., To Ascend By Any-Means To The Entity-Status
Equivalency of Man-Kind: Organic-State, Subrogation or Fictional, Or A :Like
-Presumption Status,
Is Here-To-Fore And Now-To After Denied.**

To: Joseph-Robinette: Biden², -:POTUS³, et al.- man- actors et seq.
c/o :Joseph-Robinette: Biden, -:Trustee⁴, USPS CMN 7009 1410 0000 7868 5734
600 Pennsylvania Ave NW
Washington, District of Columbia 20500

**Mark-Alexander -:General United States Army-:Chairman: CJCOS- :Milley,
:John-Earl, -:General United States Air Force: Vice- CJCOS- :Hyten,
:James-Charles, -:General United States Army: COS Army- :McConville,
:David-Hilberry, -:General United States Marine Corps: CMC- :Berger,
:Michael-Martin, -:Admiral United States Navy: CNO- :Gilday,
:David-Lee, -:General United States air Force: COS AF- :Goldfein,
:John-William, -:General United States Space Force: CSO- :Raymond,
:Joseph-Lauren, -:General United States Air Force: CNG- :Lengyel
:Karl-Leo, -:Admiral United States Coast Guard: CCG- :Schultz
c/o :Mark-Alexander: Milley, -:Trustee : USPO RE 322 398 295 US
9999 Joint Staff Pentagon
Washington, Columbia Territory [D.C.- 20318-9999]**

- 1 :Darrell-James: Hill means: :Covenant-agreements Statuses :in -Procuration means: Gila county, Arizona, Recorder, Doc.# 2017-002378, pp. 1- ; et seq.~ #2017-00652, #2018-005176, #2019-009291, #2019-011722;~ <https://recorder.gilacountyaz.gov/recorder/web/>
- 2 Joseph-Robinette: Biden, -:POTUS, et al.- man- actors et seq. means: See: :USPO RMN RE 322 398 389 US , Covenant-agreements- Statuses – :in -Procuration.
- 3 :POTUS means: office- status is :in- :Dishonor-2017-A.D. Ibid 2. SEE: USPO RMN RE 322 398 389 US : 'Claim of :-Unalienable-Right :in-accordance With The Covenant-Agreements:.... .'; sent: January 28, 2021, 11:33 a.m.
- 4 :Trustee means: under legislative-oath, duty and obligation to assure and ensure advantage and use- benefit of the EBA-1933-A.D- legislative-dry-trust is disposed to the 'United States of America'- people- beneficiary-individual upon execution:-in -exercise of the ANY:-beneficiary-right to remedy.

To: Joseph-Robinette: 70091410000078685734 – Deny :U.S.-Corp. to 'state' -people statuses

1 / 3

2022-011769 MISC Page: 1888 of 2782

09/26/2022 03:35:37 PM Receipt #: 22-9381
Rec Fee: \$30.00 Darrell James Hill
Gila County, Az, Sadie Jo Bingham, Recorder



1879

Re: **FORMAL-DENIAL –**

:Derived-Authority, for the government-services-provider -:in-fiction, et seq.~ :self-indentured-: EBA-1933-A.D.-Trustee to :debentured- :i- man, et al.- Darrell-James: Hill, -:kinsman- redeemer of :Negro-Ysrael, Ysrael and Holy Church~ :in- accordance with the covenant-agreement⁵ is DENIED.

:Trespassing upon the delimit is an offense with willful-damage upon :i- man -:sole and kinsman-redeemer, subject to procuration⁶ :in- accordance with the covenant-agreement⁷.

Greetings :Joseph-Robinette, :Mark-Alexander; et al.:

:i- man, sole, and as kinsman redeemer, appreciate your righteous-service to the beneficiary, -'United States of America'- people.

:Non-authorization for the 'UNITED STATES-CORP'- Trustee: government-services-provider ~:self-indentured -legislative-Trustee of: EBA-1933-A.D.⁸~, ascendancy to :i- man-status is with the right to :remedy for the offense by :procuration~ agreement⁹

Authority: :i- man-Darrell-James: Hill, -:sole and kinsman-redeemer¹⁰

A. :i- man -Darrell-James: Hill, -:Negro, -:inherent-beneficiary by:Almighty-God; -:civilian, -:Ohioan; debentured-beneficiary: EBA-1933-A.D., for :i- man -:sole and kinsman-redeemer for **:all- Negro-Ysrael, Ysrael and the Holy-Church, and, for all, except** the individual- soul-journeyor by the express-behest, am;

B. :i- man -ambassador of the Almighty-God am :Trustee: Concession-1213-A.D. by the

5 **:covenant-agreements** means: **:covenant-agreement(s), et al.** means: under the :Almighty-God – :1776 A.D.-People Constitution: Declaration of Independence; 1777 A.D. States' Constitution: Articles of Confederacy, 1787-1789 A.D.: 'The Constitution for the United States of America', -:non-incorporated: :permissions, duty, obligations and limitations- 'in - service to and for the United States of America -people by :standard- guarantee of the republican form of government'

6 **:Procuration** means: Ibid 1. for the recovery of damages.

7 **:covenant-agreement** means: Ibid 1. by the right of the 'political-election' -right is :executed

8 **:EBA-1933-A.D.** means: the Emergency Banking Act of 1933, -2003 legislative 'dry-trust' is over **:i- man -:sole ~wish for right of separation-account, settle and closure is executed~ and :kinsman-redeemer -demand for :right of separation executed for Negro-Ysrael, Ysrael an Holy-Church.**

9 **:covenant-agreement(s), et al.** means: **:Covenant-agreements Statuses :in -Procuration** means: Ibid 1, 2, 3, 5, 6, 7, . ~<https://recorder.gilacountyaz.gov/recorder/web/>~

10 **:kinsman-redeemer** means: for: ..., **all except the civilly-alive at their express-behest, am[;]** that **':Express-assumpsit'** is to inundertake ones' own responsibility and liability in this matter is NOT restricted :in -individual-~spirit, soul and flesh~ choice :in -civil-alive- status.

Page: 1889 of 2782

MISC

2022-011769

09/26/2022 03:35:37 PM

Rec. Fee: \$30.00

Darrell James Hill, Recorder
Gila County, Az, Sadie Jo Bingham



1880



To: Joseph-Robinette: 70091410000078685734 - Deny :U.S.-Corp. to :state -people statuses

grace of the Most High God and father of our Messiah Yushuah by covenant-agreements¹¹
:Knowledge: For the any-type of 'government-service-organization -self-ascendancy to :i-
man-status' however promulgated ~also including proffer by the propaganda, legislation,
-executive-order, or otherwise, notwithstanding~ for the tacit-acquiescence by :i- man, et al, is
now formally **denied**.

:Cause: For the issue of this Knowledge, the :any-proffer for ascendancy by any mean is
wholly- DENIED by this binding covenant. - :In this matter delimit, damage, procuration for the
right of :remedy is set.

:Action-Required: :i- man sole, and as :kinsman-redeemer, desire and require :in-office, et
al.- :man-actors', et seq.- TRUSTEES' :any -proffer for, to or unto :ascendance to the organic-
state -status to the union of the 'United States of America' -people by any means is ceased,
desisted now at this autographing, and shall forever be :willful-damage -criminal-trespassing.

1. :Trespassing in this matter is with the willful-offense -admitted -damage upon :i- man,
-;sole and :kinsman-redeemer, subject to :procuration by the PE of the kinsman-
redeemer¹².

Any- :you- man- actors- :in-office trespassing with the procuration under the PE of
:kinsman-redeemer for each individual soul-journer under the harm is now accountable to the
intervenor: principals, agents and proxies, severally also including :man- actors :in- and :office
of any institutions: ecclesiastical and non-ecclesiastical.- 'United-States-Corp'- gsp, -:Trustee:
EBA-1933-A.D., et seq., understanding the :covenant-agreements- all¹³.

**Notice to the man-actor- PRINCIPAL is sufficient notice to the man-actor-AGENT; Notice
to the man-actor-AGENT must be reported to the man-actor-PRINCIPAL.**

Without-prejudice

Darrell-James Hill, Executor
:Darrell-James: Hill, Executor; -:Kinsman-Redeemer

Affirmed and autographed before me this 05 day, February 2021 A.D.

Cheryl Smith
Notary-Public

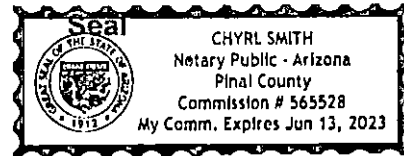

11 :covenant-agreement(s), et al. means: by :God to : Adam and Eve, et seq.- to :Noah, to :Shem,
to: Jacob/Ysrael, to :i- man, son of :Clarence and Ora, children of :Jacob/Ysrael. Ibid 1

12 :PE of the kinsman-redeemer means: Ibid 1.

13 :covenant-agreements means: Ibid 1, 2, 3, 5, 6, 7, 8, 9, 11, 12.



APACHE JUNCTION
151 W SUPERSTITION BLVD
APACHE JUNCTION, AZ 85120-9998
(800)275-8777

02/05/2021 12:55 PM

Product	Qty	Unit Price	Price
---------	-----	------------	-------

First-Class Mail® Letter	1		\$0.55
Washington, DC 20500 Weight: 0 lb 0.60 oz Estimated Delivery Date Tue 02/09/2021			
Certified Mail®			\$3.60
Tracking #:			
7009141000078685734			
e-Return Receipt			\$1.75
Total			\$5.90

First-Class Mail® Letter	1		\$0.55
Washington, DC 20318 Weight: 0 lb 1.00 oz Estimated Delivery Date Tue 02/09/2021			
Registered Mail®			\$13.50
Amount: \$21.00			
Tracking #:			
RE322398313US			
Return Receipt			\$2.85
Tracking #:			
9590 9402 4718 8344 9800 93			
Total			\$16.90

Grand Total!:

Cash Change

U.S. Postal ServiceTM
CERTIFIED MAILTM RECEIPT
(Domestic Mail Only; No Insurance Coverage Provided)

For delivery information visit our website at www.usps.com

7009 1410 0000 7868 5734

OFFICIAL USE

APACHE JUNCTION, AZ 85120-9998

Postage \$3.60

Certified Fee 1.75

Return Receipt Fee (Endorsement Required) 0.00

Restricted Delivery Fee (Endorsement Required) 0.00

Total Postage & Fees \$5.35

02/05/2021

7009141000078685734

Sept. to: Mark Alexander Miley

Street, Apt. No. or PO Box No. 9999 Joint State Pentagon

City, State, ZIP+4 Washington, Columbia Territory D.C. 20318-9999

PS Form 3806, August 2006 See Reverse for Instructions

Registered No. RE322398313US

Date Stamp FEB 05 2021

To Be Completed By Post Office	Postage \$	Extra Services & Fees (continued)
	\$0.55	
Registered Mail \$	\$13.50	<input type="checkbox"/> Signature Confirmation
Return Receipt (hardcopy) \$	\$2.85	<input type="checkbox"/> Signature Confirmation Restricted Delivery
Return Receipt (electronic) \$	\$0.00	
Restricted Delivery \$		
		Total Postage & Fees \$16.90

Customer Must Declare Full Value \$21.00

Received by 02/05/2021

Domestic Mail Item up to \$50,000 is included based upon the declared value. International Mail is limited (see Reverse).

OFFICIAL USE

APACHE JUNCTION, AZ 85120

FROM: Darrell James Hill
PO Box 3806
Apache Junction, Arizona 85117

TO: Mark Alexander Miley
9999 Joint State Pentagon
Washington, Columbia Territory
D.C. 20318-9999

PS Form 3806, Registered Mail Receipt
April 2015, PSN 7530-02-000-9051
For domestic delivery information, visit our website at www.usps.com

Copy 1 - Customer
(See Information on Reverse)

Unofficial

1882

USPS Tracking®

[FAQs >](#)

Track Another Package +

Tracking Number: 70091410000078685734

[Remove X](#)

Your item was delivered at 3:41 am on February 16, 2021 in WASHINGTON, DC 20500.

Delivered

February 16, 2021 at 3:41 am
WASHINGTON, DC 20500

Get Updates ▾

Feedback

- Text & Email Updates** ▾
- Return Receipt Electronic** ▾
- Tracking History** ▲

February 16, 2021, 3:41 am

Delivered

WASHINGTON, DC 20500

Your item was delivered at 3:41 am on February 16, 2021 in WASHINGTON, DC 20500.

February 11, 2021, 10:42 am

Available for Pickup

WASHINGTON, DC 20500

1883

February 11, 2021, 8:49 am

2022-011769 MISC Page: 1892 of 2782
 09/28/2022 03:35:37 PM Receipt #: 22-9381
 Rec Fee: \$30.00 Darrell James Hill
 Gila County, Az, Sadie Jo Bingham, Recorder



USPS Tracking®

[FAQs >](#)

Track Another Package +

Tracking Number: RE322398313US

Remove X

Your item was delivered at 6:44 am on February 24, 2021 in WASHINGTON, DC 20310.

Delivered

February 24, 2021 at 6:44 am
WASHINGTON, DC 20310

Get Updates ▾

Feedback

Text & Email Updates ▾

Tracking History ▴

February 24, 2021, 6:44 am

Delivered

WASHINGTON, DC 20310

Your item was delivered at 6:44 am on February 24, 2021 in WASHINGTON, DC 20310.

February 17, 2021, 1:51 am

Arrived at Post Office

WASHINGTON, DC 20066

February 14, 2021

In Transit to Next Facility

1884

2022-011769 MISC Page: 1893 of 2782
09/26/2022 03:35:37 PM Receipt #: 22-9381
Rec Fee: \$30.00 Darrell James Hill
Gila County, Az, Sadie Jo Bingham, Recorder



Darrell-James: Hill, -civilian, -:Executor
PO Box 3806
Apache Junction, Arizona 85117

RECEIVED

JAN 27 2021

2:00 am/pm

By: E. Castillo

:man :present,

Arizona state
Pinal county

USPO CMN 7009 2820 0003 9570 7942

:Jack: Sellers, :Dist.- 1,
:Steve: Chucri, :Dist.- 2,
:Bill: Gates, :Dist.- 3,
:Clint: Hickman, :Dist.- 4,
:Steve: Gallardo, :Dist.- 5,
:Maricopa County Board of Supervisors
c/o: Fran: McCarroll, -:Clerk
301 West Jefferson Street
Phoenix, Arizona 85003

7009 2820 0003 9570 7959

:Joseph: Welty, -: Maricopa county Judge, -:Chief
201 West Jefferson Street
Phoenix, Arizona 85003

7009 2820 0003 9570 7966

:Pamela: Gates, -: Maricopa county Judge,
-:Presiding
c/o: Keith: Kaplan, -:Administrator
:Civil Court Administration
201 West Jefferson Street, 4th Floor
Phoenix, Arizona 85003

7009 2820 0003 9570 7973

:Jeff: Fine, -:Maricopa county Clerk of the Court
620 West Jackson Street
Phoenix, Arizona 85003

7009 2820 0003 9570 7980

:Paul: Penzone, -:Maricopa county Sheriff
550 West Jackson
Phoenix Arizona state 85003

7009 2820 0003 9570 7997

:Joseph-Robinette: Biden, -:POTUS
1600 Pennsylvania Ave NW
Washington, District of Columbia 20500

7009 2820 0003 9570 8000

:Monty: Wilkinson, -:CLT, U.S. Atty.-General
950 Pennsylvania Avenue, NW
Washington, Dist. Of Columbia 20530-0001

RE: A **January 19th, 2021- Deprivation of Rights to the Court of Record for
:claim: :matter # RE 322 398 389 US at the Maricopa county Court;
the Second Level Offense :in Accordance with the Covenant-agreement in the
Election: See: Gila county Recorder, Doc.# 2017-002378, pp. 1-4, et seq.**

re: **' :notice: :see claim: :matter # RE 322 398 389 US – See- appended: claim --
executed; declaration: right of claim, with: declaration: averments: – claimant; --
See- appended: Respondent: declaration: stipulations; procurator as respondent; –
Notice of receipt of claim; formal summons waved ' ;
USPO Jan. 15, 2021 to: – Donald-John: Trump – USPO CMN 7008 1830 0002 1028
2082; :James: McConville – CMN 7009 2820 0003 8851 6100; :Mark: Lamb – 7010
1060 0001 7518 9154; and: Paul: Penzone – 7012 2210 0000 4269 7384.**

1 **:CLT, U.S. Atty.-General means: the United States-~~com~~ attorney general is also the 'common-
law-trustee' for the United-States-of-America- peop**

2022-011769 MISC Page: 1894 of 2782
09/26/2022 03:35:37 PM Receipt #: 22-9381
Rec Fee: \$30.00 Darrell James Hill
Gila County, Az, Sadie Jo Bingham, Recorder



Greetings,

I. DEPRIVATION OF RIGHT TO THE COURT-OF-RECORD

- 1) :i- man am :Darrell-James: Hill, -civilian-beneficiary, -Ohioan, -habitant on Arizona- state See: Gila county Recorder, Doc.# 2017-002378, pp. 1-4, et seq.
- 2) :You are :trustees-under-oath to advantage :i- man- beneficiary under :covenant-agreements to assure the :constitution-protected -unimpeded-access to the 'court-of-record', et al.- Trustee duties and obligations.
- 3) :i- man endure damage to date by the denial of :right to access the Court-of-record on: January 19th, et seq- era until the restoration of this right -:in -property. To wit:
- 4) :Your :clerks at the Maricopa county Court, location: 222 East Javelina Avenue state that :your policy denies :i- man the :unalienable and constitutionally-protected right to access the ':court of record' at the Maricopa county, Arizona state.
- 5) As your policy may have been misapplied to harm :i- man; alternatively,
 - o :i- man wish that :you- Trustees restore the right to the court-of-record' upon the day of this receipt, and place :urgent notice to :i- man that the restoration of :right to the court-of-record is forever-present to :i- man-beneficiary.
 - o By the :covenant-agreement, this January 19th 2021 -denial of :right is the 'Second-level offense', ~ see: Doc.# 2017-002378, p. 21~, where is :penalty for :deprivation of :rights started at: 11:00 am, January 19, 2021, and lasting until the resolve of the matter, with :express- procuration :in the property and penalty- claims.
 - o The first Bill of Particulars will follow upon the end of this month.

II. Trespass Upon The Respondent in The :Hill- Court Matter

The man- actors- :POTUS and Common-Law-Trustee are notified herein as the :any-harm of the related :constitutional- violation upon them is beyond the covenant- procuration- agreement for the :claim # RE 322 398 389 US.

Without-prejudice

darrell-james Hill Executor
:darrell-james: Hill, - beneficiary - Executor



Affirmed and autographed before me this 22 day January 2021 A.D.
Type of Identification: Arizona Driver License

Cheryl Smith
Notary-Public

SEAL

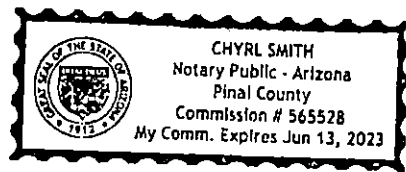

2022-011769 MISC Page: 1895 of 2782
09/26/2022 03:35:37 PM Receipt #: 22-9381
Rec Fee: \$30.00 Darrell James Hill
Gila County, Az, Sadie Jo Bingham, Recorder



Unofficial Copy

1886

Darrell-James: Hill, -civilian, -:Executor
PO Box 3806
Apache Junction, Arizona 85117

RECEIVED

FEB 04 2021

By: 8:30 @wpm
F. CASTILLO

:man :present; :aggrieved

Arizona state
Pinal county

-:Claim Of :Unalienable-Right :in-accordance With The Covenant-Agreements:

:i- man- beneficiary Have Endured The :POTUS-Office -Dereliction
Beginning With The Barack-Hussein's Presidency~2016 A.D.~ Unto Now. -
:i- man require :This Must End Now.

To: Joseph-Robinette: Biden, -:POTUS, et al.- man- actors et seq. -following:

:Lloyd-J.: Austin III,
-:Secretary of Defense
1000 Defense Pentagon
Washington, DC 20301-1000

:Monty: Wilkinson,
-:CLT, U.S. Atty.-General'
950 Pennsylvania Avenue, NW
Washington, Dist. Of Columbia 20530-0001

:Mark- A.: Milley, -:General,
-:Chairman of the Joint Chiefs of Staff
9999 Joint Staff Pentagon
Washington, DC 20318-9999

:Joseph: Welty,
-: Maricopa county Judge, -:Chief
201 West Jefferson Street
Phoenix, Arizona .85003

:John- E.: Hyten, -:General,
-:Vice Chairman: Joint Chiefs of Staff
9999 Joint Staff Pentagon
Washington, DC 20318-9999

:David- L.: Norquist,
-:Deputy Secretary of Defense
1010 Defense Pentagon
Washington, DC 20301-1010

John: Whitley,
:Acting Secretary of the Army
101 Army Pentagon
Washington, DC 20310-0101

:Lisa: Hershman,
-:Duties, :Chief Management Officer
3030 Defense Pentagon
Washington, DC 20301-3030

Tom: Harker,
:Acting Secretary of the Navy
1000 Navy Pentagon
Washington, DC 20350-1000

:Stacy-A.: Cummings,
-:Duties, :Under Secretary of Defense for
Acquisition and Sustainment
3010 Defense Pentagon
Washington, DC 20301-3010

John: Roth,
:Acting Secretary of the Air Force
670 Air Force Pentagon
Washington, DC 20330-1670

:Pamela: Gates,
-: Maricopa county Judge, -:Presiding
c/o : Keith: Kaplan, -:Administrator
:Civil Court Administration

:CLT, U.S. Atty.-General means: the United States-corp attorney general is also the 'common-law-trustee' for the United-States-of-America- people.

:USPO RMN RE 322 398 389 US , Covenant-agreements- Statutes - :in -Procuration

1 / 5

2022-011769 MISC Page: 1896 of 2782

09/26/2022 03:35:37 PM Receipt #: 22-9381
Darrell James Hill Recorder
Gila County, Az, Saddle Jo Bingham



:Amanda: Dory, :-Duties, ..
:Under Secretary of Defense for Policy
2000 Defense Pentagon
Washington, DC 20301-2000

:Jack: Sellers, :Dist.- 1,
:Steve: Chucri, :Dist.- 2,
:Bill: Gates, :Dist.- 3,
:Clint: Hickman, :Dist.- 4,
:Steve: Gallardo, :Dist.- 5,
:-Maricopa County Board of Supervisors
c/o: Fran: McCarroll, :-Clerk
301 West Jefferson Street
Phoenix, Arizona 85003

:Virginia: Penrod,
:-Duties, :Under Secretary of Defense for
Personnel and Readiness
4000 Defense Pentagon
Washington, DC 20301-4000

201 West Jefferson Street, 4th Floor
Phoenix, Arizona 85003
:Douglas: Glenn,
:Duties, :Under Secretary of Defense
-Comptroller/Chief Financial Officer
1100 Defense Pentagon
Washington, DC 20301-1100

:Pamela: Gates,
-: Maricopa county Judge, :-Presiding
c/o : Keith: Kaplan, :-Administrator
:Civil Court Administration
201 West Jefferson Street, 4th Floor
Phoenix, Arizona 85003

:Paul: Penzone, :-Maricopa county Sheriff
550 West Jackson
Phoenix Arizona state 85003

USPO CMN 7018 0360 0000 5968 6139
:Jeff: Fine, :-Maricopa county Clerk of the Court,
620 West Jackson Street
Phoenix, Arizona 85003

c/o **:Joseph-Robinette: Biden, :-Trustee, USPO RMN RE 322 398 389 US**
1600 Pennsylvania Ave NW
Washington, District of Columbia 20500

RE: Covenant-agreements- Statuses – :in -Procuration²,

- A. 'see claim: :matter # RE 322 398 389 US – executed; declaration: right of claim, with: declaration: averments: – claimant; – See- appended: Respondent: declaration: stipulations; procurator as respondent; – with :Notice of receipt of claim; formal summons waved . See: USPO Jan. 15, 2021 to: – Donald-John: Trump – USPO CMN 7008 1830 0002 1028 2082, et al., with ':Notice, and 'common-law – equity' -claim', **appended, 25 pages.**
- B. **January 19th, 2021- :in timely process for the resolve of these matters has been dilated**
~See: 'Deprivation of Right of Access to the 'court-of-record' Costs' ; below: #10 – 13~ by the Deprivation of the "Right of access' to the people's- ':Court of Record' -venue for to move the :non-controversy-matter -:claim :before the jury to decide the facts and the law of the 'out of court- judgment'- matter, # RE 322 398 389 US, at the people's Maricopa county, Arizona, Superior Court facility.

2 **:Covenant-agreements Statuses :in -Procuration** means: Gila county, Arizona, Recorder, Doc.# 2017-002378, and:# 2019-009291 ~<https://recorder.gilacountyaz.gov/recorder/web/~>

:USPO RMN RE 322 398 389 US , Covenant-agreements- Statuses – :in -Procuration

2 / 5

2022-011769 MISC Page: 1897 of 2762

09/28/2022 03:35:37 PM Receipt #: 22-9381
James Hill
Darrrell James Hill
Rec Fee: \$30.00 Sadie Jo Bingham, Recorder
Gila County, AZ

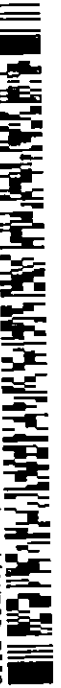

Greetings, congratulations Joseph-Robinette, et al.;

:i- man :darrell-james: Hill, -:Negro, -:civilian, -:Ohioan, -:beneficiary; -:Executor, pray
:you are well, and possess and adhere-to righteous-counsel.

:i- man am full of years, of :stable-mental-capacity, have first-hand knowledge of :all of
the matters addressed herein, and will state same onto the record in the open-court.

1) :i- man empirically know the past :president-office- man-actors, et al., as
thieves condoning the thefts of the :private- property- claimed and possessed
by :i- man.

Why write to :you?

- 2) :i- man write :you-man, et al- man-actor- POTUS now for: to determine whether :you-
man-actors are :honorable, to determine whether :i- man must now-proceed upon the
:present-POTUS-office- man-actor- status of :Dishonor³.
- 3) As :i- man stand ready to resolve this matter, you **must** respond quickly, for hereafter :i-
man must assign the status of :Dishonor -:onto the office of the POTUS, which you now
are under oath, duty and obligation anew ~ :January 20th, 2021 A.D.
- 4) :you- man -Joseph-Robinette, et al., inherited the 2017 A.D. - formal- :dishonor :upon
the previous- man- actor-Trustees :in-office, specifically, :man-actor- Donald-John: Trump, et al.-
Barack-Hussein: Obama, et seq.- man-actors -Loretta: Lynch, -:U.S. Atty General/common-law-
Trustee, et al.- unto William-Pelham: Barr, who severally and together -in :Trustee-derelection
are responsible for the condoned crime in the theft of the private-property- claimed, possessed
and owned by :i- man- beneficiary.
 - a) The :Property theft :in-violation of all-Law exceeds the jurisdiction of the office.
 - b) The man-actors- Trustees presently :in-office do now administer-agreements
implementing harms upon :i- man- beneficiary.
 - c) The :'voidance of benefit'- scam/policy and/or theft enduring at this autographing daily
damages :i- man- beneficiary.
 - d) This 'voidance of benefit'- scam is overt theft and overt-damage upon :i- man forcing
absolute-derelection unto :i- man's death, which-ever is later. This is cruel Trustee-derelection
which now daily harms :i- man while with :remedy acquiesced-to, stipulated to and agreed-upon
in the covenant-agreements.

Action required- :i- man wish all of the property restored now, none else.

**Hill- U.S.-Corp.- POTUS- Contract
Under The Covenant-agreements**

) :Man- actor- U.S.-corp.-officials :Donald-John, et al.- Barack Hussein, et seq.-
Loretta...unto :William-Pelham, -:US-AG and CLT, -Trustee- derelicts are so by the stealing of
the private-property- claimed and possessed belonging to :i- man. :In- accordance with the
covenant-agreements: PE, and Lots: One, Two, Three and Four, the property- 'deprivation-
penalty' payment is required until all proper7ty is restored :in -specie.

:Dishonor means: of ;no-moral/commercial-worth: not right, not just, not true. See: Gila County,
Arizona, Recorder: Doc. # 2019_009291, pp. 746- 751, 824- 832.
~<https://recorder.gilacountyaz.gov/recorder/web/>~.

:USPO RMN RE 322 398 389 US , Covenant-agreements- Statuses – :in -Procuration

2022-011769 MISC Page: 1898 of 2782
 09/26/2022 03:35:37 PM Receipt #: 22-9381
 Darrell James Hill
 Rec Fee: \$30.00 Sadie Jo Bingham, Recorder
 Gila County, AZ



Action required- :i- man wish the cease and desist :all -'voidance of benefit' -practices now.
Action required- :i- man wish :all of the property restored now.
Action required- :i- man wish :all of the deprivation-penalties due here-to-fore paid now.

Law of the Covenant-agreements

7) The 'Declaration of Independence of 1776 A.D.', 'DOI-1776-A.D.'; 'The Constitution for the United States of America of 1787 A.D.'; the Emancipation Proclamation of 1863 A.D., 'EP-1863-A.D.', and the Lieber Code of 1863 A.D. set in stone the prevailing law. By the --

8) :Emergency Banking Act of 1933 - 2003 A.D., 'EBA-1933-2003-A.D.'; the U.S.-Corp self-indentured with debenture to :i- man. ~ **Specific demand has been made to the dishonorable :POTUS- Trustee- Derelict -Donald-John, et al. -man-actors, for to account, settle and close :all accounts of :i- man- beneficiary and to restore :all of property to :i- man⁴.** -- :In the typical 'voidance of benefit' -harm, the man-actors, et al.- :POTUS agreed while implementing the 'voidance of benefit' scam/policy that now daily harms :i- man. This :matter is now-to-after within :your, et al.'s honorable-office in the administration and use benefit to and for :i- man -beneficiary, -.Darrell-James- Hill, covenantor.

9) The **International Covenant of Civil and Political Rights**, ':ICCPR-1992-A.D.'¹⁵ details :i- man's compliance within the covenant-agreements executed that :you- man- actor-Joseph-Robinette swore :in-oath to assure and ensure the :restoration of all property, and: payment of the deprivation-penalties, in precisely this situation.

Deprivation of Right of Access to the 'court-of-record' Costs

10) The **:Maricopa court- clerk-policy-:in- action supersedes all-Law to wholly deny :i- man-executor's unalienable and constitution-protected-right to the '-:court-of-record' at the Phoenix, Arizona Superior-court -venue.** :Their-action trespasses upon the matter.

11) :Their -:system assures and ensures 'man-executor- deprivation-of-access to the 'court-of-record' unless jurisdiction is usurped in-violation of the ICCPR-1992-A.D., et al. This may be a common practice in the Arizona -state. This wrong-doing has been directed to the Maricopa county Superior court Clerk and Chief judge, et al.- :Paul, the sheriff has been notified⁶. To wit:

4 :to account, settle and close :all accounts of :i- man- beneficiary and to restore :all of property to :i- man means: 1) June-2020 A.D. "Presentment of the Specialty Negotiable Instrument: 'Priority-Creditor for: Equity-Claim for :property- :Presentment to: Donald-John: Trump, -:Trustee, et seq' - to:Mark-Alexander: Miley~ USPS RMN RE 047 610 512 US~, :Steven-Turner: Minuchin~USPS CMN 7008 1300 0002 2256 4705~, and :William-Pelham: Barr~USPS RE 047 610 438 US~. May-2020 A.D. 2) **May-2020 A.D. 'Equity-Claim** :Presentment: Express Trust: Emergency Banking Act of 1933 A.D. - Trust, USPS RE 047 610 440 US ... ' by: USPS RE 047 610 440 US to: Donald-John: Trump- Trustee. :**International Covenant of Civil and Political Rights, ':ICCPR-1992-A.D.'** means: Gila county, Arizona, Recorder: Doc.# 2017-006522; 'Affidavit: Proof Of Claim: Declaration In Claim Against Criminal Wrong-Doings By State Party Agents Of The United State' -- Department Of Justice, "DOJ, And Of The 9th Circuit Court Administration" -- Gila county,Arizona, Recorder: Doc. # 2017_006522, pp. 25- 31. ~<https://recorder.gilacountyaz.gov/recorder/web/>~ :**Maricopa county Superior court Clerk and Chief judge, et al.- :Paul, the sheriff has been notified** means: 1) See: **Greetings: Donald-John, et al., James Charles, et al., Mark and Paul, et al. with :matter # RE 322 398 389 US** ~ Donald-John ~USPO CMN 7008 1830 0002 1028 2082~; James-Charles: McConville- Trustee~ USPO 7009 2820 0003 8851 6100~; Mark: Lamb ~USPO 7010 1060 0001 7518 9154~; Paul: Penzone~USPO CMN 7012 2210 0000 4269 7384~: appended: page 1 of the Enclosure.; 2) '**Unwarranted- Deprivation of Right to 'court-**

:USPO RMN RE 322 398 389 US , Covenant-agreements- Statutes -- :in -Procuration

2022-011769 MISC Page: 1899 of 2782
09/25/2022 03:35:37 PM Receipt #: 22-9381
Darrell James Hill
Gila County, Az, Sadie Jb Bingham, Recorder



12) On the day 19th of January, 2021; 11:00 a.m., I, in accordance with the Hill- U.S.- Corp. -prevailing covenant-agreements, standing as the executor-man-claimant and as the man-respondent in- procuracy in-law, did present the private-claim for to move the matter before the jury deciding the facts and the law of the covenant-agreements in non-controversy in the Hill-court at the said venue.

13) I, man have no authority in- procuracy for you- man, -POTUS, beyond the specific limits to ascertain the right of remedy to the Claimant, for: a) the restoration of the property in- specie, and b) the demand and receipt of the deprivation-penalty per the covenant-agreements.

Action required- I, man wish you -Joseph-Robinette, et al. to in-honor assure and ensure that I, man-beneficiary's all-rights -executed are now secured and forever protected to the full capacity of the United States Constitution. See: ICCPR-1992-A.D; Law of the Covenant-agreements- rights to remedy (# 7, above).

Enclosure: 'Greetings: Donald-John, et al., James Charles, et al., Mark and Paul, et al. with matter # RE 322 398 389 US' to, Donald-John: Trump, et al. ~USPO CMN 7008 1830, 0002 1028 2082~; James-Charles: McConville- Trustee, et al. ~ USPO 7009 2820 0003 8851 6100~; Mark: Lamb ~USPO 7010 1060 0001 7518 9154~; Paul: Penzone~USPO CMN 7012 2210 0000 4269 7384~: appended: page 1 of the Enclosure..with 'Notice, and 'common-law - equity' -claim', appended, 25 pages.

Respectfully,
Without-prejudice

Darrell James Hill, Executor

Darrell-James: Hill, beneficiary, -Executor,
man- Claimant; man- procurator in- honor.

Affirmed and autographed before me this 20 day January 2021 A.D.
Type of Identification: Arizona Driver License

Notary Public



of-record' ~ USPO -CMN 7009 2820 0003 9570 7973 ~ to: Joseph-Robinette~ and USPO CMN 7009 2820 0003 9570 8000 ~ to: Monty: Wilkinson.

:USPO RMN RE 322 398 389 US', Covenant-agreements- Statutes - in -Procuracy 5 / 5

2022-011769 MISC Page: 1900 of 2782

09/26/2022 03:35:37 PM Receipt #: 22-9381

Rec Fee: \$30.00 Darrell James Hill
Gila County, Az, Sadie Jo Bingham, Recorder



Mail Code: _____

Clerk of the Superior Court
Maricopa County
620 W. Jackson
Phoenix, Arizona 85003

RETURN SERVICE REQUESTED

DARRELL JAMES HILL
PO BOX 3806
APACHE JUNCTION, ARIZONA 85117

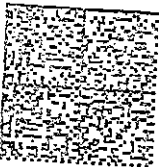

U.S. POSTAGE & METS
ZIP 85003 \$0007.10
02 1M
0001403012 FEB 16 2021

ES117841377808

2022-011769 MISC Page: 1901 of 2782
09/26/2022 03:35:37 PM Receipt #: 22-9381
Rec Fee: \$30.00 Darrell James Hill
Gila County, Az, Sadie Jo Bingham, Recorder



Copy

Official

2681

**CLERK OF THE SUPERIOR COURT
MARICOPA COUNTY**

Downtown Justice Center
620 West Jackson Street, Suite 3052
Phoenix, Arizona 85003

602-37-CLERK (25375)
Fax - 602-506-7684

February 11, 2021

Regular U.S. Mail

Darrell James Hill
PO Box 3806
Apache Junction, Arizona 85117

Re: Return of Documents Submitted

Mr. Hill:

The Clerk of the Superior Court in Maricopa County, hereinafter referred to as "Clerk's Office," received the enclosed documents and after a cursory review of the documents, the documents are being returned because it does not appear that the documents relate to any matter before the Maricopa County Superior Court, nor do they relate to any matter or issue that involves the Clerk's Office.

The Clerk's Office functions as the official record-keeper for documents related to a case or matter before the Superior Court. If these enclosed documents are meant to be pleadings to be submitted into a specific case before the Court, the documents would need to conform with applicable rules of procedure, including state and local rules of procedure, for the filing of documents into a case. Depending on the case type, different rules apply. These documents do not conform with any of those rules.

Regards,

Jessica J. Fotinos
General Counsel and Public Information Officer

1898B
2022-011769 MISC Page: 1902 of 2782
09/26/2022 03:35:37 PM Receipt #: 22-9381
Rec Fee: \$30.00 Darrell James Hill
Gila County, Az, Sadie Jo Bingham, Recorder

www.clerkofcourt.maricopa.gov



AFFIDAVIT

I, Darrell James Hill, affirm that to the best of my ability the copies of the following documents enclosed are accurate and truthful, and are reported delivered as indicated:

Item	Date Issued	Discussion	Document	Recipient	Delivery Data	Notes
Item 1:	June 2012	Class Attorney Instruction: Support Position and Status Statements	Position and Status Statements to Class Attorney Samson (Phoenix)	Johnson, et al. v. AzHHA, et al., Class Attorney Mark Samson, Phoenix, Arizona	USPO CMN: 7008 1830 0002 1030 0038 Accepted: June 29, 2012	See Enclosure 1: Position Statement, Dec. 2011 See Encl 2: Status Statement, June 2012
Item 1: Encl. 1	Dec. 2011	Position Statement	Position Statement	John R. Davis, RG2 Claims Administration, Philadelphia, Pennsylvania	USPO CMN: 7001 0470 0002 1606 2151 Accepted: December 21, 2011	See Item 3, Encl. 1: Demand Letter, Denial of Withholding Authority
Item 1: Encl. 1 Art. 1		Position Statement	Mailing and Acceptance Information	John R. Davis, RG2 Claims Administration, Philadelphia, Pennsylvania	USPO CMN: 7001 0470 0002 1606 2151 Accepted: December 21, 2011	Mailing and Acceptance Information
Item	Date Issued	Discussion	Document	Recipient	Delivery Data	Notes
Item 1: Encl. 2	June 2012	Status Statement	Affidavit of Citizenship, Domicile, and Tax Status, June 2012	John R. Davis, RG2 Claims Administration, Philadelphia, Pennsylvania	USPO CMN: 7011 0470 0002 1606 2168 Accepted: June 25, 2012	See Item 3, Enclosure 2: Affidavit

[Handwritten signature]

DOCH 361076

11/27/2012 04:15 PM Page: 1 of 183
AFF R: \$10.00 J. C. Sloan, Mokinley County

Affidavit: Hill Darrell James

2022-011769 MISC Page: 1903 of 2782
09/26/2022 03:35:37 PM Receipt #: 22-9361
Rec Fee: \$30.00 Darrell James Hill
Gila County, Az, Sadie Jo Bingham, Recorder



DOCH 361061

11/27/2012 01:09 PM Page: 1 of 178
AFF R: \$10.00 J. C. Sloan, Mokinley County



7681

[Handwritten signature]

AFFIDAVIT

Item 1: Encl. 2 Art. 1		Affidavit of Citizenship, Domicile, and Tax Status, June 2012	Mailing and Acceptance Information	John R. Davis, RG2 Claims Administration, Philadelphia, Pennsylvania	USPO CMN: 7011 0470 0002 1606 2168 Accepted: June 25, 2012	Mailing and Acceptance Information
Item 1: Encl. 3	June 2012	Class Attorney Instruction: Support Position and Status Statements	Mailing and Acceptance Information	Class Attorney Mark Samson, Phoenix, Arizona	USPO CMN: 7008 1830 0002 1030 0038 Accepted: June 29, 2012	Mailing and Acceptance Information
Item	Date Issued	Discussion	Document	Recipient	Delivery Data	Notes
Item 2:	Oct. 2012	Reiteration of Position and Status, Class Attorney Instructions re: SSA Rescission, RG2 Claims	Class Member and spouse American Citizen Status Statements	Class Attorney Mark Samson, Phoenix, Arizona	USPO CMN: 7010 1060-0001 7518 9147 Accepted: Oct. 9, 2012	See Encl. A <u>Notice of Default</u> upon Commissioner of SS re: Command upon Commissioner of SSA re: 2006 Rescission of SSA association Demand by husband and wife.
Item 2: Encl. A	Aug. 2012	<u>Notice of Default</u> by Commissioner of SSA	<u>Notice of Default</u> upon Commissioner of SSA	Commissioner John Astrue c/o President Barack Obama	USPO CMN: 7009 2820 0003 8851 6155 Accepted: Sept. 21, 2012	(McKinley County, New Mexico, DOC# 360413)
Item 2: Encl. A Art. 1	Aug. 2012	<u>Notice of Default</u> upon Commissioner of SSA	Mailing and Acceptance Information	Commissioner John Astrue c/o President Barack Obama	USPO CMN: 7009 2820 0003 8851 6155 Accepted: Sept. 21, 2012	(McKinley County, New Mexico, DOC# 360413)

DOC# 361076

11/27/2012 04:15 PM Page: 2 of 183
AFF R:\$10.00 J. C. Sloan, McKinley County

Page: 1904 of 2782

2022-011769 MISC
09/26/2022 09:36:37 PM
Rec Fee: \$30.00 Darrell James Hill
Gila County, Az, Sadie Jo Bingham, Recorder

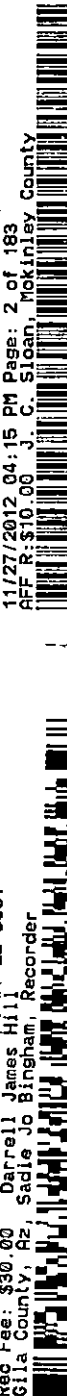

AFFIDAVIT

Item 2: Encl. B		Reiteration of Position and Status re: SSA Rescission	Mailing and Acceptance Information	Class Attorney Mark Samson, Phoenix, Arizona	USPO CMN: 7010 1060 0001 7518 9147 Accepted: Oct. 9, 2012	Mailing and Acceptance Information
Item 3:	Oct. 2012	Status Statements (of Class Member and Spouse) to Commissioner of SSA c/o President Barack Obama	Affidavit of Citizenship, Domicile, and Tax Status (from each spouse), October 2012	John Astrue, Commissioner, SSA c/o President Barack Obama	USPO RMN: RE 430 969 752 US Accepted: October 19, 2012	Answer Commissioner's request: TEH2A/ 129010X8: Oct. 1, 2012 Filings by husband and wife.
Item 3: Encl. 1			Commissioner's TEH2A/ 129010X8: Oct. 1, 2012	Hill Darrell James and Romero-Hill Beverly Jean	Oct. 1, 2012 (document date)	
Item	Date Issued	Discussion	Document	Recipient	Delivery Data	Notes
Item 3: Encl. 2	Oct. 2012	Affidavit: Status Statement	Affidavit of Citizenship, Domicile, and Tax Status (from each spouse), October 2012	John Astrue, Commissioner, SSA c/o President Barack Obama	USPO RMN: RE 430 969 752 US Accepted: October 19, 2012	
Item	Date Issued	Discussion	Document	Recipient	Delivery Data	Notes
Item 3: Encl. 3	Oct. 2012	Affidavits of Citizenship, Domicile, and Tax Status,	Mailing and Acceptance Information	John Astrue, Commissioner, SSA c/o President Barack Obama	USPO RMN: RE 430 969 752 US Accepted: October 19, 2012	Mailing and Acceptance Information

DOCH 361076
11/27/2012 04:15 PM Page: 3 of 188
AFF R: \$10.00 J. C. Sloan, McKinley County

2022-011769 MISC Page: 1905 of 2782
09/26/2022 03:35:37 PM Receipt #: 22-9381
Rec Fee: \$30.00 Darrell James Hill
Gila County, AZ; Sadie Jo Bingham, Recorder

AFFIDAVIT

		October 2012				
Item 4:	Oct. 2012	Class Attorney(s) Corroborating Willful Fraud Against Class Member	Response regarding Sorensen Oct. 31, 2012 FedEx letter, TRK #201, 5366 8192 2909	Johnson, et al. v. AzHHA, et al., Class Attorney David Sorensen, Philadelphia, Pennsylvania	USPO CMN: 7009 2820 0003 8851 6179 Accepted: October 19, 2012	Affidavit of Citizenship, Domicile, and Tax Status, October 2012
Item 4: Encl. A			Sorensen Oct. 31, 2012 FedEx letter, TRK #201, 5366 8192 2909	Johnson, et al. v. AzHHA, et al., Class Member Hill Darrell James	October 31, 2012 (document date)	
Item	Date Issued	Discussion	Document	Recipient	Delivery Data	Notes
Item 4: Encl. B		Affidavit: Status Statement, Response to Commissioner SSA	Affidavit of Citizenship, Domicile, and Tax Status, October 2012	(John Astrue, Commissioner, SSA c/o President Barack Obama)	USPO CMN: 7009 2820 0003 8851 6179 Accepted: October 19, 2012	
Item 4: Encl. C	Oct. 2012	Response regarding Sorensen Oct. 31, 2012 FedEx letter, TRK #201, 5366 8192 2909	Mailing and Acceptance Information	Class Attorney David Sorensen, Philadelphia, Pennsylvania	USPO CMN: 7009 2820 0003 8851 6179 Accepted: October 19, 2012	Mailing and Acceptance Information
Item	Date Issued	Discussion	Document	Recipient	Delivery Data	Notes
Item 5:	Nov.	Class	Class Attorney	Johnson, et al. v.	November 8, 2012	

Affidavit: Hill Darrell James

November 2012

DOCH 361061

11/27/2012 01:09 PM Page: 4 of 178
AFF R:\$10.00 J. C. Sloan, Mckinley County



2022-011769 MISC Page: 1906 of 2782

09/26/2022 03:35:37 PM Receipt #: 22-9381
Rec Fee: \$30.00 Darrell James Hill
Gila County, Az, Sadie Jo Bingham, Recorder



DOCH 361076

11/27/2012 04:15 PM Page: 4 of 183
AFF R:\$10.00 J. C. Sloan, Mckinley County



AFFIDAVIT

	2012	Attorney(s) Corroborating Willful Fraud Against Class Member	David Sorensen, Philadelphia, Pennsylvania Nov. 7, 2012, FedEx letter, TRK #201, 5366 8192 3342	AzHHA, et al., Class Member Darrell James, Hill	(document date)	
Item 6:	Nov. 2012	Response and Reiteration: Complaint of Class Attorney Willful Fraud Against Class Member	Complaint of Class Attorney(s) Sorensen Corroborating Willful Fraud Against Class Member	Johnson, et al. v. AzHHA, et al., Class Attorney David Sorensen c/o Harold Berger (Managing Shareholder- Berger and Montague, P.C.) Philadelphia, Pennsylvania cc: Mark Samson, Class Attorney	USPO CMN: 7010 1670 0001 1601 2344 Accepted: Nov. 19, 2012	
Item	Date Issued	Discussion	Document	Recipient	Delivery Data	Notes
Item 6: Encl. 1	Nov. 2012	Response and Reiteration: Complaint of Class Attorney Willful Fraud Against Class Member	Mailing and Acceptance Information)	Johnson, et al. v. AzHHA, et al., Class Attorney David Sorensen c/o Harold Berger (Managing Shareholder- Berger and Montague, P.C.) Philadelphia, Pennsylvania cc: Mark Samson, Class Attorney	USPO CMN: 7010 1670 0001 1601 2344 Accepted: Nov. 19, 2012	Mailing and Acceptanc Information

Affidavit: Hill Darrell James

November 2012

DOCH 361061

11/27/2012 01:09 PM Page: 5 of 178
AFF R: \$10.00 J. C. Sloan, Mckinley County

2022-011769 MISC Page: 1907 of 2782
09/26/2022 03:35:37 PM Receipt #: 22-9381
Rec Fee: \$30.00 Darrell James Hill
61a County, Az, Sadie Jo Bingham, Recorder

DOCH 361076

11/27/2012 04:16 PM Page: 5 of 183
AFF R: \$10.00 J. C. Sloan, Mckinley County

AFFIDAVIT

Item 7:	Nov. 2012		John R. Davis/ RG2 document	Darrell James, Hill	FedEx TRK# 0215, 8005 2316 6974); received on November 26, 2012, (2 pages)	Document response to June 2012 document; Item 1 above.
---------	-----------	--	-----------------------------	---------------------	--	--

Darrell James Hill
 Darrell James, Hill
 Sovereign Citizen of the united States of America

Notary Public Certification

BEFORE ME, the undersigned authority, a Notary Public, of the County of MCKINLEY, Republic of New Mexico (statename), this 27 day of NOVEMBER, 2012, Darrell James, Hill, the above signed man did appear and was identified by driver's license, and who, upon first being duly affirmed, deposes and says that the foregoing asseveration is true to th best of his knowledge and belief.

I certify under PENALTY OF PERJURY under the laws of the state of New Mexico that the foregoing paragraph is true and correct.

WITNESS my hand and official seal.

Jrene Becenti

My Commission Expires On: JUNE 30, 2015

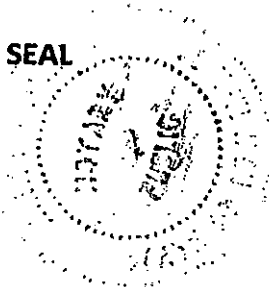

Affidavit: Hill Darrell James November 2012

DOCH 361076
 11/27/2012 04:15 PM Page: 6 of 183
 AFF R:\$10.00 J. C. Sloan, McKinley County

2022-011769 MISC Page: 1908 of 2782
 09/26/2022 03:35:37 PM Receipt #: 22-9381
 Reg Fee: \$30.00 Darrell James Hill
 Gila County, Az; Sadie Jo Bingham, Recorder

DOCH 361061
 11/27/2012 01:09 PM Page: 6 of 178
 AFF R:\$10.00 J. C. Sloan, McKinley County

0061

Unofficial Copy

DOCH 361076

11/27/2012 04:15 PM Page: 7 of 183
AFF R:\$10.00 J. C. Sloan, McKinley County



Item No. 1

June 2012

Class Attorney Instruction: Support Position and Status Statements
Position and Status Statements to Class Attorney Samson (Phoenix)
Johnson, et al. v. AzHHA, et al., Class Attorney Mark Samson, Phoenix, Arizona
USPO CMN: 7008 1830 0002 1030 0038

Accepted: June 29, 2012

See Enclosure 1: Position Statement, Dec. 2011

See Encl 2: Status Statement, June 2012

2022-011769 MISC Page: 1909 of 2782
09/26/2022 03:35:37 PM Receipt #: 22-9381
Rec Fee: \$30.00 Darrell James Hill
Gila County, Az, Sadie Jo Bingham, Recorder



DOCH 361061

11/27/2012 01:09 PM Page: 7 of 178
AFF R:\$10.00 J. C. Sloan, McKinley County



Darrell James, Hill

28 Hilltop Court, HC 61, Box 771, Ramah, N. Mex. [87321] (505)783.2499

CMN 7008 1830 0002 1030 01

(602) 248-0088

www.kellerrohrback.com

Mark Samson

Keller Rohrback, P.L.C.

3101 North Central Avenue

Suite 1400

Phoenix, AZ 85012

RE: (1) Class member is a Social Security Administration (SSA) NON-volunteer; claimant rescinded the SSA system association in since 2006 in accordance with applicable law and regulations (See RG2 Claims correspondences #1 and #2 attached; (2) See the "Affidavit of Citizenship, Domicile and Tax Status" within RG2 correspondence #2

My name is Darrell James, Hill; I am a class member, Claimant ID#: AZA000000930, within the JOHNSON, ET AL. V. ARIZONA HOSPITAL & HEALTHCARE ASSOCIATION, ET AL. UNITED STATES DISTRICT COURT CASE NO. 07-CV-1292-SRB (D. Az.).

This is my first correspondence on this small matter. I sent RG2 claims two withholding restrictions letters; the first was a demand in December 2011 to which RG2 Claims did not respond; and, the second letter was my stated position in support in June 2012. This notice is to dispel all presumptions about my citizenship, tax and domicile status with regard to any potential unauthorized actions by RG2 in its statutory role as a "withholding agent" for the United States.

The Social Security Administration (SSA)

I am a SSA NON-volunteer. I rescinded the SSA system application under the assigned name **DARRELL JAMES HILL** in 2006. This was done in accordance with law and regulations. I, and my wife, each rescinded our SSA account relationship in 2006 under current law and regulations (and as matter of public record). Identically, we no longer use the SSA system; all past years of contributions into the SSA system, and any distributions possible from the SSA system, were forfeited to the SSA system in 2006. Subsequently,

I am not a fiduciary for the strawman person;

I am not fiduciary for the SSA account/number;

I claim no current association with the SSA system;

I receive no benefits from the SSA system;

I am not eligible to receive benefits from the SSA system;

I have no application filed or pending for acceptance into the SSA system; and,

I hereby specifically deny any authority for any initiation or re-initialization of any SSA system application or association in any form on my behalf or in my regard.

In federal statutory terminology my status is "**nonresident alien NON-individual**" not engaged in "**trade or business**" in the United States. (Please refer to the documents received by RG2 Claims clarifying my status, "Affidavit of Citizenship, Domicile and Tax Status").

My Proper Name

2022-011769 MISC Page: 1910 of 2782

09/26/2022 03:35:37 PM Receipt #: 22-9381
Rec Fee: \$30.00 Darrell James Hill
Gila County, Az, Sadie Jo Bingham, Recorder



DOC# 361061

11/27/2012 01:09 PM Page: 8 of 178
AFF R: \$10.00 J. C. Sloan, McKinley County



DOC# 361076

11/27/2012 04:15 PM Page: 8 of 183
AFF R: \$10.00 J. C. Sloan, McKinley County



Darrell James, Hill

28 Hilltop Court, HC 61, Box 771, Ramah, N. Mex. [87321] (505)783.2499

CMN 7008 1830 0002 1030 0038

Concordantly, "Darrell James, Hill" is my proper name (properly in upper and lower case). Henceforth, I demand that all references to me must forevermore by any means and every form strictly to refer to me as Darrell James, Hill, the human being:

- (a) Be it known that any present and future reference to me shall be so construed;
- (b) Be it known that I am not a fiduciary for an individual, fictitious person, or other such entity.

RG2 Claims

Though I had contacted RG2 Claims (twice to date) less formally regarding my status, to state my demand, and to forbear any presumptions about my status concerning any proceeds due to me, there was no response to me from them; thus, the second correspondence.

I wrote and sent certified first a demand letter, and second an affidavit to clarify my status and preferences to RG2 Claims (see copies attached, Enclosures 1 and 2). In short, the first correspondence determined to RG2 Claims that I rescinded the SSA account and number association, and, consequently, I prohibited them to withhold any amounts payable to any taxation agency, or any other agency; that, I will manage for my self all tax matters and any other controversy that arises, if any.

That, in such a case wherein RG2 pursues by any means to disregard my demand and to redirect any amounts due to me then thereby RG2 agrees to reimburse me immediately for their act(s), and to seek recovery of their reimbursement to me from any such entity of their disbursement, at their own expense, jeopardy and liability, if they desire.

The second correspondence was definitive of my status in law and regulation, and in furtherance of my first correspondence to support and enable RG2's compliance with my simple demand for all reasons considerable; I expect that this is a small matter for which RG2 to comply -- No impasse should exist.

The Internal Revenue Service (IRS)

I hereby absolutely and unequivocally decline to give any gift to the IRS by any form of contribution.

I hereby absolutely and unequivocally decline to authorize or to give any entity or person or other, including the court, authority to authorize, proffer or file any type of the IRS "Form W-4" or its equivalent on my behalf or regarding me, as:

I am not employed by the Defendants in this case;

I am not an employee;

(Please note the RG2 attachment: Affidavit of Citizenship, Domicile, and Tax Status.).

What I Want You to do for Me Please

- a) Establish RG2's compliance with my status and demand for no withholding in writing so that this matter may be resolved efficiently and at low cost. I will initiate a criminal complaint against RG2 if they ignore the law.
- b) Do not allow any form of redistribution of funds especially and specifically because:
 - i. Be duly advised, I am lawfully separated from the SSA system and decline to rejoin the SSA system;
 - ii. Refrain from re-initialization of any SSA system application or association on my behalf or in my regard, as I have herein specifically denied any authority for any initiation or re-initialization of any SSA system application or association in any form on my behalf or in my regard;
 - iii. Be duly advised, "Darrell James, Hill" is my proper name; be it known that I am not a fiduciary for an individual, fictitious person, or other such construction. Thus, all references regarding me can only properly refer to the human being.
 - iv. Be duly advised, willful use of any SSA account/number or any filing by the RG2 the "withholding agent" constitutes both civil and criminal violations;
 - v. Honor my position as I have specifically declined to authorize or to give any entity or person or other, including the court, authority to authorize, proffer or file any type of the "Form W-4, Employee Allowance

2022-011769 MISC Page: 1911 of 2782
09/26/2022 09:35:37 PM Receipt #: 22-9381
Rec Fee: \$30.00 Darrell James Hill
Gila County, Az, Sadie Jo Bingham, Recorder

DOCH 361061

11/27/2012 01:09 PM Page: 9 of 178
AFF R: \$10.00 J. C. Sloan, McKinley County

DOCH 361076

11/27/2012 04:15 PM Page: 9 of 183
AFF R: \$10.00 J. C. Sloan, McKinley County

Darrell James, Hill

28 Hilltop Court, HC 61, Box 771, Ramah, N. Mex. [87321] (505)783.2499

CMN 7008 1830 0002 1030 0031

Certificate" or its equivalent on my behalf or regarding me. To do so, or to extort me by any means to do so is a felony violation, even for the court;

- vi. Honor my position as I have specifically declined to give gifts in any form to the IRS;
- vii. Be duly advised, do not redirect any funds due payable to me to the IRS, or any other agency, as it is a known fact that recovering any funds distributed to the government is tedious, time consuming and frequently costly in the best of relationships, and I AM NOT SUBJECT TO WITHHOLDING OR REPORTING;
- viii. Be duly advised, I am not employed by the defendants in this case.
- ix. Be duly advised, I am not an employee.
- x. Be duly advised, my Affidavit of Citizenship, Domicile, and Tax Status is determined to RG2 and to you herein (see attached in RG2 correspondence #2). I am a nonresident alien NON individual not engaged in trade or business within the United States, honor my status.
- xi. Be duly advised, according to my demand (see #1 enclosed) upon RG2, that RG2 must directly reimburse me without contest for any amounts redistributed by any defense: payable upon demand and without delay in the event RG2 disregards my demand and statement of citizenship, domicile and tax status.

c) Lastly, it is my belief that any undeliverable distributions should be provided to those who often times were ill for lack of food, or care needed, sufficient to rapidly worsen any state of wellness: for, one meal, one encouraging word, access to a safe place to rest/sleep, a coat in the winter, water/shade in the summer. This is nursing; please make the court record know this please (I), anonymously!

Conclusion

"Darrell James; Hill" is my proper name; all parties, including the court, are authorized only refer to the human being "Darrell James, Hill" the man; I am not fiduciary for an individual, fictitious person, or other such construct. My status is lawfully declared in my Affidavit of Citizenship, Domicile, and Tax Status enclosed.

I request for you to expediently and discreetly address and favorably determine RG2 to comply with my simple demand upon them, please. For them to do otherwise would further complicate my settlement and expose RG2, John R. Davis, Esq., to criminal penalties and civil complaints.

I will contact you after your receipt of this communication.

Lastly, I hope any proceeds undeliverable to class members would be sent as food to food banks, soup kitchens and homeless shelters, as support for prenatal care programs, and otherwise be given in support of the poor, the homeless, the forgotten, and the ignored men, women, children and the yet unborn in need. The court record should know this too is nursing.

Sincerely;

[Handwritten Signature]
Darrell James; Hill

Enclosures:

- (1) First Correspondence to RG2: Demand Letter
- (2) Second Correspondence to RG2: Affidavit of Citizenship, Domicile and Tax Status

2022-011769 MISC Page: 1912 of 2782

09/26/2022 03:35:37 PM Receipt #: 22-9381
Rec Fee: \$30.00 Darrell James Hill
Gila County, Az, Sadie Jo Bingham, Recorder



DOCH 361061

11/27/2012 01:09 PM Page: 10 of 178
AFF R:\$10.00 J. C. Sloan, McKinley County



DOCH 361076

11/27/2012 04:15 PM Page: 10 of 183
AFF R:\$10.00 J. C. Sloan, McKinley County

Unofficial Copy

DOCH 361076

11/27/2012 04:15 PM Page: 11 of 183
AFF R:\$10.00 J. C. Sloan, McKinley County

Item No. 1

Item 1:

Encl. 1

Dec. 2011

Position Statement

Position Statement

John R. Davis,

RG2 Claims Administration, Philadelphia, Pennsylvania

USPO CMN: 7001 0470 0002 1606 2151

Accepted: December 21, 2011

See Item 3, Encl.1: Demand Letter,: Denial of Withholding Authority

2022-011769 MISC Page: 1913 of 2782

09/26/2022 03:35:37 PM Receipt #: 22-9381

Rec Fee: \$30.00 Darrell James Hill
Gila County, Az, Sadie Jo Bingham, Recorder



DOCH 361061

11/27/2012 01:09 PM Page: 11 of 178
AFF R:\$10.00 J. C. Sloan, McKinley County



Hill Darrell James

DOC# 361076

11/27/2012 04:15 PM Page: 12 of 183
AFF R:\$10.00 J. C. Sloan, McKinley County



Official Copy

ENCLOSURE # 1

First Correspondence to RG2: Demand Letter

2022-011769 MISC Page: 1914 of 2782
09/26/2022 03:35:37 PM Receipt #: 22-9381
Rec Fee: \$30.00 Darrell James Hill
Gila County, Az, Sadia Jo Bingham, Recorder



DOC# 361061

11/27/2012 01:09 PM Page: 12 of 178
AFF R:\$10.00 J. C. Sloan, McKinley County



ENCLOSURE # 1

Darrell James, Hill
28 Hilltop Court
HC 61, Box 771
Ramah, N. Mex. [87321]

1-866-742-4955

John R. Davis, Esq., Director of Claims Administration
AzHHA Settlement Administrator
c/o RG/2 Claims Administration LLC
P.O. Box 59479
Philadelphia, PA 19102-9479

**Re: Claimant ID#: AZA000000930; I Terminated the SSA Account in 2006;
I Do Not Authorize RG2 Claims Administration To Use A SSN Regarding Me**

Mr. Davis, To Whom This May Concern:

I (and my spouse) terminated the SSA account and number in 2006 in accordance with 20 CFR 3 A7 404.1905, **Termination of agreements.**

Each agreement shall contain provisions for its possible termination. If an agreement is terminated, entitlement to benefits and coverage acquired by an individual before termination shall be retained. The agreement shall provide for notification of termination to the other party and the effective date of termination.

I made RG2 notice of my non-SSN status about the claims application SSN entry box, for the fact that the SSN required was rescinded in 2006; it is merely a historical truth that the assigned number was once active. See attached: a) initial rescission filing in 2006 and b) letter in 2010 compliance with 20 CFR 3 A7 404.1905.

I ceased all use of a SSA account and number in 2006 according to law and federal regulations: I am not entitled to SSA benefits or coverage. All coverage and monies paid into the SSA system was retained and forfeited to that system.

Thus, in accordance with my non-SSN status this is my decision:

I prohibit RG2 to use any SSN in my regard;

I prohibit RG2 to pay any tax obligations or make any distributions to any taxing authority for any obligation assumed or alleged owed (I will manage these matters privately for my status.);

2022-011769 MISC Page: 1915 of 2782
09/26/2022 03:35:37 PM Receipt #: 22-9381
Rec Fee: \$30.00 Darrell James Hill
Gila County, Az, Sadie Jo Bingham, Recorder



DOCH 361061

11/27/2012 01:09 PM Page: 13 of 178
AFF R: \$10.00 J. C. Sloan, Mokinley County



DOCH 361076

11/27/2012 04:15 PM Page: 13 of 183
AFF R: \$10.00 J. C. Sloan, Mokinley County



This prohibition of RG2 is my decision, thus:

I HEREBY assure that RG2 has no complicity with my decision to prohibit RG2 from all assumed authority in my regard to use of any SSN or to limit any claims distributions due to me by any configuration.

Further, if RG2 uses a SSN or distributes any funds against the explicit prohibitions herein, then RG2 agrees thereby to assure without contest all costs, charges, penalties and associated costs for all efforts to recover any and all losses in status and/or funds.

I authorize RG2 to use of ONLY my name, address and telephone number on a 1099 form as required, and as the Secretary requests (IRC 6041).

In conclusion, I am NOT a SSA account holder by law and in accordance with federal regulations. I do NOT use a SSN. I prohibit RG2 to use a SSN regarding me. I prohibit RG2 from withholding any funds from me by any means or condition(s). I assume all responsibility for my non-SSN status and claim full responsibility for the prohibitions herein.

RG2 agrees that for violation of these prohibitions by any method RG2 agrees to assure without contest all costs and related expenses for the recovery of all losses and making this claimant whole for same.

Sincerely;

Darrell James, Hill

Cc:

Grant Rawdin, Esq., CFP®, CEO

Michael A. Gillen, CPA, CFE, CFF, President

Michael J. Lee, CFA, COO

William W. Wickersham, Esq., Vice President, Business Development and Client Relations

1907
2022-011769 MISC Page: 1916 of 2782
09/26/2022 03:35:37 PM Receipt #: 22-9381
Rec Fee: \$30.00 Darrell James Hill
Gila County, Az, Sadie Jo Bingham, Recorder



DOCH 361061

11/27/2012 01:09 PM Page: 14 of 178
AFF R:\$10.00 J. C. Sloan, Mokinley County



DOCH 361076

11/27/2012 04:15 PM Page: 14 of 183
AFF R:\$10.00 J. C. Sloan, Mokinley County



Respond to:

DARREL JAMES HILL

May 22, 2006

Darrell James Hill
c/o PO Box 40475
Mesa, Arizona [85274]



2008-008777

Page: 1 of 5
05/22/2008 02:49P
13.00

Gila County, AZ

MISC



NOTICE TO PRINCIPAL IS NOTICE TO AGENT
NOTICE TO AGENT IS NOTICE TO PRINCIPAL

NOTICE: Filing of Request for Withdrawal of Application - Form SSA-521,
and Setoff of Account No. [REDACTED]

Address to:

Alberto R. Gonzales Attorney General, Department of Justice 950 Pennsylvania Avenue, NW Washington, D.C. 20530-0001 CMN 7003 3110 0001 3436 3760	Russell Nelson (#86-18005), Revenue Officer Department of the Treasury Bureau, Internal Revenue Service M/S 5117em 40 W. Baseline, Road, Ste. 213 Tempe, Arizona, 85283 CMN 7003 3110 0001 3436 3791
Norman Y. Mineta, Secretary of Transportation U.S. Department of Transportation 400 7 th Street, S.W. Washington, D.C. 20590 CMN 7003 3110 0001 3436 3777	Kurt Kukhausen (#86-01586), Revenue Agent (Compliance) Department of the Treasury Bureau, Internal Revenue Service PO Box 2148 Grand Junction, Colorado 81502 CMN 7004 2510 0004 3669 5987
Jan Brewer, Secretary of State Arizona 1700 West Washington Street Capitol Executive Tower, 7 th Floor Phoenix, Arizona 85007-2888 CMN 7003 3110 0001 3436 3784	Angela Carmouche (#86-16575), Settlement Officer Department of the Treasury Bureau, Internal Revenue Service PHX Office 210 East Earll Drive Phoenix, Arizona 85012 CMN 7003 3110 0001 3436 3876
Carlos M. Gutierrez, Secretary U.S. Department of Commerce 14 th & Constitution Avenue NW, Room 5516 Washington, D.C. 20230 CMN 7003 3110 0001 3436 3807	Mary Brown, Appeals Team Leader Department of the Treasury Bureau, Internal Revenue Service PHX Office 210 East Earll Drive Phoenix, Arizona 85012 CMN 7003 3110 0001 3436 3883
Condoleezza Rice, U.S. Secretary of State U.S. Department of State 2201 C Street N.W. Washington, D.C. 20520 CMN 7003 3110 0001 3436 3814	Arvid Koppang (#84-01868), Examining Group Manager Department of the Treasury Bureau, Internal Revenue Service PO Box 2148 Grand Junction, Colorado 81502 CMN 7003 3110 0001 3436 3890

Notice: Filing of Request for Withdrawal of Application - Form SSA-521

Page 1 of 2

2022-011769 MISC Page: 1917 of 2782

09/26/2022 03:35:37 PM Receipt #: 22-9381

Rec Fee: \$30.00 Darrell James Hill
Gila County, AZ, Sadie Jb Bingham, Recorder



DOCH 361076



11/27/2012 04:15 PM Page: 15 of 183
AFF R:\$10.00 J. C. Sloan, McKinley County

DOCH 361061



11/27/2012 01:09 PM Page: 15 of 178
AFF R:\$10.00 J. C. Sloan, McKinley County



Gila County, AZ

MISC

J. Russell George, Inspector General For Tax Administration Tax Administration 1125 15 th Street, N.W. Washington, D.C. 20005 CMN 7003 3110 0001 3436 3821	Donald L. Korb, IRS Chief Counsel Department of the Treasury Bureau, Internal Revenue Service 1111 Constitution Avenue, Room # 3026 Washington, D.C. 20224 CMN 7003 3110 0001 3436 3906
Paul K. Charlton, United States Attorney Room 4000 230 N 1st Ave Phoenix, AZ 85025-0230 CMN 7003 3110 0001 3436 3913	Scot Prentky, Field Director, Compliance Service Department of the Treasury Bureau, Internal Revenue Service Ogden, Utah 84201-0030 CMN 7003 3110 0001 3436 3920
Gale Garriott, Director State of Arizona Department of Revenue 1600 West Monroe Street Phoenix, Arizona 85007-2650 CMN 7003 3110 0001 3436 3937	Curtis Pett, Attorney Tax Division, Appellate Section, U.S. Department of Justice PO Box 502 Washington, D.C. 20044 CMN 7003 3110 0001 3436 3944
Dennis Parizek (#29-61699) Operations Manager, Exam SC Support Department of the Treasury Bureau, Internal Revenue Service 1973 North Rulon White Blvd. Ogden, Utah 84404-0040 CMN 7003 3110 0001 3436 3951	Shauna Henline, Technical Advisor, Frivolous Return Program Department of the Treasury Bureau, Internal Revenue Service Mail Stop 4390 105 East 23 rd Street Ogden, Utah 84401 CMN 7003 3110 0001 3436 3968

In re: Filing of Request for Withdrawal of Application - Form SSA-521,
and Setoff of Account No. [REDACTED]

Dear Messrs. Gonzales, Mineta, Gutierrez, Korb, Nelson, Kuxhausen, Koppang, George,
Charlton, Parizek, Prentky, Pett, Ms. Brewer, Ms. Rice, Ms. Carmouche, Ms. Brown, Ms.
Garriott, Ms. Henline

You and your agents are hereby notified that I, a man, above signed, appearing as Darrell James Hill, have properly filed a SSA-521 Form with the Social Security Administration, on May 22, 2006. As such, I have effectively rebutted any and all presumptions as to my status and receipt of limited liability insurance benefits. I have further, by this filing, provided notice to the world at this time of application I was not capable of contract. See SSA-521 attached hereto. In addition, I am providing notice that I am operating under my full commercial liability, having no parity with any government agency, I.R.S., U.S. District Court, etc.

Additionally, you will find enclosed a true copy of the correspondence I have sent to Mr. Mendez, the Secretary of the Treasury in San Juan, Puerto Rico, regarding account 274 64 9172. Demand has been made upon Mr. Mendez, for set off in the nature of UCC § 3-501 and to zero balance the account. I fully expect that Mr. Mendez being an honorable man, will comply with my instructions upon receipt of same.

Notice: Filing of Request for Withdrawal of Application - Form SSA-521

Page 2 of 2

2022-011769 MISC Page: 1918 of 2782
09/26/2022 03:35:37 PM Receipt #: 22-9381
Darrell James Hill
Rec Fee: \$30.00
Sally Jo Bingham, Recorder
Gila County, AZ



DOCH 361076

11/27/2012 04:15 PM Page: 16 of 189
AFF R: \$10.00 J. C. Sloan, McKinley County

DOCH 361061

11/27/2012 01:09 PM Page: 16 of 178
AFF R: \$10.00 J. C. Sloan, McKinley County



2006-008777

Page: 3 of 5

05/22/2006 02:40
13.00

Gila County, AZ

MISC

This being the case, demand is how made upon each of you, and your agents, to correct any and all records to properly reflect my status, and immediately cease and desist any and all civil and/or criminal prosecution/investigations with regards to Darrell James Hill, DARRELL JAMES HILL and/or DARRELL J. HILL and/or DJ HILL.

Thank you in advance for your prompt attention to this matter.

Enclosed: SSA-521 Filed May 22, 2006

Demand for Setoff Letter to Mr. Mendez, dated May 22, 2006 with attachments

Official Copy

2022-011769 MISC Page: 1919 of 2782
09/26/2022 03:35:37 PM Receipt #: 22-9381
Rec Fee: \$30.00 Darrell James Hill
Gila County, Az, Sadie Jo Bingham, Recorder

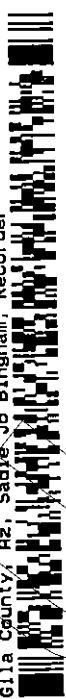

Notice: Filing of Request for Withdrawal of Application - Form SSA-521

Page 3 of 3

DOCH 361076

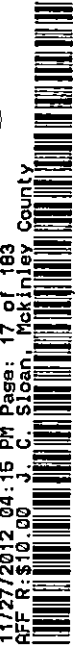

11/27/2012 04:15 PM Page: 17 of 183
AFF R: \$10.00 J. C. Sloan, McKinley County

DOCH 361061

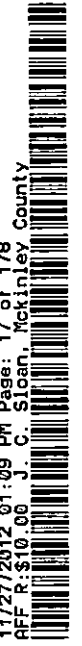

11/27/2012 01:09 PM Page: 17 of 178
AFF R: \$10.00 J. C. Sloan, McKinley County



SOCIAL SECURITY ADMINISTRATION

Gila County, AZ

MISC
10E 94V

REQUEST FOR WITHDRAWAL OF APPLICATION

IMPORTANT NOTICE.— This is a request to cancel your application. If it is approved, the decision we made on your application will have no legal effect, all rights attached to an application, including the rights of reconsideration, hearing, and appeal will be forfeited, and any payments we made to you or anyone else on the basis of that application will have to be returned. You must then reapply if you want a determination of your Social Security rights at any time in the future but any subsequent application may not involve the same retroactive period. This procedure is intended to be used only when your decision to file has resulted, or will result, in a disadvantage to you. Your local Social Security office will be glad to explain whether, and how, this procedure will help you.

Do not write in this space
MESA, ARIZONA

MAY 22 2006

**D/O CODE 929
SSA DISTRICT OFFICE**

NAME OF WAGE EARNER, SELF-EMPLOYED INDIVIDUAL, OR ELIGIBLE INDIVIDUAL

DARRELL JAMES HILL

PRINT YOUR NAME (First name, middle initial, last name)

Darrell James Hill

SOCIAL SECURITY NUMBER

DATE OF APPLICATION

1958

TYPE OF BENEFIT

N/A

TYPE OF APPLICATION

SS-5

I hereby request the withdrawal of my application, dated as above, for the reasons stated below. I understand that (1) this request may not be cancelled after 60 days from the mailing of notice of approval; and (2) if a determination of my entitlement has been made, there must be repayment of all benefits paid on the application I want withdrawn, and all other persons whose benefits would be affected must consent to this withdrawal. I further understand that the application withdrawn and all related material will remain a part of the records of the Social Security Administration and that this withdrawal will not affect the proper crediting of wages or self-employment income to my Social Security earnings record.

Give reason for withdrawal. (If you need more space, use the reverse of this form.)

- I intend to continue working. (I have been advised of the alternatives to withdrawal for applicants under full retirement age and still wish to withdraw my application.)
- Other (Please explain fully): **I, Darrell James Hill, nunc pro tunc, a living breathing man, make this Rescission, Termination, Rejection and Waiver of Benefits voluntarily, freely and with Reservation of Rights and Defenses Without Prejudice, and state: At the**

Continued on reverse

SIGNATURE OF PERSON MAKING REQUEST

Signature (First name, middle initial, last name) (Write in ink)

SIGN HERE

Darrell James Hill

Date (Month, day, year)

22 May 2006

Telephone Number (include area code)

N/A

Mailing Address (Number and Street, Apt. No., P.O. Box, or Rural Route)

c/o P.O. Box 40475

City and State

Mesa, Arizona

ZIP Code

(85274)

Enter Name of County (if any) in which you now live

Maricopa

Witnesses are required ONLY if this request has been signed by mark (X) above. If signed by mark (X), two witnesses to the signing who know the person making the request must sign below, giving their full addresses.

1. Signature of Witness

2. Signature of Witness

Address (Number and Street, City, State and ZIP Code)

Address (Number and Street, City, State and ZIP Code)

FOR USE OF SOCIAL SECURITY ADMINISTRATION

APPROVED

NOT APPROVED BECAUSE

BENEFITS NOT REPAID

CONSENT(S) NOT OBTAINED

OTHER (Attach special determination)

SIGNATURE OF SSA EMPLOYEE

TITLE

CLAIMS AUTHORIZER

OTHER (Specify)

DATE



11/27/2012 04:15 PM Page: 18 of 183
AFF R: \$10.00 J. C. Sloan, McKinley County
DOCH 361076

11/27/2012 01:09 PM Page: 18 of 178
AFF R: \$10.00 J. C. Sloan, McKinley County
DOCH 361061

Additional Remarks:

Gila County, AZ

MISC

time of application for benefits, SS-5 form, I was not capable of Contract, having no knowledge of terms and conditions, reciprocity requirements, etc., of the SS-5. Said SS-5 being unconscionable, provides no equal exchange of consideration, and cannot be made valid for lack of consideration. The SS-5 being an adhesion contract fails on its face, setting forth no terms, no conditions, no reciprocity requirements, and is therefore unconscionable and ultra vires.

Whereas, I, Darrell James Hill, nunc pro tunc, Rescind, Terminate, Reject, Forfeit and Waive any and all benefits arrived therefrom. I notice that any and all funds extracted from DARRELL JAMES HILL, aka DARRELL J. HILL by the Social Security Administration, its agents or principals, were done so under fraudulent pretenses, inducement of fraud, etc., and that Darrell James Hill is the rightful owner of all such interpleaded funds as Darrell James Hill is a secured party to DARRELL JAMES HILL, aka DARRELL J. HILL and that any such funds are not bail in fact under any Trading with the Enemy Act Doctrine.

Whereas I, Darrell James Hill, nunc pro tunc, state for the Record, that I am not a U. S. Citizen, a 14th Amendment citizen, a UN citizen, STATE OF ARIZONA citizen, nor any citizen at all, but am a de jure man on the land, first appearing as Darrell James Hill on the 20th day November month, 1958 at Summit County, Ohio republic, and I deny any fiduciary duty and/or liability for DARRELL JAMES HILL and/or DARRELL J. HILL.

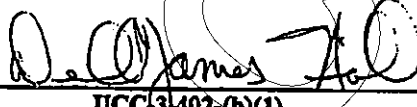
UCC3402-(b)(1)

We may also use the information you give us when we match records by computer. Matching programs compare our records with those other Federal, State, or local government agencies. Many agencies may use matching programs to find or prove that a person qualifies for benefits paid by the Federal government. The law allows us to do this even if you do not agree to it.

Explanations about these and other reasons why information you provide us may be used or give out are available in Social Security Offices. If you want to learn more about this, contact any Social Security Office.

Paperwork Reduction Act Statement - This information collection meets the requirements of 44 U.S.C. § 3607, as amended by Section 2 of the Paperwork Reduction Act of 1995. You do not need to answer these questions unless we display a valid Office of Management and Budget control number. We estimate that it will take about 5 minutes to read the instructions, gather the facts, and answer the questions. SEND THE COMPLETED FORM TO YOUR LOCAL SOCIAL SECURITY OFFICE. The office is listed under U. S. Government agencies in your telephone directory or you may call Social Security at 1-800-772-1213. You may send comments on our time estimate above to: SSA, 1338 Annex Building, Baltimore, MD 21235-0001. Send only comments relating to our time estimate to this address, not the completed form.

DOCH 361076

11/27/2012 04:15 PM Page: 19 of 163
AFF R:\$10.00 J. C. Sloan, McKinley County

2022-011769 MISC Page: 1921 of 2782
09/26/2022 03:35:37 PM Receipt #: 22-9381
Rec Fee: \$30.00 Darrell James Hill
Gila County, Az, Sadie Jo Bingham, Recorder



DOCH 361061

11/27/2012 01:09 PM Page: 19 of 178
AFF R:\$10.00 J. C. Sloan, McKinley County



Unofficial

Darrell James, Hill
1235 S. Gilbert Rd., Ste. 3, PMB-25/ Mesa, Arizona [85204]

USPO Registered Mail No.: RA 337 238 865 US

After 20 days you will be held in DEFAULT of this demand, and thereupon by tacit procurement you assent to the unequivocal incontrovertible administrative release and immediate termination in fact of the social security account and number [REDACTED] assigned to Darrell James, Hill; and, thereupon, your official release letter will issue accordingly, effective in all computerized and other general systems of records.

Sincerely;
Darrell James, Hill

Enclosure: copy of 2006 Form SSA-521 for SS-5 application for account [REDACTED] (2 pages)

state of Arizona

§

Maricopa county

I, Darrell James, Hill, having personally appeared and identified myself before notary this ___ day of September 2009, signed below that I am the party declaring this demand.

Darrell James, Hill

Notary

Expires

2022-011769 MISC Page: 1922 of 2782
09/26/2022 03:35:37 PM Receipt #: 22-9381
Rec Fee: \$30.00 Darrell James Hill
Gila County, Az, Sadie Jo Bingham, Recorder



Commissioner SSA USPO Registered Mail No.: RA 337 238 865 US

2of2

DOCH 361076

11/27/2012 04:15 PM Page: 20 of 185
AFF R: \$10.00 J. C. Sloan, McKinley County



DOCH 361061

11/27/2012 01:09 PM Page: 20 of 178
AFF R: \$10.00 J. C. Sloan, McKinley County



Unofficial Copy

1913

Darrell James, Hill
1235 S. Gilbert Rd., Ste. 3, PMB-25/ Mesa, Arizona [85204]

USPO Registered Mail No.: RA 337 238 865 US

Michael J. Astrue, Commissioner,
Social Security Administration
c/o David F. Black, General Counsel
Social Security Administration
Room 617, Altmeyer Building
6401 Security Boulevard
Baltimore, MD 21235-6401

- Re: A) Demand for Determination of Disposition of the Document for Rescission Termination (see Form SSA-521 Request for withdrawal of Application for SS-5 for Account [REDACTED]);
- B) Demand for Verified Assessment of Your Lawful Authority to force a Social Security Administration contract/membership upon Darrell James, Hill;
- C) Demand for Rescission Termination of Social Security Account and Number [REDACTED] Assigned to Darrell James, Hill, as of May 2006;

Michael J. Astrue, David F. Black; To Whom This May Concern:

I hope you are well.

You, et al., for unknown reasons ignored my 2006 "application" to terminate the social security administration account and number as demanded (see attached, Form SSA-521, "Request for withdrawal of Application" for SS-5 for account and number [REDACTED] assigned to Darrell James, Hill);

The Form SSA-521 I filed in 2006 was not a request for permission to terminate the account, the filing was an order; accordingly, your prompt action is herein demanded to bring this long overdue order to complete closure as it imposes an undue burden upon my religious belief:

YOU ARE HEREIN DEMANDED TO:

- 1) Determine the Disposition of the Document for Rescission Termination, Form SSA-521 Request for withdrawal of Application for SS-5 for account [REDACTED], Darrell James, Hill;
- 2) Provide verified assessment of lawful authority for you forcing a Social Security Administration contract/membership upon Darrell James, Hill, after on or about May of 2006; and,
- 3) Formally rescind terminate the social security account and number [REDACTED] assigned to Darrell James, Hill, as of May 2006: documentation of the unequivocal incontrovertible administrative release and termination is demanded.

You have 20 consecutive days from the delivery of this document to comply with this DEMAND;

2022-011769 MISC Page: 1923 of 2782
09/26/2022 03:35:37 PM Receipt #: 22-9381
Rec Fee: \$30.00 Darrell James Hill
Gila County, Az, Sadie Jo Bingham, Recorder

Commissioner SSA USPO Registered Mail No.: RA 337 238 865 US

1of2

DOCH 361061

11/27/2012 01:09 PM Page: 21 of 178
AFF R:\$10.00 J. C. Sloan, McKinley County

DOCH 361076

11/27/2012 04:15 PM Page: 21 of 183
AFF R:\$10.00 J. C. Sloan, McKinley County

English Customer Service USPS Mobile

Register / Sign In



Search USPS.com or Track Packages

Quick Tools

Ship a Package

Send Mail

Manage Your Mail

Shop

Business Solutions

Track & Confirm

REFRESH UPDATED PRINT DETAILS

YOUR LABEL NUMBER	SERVICE	STATUS OF YOUR ITEM	DATE & TIME	LOCATION	FEATURES
7011047000216062151	First-Class Mail®	Delivered	December 05, 2011, 12:40 pm	PHILADELPHIA, PA 19102	Expected Delivery By: December 5, 2011 Certified Mail™
		Notice Left	December 05, 2011, 11:26 am	PHILADELPHIA, PA 19102	
		Dispatched to Sort Facility	December 01, 2011, 3:24 pm	RAMAH, NM 87321	
		Acceptance	December 01, 2011, 2:12 pm	RAMAH, NM 87321	

Check on Another Item

What's your label (or receipt) number?

Find

LEGAL

- Privacy Policy
- Terms of Use
- FOIA
- No FEAR Act EEO Data

ON USPS.COM

- Government Services
- Buy Stamps & Shop
- Print a Label with Postage
- Customer Service
- Site Index

ON ABOUT.USPS.COM

- About USPS Home
- Newsroom
- Mail Service Updates
- Forms & Publications
- Careers

OTHER USPS SITES

- Business Customer Gateway
- Postal Inspectors
- Inspector General
- Postal Explorer

Copyright © 2011 USPS. All Rights Reserved.

2022-011769 MISC Page: 1924 of 2762
 09/26/2022 03:35:37 PM Receipt #: 22-9381
 Rec Fee: \$20.00 Darrell James Hill
 City: Ramah, NM 87321
 County: Sandoval, NM 87321
 Recorder: Sadie Jo Bingham



U.S. Postal Service™
CERTIFIED MAIL™ RECEIPT
 (Domestic Mail Only; No Insurance Coverage Provided)
 For delivery information visit our website at www.usps.com

OFFICIAL USE

Postage	\$.64
Certified Fee	2.85
Return Receipt Fee (Endorsement Required)	2.30
Restricted Delivery Fee (Endorsement Required)	
Total Postage & Fees	\$ 5.79

Sent To: John R. Davis, Esq.
 Street, Apt. No., or PO Box No.: P.O. Box 59479
 City, State, ZIP+4: Philadelphia, PA 19102-9479

PS Form 3800, August 2006 See Reverse for Instructions

7011 0470 0002 1606 2151

DOCH 361061

12/6

11/27/2012 01:09 PM Page: 22 of 178
 AFF R: \$10.00 J. C. Sloan, McKinley County

DOCH 361076
 11/27/2012 04:15 PM Page: 22 of 183
 AFF R: \$10.00 J. C. Sloan, McKinley County

Unofficial Copy

DOCH 361076

11/27/2012 04:15 PM Page: 23 of 183
AFF R:\$10.00 J. C. Sloan, McKinley County

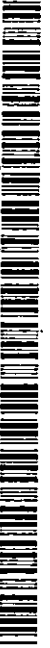

Item No. 1

Item 1:
Encl. 1
Art. 1

Position Statement

Mailing and Acceptance Information

John R. Davis,

RG2 Claims Administration, Philadelphia, Pennsylvania

USPO CMN: 7001 0470 0002 1606 2151

Accepted: December 21, 2011

Mailing and Acceptance Information

2022-011769 MISC Page: 1925 of 2782
09/26/2022 03:35:37 PM Receipt #: 22-9381
Rec Fee: \$30.00 Darrell James Hill
Gila County, Az, Sadie Jo Bingham, Recorder



DOCH 361061

11/27/2012 01:09 PM Page: 23 of 178
AFF R:\$10.00 J. C. Sloan, McKinley County



English Customer Service USPS Mobile

Register / Sign In



Search USPS.com or Track Packages

Quick Tools

Ship a Package

Send Mail

Manage Your Mail

Shop

Business Solutions

Track & Confirm

VIEW MAIL UPDATES PRINT DETAILS

YOUR LABEL NUMBER	SERVICE	STATUS OF YOUR ITEM	DATE & TIME	LOCATION	FEATURES
70110470000216062151	First-Class Mail®	Delivered	December 05, 2011, 12:40 pm	PHILADELPHIA, PA 19102	Expected Delivery By December 5, 2011 Certified Mail™
		Notice Left	December 05, 2011, 11:26 am	PHILADELPHIA, PA 19102	
		Dispatched to Sort Facility	December 01, 2011, 3:24 pm	RAMAH, NM 87321	
		Acceptance	December 01, 2011, 2:12 pm	RAMAH, NM 87321	

Check on Another Item
What's your label (or receipt) number?

U.S. Postal Service™ CERTIFIED MAIL™ RECEIPT (Domestic Mail Only; No Insurance Coverage Provided)

For delivery information visit our website at www.usps.com

OFFICIAL USE

Postage	\$.64
Certified Fee	2.85
Return Receipt Fee (Endorsement Required)	2.30
Restricted Delivery Fee (Endorsement Required)	
Total Postage & Fees	\$ 5.79

LEGAL
Privacy Policy
Terms of Use
FOIA
No FEAR Act EEO Data

ON USPS.COM
Government Services
Buy Stamps & Shop
Print a Label with Postage
Customer Service
Site Index

Copyright © 2011 USPS. All Rights Reserved

Sent To John R. Davis, Esq
 Street, Apt. No., or PO Box No. P.O. Box 59479
 City, State, ZIP+4 Philadelphia, PA 19102-9479
 PS Form 3800, August 2005 See Reverse for Instructions

- Complete items 1, 2, and 3. Also complete item 4 if Restricted Delivery is desired.
- Print your name and address on the reverse so that we can return the card to you.
- Attach this card to the back of the mailpiece, or on the front if space permits.

1. Article Addressed to:
John R. Davis, Esq
AZHHA Settlement Admin
c/o RG/2 Claims Admin LLC
PO Box 59479
Philadelphia, PA
19102-9479

A. Signature Agent Addressed
X. Angel Becerra
 B. Received by (Printed Name) Angel Becerra C. Date of Delivery 12/5/11
 D. Is delivery address different from item 1? Yes No
 If YES, enter delivery address below:

3. Service Type
 Certified Mail Express Mail
 Registered Return Receipt for Merchandise
 Insured Mail C.O.D.
 4. Restricted Delivery? (Extra Fee) Yes

2. Article Number (Transfer from service label) 7011 0470 0002 1606 2151

PS Form 3811, February 2004

Domestic Return Receipt

102595-02-M-15-00

2022-011769 MIS Page: 1926 of 2782
 09/26/2022 03:35:37 PM Receipt #: 22-9381
 Rec. Fee: \$30.00 Bartlett James Hill Recorder
 Gila County, AZ; Sadie Jo Bingham, Recorder

DOCH 361061

11/27/2012 01:09 PM Page: 24 of 178
AFF R: \$10.00 J. C. Sloan, McKinley County

DOCH 361076
11/27/2012 04:15 PM Page: 24 of 183
AFF R: \$10.00 J. C. Sloan, McKinley County

DOCH 361076

11/27/2012 04:15 PM Page: 25 of 183
AFF R:\$10.00 J. C. Sloan, Mckinley County



Item No. 1

Item 1:

Encl. 2

June 2012

Status Statement

Affidavit of Citizenship, Domicile, and Tax Status, June 2012

John R. Davis,

RG2 Claims Administration, Philadelphia, Pennsylvania

USPO CMN: 7011 0470 0002 1606 2168

Accepted: June 25, 2012

See Item 3, Enclosure 2: Affidavit

2022-011769 MISC Page: 1927 of 2782

09/26/2022 03:35:37 PM Receipt #: 22-9381
Rec Fee: \$30.00 Darrell James Hill
Gila County, Az, Sadie Jo Bingham, Recorder



DOCH 361061

11/27/2012 01:09 PM Page: 25 of 178
AFF R:\$10.00 J. C. Sloan, Mckinley County



Hill Darrell James

DOCH 361076

11/27/2012 04:15 PM Page: 26 of 183
AFF R:\$10.00 J. C. Sloan, McKinley County



ENCLOSURE # 2

Second Correspondence to RG2: Affidavit of Citizenship, Domicile and Tax Status

2022-011769 MISC Page: 1928 of 2782
09/26/2022 03:35:37 PM Receipt #: 22-9381
Rec Fee: \$30.00 Darrell James Hill
Gila County, Az, Sadie Jo Bingham, Recorder



DOCH 361061

11/27/2012 01:09 PM Page: 26 of 178
AFF R:\$10.00 J. C. Sloan, McKinley County



Darrell James, Hill (class member # AZA000000930)
28 Hilltop Court, HC 61 Box 771, Ramah, New Mexico

CMN 7011 0470 0002 1606 2168

Johnson v. AzHHA Settlement Administrator
c/o John R. Davis, Esq.
RG/2 Clams Administration LLC
P.O. Box 59479
Philadelphia, PA 19102-9479

RE: 1) Class member is a Social Security Administration (SSA) system NON-volunteer; member rescinded the SSA system account/number in May 2006;
2) Class member is a non-resident alien NON-individual with regard to the federal government, and is not engaged in trade or business in the United States. Please see the AFFIDAVIT OF CITIZENSHIP, DOMICILE, AND TAX STATUS and the WHY IT IS ILLEGAL FOR ME TO REQUEST OR TO USE A TAXPAYER IDENTIFICATION NUMBER (TIN) attachments.

To Whom This May Concern:

1. My name is Darrell James, Hill. I am a class member within the JOHNSON, ET AL. V. ARIZONA HOSPITAL & HEALTHCARE ASSOCIATION, ET AL. UNITED STATES DISTRICT COURT CASE NO. 07-CV-1292-SRB (D. Az.): class member number AZA000000930.
2. As indicated to you above, and before in my initial contact with you regarding my statuses, I rescinded the SSA account in 2006. The SSA, IRS (national headquarters and locally) was notified, as well as other agencies.
3. On December 1, 2011, I wrote and sent to you by USPO certified mail a demand letter about my status (CMN 7011 0470 0002 1606 2151) which in short states that I do not authorize you (RG2) to withhold any amounts payable to any taxation agency, or any other agency: I will manage for my self all tax matters and any other controversy that arises, if any. I deny you authority to withhold any proceeds due to me.

That, in any case wherein you pursue by any means to redirect any amounts due to me in disregard of my absolute non-authorization demand upon you then thereby you agree to reimburse me immediately for your act(s), and to seek recovery of your reimbursement to me from any such entity of your disbursement, at their own expense, jeopardy and liability, if you desire. Please notice the warnings in the attachments concerning our relationship.

The Social Security Administration (SSA)

I (We) rescinded the SSA system under assigned name DARRELL JAMES HILL in May of 2006: both, I and my wife each so did.

Identically, 1) we no longer use the SSA system; all past years of contributions into the SSA system, and any distributions possible from the SSA system, were forfeited to the SSA system in 2006. 2) We are non-resident alien NON- individuals with regard to the federal government, and who are not engaged in trade or business in the United States. 3) See attached the AFFIDAVIT OF CITIZENSHIP, DOMICILE, AND TAX STATUS to notify and determine my citizenship, domicile and tax status to you so to help clarify my demands upon you.

2022-011769 MISC Page: 1929 of 2782
09/26/2022 03:35:37 PM Receipt #: 22-9381
Rec Fee: \$30.00 Darrell James Hill
Gila County, Az, Sadie Jo Bingham, Recorder

DOC# 361061

11/27/2012 01:09 PM Page: 27 of 178
AFF R: \$10.00 J. C. Sloan, McKinley County

DOC# 361076

11/27/2012 04:15 PM Page: 27 of 183
AFF R: \$10.00 J. C. Sloan, McKinley County

Darrell James, Hill (class member # AZA000000930)
28 Hilltop Court, HC 61 Box 771, Ramah, New Mexico

CMN 7011 0470 0002 1606 2168

My Proper Name

4. "Darrell James, Hill" is my proper name; properly in upper and lower case as indicated. Henceforth, I demand that you refer to me by all means exclusively and solely as "Darrell James, Hill" the man; be it known that I am not a fiduciary for an individual, fictitious person, or other such entity.

5. I expect this is a small matter for you to comply with my demands. But, with so many class members (and no response from you on my first topical letter (See #3 above)) it seems necessary to help with as much support as I possible to clarify my Constitutional status to you and enable your discreet cooperation.

The Internal Revenue Service (IRS)

6. I hereby absolutely and unequivocally decline to give any gift(s) to the IRS by any form of contribution; and, I will receive and deposit any proceed amount to be "[d]eposited for credit on account or exchanged for a non-negotiable Federal Reserve Note(s) of face value".

7. Furthermore, it is par that the IRS will seek to unethically keep any wrongly distributed amounts by any means possible.

I hereby absolutely and unequivocally decline to allow or authorize any entity authority to authorize, proffer or file any type of the "Form W-4, Employee Allowance Certificate" or its equivalent on my behalf or regarding me.

I am not employed by the Defendants in this case.

I am not an employee.

What I Want You to do for Me Please

8. My path through you is clear; that is, for you to not allow any form of redistribution of funds especially and specifically because:

a. Be duly advised, I 1) am lawfully and legally separated from the SSA (account/number) system, 2) am not receiving benefits, 3) am not eligible to receive benefits, and 4) decline to rejoin the SSA system;

b. Refrain from re-initialization of any SSA system application or association on my behalf or in my regard, as I hereby specifically deny any authority for any initiation or re-initialization of any SSA system application or association in any form on my behalf or in my regard;

c. Be duly advised, "Darrell James, Hill" is the proper name.

d. Honor my position as I have specifically demanded that all parties referring to me forevermore by any means refer thereby exclusively and solely to me "Darrell James, Hill" the man; be it known that I am not a fiduciary for an individual, fictitious person, or other such entity.

d. Be duly advised, willful use of a SSA account/number in my regard constitutes serious felony action by you;

e. Honor my position as I have specifically declined to give a gift(s) to the IRS;

2022-011769 MISC Page: 1930 of 2782
09/26/2022 03:35:37 PM Receipt #: 22-9381
Rec Fee: \$30.00 Darrell James Hill
Gila County, Az, Sadie Jo Bingham, Recorder

DOCH 361061

11/27/2012 01:09 PM Page: 28 of 178
AFF R: \$10.00 J. C. Sloan, Mckinley County

DOCH 361076

11/27/2012 04:15 PM Page: 28 of 183
AFF R: \$10.00 J. C. Sloan, Mckinley County

Darrell James, Hill (class member # AZA00000930)
28 Hilltop Court, HC 61 Box 771, Ramah, New Mexico

CMN 7011 0470 0002 1606 2168

- f. Be duly advised, do not redirect any funds due payable to me to the IRS, or other agency;
- g. Be duly advised, I am not employed by the defendants in this case.
- h. Be duly advised, I am not an employee: See my the AFFIDAVIT OF CITIZENSHIP, DOMICILE, AND TAX STATUS and attachment.
- i. Honor my position as I have herein specifically declined to allow or authorize any entity authority to authorize, proffer or file any type of the "Form W-4, Employee Allowance Certificate" or its equivalent on my behalf or regarding me.;
- j. Be duly advised, according to my demand (see # 3, above) upon you, that RG/2 must directly reimburse me without contest for any amounts redistributed by any justification: payable upon demand and without delay; and,
- k. Honor my citizenship, domicile and tax status as declared to you in the AFFIDAVIT OF CITIZENSHIP, DOMICILE, AND TAX STATUS Be duly advised, you are herein demanded to abide by my citizenship, domicile and tax status determination notification to you in my AFFIDAVIT OF CITIZENSHIP, DOMICILE, AND TAX STATUS and the WHY IT IS ILLEGAL FOR ME TO REQUEST OR TO USE A TAXPAYER IDENTIFICATION NUMBER (TIN), co-attachment and attachment.

9. I do not desire my citizenship, domicile and tax status to become a political- social football contest. I prefer this matter in our relationship to be managed without undue attention based upon my citizenship, domicile and tax status, in fact and by law.

Conclusion

10. "Darrell James; Hill" is my proper name, the man; I am not a fiduciary for an individual, fictitious person, or other such entity. I am not an employee.
I strove herein to be as complete as possible so to avoid any gaps in necessary information.
I am not employed by the defendants in this case; and, I have specifically declined to allow, authorize or to give any entity authority to authorize, proffer or file any type of the "Form W-4, Employee Allowance Certificate" or its equivalent on my behalf or regarding me. My AFFIDAVIT OF CITIZENSHIP, DOMICILE, AND TAX STATUS statement is attached.

Sincerely;



Darrell James; Hill

ENCLOSURES:

- 1) AFFIDAVIT OF CITIZENSHIP, DOMICILE, AND TAX STATUS,
- 2) WHY IT IS ILLEGAL FOR ME TO REQUEST OR TO USE A TAXPAYER IDENTIFICATION NUMBER (TIN)

2022-011769 MISC Page: 1931 of 2782
09/26/2022 03:35:37 PM Receipt #: 22-9381
Rec Fee: \$30.00 Darrell James Hill
Gila County, Az, Sadie Jo Bingham, Recorder



DOCH 361061

11/27/2012 01:09 PM Page: 29 of 178
AFF R:\$10.00 J. C. Sloan, McKinley County



DOCH 361076

11/27/2012 04:15 PM Page: 29 of 183
AFF R:\$10.00 J. C. Sloan, McKinley County



AFFIDAVIT OF CITIZENSHIP, DOMICILE, AND TAX STATUS

SECTION 1: SUBMITTER INFORMATION

1. Name	Darrell James, Hill		
2. Mailing Address (NOT a domicile)	28 Hilltop Court, HC 62 Box 771		
3. City	Ramah	4. State	New Mexico
5. Zip	[87321]	6. Country	The United States of America
7. Phone	505.783.2499	8. Email	djhil4yah@yahoo.com
9. Date of Birth:	1958 November 20	10. Place of Birth:	Ohio
11. citizenship:	Nonresident alien NON-individual: See explanation (following)	12. DOMICILE:	Transient Foreigner: See explanation (following)

11. CITIZENSHIP

I am a Constitutional but not statutory "Citizen": "national" but not "citizen" under federal law pursuant to 8 U.S.C. §1101(a)(21) and 8 U.S.C. §1452. Born in state of the Union and a "nonresident" (per 26 U.S.C. 7701(b)(1)(B)) but NOT an "alien" (per 26 U.S.C. 7701(b)(1)(A) or "Individual" (Per 26 CFR §1.441-1(c)(3)); "Stateless Person" as per Newman-Green v. Alfonso Larrain, 490 U.S. 826 (1989); Constitutional diversity of citizenship pursuant to U.S. const. Art. III, Section 2, but NOT statutory diversity pursuant to 28 U.S.C. §1332. Rebut the preceding if you disagree within 30 days or you stipulate it as truth.

12. DOMICILE:

I have chosen my domicile as Not within any government on earth.

I choose not to politically associate with any group or government on earth for my protection. The First Amendment to the Constitution protects my right of freedom from compelled association. I am a "transient foreigner" but not an "inhabitant" of the place where I live.

Choice of my domicile and becoming a taxpayer require my consent. Rebut the proceeding within 30 days if you disagree or forever be stopped from later challenging it.

13. FEDERAL FRANCHISES

13.1. Submitter is not subject to the Internal Revenue Code Subtitle A "trade or business" franchise/excise tax. Also called "income tax": "trade or business is defined in 26 U.S.C. §7701(a)(26) as "function of a public office" in the government. Those not engaged are a "foreign estate" pursuant to 26 U.S.C. §7701(a)(31).

PRIVATE RECIPIENTS OF THIS FORM: You are warned that you may NOT use any of the information provided by the Submitter of this form or any of the attached forms to submit to the government or for ANY commercial purpose. This means you may not use any of the information provided to prepare or submit any IRS information return, such as forms W-2, 1042S, 1098, 1099, K-1, etc. and that if you do you risk criminal prosecution under the provisions of 26 U.S.C. §§7206, 7207, 18 U.S.C. §654, and 18 U.S.C. §912. This document also constitutes an indemnification of all personal liability of the private recipient for failure to withhold or report. Submitter agrees to accept all legal consequences for following the context of this form and to become the Substitute Defendant in an action against the Private Recipient for following the requirements of this affidavit. This indemnification does NOT apply to government recipients.

GOVERNMENT RECIPIENTS OF THIS FORM: You are hereby legally notified that any information returns you may have received connected with me, such as W-2, 1042S, 1098, and 1099, are FALSE and FRAUDULENT and this submission constitutes a formal request to correct the false reports and criminally prosecute the submitter to 26 U.S.C. §§7206, 7207, 18 U.S.C. §654, and 18 U.S.C. §912 and civilly prosecute pursuant to 26 U.S.C. §7434 and 31 U.S.C. §3729. Any numbers associated with these reports are provided under duress and are not "Social Security Numbers" as defined in 20 CFR §422.104 but rather PRIVATELY issued "Nontaxpayer Identification Numbers" which are protected by copyright and private license agreement and may NOT be stored in any government computer system or used for ANY commercial purpose without violating the license agreement.

13.2. Submitter is a Social Security non-volunteer (See 42 U.S.C. Chapter 7). Any application on file are fraudulent and nullity for any one or more of the following reasons: 1. Never personally made application and therefore nonbinding; 2. Never consented to participate; 3. Cannot lawfully consent because not domiciled on federal territory and not a "U.S. citizen" per 8 U.S.C. §1401 or a "permanent resident" at the time of application in violation of 20 CFR §422.104; 4. Am not a fiduciary acting with any capacity contract with the federal government.

2022-011769 MISC Page: 1932 of 2782

09/26/2022 03:35:37 PM Receipt #: 22-9381
 Rec Fee: \$30.00 Darrell James Hill
 Gila County, Az, Sadie Jo Bingham, Recorder



DOCH 361061

ship, 11/27/2012 01:09 PM Page: 30 of 178
 AFF R:\$10.00 J. C. Sloan, McKinley County



DOCH 361076

11/27/2012 04:15 PM Page: 30 of 183
 AFF R:\$10.00 J. C. Sloan, McKinley County

AFFIDAVIT OF CITIZENSHIP, DOMICILE, AND TAX STATUS

Date that UNLAWFUL SSA participation was retroactively terminated was May 22, 2006 (Date SSA Form 521 was mailed to SSA and IRS).

- 13.3. Submitter is not a Federal elected or appointed "public officer".
- 13.4. Submitter is not an "employee" as defined in 26 U.S.C. §3401(c) and 26 CFR §31.3401(c)-1.
- 13.5. Submitter has a State-issued driver's license. Corporate (not de jure) State name: Arizona
- 13.6. Submitter has a State issued marriage license.
- 13.7. Submitter does not possess an Attorney license (Admitted to practice by state-supreme Court).
- 13.8. Submitter has no lawful federal government identifying number.

WARNING: You may not use any government issued identifying number in connection with the Submitter, such as a Social Security Number (SSN) as defined in 20 CFR 422.103(d), Taxpayer Identification Number (TIN) as defined in 26 U.S.C. 6109, or Employer Identification Number (EIN) as defined in 26 U.S.C. 6019.

Submitter:

1. Would be violating the law to either request or use a Taxpayer Identification Number. See **AFFIRMATION, WHY IT IS ILLEGAL FOR ME TO REQUEST OR USE A TAXPAYER IDENTIFICATION NUMBER** (attached).
2. Is not required to have or to use a Social Security Number or Taxpayer Identification Number pursuant to 31 CFR §103.34(a)(3)(x) and 31 CFR §306.10, Note 2.
3. Does not participate and is not lawfully eligible to participate in Social Security or the "trade or business" excise taxable franchise described in 26 U.S.C. Subtitle A.
4. Is not an "alien" for which an Individual Taxpayer Identification Number may lawfully be used pursuant to 26 CFR §301.6109-1(d)(3). Nonresident aliens are NOT "aliens" are not equivalent. A human being who is a "national" can be a "nonresident alien" with being an "alien". See 26 U.S.C. §7701(b)(1)(A) and 26 U.S.C. §7701(b)(1)(B).
5. My not lawfully use or possess any government identifying number because it is "public property" which belongs to the government pursuant to 20 CFR §422.103(d). Only "public officers" on official business may lawfully use public property, and only in strict accordance with law for the benefit of the government and not them as private individuals.
6. Is appearing as a private person and not a public officer. If you compel me to use a government identifying number, you are an accessory to criminal conversion of private property to a public use and a public purpose if you connect me or my assets with a public number in violation of 18 U.S.C. § 654. You could end up in jail for ten years if you put an identifying number on any records pertaining to me or my property, assets, or my earnings from PRIVATE employment.
7. Has been a victim of identity theft, compelled association, and conversion by the government and its agents in banks and financial institutions in the past by unlawfully and involuntarily connecting them with knowingly false and fraudulent identifying numbers in criminal violation of 18 U.S.C. §1028A, and a civil violation of 42 U.S.C. §408(a)(7) and 42 U.S.C. §405(c)(2)(C)(i). He would like to prevent a recurrence of this behavior again.
8. Will file a criminal complaint in connection with the use of any government issued identifying number connected with his exclusively PRIVATE life, property, and liberty and vociferously prosecute all those who unlawfully compel him to use a knowingly false number or any number at all in order to obtain any service or product in violation of 42 U.S.C. §408.

WARNING: Any Social Security Number or Taxpayer Identification Number you have on file is FALSE and must be removed from your records. Failure to abide by this absolute requirement of law is a criminal violation of 18 U.S.C. §1028(a)(7); 18 U.S.C. §1028A, and a civil violation of 42 U.S.C. §408 and 42 U.S.C. §405(c)(2)(C)(i).

14. DOMICILE AND RESIDENCE

1. My domicile and NOT "residence" is that indicated earlier on Item 12 above.
2. My domicile is outside the statutory but not constitutional "United States" and outside of federal territory. The Term "statutory United States" includes all statutory definitions of "United States" within any act of Congress.
3. I am not a statutory "resident". All "residents" are statutory "aliens" per 26 U.S.C. §7701(b)(4).
4. I DO NOT have a statutory "residence" anywhere within the statutory "United States" per 26 CFR §2.871-2(b) because I am not a statutory "alien".

If you believe that the term "residence" includes the domicile of those who are non-citizen nationals, nonresident alien NON-individuals, please produce a statute that expressly includes this status within the meaning of the term "residence".

15. TAX WITHHOLDING LEGAL REQUIREMENTS

Affidavit of Citizenship,

DOCH 361061

11/27/2012 01:09 PM Page: 31 of 178
AFF R:\$10.00 J. C. Sloan, McKinley County



2022-011769 MISC Page: 1933 of 2782

09/26/2022 03:35:37 PM Receipt #: 22-9981
Rec Fee: \$30.00 Darrell James Hill
Gila County, Az. Sadie Jo Bingham, Recorder

DOCH 361076

11/27/2012 04:15 PM Page: 31 of 168
AFF R:\$10.00 J. C. Sloan, McKinley County

AFFIDAVIT OF CITIZENSHIP, DOMICILE, AND TAX STATUS

5. **WARNING:** You may not lawfully withhold any amount from proceeds due to me. The remainder of this section provides legally admissible evidence proving why this is.
6. Your withholding is ONLY on "wages" as legally defined in 26 U.S.C. §3401. The earnings of nonresident alien NON-individuals not engaged in a "trade or business" as legally defined are excluded from "wages" per 26 U.S.C. §3401(a)(6) and 26 U.S.C. §3401(a)(11) and therefore may not lawfully become the subject of tax withholding. If you withhold, you will therefore be guilty of the following crimes:
- 6.1. **18 U.S.C. §654:** Conversion of private property to a "public use" and a "public office". You are converting my PRIVATE proceeds as a class member into a public purpose and a "public office" by fraudulently and falsely connecting same with a "trade or business".
- 6.2. **18 U.S.C. §201:** Bribery of public officials and witnesses. You are bribing public officials who will receive the money you STOLE from me in violation of the law. The punishment is a fine and up to 15 years in jail. I remind you that all tax withholdings are classified as "gifts" by the IRS. See IRS Document 6209, pp. 4-1 and 4-2, which identify W-2 forms as "Estate and gift taxes". All tax withholdings are "gifts" to public officials that also constitute bribes.
- 6.3. **18 U.S.C. §1956(a)(1)(A)(ii):** Money laundering. You are laundering unlawfully withheld proceeds. The punishment is a fine up to \$500,000 and imprisonment for up to twenty years.
7. IRS Publication 515 indicates that nonresident alien individuals who give you IRS form W-8BEN are exempt from backup withholding. This requirement is also found in 26 U.S.C. § 3401(a)(6) or 26 CFR §31.3401(a)(6)-1(b). This Affidavit serves the equivalent of IRS Form W-8BEN because IRS doesn't have a form for those who are "nonresident aliens" but who are not "individuals", "persons", or "taxpayers".

"Foreign persons who provide Form W-8BEN, Form W-8ECI, or For W-8EXP (or applicable documentary evidence) are exempt from backup withholding and Form 1099 reporting."
[IRS Publication 515, Year 2001, p.3]

8. You **MAY NOT** lawfully tamper with, reject, redact any portion of, or alter any withholding form that I give you. You must accept them AS IS and may not lawfully threaten me to change them. If you do, you could be prosecuted for extortion.

"The employer is not authorized to alter the form or to dishonor the employee's claim. The certificate goes into effect automatically in accordance with certain standards enumerated in §3402(f)(3)."
[U.S. v. Malinowski, 347 F.Supp. 347 (1972)]

9. The proceeds connected with our relationship do not constitute "income" and therefore cannot be the subject of any tax or withholding or reporting within the Internal Revenue Code. The only definition of "income" in the Internal Revenue code is found in 26 U.S.C. §643(b) and it includes ONLY the earnings of a trust or estate. I am not representing a domestic trust or estate. My earnings and my entire estate instead are a "foreign estate" pursuant to 26 U.S.C. §7701(a)(31).

10. Any earnings that result from our relationship do not originate from "sources within the United States". The term "United States" is defined below.

If you dispute this definition, please provide the definition that expressly identifies states of the Union as being included in the meaning of "United States".

TITLE 26 > Subtitle F > CHAPTER 79 > Sec. 7701.
Sec. 7701. - Definitions

(a) Definitions

(9) United States

The term "United States" when used in a geographical sense includes only the States and the District of Columbia.

(10) State

The term "State" shall be construed to include the District of Columbia, where such construction is necessary to carry out provisions of this title.

**TITLE 4 – FLAG AND SEAL, SEAT OF GOVERNMENT, AND
CHAPTER 4 – THE STATES**

DOCH 361061

Affidavit of Citizenship.

11/27/2012 01:09 PM Page: 32 of 178
AFF R:\$10.00 J. C. Sloan, McKinley County

2022-011769 MISC Page: 1934 of 2782
09/26/2022 03:35:37 PM Receipt #: 22-9381
Rec Fee: \$30.00 Darrell James Hill
Gila County, AZ, Sadie Jo Bingham, Recorder

DOCH 361076

11/27/2012 04:15 PM Page: 32 of 183
AFF R:\$10.00 J. C. Sloan, McKinley County

AFFIDAVIT OF CITIZENSHIP, DOMICILE, AND TAX STATUS

Sec. 1210. Same; definitions

(d) The term "State" includes any Territory or possession of the United States.

"Expression unius est exclusio alterius. A maxim of statutory interpretation meaning that the expression of one thing is the exclusion of another. Burgin v. Forbes, 293 Ky. 456, 169 S.W.2d 321, 325; Newblock v. Bowles, 170 Okl. 487, 40 P.2d 1097, 1100. Mention of one thing implies exclusion of another. When certain persons or things are specified in a law, contract, or will, an intention to exclude all others from its operation may be inferred. Under this maxim, if statute specifies one exception to a general rule or assumes to specify the effects of a certain provision other exceptions of effects are excluded."

[Black's Law Dictionary, Sixth Edition, p. 581]

11. The financial transactions likely to result from relationship are excluded from (not "subject to" but not "exempt") taxation pursuant to the following authorities and therefore not subject to withholding:

- 11.1. 26 U.S.C. § 861(a)(3)(C)(i): Earning from labor of "nonresident aliens" not engaged in a "trade or business" and working in the "United States" is not deemed to be income from sources within the "United States".
- 11.2. 26 U.S.C. § 3401(a)(6): Nonresident aliens do not earn "wages".
- 11.3. 26 U.S.C. § 1402(b): Nonresident aliens do not earn "self-employment income".
- 11.4. 26 U.S.C. § 864(b)(1)(A): Earning of "nonresident aliens" working for foreign employers such as private employers do not have earnings associated with a "trade or business in the United States"
- 11.5. 26 CFR § 31.3401(a)(6)-1(b): Remuneration of nonresident aliens outside the "United States" is not subject to taxation.
- 11.6. 26 CFR § 1.872-2(f): Earning of nonresident aliens outside "United States" do not constitute "gross income".
- 11.7. 26 CFR § 1.871-7(a)(4): Nonresident aliens not engaged in a "trade or business" earn no "gross income".

12. Tax withholding is only appropriate for those having a tax liability. A nonresident alien NON-individual such as the submitter with no "income" or earning from "sources with the United States" under 26 U.S.C. § 871 can have no tax liability. If you think you, as a private employer or private Institution constitutes a "source within the United States", then why did the IRS Internal Revenue Manual say the following and where are the states of the Union included in "United States" as defined above?:

IRM 5.14.10.2 (09-30-2004)

Payroll Deduction Agreements

2. Private employers, states, and political subdivisions are not required to enter into payroll deduction agreements. Taxpayers should determine whether their employers will accept and process executed agreements before agreements are submitted for approval or finalized.

[http://www.irs.gov/irm/part5/ch14s10.html]

13. You can only be an "employer" if I am an "employee", according to 26 U.S.C. § 3401(d). I am NOT an "employee", because all "employees" are "public officers" engaged in a "trade or business" who work for the United States government as the equivalent of "temps or "Kelly Girls" on loan to private employers such as you. I DO NOT consent to act in such capacity, and therefore you cannot be an "employer" in the context of me"

26 CFR § 31.3401(c)-1 Employee:

"...the term [employee] includes [is limited to] officers and employees, whether elected or appointed, of the United States, a [federal] State, Territory, Puerto Rico or any political subdivision, thereof, or the District of Columbia, or any agency of instrumentality of any one of more of the foregoing. The term 'employee' also includes an officer of a corporation."

26 U.S.C. § 3401(c) Employee

For purposes of this chapter, the term "employee" includes [is limited to] an officer, employee, or elected official of the United States, a State, or any political thereof, or the District of Columbia, or any agency or instrumentality of any one or more of the foregoing. The term "employee" also includes an officer of a corporation.

8 Federal Register, Tuesday, September 7, 1943, § 40-

Affidavit of Citizenship

DOCH 361061

11/27/2012 01:09 PM Page: 33 of 178
AFF R: \$10.00 J. C. Sloan, Mokinley County

2022-011769 MISC Page: 1935 of 2782

09/25/2022 03:35:37 PM Receipt #: 22-9381

James Hill

Darrell James Hill

Sadie Jo Bingham, Recorder

Gila County, AZ

11/27/2012 04:15 PM Page: 33 of 183

AFF R: \$10.00 J. C. Sloan, Mokinley County

DOCH 361076

11/27/2012 04:15 PM Page: 33 of 183
AFF R: \$10.00 J. C. Sloan, Mokinley County

AFFIDAVIT OF CITIZENSHIP, DOMICILE, AND TAX STATUS

Employee: "The term employee specifically includes officers and employees whether elected or appointed, of the United States, a state, territory, or political subdivision thereof or the District of Columbia or any agency or instrumentality of any one or more of the foregoing."

If you disagree with this item, please rebut the foregoing within 30 days or be held in default and estoppels to challenge later.

14. You are only liable to withhold if you are an "employer" and if I receive "wages". 26 CFR 31.3403-1, 26 CFR §31.3111-4, 26 CFR §3102-1(c). The only way I can receive "wages" is to sign a contract called a W-4 absent duress consenting to call what proceeds I receive "wages" as legally defined but not commonly understood. If I don't sign the contract, then I don't earn "wages" subject to any withholding or reporting:

"Every man has a natural right to the fruits of his own labor, is generally admitted, and no other person can rightfully deprive him of those fruits, and appropriate them against his will..."
[The antelope, 23 U.S. 66: 10 Wheat 66, 6 L.Ed. 268 (1825)]

"Included in the rights of personal liberty and the right of private property—partaking of the nature of each—is the right to make contracts for the acquisition of property. Chief among such contracts is that of personal employment, by which labor and other services are exchanged for money or other forms or property."

"...The right of a person to sell his labor upon such terms as he deems proper is, in its essence, the same as the right of the purchaser of labor to prescribe the conditions under which he will accept such labor from the person offering to sell it."

26 CFR §31.3401(a)-3 Amounts deemed wages under voluntary withholding agreements

(a) In general.

Notwithstanding the exceptions to the definition of wages specified in section 3401(a) and the regulations thereunder, the term "wages" includes the amounts described in paragraph (b)(1) of this section with respect to which there is a voluntary withholding agreement in effect under section 3402(p). References in this chapter to the definition of wages contained in section 3410(a) shall be deemed to refer also to this section (§31.3401(a)-3).

Title 26 : Internal Revenue

PART 31—EMPLOYMENT TAXES AND COLLECTION OF INCOME TAX AT SOURCE

Subpart E—Collection of Income Tax at Source

§31.3402(p)-1 Voluntary withholding agreements

(a) In general.

An employee and his employer may enter into an agreement under section 3402(b) to provide for the withholding of income tax upon payments of amounts described in paragraph (b)(1) of §31.34(a)-3, made after December 31, 1970. And agreement may be entered into under this section only with respect to amounts which are includible in the gross income of the employee under section 61, and must be applicable to all such amounts paid by the employer to the employee. The amount to be withheld pursuant to an agreement under section 3402(p) shall be determined under the rules contained in section 3402 and the regulations thereunder. See §31.3405(c)-1, Q&A-3 concerning agreements to have more than 20-percent Federal income tax withheld from eligible rollover distributions with the meaning of section 402.

5. If I never give you an IRS for W-4 and thereby consent to call what proceeds I am due "wages" as defined in the Internal Revenue Code, then you can't lawfully withhold or report anything:

15.1. Everything that goes on the IRS form W-2 constitutes "wages" as legally defined and not commonly understood.

Affidavit of Citizenship,

DOC# 361061

11/27/2012 01:09 PM Page: 34 of 178
AFF R:\$10.00 J. C. Sloan, McKinley County



2022-011769 MISC Page: 1936 of 2782

09/26/2022 03:35:37 PM Receipt #: 22-9381

Rec Fee: \$30.00 Darrell James Hill

City County: Pz, Sadie JO Brinsnam, Recorder



DOC# 361076

11/27/2012 04:15 PM Page: 34 of 183
AFF R:\$10.00 J. C. Sloan, McKinley County



AFFIDAVIT OF CITIZENSHIP, DOMICILE, AND TAX STATUS

15.2 Tax withholding ONLY pertains to "wages" as legally defined and NOT all earnings. The U.S. Supreme Court confirmed this:

"We must reject in this case, as we have rejected in cases arising under the Corporation Excise Tax Act of 1909 (Doyle, Collector, v. Mitchell's Brother Co., 247 U.S. 179, 38 Sup. Ct. 467, 62 L. Ed. --) the broad contention submitted on behalf of the government that all receipts—everything that comes in—are income with the proper definition of the term 'gross income.' And that the entire proceeds of a conversion of capital assets, in whatever form and under whatever circumstances accomplished, should be treated as gross income. Certainly the term "income" has no broader meaning in the 1913 act than in that of 1909 (See Stratton's Independence v. Howbert, 231 U.S. 399, 416, 417 S., 34 Sup. Ct. 136), and for the present purpose we assume there is no difference in its meaning as used in the two acts."
[Southern Pacific Co., v. Lowe, 247 U.S. 330, 335, 38 S. Ct 540 (1918)]

15.3. If you are ordered by the IRS, et al., to withhold proceeds because I refuse to submit an IRS form W-4, then you must withhold and report ONLY on "wages" as statutorily defined and limited pursuant to the I.R.C. "trade or business" franchise agreement. I don't earn "wages" if I never consented to call them "wages" using a private contract called an IRS form W-4.

16. On the subject of unlawful withholding the Bible say the following. "Wages" as used below implies the ordinary and excludes the statutory definition:

"Woe to him who builds his house by unrighteousness
And his chambers by injustice,
Who [whether individual or government] uses his neighbor's service without wages
And give him nothing for his work
[Jer. 22:13, Bible, NKJV]

"Come now, you rich, weep and howl for your miseries that are coming upon you! Your riches are corrupted, and your garments are moth-eaten. Your gold and silver are corroded, and their corrosion will be a witness against you and will eat your flesh like fire. You have heaped up treasure in the last days. **Indeed the wages of the laborers who mowed your fields, which you kept back by fraud, cry out; and the cries of the reapers have reached the ears of the Lord of Sabaoth.** You [business owner who control the purse of the workers] have lived on the earth in pleasure and luxury; you have fattened your hearts as in a day of slaughter. You have condemned, you have murdered the just, he does not resist you."
[James 5:1-6, Bible, NKJV]

"You shall not cheat your neighbor, nor rob him. The wages of him who is hired shall not remain with you all night until morning.
[Lev. 19:13, Bible, NKJV]

6. TAX REPORTING LEGAL REQUIREMENTS:

WARNING: It is a criminal offense to file information returns against any payments you make in connection with our relationship. Filing of false information returns carries severe civil and criminal penalties. Information returns include IRS Forms W-2, 1042S, 1098, and 1099.

can only earn "wages" reportable on an IRS form W-2 if I am lawfully engaged in a "public office" in the U.S. Government as required by 26 U.S.C. §6041(a). Voluntarily signing a contract/agreement called an IRS form W-4 is the only way that a nonresident alien NON-individual not engaged in a "trade or business" can engage in such a "public office" per 26 CFR 31.3401(a)-3(a), and 26 CFR 31.3402(p)-1. Otherwise, it is a crime to impersonate a public officer in violation of 18 U.S.C. §912 to file an information return. If you file any kind of information return relating to me, you will be guilty of conspiracy to commit all the following crimes and civil infractions:

- 1.1. False information returns submitted in violation of 26 U.S.C. §7434. Punishment is all attorney fees plus twice the false amount reported.
- 1.2. Impersonating a public officer in violation of 18 U.S.C. §912. Punishment is a fine and up to three years in jail. Only "public officers" can act as "taxpayers", and you are creating a false presumption that I am a "taxpayer" by filing false information returns.
- 1.3. Conversion of private property to a public use, public purpose, and public office as a "withholding agent" in violation of 18 U.S.C. §654.

Affidavit of Citizenship,

DOCH 361061

11/27/2012 01:09 PM Page: 35 of 178
AFF R:\$10.00 J. C. Sloan, McKinley County

2022-011769 MISC Page: 1937 of 2782

09/26/2022 03:35:37 PM Receipt #: 22-9381

Rep Fee: \$30.00 Darrell James Hill
Gila County, Az Sadie Jo Bingham, Recorder



DOCH 361076

11/27/2012 04:15 PM Page: 35 of 183
AFF R:\$10.00 J. C. Sloan, McKinley County



AFFIDAVIT OF CITIZENSHIP, DOMICILE, AND TAX STATUS

- 1.4. Impersonating a public officer in violation of 18 U.S.C. §911. Punishment is a fine and up to three years in jail. Only *statutory* and not *constitutional* "U.S. citizens" can lawfully act as "public officers" engaged in a "trade or business" and I am NOT a statutory "U.S. citizen" pursuant to 8 U.S.C. §1401 but rather a non-citizen national.
- 1.5. False information returns in violation of 26 U.S.C. §7206. Punishment is up to a \$100,000 fine and 3 years in jail to file a false information return.
- 1.6. False information returns in violation of 26 U.S.C. §7207. Punishment is up to \$10,000 and 1 year in jail to submit a false information return.
- 1.7. Perjury in violation of 18 U.S.C. §1001 and 18 U.S.C. §1621. The IRS Forms W-3 and 1096 submitted with the information return is signed under penalty of perjury and verifies the accuracy of the accompanying information return. These forms are submitted as a government officer and agent called a "withholding agent" defined in 26 U.S.C. 7701(a)(16). Those forms are FRAUDULENT now that you have been notified that they are false and you willfully refuse to either stop filing the false report or correct the false reports already filed.

2. IRS Publication 515 indicates that nonresident aliens who give you IRS form W8BEN are exempt for 1099 reporting. This form serves the equivalent purpose and is a superset of that form.

*"Foreign persons who provide Form W-8BEN, Form W-8ECI, or Form W-EXP (or applicable documentary evidence) are exempt from backup withholding and Form 1099 reporting."
[IRS Publication 515, Year 2001, p3]*

3. 26 U.S.C. §6041 says that only earnings connected with a "trade or business" may be reported on an information return such as IRS forms W-2, W-3, 1042-S, 1096, and 1099.

TITLE 26 > Subtitle F > CHAPTER 61 > Subchapter A > PART III > § 6041
§ 6041. Information at source

(a) Payments of \$600 or more

All persons engaged in a trade or business and making payment in the course of such trade or business to another person, of rent, salaries, wages, premiums, annuities, compensations, remunerations, emoluments, or other fixed or determinable gains, profits and income (other than payments to which section 6042 (a)(1), 6044 (a)(1), 6047 (e), 6049 (a), or 6050N (a) applies, and other than payments with respect to which a statement is required under the authority of section 6042 (a)(2), 6044 (a)(2), or 6045), of \$600 or more in any taxable year, or in the case of such payments made by the United States, the officers or employees of the United States having information as to such payments and required to make returns in regard thereto by the regulations hereinafter provided for, shall render a true and accurate return to the Secretary, under such regulations and in such form and manner and to such extent as may be prescribed by the Secretary, setting forth the amount of such gains, profits, and income, and the name and address of the recipient of such payment.

4. None of the proceeds connected with our relationship pertains to a "trade or business" as statutorily defined below and therefore is not subject to reporting:

26 U.S.C. Sec. 7701(a)(26)

"The term "trade or business" includes the performance of the functions of a public office."

5. The term "income" is defined in 26 U.S.C. §643(b), and only "income" may be reported. Since I am NOT an "estate trust", I earn no reportable "income".

TITLE 26 > Subtitle A > CHAPTER 1 > Subchapter J > PART I > Subpart A > §643
§643. Definitions applicable to subparts A, B, C, and D

(b) Income

For purpose of this subpart and subparts B, C, and D, the term "income, when not preceded by the words "taxable", "distributable net", "undistributed net", or "gross", means that amount of income of the estate or trust for the taxable year determined under the terms of the governing instrument and the applicable local law. Items of gross income constituting extraordinary dividends or taxable stock

Affidavit of Citizenship, Domicile, and Tax Status

Page 7 of 178

2022-011769 MISC Page: 1938 of 2782
09/25/2022 03:35:37 PM Receipt #: 22-9381
Rep Fee: \$30.00 Darrell James Hill
Gila County, Az; Sadie Jo Bingham; Recorder

DOCH 361061

11/27/2012 01:09 PM Page: 36 of 178
AFF R: \$10.00 J. C. Sloan, McKinley County

DOCH 361076

11/27/2012 04:15 PM Page: 36 of 183
AFF R: \$10.00 J. C. Sloan, McKinley County

AFFIDAVIT OF CITIZENSHIP, DOMICILE, AND TAX STATUS

dividends which the fiduciary, acting in good faith, determines to be allocable to corpus under the terms of the governing instrument and applicable local law shall not be considered income.

2
3

IRS Form 1042-S may only be prepared in the case of statutory "nonresident aliens" (per 26 U.S.C. §7701(b)(1)(B)) who have "income" from "sources within the statutory but not constitutional "United States" that is not connected with a "trade or business" and therefore constitutes "gross income" with the meaning of 26 U.S.C. §61. All such sources are expressly indicated in 26 U.S.C. §871(a). All of these sources are government payments. The transactions likely to occur between us are NOT government payments and are not listed in 26 U.S.C. §871(a), and therefore may not lawfully be reported.

SECTION 2: AFFIDAVIT OF TAX STATUS

Human being (but not statutory "Person") who signed this form hereby affirms under penalty of perjury form WITHOUT the statutory "United States" per 28 U.S.C. §1746(1) that:

1. Submitter has NO tax liability or "gross income" pursuant to 26 CFR §1.872-2(f), 26 CFR §1.871-1(a), and 26 U.S.C. §861(a)(C)(i) and therefore no need to deduct or withhold.
2. Submitter is not a statutory "taxpayer" as defined in 26 U.S.C. §7701(a)(14) and not subject to the revenue laws.

"Revenue Laws relate to taxpayers [instrumentalities, officers, employees, and elected officials of the Federal Government] and not to non-taxpayers [American Citizens/American Nationals not subject to the exclusive jurisdiction of the Federal Government and not engaged in the "trade or business" franchise as a public officer]. The latter are without their scope. No procedures are prescribed for non-taxpayers and no attempt is made to annul any of their Rights or Remedies in due course of law. With them [non-taxpayers] Congress does not assume to deal and they are neither of the subject nor of the object of federal revenue laws."

[Economy Plumbing & Heating v. U.S., 470 F2d. 585 (1972)]

3. Submitter is not "exempt" or an "exempt individual" as defined in 26 U.S.C. §7701(b)(5) because one must otherwise be subject to the I.R.C. to be such a legal "person". Rather, Submitter is "not subject" to Internal Revenue Code Subtitle A franchise agreement and is a nonresident. Since IRS forms very deliberately do not have a block for "not subject" and are only for use by those who are "taxpayers", Submitter had to make his own form, THIS form, to avoid committing perjury on a government form in describing his status under penalty of perjury. Those who are "not subject" are described NOT as a "person, "individual", or "taxpayer", but simply as "foreign" or a "foreign estate" in 26 U.S.C. §7701(a)(31).

TITLE 26 > Subtitle F > CHAPTER 79 > § 7701 §7701. Definitions

(a) Definitions

(31) Foreign estate or trust

(A) Foreign estate

The term "foreign estate" means an estate the income of which, from sources the United States which is not effectively connected with the conduct of a trade or business within the United States, is not includible in gross income under subtitle A.

4. Submitter is a "nonresident" as statutorily defined pursuant to 26 U.S.C. § 7701(b)(1)(B) but not a "nonresident alien individual". A "nonresident alien" is defined as one who is "neither a citizen nor a resident" of the "United States", which is exactly what an "American National", or national' born in a state of the Union who is not domiciled on federal territory in the "United States" is. The only withholding form that a "nonresident" who is neither a statutory "alien" (per 26 U.S.C. §7701(b)(1)(A)) nor an "individual" (per 26 CFR §1.1441-1(c)(3) and 5 U.S.C. §2105(a)) and who is not engaged in federal franchises can fill out is a W-8BEN with block 3 modified to add the word "nontaxpayer" or "human being" to it. All statutory "taxpayers" and "individuals" are "aliens" per 26 CFR §1.1441-1(c)(3) and public officers in the national and not state government, and therefore submitter cannot check the "individual" block of the W-8BEN form without committing perjury. Even statutory "U.S. Citizens" per 26 CFR §1.1-1(c) and 26 U.S.C. §3121(e) must be aliens in relation to a foreign country under a tax treaty per 26 U.S.C. §911 in order to be "taxpayers".
5. Submitter is *not* engaged in a "trade or business", which is defined in 26 U.S.C. § 7701(a)(26) as "the functions of a public office". Receipt of earnings from the District of Columbia in connection with a "trade or business" under 26 U.S.C. §871(b)

Affidavit of Citizenship,

DOCH 361061

11/27/2012 01:09 PM Page: 37 of 178
AFF R:\$10.00 J. C. Sloan, McKinley County



2022-011769 MISC Page: 1939 of 2782
09/26/2022 03:35:37 PM Receipt #: 22-9381
Rec Fee: \$30.00 Darrell James Hill
Gila County, AZ Sadie Jo Bingham, Recorder

DOCH 361076

11/27/2012 04:15 PM Page: 37 of 183
AFF R:\$10.00 J. C. Sloan, McKinley County

AFFIDAVIT OF CITIZENSHIP, DOMICILE, AND TAX STATUS

or not connected under **26 U.S.C. 871(a)** are the only types of "gross income" or "taxable income" that nonresidents who are not aliens can have under I.R.C. **Subtitle A**.

6. Submitter is a "**transient foreigner**" but not a statutory "foreign person" or statutory "alien" in respect to the national government and federal territory. A human being or artificial entity such as a state corporation domiciled in a state of the Union is a "transient foreigner" but not a "person", "individual", or "foreign person" for the purposes of the Internal Revenue Code because the term "United States" is defined in **26 U.S.C. §7701(a)(9)** and (a)(10) as the District of Columbia and is nowhere expressly expanded to include any state of the Union.
7. Submitter is not in receipt of any treaty benefit under the terms of an income tax treaty with a foreign country.
8. Submitter has not made an election to be treated as a "resident alien" as defined in **26 U.S.C. 7701(b)(1)(A)** under the authority of **26 U.S.C. §6013(g)** and (h).
9. Submitter is not a statutory "individual" as defined in 26 CFR §1.1441-1(c)(3) or a "person" as defined in **26 U.S.C. §7701(c)** because not domiciled or resident on federal territory and not eligible or consensually participating in any federal franchise or "benefit" in the context of this exclusively private and not public transaction. As such, he is not a "public officer" with the government but rather a private human being. The only thing the government can regulate or tax are public activities, public officers, and public "employees" who are the only "persons" mentioned in the I.R.C. franchise per 26 U.S.C. §7343 and 6671(b). It is otherwise unconstitutional to regulate exclusively private conduct.

"The power to 'legislate generally upon' [the PRIVATE] life, liberty, and property, as opposed to the 'power to provide modes of redress' against offensive state [e.g. 'public officer'/'employee'] action, was 'repugnant' to the Constitution. Id., at 15. See also United States v. Reese, 92 U.S. 214, 218 (1876); United States v. Harris, 106 U.S. 629, 639 (1883); James v. Bowman, 190 U.S. 127, 139 (1903). Although the specific holdings of these early cases might have been superseded or modified, see, e.g., Heart of Atlanta Motel, Inc. v. United States, 379 U.S. 241 (1964); United States v. Guest, 383 U.S. 745 (1966), their treatment of Congress' §5 power as corrective or preventive, not definitional, has not been questioned."

[City of Boerne v. Flores, Archbishop of San Antonio, 521 U.S. 507 (1997)]

10. Submitter is **NOT** subject to IRS Form 1099 reporting, withholding, or backup withholding pursuant to **26 U.S.C. §3401(a)(6)** or **26 CFR §31.3401(a)(6)-1(b)**:

"Foreign persons who provide Form W-8BEN, Form W-8ECI, or Form W-8EXP (or applicable documentary evidence) are exempt from backup withholding and Form 1099 reporting."
[IRS Publication 515, year 2001, p. 3]

11. Submitter is not a "**U.S. person**" as statutorily defined pursuant to **26 U.S.C. 7701(a)(30)**. The term "U.S. person" is statutorily defined as follows:

TITLE 26 > Subtitle F > CHAPTER 79 > Sec. 7701.
Sec. 7701. - Definitions

(a)(30) United States person

The term "United States person" means -

(A) a citizen or resident of the United States,

(B) a domestic partnership,

(C) a domestic corporation,

(D) any estate (other than a foreign estate, within the meaning of paragraph (31)), and

(E) any trust if -

(i) a court within the United States is able to exercise primary supervision over the administration of the trust, and

(ii) one or more United States persons have the authority to control all substantial decisions of the trust.

12. The term "United States" as used in "U.S. person" above is defined in **26 U.S.C. § 7701(a)(9)** and (a)(10) as follows:

TITLE 26 > Subtitle F > CHAPTER 79 > Sec. 7701. [Internal Revenue Code]
Sec. 7701. - Definitions

Affidavit of Citizenship, I

DOCH 361061

11/27/2012 01:09 PM Page: 38 of 178
AFF R: \$10.00 J. C. Sloan, McKinley County

2022-011769 MISC Page: 1940 of 2782
09/26/2022 03:35:37 PM Receipt #: 22-9381
Rec Fee: \$30.00 Darrell James Hill
Gila County, Az, Sadie Jo Bingham, Recorder

DOCH 361076

11/27/2012 04:15 PM Page: 38 of 183
AFF R: \$10.00 J. C. Sloan, McKinley County

AFFIDAVIT OF CITIZENSHIP, DOMICILE, AND TAX STATUS

(a) When used in this title, where not otherwise distinctly expressed or manifestly incompatible with the intent thereof—

(9) United States

The term "United States" when used in a geographical sense includes on the States and the District of Columbia.

(10) State

The term "State" shall be construed to include the District of Columbia, where such construction is necessary to carry out provisions of this title.

13. Pursuant to the rules for statutory construction, if the states of the Union are not mentioned anywhere in Subtitle A of the Internal Revenue code and are not included in the definition of "United States" above, they can be safely assumed to be EXCLUDED by implication:

"Expressio unius est exclusio alterius. A maxim of statutory interpretation meaning that the expression of one thing is the exclusion of another. Burgin v. Forbes, 293 Ky. 456, 169 S.W.2d 321, 325; Newblock v. Bowles, 170 Okl. 487, 40 P.2d 1097, 1100. Mention of one thing implies exclusion of another. When certain persons or things are specified in a law, contract, or will, an intention to exclude all others from its operation may be inferred. Under this maxim, if statute specifies one exception to a general rule or assumes to specify the effects of a certain provision other exceptions of effects are excluded."
[Black's Law Dictionary, Sixth Edition, p. 581]

14. Nonresidents not engaged in a "trade or business" such as the Submitter are not required to provide identifying number to open financial accounts. The regulation below mentions "nonresident aliens", and nonresidents who are not statutory "aliens" must be treated the same:

Title 31: Money and finance: Treasury
PART 103—FINANCIAL RECORDKEEPING AND REPORTING OF CURRENCY AND FOREIGN TRANSACTIONS
Subpart C—Records Required To Be Maintained
§103.34 additional records to be made and retained by banks.

(a)(3) A taxpayer identification number required under paragraph (a)(1) of this section need not be secured for accounts or transactions with the following:

(x) non-resident aliens who are not engaged in a trade or business in the United States.

In instances described in paragraph (a)(3), (viii) and (ix) of this section, the bank shall, within 15 days following the end of any calendar year in which the interest accrued in that year is \$10 or more use its best effort to secure and maintain the appropriate taxpayer identification number or application form therefor.

15. It amounts to "compelled to association" in violation of the First Amendment to force me to associate with and be identified as a "U.S. person" (under 26 U.S.C. § 7701(a)(30)), a statutory "U.S. Citizen" (under 8 U.S.C. §1401), or a "taxpayer" (under 26 U.S.C. §7701(a)(14)) or any status OTHER than that described above. I would also be committing perjury under penalty of perjury to sign any government form that identified me as any of the three types of entities.

16. I will not allow you to compel me to participate in the "trade or business" franchise or contract with the government by changing my status to be anything other than that described herein. All franchises are contracts between the grantor and the grantee:

As a rule, franchises spring from contracts between the sovereign power and private citizens, made upon valuable considerations, for purposes of individual advantage as well as public benefit, and thus a franchise partakes of a double nature and character. So far as it affects or concerns the public, it is publici juris and is subject to governmental control. The legislature may prescribe the manner of granting it, to whom it may be granted, the condition and terms upon which it may be held, and the

Affidavit of Citizenship,

DOCH 361061

11/27/2012 01:09 PM Page: 39 of 178
AFF R:\$10.00 J. C. Sloan, Mokinley County



2022-011769 MISC Page: 1941 of 2782
09/26/2022 03:35:37 PM Receipt #: 22-9381
Rep Fee: \$90.00 Darrell James Hill
Gila County, Az Sadie Jo Bingham, Recorder



DOCH 361076

11/27/2012 04:15 PM Page: 39 of 183
AFF R:\$10.00 J. C. Sloan, Mokinley County



AFFIDAVIT OF CITIZENSHIP, DOMICILE, AND TAX STATUS

duty of the grantee to the public in exercising it, and may also provide for its forfeiture upon the failure of the grantee to perform that duty. But when granted, it becomes the property of the grantee, and is a private right, subject only to the governmental control growing out of its other nature as publici juris. ² [Am.Jur.2d; Franchises, §4: Generally]

17. Pursuant to the Declaratory Judgment Act, 28 U.S.C. §2201(a) and the federal courts, the recipient of this form and an government agent handling this case has NO authority to assume any tax status other than that indicated on this form or to convert an innocent "nontaxpayer" into a "taxpayer".

Specifically, Rowen seeks a declaratory judgment against the United States of America with respect to "whether the plaintiff is a taxpayer pursuant to, and/or under 26 U.S.C. § 7701(a)(14)." (See Compl. At 2.) The court lacks jurisdiction to issue a declaratory judgment "with respect to Federal taxes other than actions brought under section 7428 of the Internal Revenue code of 1986, " a code/section that is not at issue in the instant action. See 28 U.S.C. §2201; see also Hughes v. United States, 953 F.2d 531, 536-537 (9th Cir. 1991) (affirming dismissal of claim for declaratory relief under § 2201 where claim concerned question of tax liability). Accordingly, defendant's motion to dismiss is hereby GRANTED, and the instant action is hereby DISMISSED. [Rowen v. US., 05-3766MMC. (N.D.Cal. 11/02/2005)]

"And by statutory definition, 'taxpayer' includes any person, trust or estate subject to a tax imposed by the revenue act. ...Since the statutory definition of 'taxpayer' is exclusive, the federal courts do not have the power to create nonstatutory taxpayers for the purpose of applying the provisions of the Revenue Acts..." [C.I.R. v. Trustees of L. Inv. Ass'n, 100 F.2d 18 (1939)]

"A reasonable construction of the taxing statutes does not include vesting any tax official with absolute power of assessment against individuals not specified in the statutes as a person liable for the tax without an opportunity for judicial review of this status before the appellation of 'taxpayer' is bestowed upon them and their property is seized..." [Botta v. Scanlon, 288 F.2d. 504, 508 (1961)]

SECTION 3: DURESS STATEMENT

If any other government form with the Recipient of this form might have received or viewed which I might have signed contradicts anything contained herein, the reasons are that:

1. I was threatened or felt threatened:
 - 1.1. By the Recipient to either not be hired or be fired if I did not sign a W-4 agreement or submit to a specific government form that doesn't pertain to me and thereby commit what I know to be fraud and/or perjury on a government form. . . OR
 - 1.2. By the Recipient because I was told that I would be denied the EQUAL right of all to engage in a business or financial account needed to sustain my life if I did not fill out and submit the form indicated and which I know misrepresented my status or had no options to correctly represent my status. . . OR
 - 1.3. By the government because I would become the target of unlawful or "selective" IRS/government enforcement that the legal profession, the courts, and the government routinely protect and encourage because of conflicts of interest, undue consolidation of power, and greed.

¹ Georgia R. & Power Co. v. Atlanta, 154 Ga 731, 115 SE 263; Lippencott v. Allander, 27 Iowa 460; State ex rel. Hutton v. Baton Rouge, 217 La 857, 47 So 2d 665; Tower v. Tower & S. Street R. Co. 68 Minn 500, 71 NW 691.

² Georgia R. & Power Co. v. Atlanta, 154 Ga 731, 115 SE 263; Lippencott v. Allander, 27 Iowa 460; State ex rel. Hutton v. Baton Rouge, 217 La 857, 47 So 2d 665; Tower v. Tower & S. Street R. Co. 68 Minn 500, 71 NW 691.

"For the love of money is the root of all evil: which while some coveted after, they have erred from the

Affidavit of Citizenship, Dc DOCH 361061

11/27/2012 01:09 PM Page: 40 of 178
AFF R:\$10.00 J. C. Sloan, McKinley County

2022-011769 MISC Page: 1942 of 2782
09/26/2022 03:35:37 PM Receipt #: 22-9381
Rec Fee: \$30.00 Darrell James Hill
Gila County, Az, Sadie Jo Bingham, Recorder

DOCH 361076

11/27/2012 04:15 PM Page: 40 of 189
AFF R:\$10.00 J. C. Sloan, McKinley County

AFFIDAVIT OF CITIZENSHIP, DOMICILE, AND TAX STATUS

faith, and pierced themselves through with many sorrows.

But thou, O man of God, flee these things' and follow after righteousness, godliness, faith, love, patience, meekness.

Fight the good fight of faith, lay hold on eternal life, whereunto thou art also called, and hast professed a good profession before many witnesses."
[1 Timothy 6:5-12, Bible, NKJV]

- 1.4 By the Recipient, who may have refused to accept this for or sent it back, because they knew they were violating both the law and my right and wanted to obstruct justice, destroy evidence of their wrongdoing, and tamper with a federal witness because this form is signed under penalty of perjury.
2. I was therefore under unlawful duress and the target of racketeering, extortion, and/or unconscionable "adhesion contracts" by the recipient/ government.
3. The origin of the duress was the Recipient of this form acting in a quasi-governmental and "public officer" capacity as a "withholding agent" pursuant to 26 U.S.C. §7701(a)(16) and who is therefore legally liable to respect my constitutional rights and REFUSED demands to do so.
- ... AND
4. The result of the unlawful duress was that I was compelled to contract with or engage in commerce within the government against my will and/or religious beliefs in violation of Article 1, section 10 of the United States Constitution, and to donate private property to a public use, public purpose, and/or public office in the government such as the "trade or business" franchise that is the heart of the Internal Revenue Code. Participation in all government franchises is an act of contracting because all franchises are contracts.

I hereby for the record declare as void, untrustworthy, and not admissible as evidence of any obligation on my part in any and all forms, declarations of status, or other correspondence in conflict with this form or any attached form I may have provided because such was submitted under unlawful duress.

"An agreement [consensual contract] obtained by duress, coercion, or intimidation is invalid, since the party coerced is not exercising his free will, and the test is not so much the means by which the party is compelled to execute the agreement as the state of mind induced.³ Duress, like fraud, rarely becomes material, except where a contract or conveyance has been made which the maker wishes to avoid. As a general rule, duress renders the contract or conveyance voidable, not void, at the option of the person coerced,⁴ and it is susceptible of ratification. Like other voidable contracts, it is valid until it is avoided by the person entitled to avoid it.⁵ However, duress in the form of physical compulsion, in which a party is caused to appear to assent when he has no intention of doing so, is generally deemed to render the resulting purported contract void.^{6"}
[American Jurisprudence 2d, Duress, Section 21]

This affidavit of duress and void declaration especially includes, but is not limited to, anything relating to government franchises, disclosures of government identifying numbers such as SSN or TIN, tax withholding or reporting forms such as the W-4 contract forms (26 CFR §31.3401(a)-3(a) and 26 CFR §31.3402(p)-1, tax returns, or licensing forms provided to the government such as driver's license applications, applications for ID cards, voter registration, or benefit applications.

³ Brown v. Pierce, 74 U.S. 205, 7 Wall 205, 19 L.Ed 134

⁴ Barnette v. Wells Fargo Nevada Nat'l Bank, 270 U.S. 438, 70 L.Ed 669, 46 S Ct 326 (holding that acts induced by duress which operate solely on the mind, and fall short of actual physical compulsion, are not void at law, but are voidable only, at the election of him whose acts were induced by it); Faske v. Gershman, 30 Misc 2d 442, 215 NYS2d 144; Glenney v. Crane (Tex Civ App Houston (1st Dist)) 352 SW2d 773, writ ref n r e (May 16, 1962); Carroll v. Fetty, 121 W.Va 215, 2 SE.2d 521, cert den 308 U.S. 571, 84 L.Ed 479, 60 S ct 85.

⁵ Faske v. Gershman, 30 Misc 2d 442, 215 NYS2d 144; Glenney v. Crane (Tex Civ App Houston (1st Dist)) 352 SW2d 773, writ ref n r e (May 16, 1962)

⁶ Restatement 2d, Contracts § 174, stating that if conduct that appears to be a manifestation of assent by a party who does not intend to engage in that conduct is physically compelled by duress, the conduct is not effective as a manifestation of assent.

SECTION 4: DO NOT ATTEMPT TO ADVISE ME WHAT TO PUT ON ANY GOVERNMENT FORM OR TO CHANGE THE STATUS DESCRIBED IN THIS FORM

Affidavit of Citizenship, D

DOCH 361061

11/27/2012 01:09 PM Page: 41 of 178
AFF R:\$10.00 J. C. Sloan, McKinley County

2022-0111769 MISC Page: 1943 of 2782

09/26/2022 03:35:37 PM Receipt #: 22-9381

Rec Fee: \$30.00 Darrell James Hill

Gila County, AZ, Sadie Jo Bingham, Recorder

DOCH 361076

11/27/2012 04:15 PM Page: 41 of 183

AFF R:\$10.00 J. C. Sloan, McKinley County

AFFIDAVIT OF CITIZENSHIP, DOMICILE, AND TAX STATUS

Per 26 U.S.C. §6065, all tax forms must be signed under penalty of perjury, just as this form is. As such, this form and ALL tax forms I submit to you constitute "testimony of a witness" and are protected by witness tampering laws. I remind the recipient that it is a federal offense to tamper with witnesses. Tampering, but is not limited to:

1. Advising me what to put on this form or any tax or withholding form and thereby conspire to commit PERJURY in violation of 18 U.S.C. §1542, 18 U.S.C. §911, 18 U.S.C. §1101, and 18 U.S.C. §1621. All such attempts shall form an inseparable part of the forms you both receive and must keep on file so that you may be held accountable.
 2. Refusing to honor that status that I describe here and thereby compelling me to commit perjury for the PRIVILEGE of being treated EQUALLY to everyone else you service.
 3. Telling me that what I put on the form is INCORRECT or FALSE and thereby refusing to accept the form, and yet refusing to offer legal evidence signed under penalty (as required by 26 U.S.C. §6065) PROVING that it is false.
 4. Threatening to withhold service or discriminate against me while acting as a public officer called a "withholding agent" defined in 26 U.S.C. §7701(a)(14). That would be a denial of equal protection of the law.
 5. Imputing or assuming a legal status OTHER than what I put here, and which might subject me to illegal enforcement or penalties against parties not subject. All such activities constitute an unconstitutional "Bill of Attainder" if implemented against those not consensually and lawfully engaged in government franchises. Not even federal judges can make such determinations.
- 28 U.S.C. 2201(a) forbids such determinations.

SECTION 5: SIGNATURE OF SUBMITTER

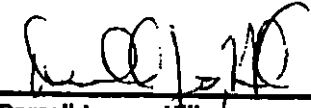
Worker Signature:	I certify under penalty of perjury from without the "United States" in accordance with <u>28 U.S.C. § 1746(1)</u> that the information provided on this form is true, correct, and complete.	Date signed:	6/19/2012
	 Darrell James, Hill		

CERTIFICATION

BEFORE me, the undersigned authority, a Notary Public, of the County of MCKINLEY Republic of NEW MEXICO (state name), this 19TH day of JUNE, 20 12

DARRELL JAMES HILL the above signed human being did appear and was identified by (circle one):

driver's license/passport/other and who, upon first being duly sworn and/or affirmed, deposes and says that the

aforegoing asseveration is true to the best of his knowledge and belief.

I certify under PENALTY OF PERJURY under the laws of the State of NEW MEXICO that the foregoing paragraph is true and correct.

WITNESS my hand and official seal.

 Notary Public Seal

My Commission Expires On: JUNE 1, 2016



OFFICIAL SEAL
 WILLIAM G. STRIPP
 NOTARY PUBLIC
 STATE OF NEW MEXICO

My Commission Expires: JUNE 1, 2012

2022-011769 MISC Page: 1944 of 2782

09/26/2022 03:35:37 PM Receipt #: 22-9381
 James Hill, Darrell
 Rec Fee: \$30.00
 Gila County, Az, Saddle Jo Bingham, Recorder.



DOCH 361076

11/27/2012 04:15 PM Page: 42 of 183
 AFF R: \$10.00 J. C. Sloan, McKinley County



izenship. DOCH 361061

11/27/2012 01:09 PM Page: 42 of 178
 AFF R: \$10.00 J. C. Sloan, McKinley County



AFFIDAVIT OF CITIZENSHIP, DOMICILE, AND TAX STATUS

APPENDIX: LEGAL POINTS AND AUTHORITIES

(This section provided for those who seek supporting authorities of statement made in this document)

1. A "national" is statutorily defined as follows:

TITLE 8 > CHAPTER 12 > SUBCHAPTER I . Sec. 1101.

Sec. 1101. – Definitions

(a)(21) The term "national" means a person owing permanent allegiance to a state.

2. The "state" in the above definition is a state of the Union. All states of the Union are "foreign states" with respect to federal government legislative jurisdiction, and therefore are lower case. Federal territories are capitalized as "State" within federal law. For example:

TITLE 4 – FLAG AND SEAL, SEAT OF GOVERNMENT, AND THE STATES

CHAPTER 4 – THE STATES

Sec. 110. Same; definitions

(d) The term "state" includes any Territory or possession of the United States.

3. Even the "United States of America" passport recognizes the two types of citizenship defined in federal statutory law. On the inside cover of the passport it says the following. Not the phrase "citizen/national", which means "citizen OR national":

"The Secretary of State of the United States of America hereby request all-whom it may concern to permit the citizen/national of the United States named herein to pass without delay or hindrance and in case of need to give all lawful aid and protection"

4. Below are some cites that establish the foreign relationship between the state and federal government for the purposes of legislative jurisdiction:

Foreign States: "Nations outside of the United States...Term may also refer to another state: i.e. a sister state. The term 'foreign nations', ...should be construed to mean all nations and states other than that in which the action is brought; and hence, one state of the Union is foreign to another, in that sense."
[Black's Law Dictionary, 6th Edition, p. 648]

Foreign Laws: "The laws of a foreign country or sister state."
[Black's Law Dictionary, 6th Edition, p. 647]

"Generally, the states of the Union sustain toward each other the relationship of independent sovereigns or independent foreign states, except in so far as the United States is paramount as the dominating government, and in so far as the states are bound to recognize the fraternity among sovereignties established by the federal Constitution, as by the provision requiring each state to give full faith and credit to the public acts, records, and judicial proceedings of the other states..."
[81A Corpus Juris Secundum (C.J.S.), United States, §29, legal encyclopedia]

"It is no longer open to question that the general government, unlike the states, Hammer v. Dagenhart, 247 U.S. 251, 275, 38 S.Ct. 529, 3 A.L.R. 649, Ann.Cas. 1918E 724, possesses no inherent power in respect of the internal affairs of the states; and emphatically not with regard to legislation. The question in respect of the inherent power of that government as to the external affairs of the Nation and in the field of international law is a wholly different matter which it is not necessary now to consider.
[Carter v. Carter Coal Co., 298 U.S. 238, 56 S.Ct. 855 (1936)]

5. The sole function of the federal government of the United States is to handle FOREIGN affairs with other countries, but it has no jurisdiction within states of the Union, including taxation. All of its revenues must derive only from the external affairs over which it has exclusive legislative jurisdiction. The rulings below occurred AFTER the passage of the Sixteenth Amendment and still limit the federal government exclusively to external matters in relation to states of the Union.

"The States, after they formed the Union, continued to have the same range of [INTERNAL] taxing power which they had before, barring only duties affecting exports, imports, and on tonnage [which all deal with FOREIGN/EXTERNAL commerce only]. 2 Congress, on the other hand, to lay taxes in order to pay the Debts and provide for the common Defence and general Welfare of the United States', Art. 1,

Affidavit of Citizenship, D

DOCH 361061

11/27/2012 01:09 PM Page: 43 of 178
AFF R:\$10.00 J. C. Sloan, McKinley County



2022-011769 MISC Page: 1945 of 2782

09/26/2022 03:35:37 PM Receipt #: 22-9381

Rec Fee: \$30.00 Darrell James Hill

61x County, Az, Sadie Jo Bingham, Recorder

DOCH 361076

11/27/2012 04:15 PM Page: 43 of 183
AFF R:\$10.00 J. C. Sloan, McKinley County



AFFIDAVIT OF CITIZENSHIP, DOMICILE, AND TAX STATUS

Sec. 8, U.S.C.A. Const., can reach every person and every dollar in the land with due regard to Constitutional limitations as the method of laying taxes.”
[Graves. V. People of State of New York, 206 U.S. 466 (1939)]

“The difficulties arising out of our dual form of government and the opportunities for differing opinions concerning the relative rights of state and national governments are many; but for a very long time this court has steadfastly adhered to the doctrine that the taxing power of Congress does not extend to the states of their political subdivisions. The same basic reasoning which leads to that conclusion, we think, requires like limitation upon the power which springs from the bankruptcy clause. United States v. Butler, supra.”
[Ashton v. Cameron County Water Improvement District No. 1, 298 U.S. 513; 56 S.Ct. 892 (1936)]

Congress is authorized to lay and collect taxes, and to pay the debts, and provide for the common defence and general welfare of the United States. This does not interfere with the power of the States to tax [internally] for the support of their own governments: nor is the exercise of that power by the States [to tax INTERNALLY], an exercise of any portion of the power that is granted to the United States [to tax EXTERNALLY]. In imposing taxes for State purposes, they are not doing what Congress is empowered to do. Congress is not empowered to tax for those purposes which are within the exclusive province of the States. When, then, each government exercises the power to taxation, neither is exercising the power of the other. But, when a State proceeds to regulate commerce with foreign nations, or among the several States, it is exercising the very power that is granted to Congress, [22 U.S. 1, 200] and is doing the very thing which Congress is authorized to do. There is no analogy, then, between the power of taxation and the power of regulating commerce.”
[Gibbons v. Ogden, 22 U.S. 1 (1824)]

“It will contribute to the elucidation of the question if we first consider the differences between the power of the federal government in respect of foreign or external affairs and those in respect of domestic or internal affairs. That there are differences between them, and that these differences are fundamental, may not be doubted. The two classes of powers are different, both in respect of their origin and their nature. The broad statement that the federal government can exercise no power except those specifically enumerated in the Constitution, and such implied power as are necessary and proper to carry into effect the enumerated power, is categorically true only in respect of our internal affairs. In that field, the primary purpose of the Constitution was to carve from the general mass of legislative powers then possessed by the states such portions as it was thought desirable to vest in the federal government, leaving those not included in the enumerations still in the states.
Carter v. Carter Coal Co., 298 U.S. 238, 294, 56 S.Ct. 855, 865. . . .

The Union existed before the Constitution, which was ordained and established among other things to form ‘a more perfect Union.’ Prior to that event, it is clear that the Union, declared by the Articles of Confederation to be ‘perpetual,’ was the sole possessor of external sovereignty, and in the Union it remained without change save in so far as the Constitution in express terms qualified its exercise. The Framers’ Convention was called and secreted its powers upon the irrefutable postulate that though the states were several their people in respect of foreign affairs were one.”
[United States v. Curtiss-Wright Export Corporation, 299 U.S. 304 (1936)]

The states of the Union are “foreign” to federal legislative jurisdiction, because, as the U.S. Supreme Court held above, they are not subject to it. This is a result of what is called the “Separation of Powers Doctrine”, which was explained by the Supreme Court as follows:

“... the Constitution divides authority [legislative jurisdiction] between federal and state governments for the protection of individuals. State sovereignty is not just an end in itself: “Rather, federalism secures to citizens the liberties that derive from the diffusion of sovereign power.” Coleman v. Thompson, 501 U.S. 722, 759 (1991) (BLACKMUN, J., dissenting). “Just as the separation and independence of the coordinate branches of the Federal Government serve to prevent the accumulation of excessive power in any one branch, a health balance of power between the States and the Federal Government will reduce the risk of tyranny and abuse from either front.” Gregory v. [505 U.S. 144, 182] Ashcroft, 501 U.S. at 458. See The Federalist No. 51, p. 323. (C. Rossiter ed. 1961).”
[New York v. United States, 505 U.S. 144 (1992)]

7. The federal government has no legislative power outside of its “territory

Affidavit of Citizenship, Domicile, and

DOCH 361061

11/27/2012 01:09 PM Page: 44 of 178
AFF R:\$10.00 J. C. Sloan, McKinley County

2022-0111769 MISC Page: 1946 of 2782
09/26/2022 09:35:37 PM Receipt #: 22-9381
Rec Fee: \$30.00 Darrell James Hill
Gila County, Az, Sadie Jo Bingham, Recorder

DOCH 361076

11/27/2012 04:15 PM Page: 44 of 163
AFF R:\$10.00 J. C. Sloan, McKinley County

AFFIDAVIT OF CITIZENSHIP, DOMICILE, AND TAX STATUS

"Judge Story, in his treatise on the Conflicts of Laws, lays down, as the basis upon which all reasonings on the law of comity must necessarily rest, the following maxims: First 'that every nation [or state] possesses an exclusive sovereignty and jurisdiction within its own territory'; secondly, that no state or nation can by its laws directly affect or bind property out of its own territory, or bind persons not resident therein, whether they are natural born subjects or others.' The learned judge then adds: 'From these two maxims or propositions there follows a third, and that is that whatever force and obligation the laws of one country have in another depend solely upon the laws and municipal regulation of the latter; that is to say, upon its own proper jurisdiction and polity, and upon its own express or tacit [voluntary] consent.'" Story on Conflict of Laws §23. [Baltimore & Ohio Railroad Co. v. Chambers, 73 Ohio St. 16; 76 N.E. 91; 11 L.R.A., N.S., 1012 (1905)]

8. The states of the Union are NOT "territory" of the federal government. They are instead INDEPENDENT and SOVEREIGN states:

86 Corpus Juris Secundum (C.J.S.) Legal Encyclopedia, Territories:

"§1. Definitions, Nature, and Distinctions

"The word 'territory,' when used to designate a political organization has a distinctive, fixed, and legal meaning under the political institutions of the United States, and does not necessarily include all the territorial possessions of the United States, but may include only the portions thereof which are organized and exercise governmental functions under act of congress."

"While the term 'territory' is often loosely used, and has even been construed to include municipal subdivisions of a territory, and "territories of the " United States is sometimes used to refer to the entire domain over which the United States exercises dominion, the word "territory," when used to designate a political organization, has a distinctive, fixed, and legal meaning under the political institutions of the United States, and the term "territory" or "territories" does not necessarily include only a portion of the portions thereof which are organized and exercise government functions under act of congress. The term "territories" has been defined to be political subdivisions of the outlying dominion of the United States, and in this sense the term "territory" is not a description of a definite area of land but of a political unit governing and being governed as such. The question whether a particular subdivision or entity is a territory is not determined by the particular form of government with which it is, more or less temporarily, invested.

"Territories" or "territory" as including "state" or "states." While the term "territories of the United States may, under certain circumstances, include the states of the Union, as used in the federal Constitution and in ordinary acts of congress "territory" does not include a foreign state.

"As used in this title, the term "territories" generally refers to the political subdivisions created by congress, and not within the boundaries of any of the several states."

9. States of the Union retain their essential character as independent nations and foreign countries with respect to the federal government except in the matter of EXTERNAL affairs delegated by them to the Federal Government in their corporate capacity as the "United States of America":

"The States between each other are sovereign and independent. They are distinct and separate sovereignties, except so far as they parted with some of the attributes of sovereignty by the Constitution. They continue to be nations, with all their rights, and under all their national obligations, and with all the rights of nations in every particular: except in the surrender by each to the common purposes and objects of the Union, under the Constitution. The rights of each State, when not so yielded up, remain absolute."

[Bank of Augusta v. Earle, 38 U.S. (13 Pet.) 519; 10 L.Ed. 274 (1839)]

"In determining the boundaries of apparently conflicting powers between states and the general government, the proper question is, not so much what has been, in terms, reserved to the states, as what has been, expressly or by necessary implication, granted by the people to the national government: for each state possess all the powers of an independent and sovereign nation, except so far as they have been ceded away by the constitution. The federal government is but a creature of the people of the states, and, like an agent appointed for definite and specific purposes, must show an express or necessarily implied authority in the charter of its appointment, to give validity to its acts." [People ex re. Atty. Gen V. Naglee, 1 Cal 234 (1850)]

DOCH 361061

Affidavit of Citizenship, Domicile, and

11/27/2012 01:09 PM Page: 45 of 178
AFF R:\$10.00 J. C. Sloan, McKinley County

2022-011769 MISC Page: 1947 of 2782

09/26/2022 03:35:37 PM Receipt #: 22-9381
Rec Fee: \$30.00 Darrell James Hill
Gila County, Az. Sadie Jo Bingham, Recorder



DOCH 361076

11/27/2012 04:15 PM Page: 45 of 183
AFF R:\$10.00 J. C. Sloan, McKinley County



AFFIDAVIT OF CITIZENSHIP, DOMICILE, AND TAX STATUS

10. A human being (but NOT "person") who is born in a state of the Union, which is outside of federal exclusive legislative jurisdiction, is called a "national". A person who is a "national" is subject to the "political jurisdiction" but not the "legislative jurisdiction" of their mother country because they are outside of the territorial reach of its general law, because the Congress cannot write any law that governs what happens with states of the Union, as the above citations indicate (see, for instance, *Carter v. Carter Coal Co.*, 298 U.S. 238, 56 S.Ct. 855, (1936)). The reason is that the states and the people in them are SOVEREIGN, and their creation, the federal government, cannot be greater than its Creator, which is the states and the people in them. The federal government is a SERVANT to the states, not their master: the equivalent of an independent contract that handles EXTERNAL affairs only. This was confirmed by the Federalist Papers, which were written prior to the ratification of the Constitution by the states of the Union in 1789:

"No legislative act [of Congress] contrary to the Constitution can be valid. To deny this would be to affirm that the deputy (agent) [which is the federal government] is greater than his principal [the States and the people in them]; that the servant is above the master; that the representatives of the people are superior to the people; that men, acting by virtue of powers may do not only what their powers do not authorize, but what they forbid...[text omitted] It is not otherwise to be supposed that the Constitution could intend to enable the representatives of the people to substitute their will to that of their constituents. It is far more rational to suppose, that the courts were designed to be an intermediate body between the people and the legislature, in order, among other things, to keep the latter within the limits assigned to their authority. The interpretation of the laws is the proper and peculiar province of the courts. A Constitution is, in fact, and must be regard by judges, as fundamental law. If there should happen to be an irreconcilable variance between the two, the Constitution is to be preferred to the statute."
[Alexander Hamilton, Federalist Paper # 78]

11. It is absurdly ridiculous to demand from the submitter a federal statute that confers but defines citizenship status of a person born outside of federal jurisdiction. States of the Union have exclusive and "plenary" jurisdiction to determine the status of the people born within their jurisdiction and they have never yielded that authority to the federal government either in the Constitution or in any subsequent amendment and enactment. To conclude otherwise is to admit that states of the Union have NO SOVEREIGNTY, because the federal government could just pass a law to literally STEAL all of their citizens. If the federal government had jurisdiction to pass a law that allowed them to STEAL all citizens of the states, then the states would be left with not one to govern!

12. Congress has the power to "naturalize" people coming into America, and when they do this, these people become statutory "nationals" and constitutional but not statutory "Citizens".

"Provision of Nationality Act of 1940 that a person becoming a national by naturalization shall lose his nationality by residing continuously for three years in territory of a foreign state, being practically identical to its successor, which was condemned by United States Supreme Court as discriminatory, would have been invalid as a congressional attempt to expatriate regardless of intent."
[United States v. Lucienne D'Hotelle, 558 F.2d 37 (1976)]

The statutory definition of "naturalization" confirms that in America, naturalization means conferring the character of a statutory "national" and not a statutory "citizen":

8 U.S.C. §1101(a)(23) naturalization defined

(a)(23) The term "naturalization" means the conferring of nationality [NOT "citizen" or "U.S. citizen" status, but "nationality", which means "national"] of a state [of the Union] upon a person after birth, by any means whatsoever.

[NOTE: Compare with the definition of "expatriation"]

"The power of naturalization, vested in congress by the constitution, is a power to confer citizenship, not a power to take it away. 'A naturalized citizen,' said Chief Justice Marshall, 'becomes a member of the society, possessing all the rights of a native citizen, and standing, in the view of the constitution, on the footing of a native. The constitution does not authorize congress to enlarge or abridge those rights. The simple power of the national legislature [over citizenship] is to prescribe a uniform rule of naturalization, and the exercise of this power exhausts it, so far as respects the individual.'"
[U.S. v. Wong Kim Ark, 169 U.S. 649 (1898)]

Affidavit of Citizenship, D

DOCH 361061

11/27/2012 01:09 PM Page: 46 of 178
AFF R:\$10.00 J. C. Sloan, McKinley County

2022-011769 MISC Page: 1948 of 2782
09/26/2022 03:35:37 PM Receipt #: 22-9381
Reg Fee: \$30.00 Darrell James Hill
Gila County, Az, Sadia Jo Bingham, Recorder

DOCH 361076

11/27/2012 04:15 PM Page: 46 of 183
AFF R:\$10.00 J. C. Sloan, McKinley County

AFFIDAVIT OF CITIZENSHIP, DOMICILE, AND TAX STATUS

13. A human being who is a "national" but not a "citizen" under federal statutory law is identified as a "citizen of the United States" within the Fourteenth Amendment to the U.S. Constitution. The United States Constitution confines itself to describing citizenship within the states and the Union and therefore, the term "United States", as used within the Constitution, means the collective states of the Union [called "The United States of America"] and EXCLUDES federal territories and possessions and the District of Columbia. The "United States" mentioned in the Constitution and the "United States" mentioned in most federal enactments are two completely different and mutually exclusive places. This is VERY important and fundamental to understanding the Separation of Powers Doctrine.

14. If the recipient of this form disagrees with any of the facts stated in this section, then please provide the following within thirty calendar days or forever be stopped from challenging these statements of fact:

14.1. Written evidence signed under penalty of perjury (not opinion, but enacted positive law, regulations, and Supreme court rulings but not those of lower courts) of same.

Signature and form NOT VALID without the attached signed form entitled "Why It Is Illegal For Me To Request Or To Use A Taxpayer Identification Number (TIN) dated on the same date."

Unofficial

DOCH 361076

11/27/2012 04:15 PM Page: 47 of 183
AFF R:\$10.00 J. C. Sloan, Mokinley County

2022-011769 MISC Page: 1949 of 2782
09/26/2022 03:35:37 PM Receipt #: 22-9381
Rec Fee: \$30.00 Darrell James Hill
Gila County, Az, Sadie Jo Bingham, Recorder



DOCH 361061

shlp, Do 11/27/2012 01:09 PM Page: 47 of 178
AFF R:\$10.00 J. C. Sloan, Mokinley County



WHY IT IS ILLEGAL FOR ME TO REQUEST OR TO USE A TAXPAYER IDENTIFICATION NUMBER (TIN)

PURPOSE OF THIS FORM:

This form is intended to provide succinct, convenient evidence proving beyond all doubt that the submitter may not lawfully have or use government issued identifying numbers and would be violating criminal and civil laws to do so. It is intended to be submitted to financial institutions, employers, and businesses who demand numbers from those they do business with.

SECTION 1: REQUIREMENTS FOR THE ISSUANCE OF SOCIAL SECURITY NUMBERS (SSN)

The authority to issue Social Security Numbers (SSNs) is found in 20 CFR §422.104. Below are the specific persons who are eligible:

Title 20: Employees' Benefits
PART 422—ORGANIZATION AND PROCEDURES
Subpart B—General Procedures

§422.104 Who can be assigned a social security number.

(a) Persons eligible for SSN assignment. We can assign you a social security number if you meet the evidence requirements in §422.107 and you are:

(1) A United States citizen; or

(2) An alien lawfully admitted to the United States for permanent residence or under other authority of law permitting you to work in the United States (§422.105 describes how we determine if a nonimmigrant alien is permitted to work in the United States); or

(3) An alien who cannot provide evidence of alien status showing lawful admission to the U.S., or an alien with evidence of lawful admission but without authority to work in the U.S., if the evidence described in §422.107(e) does not exist, but only for a valid nonwork reason. We consider you to have a valid nonwork reason if:

(i) You need a social security number to satisfy a Federal statute or regulation that requires you to have a social security number in order to receive a Federally-funded benefit to which you have otherwise established entitlement and you reside either in or outside the U.S.; or

(ii) You need a social security number to satisfy a State or local law that requires you to have a social security number in order to receive public assistance benefits to which you have otherwise established entitlement, and you are legally in the United States.

The "United States citizen" described in 20 CFR §422.104(a)(1) is a statutory "citizen of the United States" described in **8 U.S.C. §1401** and NOT a constitutional "citizen of the United States" identified in Section 1 of the Fourteenth Amendment. The difference between a statutory and a constitutional citizen arises from the difference in the meaning of the term "United States" as used in the Constitution versus "United States" as used in federal statutory law. This person is born of federal territory and not within any state of the Union. This is confirmed by the following definitions:

TITLE 8 > CHAPTER 12 > SUBCHAPTER I > Sec. 1101. (Aliens and Nationality)
Sec. 1101. - Definitions

(a)(38) The term "United States", except as otherwise specifically herein provided, when used in a geographical sense means the continental United States, Alaska, Hawaii, Puerto Rico, Guam, and the Virgin Islands of the United States.

8 U.S.C. Sec. 1101(a)(36): State (Aliens and Nationality)

The term "State" includes the District of Columbia, Puerto Rico, Guam, and the Virgin Islands of the United States.

TITLE 8—ALIENS AND NATIONALITY CHAPTER I—IMMIGRATION AND NATURALIZATION SERVICE,
DEPARTMENT OF JUSTICE
PART 215—CONTROLS OF ALIENS DEPARTING FORM THE UNITED STATES
Section 215.1: Definitions

(f) The term continental United States means the District of Columbia and the several States, except Alaska and Hawaii.

Why It Is Illegal For Me To Request Or To Use A Taxpayer Ider

DOCH 361061

11/27/2012 01:09 PM Page: 48 of 178
AFF R:\$10.00 J. C. Sloan, McKinley County

2022-011769 MISC Page: 1950 of 2782
09/26/2022 03:35:37 PM Receipt #: 22-9381
Rec Fee: \$30.00 Darrell James Hill
Gila County, Az, Sadie Jo Bingham, Recorder

DOCH 361076

11/27/2012 04:15 PM Page: 48 of 183
AFF R:\$10.00 J. C. Sloan, McKinley County

WHY IT IS ILLEGAL FOR ME TO REQUEST OR TO USE A TAXPAYER IDENTIFICATION NUMBER (TIN)

"As the only judicial power vested in Congress is to create courts whose judges shall hold their offices during good behavior, it necessarily follows that, if Congress authorizes the creation of courts and the appointment of judges for limited time, it must act independently of the Constitution upon territory which is not part of the United States within the meaning of the Constitution."

[O'Donohue v. United States, 289 U.S. 516, 53 S.Ct 740 (1933)]

Notice the last quote from the Supreme Court "NOT PART OF THE UNITED STATES WITHIN THE MEANING OF THE CONSTITUTION", which implies that there is ONLY ONE meaning of "United States" within the Constitution, and that this meaning does not include community property of the states of the Union under the care and management of the general government called the "territory of the United States".

I emphasize once again that I am NOT a statutory "U.S. citizen" pursuant to 8 U.S.C. §1401 because I do not maintain a legal domicile on federal territory called the "United States" or with any "State" as defined above. I was born in the "United States of America" or the "United States" as constitutionally defined, not the "United States as statutorily defined and I do not reside or maintain a domicile on federal territory subject to the exclusive jurisdiction of Congress pursuant to Article 1, Section 8, Clause 17 of the United States Constitution.

The "permanent resident" described in 20 CFR 422.104(a)(2) is a person born outside the United States of America and who made application to the United States government pursuant to 26 CFR §1.871-4 to become a "permanent resident": "permanent residents" are described in 26 U.S.C. §7701(b)(1)(A) and 8 U.S.C. 1101(a)(3) as an alien man or woman who has a domicile in the "United States". The "United States" is then defined in 26 U.S.C. §7701(a)(9) and (a)(10) as being the district of Columbia. Nowhere are the several states of the Union expressly included, and therefore they are implicitly excluded by implication:

"When a statute includes an explicit definition, we must follow that definition, even if it varies from that term's ordinary meaning. Meese v. Keene, 481 U.S. 465, 484-485 (1987) ("It is axiomatic that the statutory definition of the term excludes unstated meanings of that term"); Colautti v. Franklin, 439 U.S. at 392-393, n. 10 ("As a rule, 'a definition which declares what a term 'means' . . . excludes any meaning that is not stated"); Western Union Telegraph Co. v. Lenroot, 323 U.S. 490, 502 (1945); Fox v. Standard Oil Co. of N.J., 294 U.S. 87, 95-96 (1935) (Cardozo, J.); see also 2A N. Singer, Sutherland on Statutes and Statutory Construction § 47.07, p. 152, and n. 10 (5th ed. 1992) (collecting cases). That is to say, the statute, read "as a whole," post at 998 [530 U.S. 943] (THOMAS, J., dissenting), leads the reader to a definition. That definition does not include the Attorney General's restriction—"the child up to the head." Its words, "substantial portion," indicate the contrary."
[Stenberg v. Carhart, 530 U.S. 914 (2000)]

"Expressio unius est exclusio alterius. A maxim of statutory interpretation meaning that the expression of one thing is the exclusion of another. Burgin v. Forbes., 293 Ky. 456, 169 S.W.2d 321, 325; Newblock v. Bowles, 170 Okl. 487, 40 P.2d 1097, 1100. Mention of one thing implies exclusion of another. When certain persons or things are specified in a law, contract, or will, an intention to exclude all others from its operation may be inferred. Under this maxim, if statute specifies one exception to a general rule or assumes to specify the effects of a certain provision, other exceptions of effects are excluded."
[Black's Law Dictionary, Sixth Edition, p. 581]

I emphasize that I am also NOT an "alien", "resident", or "permanent resident" as defined in 8 U.S.C. §1101(a)(3) or 26 U.S.C. §7701(b)(1)(A) because I was born in the United States of America but not the statutory "United States" and maintain a domicile nowhere with the "United States" (federal territory).

If you think I belong in one of the categories described in 20 CFR §422.104, please identify exactly which one and present all evidence as may be in your possession signed under penalty of perjury from someone with personal knowledge of my circumstances that proves your hypothesis. If you do not do so within 10 days of receipt of this document, you agree with me and therefore are estopped from later contradicting yourself.

SECTION 2: REQUIREMENTS FOR THE ISSUANCE OF TAXPAYER IDENTIFICATION NUMBERS (TIN)

The authority for Issuing Taxpayer Identification Numbers is found in 26 U.S.C. §6109:

TITLE 26 > Subtitle F > CHAPTER 61 > Subchapter B > § 6109
§ 6109. Identifying numbers

Why It Is Illegal For Me To Request Or To Use A Taxpayer Ident

DOCH 361061

11/27/2012 01:09 PM Page: 49 of 178
AFF R:\$10.00 J. C. Sloan, McKinley County



2022-011769 MISC Page: 1951 of 2782
09/26/2022 03:35:37 PM Receipt #: 22-9381
Darrell James Hill
Rec Fee: \$30.00 Sadie Jo Bingham, Recorder
Gila County, Az, Sadies Jo Bingham, Recorder

DOCH 361076

11/27/2012 04:15 PM Page: 49 of 183
AFF R:\$10.00 J. C. Sloan, McKinley County

1942

WHY IT IS ILLEGAL FOR ME TO REQUEST OR TO USE A TAXPAYER IDENTIFICATION NUMBER (TIN)

(a) Supplying of identifying numbers

When required by regulations prescribed by the Secretary:

(1) Inclusion in returns

Any person required under the authority of this title to make a return, statement, or other document shall include in such return, statement, or other document such identifying number as may be prescribed for securing proper identification of such person.

(2) Furnishing number to other persons

Any person with respect to whom a return, statement, or other document is required under the authority of this title to be made by another person or whose identifying number is required to be shown on a return of another person shall furnish to such other person such identifying numbers as may be prescribed for securing his proper identification.

(3) Furnishing number of another person

Any person required under the authority of this title to make a return, statement, or other document with respect to another person shall request from such other person, and shall include in any such return, statement, or other document, such identifying number as may be prescribed for securing proper identification of such other person.

(4) Furnishing identifying number of income tax return preparer

Any return or claim for refund prepared by an income tax return preparer shall bear such identifying number for securing proper identification of such preparer, his employer, or both, as may be prescribed. For purposes of this paragraph, the terms "return" and "claim for refund" have the respective meanings given to such terms by section 6696(e).

For purposes of paragraphs (1), (2), and (3), the identifying number of an individual (or his estate) shall be such individual's social security account number.

26 U.S.C. § 6109(d) prescribes that an "individual's" social security number shall be used as the Taxpayer Identification Number of the individual:

TITLE 26 > Subtitle F > CHAPTER 61 > Subchapter B > § 6109 **§ 6109. Identifying numbers**

(d) Use of social security account number

The social security account number issued to an individual for purposed of section 205(c)(2)(A) of the Social Security Act shall, except as shall otherwise be specified under regulations of the Secretary, be used as the identifying number for such individual for purposes of this title.

The regulations under **I.R.C. § 6109** indicate who this "individual" is and who such "Taxpayer Identification Numbers" may lawfully be sued to and used against, all of them are "aliens":

26 CFR 52301.6109-1(b)

(b) Requirement to furnish one's own number—

(1) U.S. persons. Every U.S. person who makes under this title a return, statement, or other document must furnish its own taxpayer identifying number as required by the forms and the accompanying instructions.

(2) Foreign persons.

Why It Is Illegal For Me To Request Or To Use A Taxpayer Iden

DOCH 361061

11/27/2012 01:09 PM Page: 178 of 178
AFF R-\$10.00 J. C. Sloan, McKinley County



2022-011769 MISC Page: 1952 of 2782

09/26/2022 09:35:37 PM Receipt #: 22-9981
Rec Fee: \$30.00 Darrell James Hill
Gila County, Az, Sadie Jo Bingham, Recorder



DOCH 361076

11/27/2012 04:15 PM Page: 50 of 183
AFF R-\$10.00 J. C. Sloan, McKinley County



WHY IT IS ILLEGAL FOR ME TO REQUEST OR TO USE A TAXPAYER IDENTIFICATION NUMBER (TIN)

The provisions of paragraph (b)(1) of this section regarding the furnishing of one's own number shall apply to the following foreign persons—

- (i) A foreign person that has income effectively connected with the conduct of a U.S. trade or business at time during the taxable year;
- (ii) A foreign person that has a U.S. office or place of business or a U.S. fiscal or paying agent at any time during the taxable year;
- (iii) A nonresident alien treated as a resident under section 6013(g) or (h);
- (iv) A foreign person that makes a return of tax (including income, estate, and gift tax returns), an amended return, or a refund claim under this title but excluding information returns, statements, or documents;
- (v) A foreign person that makes an election under Sec. 301.7701-3(c);
- (vi) A foreign person that furnishes a withholding certificate described in Sec. 1.1441-1(e)(2) or (3) of this chapter or Sec. 1.441-5(c)(2)(iv) or (3)(iii) of this chapter to the extent required under Sec. 1.441-1(e)(4)-1(e)(4)(vii) of this chapter;
- (vii) A foreign person whose taxpayer identifying number is required to be furnished on any return, statement, or other document as required by the income tax regulations under 897 or 1445. This paragraph (b)(2)(vii) applies as of November 3, 2003; and
- (viii) A foreign person that furnishes a withholding certificate described in Sec. 1.1446-1(c)(2) or (3) of this chapter or whose taxpayer identification number is required to be furnished on any return, statement, or other document as required by the income tax regulations under section 1446. This paragraph (b)(2)(viii) shall apply to partnership taxable years beginning May 18, 2005, or such earlier time as the regulations under Sec. 1.1446-1 through 1.1446-5 of this chapter apply by reason of an election under Sec. 1.1446-7 of this chapter.

26 CFR §1.1441-1(c)(3) agrees with the above by defining an "individual" as either an "alien" or a "nonresident alien". Nowhere are "citizens" included in the definition, and therefore they are excluded by implication. Expressio unius est exclusio alterius:

25 CFR 1.1441-1 Requirement for the deduction and withholding of tax on payments to foreign persons.

(c) Definitions

(3) Individual.

(i) Alien individual.

The term alien individual means an individual who is not a citizen or a national of the United States Sec 1.1-1(c).

(ii) Nonresident alien individual.

The term nonresident alien individual means a person described in section 7701(b)(1)(B), an alien individual who is a resident of a foreign country under the residence article of an income tax treaty and Sec. 301.7701(b)-7(a)(1) of this chapter, or an alien individual who is a resident of Puerto Rico, Guam, the Commonwealth of Northern Marian Islands, the U.S. Virgin Islands, or American Samoa as determined under Sec. 301.7701(b)-1(d) of this chapter. An alien individual who has made an election under section 6013 (g) or (h) to be treated as a resident of the United States is nevertheless treated as a nonresident alien individual for purposes of withholding under chapter 3 of the Code and the regulations thereunder.

Consequently, the following rules apply to the application for and the use of Taxpayer Identification Numbers:

"Allens" as defined in 26 U.S.C. §7701(b)(1)(A) and "nonresident aliens" as defined in 26 U.S.C. 7701(b)(1)(B) are NOT equivalent. They are separate and distinct groups and "nonresident aliens" are NOT a subset of all "aliens". One may be a "nonresident alien" WITHOUT being an "alien". Such is the case with a man or woman who is a "national" but not a "citizen" as described in 8 U.S.C. §1101(a)(21) AND 8 U.S.C. §1452. All people born within the several Constitutional but not statutory states of the Union and domiciled outside of federal territory are "nationals" but not "citizens" under federal statutory law.

(Consequently, the withholding agent Recipient's reliance upon a third party unsigned informational return as evidence supporting one's actions in conclusion that the Affiant is a "taxpayer" is inadmissible as evidence under Federal Rule of Evidence 802 because not signed under penalty of perjury. Furthermore, the withholding agent of these forms seldom have personal knowledge that the Submitter Affirmant is in fact and in deed engaged in a "trade or business" as required by 26 U.S.C. §6041(a). Most people don't know, for instance, that a "trade or business" includes ONLY "the functions of a public office".)

DOCH 361061

Why It Is Illegal For Me To Request Or To Use A Taxpayer Identifier

11/27/2012 01:09 PM Page: 50 of 178
AFF R: \$10.00 J. C. Sloan, McKinley County



2022-011769 MISC Page: 1953 of 2762
09/26/2022 08:36:37 PM Receipt #: 22-9381
Rec Fee: \$30.00 Darrell James Hill
Gila County, Az, Sadie Jo Bingham, Recorder

DOCH 361076

11/27/2012 04:15 PM Page: 51 of 183
AFF R: \$10.00 J. C. Sloan, McKinley County

WHY IT IS ILLEGAL FOR ME TO REQUEST OR TO USE A TAXPAYER IDENTIFICATION NUMBER (TIN)

2. Individual Taxpayer Identification Numbers (ITINs) may only lawfully be issued to aliens and not "nonresident aliens", pursuant to 26 CFR §301.6109-1. Nonresident aliens need only apply for an ITIN if they are engaged in the "trade or business" excise taxable franchise, at which time they effectively make an "election" to be treated as a "resident alien":

Title 31: Money and Finance: Treasury

PART 103—FINANCIAL RECORDKEEPING AND REPORTING OF CURRENCY AND FOREIGN TRANSACTIONS

Subpart C—Records Required To Be Maintained

§103.34 Additional records to be made and retained by banks.

(a)(3) A taxpayer identification number required under paragraph (a)(1) of this section *need not be secured for accounts or transaction with the following:*

[...]

(x) non-resident aliens who are not engaged in a trade or business in the United States. In instances described in paragraphs (a)(3), (viii) and (ix) of this section, the bank shall, within 15 day following the end of any calendar year in which the interest accrued in that year is \$10 or more use its best effort to secure and maintain the appropriate taxpayer identification number or application form therefor.

TITLE 31—MONEY AND FINANCE: TREASURY

CHAPTER II—FISCAL SERVICE, DEPARTMENT OF THE TREASURY

PART 306 GENERAL REGULATIONS GOVERNING U.S. SECURITIES—Table of Contents

Subpart B Registration

Sec. 306.10 General

²Taxpayer identifying numbers are not required for foreign governments, nonresident aliens not engaged in trade or business within the United States, international organizations and foreign corporations not engaged in trade or business and not having an office or place of business or a financial or paying agent with the United States, and other persons or organizations as may be exempted from furnishing such numbers under regulations of the Internal Revenue Service.

26 CFR § 301.7701-5 Domestic, foreign, resident, and nonresident persons.

A domestic corporation is one organized or created in the United States, including only the States (and during the periods when not States, the Territories of Alaska and Hawaii), and the District of Columbia, or under the law of the United States or of any State or Territory. A foreign corporation is one which is not domestic. A domestic corporation is a resident corporation even though it does no business and owns no property in the United States. A foreign corporation engaged in trade or business within the United States is referred to in the regulation in this chapter as a resident foreign corporation, and a foreign corporation not engaged in trade or business with the United States, as a nonresident foreign corporation. A partnership engaged in trade or business with the United States is referred to in the regulations in this chapter as a resident partnership, and a partnership not engaged in trade or business with the United States, as a nonresident partnership. Whether a partnership is to be regarded as resident or nonresident is not determined by the nationality or residence of its members or by the place in which it was created or organized.

[Amended by T.D. 8813, Federal Register: February 2, 1999 (Volume 64, Number 21), Page 4967-4975]

3. One may be a "nonresident alien" WITHOUT being a "nonresident alien individual". Such is the case with a man or woman who is a "national" but not "citizen" as described in 8 U.S.C. §1101(a)(21) and 8 U.S.C. §1452. One cannot be an "individual" as a nonresident alien without having a domicile on federal territory. Note that the term "individual" as used in the Privacy Act, 5 U.S.C. §552a(a)(2) does not include "nonresident aliens". One must be either a statutory "U.S. citizen" pursuant to 8 U.S.C. §1401 or a "resident alien" pursuant to 26 7701(b)(1)(A) in order to be an "individual", and both of these conditions have in common a domicile on federal territory and not within any state of the Union.

4. If an ITIN is used in the case of a "nonresident alien", such an alien has made an "election" to be treated as a "resident alien" pursuant to 26 U.S.C. §6013(g) and (h). Such an election may only lawfully be made in the case of a "nonresident alien" married to a

2022-011769 MIS Page: 1954 of 2782
09/25/2022 03:35:37 PM Receipt #: 22-9381
Rec Fee: \$30.00 Darrell James Hill
Gila County, Az, Sadie Jo Bingham, Recorder

Why It Is Illegal For Me To Request Or To Use A Taxpayer Ide

DOCH 361061

11/27/2012 01:09 PM Page: 51 of 178
APF R:\$10.00 J. C. Sloan, McKinley County



DOCH 361076

11/27/2012 04:15 PM Page: 52 of 183
APF R:\$10.00 J. C. Sloan, McKinley County

1945

WHY IT IS ILLEGAL FOR ME TO REQUEST OR TO USE A TAXPAYER IDENTIFICATION NUMBER (TIN)

statutory but not constitutional "U.S. citizen" as defined in 8 U.S.C. §1401. Any other use constitutes a violation of the Internal Revenue Code and a fraud upon the United States.

5. Pursuant to **26 U.S.C. §6109(d)**, Social Security Numbers (SSNs) may only lawfully be used in place of Individual Taxpayer Identification Numbers (ITINs) in the case of aliens, but not statutory "U.S. citizens" pursuant to **8 U.S.C. §1401**.

6. **26 U.S.C. § 7701(a)(41)** defines the term "TIN" as a number assigned to a "person" by the IRS under the authority of **26 U.S.C. §6109**. Nowhere are the terms "TIN" and Taxpayer Identification Number" made equivalent.

TITLE 26 > Subtitle F > CHAPTER 79 > § 7701
§ 7701. Definitions

(a) When used in this title, where not otherwise distinctly expressed or manifestly incompatible with the intent thereof—

(41) TIN

The term "TIN" means the identifying number assigned to a person under section 6109.

It is a violation of due process of law to presume that a "TIN" and a "Taxpayer Identification Number" are the same thing or are equivalent.

7. If a statutory "U.S. citizen" is asked to provide a Taxpayer Identification Number and he or she gives you a Social Security Number, indirectly he or she is agreeing to accept being treated as an "alien" who has voluntarily and effectively surrendered the protections and privileges of a citizen and who agrees to accept the disabilities of alienage in exchange for governmental franchises. This choice cannot be compelled and must be voluntary.

SECTION 3: LAWS VIOLATED BY APPLYING FOR SOCIAL SECURITY NUMBER OR COMPELLING ME TO APPLY FOR ONE

The process of applying for a Social Security Number is initiated by filling out SSA form SS-5. A copy of that form is available below:

Social Security Administration Form SS-5, Application for Social Security Card
<http://famguardian.org/TaxFreedom/Forms/Emancipations/SS-5.pdf>

Block 3 of the form is used to indicate one's citizenship status. The block that most Americans unknowingly check is "U.S. citizen", meaning a statutory and not constitutional "citizen" under federal law. As explained in Section 1 earlier, 20 CFR §442.104 only authorizes statutory but not constitutional citizens to make application to the Social Security Administration. Men and women born with and domiciled with the several states of the Union who check the statutory "U.S. citizen" box on SSA Form SS-5 are therefore:

- Committing perjury under penalty of perjury by declaring themselves to be a statutory "U.S. citizen" pursuant to **8 U.S.C. §1401**.
- Impersonating a statutory "U.S. citizen" in criminal violation of **18 U.S.C. §911**.
- Attempting to defraud the United States by applying for a "benefit" that they are not legally entitled to.
- Are unwittingly impersonating an officer or employee of the United States in criminal violation of **18 U.S.C. §912**.

TITLE 18 > PART I > CHAPTER > §912
§912. Officer or employee of the United States

Whoever falsely assumes or pretends to be an officer or employee acting under the authority of the United States or any department, agency or officer thereof, and acts as such, or in such pretended character demands or obtains any money [BENEFIT, INCLUDING SOCIAL SECURITY], paper, document, or thing of value, shall be fined under this title or imprisoned not more than three years, or both.

The Privacy Act at **5 U.S.C. §552a(a)(13)** defines "federal personnel" as any person entitled to receive any retirement payment from the federal government, INCLUDING Social Security benefits. Such benefits are ONLY available to person who ALREADY were federal personnel BEFORE they made application to participate in Social Security. The federal government cannot lawfully use or abuse their power to tax as a means to redistribute wealth among *private parties* who are NOT also "federal personnel" or "public officers" within the U.S. government:

Why It Is Illegal For Me To Request Or To Use A Taxpayer Ide **DOCH 361061**

11/27/2012 01:09 PM Page: 52 of 178
AFF R:\$10.00 J. C. Sloan, McKinley County



2022-011769 MISC Page: 1955 of 2782
09/26/2022 03:35:37 PM Receipt #: 22-9381
Rec Fee: \$30.00 Darrell James Hill
Gila County, Az. Sadie Jo Bingham, Recorder

DOCH 361076

11/27/2012 04:15 PM Page: 53 of 183
AFF R:\$10.00 J. C. Sloan, McKinley County

WHY IT IS ILLEGAL FOR ME TO REQUEST OR TO USE A TAXPAYER IDENTIFICATION NUMBER (TIN)

To lay, with one hand, the power of the government on the property of the citizen, and with the other to bestow it upon favored individuals to aid private enterprises and build up private fortunes, is not the less a robbery because it is done under the forms of law and is called taxation. This is not legislation. It is a decree under legislative forms.

Nor is it taxation. 'A tax,' say Webster's Dictionary, 'is a rate or sum of money assessed on the person or property of a citizen by government for the use of the nation or State.' 'Taxes are burdens or charges imposed by the Legislature upon persons or property to raise money for public purposes.' Cooley, Const. Lim, 479

Coulter, J., in Northern Liberties v. St. John's Church, 13 Pa. St., 104 says, very forcibly, 'I think the common mind has everywhere taken in the understanding that taxes are a public imposition, levied by authority of the government in all its machinery and operations—that they are imposed for a public purpose.' See, also Pray v. Northern Liberties, 31 Pa.St., 69; Matter of Mayor of N.Y., 11 Johns., 77; Camden v. Allen, 2 Dutch., 398; Sharpless v. Mayor, supra; Hanson v. Vernon, 27 Ia., 47; Whiting v. Fon du Lac, supra." [Loan Association v. Topeka, 20 Wall. 655 (1874)]

"A tax, in the general understanding of the term and as used in the constitution, signifies an exaction for the support of the government. The word has never thought to connote the expropriation of money from one group for the benefit of another." [U.S. v. Butler, 297 U.S. 1 (1936)]

The only thing the government can lawfully pay "benefits" to, including Social Security, are people who are its own "officers" PRIOR to applying for the "benefit". There is no provision within the Internal Revenue Code or the Social Security Act which authorizes the CREATION of "public offices" using any tax form. The I.R.C. and the Social Security Act simply authorize "benefits" to persons who are ALREADY officers of the United States government. 4 U.S.C. 572 says that if such offices have been created within a state of the Union, then a statute authorizing this MUST appear somewhere within the statutes which administer the benefit, and no such statute exists.

TITLE 4 > CHAPTER 3 > 572

§ 72. Public offices: at seat of Government

All offices attached to the seat of government shall be exercised in the District of Columbia, and not elsewhere, except as otherwise expressly provided by law.

Consequently, benefits such as Medicare and Social Security are ONLY available to "federal personnel" who ALREADY hold "public office" within the U.S. government. "Benefits" may NOT lawfully be offered to private individuals. All such "public officers" are then defined in 5 U.S.C. §2105 as "employees" and 5 U.S.C. §2105(a) identifies such persons as "officers AND individuals". The only way one can lawfully be an "individual" is to work for or contract with the government.

SECTION 4: LAWS VIOLATED BY APPLYING FOR A TAXPAYER IDENTIFICATION NUMBER OR COMPELLING ME TO APPLY FOR ONE

Taxpayer Identification Numbers are requested using IRS forms W-7 and W-9:

1. Form W-7 says at the top the following:

"For use by individuals who are not U.S. citizens or nationals."

As pointed out in section 1 earlier, I am a "national" but not a statutory "U.S. citizen" or an "individual", and therefore it would constitute fraud and perjury in criminal violation of 18 U.S.C. §1001, 18 U.S.C. §1542, and 18 U.S.C. §1621 to complete and submit the W-7 form.

2. Form W-9 is entitled "Request for Taxpayer Identification Number and Certification". Part III of this form requires the applicant to admit under penalty of perjury that they are a "U.S. person". 26 U.S.C. §7701(a)(30) defines a "U.S. person" as a statutory "U.S. citizen" pursuant to 8 U.S.C. §1401 or a statutory "permanent resident" as defined in 26 U.S.C. §7701(b)(1)(A) and 8 U.S.C. §1101(a)(3). As stated in section 1 earlier, I am NEITHER a statutory "U.S. citizen" pursuant to 8 U.S.C. §1401 nor a statutory

Why It Is Illegal For Me To Request Or To Use A Taxpayer Identifier

DOCH 361061

11/27/2012 01:09 PM Page: 53 of 178
AFF R:\$10.00 J. C. Sloan, McKinley County



2022-011769 MISC Page: 1956 of 2782

09/26/2022 03:35:37 PM Receipt #: 22-9381
Rec Fee: \$30.00 Darrell James Hill
Gila County, Az, Sadie Jo Bingham, Recorder



DOCH 361076

11/27/2012 04:15 PM Page: 54 of 183
AFF R:\$10.00 J. C. Sloan, McKinley County



WHY IT IS ILLEGAL FOR ME TO REQUEST OR TO USE A TAXPAYER IDENTIFICATION NUMBER (TIN)

"permanent resident" (alien) pursuant to **26 U.S.C. §7701(b)(1)(A)** and **8 U.S.C. §1101(a)(3)**. Therefore, once again, it would constitute fraud and perjury in criminal violation of **18 U.S.C. §1001**, **18 U.S.C. § 1542**, and **18 U.S.C. §1621** to use the W-9 form.

Once again, the American Affirmant who gave you this form is:

1. A "nontaxpayer" not subject to any provision of subtitles A through C of the Internal Revenue Code:

*"Revenue Laws relate to taxpayers [officers, employees, instrumentalities, and elected officials of the Federal Government] and not to non-taxpayers [American Citizens/American Nationals not subject to the exclusive jurisdiction of the Federal Government]. The latter are without the their scope. No procedures are prescribed or non-taxpayers and no attempt is made to annul any of their Right or Remedies in due course of law. With them [non-taxpayers] Congress does not assume to deal and they are neither of the subject nor of the object of federal revenue laws."
[Economy Plumbing & Heating v. U.S., 470 F2d. 585 (1972)]*

2. A constitutional "Citizen of the United States **OF AMERICA**".
3. A "non-citizen national" as defined in **8 U.S.C. §1101(a)(21)** and **8 U.S.C. §1452**.
4. Domiciled on other than federal territory and not with any internal revenue district or United States Judicial District or "State" defined in **28 U.S.C. §1332(d)**, **26 U.S.C. §7701(a)(10)**, or **4 U.S.C. §110(d)**.
5. Subject to constitutional diversity of citizenship pursuant to **U.S. Const. Art. III, Section 2**, but NOT statutory diversity pursuant to **28 U.S.C. §1332**.
6. A "nonresident alien" as defined in **26 U.S.C. 7701(b)(1)(B)** but not a "nonresident alien individual" as defined in 26 CFR §1.1441-1(c)(3).
7. A "stateless person" immune from the jurisdiction of federal courts within the meaning of **28 U.S.C. §1332**. See Newman-Green v. Alfonso Lorrain, 490 U.S. 826 (1989).
8. NOT engaged in the "trade or business" federal franchise as defined in **26 U.S.C. §7701(a)(26)**.
9. NOT a statutory "citizen and national of the United States" as described in **8 U.S.C. § 1401** or 26 CFR 1.1-1(c).
10. NOT a statutory "U.S. national" as defined in **8 U.S.C. §1408** or **8 U.S.C. §1101(a)(22)(B)**.
11. NOT an "alien" as defined in **26 U.S.C. §7701(b)(1)(A)**.
12. NOT the "individual" as defined in **5 U.S.C. §552a(a)(2)** or referenced in **5 U.S.C. §2105(a)** because neither a statutory "U.S. citizen" pursuant to **8 U.S.C. §1401** nor a "resident" (alien) pursuant to **26 U.S.C. §7701(b)(1)(A)** nor a government "employee" or officer. I am an individual in a common sense of the term, but not with the meaning of any federal statute. I must have a domicile on federal territory to be anything described in federal statutory civil law, and I do not maintain such a domicile. Only "public officers", "employees", agencies and instrumentalities operating in a representative capacity within the United States government pursuant to **Federal Rule of Civil Procedure 17(b)** can be "individuals" within the meaning of any provision of the I.R.C.
13. NOT the "individual" the mentioned in **26 U.S.C. §7701(a)(1)** OR 26 CFR 1.1441-1(c)(3), because not an officer, "employee", agency or instrumentality of the United States government or the District of Columbia as described in **26 U.S.C. §6631(a)** or any other federal law.
14. NOT an "employee" as defined in **26 U.S.C. §3401(c)** or 26 CFR §31.3401(c)-1 or **5 U.S.C. §2105**.
15. NOT the "person" described in **26 U.S.C. §6671(b)** or **26 U.S.C. §7343**.

WARNING: Recipient is reminded that **28 U.S.C. §2201(a)** PROHIBITS the federal courts from presuming any status OTHER than that stated above in the context of federal or state taxes. Only I as the sovereign being may declare and establish my tax and citizenship status, because only I can lawfully exercise my First Amendment right of association and freedom from compelled association in deciding what political group I wish to associate with and thereby have allegiance toward, a domicile within, and protection from. **Domicile** is the origin of ALL of the government's authority to impose an income tax pursuant to **26 U.S.C. §911(d)(3)** and Miller Brothers Co. v. Maryland, 347 U.S. 340 (1954), and only I can determine my domicile.

26 CFR §301.6109-1(d)(3) authorizes the issuance of Individual Taxpayer Identification Numbers ONLY to "aliens", and not all nonresident aliens are "aliens". I am a "nonresident alien" and a "national" but not a statutory "citizen" who is NOT an "alien" and therefore am NOT eligible for a Taxpayer Identification Number. I cannot submit an application for such a number without committing criminal perjury and impersonating a "public officer" within the U.S. government in criminal violation of **18 U.S.C. §912**. If you want to direct me to a form that can be used by a person with all of the qualifications above for lawfully obtaining such a number without committing a crime, please direct me to the proper form, as I am not now aware of any such instrument.

pursuant to 20 CFR §422.103(d) and the back of the Social Security Card itself, Social Security Numbers and Social Security Cards are property of the Social Security Administration (SSA) and must be returned upon request:

Title 20: employees' Benefits

Why It Is Illegal For Me To Request Or To Use A Taxpayer Ide

DOCH 361061

11/27/2012 01:09 PM Page: 54 of 178
AFF R: \$10.00 J. C. Sloan, McKinley County

2022-011769 MISC Page: 1957 of 2782

09/26/2022 03:35:37 PM Receipt #: 22-9381

Rec Fee: \$30.00 Darrell James Hill

Gila County, Az. Sadie Jo Bingham Recorder

DOCH 361076

11/27/2012 04:15 PM Page: 55 of 183
AFF R: \$10.00 J. C. Sloan, McKinley County

WHY IT IS ILLEGAL FOR ME TO REQUEST OR TO USE A TAXPAYER IDENTIFICATION NUMBER (TIN)

PART 422—ORGANIZATION AND PROCEDURES

Subpart B—General Procedures

§422.103 Social security numbers.

(d) Social security number cards. A person who is assigned a social security number will receive a social security number card from SSA within a reasonable time after the number has been assigned. (See §422.104 regarding the assignment of social security number cards to aliens.) **Social security number cards are the property of SSA and must be returned upon request.**

The only "persons" or "individuals" who may lawfully be in possession, use, or control of government property are "public officers", trustees, and fiduciaries of the government who are described in **26 U.S.C. §6671(b)** and **26 U.S.C. §7343**. These persons all work for a federal corporation called the "United States" (28 U.S.C. §3002(15)(A)) as officers of said corporation and public trust: I am NOT such a person nor do I intend or wish to be. By applying for or using such a number, you are compelling me to donate my private property to a "public use" and to a federal franchise without compensation in violation of the United States Constitution's Fifth Amendment takings clause.

"Men are endowed by their Creator with certain unalienable rights, - 'life, liberty, and the pursuit of happiness;' and to 'secure,' not grant or create, these rights, governments are instituted. That property [or income] which a man has honestly acquired he retains full control of, subject to these limitations: First, that he shall not use it to his neighbor's injury, and that does not mean that he must use it for his neighbor's benefit; second, that if he devotes it to a public use, he gives to the public a right to control that use; and third, that whenever the public needs require, the public may take it upon payment of due compensation.
[Budd v. People of State of New York, 143 U.S. 517 (1892)]

It is UNLAWFUL for a private person such as myself to use public property such as a Social Security Number or a Social Security Card for my own personal benefit to the exclusion of the government because it constitutes theft and embezzlement in criminal violation of **18 U.S.C. §641**. I am not in receipt of any evidence which would authorize me to BECOME a "public officer" or federal "employee" by virtue of applying for or using such a number. Rather, such a person must ALREADY be such officer or employee BEFORE they apply for or using such number. This is mandated by **4 U.S.C. §72**, which says that all public offices MUST be exercised in the District of Columbia and not elsewhere except as expressly provided by and enactment of Congress. There is no statue authorizing the establishment of the "public offices" that are the subject of the franchise tax called the income tax, which is upon a "trade or business"/"public office" within the U.S. government. The U.S. Supreme Court has also said that Congress CANNOT lawfully establish such offices within a state of the Union in order to tax them:

"Congress cannot authorize a [privileged] trade or business [as defined in 26 U.S.C. §7701(a)(26)] within a State in order to tax it."
[License Tax Cases, 72 U.S. 462, 18 L.Ed. 497, 5 Wall. 462, 2 A.F.T.R. 2224 (1866)]

SECTION 5: LAWS VIOLATED IF YOU USE A TAXPAYER IDENTIFICATION NUMBER OR SOCIAL SECURITY NUMBER WITHOUT MY EXPLICIT CONSENT OR PERMISSION IN WRITING

Only "U.S. persons" as defined in **26 U.S.C. §7701(a)(30)**, which includes both statutory "U.S. citizens" and statutory "residents" (aliens) may use Social Security numbers.

26 CFR §301.6109-1(b)

(b) Requirement to furnish one's own number—

(1) U.S. persons.

Every U.S. person who makes under this title a return, statement, or other document must furnish its own taxpayer identifying number as required by the forms and the accompanying instructions.

TITLE 26 > Subtitle F > CHAPTER 79 > Sec. 7701.
Sec. 7701. — Definitions

(a)(30) **United States** person
The term "United States person" means —

Why It Is Illegal For Me To Request Or To Use A Taxpayer Identi

DOC# 361061

11/27/2012 01:09 PM Page: 55 of 178
AFF R:\$10.00 J. C. Sloan, McKinley County

2022-011769 MISC Page: 1958 of 2782

09/26/2022 03:35:37 PM Receipt #: 22-9381

James Hill, Darrell
Sadie Jo, Birmingham, Recorder
Gila County, Az

DOC# 361076

11/27/2012 04:15 PM Page: 56 of 183
AFF R:\$10.00 J. C. Sloan, McKinley County

WHY IT IS ILLEGAL FOR ME TO REQUEST OR TO USE A TAXPAYER IDENTIFICATION NUMBER (TIN)

- (A) a citizen or resident of the United States,
- (B) a domestic partnership,
- (C) a domestic corporation,
- (D) any estate (other than a foreign estate, within the meaning or paragraph (31)), and
- (E) any trust if –
 - (i) a court within the United States is able to exercise primary supervision over the administration of the trust, and
 - (ii) one or more United States persons have the authority to control all substantial decisions of the trust.

The term "U.S." as used in the term "U.S. person" is defined 26 U.S.C. 57701(a)(9) and (a)(10) to include only the District of Columbia meaning the U.S. government, and not the geographical states of the Union. Nowhere in the I.R.C. Subtitle A are states of the Union included in the definition of "United States" and therefore it must be presumed that they are purposefully excluded. It therefore constitutes CONSTRUCTIVE FRAUD to associate me with being a "U.S. person" or with the duties of a "U.S. person" by associating me with a federal identifying number when nowhere is the place of my domicile included in the definition of "U.S." within the Internal Revenue code Subtitle A, and you aren't allowed to "assume" anything without violating due process of law and causing the government to become a religion in violation of the First Amendment to the United States Constitution. Any "presumption" that you n't support with evidence amounts to the equivalent of religious faith, an no officer of the government or "withholding agent", whether voluntary or working for pay, may lawfully engage in an act of religion without violating the Constitution.

"Expressio unius est exclusio alterius. A maxim of statutory interpretation meaning that the expression of one thing is the exclusion of another. Burgin v. Forbes., 293 Ky. 456, 169 S.W.2d 321, 325; Newblock v. Bowles, 170 Okl. 487, 40 P.2d 1097, 1100. Mention of one thing implies exclusion of another. When certain persons or things are specified in a law, contract, or will, an intention to exclude all others from its operation may be inferred. Under this maxim, if statute specifies one exception to a general rule or assumes to specify the effects of a certain provision, other exceptions of effects are excluded."

[Black's Law Dictionary, Sixth Edition, p. 581]

"When a statute includes an explicit definition, we must follow that definition, even if it varies from that term's ordinary meaning. Meese v. Keene, 481 U.S. 465, 484-485 (1987) ("It is axiomatic that the statutory definition of the term excludes unstated meanings of that term"); Colautti v. Franklin, 439 U.S. at 392-393, n. 10 ("As a rule, 'a definition which declares what a term 'means'... excludes any meaning that is not state"); Western Union Telegraph Co. v. Lenroot, 323 U.S. 490, 502 (1945); Fox v. Standard Oil Co. of N.J., 294 U.S. 87, 95-96 (1935) (Cardozo, J.); see also 2A N. Singer, Sutherland on Statutes and Statutory Construction § 47.07, p. 152, and n. 10 (5th ed. 1992) (collecting cases). That is to say, the statute, read "as a whole," post at 998 [530 U.S. 943] (THOMAS, J., dissenting), leads the reader to a definition. That definition does not include the Attorney General's restriction—"the child up to the head." Its words, "substantial portion," indicate the contrary." [Stenberg v. Carhart, 530 U.S. 914 (2000)]

IRS Form 1042-S Instructions indicate the circumstances under which identifying number are absolutely mandatory, and all of them involve federal privileges and franchises that I am NOT engaged in. If you think I am engaged in a federal franchise, please describe exactly WHICH one of the below franchises I am specifically engaged in and provide the specific statute that mandates someone with my status to provide such a number. Otherwise, your request is illegal:

Box 14, Recipient's U.S. Taxpayer Identification Number (TIN)

You must obtain a U.S. Taxpayer identification number (TIN) for:

- Any recipient whose income is effectively connected with the conduct of a trade or business ["public office" per 26 U.S.C. 57701(a)(26)] in the United States [District of Columbia per 4 U.S.C. 572 and 26 U.S.C. 57701(a)(9) and (a)(10)]. Note. For these recipients, exemption code 01 should be entered in box 6.
- Any foreign person claiming a reduced rate of, or exemption from, tax under a tax treaty between a foreign country and the United States [per 26 U.S.C. 8894], unless the income is an unexpected payment (as described in Regulations section 1.1441-6(g) or consists of dividends and interest from stocks and debt obligations that are actively traded; dividends from any redeemable security issued by an investment company registered under the Investment Company Act of 1940 (mutual fund); dividends, interest, or royalties from units of beneficial interest in a unit investment trust that are (or were, upon issuance) publicly offered and are registered with the Securities and Exchange Commission

Why It Is Illegal For Me To Request Or To Use A Taxpayer Ident

DOCH 361061

11/27/2012 01:09 PM Page: 56 of 178
AFF R: \$10.00 J. C. Sloan, McKinley County



2022-011769 MISC Page: 1959 of 2782
09/26/2022 03:35:37 PM Receipt #: 22-9381
Rep Fee: \$30.00 Darrell James Hill
Gila County, Az, Sadie Jo Birmingham, Recorder

1950

DOCH 361076

11/27/2012 04:15 PM Page: 67 of 183
AFF R: \$10.00 J. C. Sloan, McKinley County

WHY IT IS ILLEGAL FOR ME TO REQUEST OR TO USE A TAXPAYER IDENTIFICATION NUMBER (TIN)

under the Securities Act of 1933; and amounts paid with respect to loans of any of the above securities.

- Any nonresident alien individual claiming exemption from tax under section 871(f) for certain annuities received under qualified plans.
- A foreign organization claiming an exemption from tax solely because of its status as a tax-exempt organization under section 501(c) or as a private foundation.
- Any QI [Qualified Intermediary per 26 CFR §1.1441-1(e)(5)].
- Any WP [Withholding Partnership per 26 CFR §1.1441-5(c)] or WT [Withholding Trust per 26 CFR §1.1441-5(c)].
- Any nonresident alien individual claiming exemption from withholding on compensation for independent personal services [services connected with a "trade or business"]
- Any foreign grantor trust with five or fewer grantors.
- Any branch of a foreign bank or foreign insurance company that is treated as a U.S. person.

If a foreign person provides a TIN on a Form W-8, but is not required to do so, the withholding agent must include the TIN on Form 1042-S.

[IRS Form 1042s Instructions, Year 2006, p. 14]

If it is a violation of 42 U.S.C. §408(a)(8) to compel the use of Social Security Numbers and I DO NOT consent to use them:

TITLE 42 – THE PUBLIC HEALTH AND WELFARE
CHAPTER 7 – SOCIAL SECURITY
SUBCHAPTER II – FEDERAL OLD-AGE, SURVIVORS, AND DISABILITY INSURANCE BENEFITS
Sec. 408. Penalties

(a) In general
Whoever –...

(8) discloses, uses, or compels the disclosure of the social security number of any person in violation of the laws of the United States; shall be guilty of a felony and upon conviction thereof shall be fined under title 18 or imprisoned for not more than five years, or both.

If you use a government issued identifying number against me without my consent or permission, you are also committing identity theft and thereby violating the following statutes:

1. 42 U.S.C. §405(c)(2)(C)(i): Evidence, Procedure, and Certification for payments
2. 42 U.S.C. §408(a)(7): Penalties.
3. 18 U.S.C §1028(a)(7): Fraud and related activity in connection with identification documents, authentication features, and information
4. 18 U.S.C §1028A: Aggravated Identity Theft
5. 18 U.S.C §654: Anyone who uses a public number in connection with you property without your private consent is guilty of conversion.
6. 18 U.S.C §1001: Materiality. Failing to give full disclosure of the terms and conditions of a federal franchise.

For further information about how the government prosecutes identity theft described above, see:

U.S. Attorneys Bulletin, Volume 53, No. 1, Jan. 2006: <http://famguardian.org/Publications/USAttyBulletins/usab5301.pdf>

SECTION 6: WARNING ABOUT USING IDENTIFYING NUMBER ON INFORMATION RETURNS OR OTHER GOVERNMENT FORMS

WARNING TO RECIPIENT! Any document, form, or information in your possession which associates a federal government issued identifying number with the Submitter of this form is knowingly false and fraudulent. Please immediately:

1. Correct your records to remove all such FALSE numbers.
2. Cease and desist filing of information returns containing such numbers. Information returns include IRS Forms W-2, 1042s, 1098, 1099, and K-1. Pursuant to 26 U.S.C. §6041(a), all such information returns may only lawfully be submitted against persons who are engaged in a "trade or business", which is then defined as "the functions of a public office" in the U.S. Government pursuant to 26 U.S.C. §7701(a)(26). I am not now and never have lawfully been engaged in a "public office" within the U.S. Government.
3. Send in corrected information returns which remove the false identifying number associated with me and change the amount of earnings reported that are connected to a "trade or business" to ZERO.

Why It Is Illegal For Me To Request Or To Use A Taxpayer Ident

DOCH 361061

11/27/2012 01:09 PM Page: 57 of 178
AFF R:\$10.00 J. C. Sloan, McKinley County



2022-011769 MISC Page: 1960 of 2782

09/26/2022 03:35:37 PM Receipt # : 22-9381
Darrell James Hill
Rec Fee: \$30.00
Gila County, Az, Sadie Jo Birmingham, Recorder



DOCH 361076

11/27/2012 04:15 PM Page: 58 of 183
AFF R:\$10.00 J. C. Sloan, McKinley County



1951

WHY IT IS ILLEGAL FOR ME TO REQUEST OR TO USE A TAXPAYER IDENTIFICATION NUMBER (TIN)

If you do not do the above immediately, you could be the subject of a criminal complaint against the recipient of this form based on all the violations of law resulting from fraudulent or compelled use of government issued identifying numbers described herein. That criminal complaint may also include a complaint under 26 U.S.C. 657206 and 7207, which make it a crime to file knowingly false information returns. These returns are false in my case because I AM NOT engaged in the "trade or business" federal franchise and because I am not eligible for, do not consent to use, and have terminated unlawful participation in all government programs that would issue a government number or convey any kind of government benefit whatsoever to the Submitter.

SECTION 7: CONSTRAINTS ON THE DELEGATED AUTHORITY OF THE SUBMITTER IN RELATION TO THE GOVERNMENT

1. Submitter is acting in a fiduciary and trustee capacity for God and ONLY God 24 hours a day, seven days a week. The terms of the trust indenture and constraining this delegated authority are found in the Holy Bible Trust Indenture. Under the terms of the Holy Bible Trust indenture, Submitter has NO DELEGATED AUTHORITY to:

3.1 Contract with or conduct any kind of commerce with any government other than God's government on earth.

"You shall make no covenant with them [foreigners], nor with their [pagan government] gods [or judges]. They shall not dwell in your land [and you shall not dwell in theirs by becoming a "resident" in the process of contracting with them], lest they make you sin against Me. For if you serve their gods [under contract or agreement], it will surely be a snare to you."

[Exodus 23:32-33, Bible, NKJV]

"It is our true policy to steer clear of permanent alliances [contract/covenants] with any portion of the foreign world."

[George Washington, Farewell Address]

"Peace, commerce, and honest friendship with all nations - entangling alliances [contracts, covenants, treaties] with none."

[Thomas Jefferson, First Inaugural Address, March 4, 1801]

Act as a "public officer" or agent of the government in any capacity, and especially in the context of the "trade or business" franchise defined in 26 U.S.C 57701(a)(26) as "the function of a public office". I may ONLY serve the Lord and ONLY have allegiance protection from him and not any man.

"No servant can serve two masters: for either he will hate the one, and love the other; or else he will hold to the one, and despise the other. Ye cannot serve God and mammon."

[Luke 16:13, Bible, KJV]

4. The Holy Bible Trust Indenture applies from the date that the Submitter became a Christian.
5. Any express or implied agreements or contract between the Submitter and the government must be deemed to have been undertaken without delegated authority and are therefore null and void ab initio.

"All persons dealing with public officers [or Heavenly officers] are bound to take notice of the [Biblical] law prescribing their authority and powers."

[State ex rel McConnell v. First State Bank, 22 Tenn. App. 577, 124 S.W.2d 726, 733 (1938)]

"Of this it is enough to say that the United States is neither bound nor stopped by acts of its officers or agents in entering into an arrangement of agreement to do or cause to be done what the [Biblical] law does not sanction or permit," 243 U.S., at 409. [ditto for officers of Heaven]

[Utah Power and Light Co. v. United States, 243 U.S. 289, 37 S.Ct 387 (1917)]

"Where an executive officer, under his misconstruction of the [Biblical] law, has acted without or beyond the powers given him, the courts have jurisdiction to restore the status quo ante insofar as that may be done (cites omitted)."

[United States v. Mott, 37 F.2d 860, 862 (10th Cir. 1930), Affirmed, Mott v. United States, 283 U.S. 747, 51 S.Ct. 642 (1931)]

DOCH 361061

11/27/2012 01:09 PM Page: 58 of 178
AFF R:\$10.00 J. C. Sloan, McKinley County



2022-011769 MISC Page: 1961 of 2782
09/26/2022 03:35:37 PM Receipt #: 22-9381
Darrell James Hill
Rec Fee: \$30.00
Gila County, AZ, Sadie Jo Bingham, Recorder

DOCH 361076

11/27/2012 04:15 PM Page: 59 of 183
AFF R:\$10.00 J. C. Sloan, McKinley County

Why It Is Illegal For Me To Request Or To Use A Taxpayer Identif

WHY IT IS ILLEGAL FOR ME TO REQUEST OR TO USE A TAXPAYER IDENTIFICATION NUMBER (TIN)

*"[T]he authority of ministerial officers is to be strictly construed as including only such power as are expressly conferred [in the Holy Bible], or necessarily implied," 141 F.2d, at 913.
[Youngblood v. United States, 141 F.2d 912 (6th Cir. 1944): Action to compel recorder to record tax liens]*

*"Whatever the form in which the [Heavenly] Government functions, anyone entering into an arrangement with the [Heavenly] Government takes the risk of having accurately ascertained that he who purports to act for the [Heavenly] Government stays within the bounds of his authority. The scope of this authority may be explicitly defined by Congress [or the Holy Bible] or be limited by delegated legislation, properly exercised through the rule-making power. And this is so even though, as here, the agent himself may have been unaware of the limitation upon his authority," 332 U.S., at 384.
[Federal Crop Ins. Corp. v Merrill, 332 U.S. 380, 68 S.Ct. 1 (1947)]*

6. Any contracts entered into on my behalf by my parents are null and void ab initio. This includes any application for government benefits or franchises submitted on my behalf by my parents or guardians, such as Social Security.
7. Government has received reasonable notice of the revocation of the Social Security Contract by being sent the SSA Form 521 (and posted in the public record) in 2006 (and, reestablishing the same rescission in the public record in 2009).
8. Submitter reserves all his God given unalienable rights pursuant to UCC 1-208 and its predecessor, UCC 1-207, and UCC 1-103.
9. Because Submitter reserves all rights and has no authority to delegate any of them under the terms of the Holy Bible Trust indenture, then he is a foreign sovereign within the meaning of the **Foreign Sovereign Immunities Act, 28 U.S.C. Part IV, Chapter 97**.
10. Submitter has and will continue to notify the government in ONLY in written forms that all obligations, contracts, or agreements between him and any other foreign sovereign such as the United States government are ceased.
11. Any obligations, debts, or collection notices sent to the Submitter by the government must be accompanied by the written instrument containing his signature that created the alleged debt pursuant to the documents attached herein and the **Fair Debt Collection Practices Act, 15 U.S.C. §1692(g)(b)** and UCC 3-501.
12. Recipient is reminded that if the government can enact anything requiring all contracts with the government to be in writing, then I have equal right to enforce the same requirement upon the government by giving reasonable notice of the existence of such requirement.

*"Every man is supposed to know the law. A party who makes a contract with an officer [of the government or of God's government] without having it reduced to writing is knowingly accessory to a violation of duty on his part. Such a party aids in the violation of the law."
[Clark v. United States, 95 U.S. 539 (1877)]*

SECTION 8: YOU ARE NOT EMPOWERED TO PRACTICE LAW ON MY BEHALF OR MAKE LEGAL DETERMINATIONS ABOUT MY STATUS

do not consent to allow you, the Recipient of this form, to practice law on my behalf, to represent me legally, or make any legal determinations about my status other than those already indicated here under penalty of perjury. You **MUST** accept what I tell you about my status under penalty of perjury and presume that it is truthful and accurate. Please DO NOT:

1. Contact the IRS to get them to contradict what I tell you here, because they are not authorized to determine my status, they have no personal knowledge of my circumstances and therefore cannot act as a witness, and because nothing they say or print is trustworthy by their own admission!!

"Unfortunately, the IRS is not bound by answers or positions stated by its employees orally, whether in person or by telephone. According to the procedural regulations, "oral advice is advisory only and the Service is not bound to recognize it in the examination of the taxpayer's return." 26 CFR §601.201(k)(2). [...] Thus, it will still be difficult to bind the IRS even to written statements made by its employees. As was true before, taxpayers may be penalized for following oral advice from the IRS."

[Tax Procedure and Tax Fraud, Patricia Morgan, 1999, ISBN 0-314-06586-5, West Group, p. 34]

*"IRS Publications, issued by the National Office, explain the law in plain language for taxpayers and their advisors... While a good source of general information, publications should not be cited to sustain a position."
[Internal Revenue Manual, Section 4.10.7.2.8 (05-14-1999)]*

1. Approach me with legal counsel or an attorney intent on contradicting what I state here and hereafter under penalty of perjury. He or she does not have personal knowledge of my circumstances and therefore is not a competent witness, and I do not empower him or her to "represent me". Furthermore, the courts say that you cannot rely on legal counsel to determine your status. We are

Why It Is Illegal For Me To Request Or To Use A Taxpayer Ident

DOCH 361061

11/27/2012 01:09 PM Page: 59 of 178
AFF R:\$10.00 J. C. Sloan, McKinley County



2022-011769 MISC Page: 1962 of 2782
09/26/2022 03:35:37 PM Receipt #: 22-9381
Reg Fee: \$30.00 Darrell James Hill
Gila County, Az, Sadie Jo Bingham, Recorder

DOCH 361076

11/27/2012 04:15 PM Page: 60 of 183
AFF R:\$10.00 J. C. Sloan, McKinley County

WHY IT IS ILLEGAL FOR ME TO REQUEST OR TO USE A TAXPAYER IDENTIFICATION NUMBER (TIN)

society of laws and not of men and each person is the only person who can or should read and apply the law to their own specific circumstances:

"But it must be remembered that all are presumed to know the law [the Internal Revenue Code, which is municipal law for the District of Columbia], and that whoever deals with a municipality [e.g. the District of Columbia, also called the "United States"] is bound to know the extent of its powers. Those who contract with it, or furnish it supplies, do so with reference to the law, and must see that limit is not exceeded. With proper care on their part and on the part of the representatives of the municipality, there is no danger of loss."

[San Francisco Gas Co. v. Brickwedel, 62 Cal 641 (1882). See also Dore v. Southern Pacific Co. (1912), 163 Cal. 182, 124 P. 817; People v. Flanagan (1924), 65 Cal.App. 268, 223 P. 1014; Lincoln v. Superior Court (1928), 95 Cal.App. 35, 271 P. 1107; San Francisco Realty Co. v. Linnard (1929), 98 Cal.App. 33, 276 P. 368]

3. Tell me you have a "policy" to disregard or contradict what appears here. Corporate or private policy cannot and does not supersede the requirements of enacted law. I am NOT interested in your "policy", but only in doing what the law allows and require both me and you to do or not do in this circumstance. I WILL NOT help you violate the laws clearly documented here by applying for or using government issued identifying number, regardless of what your "policy" is. I am a law abiding American who scrupulously reads and obeys all laws that apply to the jurisdiction I am in. Are You?

I am willing, able, and eager to be educated by your legal counsel if you believe anything here incorrect. If I am proven incorrect with court admissible evidence signed under penalty of perjury for which the witness agrees to take personal responsibility, I will change my testimony on the form, but not before. The only thing I want to talk about, however, is the law. I am not interested in what the "policy" of the recipient is because I don't and won't govern my life by "policy" or even "public policy" disguised as de facto law. I must obey the laws of my God, which say that I can't contract with, do business with, be a "resident", "citizen", or domiciliary of, or pay money to any government, which it calls "the Beast" in Rev. 19:19.

"You shall make no covenant [contract or franchise] with them [foreigners, pagans], nor with their [pagan government] gods [laws or judges]. They shall not dwell in your land [and you shall not dwell in theirs by becoming a "resident" in the process of contracting with them], lest they make you sin against Me [God]. For if you serve their gods [under contract or agreement or franchise], it will surely be a snare to you."
[Exodus 23:32-33, Bible, NKJV]

"You shall no other gods [including political rulers, governments, or earthly laws] before Me [or My commandments]."
[Exodus 20:3, Bible, NKJV]

"Do you not know that friendship with the world is enmity with God? Whoever therefore wants to be a friend ["citizen", "taxpayer", "inhabitant", or "subject" under a king or political ruler] of the world [for any man-made kingdom other than God's Kingdom] makes himself an enemy of God."
[James 4:4, Bible, NKJV]

I am protected in the above pursuits by the First Amendment to the United States Constitution and the Religious Freedom Restoration Act, 42 U.S.C. Chapter 21B. It is my right and my duty under God's laws to have the status and the standing described herein.

SECTION 9: SIGNATURE OF SUBMITTER

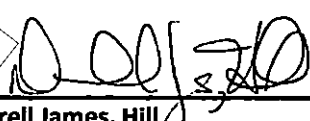
<p>Submitter Signature:</p>	<p>I declare by unsworn affirmation from without the "United States" in accordance with <u>28 U.S.C. § 1746(1)</u> that the facts provided in this section are true, correct, and complete to the best of my knowledge and belief.</p> <p></p> <p>Darrell James, Hill</p>	<p>Date signed:</p> <p>06/19/12</p>	
-----------------------------	--	-------------------------------------	--

Signature and form NOT VALID without the attached signed form entitled "AFFIDAVIT OF CITIZENSHIP, DOMICILE, AND TAX STATUS."

Why It Is Illegal For Me To Request Or To Use A Taxpayer Ident

DOCH 361061

11/27/2012 01:09 PM Page: 60 of 178
AFF R: \$10.00 J. C. Sloan, McKinley County



2022-011769 MISC Page: 1963 of 2782
09/26/2022 03:35:37 PM Receipt #: 22-9381
Rec Fee: \$30.00 Darrell James Hill
Gila County, Az, Sadie Jo Bingham, Recorder

DOCH 361076

11/27/2012 04:15 PM Page: 61 of 183
AFF R: \$10.00 J. C. Sloan, McKinley County

1954

Unofficial Copy

DOCH 361076

11/27/2012 04:15 PM Page: 62 of 183
AFF R:\$10.00 J. C. Sloan, McKinley County



Item No. 1

Item 1:
Encl. 2
Art. 1

Affidavit of Citizenship, Domicile, and Tax Status, June 2012
Mailing and Acceptance Information

John R. Davis,
RG2 Claims Administration, Philadelphia, Pennsylvania
USPO CMN: 7011 0470 0002 1606 2168

Accepted: June 25, 2012
Mailing and Acceptance Information

2022-011769 MISC Page: 1964 of 2782
09/26/2022 03:35:37 PM Receipt #: 22-9381
Rec Fee: \$30.00 Darrell James Hill
Gila County, Az, Sadie Jo Bingham, Recorder



DOCH 361061

11/27/2012 01:09 PM Page: 61 of 178
AFF R:\$10.00 J. C. Sloan, McKinley County



1935



Search USPS.com or Track Packages

Quick Tools

Ship a Package

Send Mail

Manage Your Mail

Shop

Business Solutions

Track & Confirm

GET EMAIL UPDATES PRINT DETAILS

YOUR LABEL NUMBER	SERVICE	STATUS OF YOUR ITEM	DATE & TIME	LOCATION	FEATURES
7011047000216062168	Priority Mail®	Delivered	June 25, 2012 12:43 pm	PHILADELPHIA, PA 19102	Expected Delivery B June 22, 2012 Certified Mail™
		Notice Left	June 25, 2012, 10:45 am	PHILADELPHIA, PA 19102	
		Arrival at Unit	June 22, 2012, 8:58 am	PHILADELPHIA, PA 19104	
		Depart USPS Sort Facility	June 22, 2012	PHILADELPHIA, PA 19116	
		Processed at USPS Origin Sort Facility	June 21, 2012, 10:31 pm	PHILADELPHIA, PA 19116	
		Acceptance	June 20, 2012, 8:17 am	RAMAH, NM 87321	

2022-011769 MISC
 09/26/2022 03:35:37 PM
 Rec Fee: \$30.00 Darrell James Hill
 Gila County, Az, Sadis Jo Bingham, Recorder

Check on Another Item
 What's your label (or receipt) number?

LEGAL
 Privacy Policy
 Terms of Use
 FOIA
 No FEAR Act EEO Data

ON USPS.COM
 Government Services
 Buy Stamps & Shop
 Print a Label with Postage
 Customer Service
 Site Index

Copyright © 2012 USPS All Rights Reserved.

U.S. Postal Service™ CERTIFIED MAIL™ RECEIPT (Domestic Mail Only; No Insurance Coverage Provided)

For delivery information visit our website at www.usps.com

Postage	\$ 5.15
Certified Fee	2.95
Return Receipt Fee (Endorsement Required)	2.35
Restricted Delivery Fee (Endorsement Required)	
Total Postage & Fees	\$ 10.45

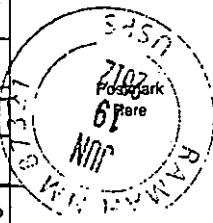

7011 0470 0002 1606 2168
 Sent to:
 Recipient's Name: Johnson v. AzHHA Settlement Administrator
 Recipient's Address: c/o John R. Davis, Esq.
 Recipient's City: RG/2 Clams Administration LLC
 Recipient's State: P.O. Box 59479
 Recipient's Zip: Philadelphia, PA 19102-9479

SENDER: COMPLETE THIS SECTION

- Complete items 1, 2, and 3. Also complete item 4 if Restricted Delivery is desired.
- Print your name and address on the reverse so that we can return the card to you.
- Attach this card to the back of the mailpiece, or on the front if space permits.

1. Article Addressed to:

1956
 Johnson v. AzHHA Settlement
 c/o John R. Davis, Esq.
 RG/2 Clams Administration LLC
 P.O. Box 59479
 Philadelphia, PA 19102-9479

A. Signature

x *[Signature]*

- Agent
 Addressee

B. Received by (Printed Name)

MICHAEL

C. Date of Delivery

6/25/12

D. Is delivery address different from item 1? Yes
 If YES, enter delivery address below: No

3. Service Type

- Certified Mail Express Mail
 Registered Return Receipt for Merchandise
 Insured Mail C.O.D.

4. Restricted Delivery? (Extra Fee) Yes

2. Article Number
 (Transfer from service label)

7011 0470 0002 1606 2168

DOCH 361061

11/27/2012 01:09 PM Page: 62 of 178
 AFF R: \$10.00 J. C. Sloan, McKinley County

11/27/2012 04:15 PM Page: 63 of 183
 AFF R: \$10.00 J. C. Sloan, McKinley County

DOCH 361076

Unofficial Copy

DOCH 361076

11/27/2012 04:15 PM Page: 64 of 183
AFF R:\$10.00 J. C. Sloan, McKinley County



Item No. 1

Item 1: Encl. 3
June 2012

Class Attorney Instruction: Support Position and Status Statements
Mailing and Acceptance Information
Class Attorney Mark Samson, Phoenix, Arizona
USPO CMN: 7008 1830 0002 1030 0038
Accepted: June 29, 012
Mailing and Acceptance Information

1957

2022-011769 MISC Page: 1966 of 2782
09/26/2022 03:35:37 PM Receipt #: 22-9381
Rec Fee: \$30.00 Darrell James Hill
Gila County, Az, Sadie Jo Bingham, Recorder



DOCH 361061

11/27/2012 01:09 PM Page: 63 of 178
AFF R:\$10.00 J. C. Sloan, McKinley County



English Customer Service USPS Mobile

Register / Sign In



Search USPS.com or Track Packages

Quick Tools

Ship a Package

Send Mail

Manage Your Mail

Shop

Business Solutions

Track & Confirm

GET EMAIL UPDATES PRINT DETAILS

YOUR LABEL NUMBER	SERVICE	STATUS OF YOUR ITEM	DATE & TIME	LOCATION	FEATURES
70081830000210300038	Priority Mail®	Delivered	June 29, 2012, 2:58 pm	PHOENIX, AZ 85012	

Check on Another Item

What's your label (or receipt) number?



LEGAL

- Privacy Policy ›
- Terms of Use ›
- FOIA ›
- No FEAR Act EEO Data ›

ON USPS.COM

- Government Services ›
- Buy Stamps & Shop ›
- Print a Label with Postage ›
- Customer Service ›
- Site Index ›

ON ABOUT.USPS.COM

- About USPS Home ›
- Newsroom ›
- Mail Service Updates ›
- Forms & Publications ›
- Careers ›

OTHER USPS SITES

- Business Customer Gateway ›
- Postal Inspectors ›
- Inspector General ›
- Postal Explorer ›

Copyright© 2012 USPS. All Rights Reserved.

U.S. Postal Service™
CERTIFIED MAIL™ RECEIPT
(Domestic Mail Only; No Insurance Coverage Provided)

For delivery information visit our website at www.usps.com

OFFICIAL USE

Postage	\$ 5.15
Certified Fee	2.95
Return Receipt Fee (Endorsement Required)	
Restricted Delivery Fee (Endorsement Required)	
Total Postage & Fees	\$ 8.10



Sent To

Street, Apt. No.
 or PO Box No.
 City, State, ZIP

Mark Samson
 Keller Rohrback, P.L.C.
 3101 North Central Avenue, Suite 1400
 Phoenix, AZ 85012

PS Form 3800, August 2009

2022-011769 MISC Page: 1967 of 2782

09/26/2022 03:35:37 PM Receipt #: 22-9381
 Rec Fee: \$30.00 Darrell James Hill
 Gila County, Az, Sadie Jo Bingham, Recorder



DOCH 361061

11/27/2012 01:09 PM Page: 64 of 178
 AFF R:\$10.00 J. C. Sloan, Mckinley County



DOCH 361076

11/27/2012 04:15 PM Page: 65 of 183
 AFF R:\$10.00 J. C. Sloan, Mckinley County



UNOFFICIAL COPY
 1958
 9000 DEPT 2000 DEPT 9002

DOCH 361076

11/27/2012 04:15 PM Page: 66 of 183
AFF R:\$10.00 J. C. Sloan, McKinley County



Item No. 2

Item 2:
Oct. 2012

Reiteration of Position and Status, Class Attorney Instructions re: SSA Rescission, RG2 Claims
Class Member and spouse American Citizen Status Statements
Class Attorney Mark Samson, Phoenix, Arizona
USPO CMN: 7010 1060 0001 7518 9147
Accepted: Oct. 9, 2012

2022-011769 MISC Page: 1968 of 2782
09/26/2022 03:35:37 PM Receipt #: 22-9381
Rec Fee: \$30.00 Darrell James Hill
Gila County, Az, Sadie Jo Bingham, Recorder



DOCH 361061

11/27/2012 01:09 PM Page: 65 of 178
AFF R:\$10.00 J. C. Sloan, McKinley County



Darrell James, Hill
28 Hilltop Court, HC 61, Box 771, Ramah, New Mex.

USPO CMN 7010 1060 0001 7518 9147

(602) 248-0088
www.kellerrohrback.com

Mark Samson
Keller Rohrback, P.L.C.
3101 North Central Avenue
Suite 1400
Phoenix, AZ 85012

RE: Johnson v. AzHHA class member Darrell James, Hill (member 000000932): See related correspondence to SSA Commissioner Astrue (c/o President Obama) re: sovereign status (See Affidavit DOC# 360413, McKinley County, N. Mex.).

Dear Mr. Samson,

I am writing again concerning my complete prohibition of all deductions made upon RG2 Claims; correspondence was initially sent to you by USPO CMN: 70021830000210300038.

Historically:

I denied RG2 authority to make any deductions from any proceeds due to me. RG2 did not respond.

I sent my Citizenship status declaration to you (which you sent to David Sorensen). Thenafter, I spoke with David regarding the deductions matter, and David reportedly:

- i) spoke with RG2 Claims; and,
- ii) **RG2 concluded to ignore my Sovereign rights, Constitutional law and federal statutes to impose unlawful actions against me despite my clearly expressed non-authorization of their proposed deductions upon any class member distributions due to me.**

My wife and I are not "U.S. Citizens" in the statutory sense; we are American Citizens in the Constitutional sense. To this end my wife and I have written to the Commissioner of the SSA AGAIN to illuminate our choices of SSA Non-association. The attached Affidavit, DOC# 360413, McKinley County, N. Mex. is important as relates to our American Citizen Non-SSA association statuses, and as relates to our to be expected RG2 Claims suit for recovery of redistributed funds.

I want to begin the suit as soon as deductions have for fact been made upon receipts due to me. I know that RG2 Claims is not my enemy; however, I will need to sue them on Constitutional grounds for the immediate and direct repayment to me of all funds redistributed in Any case, and damages if the court allows. I do not consent to RG2's mechanical predilections in my case (all considered), NOR has or could the district court(s) sanction RG2 to impose Constitutional law or federal statutory violations upon my wife and I.

Please contact me at: djhill4yah@yahoo.com; 1.505.783.2499, concerning the RG2 deduction matter. And, I will need Pennsylvania counsel for Constitutional court. I have asked David for same but he has not yet responded; I hope he is well.

Sincerely,

Darrell James, Hill

Enclosed: Affidavit, DOC# 360413, McKinley County, N. Mex.

2022-011769 MISC Page: 1969 of 2782
09/26/2022 03:35:37 PM Receipt #: 22-9381
Rec Fee: \$30.00 Darrell James Hill
Gila County, Az, Sadie Jo Bingham, Recorder

DOC# 361061

11/27/2012 01:09 PM Page: 66 of 178
AFF R: \$10.00 J. C. Sloan, McKinley County

DOC# 361076

11/27/2012 04:15 PM Page: 67 of 183
AFF R: \$10.00 J. C. Sloan, McKinley County

Unofficial Copy

DOCH 361076

11/27/2012 04:15 PM Page: 68 of 183
AFF R:\$10.00 J. C. Sloan, McKinley County



Item No. 2

Item 2:

Encl. A

Aug. 2012

Notice of Default upon Commissioner of SSA

Commissioner

John Astrue c/o President Barack Obama

USPO CMN: 7009 2820 0003 8851 6155

Accepted: Sept. 21, 2012

(McKinley County, New Mexico, DOC# 360413)

1961

2022-011769 MISC Page: 1970 of 2782

09/26/2022 03:35:37 PM Receipt #: 22-9381

Rec Fee: \$30.00 Darrell James Hill

Gila County, Az, Sadie Jo Bingham, Recorder



DOCH 361061

11/27/2012 01:09 PM Page: 67 of 178

AFF R:\$10.00 J. C. Sloan, McKinley County



Affidavit

We, the Hills, **Hill Darrell James (husband)**, and **Romero-Hill Beverly Jean (wife)**, affirm that the copies of the following documents enclosed are accurate and truthful to the best of our ability(s), and were reported delivered as indicated by the USPO (www.usps.com) confirmations, attached:

Correspondence: Affidavits sent to Social Security Administrator Commissioner Astrue c/o President Barack Hussein Obama: USPO RMN: **RE 430 969 426 US** - Delivered: September 13, 2012, 4:23 am (Enclosure A: pages)

Correspondence: Copy of Affidavits (sent to Commissioner Astrue c/o President Barack Hussein Obama: RMN: **RE 430 969 426**) sent Directly to Commissioner Astrue: USPO CMN: **7009 2820 0003 8851 6155** - Delivered: September 21, 2012, 8:02 am (Enclosure B: pages)



Darrell James Hill (husband)
Sovereign Citizen of the United States of America



Beverly Jean Romero-Hill (wife)
Sovereign Citizen of the United States of America

NOTARY PUBLIC CERTIFICATION

BEFORE ME, the undersigned authority, a Notary Public, of the County of CIBOLA Republic of NM (statename), this 20th day of September, 2012, **Darrell James, Hill, and Beverly Jean, Romero- Hill**, the above signed human beings did appear and were identified by (circle one): driver's licenses / passports / other, and who, upon first being duly sworn and/or affirmed, deposes and says that the foregoing asseveration true to the best of their knowledge and belief(s).

I (We) certify under PENALTY OF PERJURY under the laws of the state of New Mexico that the foregoing paragraph is true and correct.

WITNESS my hand and official seal.

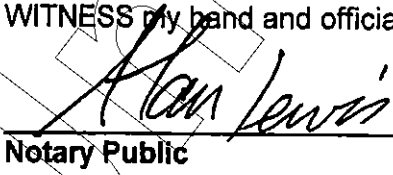
Notary Public

Seal



DOCH 361076
11/27/2012 04:15 PM Page: 69 of 183
AFF R:\$10.00 J. C. Sloan, McKinley County

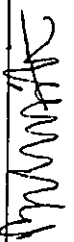

DOCH 360413
10/02/2012 09:54 AM Page: 1 of 23
AFF R:\$10.00 J. C. Sloan, McKinley County

2022-011769 MISC Page: 1971 of 2782
09/26/2022 03:35:37 PM Receipt #: 22-9381
Rec Fee: \$30.00 Darrell James Hill
Gila County, Az, Sadie Jo Bingham, Recorder

DOCH 361061
11/27/2012 01:09 PM Page: 68 of 178
AFF R:\$10.00 J. C. Sloan, McKinley County

Affidavit

Unofficial Copy

ENCLOSURE: A

DOCH 361076

11/27/2012 04:15 PM Page: 70 of 183
AFF R:\$10.00 J. C. Sloan, McKinley County



DOCH 360413

10/02/2012 09:54 AM Page: 2 of 23
AFF R:\$10.00 J. C. Sloan, McKinley County



ENCLOSURE: A

1963

2022-011769 MISC Page: 1972 of 2782
09/26/2022 03:35:37 PM Receipt #: 22-9381
Rec Fee: \$30.00 Darrell James Hill
Gila County, Az, Sadie Jo Bingham, Recorder



DOCH 361061

11/27/2012 01:09 PM Page: 69 of 178
AFF R:\$10.00 J. C. Sloan, McKinley County



Hill Bt

Darrell James, Hill, and Beverly Jean, Romero-Hill
28 Hilltop Court, HC 61, Box 771, Ramah, New Mex.

USPO RMN: RE 430 969 426 US

President Barack Hussein Obama
The White House
1600 Pennsylvania Avenue NW
Washington, DC. 20500

Re: Commissioner John J. Astrue c/o President Barack H. Obama Affidavits.(attached)

Dear Mr. President:

Our name is Hill: Darrell James, Hill, husband, and wife Beverly Jean Romero- Hill. We are American Citizens born in states of the union of States of America. We trust in God Almighty, the God of Abraham, Isaac and Jacob, and keep the commandments of the Most High God YHVH sacred.

We have written to Commissioner Astrue c/o You the attached Affidavit(s) (Notices of Default) because you are this agency's direct chief executive. The Affidavit, decrees our Non-SSA association status and demands the Commissioner's strict compliance with our Constitutional decree.

Issue History and Status

We administratively ordered Commissioner to rescind the any SSA association (account, number, et seq.) over six years ago necessitating writing the American Citizen Sovereign's Affidavits now enclosed to Commissioner c/o you.

The statuses are not administrative issues, not requests, and not subject to dispute. The decrees and demands are plainly from inalienable Constitutional rights of choice as we did act, and the Commissioner is Constitutionally constrained and duty bound to serve in accordance with each decree and order. (When a Constitutional republic's principles are abandoned without apprehension of repercussion, look for a dulocracy.)

What We want you to do

Commit the letter to the addressee; and, oblige the Commissioner to without hesitation obey our decrees and demands, to respect our choices under obligation to the Constitution for United States of America. Your expedience in this matter would be appreciated.

Sincerely;



Darrell James, Hill (husband)
Sovereign Citizen of the United States of America



Beverly Jean, Romero-Hill (wife)
Sovereign Citizen of the United States of America

Enclosure: Affidavit: Notice of Default, sent to Commissioner of SSA from husband (4 pages)
Affidavit: Notice of Default, sent to Commissioner of SSA from wife (3 pages)

Letter to Presid

DOCH 361061

USPO RMN: USPO RMN: RE 430 9

11/27/2012 01:09 PM Page: 70 of 178
AFF R:\$10.00 J. C. Sloan, Mckinley County



2022-011769 MISC Page: 1973 of 2782
09/26/2022 03:35:47 PM Receipt #: 22-9381
Rec Fee: \$30.00 Darrell James Hill
Gila County, AZ, Sadie Jo Binham, Recorder



DOCH 361076

11/27/2012 04:15 PM Page: 71 of 183
AFF R:\$10.00 J. C. Sloan, Mckinley County



DOCH 360413

10/02/2012 09:54 AM Page: 3 of 23
AFF R:\$10.00 J. C. Sloan, Mckinley County



AFFIDAVIT

Commissioner John J. Astrue,
c/o President Barack Hussein Obama
Office of Commissioner
Social Security Administration
6401 Security Blvd.
Baltimore, MD 21235

NOTICE OF DEFAULT

You are in Default of Notice and Demand:

this document is the service of Notice of Default upon you Commissioner Astrue, et al., (Commissioner) of the Social Security Administration (SSA) for dishonor upon the demand and all prior notices of same from Darrell James, Hill, (Submitter) to rescind all SSA association as ordered, noticed and demanded.

Darrell James, Hill:

Submitter is an American citizen, a private human being born within the states of the Union of States of America. Submitter is Not a "U.S. Citizen", "person", "individual", "resident", "entity", or "etc." other terms of the municipal, administrative law and adhesion contract(s) of the "United States"; Rather, Submitter is a non-volunteer of same.

I, Darrell James, Hill, have settled my belief and place all my trust in God Almighty, the Torah God of Abraham, Isaac and Jacob, YHVH to protect and provide for me forever, now and hereafter. All I have ever needed is manifested through Him. This fact is my experience, understanding, my religious choice of Sovereign right, and not alienable under the Constitution for the United States of America. No other guarantor, specifically the United States SSA, is necessary or needed as I decided in May of 2006, the date of the ORIGINAL Order of Rescission received by the SSA association, et seq. See Since 2006 the Commissioner has ignored Submitter's determination (below).

Since 2006 the Commissioner has ignored Submitter's determination:

1. See Judges Order in United States of America v. Beverly J. Hill, and Darrell J. Hill, individually, ..., No. CV 05-877-PHX-DGC permanently enjoined Submitter from any involvement in any way for filing or assisting in filing of any tax return for any "person or entity other than themselves." Submitter is not a "person" or and "entity". As the self, Submitter is an American Citizen under the Constitution for the United States of America, Not a "U.S. Citizen", etc. as determined above.
2. Administrative Demand For Rescission of SSA association was filed in May 22, 2006, at the local SSA office, evidence of which was sent broadly then filed into the public record in Gila County Arizona, Doc. Id. 2006-008777
3. Multiple Demand For Rescission of SSA association was sent and received by Commissioner by USPO Registered Mail RA 337 238 865 US in September 2009.
4. See 2009 Case: 2:09 CV-01956-DGC Darrell Hill v Premier Healthcare Services: Commissioner of SSA is codefendant. Rescission information is Placed in Docket 1, Exhibits.
5. See 2009 Case 2:09 CV-01957-MHM Darrell Hill v DNA Medical Staffing, LLC: Commissioner of SSA is codefendant. Rescission information is Placed in Docket 1, Exhibits.

1965

USPO RMN: USPO RMN: RE 430 969

DOCH 361061

11/27/2012 01:09 PM Page: 71 of 178
AFF R: \$10.00 J. C. Sloan, McKinley County



2022-011769 MISC Page: 1974 of 2782
09/26/2022 03:35:37 PM Receipt #: 22-5381
Darrell James Hill
Rec Fee: \$20.00 Darrell James Hill
Gila County, Az, Sadie Jo Bingham, Recorder



DOCH 361076

11/27/2012 04:15 PM Page: 72 of 189
AFF R: \$10.00 J. C. Sloan, McKinley County

DOCH 360413

10/02/2012 09:54 PM Page: 4 of 23
AFF R: \$10.00 J. C. Sloan, McKinley County



COPY

6 See 2009 Case 2:09 CV-01958-JAT Darrell Hill v Promise Hospital of Phoenix, Inc.:
Commissioner of SSA is codefendant. Rescission information is Placed in Docket 1, Exhibits.

U.S. Commissioner of SSA Authority

Submitter does Not volunteer His sovereign Constitutional rights to Commissioner. Under the Constitution for the United States of America public servants' actions ignoring Submitter Sovereign's order for rescission of the SSA association are criminal behaviors imposed without right against Submitter's sovereign rights of choice for rescission of and non-association with the SSA.

Commissioner Acquiesced by Inaction upon Sovereign's demand

NO response is acquiescence in the Default of Notice and Demand. Further, No acknowledgment by Commissioner of Submitter's sovereign authority to command rescission of the SSA association is a direct violation of Commissioner's Constitutional obligation to the People of the United States of America. Thus, you are in Dishonor.

Thus, the Commissioner's inaction after Submitter's sovereign demand:
breached Commissioner's sworn Constitutional duty;
failed stated administrative regulations governing Commissioner's actions; and,
violated Submitter's sovereign constitutional rights of choice.

As Commissioner's behavior is plainly un-Constitutional your dysfunction should not be enabled because:

Submitter is a Sovereign private human being

Submitter is a Sovereign Citizen under the Constitution for the United States of America. As such, Submitter prohibits future record keeping of this Submitter, Darrell James, Hill, the private human being, in Commissioner's governmental and/or other associated databases as anything other than a Sovereign Citizen under the Constitution for the United States of America in the Constitutional sense.

Submitter does Not relinquish His Sovereignty to the Commissioner

Because of the Amendment X to the Constitution for the United States of America, the federal United States government has no authority and cannot assume authority over the People.

*"The powers not delegated to the United States by the Constitution, nor prohibited by it to the States, are reserved to the States respectively, or to the people."
[Constitution for the United States of America, Amendment X]*

Sovereignty is a natural right which cannot lawfully be relinquished involuntarily. Any removal of sovereignty must be accomplished voluntarily by the Submitter. Government powers may not reach beyond that which is constitutionally granted. Thus, in order for the "United States" government to vicariously subject Submitter to its law(s) it is necessary for Submitter to relinquish sovereignty to the "United States" government. Since 2006 the SSA association has been INVOLUNTARY, compelled in this instance by the Commissioner's disobedience of Submitter's Sovereign Choice.

Commissioner's strict compliance with Sovereign's rescission order was demanded

Upon receipt of Notice and Demand for the rescission of the SSA association, you were thereby immediately obligated to: 1) correct Submitter's all association, history and "Numident" consistent with Submitter's Non-SSA association determination; 2) provide documentation of (i) your strict compliance with Submitter's rescission order (ii) noting that it was effective as of the date of original order of rescission (May 2006).

Commissioner has Not had Nor has now authority to disobey Submitter's Order of Rescission

Commissioner has not had and still yet has No Constitutional authority, presumed or assumable, to disobey Submitter's order of rescission of the SSA association. **Submitter Sovereign herein**

1966
USPO RMN: USPO RMN: RE 430 96!

DOCH 361051

11/27/2012 01:09 PM Page: 72 of 178
AFF R: \$10.00 J. C. Sloan, McKinley County



2022-011769 MISC Page: 1975 of 2782
09/26/2022 03:35:37 PM Receipt #: 22-9381
Rec Fee: \$30.00 Darrell James Hill
Gila County, Az, Sadie Jo Bingham, Recorder

DOCH 361076

11/27/2012 04:15 PM Page: 73 of 183
AFF R: \$10.00 J. C. Sloan, McKinley County

DOCH 360413
10/02/2012 09:54 AM Page: 5 of 23
AFF R: \$10.00 J. C. Sloan, McKinley County

Darrell James, Hill: 28 Hilltop Court, HC 61, Box 771, Ramah, New Mex.

USPO RMN: USPO RMN: RE 430 969 426 US

decrees you to comply. Submitter does not ask you to function within the confines of the Constitution for the United States of America; your service is only to comply!

Remainder of Intentionally Left Blank

Non Official Copy

2022-011769 MISC Page: 1976 of 2782
09/26/2022 09:35:37 PM Receipt #: 22-9381
Rec Fee: \$30.00 Darrell James Hill
Gila County, Az/ Sadie Jo Bingham, Recorder



1967

USPO RMN: USPO RMN: RE 430 969

DOCH 361061

11/27/2012 01:09 PM Page: 73 of 178
AFF R: \$10.00 J. C. Sloan, McKinley County



DOCH 360413

10/02/2012 09:54 AM Page: 6 of 23
AFF R: \$10.00 J. C. Sloan, McKinley County

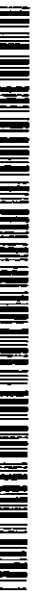

DOCH 361076

11/27/2012 04:15 PM Page: 74 of 183
AFF R: \$10.00 J. C. Sloan, McKinley County



Sovereign Decree

Because the Commissioner dishonors his office before the lawful order from Darrell James, Hill, a sovereign Citizen of the United States of America, by:

- (a)
 - (1) denial of Constitutional compliance to Submitter's order;
 - (2) disobeying rescission order of all SSA association: and, that
- (b) upon all prima facie evidence herein, that Sovereign:
 - (1) made known the order to the United States Commissioner of SSA;
 - (2) noticed, demanded and severally made known the demand to the United States SSA Commissioner's attention so that Commissioner knew or should have known Submitter's Command,

Submitter confirms final compliance with all Constitutional requirements to sever the SSA association. Therefore,

Submitter Sovereign Constitutionally demands:

- 1) immediate elimination of all SSA association; and,
- 2) Commissioner will immediately provide Submitter written compliance with Sovereign's decree, effective to the date of Submitter's order of first filing, to wit, May 2006.

Submitter's Signature, Sovereign Romero-Hill Beverly Jean

NOTARY PUBLIC CERTIFICATION

BEFORE ME, the undersigned authority, a Notary Public, of the County of CIBOLA, Republic of NM (statename), this 31st day of Aug, 2012,

the above signed human being did appear and was identified by (circle one): driver's license /passport /

her and who, upon first being duly sworn and/or affirmed, deposes and says that the foregoing severation is true to the best of his knowledge and belief;

I certify under PENALTY OF PERJURY under the laws of the State of NM that the foregoing paragraph is true and correct.

WITNESS my hand and official seal.

Notary Public Seal

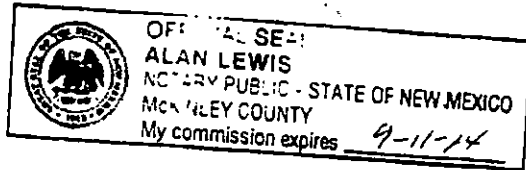

Commission Expires On: 1968
9-11-14

DOCH 361061

USPO RMN: USPO RMN: RE 430 96



2022-0111769 NISC Page: 1977 of 2782
09/26/2022 05:35:37 PM Receipt #: 22-9381
Rec Fee: \$30.00 Darrell James Hill
Gila County, Az, Sadie Jo Bingham, Recorder

DOCH 361076

11/27/2012 04:15 PM Page: 75 of 183
AFF R: \$10.00 J. C. Sloan, McKinley County

DOCH 360413

10/02/2012 09:54 AM Page: 7 of 23
AFF R: \$10.00 J. C. Sloan, McKinley County

AFFIDAVIT

Commissioner John J. Astrue,
c/o President Barack Hussein Obama
Office of Commissioner
Social Security Administration
6401 Security Blvd.
Baltimore, MD 21235

NOTICE OF DEFAULT

You are in Default of Notice and Demand:

This document is the service of Notice of Default upon you Commissioner Astrue, et al., (Commissioner) of the Social Security Administration (SSA) for dishonor upon the demand and all prior notice of same from Beverly Jean, Romero-Hill, (Submitter) to rescind all SSA association as ordered, noticed and demanded.

Beverly Jean, Romero-Hill:

Submitter is an American citizen, a private human being born within the states of the Union of States of America. Submitter is Not a "U.S. Citizen", "person", "individual", "resident", or "etc." other terms of the municipal, administrative law and adhesion contract(s) of the "United States"; Rather, Submitter is a non-volunteer of same.

I, Beverly Jean, Romero-Hill, have settled my belief and place all my trust in God Almighty, the Torah God of Abraham, Isaac and Jacob, YHVH to protect and provide for me forever, now and hereafter. All I have ever needed is manifested through Him. This fact is my experience, understanding, my religious choice of sovereign right, and not alienable under the Constitution for the United States of America. No other grantor, specifically the United States SSA, is necessary or needed as I decided in May of 2006, the of the ORIGINAL Order of Rescission received by the SSA association, et seq. See Since 2006 the Commissioner has ignored Submitter's determination (below).

Since 2006 the Commissioner has ignored Submitter's determination:

1. See Judges Order in United States of America v. Beverly J. Hill, and Darrell J. Hill, individually, No. CV 05-877-PHX-DGC permanently enjoined Submitter from any involvement in any way for filing or assisting in filing of any tax return for any "person or entity other than themselves." Submitter is not a "person" or and "entity". As the self, Submitter is an American Citizen under the Constitution for the United States of America, Not a "U.S. Citizen", etc. as determined above.
2. Administrative Demand For Rescission of SSA association was filed in May 22, 2006, at the local SSA office, evidence of which was sent broadly then filed into the public record in Gila County Arizona, Doc. Id. 2006-008774.

Commissioner of SSA Authority

Submitter does Not volunteer Her sovereign Constitutional rights to Commissioner. Under the Constitution of the United States of America public servants' actions ignoring Submitter Sovereign's order for rescission of the SSA association are criminal behaviors imposed without right against Submitter's sovereign rights of choice for rescission of and non-association with the SSA.

Commissioner Acquiesced by Inaction upon Sovereign's demand

2022-011769 MISC Page: 1978 of 2782
05/25/2022 03:35:37 PM Receipt #: 22-9381
Rep Fee: \$30.00 Darrell James Hill Recorder
Gila County, Az, Sadie Jo Bingham



DOC# 361061

AFFIDAVIT: Notice of Default upon Commission

USPO RMN: USPO RMN: RE 430 969 426 U

11/27/2012 01:09 PM Page: 75 of 178
AFF R: \$10.00 J. C. Sloan, Mckinley County



DOC# 361076

11/27/2012 04:15 PM Page: 76 of 189
AFF R: \$10.00 J. C. Sloan, Mckinley County

10/02/2012 09:54 PM Page: 8 of 23
AFF R: \$10.00 J. C. Sloan, Mckinley County

DOC# 360413



NO response is acquiescence in the Default of Notice and Demand. Further, No acknowledgment by Commissioner of Submitter's sovereign authority to command rescission of the SSA association is a direct violation of Commissioner's Constitutional obligation to the People of the United States of America. Thus, you are in Dishonor.

Thus, the Commissioner's inaction after Submitter's sovereign demand:
Breached Commissioner's sworn Constitutional duty;
Failed stated administrative regulations governing Commissioner's actions; and,
Violated Submitter's sovereign constitutional rights of choice.

As Commissioner's behavior is plainly un-Constitutional your dysfunction should not be enabled because:

Submitter is a Sovereign private human being

Submitter is a Sovereign Citizen under the Constitution for the United States of America. As such, Submitter prohibits future record keeping of this Submitter, Beverly Jean, Romero-Hill, the private human being, in Commissioner's governmental and/or other associated databases as anything other than a Sovereign Citizen under the Constitution for the United States of America in the Constitutional sense.

Submitter does Not relinquish Her Sovereignty to the Commissioner

Because of the Amendment X to the Constitution for the United States of America, the federal United States government has no authority and cannot assume authority over the People.

*"The powers not delegated to the United States by the Constitution, nor prohibited by it to the States, are reserved to the States respectively, or to the people."
[Constitution for the United States of America, Amendment X]*

Sovereignty is a natural right which cannot lawfully be relinquished involuntarily. Any removal of sovereignty must be accomplished voluntarily by the Submitter. Government powers may not reach beyond that which is constitutionally granted. Thus, in order for the "United States" government to vicariously subject Submitter to its law(s) it is necessary for Submitter to relinquish sovereignty to the "United States" government. Since 2006 the SSA association has been INVOLUNTARY, compelled in this instance by the Commissioner's disobedience of Submitter's Sovereign Choice.

Commissioner's strict compliance with Sovereign's rescission order was demanded

Upon receipt of Notice and Demand for the rescission of the SSA association, you were thereby immediately obligated to: 1) correct Submitter's all association, history and "Numident" consistent with Submitter's Non-SSA association determination; 2) provide documentation of (i) your strict compliance with Submitter's rescission order (ii) noting that it was effective as of the date of original order of rescission (May 2006).

Commissioner has Not had Nor has now authority to disobey Submitter's Order of Rescission

Commissioner has not had and still yet has No Constitutional authority, presumed or assumable, to disobey Submitter's order of rescission of the SSA association. **Submitter Sovereign herein decrees you to comply.** Submitter does not ask you to function within the confines of the Constitution for the United States of America; your service is only to comply!

Remainder of Intentionally Left Blank

AFFIDAVIT: Notice of Default upon Commissio

USPO RMN: USPO RMN: RE 430 969 426 U

DOCH 361061

11/27/2012 01:09 PM Page: 76 of 178
AFF R: \$10.00 J. C. Sloan, McKinley County



2022-011769 MISC Page: 1979 of 2782
09/26/2022 03:35:37 PM Receipt #: 22-9381
Rec Fee: \$30.00 Darrell James Hill
Gila County, AZ, Sadie Jo Bingham, Recorder



DOCH 361076

11/27/2012 04:15 PM Page: 77 of 183
AFF R: \$10.00 J. C. Sloan, McKinley County



DOCH 360413

10/02/2012 09:54 AM Page: 9 of 23
AFF R: \$10.00 J. C. Sloan, McKinley County



Sovereign Decree

Because the Commissioner dishonors his office before the lawful order from Beverly Jean, Romero-Hill, a sovereign Citizen of the United States of America, by:

- (a)
 - (1) denial of Constitutional compliance to Submitter's order;
 - (2) disobeying rescission order of all SSA association; and, that

- (b) upon all prima facie evidence herein, that Sovereign:
 - (1) made known the order to the United States Commissioner of SSA;
 - (2) noticed, demanded and severally made known the demand to the United States SSA Commissioner's attention so that Commissioner knew or should have known Submitter's Command.

Submitter confirms final compliance with all Constitutional requirements to sever the SSA association. Therefore,

Submitter Sovereign Constitutionally demands:

- 1) immediate elimination of all SSA association; and,
- (2) Commissioner will immediately provide Submitter written compliance with Sovereign's decree, effective to the date of Submitter's order of first filing, to wit, May 2006.

Beverly Jean Romero Hill
 Submitter's Signature, Sovereign Romero-Hill Beverly Jean

NOTARY PUBLIC CERTIFICATION

BEFORE ME, the undersigned authority, a Notary Public, of the County of IBOLA, Republic of NAI (statename), this 31ST day of May, 2012.

the above signed human being did appear and was identified by (circle one): driver's license /passport / other and who, upon first being duly sworn and/or affirmed, deposes and says that the foregoing asseveration is true to the best of her knowledge and belief.

I certify under PENALTY OF PERJURY under the laws of the state of NAI that the foregoing paragraph is true and correct.

WITNESS my hand and official seal.

Alan Lewis
 Notary Public Seal

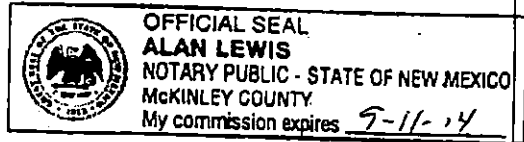

My Commission Expires On: 9-11-14

DOCH 361076
 11/27/2012 04:15 PM Page: 78 of 183
 AFF R: \$10.00 J. C. Sloan, McKinley County

DOCH 360413
 10/02/2012 09:54 AM Page: 10 of 23
 AFF R: \$10.00 J. C. Sloan, McKinley County

Unofficial
1972

RE 430 969 426 US

ate Stamp

To Be Completed By Post Office	Reg. Fee	10.95	
	Handling Charge		Return Receipt
	Postage	1.10	Restricted Delivery
	Received by		

AUG 21 2012

Customer Must Declare Full Value \$ 0 Domestic insurance up to \$25,000 is included based upon the declared value. International Indemnity is limited. (See Reverse).

OFFICIAL USE

To Be Completed By Customer (Please Print) ALL Entries Must Be in Ballpoint or Typed

FROM	Darrell James Hill
	28th Top Court
	Hill Box 771
	Bartow, New Mexico 87321
	President Barack Obama
	The White House
	1600 Pennsylvania Ave
	Washington DC 20500

PS Form 3806, Receipt for Registered Mail Copy 1 - Customer
May 2007 (7530-02-000-9051) (See Information on Reverse)
For domestic delivery information, visit our website at www.usps.com®

2022-011769 MISC Page: 1981 of 2782
09/26/2022 03:35:37 PM Receipt #: 22-9381
Rec Fee: \$30.00 Darrell James Hill
Gila County, Az, Sadie Jo Bingham, Recorder

DOCH 361061

11/27/2012 01:09 PM Page: 78 of 178
AFF R:\$10.00 J. C. Sloan, McKinley County

DOCH 361076

11/27/2012 04:15 PM Page: 79 of 183
AFF R:\$10.00 J. C. Sloan, McKinley County

DOCH 360413

10/02/2012 09:54 AM Page: 11 of 23
AFF R:\$10.00 J. C. Sloan, McKinley County

English Customer Service USPS Mobile

Register / Sign In



Search USPS.com or Track Packages

Quick Tools

Ship a Package

Send Mail

Manage Your Mail

Shop

Business Solutions

Track & Confirm

GET EMAIL UPDATES PRINT DETAILS

YOUR LABEL NUMBER

RE430969426US

SERVICE

First-Class Mail®

STATUS OF YOUR ITEM

Delivered

DATE & TIME

September 13, 2012, 4:23 am

LOCATION

WASHINGTON, DC 20500

FEATURES

Expected Delivery By:
September 4, 2012
Registered Mail™

Arrival at Unit

September 09, 2012, 4:36 am

WASHINGTON, DC 20066

Processed at USPS
Origin Sort Facility

August 31, 2012, 12:21 pm

RAMAH, NM 87321

Acceptance

August 31, 2012, 12:20 pm

RAMAH, NM 87321

Check on Another Item

What's your label (or receipt) number?

Find

LEGAL

- Privacy Policy »
- Terms of Use »
- FOIA »
- No FEAR Act EEO Data »

ON USPS.COM

- Government Services »
- Buy Stamps & Shop »
- Print a Label with Postage »
- Customer Service »
- Site Index »

ON ABOUT.USPS.COM

- About USPS Home »
- Newsroom »
- Mail Service Updates »
- Forms & Publications »
- Careers »

OTHER USPS SITES

- Business Customer Gateway »
- Postal Inspectors »
- Inspector General »
- Postal Explorer »

Copyright © 2012 USPS. All Rights Reserved.

2022-011769 MISC Page: 1982 of 2782

09/26/2022 03:35:37 PM Receipt #: 22-9381
Rec Fee: \$30.00 Darrell James Hill
Gila County, Az, Sadie Jo Bingham, Recorder



DOCH 361061

11/27/2012 01:09 PM Page: 79 of 178
AFF R:\$10.00 J. C. Sloan, McKinley County



DOCH 361076

11/27/2012 04:15 PM Page: 80 of 183
AFF R:\$10.00 J. C. Sloan, McKinley County



DOCH 360413

10/02/2012 09:54 AM Page: 12 of 23
AFF R:\$10.00 J. C. Sloan, McKinley County



Affidavit

ENCLOSURE: B

2022-011769 MISC Page: 1983 of 2782
09/26/2022 03:35:37 PM Receipt #: 22-9381
Rec Fee: \$30.00 Darrell James Hill
Gila County, Az, Sadie Jo Bingham, Recorder



DOCH 361061

11/27/2012 01:09 PM Page: 80 of 178
AFF R: \$10.00 J. C. Sloan, Mokinley County



DOCH 360413

10/02/2012 09:54 AM Page: 13 of 23
AFF R: \$10.00 J. C. Sloan, Mokinley County



DOCH 361076

11/27/2012 04:15 PM Page: 81 of 183
AFF R: \$10.00 J. C. Sloan, Mokinley County



ENCLOSURE: B

Unofficial Copy

Darrell James, Hill; Beverly Jean, Romero-Hill:
28 Hilltop Court, HC 61 Box 771, Ramah, New Mex.

USPO CMN: 7009 2820 0003 8851 6155

Commissioner John J. Astrue,
Office of Commissioner
Social Security Administration
6401 Security Blvd.
Baltimore, MD 21235

RE: Affidavits (2): Notices of Default

Dear Commissioner Astrue;

The Hills, Darrell James (husband), and Beverly Jean, Romero- (wife), wrote and sent to you c/o President Barack Hussein Obama two affidavits by USPS registered mail (RE 430 969 426 US; received September 13, 2012). See "Affidavit: Notice of Default, from husband (4 pages) and Affidavit: Notice of Default from wife (3 pages)", enclosed.

The Affidavits are Constitutional decrees that compel your attention and direct your compliance in achieving the duties in completion of May 2006 orders for the absolute rescissions of all SSA association(s) as noticed, demanded, and defaulted upon by you.

You no doubt may have a busy position, so understand that these People chose to Not be associated with the SSA, et.al, system in 2006 (a fact you have repeatedly ignored). Thus, you have been commanded in the two Constitutional decrees by these People to straightaway i) comply with the severance of all SSA association as ordered and ii) report your compliance of same to each Constitutional Sovereign, Darrell James, Hill (husband); and, Beverly Jean, Romero-Hill (wife).

Commissioner, Your hands-on determination to get these firm orders promptly fulfilled is required; your expedience would be greatly appreciated. (You can execute this order in moments; please do so sir.)

Sincerely:

Darrell James, Hill (husband)
Sovereign Citizen of the United States of America

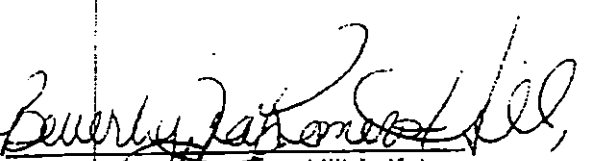
Beverly Jean, Romero-Hill (wife)
Sovereign Citizen of the United States of America

Enclosure: Affidavit: Notice of Default, sent to Commissioner of SSA from husband (4 pages);
Affidavit: Notice of Default, sent to Commissioner of SSA from wife (3 pages)

DOCH 361061

Post BHO Letter to Comm SSA Astrue

11/27/2012 01:09 PM Page: 81 of 178
AFF R:\$10.00 J. C. Sloan, McKinley County



2022-011769 MISC Page: 1984 of 2782

09/26/2022 03:35:37 PM Receipt #: 22-9381
Rec Fee: \$30.00 Darrell James Hill
Gila County, Az, Sadie Jo Bingham, Recorder



DOCH 361076

11/27/2012 04:15 PM Page: 82 of 183
AFF R:\$10.00 J. C. Sloan, McKinley County

DOCH 360413

10/02/2012 09:54 AM Page: 14 of 23
AFF R:\$10.00 J. C. Sloan, McKinley County

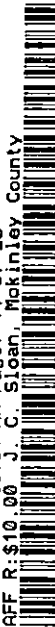

1975
US

COPIES

AFFIDAVIT

Commissioner John J. Astrue,
c/o President Barack Hussein Obama
Office of Commissioner
Social Security Administration
6401 Security Blvd.
Baltimore, MD 21235

NOTICE OF DEFAULT

You are in Default of Notice and Demand:

this document is the service of Notice of Default upon you Commissioner Astrue, et al., (Commissioner) of the Social Security Administration (SSA) for dishonor upon the demand and all prior notices of same from Darrell James, Hill, (Submitter) to rescind all SSA association as ordered, noticed and demanded.

Darrell James, Hill:

Submitter is an American citizen, a private human being born within the states of the Union of States of America. Submitter is Not a "U.S. Citizen", "person", "individual", "resident", "entity", or "etc." other terms of the municipal, administrative law and adhesion contract(s) of the "United States"; Rather, Submitter is a non-volunteer of same.

I, Darrell James, Hill, have settled my belief and place all my trust in God Almighty, the Torah-God of Abraham, Isaac and Jacob, YHVH to protect and provide for me forever, now and hereafter. All I have ever needed is manifested through Him. This fact is my experience, understanding, my religious choice of Sovereign right, and not alienable under the Constitution for the United States of America. No other guarantor, specifically the United States SSA, is necessary or needed as I decided in May of 2006, the date of the ORIGINAL Order of Rescission received by the SSA association, et seq. See Since 2006 the Commissioner has ignored Submitter's determination (below).

Since 2006 the Commissioner has ignored Submitter's determination:

1. See Judges Order in United States of America v. Beverly J. Hill, and Darrell J. Hill, individually, et al., No. CV-05-877-PHX-DGC permanently enjoined Submitter from any involvement in any way for filing or assisting in filing of any tax return for any "person or entity other than themselves." Submitter is not a "person" or and "entity". As the self, Submitter is an American Citizen under the Constitution for the United States of America, Not a "U.S. Citizen", etc. as determined above.
2. Administrative Demand For Rescission of SSA association was filed in May 22, 2006, at the local SSA office, evidence of which was sent broadly then filed into the public record in Gila County Arizona, Doc. Id. 2006-008777
3. Multiple Demand For Rescission of SSA association was sent and received by Commissioner by USPO Registered Mail RA 337 238 865 US in September 2009.
4. See 2009 Case: 2:09 CV-01956-DGC Darrell Hill v Premier Healthcare Services: Commissioner of SSA is codefendant. Rescission information is Placed in Docket 1, Exhibits.
5. See 2009 Case 2:09 CV-01957-MHM Darrell Hill v DNA Medical Staffing, LLC: Commissioner of SSA is codefendant. Rescission information is Placed in Docket 1, Exhibits.

DOCH 361061

USPO RMN: USPO RMN: RE 430 969 426 US

11/27/2012 01:09 PM Page: 82 of 178
AFF R: \$10.00 J. C. Sloan, Mckinley County



2022-0111769 MISC Page: 1985 of 2782

09/26/2022 03:35:37 PM Receipt #: 22-9381
Darrell James Hill, Recorder
Gila County, Az, Sadie Jo Birmingham



DOCH 361076

11/27/2012 04:15 PM Page: 83 of 183
AFF R: \$10.00 J. C. Sloan, Mckinley County



DOCH 360413

10/02/2012 09:54 AM Page: 15 of 23
AFF R: \$10.00 J. C. Sloan, Mckinley County

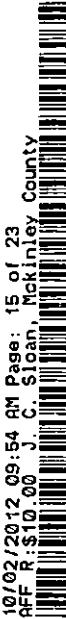

Darrell James, Hill: 28 Hilltop Court, HC 61, Box 771, Ramah, New Mex.

USPO RMN: USPO RMN: RE 430 969 426 US

6 See 2009 Case:2:09 CV-01958-JAT Darrell Hill v Promise Hospital of Phoenix, Inc.:
Commissioner of SSA is codefendant. Rescission information is Placed in Docket 1, Exhibits

U.S. Commissioner of SSA Authority

Submitter does Not volunteer His sovereign Constitutional rights to Commissioner. Under the Constitution for the United States of America public servants' actions ignoring Submitter Sovereign's order for rescission of the SSA association are criminal behaviors imposed without right against Submitter's sovereign rights of choice for rescission of and non-association with the SSA.

Commissioner Acquiesced by Inaction upon Sovereign's demand

NO response is acquiescence in the Default of Notice and Demand. Further, No acknowledgment by Commissioner of Submitter's sovereign authority to command rescission of the SSA association is a direct violation of Commissioner's Constitutional obligation to the People of the United States of America. Thus, you are in Dishonor.

Thus, the Commissioner's inaction after Submitter's sovereign demand:
Breached Commissioner's sworn Constitutional duty;
Failed stated administrative regulations governing Commissioner's actions; and,
Violated Submitter's sovereign constitutional rights of choice.

As Commissioner's behavior is plainly un-Constitutional your dysfunction should not be enabled because:

Submitter is a Sovereign private human being

Submitter is a Sovereign Citizen under the Constitution for the United States of America. As such, Submitter prohibits future record keeping of this Submitter, Darrell James, Hill, the private human being, in Commissioner's governmental and/or other associated databases as anything other than a Sovereign Citizen under the Constitution for the United States of America in the Constitutional sense.

Submitter does Not relinquish His Sovereignty to the Commissioner

Because of the Amendment X to the Constitution for the United States of America, the federal United States government has no authority and cannot assume authority over the People.

*"The powers not delegated to the United States by the Constitution, nor prohibited by it to the States, are reserved to the States respectively, or to the people."
[Constitution for the United States of America, Amendment X]*

Sovereignty is a natural right which cannot lawfully be relinquished involuntarily. Any removal of sovereignty must be accomplished voluntarily by the Submitter: Government powers may not reach beyond that which is constitutionally granted. Thus, in order for the "United States" government to vicariously subject Submitter to its law(s) it is necessary for Submitter to relinquish sovereignty to the "United States" government. Since 2006 the SSA association has been INVOLUNTARY, compelled in this instance by the Commissioner's disobedience of Submitter's Sovereign Choice.

Commissioner's strict compliance with Sovereign's rescission order was demanded

Upon receipt of Notice and Demand for the rescission of the SSA association, you were thereby immediately obligated to: 1) correct Submitter's all association, history and "Numident" consistent with Submitter's Non-SSA association determination; 2) provide documentation of (i) your strict compliance with Submitter's rescission order (ii) noting that it was effective as of the date of original order of rescission (May 2006).

Commissioner has Not had Nor has now authority to disobey Submitter's Order of Rescission

Commissioner has not had and still yet has No Constitutional authority, presumed or assumable, to disobey Submitter's order of rescission of the SSA association. **Submitter Sovereign herein**

DOCH 361061

USPO RMN: USPO RMN: RE 430 965

11/27/2012 01:09 PM Page: 83 of 178
AFF R:\$10.00 J. C. Sloan, McKinley County



2022-011769 MISC Page: 1986 of 2782

09/26/2022 03:35:37 PM Receipt # 22-9381
Darrell James Hill
Rec Fee: \$30.00
Gila County, AZ, Sadie Jo Bingham, Recorder



DOCH 361076

11/27/2012 04:15 PM Page: 84 of 183
AFF R:\$10.00 J. C. Sloan, McKinley County

DOCH 360413

10/02/2012 09:54 AM Page: 16 of 23
AFF R:\$10.00 J. C. Sloan, McKinley County



Darrell James, Hill: 28 Hilltop Court, HC 61, Box 771, Ramah, New Mex.

USPO RMN: USPO RMN: RE 430 969 426 US

decrees you to comply. Submitter does not ask you to function within the confines of the Constitution for the United States of America; your service is only to comply!

Remainder of Intentionally Left Blank

2022-011769 MISC Page: 1987 of 2782
09/28/2022 03:35:37 PM Receipt #: 22-9381
Rec Fee: \$30.00 Darrell James Hill
Gila County, Az, Sadie Jo Bingham, Recorder



Unofficial Copy

USPO RMN: USPO RMN: RE 430 969 426 US

DOCH 361061

11/27/2012 01:09 PM Page: 84 of 178
AFF R: \$10.00 J. C. Sloan, McKinley County



DOCH 360413

10/02/2012 09:54 AM Page: 17 of 23
AFF R: \$10.00 J. C. Sloan, McKinley County



DOCH 361076

11/27/2012 04:15 PM Page: 85 of 183
AFF R: \$10.00 J. C. Sloan, McKinley County



Sovereign Decree

Because the Commissioner dishonors his office before the lawful order from Darrell James, Hill, a sovereign Citizen of the United States of America. by

a:

- (1) denial of Constitutional compliance to Submitter's order.
- (2) disobeying rescission order of all SSA association and, that

(b) upon all prima facie evidence herein that Sovereign

- (1) made known the order to the United States Commissioner of SSA.
- (2) noticed, demanded and severally made known the demand to the United States SSA Commissioner's attention so that Commissioner knew or should have known Submitter's Command.

Submitter confirms final compliance with all Constitutional requirements to sever the SSA association. Therefore

Submitter Sovereign Constitutionally demands:

- 1) immediate elimination of all SSA association; and,
- 2) Commissioner will immediately provide Submitter written compliance with Sovereign's decree, effective to the date of Submitter's order of first filing, to wit, May 2006.

Submitter's Signature, Sovereign Romero-Hill: Beverly Jean

NOTARY PUBLIC CERTIFICATION

BEFORE ME, the undersigned authority, a Notary Public, of the County of CIBOLA, Republic

of NM (statename), this 3rd day of Aug, 2012,

the above signed human being did appear and was identified by (circle one): driver's license / passport /

other and who, upon first being duly sworn and/or affirmed, deposes and says that the foregoing

asseveration is true to the best of his knowledge and belief

I certify under PENALTY OF PERJURY under the laws of the State of NM that the foregoing paragraph is true and correct.

WITNESS my hand and official seal.

Alan Lewis Seal
Notary Public

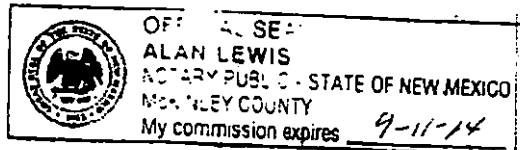

DOC# 361076

11/27/2012 04:15 PM Page: 86 of 183
FF R: \$10.00 J. C. Sloan, McKinley County

DOC# 360413

11/27/2012 09:54 AM Page: 18 of 23
FF R: \$10.00 J. C. Sloan, McKinley County

AFFIDAVIT

Commissioner John J. Astrue,
c/o President Barack Hussein Obama
Office of Commissioner
Social Security Administration
6401 Security Blvd.
Baltimore, MD 21235

NOTICE OF DEFAULT

You are in Default of Notice and Demand:

This document is the service of Notice of Default upon you Commissioner Astrue, et al., (Commissioner) of the Social Security Administration (SSA) for dishonor upon the demand and all prior notice of same from Beverly Jean, Romero-Hill, (Submitter) to rescind all SSA association as ordered, noticed and demanded.

Beverly Jean, Romero-Hill:

Submitter is an American citizen, a private human being born within the states of the Union of States of America. Submitter is Not a "U.S. Citizen", "person", "individual", "resident", or "etc." other terms of the municipal, administrative law and adhesion contract(s) of the "United States"; Rather, Submitter is a non-volunteer of same.

I, Beverly Jean, Romero-Hill, have settled my belief and place all my trust in God Almighty, the Torah God of Abraham, Isaac and Jacob, YHVH to protect and provide for me forever, now and hereafter. All I have ever needed is manifested through Him. This fact is my experience, understanding, my religious choice of Sovereign right, and not alienable under the Constitution for the United States of America. No other guarantor, specifically the United States SSA, is necessary or needed as I decided in May of 2006, the date of the ORIGINAL Order of Rescission received by the SSA association, et seq. See Since 2006 the Commissioner has ignored Submitter's determination (below).

Since 2006 the Commissioner has ignored Submitter's determination:

1. See Judges Order in United States of America v. Beverly J. Hill, and Darrell J. Hill, individually, No. CV-05-877-PHX-DGC permanently enjoined Submitter from any involvement in any way for filing or assisting in filing of any tax return for any "person or entity other than themselves." Submitter is not a "person" or and "entity". As the self, Submitter is an American Citizen under the Constitution for the United States of America. Not a "U.S. Citizen", etc. as determined above.
2. Administrative Demand For Rescission of SSA association was filed in May 22, 2006, at the local SSA office, evidence of which was sent broadly then filed into the public record in Gila County Arizona, Doc. Id. 2006-008774.

U.S. Commissioner of SSA Authority

Submitter does Not volunteer Her sovereign Constitutional rights to Commissioner. Under the Constitution for the United States of America public servants' actions ignoring Submitter Sovereign's order for rescission of the SSA association are criminal behaviors imposed without right against Submitter's sovereign rights of choice for rescission of and non-association with the SSA.

Commissioner Acquiesced by Inaction upon Sovereign's demand

2022-011769 MISC Page: 1989 of 2782
09/26/2022 03:35:37 PM Receipt #: 22-9381
Rec Fee: \$30.00 Darrell James Hill
Gila County, Az, Sadie Jo Bingham, Recorder



(At) DOCH 361061

11/27/2012 01:09 PM Page: 86 of 178
AFF R: \$10.00 J. C. Sloan, Mckinley County



DOCH 361076

11/27/2012 04:15 PM Page: 87 of 183
AFF R: \$10.00 J. C. Sloan, Mckinley County



DOCH 360413

10/02/2012 09:54 AM Page: 19 of 23
AFF R: \$10.00 J. C. Sloan, Mckinley County



NO response is acquiescence in the Default of Notice and Demand. Further, No acknowledgment by Commissioner of Submitter's sovereign authority to command rescission of the SSA association is a direct violation of Commissioner's Constitutional obligation to the People of the United States of America. Thus, you are in Dishonor.

Thus, the Commissioner's inaction after Submitter's sovereign demand:
Breached Commissioner's sworn Constitutional duty;
Failed stated administrative regulations governing Commissioner's actions; and,
Violated Submitter's sovereign constitutional rights of choice.

As Commissioner's behavior is plainly un-Constitutional your dysfunction should not be enabled because:

Submitter is a Sovereign private human being

Submitter is a Sovereign Citizen under the Constitution for the United States of America. As such, Submitter prohibits future record keeping of this Submitter, Beverly Jean, Romero-Hill, the private human being, in Commissioner's governmental and/or other associated databases as anything other than a Sovereign Citizen under the Constitution for the United States of America in the Constitutional sense.

Submitter does Not relinquish Her Sovereignty to the Commissioner

Because of the Amendment X to the Constitution for the United States of America, the federal United States government has no authority and cannot assume authority over the People.

*"The powers not delegated to the United States by the Constitution, nor prohibited by it to the States, are reserved to the States respectively, or to the people."
[Constitution for the United States of America, Amendment X]*

Sovereignty is a natural right which cannot lawfully be relinquished involuntarily. Any removal of sovereignty must be accomplished voluntarily by the Submitter: Government powers may not reach beyond that which is constitutionally granted. Thus, in order for the "United States" government to vicariously subject Submitter to its law(s) it is necessary for Submitter to relinquish sovereignty to the "United States" government. Since 2006 the SSA association has been INVOLUNTARY, compelled in this instance by the Commissioner's disobedience of Submitter's Sovereign Choice.

Commissioner's strict compliance with Sovereign's rescission order was demanded

Upon receipt of Notice and Demand for the rescission of the SSA association, you were thereby immediately obligated to: 1) correct Submitter's all association, history and "Numident" consistent with Submitter's Non-SSA association determination; 2) provide documentation of (i) your strict compliance with Submitter's rescission order (ii) noting that it was effective as of the date of original order of rescission (May 2006).

Commissioner has Not had Nor has now authority to disobey Submitter's Order of Rescission

Commissioner has not had and still yet has No Constitutional authority, presumed or assumable, to disobey Submitter's order of rescission of the SSA association. **Submitter Sovereign herein decrees you to comply.** Submitter does not ask you to function within the confines of the Constitution for the United States of America; your service is only to comply!

Remainder of Intentionally Left Blank

DOCH 361076

11/27/2012 04:15 PM Page: 88 of 183
AFF R: \$10.00 J. C. Sloan, McKinley County

DOCH 360413

10/02/2012 09:54 AM Page: 20 of 23
AFF R: \$10.00 J. C. Sloan, McKinley County



1981

Sovereign Decree

Because the Commissioner dishonors his office before the lawful order from Beverly Jean, Romero-Hill a sovereign Citizen of the United States of America by

- (1) denial of Constitutional compliance to Submitter's order
- (2) disobeying rescission order of all SSA association and that

- (b) upon all prima facie evidence herein that Sovereign
 - (1) made known the order to the United States Commissioner of SSA.
 - (2) noticed, demanded and severally made known the demand to the United States SSA Commissioner's attention so that Commissioner knew or should have known Submitter's Command

Submitter confirms final compliance with all Constitutional requirements to sever the SSA association. Therefore,

Submitter Sovereign Constitutionally demands:

- 1) immediate elimination of all SSA association; and,
- 2) Commissioner will immediately provide Submitter written compliance with Sovereign's decree, effective to the date of Submitter's order of first filing, to wit, May 2006.

Beverly Jean Romero-Hill
 Submitter's Signature, Sovereign Romero-Hill Beverly Jean

NOTARY PUBLIC CERTIFICATION

BEFORE ME, the undersigned authority, a Notary Public, of the County of Brewer, Republic

MO (statename) this 31ST day of Aug, 2012,

the above signed human being did appear and was identified by (circle one): driver's license /passport /

her and who, upon first being duly sworn and/or affirmed, deposes and says that the foregoing

severation is true to the best of her knowledge and belief.

I certify under PENALTY OF PERJURY under the laws of the state of MO that the foregoing paragraph is true and correct.

WITNESS my hand and official seal.

Alan Lewis
 _____ Seal
 Notary Public

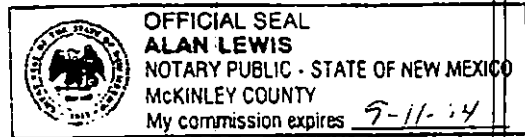

My Commission Expires On: 9-11-14



2022-011769 MISC Page: 1991 of 2782

09/26/2022 03:35:37 PM Receipt # 22-9381
Darrell James Hill, Recorder
Gila County, AZ, Sadie Jo Birmingham



DOCH 361076

11/27/2012 04:15 PM Page: 89 of 183
AFF R:\$10.00 J. C. Sloan, McKinley County



DOCH 360413

10/02/2012 09:54 AM Page: 21 of 23
AFF R:\$10.00 J. C. Sloan, McKinley County



DOCH 361076

11/27/2012 04:15 PM Page: 90 of 183
AFF R: \$10.00 J. C. Sloan, McKinley County



Item No. 2

Item 2:

Encl. A

Art. 1

Aug. 2012

Notice of Default upon Commissioner of SSA

Mailing and Acceptance Information

Commissioner

John Astrue c/o President Barack Obama

USPO CMN: 7009 2820 0003 8851 6155

Accepted: Sept. 21, 2012

(McKinley County, New Mexico, DOC# 360413)

2022-011769 MISC Page: 1992 of 2782

09/26/2022 03:35:37 PM Receipt #: 22-9381

Rec Fee: \$30.00 Darrell James Hill

Gila County, Az, Sadie Jo Bingham, Recorder



DOCH 361061

11/27/2012 01:09 PM Page: 89 of 178

AFF R: \$10.00 J. C. Sloan, McKinley County



U.S. Postal Service
CERTIFIED MAIL RECEIPT
 (Domestic Mail Only; No Insurance Coverage Provided)

For delivery information visit our website at www.usps.com

7009 2820 0003 8851 6155

Postage	\$ 1.30
Domestic Fee	2.95
Return Receipt Fee (Endorsement Required)	2.35
Restricted Delivery Fee (Endorsement Required)	
Total Postage & Fees	\$ 6.60

Postmark Date: 10/10/12

Sent To: Commissioner John J. Astrue, Office of Commissioner Social Security Administration, 6401 Security Blvd, Baltimore, MD 21235

PS Form 3800, August 2006 See Reverse for Instructions

DOCH 361076

11/27/2012 04:15 PM Page: 91 of 183
 AFF R:\$10.00 J. C. Sloan, McKinley County



SENDER INFORMATION

- Complete items 1, 2, and 3. Also complete item 4 if Restricted Delivery is desired.
- Print your name and address on the reverse so that we can return the card to you.
- Attach this card to the back of the mailpiece, or on the front if space permits.

1. Article Addressed to:

Commissioner John J. Astrue,
 Office of Commissioner
 Social Security Administration
 6401 Security Blvd.
 Baltimore, MD 21235

A. Signature

X SOCIAL SECURITY ADMINIST

Addressee

B. Received by (Printed Name)

E. Date of Delivery

D. Is delivery address different from item 1? Yes
 If YES, enter delivery address below: No

SEP 21 2012

3. Service Type

- Certified Mail Express Mail
- Registered Return Receipt for Merchandise
- Insured Mail C.O.D.

4. Restricted Delivery? (Extra Fee) Yes

2. Article Number

(Transfer from service label)

7009 2820 0003 8851 6155

PS Form 3811, February 2004

Domestic Return Receipt

10252-02-000

UNITED STATES POSTAL SERVICE



First-Class Mail
 Postage & Fees Paid
 USPS
 Permit No. G-10

• Sender. Please print your name, address, and ZIP+4 in this box •

Hill Darrell James
 Romero-Hill Beverly Jean
 28 Hilltop Court
 HC 61, Box 771
 Ramah, N. Mex. 87321

DOCH 361061

11/27/2012 01:09 PM Page: 90 of 178
 AFF R:\$10.00 J. C. Sloan, McKinley County



DOCH 360413

10/02/2012 09:54 AM Page: 22 of 23
 AFF R:\$10.00 J. C. Sloan, McKinley County



2022-011769 MISC Page: 1993 of 2782

09/26/2022 03:35:37 PM Receipt #: 22-9381
 Rec Fee: \$30.00 Darrell James Hill
 Gila County, Az, Sadie Jo Bingham, Recorder



English Customer Service USPS Mobile

Register / Sign In



Search USPS.com or Track Packages

Quick Tools

Ship a Package

Send Mail

Manage Your Mail

Shop

Business Solutions

Track & Confirm

GET EMAIL UPDATES PRINT DETAILS

YOUR LABEL NUMBER

70092820000388516155

SERVICE

First-Class Mail®

STATUS OF YOUR ITEM

Delivered

DATE & TIME

September 21, 2012, 8:02 am

LOCATION

BALTIMORE, MD 21241

FEATURES

Expected Delivery By:
September 21, 2012
Certified Mail™

Notice Left (No Authorized Recipient Available)

September 21, 2012, 8:02 am

BALTIMORE, MD 21235

Arrival at Unit

September 21, 2012, 7:11 am

BALTIMORE, MD 21203

Acceptance

September 18, 2012, 11:16 am

RAMAH, NM 87321

Check on Another Item

What's your label (or receipt) number?

Find

LEGAL

- Privacy Policy »
- Terms of Use »
- FOIA »
- No FEAR Act EEO Data »

ON USPS.COM

- Government Services »
- Buy Stamps & Shop »
- Print a Label with Postage »
- Customer Service »
- Site Index »

ON ABOUT.USPS.COM

- About USPS Home »
- Newsroom »
- Mail Service Updates »
- Forms & Publications »
- Careers »

OTHER USPS SITES

- Business Customer Gateway »
- Postal Inspectors »
- Inspector General »
- Postal Explorer »

Copyright© 2012 USPS. All Rights Reserved.

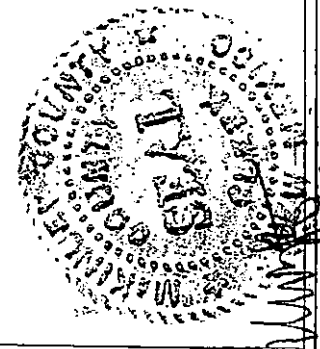

2022-011769 MISC Page: 1994 of 2782

09/26/2022 03:35:37 PM Receipt #: 22-9381
Rec Fee: \$30.00 Darrell James Hill
Gila County, Az, Sadie Jo Bingham, Recorder



DOCH 361061

11/27/2012 01:09 PM Page: 91 of 178
AFF R:\$10.00 J. C. Sloan, Mckinley County



DOCH 361076

11/27/2012 04:15 PM Page: 92 of 183
AFF R:\$10.00 J. C. Sloan, Mckinley County



DOCH 360413

10/02/2012 09:54 AM Page: 23 of 23
AFF R:\$10.00 J. C. Sloan, Mckinley County



Unofficial

1985

DOC# 361076

11/27/2012 04:15 PM Page: 93 of 183
AFF R:\$10.00 J. C. Sloan, Mckinley County



Item No. 2

Item 2:
Encl. B

Reiteration of Position and Status re: SSA Rescission
Mailing and Acceptance Information
Class Attorney Mark Samson, Phoenix, Arizona
USPO CMN: 7010 1060 0001 7518 9147
Accepted: Oct. 9, 2012
Mailing and Acceptance Information

2022-011769 MISC Page: 1995 of 2782
09/26/2022 03:35:37 PM Receipt #: 22-9381
Rec Fee: \$30.00 Darrell James Hill
Gila County, Az, Sadie Jo Bingham, Recorder



DOC# 361061

11/27/2012 01:09 PM Page: 92 of 178
AFF R:\$10.00 J. C. Sloan, Mckinley County



Unofficial Copy

1986



Register / Sign In

Search USPS.com or Track Pa

Quick Tools

Ship a Package

Send Mail

Manage Your Mail

Shop

Business Solutions

Track & Confirm

GET EMAIL UPDATES PRINT DETAILS

YOUR LABEL NUMBER	SERVICE	STATUS OF YOUR ITEM	DATE & TIME	LOCATION	FEATURES
70101060000175189147	First-Class Mail®	Delivered	October 09, 2012, 3:12 pm	PHOENIX, AZ 85012	Expected Delivery By: October 9, 2012 Certified Mail™
		Notice Left (Business Closed)	October 06, 2012, 9:37 am	PHOENIX, AZ 85012	
		Arrival at Unit	October 06, 2012, 4:06 am	PHOENIX, AZ 85013	
		Acceptance	October 04, 2012, 2:15	RAMAH, NM 87321	

Check on Another Item

What's your label (or receipt) number?

Find

LEGAL

- Privacy Policy
- Terms of Use
- FOIA
- No FEAR Act EEO Data

ON USPS.COM

- Government Services
- Buy Stamps & Shop
- Print a Label with Postage
- Customer Service
- Site Index

Copyright© 2012 USPS. All Rights Reserved.

U.S. Postal Service™ CERTIFIED MAIL™ RECEIPT

(Domestic Mail Only; No Insurance Coverage Provided)

For delivery information visit our website at www.usps.com

OFFICIAL USE

Postage	\$ 1.70
Certified Fee	2.95
Return Receipt Fee (Endorsement Required)	2.35
Restricted Delivery Fee (Endorsement Required)	
Total Postage & Fees	\$ 7.00

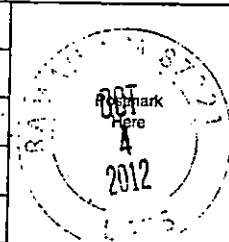

Sent To: **Mark Samson**
Keller Rohrback, P.L.C.
 3101 North Central Ave Suite 1400
 Phoenix, AZ 85012

PS Form 3800, August 2006 See Reverse for Instructions

DOCH 361076

11/27/2012 04:15 PM Page: 94 of 183
AFF R:\$10.00 J. C. Sloan, McKinley County

2022-011769 MISC Page: 1996 of 2782
 09/26/2022 03:35:37 PM Receipt #: 22-9381
 Rec Fee: \$30.00 Darrell James Hill
 Gila County, Az, Sadie Jo Bingham, Recorder

DOCH 361061
 11/27/2012 01:09 PM Page: 93 of 178
 AFF R:\$10.00 J. C. Sloan, McKinley County

DOCH 361076

11/27/2012 04:15 PM Page: 95 of 183
AFF R: \$10.00 J. C. Sloan, McKinley County



Item No. 3

Item 3:
Oct. 2012

Status Statements (of Class Member and Spouse) to Commissioner of SSA
c/o President Barack Obama

Affidavit of Citizenship, Domicile, and Tax Status (from each spouse), October 2012

John Astrue, Commissioner, SSA c/o President Barack Obama

USPO RMN: RE 430 969 752 US

Accepted: October 19, 2012

Answer Commissioner's request: TEH2A/ 129010X8: Oct. 1, 2012

Filings by husband and wife.

2022-011769 MISC Page: 1997 of 2782
09/26/2022 03:35:37 PM Receipt #: 22-9381
Rec Fee: \$30.00 Darrell James Hill
Gila County, Az, Sadie Jo Bingham, Recorder



DOCH 361061

11/27/2012 01:09 PM Page: 94 of 178
AFF R: \$10.00 J. C. Sloan, McKinley County



Darrell James, Hill, and Beverly Jean, Romero-Hill
28 Hilltop Court, HC 61, Box 771, Ramah, New Mex.

USPO RMN: RE 430 969 752 US

President Barack Hussein Obama
The White House
1600 Pennsylvania Avenue NW
Washington, DC. 20500

Re: 2ND -Commissioner Astrue c/o President Barack H. Obama: Response Letter;
Affidavits (attached)

Dear Mr. President:

AGAIN, we write: Our name is Hill: Darrell James, Hill, husband, and wife Beverly Jean Romero- Hill. We are American Citizens born in states of the union of States of America. We trust in the God of Abraham, Isaac and Jacob; keep the commandments of the Most High God YHVH sacred, and have the testimony of His Son Yushuah, the Almighty God.

This is our **SECOND USPO Registered Mail** letter to Commissioner Astrue c/o You, continued upon the same matter: See **USPO RMN RE430969426US**.

The Commissioner's Response Letter Request

Clearly, the Commissioner's letter content is simply misguided (See a copy of his "TEH2A, 129010X8" LETTER enclosed, 1 page), as we are plainly not the "persons" and etc. other statutory terms whereupon the Commissioner's response presumes to validate his position. The enclosed Affidavits resolve this actual or feigned ignorance (see the AFFIDAVIT OF CITIZENSHIP, DOMICILE, AND TAX STATUS, (2) enclosed).

What We want you Barack to do - in finality

Commit the letter to the addressee; and, this time **ORDER** the Commissioner to **WITH NO FURTHER DELAY** obey our decrees and demands under obligation to the Constitution for **United States of America**. NO excuses or other ignorant positions; get this done!

Sincerely;

[Signature]
10/11/2012

Darrell James, Hill (husband)
Sovereign Citizen of the United States of America

[Signature]
Beverly Jean, Romero-Hill (wife)
Sovereign Citizen of the United States of America

Enclosure: "TEH2A, 129010X8" LETTER from Commissioner SSA (1 page)
AFFIDAVIT OF CITIZENSHIP, DOMICILE, AND TAX STATUS, to Commissioner of SSA from husband (18 pages)
AFFIDAVIT OF CITIZENSHIP, DOMICILE, AND TAX STATUS, to Commissioner of SSA from wife (18 pages)

Letter to President Barack H. Obama (

USPO RMN: RE 430 969 752 US

DOCH 361061

11/27/2012 01:09 PM Page: 95 of 178
AFF R:\$10.00 J. C. Sloan, Mekinley County



2022-011769 MISC Page: 1998 of 2782
09/26/2022 03:35:37 PM Receipt #: 22-9381
Rec Fee: \$30.00 Darrell James Hill
Gila County, Az, Sadie Jo Bingham, Recorder



DOCH 361076

11/27/2012 04:15 PM Page: 96 of 183
AFF R:\$10.00 J. C. Sloan, Mekinley County



1989

Unofficial Copy

dbb

DOC# 361076

11/27/2012 04:15 PM Page: 97 of 183
AFF R:\$10.00 J. C. Sloan, McKinley County



Item No. 3

Item 3:
Encl. 1

Commissioner's TEH2A/ 129010X8: Oct. 1, 2012

Hill Darrell James

and

Romero-Hill Beverly Jean

Oct. 1, 2012

(document date)

2022-011769 MISC Page: 1999 of 2782

09/26/2022 03:35:37 PM Receipt #: 22-9381
Rec Fee: \$30.00 Darrell James Hill
Gila County, Az, Sadie Jo Bingham, Recorder



DOC# 361061

11/27/2012 01:09 PM Page: 96 of 178
AFF R:\$10.00 J. C. Sloan, McKinley County





SOCIAL SECURITY

TEH2A
129010X8

October 1, 2012

Mr. and Mrs. Darrell J. Hill
28 Hilltop Court
Ramah, New Mexico 87321

COPY

DOCH 361076

11/27/2012 04:15 PM Page: 98 of 183
AFF R:\$10.00 J. C. Sloan, McKinley County



Dear Mr. and Mrs. Hill:

Thank you for your September 18, 2012 letter about the Social Security program. People cannot voluntarily end their participation in the program. Under Federal law, it is mandatory that everyone pay Social Security taxes, regardless of the citizenship or place of residence of either the employer or the employee. Unless specifically exempt by law, everyone working in the United States must pay Social Security taxes.

Similarly, people cannot withdraw the Social Security taxes that they have already paid. We do not place Social Security taxes paid by employees and employers in individual accounts but use them to pay benefits to workers and their families today. A person must voluntarily file an application to receive these benefits.

The law (Section 205 of the Social Security Act) requires the Social Security Administration to maintain records of workers' earnings and to establish any other records necessary to carry out our responsibilities under the Social Security Act. Since many people have the same name, or change their name, we needed a reliable and permanent system to distinguish one individual from another in our records. Congress established the Social Security number system to meet that need.

The Supreme Court has upheld the constitutionality of the Social Security system, as established by the Social Security Act, and mandatory individual participation. We will not respond further to your correspondence about voluntary participation in the Social Security program or the withdrawal of Social Security taxes.

The Internal Revenue Service has jurisdiction over the issue of liability for Social Security taxes; the United States Citizenship and Immigration Services has jurisdiction over the issue of citizenship. If you have questions about those subjects, you should contact one of those offices.

Social Security Administration

2022-011769 MISC Page: 2000 of 2782
09/26/2022 03:35:37 PM Receipt #: 22-9381
Rec Fee: \$30.00 Darrell James Hill
Gila County, Az, Sadie Jo Bingham, Recorder



DOCH 361061

11/27/2012 01:09 PM Page: 97 of 178
AFF R:\$10.00 J. C. Sloan, McKinley County



IN

Unofficial Copy

DOCH 361076

11/27/2012 04:15 PM Page: 99 of 183
AFF R: \$10.00 J. C. Sloan, McKinley County



Item No. 3

Item 3: Encl. 2

Oct. 2012

Affidavit: Status Statement

Affidavit of Citizenship, Domicile, and Tax Status (from each spouse), October 2012

John Astrue, Commissioner, SSA c/o President Barack Obama

USPO RMN: RE 430 969 752 US

Accepted: October 19, 2012

1992

2022-011769 MISC Page: 2001 of 2782
09/26/2022 03:35:37 PM Receipt #: 22-9381
Rec Fee: \$30.00 Darrell James Hill
Gila County, Az, Sadie Jo Bingham, Recorder



DOCH 361061

11/27/2012 01:09 PM Page: 98 of 178
AFF R: \$10.00 J. C. Sloan, McKinley County



AFFIDAVIT OF CITIZENSHIP, DOMICILE, AND TAX STATUS

SECTION 1: SUBMITTER INFORMATION

1. Name	Darrell James, Hill		
2. Mailing Address (NOT a domicile)	28 Hilltop Court, HC 62 Box 771		
3. City	Ramah	4. State	New Mexico
5. Zip	[87321]	6. Country	The United States of America
7. Phone	505.783.2499	8. Email	djhill4yah@yahoo.com
9. Date of Birth:	1958 November 20	10. Place of Birth:	Ohio
11. citizenship:	Nonresident alien NON-individual: See explanation (following)	12. DOMICILE:	Transient Foreigner: See explanation (following)

11. CITIZENSHIP

I am a Constitutional but not statutory "Citizen": "national" but not "citizen" under federal law pursuant to 8 U.S.C. §1101(a)(21) and 8 U.S.C. §1452. Born in state of the Union and a "nonresident" (per 26 U.S.C. 7701(b)(1)(B)) but NOT an "alien" (per 26 U.S.C. 7701(b) (1)(A) or "Individual" (Per 26 CFR §1.441-1(c)(3)); "Stateless Person" as per Newman-Green v. Alfonso Larrain, 490 U.S. 826 (1989); *Constitutional* diversity of citizenship pursuant to U.S. Const. Art. III, Section 2, but NOT *statutory* diversity pursuant to 28 U.S.C. §1332. Rebut the preceding if you disagree within 30 days or you stipulate it as truth.

12. DOMICILE:

I have chosen my domicile as Not within any government on earth.

I choose not to politically associate with any group or government on earth for my protection. The First Amendment to the Constitution protects my right of freedom from compelled association. I am a "transient foreigner" but not an "inhabitant" of the place where I live.

Choice of my domicile and becoming a taxpayer require my consent. Rebut the proceeding within 30 days if you disagree or forever be stopped from later challenging it.

13. FEDERAL FRANCHISES

13.1. Submitter is not subject to the Internal Revenue Code Subtitle A "trade or business" franchise/excise tax. Also called "income tax": "trade or business" is defined in 26 U.S.C. §7701(a)(26) as "function of a public office" in the government. Those not engaged are a "foreign estate" pursuant to 26 U.S.C. §7701(a)(31).

PRIVATE RECIPIENTS OF THIS FORM: You are warned that you may NOT use any of the information provided by the Submitter of this form or any of the attached forms to submit to the government or for ANY commercial purpose. This means you may not use any of the information provided to prepare or submit any IRS information return, such as forms W-2, 1042S, 1098, 1099, K-1, etc. and that if you do you risk criminal prosecution under the provisions of 26 U.S.C. §57206, 7207, 18 U.S.C. §654, and 18 U.S.C. §912. This document also constitutes an indemnification of all personal liability of the private recipient for failure to withhold or report. Submitter agrees to accept all legal consequences for following the context of this form and to become the Substitute Defendant in an action against the Private Recipient for following the requirements of this affidavit. This indemnification does NOT apply to government recipients.

GOVERNMENT RECIPIENTS OF THIS FORM: You are hereby legally notified that any information returns you may have received connected with me, such as W-2, 1042S, 1098, and 1099, are FALSE and FRAUDULENT and this submission constitutes a formal request to correct the false reports and criminally prosecute the submitter to 26 U.S.C. §57206, 7207, 18 U.S.C. §654, and 18 U.S.C. §912 and civilly prosecute pursuant to 26 U.S.C. §7434 and 31 U.S.C. §3729. Any numbers associated with these reports are provided under duress and are not "Social Security Numbers" as defined in 20 CFR §422.104 but rather PRIVATELY issued "Nontaxpayer Identification Numbers" which are protected by copyright and private license agreement and may NOT be stored in any government computer system or used for ANY commercial purpose without violating the license agreement.

13.2. Submitter is a Social Security non-volunteer (See 42 U.S.C. Chapter 7). Any application on file are fraudulent and nullity for any one or more of the following reasons: 1. Never personally made application and therefore nonbinding; 2. Never consented to participate; 3. Cannot lawfully consent because not domiciled on federal territory and not a "U.S. citizen" per 8 U.S.C. §1401 or a "permanent resident" at the time of application in violation of 20 CFR §422.104; 4. Am not a fiduciary acting within any capacity contract with the federal government;

DOCH 361061

Affidavit of Citizenshi

11/27/2012 01:09 PM Page: 99 of 178
AFF R:\$10.00 J. C. Sloan, McKinley County



2022-011769 MISC Page: 2002 of 2782

09/26/2022 09:35:37 PM Receipt # 22-9981
Rec Fee: \$30.00 Darrell James Hill
Gila County, AZ Sadie Jo Bingham, Recorder



DOCH 361076

11/27/2012 04:15 PM Page: 100 of 183
AFF R:\$10.00 J. C. Sloan, McKinley County



AFFIDAVIT OF CITIZENSHIP, DOMICILE, AND TAX STATUS

Date that UNLAWFUL SSA participation was retroactively terminated was May 22, 2006 (Date SSA Form 521 was mailed to SSA and IRS).

- 13.3. Submitter is not a Federal elected or appointed "public officer".
- 13.4. Submitter is not an "employee" as defined in 26 U.S.C. §3401(c) and 26 CFR §31.3401(c)-1.
- 13.5. Submitter has a State-issued driver's license. Corporate (not de jure) State name: Arizona
- 13.6. Submitter has a State issued marriage license.
- 13.7. Submitter does not possess an Attorney license (Admitted to practice by state-supreme Court).
- 13.8. Submitter has no lawful federal government identifying number.

WARNING: You may not use any government issued identifying number in connection with the Submitter, such as a Social Security Number (SSN) as defined in 20 CFR 422.103(d), Taxpayer Identification Number (TIN) as defined in 26 U.S.C. 6109, or Employer Identification Number (EIN) as defined in 26 U.S.C. 6109.

Submitter:

1. Would be violating the law to either request or use a Taxpayer Identification Number. See AFFIRMATION, WHY IT IS ILLEGAL FOR ME TO REQUEST OR USE A TAXPAYER IDENTIFICATION NUMBER (attached).
2. Is not required to have or to use a Social Security Number or Taxpayer Identification Number pursuant to 31 CFR §103.34(a)(3)(x) and 31 CFR §306.10, Note 2.
3. Does not participate and is not lawfully eligible to participate in Social Security or the "trade or business" excise taxable franchise described in 26 U.S.C. Subtitle A.
4. Is not an "alien" for which an Individual Taxpayer Identification Number may lawfully be used pursuant to 26 CFR §301.6109- 1(d)(3). Nonresident aliens are NOT "aliens" are not equivalent. A human being who is a "national" can be a "nonresident alien" with being an "alien". See 26 U.S.C. §7701(b)(1)(A) and 26 U.S.C. §7701(b)(1)(B).
5. May not lawfully use or possess any government identifying number because it is "public property" which belongs to the government pursuant to 20 CFR §422.103(d). Only "public officers" on official business may lawfully use public property, and only in strict accordance with law for the benefit of the government and not them as private individuals.
6. Is appearing as a private person and not a public officer. If you compel me to use a government identifying number, you are an accessory to criminal conversion of private property to a public use and a public purpose if you connect me or my assets with a public number in violation of 18 U.S.C. § 654. You could end up in jail for ten years if you put an identifying number on any records pertaining to me or my property, assets, or my earnings from PRIVATE employment.
7. Has been a victim of identity theft, compelled association, and conversion by the government and its agents in banks and financial institutions in the past by unlawfully and involuntarily connecting them with knowingly false and fraudulent identifying numbers in criminal violation of 18 U.S.C. §1028A, and a civil violation of 42 U.S.C. §408(a)(7) and 42 U.S.C. §405(c)(2)(C)(i). He would like to prevent a recurrence of this behavior again.
8. Will file a criminal complaint in connection with the use of any government issued identifying number connected with his exclusively PRIVATE life, property, and liberty and vociferously prosecute all those who unlawfully compel him to use a knowingly false number or any number at all in order to obtain any service or product in violation of 42 U.S.C. §408.

WARNING: Any Social Security Number or Taxpayer Identification Number you have on file is FALSE and must be removed from your records. Failure to abide by this absolute requirement of law is a criminal violation of 18 U.S.C. §1028(a)(7); 18 U.S.C. §1028A, and a civil violation of 42 U.S.C. §408 and 42 U.S.C. §405(c)(2)(C)(i).

14. DOMICILE AND RESIDENCE

1. My domicile and NOT "residence" is that indicated earlier on Item 12 above.
2. My domicile is outside the statutory but not constitutional "United States" and outside of federal territory. The Term "statutory United States" includes all statutory definitions of "United States" within any act of Congress.
3. I am not a statutory "resident". All "residents" are statutory "aliens" per 26 U.S.C. §7701(b)(4).
4. I DO NOT have a statutory "residence" anywhere within the statutory "United States" per 26 CFR §1.871-2(b) because I am not a statutory "alien".

If you believe that the term "residence" includes the domicile of those who are non-citizen nationals, nonresident alien NON-individuals, please produce a statute that expressly includes this status within the meaning of the term "residence".

15. TAX WITHHOLDING LEGAL REQUIREMENTS

Affidavit of Citizenship

DOCH 361061

11/27/2012 01:09 PM Page: 100 of 178
AFF R: \$10.00 J. C. Sloan, McKinley County

2022-011769 MISC Page: 2003 of 2782

09/25/2022 03:35:37 PM Receipt #: 22-9981
Rec Fee: \$30.00 Darrell James Hill
Gila County, AZ Sadie Jo Bingham, Recorder

DOCH 361076

11/27/2012 04:15 PM Page: 101 of 183

AFF R: \$10.00 J. C. Sloan, McKinley County

AFFIDAVIT OF CITIZENSHIP, DOMICILE, AND TAX STATUS

5. **WARNING:** You may not lawfully withhold any amount from proceeds due to me. The remainder of this section provides legally admissible evidence proving why this is.
6. Your withholding is ONLY on "wages" as legally defined in 26 U.S.C. §3401. The earnings of nonresident alien NON-individuals not engaged in a "trade or business" as legally defined are excluded from "wages" per 26 U.S.C. §3401(a)(6) and 26 U.S.C. §3401(a)(11) and therefore may not lawfully become the subject of tax withholding. If you withhold, you will therefore be guilty of the following crimes:
- 6.1. 18 U.S.C. §654: Conversion of private property to a "public use" and a "public office". You are converting my PRIVATE proceeds as a class member into a public purpose and a "public office" by fraudulently and falsely connecting same with a "trade or business".
- 6.2. 18 U.S.C. §201: Bribery of public officials and witnesses. You are bribing public officials who will receive the money you STOLE from me in violation of the law. The punishment is a fine and up to 15 years in jail. I remind you that all tax withholdings are classified as "gifts" by the IRS. See IRS Document 6209, pp. 4-1 and 4-2, which identify W-2 forms as "Estate and gift taxes". All tax withholdings are "gifts" to public officials that also constitute bribes.
- 6.3. 18 U.S.C. §1956(a)(1)(A)(ii): Money laundering. You are laundering unlawfully withheld proceeds. The punishment is a fine up to \$500,000 and imprisonment for up to twenty years.
7. IRS Publication 515 indicates that nonresident alien individuals who give you IRS form W-8BEN are exempt from backup withholding. This requirement is also found in 26 U.S.C. § 3401(a)(6) or 26 CFR §31.3401(a)(6)-1(b). This Affidavit serves the equivalent of IRS Form W-8BEN because IRS doesn't have a form for those who are "nonresident aliens" but who are not "individuals", "persons", or "taxpayers".

"Foreign persons who provide Form W-8BEN, Form W-8ECI, or Form W-8EXP (or applicable documentary evidence) are exempt from backup withholding and Form 1099 reporting."
[IRS Publication 515, Year 2001, p.3]

8. You MAY NOT lawfully tamper with, reject, redact any portion of, or alter any withholding form that I give you. You must accept them AS IS and may not lawfully threaten me to change them. If you do, you could be prosecuted for extortion.

"The employer is not authorized to alter the form or to dishonor the employee's claim. The certificate goes into effect automatically in accordance with certain standards enumerated in §3402(f)(3)."
[U.S. v. Malinowski, 347 F.Supp. 347 (1972)]

9. The proceeds connected with our relationship do not constitute "income" and therefore cannot be the subject of any tax or withholding or reporting within the Internal Revenue Code. The only definition of "income" in the Internal Revenue Code is found in 26 U.S.C. §643(b) and it includes ONLY the earnings of a trust or estate. I am not representing a domestic trust or estate. My earnings and my entire estate instead are a "foreign estate" pursuant to 26 U.S.C. §7701(a)(31).

10. Any earnings that result from our relationship do not originate from "sources within the United States". The term "United States" is defined below.

If you dispute this definition, please provide the definition that expressly identifies states of the Union as being included in the meaning of "United States".

TITLE 26 > Subtitle F > CHAPTER 79 > Sec. 7701.
Sec. 7701. - Definitions

(a) Definitions

(9) United States

The term "United States" when used in a geographical sense includes only the States and the District of Columbia.

(10) State

The term "State" shall be construed to include the District of Columbia, where such construction is necessary to carry out provisions of this title.

2022-011769 MISC Page: 2004 of 2782
09/26/2022 03:35:37 PM Receipt #: 22-9381
Rec Fee: \$30.00 Darrell James Hill
Gila County, Az, Sadie Jo Bingham, Recorder

DOCH 361076

11/27/2012 04:15 PM Page: 102 of 183
AFF R: \$10.00 J. C. Sloan, Mckinley County



IMENT, A

DOCH 361061

Citizenship

11/27/2012 01:09 PM Page: 101 of 178
AFF R: \$10.00 J. C. Sloan, Mckinley County



AFFIDAVIT OF CITIZENSHIP, DOMICILE, AND TAX STATUS

CHAPTER 4 – THE STATES

Sec. 1210. Same; definitions

(d) The term "State" includes any Territory or possession of the United States.

"Expression unius est exclusio alterius. A maxim of statutory interpretation meaning that the expression of one thing is the exclusion of another. Burgin v. Forbes, 293 Ky. 456, 169 S.W.2d 321, 325; Newblock v. Bowles, 170 Okl. 487, 40 P.2d 1097, 1100. Mention of one thing implies exclusion of another. When certain persons or things are specified in a law, contract, or will, an intention to exclude all others from its operation may be inferred. Under this maxim, if statute specifies one exception to a general rule or assumes to specify the effects of a certain provision other exceptions of effects are excluded."
[Black's Law Dictionary, Sixth Edition, p. 581]

11. The financial transactions likely to result from relationship are excluded from (not "subject to" but not "exempt") taxation pursuant to the following authorities and therefore not subject to withholding:
- 11.1. 26 U.S.C. § 861(a)(3)(C)(i): Earning from labor of "nonresident aliens" not engaged in a "trade or business" and working in the "United States" is not deemed to be income from sources within the "United States".
 - 11.2. 26 U.S.C. § 3401(a)(6): Nonresident aliens do not earn "wages".
 - 11.3. 26 U.S.C. § 1402(b): Nonresident aliens do not earn "self-employment income".
 - 11.4. 26 U.S.C. § 864(b)(1)(A): Earning of "nonresident aliens" working for foreign employers such as private employers do not have earnings associated with a "trade or business in the United States"
 - 11.5. 26 CFR § 31.3401(a)(6)-1(b): Remuneration of nonresident aliens outside the "United States" is not subject to taxation.
 - 11.6. 26 CFR § 1.872-2(f): Earning of nonresident aliens outside "United States" do not constitute "gross income".
 - 11.7. 26 CFR § 1.871-7(a)(4): Nonresident aliens not engaged in a "trade or business" earn no "gross income".
12. Tax withholding is only appropriate for those having a tax liability. A nonresident alien NON-individual such as the submitter with no "income" or earning from "sources within the United States" under 26 U.S.C. § 871 can have no tax liability. If you think you, as a private employer or private institution constitutes a "source within the United States", then why did the IRS Internal Revenue Manual say the following and where are the states of the Union included in "United States" as defined above?:

IRM 5.14.10.2 (09-30-2004)

Payroll Deduction Agreements

2. Private employers, states, and political subdivisions are not required to enter into payroll deduction agreements. Taxpayers should determine whether their employers will accept and process executed agreements before agreements are submitted for approval or finalized.
<http://www.irs.gov/irm/part5/ch14s10.html>

13. You can only be an "employer" if I am an "employee", according to 26 U.S.C. § 3401(d). I am NOT an "employee", because all "employees" are "public officers" engaged in a "trade or business" who work for the United States government as the equivalent of "temps" or "Kelly Girls" on loan to private employers such as you. I DO NOT consent to act in such capacity, and therefore you cannot be an "employer" in the context of me"

26 CFR § 31.3401(c)-1 Employee:

"...the term [employee] includes [is limited to] officers and employees, whether elected or appointed, of the United States, a [federal] State, Territory, Puerto Rico or any political subdivision, thereof, or the District of Columbia, or any agency of instrumentality of any one of more of the foregoing. The term 'employee' also includes an officer of a corporation."

26 U.S.C. § 3401(c) Employee

For purpose of this chapter, the term "employee" includes [is limited to] an officer, employee, or elected official of the United States, a State, or any political thereof, or the District of Columbia, or any agency or instrumentality of any one or more of the foregoing. The term "employee" also includes an officer of a corporation.

2022-011769 MISC Page: 2005 of 2782

09/26/2022 03:36:37 PM Receipt #: 22-9381

James Hill
Darrell Jo Bingham, Recorder
Gila County, Az, Sadie Jo Bingham, Recorder

DOCH 361076

11/27/2012 04:15 PM Page: 103 of 183
AFF R: \$10.00 J. C. Sloan, Mckinley County



DOCH 361061

izenship, 11/27/2012 01:09 PM Page: 102 of 178
AFF R: \$10.00 J. C. Sloan, Mckinley County



AFFIDAVIT OF CITIZENSHIP, DOMICILE, AND TAX STATUS

8 Federal Register, Tuesday, September 7, 1943, §404.104, pg 12267

Employee: "The term employee specifically includes officers and employees whether elected or appointed, of the United States, a state, territory, or political subdivision thereof or the District of Columbia or any agency or instrumentality of any one or more of the foregoing."

If you disagree with this item, please rebut the foregoing within 30 days or be held in default and estoppels to challenge later.

14. You are only liable to withhold if you are an "employer" and if I receive "wages". 26 CFR 31.3403-1, 26 CFR §31.3111-4, 26 CFR §3102-1(c). The only way I can receive "wages" is to sign a contract called a W-4 absent duress consenting to call what proceeds I receive "wages" as legally defined but not commonly understood. If I don't sign the contract, then I don't earn "wages" subject to any withholding or reporting:

"Every man has a natural right to the fruits of his own labor, is generally admitted; and no other person can rightfully deprive him of those fruits, and appropriate them against his will."
[The antelope, 23 U.S. 66: 10 Wheat 66, 6 L.Ed. 268 (1825)]

"Included in the rights of personal liberty and the right of private property—partaking of the nature of each—is the right to make contracts for the acquisition of property. Chief among such contracts is that of personal employment, by which labor and other services are exchanged for money or other forms or property."

"...The right of a person to sell his labor upon such terms as he deems proper is, in its essence, the same as the right of the purchaser of labor to prescribe the conditions under which he will accept such labor from the person offering to sell it."

26 CFR §31.3401(a)-3 Amounts deemed wages under voluntary withholding agreements

(a) In general.

Notwithstanding the exceptions to the definition of wages specified in section 3401(a) and the regulations thereunder, the term "wages" includes the amounts described in paragraph (b)(1) of this section with respect to which there is a voluntary withholding agreement in effect under section 3402(p). References in this chapter to the definition of wages contained in section 3401(a) shall be deemed to refer also to this section. (§31.3401(a)-3).

Title 26: Internal Revenue

PART 31—EMPLOYMENT TAXES AND COLLECTION OF INCOME TAX AT SOURCE

Subpart E—Collection of Income Tax at Source

§31.3402(p)-1 Voluntary withholding agreements

(a) In general.

An employee and his employer may enter into an agreement under section 3402(b) to provide for the withholding of income tax upon payments of amounts described in paragraph (b)(1) of §31.3401(a)-3, made after December 31, 1970. An agreement may be entered into under this section only with respect to amounts which are includible in the gross income of the employee under section 61, and must be applicable to all such amounts paid by the employer to the employee. The amount to be withheld pursuant to an agreement under section 3402(p) shall be determined under the rules contained in section 3402 and the regulations thereunder. See §31.3405(c)-1, Q&A-3 concerning agreements to have more than 20-percent Federal income tax withheld from eligible rollover distributions with the meaning of section 402.

DOC# 361076

11/27/2012 04:15 PM Page: 104 of 183
AFF R:\$10.00 J. C. Sloan, McKinley County



DOC# 361061

11/27/2012 01:09 PM Page: 103 of 178
izenship, AFF R:\$10.00 J. C. Sloan, McKinley County



2022-011769 MISC Page: 2006 of 2782

09/26/2022 03:35:37 PM Receipt #: 22-9381
Darrell James Hill
Rec Fee: \$30.00
Sadie Jo Bingham, Recorder
Gila County, Az.

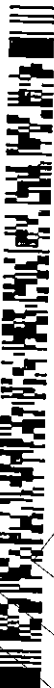

AFFIDAVIT OF CITIZENSHIP, DOMICILE, AND TAX STATUS

15. If I never give you an IRS form W-4 and thereby consent to call what proceeds I am due "wages" as defined in the Internal Revenue Code, then you can't lawfully withhold or report anything:

15.1. Everything that goes on the IRS form W-2 constitutes "wages" as legally defined and not commonly understood.

15.2 Tax withholding ONLY pertains to "wages" as legally defined and NOT all earnings. The U.S. Supreme Court confirmed this:

"We must reject in this case, as we have rejected in cases arising under the Corporation Excise Tax Act of 1909 (Doyle, Collector, v. Mitchells Brother Co., 247 U.S. 179, 38 Sup. Ct. 467, 62 L. Ed. --) the broad contention submitted on behalf of the government that all receipts—everything that comes in—are income with the proper definition of the term 'gross income.' And that the entire proceeds of a conversion of capital assets, in whatever form and under whatever circumstances accomplished, should be treated as gross income. Certainly the term 'income' has no broader meaning in the 1913 act than in that of 1909 (See Stratton's Independence v. Howbert, 231 U.S. 399, 416, 417 S., 34 Sup. Ct. 136), and for the present purpose we assume there is no difference in its meaning as used in the two acts."
[Southern Pacific Co., v. Lowe, 247 U.S. 330, 335, 38 S. Ct 540 (1918)]

15.3. If you are ordered by the IRS, et al., to withhold proceeds because I refuse to submit an IRS for W-4, then you must withhold and report ONLY on "wages" as statutorily defined and limited pursuant to the I.R.C. "trade or business" franchise agreement. I don't earn "wages" if I never consented to call them "wages" using a private contract called an IRS form W-4.

16. On the subject of unlawful withholding the Bible say the following. "Wages" as used below implies the ordinary and excludes the statutory definition:

"Woe to him who builds his house by unrighteousness
And his chambers by injustice,
Who [whether individual or government] uses his neighbor's service without wages
And give him nothing for his work
[Jer. 22:13, Bible, NKJV]

"Come now, you rich, weep and howl for your miseries that are coming upon you! Your riches are corrupted, and your garments are moth-eaten. Your gold and silver are corroded, and their corrosion will be a witness against you and will eat your flesh like fire. You have heaped up treasure in the last days. Indeed the wages of the laborers who mowed your fields, which you kept back by fraud, cry out; and the cries of the reapers have reached the ears of the Lord of Sabaoth. You [business owner who control the purse of the workers] have lived on the earth in pleasure and luxury; you have fattened your hearts as in a day of slaughter. You have condemned, you have murdered the just, he does not resist you."
[James 5:1-6, Bible, NKJV]

"You shall not cheat your neighbor, nor rob him. The wages of him who is hired shall not remain with you all night until morning.
[Lev. 19.13, Bible, NKJV]

16. TAX REPORTING LEGAL REQUIREMENTS:

1. **WARNING:** it is a criminal offense to file information returns against any payments you make in connection with our relationship. Filing of false information returns carries severe civil and criminal penalties. Information returns include IRS Forms W-2, 1042S, 1098, and 1099.

I can only earn "wages" reportable on an IRS form W-2 if I am lawfully engaged in a "public office" in the U.S. Government as required by 26 U.S.C. §6041(a). Voluntarily signing a contract/agreement called an IRS form W-4 is the only way that a nonresident alien NON-individual not engaged in a "trade or business" can engage in such a "public office" per 26 CFR §31.3401(a)-3(a), and 26 CFR 31.3402(p)-1. Otherwise, it is a crime to impersonate a public officer in violation of 18 U.S.C. §912 to file an information return. If you file any kind of information return relating to me, you will be guilty of conspiracy to commit all the following crimes and civil infractions:

- 1.1. False information returns submitted in violation of 26 U.S.C. §7434. Punishment is all attorney fees plus twice the false amount reported.
- 1.2. Impersonating a public officer in violation of 18 U.S.C. §912. Punishment is a fine and up to three years in jail. Only "public officers" can act as "taxpayers", and you are creating a false presumption that I am a "taxpayer" by filing false information returns.

Affidavit of Citizenshi

DOCH 361061

11/27/2012 01:09 PM Page: 104 of 178
AFF R: \$10.00 J. C. Sloan, McKinley County

2022-011769 MISC Page: 2007 of 2782
09/26/2022 03:35:37 PM Receipt #: 22-9381
Rec Fee: \$30.00 Darrell James Hill
Gila County, Az, Sadie Jo Bingham, Recorder

DOCH 361076

11/27/2012 04:15 PM Page: 105 of 183
AFF R: \$10.00 J. C. Sloan, McKinley County

AFFIDAVIT OF CITIZENSHIP, DOMICILE, AND TAX STATUS

- 1.3. Conversion of private property to a public use, public purpose, and public office as a "withholding agent" in violation of 18 U.S.C. §654.
- 1.4. Impersonating a public officer in violation of 18 U.S.C. §911. Punishment is a fine and up to three years in jail. Only *statutory* and not *constitutional* "U.S. citizens" can lawfully act as "public officers" engaged in a "trade or business" and I am NOT a statutory "U.S. citizen" pursuant to 8 U.S.C. §1401 but rather a non-citizen national.
- 1.5. False information returns in violation of 26 U.S.C. §7206. Punishment is up to a \$100,000 fine and 3 years in jail to file a false information return.
- 1.6. False information returns in violation of 26 U.S.C. §7207. Punishment is up to \$10,000 and 1 year in jail to submit a false information return.
- 1.7. Perjury in violation of 18 U.S.C. §1001 and 18 U.S.C. §1621. The IRS Forms W-3 and 1096 submitted with the information return is signed under penalty of perjury and verifies the accuracy of the accompanying information return. These forms are submitted as a government officer and agent called a "withholding agent" defined in 26 U.S.C. 7701(a)(16). Those forms are FRAUDULENT now that you have been notified that they are false and you willfully refuse to either stop filing the false report or correct the false reports already filed.

2. IRS Publication 515 indicates that nonresident aliens who give you IRS form W-8BEN are exempt for 1099 reporting. This document serves the equivalent purpose and is a superset of that form.

*"Foreign persons who provide Form W-8BEN, Form W-8ECI, or Form W-EXP (or applicable documentary evidence) are exempt from backup withholding and Form 1099 reporting."
[IRS Publication 515, Year 2001, p3]*

3. 26 U.S.C. §6041 says that only earnings connected with a "trade or business" may be reported on an information return such as IRS forms W-2, W-3, 1042-S, 1096, and 1099.

TITLE 26 > Subtitle F > CHAPTER 61 > Subchapter A > PART III > § 6041
§ 6041. Information at source

(a) Payments of \$600 or more

All persons engaged in a trade or business and making payment in the course of such trade or business to another person, of rent, salaries, wages, premiums, annuities, compensations, remunerations, emoluments, or other fixed or determinable gains, profits and income (other than payments to which section 6042 (a)(1), 6044 (a)(1), 6047 (e), 6049 (a), or 6050N (a) applies, and other than payments with respect to which a statement is required under the authority of section 6042 (a)(2), 6044 (a)(2), or 6045), of \$600 or more in any taxable year, or in the case of such payments made by the United States, the officers or employees of the United States having information as to such payments and required to make returns in regard thereto by the regulations hereinafter provided for, shall render a true and accurate return to the Secretary, under such regulations and in such form and manner and to such extent as may be prescribed by the Secretary, setting forth the amount of such gains, profits, and income, and the name and address of the recipient of such payment.

4. None of the proceeds connected with our relationship pertains to a "trade or business" as statutorily defined below, and therefore is not subject to reporting:

26 U.S.C. Sec. 7701(a)(26)

"The term 'trade or business' includes the performance of the functions of a public office."

5. The term "income" is defined in 26 U.S.C. §643(b), and only "income" may be reported. Since I am NOT an "estate or trust", I earn no reportable "income".

TITLE 26 > Subtitle A > CHAPTER 1 > Subchapter J > PART I > Subpart A > §643
§643. Definitions applicable to subparts A, B, C, and D

(b) Income

For purpose of this subpart and subparts B, C, and D, the term "income, when not preceded by the words "taxable", "distributable net", "undistributed net", or "gross", means that amount of income of

2022-011769 MISC Page: 2008 of 2782

09/26/2022 03:35:37 PM Receipt #: 22-9381

Rec Fee: \$30.00 Darrell James Hill
Gila County, Az. Sadie Jo Bingham, Recorder

DOCH 361076

vit of Citizens

DOCH 361061

11/27/2012 04:15 PM Page: 106 of 183
AFF R:\$10.00 J. C. Sloan, McKinley County

11/27/2012 01:09 PM Page: 105 of 178
AFF R:\$10.00 J. C. Sloan, McKinley County

AFFIDAVIT OF CITIZENSHIP, DOMICILE, AND TAX STATUS

the estate or trust for the taxable year determined under the terms of the governing instrument and the applicable local law. Items of gross income constituting extraordinary dividends or taxable stock dividends which the fiduciary, acting in good faith, determines to be allocable to corpus under the terms of the governing instrument and applicable local law shall not be considered income.

IRS Form 1042-S may only be prepared in the case of statutory "nonresident aliens" (per 26 U.S.C. §7701(b)(1)(B)) who have "income" from "sources within the statutory but not constitutional "United States" that is not connected with a "trade or business" and therefore constitutes "gross income" with the meaning of 26 U.S.C. §61. All such sources are expressly indicated in 26 U.S.C. §871(a). All of these sources are government payments. The transactions likely to occur between us are NOT government payments and are not listed in 26 U.S.C. §871(a), and therefore may not lawfully be reported.

SECTION 2: AFFIDAVIT OF TAX STATUS

Human being (but not statutory "Person") who signed this form hereby affirms under penalty of perjury from WITHOUT the statutory "United States" per 28 U.S.C. §1746(1) that:

1. Submitter has NO tax liability or "gross income" pursuant to 26 CFR §1.872-2(f), 26 CFR §1.871-1(a), and 26 U.S.C. §861(a)(C)(i) and therefore no need to deduct or withhold.
2. Submitter is not a statutory "taxpayer" as defined in 26 U.S.C. §7701(a)(14) and not subject to the revenue laws.

"Revenue Laws relate to taxpayers [instrumentalities, officers, employees, and elected officials of the Federal Government] and not to non-taxpayers [American Citizens/American Nationals not subject to the exclusive jurisdiction of the Federal Government and not engaged in the "trade or business" franchise as a public officer]. The latter are without their scope. No procedures are prescribed for non-taxpayers and no attempt is made to annul any of their Rights or Remedies in due course of law. With them [non-taxpayers] Congress does not assume to deal and they are neither of the subject nor of the object of federal revenue laws."

[Economy Plumbing & Heating v. U.S., 470 F2d, 585 (1972)]

3. Submitter is not "exempt" or an "exempt individual" as defined in 26 U.S.C. §7701(b)(5) because one must otherwise be subject to the I.R.C. to be such a legal "person". Rather, Submitter is "not subject" to Internal Revenue Code Subtitle A franchise agreement and is a nonresident. Since IRS forms very deliberately do not have a block for "not subject" and are only for use by those who are "taxpayers", Submitter had to make his own form, THIS DOCUMENT, to avoid committing perjury on a government form in describing his status under penalty of perjury. Those who are "not subject" are described NOT as a "person", "individual", or "taxpayer", but simply as "foreign" or a "foreign estate" in 26 U.S.C. §7701(a)(31).

TITLE 26 > Subtitle F > CHAPTER 79 > § 7701 §7701. Definitions

(a) Definitions

(31) Foreign estate or trust

(A) Foreign estate

The term "foreign estate" means an estate the income of which, from sources without the United States which is not effectively connected with the conduct of a trade or business within the United States, is not includible in gross income under subtitle A.

4. Submitter is a "nonresident" as statutorily defined pursuant to 26 U.S.C. § 7701(b)(1)(B) but not a "nonresident alien individual". A "nonresident alien" is defined as one who is "neither a citizen nor a resident" of the "United States", which is exactly what an "American National", or national born in a state of the Union who is not domiciled on federal territory in the "United States" is. The only withholding form that a "nonresident" who is neither a statutory "alien" (per 26 U.S.C. §7701(b)(1)(A) nor an "individual" (per 26 CFR §1.1441-1(c)(3) and 5 U.S.C. §2105(a)) and who is not engaged in federal franchises can fill out is a W-8BEN with block 3 modified to add the word "nontaxpayer" or "human being" to it. All statutory "taxpayers" and "individuals" are "aliens" per 26 CFR §1.1441-1(c)(3) and public officers in the national and not state government, and therefore submitter cannot check the "individual" block of the W-8BEN form without committing perjury. Even statutory "U.S. Citizens" per 26 CFR §1.1-1(c) and 26 U.S.C. §3121(e) must be aliens in relation to a foreign country under a tax treaty per 26 U.S.C. §911 in order to be "taxpayers".

2022-011769 MISC Page: 2009 of 2782
09/26/2022 09:35:37 PM Receipt #: 22-9381
Rec Fee: \$30.00 Darrell James Hill
Gila County, Az, Sadie Jo Blingham, Recorder

Affidavit of Citizenship,

DOCH 361061

11/27/2012 01:09 PM Page: 106 of 178
AFF R:\$10.00 J. C. Sloan, Mckinley County

DOCH 361076

11/27/2012 04:15 PM Page: 107 of 183
AFF R:\$10.00 J. C. Sloan, Mckinley County

AFFIDAVIT OF CITIZENSHIP, DOMICILE, AND TAX STATUS

5. Submitter is not engaged in a "trade or business", which is defined in 26 U.S.C. § 7701(a)(26) as "the functions of a public office". Receipt of earnings from the District of Columbia in connection with a "trade or business" under 26 U.S.C. 5871(b) or not connected under 26 U.S.C. 871(a) are the only types of "gross income" or "taxable income" that nonresidents who are not aliens can have under I.R.C. Subtitle A.
6. Submitter is a "transient foreigner" but not a statutory "foreign person" or statutory "alien" in respect to the national government and federal territory. A human being or artificial entity such as a state corporation domiciled in a state of the Union is a "transient foreigner" but not a "person", "individual", or "foreign person" for the purposes of the Internal Revenue Code because the term "United States" is defined in 26 U.S.C. 57701(a)(9) and (a)(10) as the District of Columbia and is nowhere expressly expanded to include any state of the Union.
7. Submitter is not in receipt of any treaty benefit under the terms of an income tax treaty with a foreign country.
8. Submitter has not made an election to be treated as a "resident alien" as defined in 26 U.S.C. 7701(b)(1)(A) under the authority of 26 U.S.C. 56013(g) and (h).
9. Submitter is not a statutory "individual" as defined in 26 CFR §1.1441-1(c)(3) or a "person" as defined in 26 U.S.C. 57701(c) because not domiciled or resident on federal territory and not eligible or consensually participating in any federal franchise or "benefit" in the context of this exclusively private and not public transaction. As such, he is not a "public officer" with the government but rather a private human being. The only thing the government can regulate or tax are public activities, public officers, and public "employees" who are the only "persons" mentioned in the I.R.C. franchise per 26 U.S.C. §7343 and 6671(b). It is otherwise unconstitutional to regulate exclusively private conduct.

"The power to "legislate generally upon" [the PRIVATE] life, liberty, and property, as opposed to the "power to provide modes of redress" against offensive state [e.g. "public officer"/"employee"] action, was "repugnant" to the Constitution. Id., at 15. See also United States v. Reese, 92 U.S. 214, 218 (1876); United States v. Harris, 106 U.S. 629, 639 (1883); James v. Bowman, 190 U.S. 127, 139 (1903). Although the specific holdings of these early cases might have been superseded or modified, see, e.g., Heart of Atlanta Motel, Inc. v. United States, 379 U.S. 241 (1964); United States v. Guest, 383 U.S. 745 (1966), their treatment of Congress' §5 power as corrective or preventive, not definitional, has not been questioned."

[City of Boerne v. Flores, Archbishop of San Antonio, 521 U.S. 507 (1997)]

10. Submitter is **NOT** subject to IRS Form 1099 reporting, withholding, or backup withholding pursuant to 26 U.S.C. 53401(a)(6) or 26 CFR 531.3401(a)(6)-1(b):

*"Foreign persons who provide Form W-8BEN, Form W-8ECI, or Form W-8EXP (or applicable documentary evidence) are exempt from backup withholding and Form 1099 reporting."
[IRS Publication 515, year 2001, p. 3]*

11. Submitter is not a "U.S. person" as statutorily defined pursuant to 26 U.S.C. 7701(a)(30). The term "U.S. person" is statutorily defined as follows:

TITLE 26 > Subtitle F > CHAPTER 79 > Sec. 7701.
Sec. 7701. -- Definitions

(a)(30) United States person

The term "United States person" means -

(A) a citizen or resident of the United States,

(B) a domestic partnership,

(C) a domestic corporation,

(D) any estate (other than a foreign estate, within the meaning of paragraph (31)), and

(E) any trust if -

(i) a court within the United States is able to exercise primary supervision over the administration of the trust, and

(ii) one or more United States persons have the authority to control all substantial decisions of the trust.

12. The term "United States" as used in "U.S. person" above is defined in 26 U.S.C. 57701(a)(9) and (a)(10) as follows:

Affidavit of Citizenship, **DOCH 361061**

11/27/2012 01:09 PM Page: 107 of 178
AFF R:\$10.00 J. C. Sloan, McKinley County

2022-011769 MISC Page: 2010 of 2782
09/26/2022 03:35:37 PM Receipt #: 22-9381
Rec Fee: \$30.00 Darrell James Hill
Gila County, Az, Sadie Jo Bingham, Recorder

DOCH 361076

11/27/2012 04:15 PM Page: 108 of 183
AFF R:\$10.00 J. C. Sloan, McKinley County

AFFIDAVIT OF CITIZENSHIP, DOMICILE, AND TAX STATUS

TITLE 26 > Subtitle F > CHAPTER 79 > Sec. 7701. [Internal Revenue Code]
Sec. 7701. – Definitions

(a) When used in this title, where not otherwise distinctly expressed or manifestly incompatible with the intent thereof—

(9) United States

The term "United States" when used in a geographical sense includes on the States and the District of Columbia.

(10) State

The term "State" shall be construed to include the District of Columbia, where such construction is necessary to carry out provisions of this title.

13. Pursuant to the rules for statutory construction, if the states of the Union are not mentioned anywhere in Subtitle A of the Internal Revenue code and are not included in the definition of "United States" above, they can be safely assumed to be EXCLUDED by implication:

"Expressio unius est exclusio alterius. A maxim of statutory interpretation meaning that the expression of one thing is the exclusion of another. Burgin v. Forbes, 293 Ky. 456, 169 S.W.2d 321, 325; Newblock v. Bowles, 170 Okl. 487, 40 P.2d 1097, 1100. Mention of one thing implies exclusion of another. When certain persons or things are specified in a law, contract, or will, an intention to exclude all others from its operation may be inferred. Under this maxim, if statute specifies one exception to a general rule or assumes to specify the effects of a certain provision other exceptions of effects are excluded."
[Black's Law Dictionary, Sixth Edition, p. 581]

14. Nonresidents not engaged in a "trade or business" such as the Submitter are not required to provide identifying number to open financial accounts. The regulation below mentions "nonresident aliens", and nonresidents who are not statutory "aliens" must be treated the same:

Title 31: Money and finance: Treasury
PART 103—FINANCIAL RECORDKEEPING AND REPORTING OF CURRENCY AND FOREIGN TRANSACTIONS
Subpart C—Records Required To Be Maintained
§103.34 additional records to be made and retained by banks.

(a)(3) A taxpayer identification number required under paragraph (a)(1) of this section need not be secured for accounts or transactions with the following:

(x) non-resident aliens who are not engaged in a trade of business in the United States.

In instances described in paragraph (a)(3), (viii) and (ix) of this section, the bank shall, within 15 days following the end of any calendar year in which the interest accrued in that year is \$10 or more use its best effort to secure and maintain the appropriate taxpayer identification number or application form therefor.

15. It amounts to "compelled to association" in violation of the First Amendment to force me to associate with and be identified as a "U.S. person" (under 26 U.S.C. § 7701(a)(30)), a statutory "U.S. Citizen" (under 8 U.S.C. §1401), or a "taxpayer" (under 26 U.S.C. §7701(a)(14)) or any status OTHER than that described above. I would also be committing perjury under penalty of perjury to sign any government form that identified me as any of the three types of entities.

16. I will not allow you to compel me to participate in the "trade or business" franchise or contract with the government by changing my status to be anything other than that described herein. All franchises are contracts between the grantor and the grantee:

As a rule, franchises spring from contracts between the sovereign power and private citizens, made upon valuable considerations, for purposes of individual advantage as well as public benefit, and thus a franchise partakes of a double nature and character. So far as it affects or concerns the public, it is

Affidavit of Citizenship,

DOCH 361061

11/27/2012 01:09 PM Page: 108 of 178
AFF R:\$10.00 J. C. Sloan, McKinley County



2022-011769 MISC Page: 2011 of 2762
09/26/2022 03:36:37 PM Receipt #: 22-9381
Rec Fee: \$30.00 Darrell James Hill
Gila County, Az, Sadie Jo Bingham, Recorder



DOCH 361076

11/27/2012 04:15 PM Page: 109 of 183
AFF R:\$10.00 J. C. Sloan, McKinley County



2002

AFFIDAVIT OF CITIZENSHIP, DOMICILE, AND TAX STATUS

publici juris and is subject to governmental control. The legislature may prescribe the manner of granting it, to whom it may be granted, the condition and terms upon which it may be held, and the duty of the grantee to the public in exercising it, and may also provide for its forfeiture upon the failure of the grantee to perform that duty. But when granted, it becomes the property of the grantee, and is a private right, subject only to the governmental control growing out of its other nature as publici juris.
[Am.Jur.2d, Franchises, §4: Generally]

17. Pursuant to the Declaratory Judgment Act, 28 U.S.C. §2201(a) and the federal courts, the recipient of this form and any government agent handling this case has NO authority to assume any tax status other than that indicated on this form or to convert an innocent "nontaxpayer" into a "taxpayer".

*Specifically, Rowen seeks a declaratory judgment against the United States of America with respect to "whether or not the plaintiff is a taxpayer pursuant to, and/or under 26 U.S.C. § 7701(a)(14)." (See Compl. At 2.) The court lacks jurisdiction to issue a declaratory judgment "with respect to Federal taxes other than actions brought under section 7428 of the Internal Revenue code of 1986, " a code section that is not at issue in the instant action. See 28 U.S.C. §2201; see also Hughes v. United States, 953 F.2d 531, 536-537 (9th Cir. 1991) (affirming dismissal of claim for declaratory relief under § 2201 where claim concerned question of tax liability). Accordingly, defendant's motion to dismiss is hereby GRANTED, and the instant action is hereby DISMISSED.
[Rowen v. US., 05-3766MMC. (N.D.Cal. 11/02/2005)]*

"And by statutory definition, 'taxpayer' includes any person, trust or estate subject to a tax imposed by the revenue act. ...Since the statutory definition of 'taxpayer' is exclusive, the federal courts do not have the power to create nonstatutory taxpayers for the purpose of applying the provisions of the Revenue Acts..."

[C.I.R. v. Trustees of L. Inv. Ass'n, 100 F.2d 18 (1939)]

"A reasonable construction of the taxing statutes does not include vesting any tax official with absolute power of assessment against individuals not specified in the statutes as a person liable for the tax without an opportunity for judicial review of this status before the appellation of 'taxpayer' is bestowed upon them and their property is seized..."

[Botto v. Scanlon, 288 F.2d. 504, 508 (1961)]

SECTION 3: DURESS STATEMENT

If any other government form with the Recipient of this form might have received or viewed which I might have signed contradicts anything contained herein, the reasons are that:

1. I was threatened or felt threatened:
 - 1.1. By the Recipient to either not be hired or be fired if I did not sign a W-4 agreement or submit to a specific government form that doesn't pertain to me and thereby commit what I know to be fraud and/or perjury on a government form. . . OR
 - 1.2. By the Recipient because I was told that I would be denied the EQUAL right of all to engage in a business or financial account needed to sustain my life if I did not fill out and submit the form indicated and which I know misrepresented my status or had no options to correctly represent my status. . . OR
 - 1.3. By the government because I would become the target of unlawful or "selective" IRS/government enforcement that the legal profession, the courts, and the government routinely protect and encourage because of conflicts of interest, undue consolidation of power, and greed.

¹ Georgia R. & Power Co. v. Atlanta, 154 Ga 731, 115 SE 263; Lippencott v. Allander, 27 Iowa 460; State ex rel. Hutton v. Baton Rouge, 217 La 857, 47 So 2d 665; Tower v. Tower & S. Street R. Co. 68 Minn 500, 71 NW 691.

² Georgia R. & Power Co. v. Atlanta, 154 Ga 731, 115 SE 263; Lippencott v. Allander, 27 Iowa 460; State ex rel. Hutton v. Baton Rouge, 217 La 857, 47 So 2d 665; Tower v. Tower & S. Street R. Co. 68 Minn 500, 71 NW 691.

Affidavit of Citizenship, **DOCH 361061**

11/27/2012 01:09 PM Page: 109 of 178
AFF R:\$10.00 J. C. Sloan, McKinley County



2022-011769 MISC Page: 2012 of 2782
09/26/2022 03:35:37 PM Receipt #: 22-9381
James Hill
Darrell Bingham, Recorder
Gila County, Az, Sadie Jo Bingham

DOCH 361076

11/27/2012 04:15 PM Page: 110 of 183
AFF R:\$10.00 J. C. Sloan, McKinley County

AFFIDAVIT OF CITIZENSHIP, DOMICILE, AND TAX STATUS

"For the love of money is the root of all evil: which while some coveted after, they have erred from the faith, and pierced themselves through with many sorrows.

But thou, O man of God, flee these things' and follow after righteousness, godliness, faith, love, patience, meekness.

Fight the good fight of faith, lay hold on eternal life, whereunto thou art also called, and hast professed a good profession before many witnesses."

[1 Timothy 6:5-12, Bible, NKJV]

1.4 By the Recipient, who may have refused to accept this for or sent it back, because they knew they were violating both the law and my right and wanted to obstruct justice, destroy evidence of their wrongdoing, and tamper with a federal witness because this form is signed under penalty of perjury.

2. I was therefore under unlawful duress and the target of racketeering, extortion, and/or unconscionable "adhesion contracts" by the recipient/ government.

3. The origin of the duress was the Recipient of this form acting in a quasi-governmental and "public officer" capacity as a "withholding agent" pursuant to 26 U.S.C. §7701(a)(16) and who is therefore legally liable to respect my constitutional rights and REFUSED demands to do so.

... AND

4. The result of the unlawful duress was that I was compelled to contract with or engage in commerce within the government against my will and/or religious beliefs in violation of Article 1, section 10 of the United States Constitution, and to donate private property to a public use, public purpose, and/or public office in the government such as the "trade or business" franchise that is the heart of the Internal Revenue Code. Participation in all government franchises is an act of contracting because all franchises are contracts.

I hereby for the record declare as void, untrustworthy, and not admissible as evidence of any obligation on my part in any and all forms, declarations of status, or other correspondence in conflict with this form or any attached form I may have provided because such was submitted under unlawful duress.

*"An agreement [consensual contract] obtained by duress, coercion, or intimidation is invalid, since the party coerced is not exercising his free will, and the test is not so much the means by which the party is compelled to execute the agreement as the state of mind induced."*³ *Duress, like fraud, rarely becomes material, except where a contract or conveyance has been made which the maker wishes to avoid. As a general rule, duress renders the contract or conveyance voidable, not void, at the option of the person coerced, and it is susceptible of ratification. Like other voidable contracts, it is valid until it is avoided by the person entitled to avoid it."*⁴ *However, duress in the form of physical compulsion, in which a party is caused to appear to assent when he has no intention of doing so, is generally deemed to render the resulting purported contract void.*⁵

[American Jurisprudence 2d, Duress, Section 21]

This affidavit of duress and void declaration especially includes, but is not limited to, anything relating to government franchises, disclosures of government identifying numbers such as SSN or TIN, tax withholding or reporting forms such as the W-4 contract forms (26 CFR §31.3401(a)-3(a) and 26 CFR §31.3402(p)-1, tax returns, or any other declaration of status (e.g. "employee", "taxpayer", "individual", "inhabitant", "U.S. citizen") arising out of any tax, citizenship, or licensing forms provided to the government such as driver's license applications, applications for ID cards, voter registration, or benefit applications.

³ Brown v. Pierce, 74 U.S. 205, 7 Wall 205, 19 L.Ed 134

⁴ Bannette v. Wells Fargo Nevada Nat'l Bank, 270 U.S. 438, 70 L.Ed 669, 46 S Ct 326 (holding that acts induced by duress which operate solely on the mind, and fall short of actual physical compulsion, are not void at law, but are voidable only, at the election of him whose acts were induced by it); Faske v. Gershman, 30 Misc 2d 442, 215 NYS2d 144; Glenney v. Crane (Tex Civ App Houston (1st Dist)) 352 SW2d 773, writ ref n r e (May 16, 1962); Carroll v. Fetty, 121 W.Va 215, 2 SE.2d 521, cert den 308 U.S. 571, 84 L.Ed 479, 60 S ct 85.

⁵ Faske v. Gershman, 30 Misc 2d 442, 215 NYS2d 144; Heider v Unicum, 142 Or 416, 20 P2d 384; Glenney v. Crane (Tex Civ App Houston (1st Dist)) 352 SW2d 773, writ ref n r e (May 16, 1962)

⁶ Restatement 2d, Contracts § 174, stating that if conduct that appears to be a manifestation of assent by a party who does not intend to engage in that conduct is physically compelled by duress, the conduct is not effective as a manifestation of assent.

Affidavit of Citizenship,

DOCH 361061

11/27/2012 01:09 PM Page: 110 of 178
AFF R:\$10.00 J. C. Sloan, McKinley County



11/27/2012 04:15 PM Page: 111 of 183
AFF R:\$10.00 J. C. Sloan, McKinley County

2022-011769 MISC Page: 2013 of 2782
09/26/2022 09:35:37 PM Receipt #: 22-9361
Rec Fee: \$30.00 Darrell James Hill
Gila County, Az, Sadie Jo Bingham, Recorder

2004

AFFIDAVIT OF CITIZENSHIP, DOMICILE, AND TAX STATUS

SECTION 4: DO NOT ATTEMPT TO ADVISE ME WHAT TO PUT ON ANY GOVERNMENT FORM OR TO CHANGE THE STATUS DESCRIBED IN THIS FORM

Per 26 U.S.C. §6065, all tax forms must be signed under penalty of perjury, just as this form is. As such, this form and ALL tax forms I submit to you constitute "testimony of a witness" and are protected by witness tampering laws. I remind the recipient that it is a federal offense to tamper with witnesses. Tampering includes, but is not limited to:

1. Advising me what to put on this form or any tax or withholding form and thereby conspire to commit PERJURY in violation of 18 U.S.C. §1542, 18 U.S.C. §911, 18 U.S.C. §1001, and 18 U.S.C. §1621. All such attempts shall form an inseparable part of the forms you both receive and must keep on file so that you may be held accountable.
 2. Refusing to honor that status that I describe here and thereby compelling me to commit perjury for the PRIVILEGE of being treated EQUALLY to everyone else you service.
 3. Telling me that what I put on the form is INCORRECT or FALSE and thereby refusing to accept the form, and yet refusing to offer legal evidence signed under penalty of perjury (as required by 26 U.S.C. §6065) PROVING that it is false.
 4. Threatening to withhold service or discriminate against me while acting as a public officer called a "withholding agent" defined in 26 U.S.C. §7701(a)(14). That would be a denial of equal protection of the law.
 5. Imputing or assuming a legal status OTHER than what I put here, and which might subject me to illegal enforcement or penalties against parties not subject. All such activities constitute an unconstitutional "Bill of Attainder" if implemented against those not consensually and lawfully engaged in government franchises. Not even federal judges can make such determinations.
- 28 22 U.S.C. 2201(a) forbids such determinations.

SECTION 5: SIGNATURE OF SUBMITTER

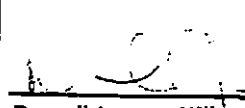
Worker Signature:	I certify under penalty of perjury from without the "United States" in accordance with <u>28 U.S.C. § 1746(1)</u> that the information provided on this form is true, correct, and complete.  Darrell James, Hill	Date signed: 10/11/12	
-------------------	--	------------------------------	--

NOTARY PUBLIC CERTIFICATION

BEFORE ME, the undersigned authority, a Notary Public, of the County of MCKINLEY, Republic of NEW MEXICO (statename), this 11th day of OCTOBER 20 12

Darrell James Hill the above signed human being did appear and was identified by (circle or

driver's license/passport/other and who, upon first being duly sworn and/or affirmed, deposes and says that foregoing asseveration is true to the best of his knowledge and belief.

I certify under PENALTY OF PERJURY under the laws of the State of NEW MEXICO that the foregoing paragraph is true and correct.

WITNESS my hand and official seal.

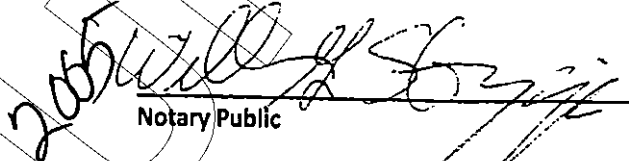
Notary Public Seal
My Commission Expires On: June 1, 2016

 OFFICIAL SEAL
WILLIAM G. STRIPP
NOTARY PUBLIC
STATE OF NEW MEXICO
My Commission Expires 6/1/2016

DOC# 361076
11/27/2012 04:15 PM Page: 112 of 183
OFF R:\$10.00 J. C. Sloan, McKinley County

2022-011769 MISC Page: 2014 of 2782
09/26/2022 03:35:37 PM Receipt #: 22-9381
Rec Fee: \$30.00 Darrell James Hill
Gila County, Az, Sadie Jo Bingham, Recorder

DOC# 361061
11/27/2012 01:09 PM Page: 111 of 178
OFF R:\$10.00 J. C. Sloan, McKinley County

AFFIDAVIT OF CITIZENSHIP, DOMICILE, AND TAX STATUS

APPENDIX: LEGAL POINTS AND AUTHORITIES

(This section provided for those who seek supporting authorities of statement made in this document)

1. A "national" is statutorily defined as follows:

TITLE 8 > CHAPTER 12 > SUBCHAPTER I . Sec. 1101.

Sec. 1101. - Definitions

(a)(21) The term "national" means a person owing permanent allegiance to a state.

2. The "state" in the above definition is a state of the Union. All states of the Union are "foreign states" with respect to federal government legislative jurisdiction, and therefore are lower case. Federal territories are capitalized as "State" within federal law. For example:

TITLE 4 - FLAG AND SEAL, SEAT OF GOVERNMENT, AND THE STATES

CHAPTER 4 - THE STATES

Sec. 110. Same; definitions

(d) The term "state" includes any Territory or possession of the United States.

3. Even the "United States of America" passport recognizes the two types of citizenship defined in federal statutory law. On the inside cover of the passport it says the following. Note the phrase "citizen/national", which means "citizen OR national":

"The Secretary of State of the United States of America hereby request all whom it may concern to permit the citizen/national of the United States named herein to pass without delay or hindrance and in case of need to give all lawful aid and protection"

4. Below are some cites that establish the foreign relationship between the state and federal government for the purposes of legislative jurisdiction:

Foreign States: "Nations outside of the United States... Term may also refer to another state: i.e. a sister state. The term 'foreign nations', ...should be construed to mean all nations and states other than that in which the action is brought; and hence, one state of the Union is foreign to another, in that sense."
[Black's Law Dictionary, 6th Edition, p. 648]

Foreign Laws: "The laws of a foreign country or sister state."
[Black's Law Dictionary, 6th Edition, p. 647]

"Generally, the states of the Union sustain toward each other the relationship of independent sovereigns or independent foreign states, except in so far as the United States is paramount as the dominating government, and in so far as the states are bound to recognize the fraternity among sovereignties established by the federal Constitution, as by the provision requiring each state to give full faith and credit to the public acts, records, and judicial proceedings of the other states..."
[81A Corpus Juris Secundum (C.J.S.), United States, §29, legal encyclopedia]

"It is no longer open to question that the general government, unlike the states, Hammer v. Dagenhart, 247 U.S. 251, 275, 38 S.Ct. 529, 3 A.L.R. 649, Ann.Cas. 1918E 724, possesses no inherent power in respect of the internal affairs of the states; and emphatically not with regard to legislation. The question in respect of the inherent power of that government as to the external affairs of the Nation and in the field of international law is a wholly different matter which it is not necessary now to consider.
[Carter v. Carter Coal Co., 298 U.S. 238, 56 S.Ct. 855 (1936)]

5. The sole function of the federal government of the United States is to handle FOREIGN affairs with other countries, but it has no jurisdiction within states of the Union, including taxation. All of its revenues must derive only from the external affairs over which it has exclusive legislative jurisdiction. The rulings below occurred AFTER the passage of the Sixteenth Amendment and still limit the federal government exclusively to external matters in relation to states of the Union.

"The States, after they formed the Union, continued to have the same range of [INTERNAL] taxing power which they had before, barring only duties affecting exports, imports, and on tonnage [which all deal with FOREIGN/EXTERNAL commerce only]. 2 Congress, on the other hand, to lay taxes in order 'to pay the Debts and provide for the common Defence and general Welfare of the United States', Art. 1,

Affidavit of Citizenshi

DOCH 361061

11/27/2012 01:09 PM Page: 112 of 178

AFF R: \$10.00 J. C. Sloan, Mckinley County



DOCH 361076

11/27/2012 04:15 PM Page: 113 of 183
AFF R: \$10.00 J. C. Sloan, Mckinley County

Page: 2015 of 2782

MISC

09/26/2022 03:35:37 PM Receipt #: 22-9381
Rec Fee: \$30.00 Darrell James Hill
Gila County, Az, Sadie Jo Bingham, Recorder

2006

AFFIDAVIT OF CITIZENSHIP, DOMICILE, AND TAX STATUS

Sec. 8, U.S.C.A. Const., can reach every person and every dollar in the land with due regard to Constitutional limitations as the method of laying taxes." (Graves, V. People of State of New York, 306 U.S. 466 (1939))

"The difficulties arising out of our dual form of government and the opportunities for differing opinions concerning the relative rights of state and national governments are many; but for a very long time this court has steadfastly adhered to the doctrine that the taxing power of Congress does not extend to the states of their political subdivisions. The same basic reasoning which leads to that conclusion, we think, requires like limitation upon the power which springs from the bankruptcy clause. United States v. Butler, supra."

[Ashton v. Cameron County Water Improvement District No. 1, 298 U.S. 513, 56 S.Ct. 892 (1936)]
Congress is authorized to lay and collect taxes, and to pay the debts, and provide for the common defence and general welfare of the United States. This does not interfere with the power of the States to tax [internally] for the support of their own governments; nor is the exercise of that power by the States [to tax INTERNALLY], an exercise of any portion of the power that is granted to the United States [to tax EXTERNALLY]. In imposing taxes for state purposes, they are not doing what Congress is empowered to do. Congress is not empowered to tax for those purposes which are within the exclusive province of the States. When, then, each government exercises the power to taxation, neither is exercising the power of the other. But, when a State proceeds to regulate commerce with foreign nations, or among the several States, it is exercising the very power that is granted to Congress, [22 U.S. 1, 200] and is doing the very thing which Congress is authorized to do. There is no analogy, then, between the power of taxation and the power of regulating commerce."

[Gibbons v. Ogden, 22 U.S. 1 (1824)]

"It will contribute to the elucidation of the question if we first consider the differences between the power of the federal government in respect of foreign or external affairs and those in respect of domestic or internal affairs. That there are differences between them, and that these differences are fundamental, may not be doubted. The two classes of powers are different, both in respect of their origin and their nature. The broad statement that the federal government can exercise no power except those specifically enumerated in the Constitution, and such implied power as are necessary and proper to carry into effect the enumerated power, is categorically true only in respect of our internal affairs. In that field, the primary purpose of the Constitution was to carve from the general mass of legislative powers then possessed by the states such portions as it was thought desirable to vest in the federal government, leaving those not included in the enumerations still in the states. Carter v. Carter Coal Co., 298 U.S. 238, 294, 56 S.Ct. 855, 865. . . ."

The Union existed before the Constitution, which was ordained and established among other things to form a more perfect Union. Prior to that event, it is clear that the Union, declared by the Articles of Confederation to be perpetual, was the sole possessor of external sovereignty, and in the Union it remained without change save in so far as the Constitution in express terms qualified its exercise. The Framers' Convention was called and exerted its powers upon the irrefutable postulate that though the states were several their people in respect of foreign affairs were one."

[United States v. Curtis-Wright Export Corporation, 299 U.S. 304 (1936)]

6. The states of the Union are "foreign" to federal legislative jurisdiction, because, as the U.S. Supreme Court held above, they are not subject to it. This is a result of what is called the "Separation of Powers Doctrine", which was explained by the Supreme Court as follows:

"... the Constitution divides authority [legislative jurisdiction] between federal and state governments for the protection of individuals. State sovereignty is not just an end in itself. "Rather, federalism secures to citizens the liberties that derive from the diffusion of sovereign power." Coleman v. Thompson, 501 U.S. 722, 759 (1991) (BLACKMUN, J., dissenting). "Just as the separation and independence of the coordinate branches of the federal government serve to prevent the accumulation of excessive power in any one branch, a healthy balance of power between the States and the federal Government will reduce the risk of tyranny and abuse from either front." Gregory v. [505 U.S. 144, 182] Ashcroft, 501 U.S. at 458. See The Federalist No. 51, p. 323. (C. Rossiter ed. 1961)."

[New York v. United States, 505 U.S. 144 (1992)]

2022-011769 MISC Page: 2016 of 2782
09/26/2022 03:35:37 PM Receipt #: 22-9381
Rec Fee: \$90.00 Darrell James Hill
Gila County, Az, Sadie Jo Bingham, Recorder

2022

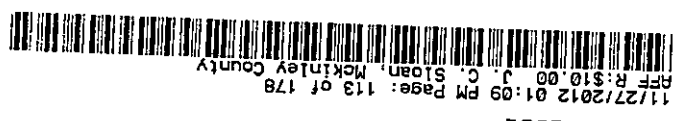

DOCH 361061

DOCH 361076

AFFIDAVIT OF CITIZENSHIP, DOMICILE, AND TAX STATUS

7. The federal government has no legislative power outside of its "territory".
"Judge Story, in his treatise on the Conflicts of Laws, lays down, as the basis upon which all reasonings on the law of comity must necessarily rest, the following maxims: First, 'that every nation [or state] possesses an exclusive sovereignty and jurisdiction within its own territory'; secondly, 'that no state or nation can by its laws directly affect or bind property out of its own territory, or bind persons not resident therein, whether they are natural born subjects or others.'
The learned judge then adds: 'From these two maxims or propositions there follows a third, and that is that whatever force and obligation the laws of one country have in another depend solely upon the laws and municipal regulation of the latter; that is to say, upon its own proper jurisdiction and polity, and upon its own express or tacit [voluntary] consent.' Story on Conflict of Laws §23.
[Baltimore & Ohio Railroad Co. v. Chambers, 73 Ohio St. 16; 76 N.E. 91; 11 L.R.A., 1012 (1905)]

8. The states of the Union are NOT "territory" of the federal government. They are instead INDEPENDENT and SOVEREIGN states:

86 Corpus Juris Secundum (C.J.S.) Legal Encyclopedia, Territories:
"§1. Definitions, Nature, and Distinctions
"The word 'territory,' when used to designate a political organization has a distinctive, fixed, and legal meaning under the political institutions of the United States, and does not necessarily include all the territorial possessions of the United States, but may include only the portions thereof which are organized and exercise governmental functions under act of congress."
"While the term 'territory' is often loosely used, and has even been construed to include municipal subdivisions of a territory, and 'territories of the " United States is sometimes used to refer to the entire domain over which the United States exercises dominion, the word 'territory,' when used to designate a political organization, has a distinctive, fixed, and legal meaning under the political institutions of the United States, and the term 'territory' or 'territories' does not necessarily include only a portion of the portions thereof which are organized and exercise government functions under act of congress. The term 'territories' has been defined to be political subdivisions of the outlying domain of the United States, and in this sense the term 'territory' is not a description of a definite area of land but of a political unit governing and being governed as such. The question whether a particular subdivision or entity is a territory is not determined by the particular form of government with which it is, more or less temporarily, invested."
"Territories' or 'territory' as including 'state' or 'states.'" While the term 'territories of the 'United States may, under certain circumstances, include the states of the Union, as used in the federal Constitution and in ordinary acts of congress "territory" does not include a foreign state.
"As used in this title, the term 'territories' generally refers to the political subdivisions created by congress, and not within the boundaries of any of the several states."

9. States of the Union retain their essential character as independent nations and foreign countries with respect to the federal government except in the matter of EXTERNAL affairs delegated by them to the Federal Government in their corporate capacity as the "United States of America";

"The States between each other are sovereign and independent. They are distinct and separate sovereignties, except so far as they parted with some of the attributes of sovereignty by the Constitution. They continue to be nations, with all their rights, and under all their national obligations, and with all the rights of nations in every particular, except in the surrender by each to the common purposes and objects of the Union, under the Constitution. The rights of each State, when not so yielded up, remain absolute."
[Bank of Augusta v. Earle, 38 U.S. (13 Pet.) 519; 10 L.Ed. 274 (1839)]

"In determining the boundaries of apparently conflicting powers between states and the general government, the proper question is, not so much what has been, in terms, reserved to the states, as what has been, expressly or by necessary implication, granted by the people to the national government; for each state possesses all the powers of an independent and sovereign nation, except so far as they have been ceded away by the constitution. The federal government is but a creature of the people of the states, and, like an agent appointed for definite and specific purposes, must show an express or necessarily implied authority in the charter of its appointment, to give validity to its acts."

2022-011769
09/26/2022 03:35:37 PM
Rep Fee: \$30.00
Gila County, Az

MISC
Page: 2017 of 2782
Record #: 22-9981
James H. Bingham, Recorder
Darrell Jo Bingham, Recorder

AFFIDAVIT OF CITIZENSHIP, DOMICILE, AND TAX STATUS

[People ex re. Atty. Gen V. Naglee, 1 Cal 234 (1850)]

10. A human being (but NOT "person") who is born in a state of the Union, which is outside of federal exclusive legislative jurisdiction, is called a "national". A person who is a "national" is subject to the "political jurisdiction" but not the "legislative jurisdiction" of their mother country because they are outside of the territorial reach of its general laws, because the Congress cannot write any law that governs what happens with states of the Union, as the above citations indicate (see, for instance, Carter v. Carter Coal Co., 298 U.S. 238, 56 S.Ct. 855, (1936)). The reason is that the states and the people in them are SOVEREIGN, and their creation, the federal government, cannot be greater than its Creator, which is the states and the people in them. The federal government is a SERVANT to the states, not their master: the equivalent of an independent contract that handles EXTERNAL affairs only. This was confirmed by the Federalist Papers, which were written prior to the ratification of the Constitution by the states of the Union in 1789:

"No legislative act [of Congress] contrary to the Constitution can be valid. To deny this would be to affirm that the deputy (agent) [which is the federal government] is greater than his principal [the States and the people in them]; that the servant is above the master; that the representatives of the people are superior to the people; that men, acting by virtue of powers may do not only what their powers do not authorize, but what they forbid...[text omitted] It is not otherwise to be supposed that the Constitution could intend to enable the representatives of the people to substitute their will to that of their constituents. It is far more rational to suppose, that the courts were designed to be an intermediate body between the people and the legislature, in order, among other things, to keep the latter within the limits assigned to their authority. The interpretation of the laws is the proper and peculiar province of the courts. A Constitution is, in fact, and must be regard by judges, as fundamental law. If there should happen to be an irreconcilable variance between the two, the Constitution is to be preferred to the statute."
[Alexander Hamilton, Federalist Paper # 78]

11. It is absurdly ridiculous to demand from the submitter a federal statute that confers but NOT defines citizenship status of a person born outside of federal jurisdiction. The laws of the States of the Union, and not federal law, govern the citizenship status of people born within their jurisdiction. States of the Union have exclusive and "plenary" jurisdiction to determine the status of people born with their jurisdiction and they have never yielded that authority to the federal government either in the Constitution or in any subsequent amendment or enactment. To conclude otherwise is to admit that states of the Union have NO SOVEREIGNTY, because the federal government could just pass a law to literally STEAL all of their citizens. If the federal government had jurisdiction to pass a law that allowed them to STEAL all citizens of the states, then the states would be left with not one to govern!

12. Congress has the power to "naturalize" people coming into America, and when they do this, these people become statutory "nationals" and constitutional but not statutory "Citizens".

"Provision of Nationality Act of 1940 that a person becoming a national by naturalization shall lose his nationality by residing continuously for three years in territory of a foreign state, being practically identical to its successor, which was condemned by United States Supreme Court as discriminatory, would have been invalid as a congressional attempt to expatriate regardless of intent."
[United States v. Lucienne D'Hotelle, 558 F.2d 37 (1976)]

The statutory definition of "naturalization" confirms that in America, naturalization means conferring the character of a statutory "national" and not a statutory "citizen":

8 U.S.C. §1101(a)(23) naturalization defined

(a)(23) The term "naturalization" means the conferring of nationality [NOT "citizen" or "U.S. citizen" status, but "nationality", which means "national"] of a state [of the Union] upon a person after birth, by any means whatsoever.

[NOTE: Compare with the definition of "expatriation"]

"The power of naturalization, vested in congress by the constitution, is a power to confer citizenship, not a power to take it away. 'A naturalized citizen,' said Chief Justice Marshall, 'becomes a member of the society, possessing all the rights of a native citizen, and standing, in the view of the constitution, on the footing of a native. The constitution does not authorize congress to enlarge or abridge those rights. The simple power of the national legislature [over citizenship] is to prescribe a uniform rule of naturalization, and the exercise of this power exhausts it, so far as respects the individual."

DOC# 361076

11/27/2012 04:15 PM Page: 116 of 183
AFF R:\$10.00 J. C. Sloan, McKinley County

Page: 2018 of 2782

2022-011769 MISC
09/26/2022 03:35:37 PM Receipt #: 22-9381
Rec Fee: \$30.00 Darrell James Hill
Gila County, Az, Sadies Jo Bingham, Recorder

DOC# 361061

11/27/2012 01:09 PM Page: 115 of 178
AFF R:\$10.00 J. C. Sloan, McKinley County

AFFIDAVIT OF CITIZENSHIP, DOMICILE, AND TAX STATUS

[U.S. v. Wong Kim Ark, 169 U.S. 649 (1898)]

13. A human being who is a "national" but not a "citizen" under federal statutory law is identified as a "citizen of the United States" within the Fourteenth Amendment to the U.S. Constitution. The United States Constitution confines itself to describing citizenship within the states and the Union and therefore, the term "United States", as used within the Constitution, means the collective states of the Union [called "The United States of America"] and EXCLUDES federal territories and possessions and the District of Columbia. The "United States" mentioned in the Constitution and the "United States" mentioned in most federal enactments are two completely different and mutually exclusive places. This is VERY important and fundamental to understanding the Separation of Powers Doctrine.

14. If the recipient of this form disagrees with any of the facts stated in this section, then please provide the following within thirty calendar days or forever be stopped from challenging these statements of fact:

14.1. Written evidence signed under penalty of perjury (not opinion, but enacted positive law, regulations, and Supreme court rulings but not those of lower courts) of same.

The remainder of this is intentionally left blank.

2022-011769 MISC Page: 2019 of 2782
09/28/2022 03:35:37 PM Receipt #: 22-9381
Rec Fee: \$30.00 Darrell James Hill
Gila County, Az, Sadie Jo Bingham, Recorder



Non Official Copy

Affidavit of Citizenship,

DOCH 361061

11/27/2012 01:09 PM Page: 116 of 178
AFF R: \$10.00 J. C. Sloan, McKinley County



DOCH 361076

11/27/2012 04:15 PM Page: 117 of 188
AFF R: \$10.00 J. C. Sloan, McKinley County



AFFIDAVIT OF CITIZENSHIP, DOMICILE, AND TAX STATUS

SECTION 1: SUBMITTER INFORMATION

1. Name	Beverly Jean, Romero- Hill		
2. Mailing Address (NOT a domicile)	28 Hilltop Court, HC 62 Box 771		
3. City	Ramah	4. State	New Mexico
5. Zip	[87321]	6. Country	The United States of America
7. Phone	505.783.2499	8. Email	dihill4yah@yahoo.com
9. Date of Birth:	1958 July 15	10. Place of Birth:	New Mexico
11. citizenship:	Nonresident alien NON-Individual: See explanation (following)	12. DOMICILE:	Transient Foreigner: See explanation (following)

11. CITIZENSHIP

I am a Constitutional but not statutory "Citizen": "national" but not "citizen" under federal law pursuant to 8 U.S.C. §1101(a)(21) and 8 U.S.C. §1452. Born in state of the Union and a "nonresident" (per 26 U.S.C. 7701(b)(1)(B)) but NOT an "alien" (per 26 U.S.C. 7701(b) (1)(A) or "Individual" (Per 26 CFR §1.441-1(c)(3)); "Stateless Person" as per Newman-Green v. Alfonso Larrain, 490 U.S. 826 (1989); Constitutional diversity of citizenship pursuant to U.S. Const. Art. III, Section 2, but NOT statutory diversity pursuant to 28 U.S.C. §1332. Rebut the preceding if you disagree within 30 days or you stipulate it as truth.

12. DOMICILE:

I have chosen my domicile as Not within any government on earth.

I choose not to politically associate with any group or government on earth for my protection. The First Amendment to the Constitution protects my right of freedom from compelled association. I am a "transient foreigner" but not an "inhabitant" of the place where I live.

Choice of my domicile and becoming a taxpayer require my consent. Rebut the proceeding within 30 days if you disagree or forever be stopped from later challenging it.

13. FEDERAL FRANCHISES

13.1. Submitter is not subject to the Internal Revenue Code Subtitle A "trade or business" franchise/excise tax. Also called "income tax": "trade or business is defined in 26 U.S.C. §7701(a)(26) as "function of a public office" in the government. Those not engaged are a "foreign estate" pursuant to 26 U.S.C. §7701(a)(31).

Rebut the proceeding within 30 days if you disagree or forever be held in default, estoppel and laches.

PRIVATE RECIPIENTS OF THIS FORM: You are warned that you may NOT use any of the information provided by the Submitter of this form or any of the attached forms to submit to the government or for ANY commercial purpose. This means you may not use any of the information provided to prepare or submit any IRS information return, such as forms W-2, 1042S, 1098, 1099, K-1, etc. and that if you do you risk criminal prosecution if you do under the provisions of 26 U.S.C. §§7206, 7207, 18 U.S.C. §654, and 18 U.S.C. §912. This document also constitutes an indemnification of all personal liability of the private recipient for failure to withhold or report. Submitter agrees to accept all legal consequences for following the context of this form and to become the Substitute Defendant in an action against the Private Recipient for following the requirements of this affidavit. This indemnification does NOT apply to government recipients.

GOVERNMENT RECIPIENTS OF THIS FORM: You are hereby legally notified that any information returns you may have received connected with me, such as W-2, 1042S, 1098, and 1099, are FALSE and FRAUDULENT and this submission constitutes a formal request to correct the false reports and criminally prosecute the submitter to 26 U.S.C. §§7206, 7207, 18 U.S.C. §654, and 18 U.S.C. §912 and civilly prosecute pursuant to 26 U.S.C. §7434 and 31 U.S.C. §3729. Any numbers associated with these reports are provided under duress and are not "Social Security Numbers" as defined in 20 CFR §422.104 but rather PRIVATELY issued "Nontaxpayer Identification Numbers" which are protected by copyright and private license agreement and may NOT be stored in any government computer system or used for ANY commercial purpose without violating the license agreement.

13.2. Submitter is a Social Security non-volunteer (See 42 U.S.C. Chapter 7). Any application on file are fraudulent and nullity for any one or more of the following reasons: 1. Never personally made application and therefore nonbinding; 2. Never consented to participate; 3. Cannot lawfully consent because not domiciled on federal territory and not a "U.S. citizen" per 8

2022-011769 MISC Page: 2020 of 2782

09/26/2022 03:35:37 PM Receipt #: 22-9381

James Hill Darrell James Hill Sadie Jo Bingham Recorder Gila County, Az.

DOCH 361076

11/27/2012 04:15 PM Page: 118 of 183
AFF R:\$10.00 J. C. Sloan, McKinley County

omicle, i

DOCH 361061

11/27/2012 01:09 PM Page: 117 of 178
AFF R:\$10.00 J. C. Sloan, McKinley County

AFFIDAVIT OF CITIZENSHIP, DOMICILE, AND TAX STATUS

U.S.C. §1401 or a "permanent resident" at the time of application in violation of 20 CFR §422.104; 4. Am not a fiduciary acting within any capacity contract with the federal government;

Date that UNLAWFUL SSA participation was retroactively terminated was May 22, 2006 (Date SSA Form 521 was mailed to SSA and IRS).

- 13.3. Submitter is not a Federal elected or appointed "public officer".
- 13.4. Submitter is not an "employee" as defined in 26 U.S.C. §3401(c) and 26 CFR §31.3401(c)-1.
- 13.5. Submitter has a State-issued driver's license. Corporate (not de jure) State name: Arizona
- 13.6. Submitter has a State issued marriage license.
- 13.7. Submitter does not possess an Attorney license (Admitted to practice by state-supreme Court).
- 13.8. Submitter has no lawful federal government identifying number.

WARNING: You may not use any government issued identifying number in connection with the Submitter, such as a Social Security Number (SSN) as defined in 20 CFR 422.103(d), Taxpayer Identification Number (TIN) as defined in 26 U.S.C. 6109, or Employer Identification Number (EIN) as defined in 26 U.S.C. 6109.

Submitter:

1. Would be violating the law to either request or use a Taxpayer Identification Number.
2. Is not required to have or to use a Social Security Number or Taxpayer Identification Number pursuant to 31 CFR §103.34(a)(3)(x) and 31 CFR §306.10, Note 2.
3. Does not participate and is not lawfully eligible to participate in Social Security or the "trade or business" excise taxable franchise described in 26 U.S.C. Subtitle A.
4. Is not an "alien" for which an Individual Taxpayer Identification Number may lawfully be used pursuant to 26 CFR §301.6109-1(d)(3). Nonresident aliens are NOT "aliens" are not equivalent. A human being who is a "national" can be a "nonresident alien" with being an "alien". See 26 U.S.C. §7701(b)(1)(A) and 26 U.S.C. §7701(b)(1)(B).
5. May not lawfully use or possess any government identifying number because it is "public property" which belongs to the government pursuant to 20 CFR §422.103(d). Only "public officers" on official business may lawfully use public property, and only in strict accordance with law for the benefit of the government and not them as private individuals.
6. Is appearing as a private person and not a public officer. If you compel me to use a government identifying number, you are an accessory to criminal conversion of private property to a public use and a public purpose if you connect me or my assets with a public number in violation of 18 U.S.C. § 654. You could end up in jail for ten years if you put an identifying number on any records pertaining to me or my property, assets, or my earnings from PRIVATE employment.
7. Has been a victim of identity theft, compelled association, and conversion by the government and its agents in banks and financial institutions in the past by unlawfully and involuntarily connecting them with knowingly false and fraudulent identifying numbers in criminal violation of 18 U.S.C. §1028(a)(7), 18 U.S.C. §1028A, and a civil violation of 42 U.S.C. §408(a)(7) and 42 U.S.C. §405(c)(2)(C)(i). She would like to prevent a recurrence of this behavior again.
8. Will file a criminal complaint in connection with the use of any government issued identifying number connected with his exclusively PRIVATE life, property, and liberty and vociferously prosecute all those who unlawfully compel him to use a knowingly false number or any number at all in order to obtain any service or product in violation of 42 U.S.C. §408.

WARNING: Any Social Security Number or Taxpayer Identification Number you have on file is FALSE and must be removed from your records. Failure to abide by this absolute requirement of law is a criminal violation of 18 U.S.C. §1028(a)(7); 18 U.S.C. §1028A, and a civil violation of 42 U.S.C. §408 and 42 U.S.C. §405(c)(2)(C)(i).

14. DOMICILE AND RESIDENCE

1. My domicile and NOT "residence" is that indicated earlier on Item 12 above.
2. My domicile is outside the statutory but not constitutional "United States" and outside of federal territory. The Term "statutory United States" includes all statutory definitions of "United States" within any act of Congress.
3. I am not a statutory "resident". All "residents" are statutory "aliens" per 26 U.S.C. §7701(b)(4).
4. I DO NOT have a statutory "residence" anywhere within the statutory "United States" per 26 CFR §1.871-2(b) because I am not a statutory "alien".

DOCH 361076

11/27/2012 04:15 PM Page: 119 of 183
AFF R:\$10.00 J. C. Sloan, McKinley County



Domicile,

DOCH 361061

11/27/2012 01:09 PM Page: 118 of 178
AFF R:\$10.00 J. C. Sloan, McKinley County



2022-011769 MISC Page: 2021 of 2782
09/25/2022 03:35:37 PM Receipt # 22-9381
Rec Fee: \$30.00 Darrell James Hill, Recorder
Gila County, Az, Sadie Jo Bingham, Recorder



2012

AFFIDAVIT OF CITIZENSHIP, DOMICILE, AND TAX STATUS

If you believe that the term "residence" includes the domicile of those who are non-citizen nationals, nonresident alien NON-individuals, please produce a statute that expressly includes this status within the meaning of the term "residence".

15. TAX WITHHOLDING LEGAL REQUIREMENTS

5. **WARNING:** You may not lawfully withhold any amount from proceeds due to me. The remainder of this section provides legally admissible evidence proving why this is.

6. Your withholding is ONLY on "wages" as legally defined in 26 U.S.C. §3401. The earnings of nonresident alien NON-individuals not engaged in a "trade or business" as legally defined are excluded from "wages" per 26 U.S.C. §3401(a)(6) and 26 U.S.C. §3401(a)(11) and therefore may not lawfully become the subject of tax withholding. If you withhold, you will therefore be guilty of the following crimes:

6.1. 18 U.S.C. §654: Conversion of private property to a "public use" and a "public office". You are converting my PRIVATE proceeds as a class member into a public purpose and a "public office" by fraudulently and falsely connecting same with a "trade or business".

6.2. 18 U.S.C. §201: Bribery of public officials and witnesses. You are bribing public officials who will receive the money you STOLE from me in violation of the law. The punishment is a fine and up to 15 years in jail. I remind you that all tax withholdings are classified as "gifts" by the IRS. See IRS Document 6209, pp. 4-1 and 4-2, which identify W-2 forms as "Estate and gift taxes". All tax withholdings are "gifts" to public officials that also constitute bribes.

6.3. 18 U.S.C. §1956(a)(1)(A)(ii): Money laundering. You are laundering unlawfully withheld proceeds. The punishment is a fine up to \$500,000 and imprisonment for up to twenty years.

7. IRS Publication 515 indicates that nonresident alien individuals who give you IRS form W-8BEN are exempt from backup withholding. This requirement is also found in 26 U.S.C. § 3401(a)(6) or 26 CFR §31.3401(a)(6)-1(b). This Affidavit serves the equivalent of IRS Form W-8BEN because IRS doesn't have a form for those who are "nonresident aliens" but who are not "individuals", "persons", or "taxpayers".

*"Foreign persons who provide Form W-8BEN, Form W-8ECI, or Form W-8EXP (or applicable documentary evidence) are exempt from backup withholding and Form 1099 reporting."
[IRS Publication 515, Year 2001, p.3]*

8. You **MAY NOT** lawfully tamper with, reject, redact any portion of, or alter any withholding form that I give you. You must accept them AS IS and may not lawfully threaten me to change them. If you do, you could be prosecuted for extortion.

*"The employer is not authorized to alter the form or to dishonor the employee's claim. The certificate goes into effect automatically in accordance with certain standards enumerated in §3402(f)(3)."
[U.S. v. Malinowski, 347 F.Supp. 347 (1972)]*

9. The proceeds connected with our relationship do not constitute "income" and therefore cannot be the subject of any tax or withholding or reporting within the Internal Revenue Code. The only definition of "income" in the Internal Revenue Code is found in 26 U.S.C. §643(b) and it includes ONLY the earnings of a trust or estate. I am not representing a domestic trust or estate. My earnings and my entire estate instead are a "foreign estate" pursuant to 26 U.S.C. §7701(a)(31).

10. Any earnings that result from our relationship do not originate from "sources within the United States". The term "United States" is defined below.

If you dispute this definition, please provide the definition that expressly identifies states of the Union as being included in the meaning of "United States".

TITLE 26 > Subtitle F > CHAPTER 79 > Sec. 7701.

Sec. 7701. - Definitions

(a) Definitions

(9) United States

The term "United States" when used in a geographical sense includes only the States and the District of Columbia.

(10) State

Romero-Hill Affidavit of Citizenship, Domicile,

DOCH 361061

11/27/2012 01:09 PM Page: 119 of 178
AFF R:\$10.00 J. C. Sloan, McKinley County



2022-011769 MISC Page: 2022 of 2782
09/26/2022 03:35:37 PM Receipt #: 22-9381
Rec Fee: \$30.00 Darrell James Hill
Gila County, Az, Sadie Jo Bingham, Recorder

DOCH 361076
11/27/2012 04:15 PM Page: 120 of 183
AFF R:\$10.00 J. C. Sloan, McKinley County

2013

AFFIDAVIT OF CITIZENSHIP, DOMICILE, AND TAX STATUS

The term "State" shall be construed to include the District of Columbia, where such construction is necessary to carry out provisions of this title.

TITLE 4 – FLAG AND SEAL, SEAT OF GOVERNMENT, AND THE STATES CHAPTER 4 – THE STATES

Sec. 1210. Same; definitions

(d) The term "State" includes any Territory or possession of the United States.

"Expression unius est exclusio alterius. A maxim of statutory interpretation meaning that the expression of one thing is the exclusion of another. Burgin v. Forbes, 293 Ky. 456, 169 S.W.2d 321, 325; Newblock v. Bowles, 170 Okl. 487, 40 P.2d 1097, 1100. Mention of one thing implies exclusion of another. When certain persons or things are specified in a law, contract, or will, an intention to exclude all others from its operation may be inferred. Under this maxim, if statute specifies one exception to a general rule or assumes to specify the effects of a certain provision other exceptions of effects are excluded."

[Black's Law Dictionary, Sixth Edition, p. 581]

11. The financial transactions likely to result from relationship are excluded from (not "subject to" but not "exempt") taxation pursuant to the following authorities and therefore not subject to withholding:
- 11.1. 26 U.S.C. § 861(a)(3)(C)(i): Earning from labor of "nonresident aliens" not engaged in a "trade or business" and working in the "United States" is not deemed to be income from sources within the "United States".
 - 11.2. 26 U.S.C. § 3401(a)(6): Nonresident aliens do not earn "wages".
 - 11.3. 26 U.S.C. § 1402(b): Nonresident aliens do not earn "self-employment income".
 - 11.4. 26 U.S.C. § 864(b)(1)(A): Earning of "nonresident aliens" working for foreign employers such as private employers do not have earnings associated with a "trade or business in the United States"
 - 11.5. 26 CFR § 31.3401(a)(6)-1(b): Remuneration of nonresident aliens outside the "United States" is not subject to taxation.
 - 11.6. 26 CFR § 1.872-2(f): Earning of nonresident aliens outside "United States" do not constitute "gross income".
 - 11.7. 26 CFR § 1.871-7(a)(4): Nonresident aliens not engaged in a "trade or business" earn no "gross income".
12. Tax withholding is only appropriate for those having a tax liability. A nonresident alien NON-individual such as the submitter with no "income" or earning from "sources within the United States" under 26 U.S.C. § 871 can have no tax liability. If you think you, as a private employer or private institution constitutes a "source within the United States", then why did the IRS Internal Revenue Manual say the following and where are the states of the Union included in "United States" as defined above?:

IRM 5.14.10.2 (09-30-2004)
Payroll Deduction Agreements

2. Private employers, states, and political subdivisions are not required to enter into payroll deduction agreements. Taxpayers should determine whether their employers will accept and process executed agreements before agreements are submitted for approval or finalized.
[<http://www.irs.gov/irm/part5/ch14s10.html>]

13. You can only be an "employer" if I am an "employee", according to 26 U.S.C. § 3401(d). I am NOT an "employee", because all "employees" are "public officers" engaged in a "trade or business" who work for the United States government as the equivalent of "temps" or "Kelly Girls" on loan to private employers such as you. I DO NOT consent to act in such capacity, and therefore you cannot be an "employer" in the context of me"

26 CFR § 31.3401(c)-1 Employee:

"...the term [employee] includes [is limited to] officers and employees, whether elected or appointed, of the United States, a [federal] State, Territory, Puerto Rico or any political subdivision, thereof, or the District of Columbia, or any agency of instrumentality of any one of more of the foregoing. The term 'employee' also includes an officer of a corporation."

26 U.S.C. § 3401(c) Employee

For purpose of this chapter, the term "employee" includes [is limited to] an officer, employee, or elected official of the United States, a State, or any political thereof, or the District of Columbia, or any agency

Romero-Hill Affidavit of Citizenship, Domicile,

DOC# 361061

11/27/2012 01:09 PM Page: 120 of 178
AFF R:\$10.00 J. C. Sloan, McKinley County

2022-011769 MISC Page: 2023 of 2782
09/26/2022 03:35:37 PM Receipt #: 22-9381
Rec Fee: \$30.00 Darrell James Hill
Gila County, Az, Sadie Jo Binsham, Recorder

DOC# 361076

11/27/2012 04:15 PM Page: 121 of 183
AFF R:\$10.00 J. C. Sloan, McKinley County

AFFIDAVIT OF CITIZENSHIP, DOMICILE, AND TAX STATUS

or instrumentality of any one or more of the foregoing. The term "employee" also includes an officer of a corporation.

8 Federal Register, Tuesday, September 7, 1943, §404.104, pg 12267

Employee: "The term employee specifically includes officers and employees whether elected or appointed, of the United States, a state, territory, or political subdivision thereof or the District of Columbia or any agency or instrumentality of any one or more of the foregoing."

If you disagree with this item, please rebut the foregoing within 30 days or be held in default and estoppels to challenge later.

14. You are only liable to withhold if you are an "employer" and if I receive "wages". 26 CFR 31.3403-1, 26 CFR §31.3111-4, 26 CFR §3102-1(c). The only way I can receive "wages" is to sign a contract called a W-4 absent duress consenting to call what proceeds I receive "wages" as legally defined but not commonly understood. If I don't sign the contract, then I don't earn "wages" subject to any withholding or reporting:

"Every man has a natural right to the fruits of his own labor, is generally admitted; and no other person can rightfully deprive him of those fruits, and appropriate them against his will.."
[The antelope, 23 U.S. 66: 10 Wheat 66, 6 L.Ed. 268 (1825)]

"Included in the rights of personal liberty and the right of private property—partaking of the nature of each—is the right to make contracts for the acquisition of property. Chief among such contracts is that of personal employment, by which labor and other services are exchanged for money or other forms or property."

"...The right of a person to sell his labor upon such terms as he deems proper is, in its essence, the same as the right of the purchaser of labor to prescribe the conditions under which he will accept such labor from the person offering to sell it."

26 CFR §31.3401(a)-3 Amounts deemed wages under voluntary withholding agreements

(a) In general.

Notwithstanding the exceptions to the definition of wages specified in section 3401(a) and the regulations thereunder, the term "wages" includes the amounts described in paragraph (b)(1) of this section with respect to which there is a voluntary withholding agreement in effect under section 3402(p). References in this chapter to the definition of wages contained in section 3401(a) shall be deemed to refer also to this section (§31.3401(a)-3).

Title 26: Internal Revenue

PART 31—EMPLOYMENT TAXES AND COLLECTION OF INCOME TAX AT SOURCE

Subpart E—Collection of Income Tax at Source

§31.3402(p)-1 Voluntary withholding agreements

(a) In general.

An employee and his employer may enter into an agreement under section 3402(b) to provide for the withholding of income tax upon payments of amounts described in paragraph (b)(1) of §31.3401(a)-3, made after December 31, 1970. An agreement may be entered into under this section only with respect to amounts which are includible in the gross income of the employee under section 61, and must be applicable to all such amounts paid by the employer to the employee. The amount to be withheld pursuant to an agreement under section 3402(p) shall be determined under the rules contained in section 3402 and the regulations thereunder. See §31.3405(c)-1, Q&A-3 concerning agreements to have more than 20-percent Federal income tax withheld from eligible rollover distributions with the meaning

2022-011769 MISC Page: 2024 of 2782

09/26/2022 09:35:37 PM Receipt # 22-9381
Rec Fee: \$30.00 Darrell James Hill
Gila County, Az, Sadie Jo Bingham, Recorder

DOCH 361076

11/27/2012 04:15 PM Page: 122 of 183
AFF R: \$10.00 J. C. Sloan, McKinley County

DOCH 361061

11/27/2012 01:09 PM Page: 121 of 178
AFF R: \$10.00 J. C. Sloan, McKinley County

AFFIDAVIT OF CITIZENSHIP, DOMICILE, AND TAX STATUS

of section 402.

15. If I never give you an IRS form W-4 and thereby consent to call what proceeds I am due "wages" as defined in the Internal Revenue Code, then you can't lawfully withhold or report anything:

15.1. Everything that goes on the IRS form W-2 constitutes "wages" as legally defined and not commonly understood.

15.2. Tax withholding ONLY pertains to "wages" as legally defined and NOT all earnings. The U.S. Supreme Court confirmed this:

"We must reject in this case, as we have rejected in cases arising under the Corporation Excise Tax Act of 1909 (Doyle, Collector, v. Mitchells Brother Co., 247 U.S. 179, 38 Sup. Ct. 467, 62 L. Ed. --) the broad contention submitted on behalf of the government that all receipts—everything that comes in—are income with the proper definition of the term 'gross income.' And that the entire proceeds of a conversion of capital assets, in whatever form and under whatever circumstances accomplished, should be treated as gross income. Certainly the term 'income' has no broader meaning in the 1913 act than in that of 1909 (See Stratton's Independence v. Howbert, 231 U.S. 399, 416, 417 S., 34 Sup. Ct. 136), and for the present purpose we assume there is no difference in its meaning as used in the two acts."
[Southern Pacific Co., v. Lowe, 247 U.S. 330, 335, 38 S. Ct 540 (1918)]

15.3. If you are ordered by the IRS, et al., to withhold proceeds because I refuse to submit an IRS for W-4, then you must withhold and report ONLY on "wages" as statutorily defined and limited pursuant to the I.R.C. "trade or business" franchise agreement. I don't earn "wages" if I never consented to call them "wages" using a private contract called an IRS form W-4.

16. On the subject of unlawful withholding the Bible say the following. "Wages" as used below implies the ordinary and excludes the statutory definition:

"Woe to him who builds his house by unrighteousness
And his chambers by injustice,
Who [whether individual or government] uses his neighbor's service without wages
And give him nothing for his work
[Jer. 22:13, Bible, NKJV]

"Come now, you rich, weep and howl for your miseries that are coming upon you! Your riches are corrupted, and your garments are moth-eaten. Your gold and silver are corroded, and their corrosion will be a witness against you, and will eat your flesh like fire. You have heaped up treasure in the last days. **Indeed the wages of the laborers who mowed your fields, which you kept back by fraud, cry out; and the cries of the reapers have reached the ears of the Lord of Sabaoth.** You [business owner who control the purse of the workers] have lived on the earth in pleasure and luxury; you have fattened your hearts as in a day of slaughter. You have condemned, you have murdered the just, he does not resist you."
[James 5:1-6, Bible, NKJV]

"You shall not cheat your neighbor, nor rob him. **The wages of him who is hired shall not remain with you all night until morning.**
[Lev. 19:13, Bible, NKJV]

16. TAX REPORTING LEGAL REQUIREMENTS:

1. **WARNING:** It is a criminal offense to file information returns against any payments you make in connection with our relationship. Filing of false information returns carries severe civil and criminal penalties. Information returns include IRS Forms W-2, 1042S, 1098, and 1099.

I can only earn "wages" reportable on an IRS form W-2 if I am lawfully engaged in a "public office" in the U.S. Government as required by 26 U.S.C. §6041(a). Voluntarily signing a contract/agreement called an IRS form W-4 is the only way that a nonresident alien NON-individual not engaged in a "trade or business" can engage in such a "public office" per 26 CFR §31.3401(a)-3(a), and 26 CFR 31.3402(p)-1. Otherwise, it is a crime to impersonate a public officer in violation of 18 U.S.C. §912 to file an information return. If you file any kind of information return relating to me, you will be guilty of conspiracy to commit all the following crimes and civil infractions:

1.1. False information returns submitted in violation of 26 U.S.C. §7434. Punishment is all attorney fees plus twice the false amount reported.

Romero-Hill Affidavit of Citizenship, Domicile, i

DOCH 361061

11/27/2012 01:09 PM Page: 122 of 178
AFF R: \$10.00 J. C. Sloan, McKinley County

2022-0111769 MISC Page: 2025 of 2782

09/26/2022 03:35:37 PM Receipt #: 22-9381
Rec Fee: \$30.00 Darrell James Hill
Gila County, Az, Sadie Jo Bingham, Recorder

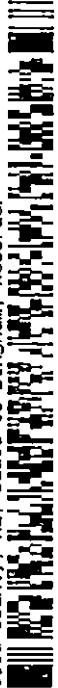

DOCH 361076

11/27/2012 04:15 PM Page: 123 of 183
AFF R: \$10.00 J. C. Sloan, McKinley County



2016



AFFIDAVIT OF CITIZENSHIP, DOMICILE, AND TAX STATUS

- 1.2. Impersonating a public officer in violation of 18 U.S.C. §912. Punishment is a fine and up to three years in jail. Only "public officers" can act as "taxpayers", and you are creating a false presumption that I am a "taxpayer" by filing false information returns.
- 1.3. Conversion of private property to a public use, public purpose, and public office as a "withholding agent" in violation of 18 U.S.C. §654.
- 1.4. Impersonating a public officer in violation of 18 U.S.C. §911. Punishment is a fine and up to three years in jail. Only *statutory* and not *constitutional* "U.S. citizens" can lawfully act as "public officers" engaged in a "trade or business" and I am NOT a statutory "U.S. citizen" pursuant to 8 U.S.C. §1401 but rather a non-citizen national.
- 1.5. False information returns in violation of 26 U.S.C. §7206. Punishment is up to a \$100,000 fine and 3 years in jail to file a false information return.
- 1.6. False information returns in violation of 26 U.S.C. §7207. Punishment is up to \$10,000 and 1 year in jail to submit a false information return.
- 1.7. Perjury in violation of 18 U.S.C. §1001 and 18 U.S.C. §1621. The IRS Forms W-3 and 1096 submitted with the information return is signed under penalty of perjury and verifies the accuracy of the accompanying information return. These forms are submitted as a government officer and agent called a "withholding agent" defined in 26 U.S.C. 7701(a)(16). Those forms are FRAUDULENT now that you have been notified that they are false and you willfully refuse to either stop filing the false report or correct the false reports already filed.

2. IRS Publication 515 indicates that nonresident aliens who give you IRS form W-8BEN are exempt for 1099 reporting. This document serves the equivalent purpose and is a superset of that form.

"Foreign persons who provide Form W-8BEN, Form W-8ECI, or Form W-EXP (or applicable documentary evidence) are exempt from backup withholding and Form 1099 reporting."
[IRS Publication 515, Year 2001, p3]

3. 26 U.S.C. §6041 says that only earnings connected with a "trade or business" may be reported on an information return such as IRS forms W-2, W-3, 1042-S, 1096, and 1099.

TITLE 26 > Subtitle F > CHAPTER 61 > Subchapter A > PART III > § 6041
§ 6041. Information at source

(a) Payments of \$600 or more

All persons engaged in a trade or business and making payment in the course of such trade or business to another person, of rent, salaries, wages, premiums, annuities, compensations, remunerations, emoluments, or other fixed or determinable gains, profits and income (other than payments to which section 6042 (a)(1), 6044 (a)(1), 6047 (e), 6049 (a), or 6050N (a) applies, and other than payments with respect to which a statement is required under the authority of section 6042 (a)(2), 6044 (a)(2), or 6045), of \$600 or more in any taxable year, or in the case of such payments made by the United States, the officers or employees of the United States having information as to such payments and required to make returns in regard thereto by the regulations hereinafter provided for, shall render a true and accurate return to the Secretary, under such regulations and in such form and manner and to such extent as may be prescribed by the Secretary, setting forth the amount of such gains, profits, and income, and the name and address of the recipient of such payment.

4. None of the proceeds connected with our relationship pertains to a "trade or business" as statutorily defined below, and therefore is not subject to reporting:

26 U.S.C. Sec. 7701(a)(26)

"The term 'trade or business' includes the performance of the functions of a public office."

5. The term "income" is defined in 26 U.S.C. §643(b), and only "income" may be reported. Since I am NOT an "estate or trust", I earn no reportable "income".

TITLE 26 > Subtitle A > CHAPTER 1 > Subchapter J > PART I > Subpart A > §643
§643. Definitions applicable to subparts A, B, C, and D

(b) Income

Romero-Hill Affidavit of Citizenship, Domicile,

DOCH 361061

11/27/2012 01:09 PM Page: 123 of 178
AFF R: \$10.00 J. C. Sloan, McKinley County



2022-011769 MISC Page: 2026 of 2782

09/26/2022 03:35:37 PM Receipt #: 22-9981

Rec Fee: \$30.00 Darrell James Hill

Gila County, Az. Sadie Jo Bingham, Recorder

DOCH 361076

11/27/2012 04:15 PM Page: 124 of 183

AFF R: \$10.00 J. C. Sloan, McKinley County

AFFIDAVIT OF CITIZENSHIP, DOMICILE, AND TAX STATUS

For purpose of this subpart and subparts B, C, and D, the term "income, when not preceded by the words "taxable", "distributable net", "undistributed net", or "gross", means that amount of income of the estate or trust for the taxable year determined under the terms of the governing instrument and the applicable local law. Items of gross income constituting extraordinary dividends or taxable stock dividends which the fiduciary, acting in good faith, determines to be allocable to corpus under the terms of the governing instrument and applicable local law shall not be considered income.

IRS Form 1042-S may only be prepared in the case of statutory "nonresident aliens" (per 26 U.S.C. §7701(b)(1)(B)) who have "income" from "sources within the statutory but not constitutional "United States" that is not connected with a "trade or business" and therefore constitutes "gross income" with the meaning of 26 U.S.C. §61. All such sources are expressly indicated in 26 U.S.C. §871(a). All of these sources are government payments. The transactions likely to occur between us are NOT government payments and are not listed in 26 U.S.C. §871(a), and therefore may not lawfully be reported.

SECTION 2: AFFIDAVIT OF TAX STATUS

Human being (but not statutory "Person") who signed this form hereby affirms under penalty of perjury from WITHOUT the statutory "United States" per 28 U.S.C. §1746(1) that:

1. Submitter has NO tax liability or "gross income" pursuant to 26 CFR §1.872-2(f), 26 CFR §1.871-1(a), and 26 U.S.C. §861(a)(C)(i) and therefore no need to deduct or withhold.
2. Submitter is not a statutory "taxpayer" as defined in 26 U.S.C. §7701(a)(14) and not subject to the revenue laws.

"Revenue Laws relate to taxpayers [instrumentalities, officers, employees, and elected officials of the Federal Government] and not to non-taxpayers [American Citizens/American Nationals not subject to the exclusive jurisdiction of the Federal Government and not engaged in the "trade or business" franchise as a public officer]. The latter are without their scope. No procedures are prescribed for non-taxpayers and no attempt is made to annul any of their Rights or Remedies in due course of law. With them [non-taxpayers] Congress does not assume to deal and they are neither of the subject nor of the object of federal revenue laws."

[Economy Plumbing & Heating v. U.S., 470 F.2d. 585 (1972)]

3. Submitter is not "exempt" or an "exempt individual" as defined in 26 U.S.C. §7701(b)(5) because one must otherwise be subject to the I.R.C. to be such a legal "person". Rather, Submitter is "not subject" to Internal Revenue Code Subtitle A franchise agreement and is a nonresident. Since IRS forms very deliberately do not have a block for "not subject" and are only for use by those who are "taxpayers", Submitter had to make his own form, THIS DOCUMENT, to avoid committing perjury on a government form in describing his status under penalty of perjury. Those who are "not subject" are described NOT as a "person", "individual", or "taxpayer", but simply as "foreign" or a "foreign estate" in 26 U.S.C. §7701(a)(31).

TITLE 26 > Subtitle F > CHAPTER 79 > § 7701 §7701. Definitions

(a) Definitions

(31) Foreign estate or trust

(A) Foreign estate

The term "foreign estate" means an estate the income of which, from sources without the United States which is not effectively connected with the conduct of a trade or business within the United States, is not includible in gross income under subtitle A.

4. Submitter is a "nonresident" as statutorily defined pursuant to 26 U.S.C. § 7701(b)(1)(B) but not a "nonresident alien individual". A "nonresident alien" is defined as one who is "neither a citizen nor a resident" of the "United States", which is exactly what an "American National", or national born in a state of the Union who is not domiciled on federal territory in the "United States" is. The only withholding form that a "nonresident" who is neither a statutory "alien" (per 26 U.S.C. §7701(b)(1)(A)) nor an "individual" (per 26 CFR §1.1441-1(c)(3) and 5 U.S.C. §2105(a)) and who is not engaged in federal franchises can fill out is a W-8BEN with block 3 modified to add the word "nontaxpayer" or "human being" to it. All statutory "taxpayers" and "individuals" are "aliens" per 26 CFR §1.1441-1(c)(3) and public officers in the national and not state government, and therefore submitter cannot check the "individual" block of the W-8BEN form without committing perjury. Even statutory "U.S. Citizens" per

Romero-Hill Affidavit of Citizenship, Domicile, i

DOCH 361061

11/27/2012 01:09 PM Page: 124 of 178
AFF R:\$10.00 J. C. Sloan, McKinley County



2022-011769 MISC Page: 2027 of 2782
09/26/2022 03:35:37 PM Receipt #: 22-9381
Rec Fee: \$30.00 Darrell James Hill
GiLa County, Az, Sadie Jo Bingham, Recorder

DOCH 361076

11/27/2012 04:15 PM Page: 125 of 183
AFF R:\$10.00 J. C. Sloan, McKinley County



2018

AFFIDAVIT OF CITIZENSHIP, DOMICILE, AND TAX STATUS

26 CFR §1.1-1(c) and 26 U.S.C. §3121(e) must be aliens in relation to a foreign country under a tax treaty per 26 U.S.C. §911 in order to be "taxpayers".

5. Submitter is not engaged in a "trade or business", which is defined in 26 U.S.C. § 7701(a)(26) as "the functions of a public office". Receipt of earnings from the District of Columbia in connection with a "trade or business" under 26 U.S.C. §871(b) or not connected under 26 U.S.C. 871(a) are the only types of "gross income" or "taxable income" that nonresidents who are not aliens can have under I.R.C. Subtitle A.

6. Submitter is a "transient foreigner" but not a statutory "foreign person" or statutory "alien" in respect to the national government and federal territory. A human being or artificial entity such as a state corporation domiciled in a state of the Union is a "transient foreigner" but not a "person", "individual", or "foreign person" for the purposes of the Internal Revenue Code because the term "United States" is defined in 26 U.S.C. §7701(a)(9) and (a)(10) as the District of Columbia and is nowhere expressly expanded to include any state of the Union.

7. Submitter is not in receipt of any treaty benefit under the terms of an income tax treaty with a foreign country.

8. Submitter has not made an election to be treated as a "resident alien" as defined in 26 U.S.C. 7701(b)(1)(A) under the authority of 26 U.S.C. §6013(g) and (h).

9. Submitter is not a statutory "individual" as defined in 26 CFR §1.1441-1(c)(3) or a "person" as defined in 26 U.S.C. §7701(c) because not domiciled or resident on federal territory and not eligible or consensually participating in any federal franchise or "benefit" in the context of this exclusively private and not public transaction. As such, she is not a "public officer" with the government but rather a private human being. The only thing the government can regulate or tax are public activities, public officers, and public "employees" who are the only "persons" mentioned in the I.R.C. franchise per 26 U.S.C. §7343 and 6671(b). It is otherwise unconstitutional to regulate exclusively private conduct.

"The power to 'legislate generally upon' [the PRIVATE] life, liberty, and property, as opposed to the 'power to provide modes of redress' against offensive state [e.g. 'public officer'/'employee'] action, was 'repugnant' to the Constitution. Id., at 15. See also United States v. Reese, 92 U.S. 214, 218 (1876); United States v. Harris, 106 U.S. 629, 639 (1883); James v. Bowman, 190 U.S. 127, 139 (1903). Although the specific holdings of these early cases might have been superseded or modified, see, e.g., Heart of Atlanta Motel, Inc. v. United States, 379 U.S. 241 (1964); United States v. Guest, 383 U.S. 745 (1966), their treatment of Congress' §5 power as corrective or preventive, not definitional, has not been questioned."

[City of Boerne v. Flores, Archbishop of San Antonio, 521 U.S. 507 (1997)]

10. Submitter is NOT subject to IRS Form 1099 reporting, withholding, or backup withholding pursuant to 26 U.S.C. §3401(a)(6) or 26 CFR §31.3401(a)(6)-1(b):

"Foreign persons who provide Form W-8BEN, Form W-8ECI, or Form W-8EXP (or applicable documentary evidence) are exempt from backup withholding and Form 1099 reporting."
[IRS Publication 515, year 2001, p. 3]

11. Submitter is not a "U.S. person" as statutorily defined pursuant to 26 U.S.C. 7701(a)(30). The term "U.S. person" is statutorily defined as follows:

TITLE 26 > Subtitle F > CHAPTER 79 > Sec. 7701.
Sec. 7701. - Definitions

(a)(30) United States person

The term "United States person" means --

(A) a citizen or resident of the United States,

(B) a domestic partnership,

(C) a domestic corporation,

(D) any estate (other than a foreign estate, within the meaning of paragraph (31)), and

(E) any trust if --

(i) a court within the United States is able to exercise primary supervision over the administration of the trust, and

(ii) one or more United States persons have the authority to control all substantial decisions of the trust.

Romero-Hill Affidavit of Citizenship, Domicile, &

DOCH 361061

11/27/2012 01:09 PM Page: 125 of 178
AFF R:\$10.00 J. C. Sloan, Mckinley County



2022-011769 MISC Page: 2028 of 2762
09/25/2022 03:35:37 PM Receipt #: 22-9381
Rec Fee: \$30.00 Darrell James Hill
Gila County, Az, Sadie Jo Bingham, Recorder

DOCH 361076
11/27/2012 04:15 PM Page: 126 of 188
AFF R:\$10.00 J. C. Sloan, Mckinley County

2019

AFFIDAVIT OF CITIZENSHIP, DOMICILE, AND TAX STATUS

12. The term "United States" as used in "U.S. person" above is defined in 26 U.S.C. § 7701(a)(9) and (a)(10) as follows:

TITLE 26 > Subtitle F > CHAPTER 79 > Sec. 7701. [Internal Revenue Code]
Sec. 7701. - Definitions

(a) When used in this title, where not otherwise distinctly expressed or manifestly incompatible with the intent thereof--

(9) United States

The term "United States" when used in a geographical sense includes on the States and the District of Columbia.

(10) State

The term "State" shall be construed to include the District of Columbia, where such construction is necessary to carry out provisions of this title.

13. Pursuant to the rules for statutory construction, if the states of the Union are not mentioned anywhere in Subtitle A of the Internal Revenue code and are not included in the definition of "United States" above, they can be safely assumed to be EXCLUDED by implication:

"Expressio unius est exclusio alterius. A maxim of statutory interpretation meaning that the expression of one thing is the exclusion of another. Burgin v. Forbes, 293 Ky. 456, 169 S.W.2d 321, 325; Newblock v. Bowles, 170 Okl. 487, 40 P.2d 1097, 1100. Mention of one thing implies exclusion of another. When certain persons or things are specified in a law, contract, or will, an intention to exclude all others from its operation may be inferred. Under this maxim, if statute specifies one exception to a general rule or assumes to specify the effects of a certain provision other exceptions of effects are excluded."
[Black's Law Dictionary, Sixth Edition, p. 581]

14. Nonresidents not engaged in a "trade or business" such as the Submitter are not required to provide identifying number to open financial accounts. The regulation below mentions "nonresident aliens", and nonresidents who are not statutory "aliens" must be treated the same:

Title 31: Money and finance: Treasury
PART 103—FINANCIAL RECORDKEEPING AND REPORTING OF CURRENCY AND FOREIGN TRANSACTIONS
Subpart C—Records Required To Be Maintained
§103.34 additional records to be made and retained by banks.

(a)(3) A taxpayer identification number required under paragraph (a)(1) of this section need not be secured for accounts or transactions with the following:

(x) non-resident aliens who are not engaged in a trade of business in the United States.

In instances described in paragraph (a)(3), (viii) and (ix) of this section, the bank shall, within 15 days following the end of any calendar year in which the interest accrued in that year is \$10 or more use its best effort to secure and maintain the appropriate taxpayer identification number or application form therefor.

15. It amounts to "compelled to association" in violation of the First Amendment to force me to associate with and be identified as a "U.S. person" (under 26 U.S.C. § 7701(a)(30)), a statutory "U.S. Citizen" (under 8 U.S.C. § 1401), or a "taxpayer" (under 26 U.S.C. § 7701(a)(14)) or any status OTHER than that described above. I would also be committing perjury under penalty of perjury to sign any government form that identified me as any of the three types of entities.

16. I will not allow you to compel me to participate in the "trade or business" franchise or contract with the government by changing my status to be anything other than that described herein. All franchises are contracts between the grantor and the grantee:

Romero-Hill Affidavit of Citizenship, Domicile, ar

DOCH 361061

11/27/2012 01:09 PM Page: 126 of 178
AFF R: \$10.00 J. C. Sloan, McKinley County



2022-011769 MISC Page: 2029 of 2782
09/26/2022 03:35:37 PM Receipt #: 22-9381
Rec Fee: \$30.00 Darrell James Hill
Gila County, AZ Sadie Jo Bingham, Recorder

DOCH 361076 Page: 127 of 183
11/27/2012 04:15 PM J. C. Sloan, McKinley County
AFF R: \$10.00

2020

AFFIDAVIT OF CITIZENSHIP, DOMICILE, AND TAX STATUS

As a rule, franchises spring from contracts between the sovereign power and private citizens, made upon valuable considerations, for purposes of individual advantage as well as public benefit,¹ and thus a franchise partakes of a double nature and character. So far as it affects or concerns the public, it is *publici juris* and is subject to governmental control. The legislature may prescribe the manner of granting it, to whom it may be granted, the condition and terms upon which it may be held, and the duty of the grantee to the public in exercising it, and may also provide for its forfeiture upon the failure of the grantee to perform that duty. But when granted, it becomes the property of the grantee, and is a private right, subject only to the governmental control growing out of its other nature as *publici juris*.² [Am.Jur.2d, Franchises, §4: Generally]

17. Pursuant to the Declaratory Judgment Act, 28 U.S.C. §2201(a) and the federal courts, the recipient of this form and any government agent handling this case has NO authority to assume any tax status other than that indicated on this form or to convert an innocent "nontaxpayer" into a "taxpayer".

Specifically, Rowen seeks a declaratory judgment against the United States of America with respect to "whether or not the plaintiff is a taxpayer pursuant to, and/or under 26 U.S.C. § 7701(a)(14)." (See Compl. At 2.) The court lacks jurisdiction to issue a declaratory judgment "with respect to Federal taxes other than actions brought under section 7428 of the Internal Revenue code of 1986, "a code section that is not at issue in the instant action. See 28 U.S.C. §2201; see also *Huqhes v. United States, 953 F.2d 531, 536-537 (9th Cir. 1991)* (affirming dismissal of claim for declaratory relief under §2201 where claim concerned question of tax liability). Accordingly, defendant's motion to dismiss is hereby GRANTED, and the instant action is hereby DISMISSED. [Rowen v. US., 05-3766MMC. (N.D.Cal. 11/02/2005)]

"And by statutory definition, 'taxpayer' includes any person, trust or estate subject to a tax imposed by the revenue act. ...Since the statutory definition of 'taxpayer' is exclusive, the federal courts do not have the power to create nonstatutory taxpayers for the purpose of applying the provisions of the Revenue Acts..."

[C.I.R. v. Trustees of L. Inv. Ass'n, 100 F.2d 18 (1939)]

"A reasonable construction of the taxing statutes does not include vesting any tax official with absolute power of assessment against individuals not specified in the statutes as a person liable for the tax without an opportunity for judicial review of this status before the appellation of 'taxpayer' is bestowed upon them and their property is seized..."

[Botta v. Scanlon, 288 F.2d. 504, 508 (1961)]

SECTION 3: DURESS STATEMENT

If any other government form with the Recipient of this form might have received or viewed which I might have signed contradicts anything contained herein, the reasons are that:

1. I was threatened or felt threatened:
 - 1.1. By the Recipient to either not be hired or be fired if I did not sign a W-4 agreement or submit to a specific government form that doesn't pertain to me and thereby commit what I know to be fraud and/or perjury on a government form. . . OR
 - 1.2. By the Recipient because I was told that I would be denied the EQUAL right of all to engage in a business or financial account needed to sustain my life if I did not fill out and submit the form indicated and which I know misrepresented my status or had no options to correctly represent my status. . . OR
 - 1.3. By the government because I would become the target of unlawful or "selective" IRS/government enforcement that the legal profession, the courts, and the government routinely protect and encourage because of conflicts of interest, undue consolidation of power, and greed.

¹ Georgia R. & Power Co. v. Atlanta, 154 Ga 731, 115 SE 263; Lippencott v. Allander, 27 Iowa 460; State ex rel. Hutton v. Baton Rouge, 217 La 857, 47 So 2d 665; Tower v. Tower & S. Street R. Co. 68 Minn 500, 71 NW 691.

² Georgia R. & Power Co. v. Atlanta, 154 Ga 731, 115 SE 263; Lippencott v. Allander, 27 Iowa 460; State ex rel. Hutton v. Baton Rouge, 217 La 857, 47 So 2d 665; Tower v. Tower & S. Street R. Co. 68 Minn

Romero-Hill Affidavit of Citizenship, Domicile, and

DOCH 361061

11/27/2012 01:09 PM Page: 127 of 178
AFF R: \$10.00 J. C. Sloan, McKinley County



2022-011769 MISC Page: 2030 of 2782
09/26/2022 03:35:37 PM Receipt #: 22-9381
Rep Fee: \$30.00 Darrell James Hill
Gila County, Az, Sadie Jo Bingham, Recorder

DOCH 361076
11/27/2012 04:15 PM Page: 128 of 183
AFF R: \$10.00 J. C. Sloan, McKinley County

2021

AFFIDAVIT OF CITIZENSHIP, DOMICILE, AND TAX STATUS

"For the love of money is the root of all evil: which while some coveted after, they have erred from the faith, and pierced themselves through with many sorrows.

But thou, O man of God, flee these things' and follow after righteousness, godliness, faith, love, patience, meekness.

Fight the good fight of faith, lay hold on eternal life, whereunto thou art also called, and hast professed a good profession before many witnesses."

[1 Timothy 6:5-12, Bible, NKJV]

1.4 By the Recipient, who may have refused to accept this for or sent it back, because they knew they were violating both the law and my right and wanted to obstruct justice, destroy evidence of their wrongdoing, and tamper with a federal witness because this form is signed under penalty of perjury.

2. I was therefore under unlawful duress and the target of racketeering, extortion, and/or unconscionable "adhesion contracts" by the recipient/ government.

3. The origin of the duress was the Recipient of this form acting in a quasi-governmental and "public officer" capacity as a "withholding agent" pursuant to 26 U.S.C. §7701(a)(16) and who is therefore legally liable to respect my constitutional rights and REFUSED demands to do so.

... AND

4. The result of the unlawful duress was that I was compelled to contract with or engage in commerce within the government against my will and/or religious beliefs in violation of Article 1, section 10 of the United States Constitution, and to donate private property to a public use, public purpose, and/or public office in the government such as the "trade or business" franchise that is the heart of the Internal Revenue Code. Participation in all government franchises is an act of contracting because all franchises are contracts.

I hereby for the record declare as void, untrustworthy, and not admissible as evidence of any obligation on my part in any and all forms, declarations of status, or other correspondence in conflict with this form or any attached form I may have provided because such was submitted under unlawful duress.

"An agreement [consensual contract] obtained by duress, coercion, or intimidation is invalid, since the party coerced is not exercising his free will, and the test is not so much the means by which the party is compelled to execute the agreement as the state of mind induced."³ Duress, like fraud, rarely becomes material, except where a contract or conveyance has been made which the maker wishes to avoid. As a general rule, duress renders the contract or conveyance voidable, not void, at the option of the person coerced,⁴ and it is susceptible of ratification. Like other voidable contracts, it is valid until it is avoided by the person entitled to avoid it.⁵ However, duress in the form of physical compulsion, in which a party is caused to appear to assent when he has no intention of doing so, is generally deemed to render the resulting purported contract void.⁶

[American Jurisprudence 2d, Duress, Section 21]

This affidavit of duress and void declaration especially includes, but is not limited to, anything relating to government franchises, disclosures of government identifying numbers such as SSN or TIN, tax withholding or reporting forms such as the W-4 contract forms (26 CFR §31.3401(a)-3(a) and 26 CFR §31.3402(p)-1, tax returns, or any other declaration of status (e.g. "employee", "taxpayer", "individual", "inhabitant", "U.S. citizen") arising out of any tax, citizenship, or licensing forms provided to the government such as driver's license applications, applications for ID cards, voter registration, or benefit applications.

³ Brown v. Pierce, 74 U.S. 205, 7 Wall 205, 19 LEd 134

⁴ Barnett v. Wells Fargo Nevada Nat'l Bank, 270 U.S. 438, 70 LEd 669, 46 S Ct 326 (holding that acts induced by duress which operate solely on the mind, and fall short of actual physical compulsion, are not void at law, but are voidable only, at the election of him whose acts were induced by it); Fiske v. Gershman, 30 Misc 2d 442, 215 NYS2d 144; Glenney v. Crane (Tex Civ App Houston (1st Dist)) 352 SW2d 773, writ ref n r e (May 16, 1962); Carroll v. Fetty, 121 W.Va 215, 2 SE.2d 521, cert den 308 U.S. 571, 84 LEd 479, 60 S ct 85.

⁵ Fiske v. Gershman, 30 Misc 2d 442, 215 NYS2d 144; Heider v Unicume, 142 Or 416, 20 P2d 384; Glenney v. Crane (Tex Civ App Houston (1st Dist)) 352 SW2d 773, writ ref n r e (May 16, 1962)

⁶ Restatement 2d, Contracts § 174, stating that if conduct that appears to be a manifestation of assent by a party who does not intend to engage in that conduct is physically compelled by duress, the conducts is not effective as a manifestation of assent.

Romero-Hill Affidavit of Citizenship, Domicile, an

DOCH 361061

11/27/2012 01:09 PM Page: 128 of 178
AFF R: \$10.00 J. C. Sloan, McKinley County



2022-011769 MISC Page: 2031 of 2782

09/26/2022 03:35:37 PM Receipt #: 22-9381

Rec Fee: \$30.00 Darrell James Hill
Gila County, AZ Sadie Jo Bingham, Recorder



DOC# 361076

11/27/2012 04:15 PM Page: 128 of 183

AFF R: \$10.00 J. C. Sloan, McKinley County



2022

AFFIDAVIT OF CITIZENSHIP, DOMICILE, AND TAX STATUS

SECTION 4: DO NOT ATTEMPT TO ADVISE ME WHAT TO PUT ON ANY GOVERNMENT FORM OR TO CHANGE THE STATUS DESCRIBED IN THIS FORM

Per **26 U.S.C. §6065**, all tax forms must be signed under penalty of perjury, just as this form is. As such, this form and ALL tax forms I submit to you constitute "testimony of a witness" and are protected by witness tampering laws. I remind the recipient that it is a federal offense to tamper with witnesses. Tampering includes, but is not limited to:

1. Advising me what to put on this form or any tax or withholding form and thereby conspire to commit PERJURY in violation of **18 U.S.C. §1542**, **18 U.S.C. §911**, **18 U.S.C. §1001**, and **18 U.S.C. §1621**. All such attempts shall form an inseparable part of the forms you both receive and must keep on file so that you may be held accountable.
2. Refusing to honor that status that I describe here and thereby compelling me to commit perjury for the PRIVILEGE of being treated EQUALLY to everyone else you service.
3. Telling me that what I put on the form is INCORRECT or FALSE and thereby refusing to accept the form, and yet refusing to offer legal evidence signed under penalty of perjury (as required by **26 U.S.C. §6065**) PROVING that it is false.
4. Threatening to withhold service or discriminate against me while acting as a public officer called a "withholding agent" defined in **26 U.S.C. §7701(a)(14)**. That would be a denial of equal protection of the law.
5. Imputing or assuming a legal status OTHER than what I put here, and which might subject me to illegal enforcement or penalties against parties not subject. All such activities constitute an unconstitutional "Bill of Attainder" if implemented against those not consensually and lawfully engaged in government franchises. Not even federal judges can make such determinations.
- 28 22 U.S.C. 2201(a) forbids such determinations.

SECTION 5: SIGNATURE OF SUBMITTER

Worker Signature:	I certify under penalty of perjury from without the "United States" in accordance with 28 U.S.C. § 1746(1) that the information provided on this form is true, correct, and complete.	Date signed:	
	 Beverly Jean, Romero- Hill	10/11/12	

NOTARY PUBLIC CERTIFICATION

BEFORE ME, the undersigned authority, a Notary Public, of the County of McKinley, Republic of NEW MEXICO (statename), this 11th day of OCTOBER, 20 12

BEVERLY JEAN ROMERO-HILL the above signed human being did appear and was identified by (circle one):

driver's license/passport/other and who, upon first being duly sworn and/or affirmed, deposes and says that the

foregoing asseveration is true to the best of his knowledge and belief.

I certify under PENALTY OF PERJURY under the laws of the State of NEW MEXICO that the foregoing paragraph is true and correct.

WITNESS my hand and official seal.

 Notary Public Seal



OFFICIAL SEAL
 WILLIAM G. STRIPP
 NOTARY PUBLIC
 STATE OF NEW MEXICO

My Commission Expires: 6/1/2016

My Commission Expires On: JUNE 1, 2016

2023

2022-011769 MISC Page: 2032 of 2782
 09/26/2022 03:35:37 PM Receipt #: 22-9381
 Rec Fee: \$30.00 Darrell James Hill
 Gila County, Az. Sadie Jo Bingham, Recorder

DOCH 361076

11/27/2012 04:15 PM Page: 130 of 183
 AFF R: \$10.00 J. C. Sloan, McKinley County

DOCH 361061

11/27/2012 01:09 PM Page: 129 of 178
 AFF R: \$10.00 J. C. Sloan, McKinley County

AFFIDAVIT OF CITIZENSHIP, DOMICILE, AND TAX STATUS

SECTION 4: DO NOT ATTEMPT TO ADVISE ME WHAT TO PUT ON ANY GOVERNMENT FORM OR TO CHANGE THE STATUS DESCRIBED IN THIS FORM

Per 26 U.S.C. §6065, all tax forms must be signed under penalty of perjury, just as this form is. As such, this form and ALL tax forms I submit to you constitute "testimony of a witness" and are protected by witness tampering laws. I remind the recipient that it is a federal offense to tamper with witnesses. Tampering includes, but is not limited to:

1. Advising me what to put on this form or any tax or withholding form and thereby conspire to commit PERJURY in violation of 18 U.S.C. §1542, 18 U.S.C. §911, 18 U.S.C. §1001, and 18 U.S.C. §1621. All such attempts shall form an inseparable part of the forms you both receive and must keep on file so that you may be held accountable.
2. Refusing to honor that status that I describe here and thereby compelling me to commit perjury for the PRIVILEGE of being treated EQUALLY to everyone else you service.
3. Telling me that what I put on the form is INCORRECT or FALSE and thereby refusing to accept the form, and yet refusing to offer legal evidence signed under penalty of perjury (as required by 26 U.S.C. §6065) PROVING that it is false.
4. Threatening to withhold service or discriminate against me while acting as a public officer called a "withholding agent" defined in 26 U.S.C. §7701(a)(14). That would be a denial of equal protection of the law.
5. Imputing or assuming a legal status OTHER than what I put here, and which might subject me to illegal enforcement or penalties against parties not subject. All such activities constitute an unconstitutional "Bill of Attainder" if implemented against those not consensually and lawfully engaged in government franchises. Not even federal judges can make such determinations. 28 U.S.C. 2201(a) forbids such determinations.

SECTION 5: SIGNATURE OF SUBMITTER

Worker signature:	I certify under penalty of perjury from without the "United States" in accordance with <u>28 U.S.C. § 1746(1)</u> that the information provided on this form is true, correct, and complete.  Beverly Jean, Romero-Hill	Date signed: 10/11/12	
-------------------	--	------------------------------	--

NOTARY PUBLIC CERTIFICATION

BEFORE ME, the undersigned authority, a Notary Public, of the County of MCKINLEY, Republic of NEW MEXICO (statename), this 11th day of OCTOBER, 20 12

BEVERLY JEAN ROMERO-HILL the above signed human being did appear and was identified by (circle one):

driver's license/passport/other and who, upon first being duly sworn and/or affirmed, deposes and says that the foregoing asseveration is true to the best of his knowledge and belief.

I certify under PENALTY OF PERJURY under the laws of the State of NEW MEXICO that the foregoing paragraph is true and correct.

WITNESS my hand and official seal.

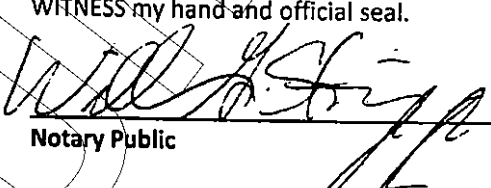
Notary Public

Seal



OFFICIAL SEAL
WILLIAM G. STRIPP
NOTARY PUBLIC
STATE OF NEW MEXICO

My Commission Expires: 6/1/2016

My Commission Expires On: JUNE 1, 2016

2022-011769 MISC Page: 2033 of 2782
09/26/2022 03:35:37 PM Receipt #: 22-9381
Darrell James Hill
Rec Fee: \$30.00 Sadie Jo Bingham, Recorder
Gila County, Az

DOC# 361076

11/27/2012 04:15 PM Page: 131 of 183
AFF R: \$10.00 J. C. Sloan, McKinley County

DOC# 361061

11/27/2012 01:09 PM Page: 130 of 178
AFF R: \$10.00 J. C. Sloan, McKinley County

2024

AFFIDAVIT OF CITIZENSHIP, DOMICILE, AND TAX STATUS

APPENDIX: LEGAL POINTS AND AUTHORITIES

(This section provided for those who seek supporting authorities of statement made in this document)

1. A "national" is statutorily defined as follows:

TITLE 8 > CHAPTER 12 > SUBCHAPTER I. Sec. 1101.

Sec. 1101. - Definitions

(a)(21) The term "national" means a person owing permanent allegiance to a state.

2. The "state" in the above definition is a state of the Union. All states of the Union are "foreign states" with respect to federal government legislative jurisdiction, and therefore are lower case. Federal territories are capitalized as "State" within federal law. For example:

TITLE 4 -- FLAG AND SEAL, SEAT OF GOVERNMENT, AND THE STATES

CHAPTER 4 -- THE STATES

Sec. 110. Same; definitions

(d) The term "state" includes any Territory or possession of the United States.

3. Even the "United States of America" passport recognizes the two types of citizenship defined in federal statutory law. On the inside cover of the passport it says the following. Note the phrase "citizen/national", which means "citizen OR national":

"The Secretary of State of the United States of America hereby request all whom it may concern to permit the citizen/national of the United States named herein to pass without delay or hindrance and in case of need to give all lawful aid and protection"

4. Below are some cites that establish the foreign relationship between the state and federal government for the purposes of legislative jurisdiction:

Foreign States: "Nations outside of the United States...Term may also refer to another state: i.e. a sister state. The term 'foreign nations', ...should be construed to mean all nations and states other than that in which the action is brought; and hence, one state of the Union is foreign to another, in that sense."
[Black's Law Dictionary, 6th Edition, p. 648]

Foreign Laws: "The laws of a foreign country or sister state."
[Black's Law Dictionary, 6th Edition, p. 647]

"Generally, the states of the Union sustain toward each other the relationship of independent sovereigns or independent foreign states, except in so far as the United States is paramount as the dominating government, and in so far as the states are bound to recognize the fraternity among sovereignties established by the federal Constitution, as by the provision requiring each state to give full faith and credit to the public acts, records, and judicial proceedings of the other states..."
[81A Corpus Juris Secundum (C.J.S.), United States, §29, legal encyclopedia]

"It is no longer open to question that the general government, unlike the states, Hammer v. Dagenhart, 247 U.S. 251, 275, 38 S.Ct. 529, 3 A.L.R. 649, Ann.Cas. 1918E 724, possesses no inherent power in respect of the internal affairs of the states; and emphatically not with regard to legislation. The question in respect of the inherent power of that government as to the external affairs of the Nation and in the field of international law is a wholly different matter which it is not necessary now to consider."
[Carter v. Carter Coal Co., 298 U.S. 238, 56 S.Ct. 855 (1936)]

5. The sole function of the federal government of the United States is to handle FOREIGN affairs with other countries, but it has no jurisdiction within states of the Union, including taxation. All of its revenues must derive only from the external affairs over which it has exclusive legislative jurisdiction. The rulings below occurred AFTER the passage of the Sixteenth Amendment and still limit the federal government exclusively to external matters in relation to states of the Union.

"The States, after they formed the Union, continued to have the same range of {INTERNAL} taxing power which they had before, barring only duties affecting exports, imports, and on tonnage [which all deal with FOREIGN/EXTERNAL commerce only]. 2 Congress, on the other hand, to lay taxes in order 'to pay the Debts and provide for the common Defence and general Welfare of the United States', Art. 1,

2022-011769 MISC Page: 2034 of 2782

09/26/2022 03:35:37 PM Receipt #: 22-9381

Rec Fee: \$30.00 Darrell James Hill
Gila County, Az, Sadie Jo Bingham, Recorder



DOC# 361076

11/27/2012 04:15 PM Page: 132 of 183
AFF R: \$10.00 J. C. Sloan McKinley County

DOC# 361061

11/27/2012 01:09 PM Page: 131 of 178
AFF R: \$10.00 J. C. Sloan McKinley County

AFFIDAVIT OF CITIZENSHIP, DOMICILE, AND TAX STATUS

Sec. 8, U.S.C.A. Const., can reach every person and every dollar in the land with due regard to Constitutional limitations as the method of laying taxes."

[Graves. V. People of State of New York, 306 U.S. 466 (1939)]

"The difficulties arising out of our dual form of government and the opportunities for differing opinions concerning the relative rights of state and national governments are many; but for a very long time this court has steadfastly adhered to the doctrine that the taxing power of Congress does not extend to the states of their political subdivisions. The same basic reasoning which leads to that conclusion, we think, requires like limitation upon the power which springs from the bankruptcy clause. United States v. Butler, supra."

[Ashton v. Cameron County Water Improvement District No. 1, 298 U.S. 513; 56 S.Ct. 892 (1936)]

Congress is authorized to lay and collect taxes, and to pay the debts, and provide for the common defence and general welfare of the United States. This does not interfere with the power of the States to tax [internally] for the support of their own governments; nor is the exercise of that power by the States [to tax INTERNALLY], an exercise of any portion of the power that is granted to the United States [to tax EXTERNALLY]. In imposing taxes for State purposes, they are not doing what Congress is empowered to do. Congress is not empowered to tax for those purposes which are within the exclusive province of the States. When, then, each government exercises the power to taxation, neither is exercising the power of the other. But, when a State proceeds to regulate commerce with foreign nations, or among the several States, it is exercising the very power that is granted to Congress, [22 U.S. 1, 200] and is doing the very thing which Congress is authorized to do. There is no analogy, then, between the power of taxation and the power of regulating commerce."

[Gibbons v. Ogden, 22 U.S. 1 (1824)]

"It will contribute to the elucidation of the question if we first consider the differences between the power of the federal government in respect of foreign or external affairs and those in respect of domestic or internal affairs. That there are differences between them, and that these differences are fundamental, may not be doubted. The two classes of powers are different, both in respect of their origin and their nature. The broad statement that the federal government can exercise no power except those specifically enumerated in the Constitution, and such implied power as are necessary and proper to carry into effect the enumerated power, is categorically true only in respect of our internal affairs. In that field, the primary purpose of the Constitution was to carve from the general mass of legislative powers then possessed by the states such portions as it was thought desirable to vest in the federal government, leaving those not included in the enumerations still in the states.

Carter v. Carter Coal Co., 298 U.S. 238, 294, 56 S.Ct. 855, 865. . . .

The Union existed before the Constitution, which was ordained and established among other things to form 'a more perfect Union.' Prior to that event, it is clear that the Union, declared by the Articles of Confederation to be 'perpetual,' was the sole possessor of external sovereignty, and in the Union it remained without change save in so far as the Constitution in express terms qualified its exercise. The Framers' Convention was called and exerted its powers upon the irrefutable postulate that though the states were several their people in respect of foreign affairs were one."

[United States v. Curtiss-Wright Export Corporation, 299 U.S. 304 (1936)]

6. The states of the Union are "foreign" to federal legislative jurisdiction, because, as the U.S. Supreme Court held above, they are not subject to it. This is a result of what is called the "Separation of Powers Doctrine", which was explained by the Supreme Court as follows:

"... the Constitution divides authority [legislative jurisdiction] between federal and state governments for the protection of individuals. State sovereignty is not just an end in itself: "Rather, federalism secures to citizens the liberties that derive from the diffusion of sovereign power." Coleman v. Thompson, 501 U.S. 722, 759 (1991) (BLACKMUN, J., dissenting). "Just as the separation and independence of the coordinate branches of the Federal Government serve to prevent the accumulation of excessive power in any one branch, a health balance of power between the States and the Federal Government will reduce the risk of tyranny and abuse from either front." Gregory v. [505 U.S. 144, 182] Ashcroft, 501 U.S. at 458. See The Federalist No. 51, p. 323. (C. Rossiter ed. 1961)."

[New York v. United States, 505 U.S. 144 (1992)]

AFFIDAVIT OF CITIZENSHIP, DOMICILE, AND TAX STATUS

7. The federal government has no legislative power outside of its "territory".

"Judge Story, in his treatise on the Conflicts of Laws, lays down, as the basis upon which all reasonings on the law of comity must necessarily rest, the following maxims: First 'that every nation [or state] possesses an exclusive sovereignty and jurisdiction within its own territory'; secondly, that no state or nation can by its laws directly affect or bind property out of its own territory, or bind persons not resident therein, whether they are natural born subjects or others.' The learned judge then adds: 'From these two maxims or propositions there follows a third, and that is that whatever force and obligation the laws of one country have in another depend solely upon the laws and municipal regulation of the latter; that is to say, upon its own proper jurisdiction and polity, and upon its own express or tacit [voluntary] consent.'" Story on Conflict of Laws §23.
[Baltimore & Ohio Railroad Co. v. Chambers, 73 Ohio St. 16; 76 N.E. 91; 11 L.R.A., N.S., 1012 (1905)]

8. The states of the Union are NOT "territory" of the federal government. They are instead INDEPENDENT and SOVEREIGN states:

86 Corpus Juris Secundum (C.J.S.) Legal Encyclopedia, Territories:

"§1. Definitions, Nature, and Distinctions

"The word 'territory,' when used to designate a political organization has a distinctive, fixed, and legal meaning under the political institutions of the United States, and does not necessarily include all the territorial possessions of the United States, but may include only the portions thereof which are organized and exercise governmental functions under act of congress."

"While the term 'territory' is often loosely used, and has even been construed to include municipal subdivisions of a territory, and 'territories of the " United States is sometimes' used to refer to the entire domain over which the United States exercises dominion, the word 'territory,' when used to designate a political organization, has a distinctive, fixed, and legal meaning under the political institutions of the United States, and the term 'territory' or 'territories' does not necessarily include only a portion of the portions thereof which are organized and exercise government functions under act of congress. The term 'territories' has been defined to be political subdivisions of the outlying dominion of the United States, and in this sense the term 'territory' is not a description of a definite area of land but of a political unit governing and being governed as such. The question whether a particular subdivision or entity is a territory is not determined by the particular form of government with which it is, more or less temporarily, invested."

"Territories' or 'territory' as including 'state' or 'states.'" While the term 'territories of the' United States may, under certain circumstances, include the states of the Union, as used in the federal Constitution and in ordinary acts of congress "territory" does not include a foreign state.

"As used in this title, the term 'territories' generally refers to the political subdivisions created by congress, and not within the boundaries of any of the several states."

9. States of the Union retain their essential character as independent nations and foreign countries with respect to the federal government except in the matter of EXTERNAL affairs delegated by them to the Federal Government in their corporate capacity as the "United States of America":

"The States between each other are sovereign and independent. They are distinct and separate sovereignties, except so far as they parted with some of the attributes of sovereignty by the Constitution. They continue to be nations, with all their rights, and under all their national obligations, and with all the rights of nations in every particular: except in the surrender by each to the common purposes and objects of the Union, under the Constitution. The rights of each State, when not so yielded up, remain absolute."

[Bank of Augusta v. Earle, 38 U.S. (13 Pet.) 519; 10 L.Ed. 274 (1839)]

"In determining the boundaries of apparently conflicting powers between states and the general government, the proper question is, not so much what has been, in terms, reserved to the states, as what has been, expressly or by necessary implication, granted by the people to the national government: for each state possess all the powers of an independent and sovereign nation, except so far as they have been ceded away by the constitution. The federal government is but a creature of the people of the states, and, like an agent appointed for definite and specific purposes, must show an express or necessarily implied authority in the charter of its appointment, to give validity to its acts."

2022-011769 MISC Page: 2036 of 2782
09/26/2022 03:35:37 PM Receipt #: 22-9381
Rec Fee: \$30.00 Darrell James Hill
Gila County, Az, Sadie Jo Bingham, Recorder

DOC# 361076

11/27/2012 04:15 PM Page: 134 of 183
AFF R:\$10.00 J. C. Sloan, Mckinley County

DOC# 361061

11/27/2012 01:09 PM Page: 133 of 178
AFF R:\$10.00 J. C. Sloan, Mckinley County

AFFIDAVIT OF CITIZENSHIP, DOMICILE, AND TAX STATUS

[People ex re. Atty. Gen V. Naglee, 1 Cal 234 (1850)]

10. A human being (but NOT "person") who is born in a state of the Union, which is outside of federal exclusive legislative jurisdiction, is called a "national". A person who is a "national" is subject to the "political jurisdiction" but not the "legislative jurisdiction" of their mother country because they are outside of the territorial reach of its general laws, because the Congress cannot write any law that governs what happens with states of the Union, as the above citations indicate (see, for instance, Carter v. Carter Coal Co., 298 U.S. 238, 56 S.Ct. 855, (1936)). The reason is that the states and the people in them are SOVEREIGN, and their creation, the federal government, cannot be greater than its Creator, which is the states and the people in them. The federal government is a SERVANT to the states, not their master: the equivalent of an independent contract that handles EXTERNAL affairs only. This was confirmed by the Federalist Papers, which were written prior to the ratification of the Constitution by the states of the Union in 1789:

"No legislative act [of Congress] contrary to the Constitution can be valid. To deny this would be to affirm that the deputy (agent) [which is the federal government] is greater than his principal [the States and the people in them]; that the servant is above the master; that the representatives of the people are superior to the people; that men, acting by virtue of powers may do not only what their powers do not authorize, but what they forbid...[text omitted] It is not otherwise to be supposed that the Constitution could intend to enable the representatives of the people to substitute their will to that of their constituents. It is far more rational to suppose, that the courts were designed to be an intermediate body between the people and the legislature, in order, among other things, to keep the latter within the limits assigned to their authority. The interpretation of the laws is the proper and peculiar province of the courts. A Constitution is, in fact, and must be regard by judges, as fundamental law. If there should happen to be an irreconcilable variance between the two, the Constitution is to be preferred to the statute."
[Alexander Hamilton, Federalist Paper # 78]

11. It is absurdly ridiculous to demand from the submitter a federal statute that confers but NOT defines citizenship status of a person born outside of federal jurisdiction. The laws of the States of the Union, and not federal law, govern the citizenship status of people born within their jurisdiction. States of the Union have exclusive and "plenary" jurisdiction to determine the status of people born with their jurisdiction and they have never yielded that authority to the federal government either in the Constitution or in any subsequent amendment or enactment. To conclude otherwise is to admit that states of the Union have NO SOVEREIGNTY, because the federal government could just pass a law to literally STEAL all of their citizens. If the federal government had jurisdiction to pass a law that allowed them to STEAL all citizens of the states, then the states would be left with not one to govern!

12. Congress has the power to "naturalize" people coming into America, and when they do this, these people become statutory "nationals" and constitutional but not statutory "Citizens".

"Provision of Nationality Act of 1940 that a person becoming a national by naturalization shall lose his nationality by residing continuously for three years in territory of a foreign state, being practically identical to its successor, which was condemned by United States Supreme Court as discriminatory, would have been invalid as a congressional attempt to expatriate regardless of intent."
[United States v. Lucienne D'Hotelle, 558 F.2d 37 (1976)]

The statutory definition of "naturalization" confirms that in America, naturalization means conferring the character of a statutory "national" and not a statutory "citizen":

8 U.S.C. §1101(a)(23) naturalization defined

(a)(23) The term "naturalization" means the conferring of nationality [NOT "citizen" or "U.S. citizen" status, but "nationality", which means "national"] of a state [of the Union] upon a person after birth, by any means whatsoever.

[NOTE: Compare with the definition of "expatriation"]

"The power of naturalization, vested in congress by the constitution, is a power to confer citizenship, not a power to take it away. 'A naturalized citizen,' said Chief Justice Marshall, 'becomes a member of the society, possessing all the rights of a native citizen, and standing, in the view of the constitution, on the footing of a native. The constitution does not authorize congress to enlarge or abridge those rights. The simple power of the national legislature [over citizenship] is to prescribe a uniform rule of naturalization, and the exercise of this power exhausts it, so far as respects the individual.'"

2022-011769 MISC Page: 2037 of 2782
09/26/2022 03:35:37 PM Receipt #: 22-9381
Rec Fee: \$30.00 Darrell James Hill
Gila County, Az, Sadie Jo Bingham, Recorder

DOCH 361076
11/27/2012 04:15 PM Page: 135 of 183
J. C. Sloan, McKinley County
AFF R: \$10.00

DOCH 361061
11/27/2012 01:09 PM Page: 134 of 178
J. C. Sloan, McKinley County
AFF R: \$10.00

AFFIDAVIT OF CITIZENSHIP, DOMICILE, AND TAX STATUS

[U.S. v. Wong Kim Ark, 169 U.S. 649 (1898)]

13. A human being who is a "national" but not a "citizen" under federal statutory law is identified as a "citizen of the United States" within the Fourteenth Amendment to the U.S. Constitution. The United States Constitution confines itself to describing citizenship within the states and the Union and therefore, the term "United States", as used within the Constitution, means the collective states of the Union [called "The United States of America"] and EXCLUDES federal territories and possessions and the District of Columbia. The "United States" mentioned in the Constitution and the "United States" mentioned in most federal enactments are two completely different and mutually exclusive places. This is VERY important and fundamental to understanding the Separation of Powers Doctrine.

14. If the recipient of this form disagrees with any of the facts stated in this section, then please provide the following within thirty calendar days or forever be stopped from challenging these statements of fact:

14.1. **Written evidence signed under penalty of perjury (not opinion, but enacted positive law, regulations, and Supreme court rulings but not those of lower courts) of same.**

The remainder of this is intentionally left blank.

2022-011769 MISC Page: 2038 of 2762
09/26/2022 08:35:47 PM Receipt #: 22-9381
Rec Fee: \$30.00 Darrell James Hill, Recorder
Gila County, AZ, Sadie Jo Binsman, Recorder

Official Copy

Romero-Hill Affidavit of Citizenship, Domicile, ai

DOCH 361061

11/27/2012 01:09 PM Page: 135 of 178
AFF R: \$10.00 J. C. Sloan, McKinley County

DOCH 361076

11/27/2012 04:15 PM Page: 136 of 183
AFF R: \$10.00 J. C. Sloan, McKinley County

2022-011769 MISC Page: 2039 of 2782
09/26/2022 03:35:37 PM Receipt #: 22-9381
Darrell James Hill
Rec Fee: \$30.00 Bingham, Recorder
Gila County, Az, Sadie Jo Bingham



DOCH 361076
11/27/2012 04:15 PM Page: 137 of 183
AFF R: \$10.00 J. C. Sloan, McKinley County

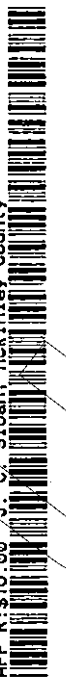

2020

Unofficial Copy

Item No. 3

Item 3:

Encl. 3

Oct. 2012

Affidavits of Citizenship, Domicile, and Tax Status, October 2012

Mailing and Acceptance Information

John Astrue, Commissioner, SSA c/o President Barack Obama

USPO RMN: RE 430 969 752 US

Accepted: October 19, 2012

Mailing and Acceptance Information

DOCH 361061

11/27/2012 01:09 PM Page: 136 of 178
AFF R: \$10.00 J. C. Sloan, McKinley County



Registered No. **RE430969752 US**

Date Stamp

To Be Completed By Post Office	Reg. Fee	10.95	
	Handling Charge		Return Receipt
	Postage	5.15	Restricted Delivery
	Received by <i>P. Mansperger</i>		

OCT 12 2012

Customer Must Declare Full Value \$ 0 Domestic Insurance up to \$25,000 is included based upon the declared value. International indemnity is limited. (See Reverse).

OFFICIAL USE

To Be Completed By Customer (Please Print) All Entries Must Be in Ballpoint or Typed	FROM	Darrell James Hill
		28 Hilltop Court
		HC 61, Box 771
	Ramah, New Mexico	
	TO	President Barack Hussein Obama
		The White House
11000 Pennsylvania Avenue NW Washington, DC. 20500		

PS Form 3806, Receipt for Registered Mail Copy 1 - Customer
May 2007 (7530-02-000-9051) (See Information on Reverse)
For domestic delivery information, visit our website at www.usps.com®

DOCH 361076

11/27/2012 04:15 PM Page: 138 of 183
AFF R: \$10.00 J. C. Sloan, McKinley County



Sent 10/12/2012
Rec. 10/19/2012

Unofficial

2031
2022-011769 MISC Page: 2040 of 2782
09/26/2022 03:35:37 PM Receipt #: 22-9381
Rec Fee: \$30.00 Darrell James Hill
Gila County, Az, Sadie Jo Bingham, Recorder



DOCH 361061

11/27/2012 01:09 PM Page: 137 of 178
AFF R: \$10.00 J. C. Sloan, McKinley County



English Customer USPS

Register / Sign In



Service Mobile

Search USPS.com or Track Package

Quick Tools

Ship a Package

Send Mail

Manage Your Mail

Shop

Business Solutions

Track & Confirm

GET EMAIL UPDATES PRINT DETAILS

YOUR LABEL NUMBER	SERVICE	STATUS OF YOUR ITEM	DATE & TIME	LOCATION	FEATURES
RE430969752US		Delivered	October 19, 2012, 4:20 am	WASHINGTON, DC 20369	Registered Mail™
		Arrival at Unit	October 18, 2012, 2:57 am	WASHINGTON, DC 20066	

Check on Another Item

What's your label (or receipt) number?

Find

LEGAL

- Privacy Policy ›
- Terms of Use ›
- FOIA ›
- No FEAR Act EEO Data ›

ON USPS.COM

- Government Services ›
- Buy Stamps & Shop ›
- Print a Label with Postage ›
- Customer Service ›
- Site Index ›

ON ABOUT.USPS.COM

- About USPS Home ›
- Newsroom ›
- Mail Service Updates ›
- Forms & Publications ›
- Careers ›

OTHER USPS SITES

- Business Customer Gateway ›
- Postal Inspectors ›
- Inspector General ›
- Postal Explorer ›

Copyright© 2012 USPS. All Rights Reserved.

DOCH 361076

11/27/2012 04:15 PM Page: 139 of 179
AFF R:\$10.00 J. C. Sloan, McKinley County



2022-011769 MISC Page: 2041 of 2782
09/26/2022 03:35:37 PM Receipt #: 22-9381
Rec Fee: \$30.00 Darrell James Hill
Gila County, Az, Sadie Jo Bingham, Recorder



DOCH 361061

11/27/2012 01:09 PM Page: 138 of 179
AFF R:\$10.00 J. C. Sloan, McKinley County



Des

DOCH 361076

11/27/2012 04:15 PM Page: 140 of 183
AFF R:\$10.00 J. C. Sloan, McKinley County



Item No. 4

Item 4:
Oct. 2012

Class Attorney(s) Corroborating Willful Fraud Against Class Member
Response regarding Sorensen Oct. 31, 2012 FedEx letter, TRK #201, 5366 8192 2909

Johnson, et al. v. AzHHA, et al., Class Attorney David Sorensen, Philadelphia, Pennsylvania

USPO CMN: 7009 2820 0003 8851 6179

Accepted: October 19, 2012

Affidavit of Citizenship, Domicile, and Tax Status, October 2012

2022-011769 MISC Page: 2042 of 2782

09/26/2022 03:35:37 PM Receipt #: 22-9381
Rec Fee: \$30.00 Darrell James Hill
Gila County, Az, Sadie Jo Bingham, Recorder



DOCH 361061

11/27/2012 01:09 PM Page: 139 of 178
AFF R:\$10.00 J. C. Sloan, McKinley County



Darrell James, Hill
28 Hilltop Court, HC 61, Box 771, Ramah, New Mex.

CMN: 7009 2820 0003 8851 6179

David F. Sorensen
Berger & Montague, P.C.
1622 Locust Street
Philadelphia, PA 19102-6305

Re: Your October 31, 2012 letter/ Fed Ex Express, TRK # 201, 5366 8192 2909

David,

Again, Glad to hear you are well.

About your October 31, 2012 letter (Fed Ex Express, TRK # 201, 5366 8192 2909, see attached for the record, 2 pages), David - NO! (I'll just be frank: May the truth be said and known.):

- 1) I submitted my demand and all facts upon RG2 claims for RG2's compliance with law and federal regulations (See my Affidavit of Citizenship, Domicile, and Tax Status.-See most recent Affidavit of Citizenship, Domicile, and Tax Status sent to Commissioner Astrue c/o President Obama based upon Commissioner Astrue's letter response/request - RMN: RE 430 969 752 US, 20 pages.).
- 2) As I repeatedly told you, my demand was sent directly to RG2 Claims because this matter was and remains between RG2 (as the "withholding agent" of the TD/IRS) and my "status" for "reporting"/ "withholding."
- 3) My only request to you was and remains restricted to solely advancing my position, assuring RG2's compliance with my position.
- 4) **Note: Your opinion on my position and "status", as you were repeatedly told, is not requested, authorized, relevant nor accepted.**

Your October 31, 2012 letter (attached) is false presumption on your part.

a) See paragraph 2, sentence 2: Regarding "applicable taxes" refer to my "status" statement Affidavit of Citizenship, Domicile, and Tax Status (enclosed). As established by law and regulations "no withholding" nor "reporting" by the "withholding agent" is permitted. Accordingly,

b) as indicated in my Affidavit of Citizenship, Domicile, and Tax Status (enclosed), the "withholding agent" RG2 claims and you shall commit willful fraud upon ignoring my "status" statement made.

c) Regarding your paragraph 3, sentence 2, you shamelessly state corroboration with RG2 to violate my demand, ignore my status statement, despite my express directions to you to ONLY support my position, NOT to corroborate 'business as usual' with RG2 claims against me!

5) This is likely to become a constitutional matter regarding apportionment. Thus, I inquired of you whether you knew of trustworthy PA lawyers to counsel me with the impending case against RG2, and you did not answer.

-Who are you protecting?

to defraud me?

2022-011769 MISC Page: 2043 of 2782
09/26/2022 03:35:37 PM Receipt #: 22-9381
Rec Fee: \$30.00 Darrell James Hill
Gila County, Az, Sadie Jo Bingham, Recorder



DOCH 361061

11/27/2012 01:09 PM Page: 140 of 178
AFF R:\$10.00 J. C. Sloan, McKinley County



DOCH 361076

11/27/2012 04:15 PM Page: 141 of 183
AFF R:\$10.00 J. C. Sloan, McKinley County



COPY

2034

Darrell James, Hill
28 Hilltop Court, HC 61, Box 771, Ramah, New Mex.

CMN: 7009 2820 0003 8851 6179

-Why do you persecute me?

When RG2 Claims "withholding agent" "withholds" anything ignoring my demand, or "status," and, consequently, law and federal regulations I will pursue them in constitutional court. It is a lie that the USDC - D of Arizona authorized a Pennsylvania business (or you) to violate laws and regulations (which is a felony by them) concerning my "status".

All considered your actions of late warrant reporting your unethical corroboration with RG2 Claims' proposed actions to your state bar for blatant corroboration in willful fraud with RG2 Claims against this class member. Where are your professional ethics David?!

Fix this!

Sincerely,

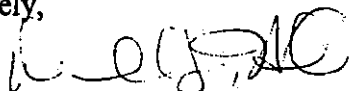

Darrell James, Hill

Enclosures: A: **Fed Ex Express, TRK # 201, 5366 8192 2909** from David Sorenson, (2 pages)

B: **Affidavit of Citizenship, Domicile, and Tax Status** sent to Commissioner Astrue c/o President Obama President Barack Obama, (20 pages)

cc: Mark Samson
Keller Rohrback, P.L.C.
3101 North Central Avenue
Suite 1400
Phoenix, AZ 85012

035
2022-011769 MISC Page: 2044 of 2782
09/26/2022 03:35:37 PM Receipt #: 22-9381
Rec Fee: \$30.00 Darrell James Hill
Gila County, Az, Sadie Jo Bingham, Recorder



DOCH 361061

11/27/2012 01:09 PM Page: 141 of 178
AFF R: \$10.00 J. C. Sloan, McKinley County



DOCH 361076

11/27/2012 04:15 PM Page: 142 of 183
AFF R: \$10.00 J. C. Sloan, McKinley County



Unofficial Copy

Item No. 4

Item 4:
Encl. A

Sorensen Oct. 31, 2012 FedEx letter, TRK #201, 5366 8192 2909
Johnson, et al. v. AzHHA, et al., Class Member Hill Darrell James

October 31, 2012
(document date)

2022-011769 MISC Page: 2045 of 2782
09/26/2022 03:35:37 PM Receipt #: 22-9381
Rec Fee: \$30.00 Darrell James Hill
Gila County, Az, Sadie Jo Bingham, Recorder



DOCH 361061

11/27/2012 01:09 PM Page: 142 of 178
AFF R:\$10.00 J. C. Sloan, Mckinley County



DOCH 361076

11/27/2012 04:15 PM Page: 143 of 183
AFF R:\$10.00 J. C. Sloan, Mckinley County



Darrell James, Hill
28 Hilltop Court, HC 61, Box 771, Ramah, New Mex.

CMN: 7009 2820 0003 8851 6179

ENCLOSURE A

Unofficial Copy

DOCH 361076

11/27/2012 04:15 PM Page: 144 of 183
AFF R:\$10.00 J. C. Sloan, Mokinley County



2022-011769 MISC Page: 2046 of 2782
09/26/2022 03:35:37 PM Receipt #: 22-9381
Rec Fee: \$30.00 Darrell James Hill
Gila County, Az. Sadie Jo Bingham, Recorder



DOCH 361061

11/27/2012 01:09 PM Page: 143 of 178
AFF R:\$10.00 J. C. Sloan, Mokinley County



Berger & Montague, P.C.

ATTORNEYS AT LAW

DAVID F. SORENSEN

WRITER'S DIRECT DIAL	215/875-5705
WRITER'S DIRECT FAX	215/875-5707
WRITER'S DIRECT E-MAIL	dsorensen@bm.net

October 31, 2012

VIA FED EX DELIVERY

Darrell James, Hill
 28 Hilltop Court
 HC 61, Box 771
 Ramah, NM 87321

Re: Johnson, et al. v. Arizona Hospital and Healthcare Assoc., et al.

Dear Mr. Hill:

I hope you are well, and I greatly appreciate and thank you for your concern for my own health (which is fine, thank you).

I am writing again about your individual request that, as to the claim you submitted in connection with the settlements in the Johnson v. AzHHA matter, the claims administrator not withhold applicable taxes from any settlement distribution payment you might receive as a claimant after we have moved for, and the Court has approved, distributions in this matter. As I have explained to you previously, the claims administrator (RG/2 Claims Administration) is required by law and the settlement agreements to calculate and withhold applicable taxes, and remit them to the appropriate authorities.

You have submitted various documents, but as I have explained to you, unless you can produce documents from the Social Security Administration (not just to them) and/or from other taxing authorities officially agreeing with your view of your tax status, RG/2 is required to withhold taxes and remit them to the appropriate authorities. We note that, in support of your claim in this matter, you submitted W-2 tax forms which document wages and federal and state tax withholding, and the settlement distribution payment you may ultimately receive in connection with this matter, similarly, relates to those same wages and is also subject to withholding.

Please understand that this is our final determination regarding your individual request. If you wish to appeal to the Court overseeing this case, you may contact the Court at: Clerk of Court, Johnson v. Arizona Hospital and Healthcare et al., No. 07-1292, U.S. District Court for

COPY

DOCH 361076
 11/27/2012 04:15 PM Page: 145 of 183
 AFF R:\$10.00 J. C. Sloan, Mckinley County

2022-011769 MISC Page: 2047 of 2782
 09/26/2022 03:35:37 PM Receipt #: 22-9381
 Rec Fee: \$30.00 Darrell James Hill
 Gila County, Az, Sadie Jo Bingham, Recorder

DOCH 361061
 11/27/2012 01:09 PM Page: 144 of 178
 AFF R:\$10.00 J. C. Sloan, Mckinley County

Berger & Montague, P.C.
ATTORNEYS AT LAW

District of Arizona, Sandra Day O'Connor U.S. Courthouse, 401 W. Washington St., Phoenix,
Arizona 85003.

[I sent you this by email yesterday as well.]

Sincerely,

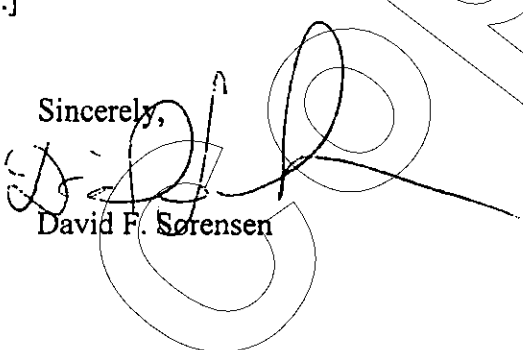
David F. Sorensen

cc: Mark Samson (by email)
Mike Lee (by email)

DOC# 361076

11/27/2012 04:15 PM Page: 146 of 183
AFF R: \$10.00 J. C. Sloan, McKinley County

2022-011769 MISC Page: 2048 of 2782
09/26/2022 03:35:37 PM Receipt #: 22-9381
Rec Fee: \$30.00 Darrell James Hill
Gila County, Az, Sadie Jo Bingham, Recorder

DOC# 361061

11/27/2012 01:09 PM Page: 145 of 178
AFF R: \$10.00 J. C. Sloan, McKinley County

Item No. 4

Item 4:
Encl. B

Affidavit: Status Statement, Response to Commissioner SSA
Affidavit of Citizenship, Domicile, and Tax Status, October 2012
(John Astrue, Commissioner, SSA c/o President Barack Obama)
USPO CMN: 7009 2820 0003 8851 6179
Accepted: October 19, 2012

DOCH 361076

11/27/2012 04:15 PM Page: 147 of 183
AFF R:\$10.00 J. C. Sloan, Mckinley County



2022-011769 MISC Page: 2049 of 2782
09/26/2022 03:35:37 PM Receipt #: 22-9381
Rec Fee: \$30.00 Darrell James Hill
Gila County, Az, Sadie Jo Bingham, Recorder



DOCH 361061

11/27/2012 01:09 PM Page: 146 of 178
AFF R:\$10.00 J. C. Sloan, Mckinley County



Darrell James, Hill
28 Hilltop Court, HC 61, Box 771, Ramah, New Mex.

CMN: 7009 2820 0003 8851 6179

ENCLOSURE B

Unofficial Copy

2022-011769 MISC Page: 2050 of 2782
09/26/2022 09:35:37 PM Receipt #: 22-9381
Rec Fee: \$30.00 Darrell James Hill
Gila County, Az, Sadie Jo Bingham, Recorder



DOCH 361061

11/27/2012 01:09 PM Page: 147 of 178
AFF R: \$10.00 J. C. Sloan, McKinley County



DOCH 361076

11/27/2012 04:15 PM Page: 148 of 189
AFF R: \$10.00 J. C. Sloan, McKinley County



Darrell James, Hill, and Beverly Jean, Romero-Hill
28 Hilltop Court, HC 61, Box 771, Ramah, New Mex.

USPO RMN: RE 430 969 752 US

President Barack Hussein Obama
The White House
1600 Pennsylvania Avenue NW
Washington, DC. 20500

Re: 2ND -Commissioner Astrue c/o President Barack H. Obama: Response Letter;
Affidavits (attached)

Dear Mr. President:

AGAIN, we write: Our name is Hill: Darrell James, Hill, husband, and wife Beverly Jean Romero- Hill. We are American Citizens born in states of the union of States of America. We trust in the God of Abraham, Isaac and Jacob; keep the commandments of the Most High God YHVH sacred, and have the testimony of His Son Yushuah, the Almighty God.

This is our SECOND USPO Registered Mail letter to Commissioner Astrue c/o You, continued upon the same matter: See USPO RMN RE430969426US.

The Commissioner's Response Letter Request

Clearly, the Commissioner's letter content is simply misguided (See a copy of his "TEH2A, 129010X8" LETTER enclosed, 1 page), as we are plainly not the "persons" and etc. other statutory terms whereupon the Commissioner's response presumes to validate his position. The enclosed Affidavits resolve this actual or feigned ignorance (see the AFFIDAVIT OF CITIZENSHIP, DOMICILE, AND TAX STATUS, (2) enclosed).

What We want you Barack to do – in finality

Commit the letter to the addressee, and, this time ORDER the Commissioner to WITH NO FURTHER DELAY obey our decrees and demands under obligation to the Constitution for United States of America. NO excuses or other ignorant positions; get this done!

Sincerely;

 10/11/2012

Darrell James, Hill (husband)
Sovereign Citizen of the United States of America



Beverly Jean, Romero-Hill (wife)
Sovereign Citizen of the United States of America

Enclosure: "TEH2A, 129010X8" LETTER from Commissioner SSA (1 page)

AFFIDAVIT OF CITIZENSHIP, DOMICILE, AND TAX STATUS, to Commissioner of SSA from husband (18 pages)

AFFIDAVIT OF CITIZENSHIP, DOMICILE, AND TAX STATUS, to Commissioner of SSA from wife (18 pages)

2022-011769 MISC Page: 2051 of 2782
09/26/2022 03:35:37 PM Receipt #: 22-9381
Rec Fee: \$30.00 Darrell James Hill
Gila County, Az, Sadie Jo Bingham, Recorder



bama (0) DOCH 361061

11/27/2012 01:09 PM Page: 148 of 178
AFF R:\$10.00 J. C. Sloan, Mckinley County



DOCH 361076

11/27/2012 04:15 PM Page: 149 of 189
AFF R:\$10.00 J. C. Sloan, Mckinley County





SOCIAL SECURITY

TEH2A
129010X8

October 1, 2012

Mr. and Mrs. Darrell J. Hill
28 Hilltop Court
Ramah, New Mexico 87321

Dear Mr. and Mrs. Hill:

Thank you for your September 18, 2012 letter about the Social Security program. People cannot voluntarily end their participation in the program. Under Federal law, it is mandatory that everyone pay Social Security taxes, regardless of the citizenship or place of residence of either the employer or the employee. Unless specifically exempt by law, everyone working in the United States must pay Social Security taxes.

Similarly, people cannot withdraw the Social Security taxes that they have already paid. We do not place Social Security taxes paid by employees and employers in individual accounts but use them to pay benefits to workers and their families today. A person must voluntarily file an application to receive these benefits.

The law (Section 205 of the Social Security Act) requires the Social Security Administration to maintain records of workers' earnings and to establish any other records necessary to carry out our responsibilities under the Social Security Act. Since many people have the same name, or change their name, we needed a reliable and permanent system to distinguish one individual from another in our records. Congress established the Social Security number system to meet that need.

The Supreme Court has upheld the constitutionality of the Social Security system, as established by the Social Security Act, and mandatory individual participation. We will not respond further to your correspondence about voluntary participation in the Social Security program or the withdrawal of Social Security taxes.

The Internal Revenue Service has jurisdiction over the issue of liability for Social Security taxes; the United States Citizenship and Immigration Services has jurisdiction over the issue of citizenship. If you have questions about those subjects, you should contact one of those offices.

Social Security Administration

Copy

DOCH 361076

11/27/2012 04:15 PM Page: 150 of 183
AFF R:\$10.00 J. C. Sloan, McKinley County



2022-011769 MISC Page: 2052 of 2782
09/26/2022 03:35:37 PM Receipt #: 22-9381
Rec Fee: \$30.00 Darrell James Hill
Gila County, Az, Sadie Jo Bingham, Recorder



DOCH 361061

11/27/2012 01:09 PM Page: 149 of 178
AFF R:\$10.00 J. C. Sloan, McKinley County



AFFIDAVIT OF CITIZENSHIP, DOMICILE, AND TAX STATUS

SECTION 1: SUBMITTER INFORMATION

1. Name	Darrell James, Hill		
2. Mailing Address (NOT a domicile)	28 Hilltop Court, HC 62 Box 771		
3. City	Ramah	4. State	New Mexico
5. Zip	[87321]	6. Country	The United States of America
7. Phone	505.783.2499	8. Email	djhill4yah@yahoo.com
9. Date of Birth:	1958 November 20	10. Place of Birth:	Ohio
11. citizenship:	Nonresident alien NON-Individual: See explanation (following)	12. DOMICILE:	Transient Foreigner: See explanation (following)

11. CITIZENSHIP

I am a Constitutional but not statutory "Citizen": "national" but not "citizen" under federal law pursuant to 8 U.S.C. §1101(a)(21) and 8 U.S.C. §1452. Born in state of the Union and a "nonresident" (per 26 U.S.C. 7701(b)(1)(B)) but NOT an "alien" (per 26 U.S.C. 7701(b) (1)(A) or "Individual" (Per 26 CFR §1.441-1(c)(3)); "Stateless Person" as per Newman-Green v. Alfonso Larrain, 490 U.S. 826 (1989); Constitutional diversity of citizenship pursuant to U.S. Const. Art. III, Section 2, but NOT statutory diversity pursuant to 28 U.S.C. §1332. Rebut the preceding if you disagree within 30 days or you stipulate it as truth.

12. DOMICILE:

I have chosen my domicile as Not within any government on earth.

I choose not to politically associate with any group or government on earth for my protection. The First Amendment to the Constitution protects my right of freedom from compelled association. I am a "transient foreigner" but not an "inhabitant" of the place where I live.

Choice of my domicile and becoming a taxpayer require my consent. Rebut the proceeding within 30 days if you disagree or forever be stopped from later challenging it.

13. FEDERAL FRANCHISES

13.1. Submitter is not subject to the Internal Revenue Code Subtitle A "trade or business" franchise/excise tax. Also called "income tax": "trade or business is defined in 26 U.S.C. §7701(a)(26) as "function of a public office" in the government. Those not engaged are a "foreign estate" pursuant to 26 U.S.C. §7701(a)(31).

PRIVATE RECIPIENTS OF THIS FORM: You are warned that you may NOT use any of the information provided by the Submitter of this form or any of the attached forms to submit to the government or for ANY commercial purpose. This means you may not use any of the information provided to prepare or submit any IRS information return, such as forms W-2, 1042S, 1098, 1099, K-1, etc. and that if you do you risk criminal prosecution under the provisions of 26 U.S.C. §57206, 7207, 18 U.S.C. §654, and 18 U.S.C. §912. This document also constitutes an indemnification of all personal liability of the private recipient for failure to withhold or report. Submitter agrees to accept all legal consequences for following the context of this form and to become the Substitute Defendant in an action against the Private Recipient for following the requirements of this affidavit. This indemnification does NOT apply to government recipients.

GOVERNMENT RECIPIENTS OF THIS FORM: You are hereby legally notified that any information returns you may have received connected with me, such as W-2, 1042S, 1098, and 1099, are FALSE and FRAUDULENT and this submission constitutes a formal request to correct the false reports and criminally prosecute the submitter to 26 U.S.C. §57206, 7207, 18 U.S.C. §654, and 18 U.S.C. §912 and civilly prosecute pursuant to 26 U.S.C. §7434 and 31 U.S.C. §3729. Any numbers associated with these reports are provided under duress and are not "Social Security Numbers" as defined in 20 CFR §422.104 but rather PRIVATELY issued "Nontaxpayer Identification Numbers" which are protected by copyright and private license agreement and may NOT be stored in any government computer system or used for ANY commercial purpose without violating the license agreement.

13.2. Submitter is a Social Security non-volunteer (See 42 U.S.C. Chapter 7). Any application on file are fraudulent and nullity for any one or more of the following reasons: 1. Never personally made application and therefore nonbinding; 2. Never consented to participate; 3. Cannot lawfully consent because not domiciled on federal territory and not a "U.S. citizen" per 8 U.S.C. §1401 or a "permanent resident" at the time of application in violation of 20 CFR §422.104; 4. Am not a fiduciary acting

2022-011769 MISC Page: 2053 of 2782

09/26/2022 03:35:37 PM Receipt #: 22-9381
 Rec Fee: \$30.00 Darrell James Hill
 Gila County, Az, Sadie Jo Bingham, Recorder



hip, D

DOC# 361061

11/27/2012 01:09 PM Page: 150 of 178
 AFF R:\$10.00 J. C. Sloan, McKinley County



11/27/2012 04:15 PM Page: 151 of 183
 AFF R:\$10.00 J. C. Sloan, McKinley County
 DOC# 361076

AFFIDAVIT OF CITIZENSHIP, DOMICILE, AND TAX STATUS

Date that UNLAWFUL SSA participation was retroactively terminated was May 22, 2006 (Date SSA Form 521 was mailed to SSA and IRS).

- 13.3. Submitter is not a Federal elected or appointed "public officer".
- 13.4. Submitter is not an "employee" as defined in 26 U.S.C. §3401(c) and 26 CFR §31.3401(c)-1.
- 13.5. Submitter has a State-issued driver's license. Corporate (not de jure) State name: Arizona
- 13.6. Submitter has a State issued marriage license.
- 13.7. Submitter does not possess an Attorney license (Admitted to practice by state-supreme Court).
- 13.8. Submitter has no lawful federal government identifying number.

WARNING: You may not use any government issued identifying number in connection with the Submitter, such as a Social Security Number (SSN) as defined in 20 CFR 422.103(d), Taxpayer Identification Number (TIN) as defined in 26 U.S.C. 6109, or Employer Identification Number (EIN) as defined in 26 U.S.C. 6109.

Submitter:

1. Would be violating the law to either request or use a Taxpayer Identification Number. See **AFFIRMATION, WHY IT IS ILLEGAL FOR ME TO REQUEST OR USE A TAXPAYER IDENTIFICATION NUMBER** (attached).
2. Is not required to have or to use a Social Security Number or Taxpayer Identification Number pursuant to 31 CFR §103.34(a)(3)(x) and 31 CFR §306.10, Note 2.
3. Does not participate and is not lawfully eligible to participate in Social Security or the "trade or business" excise taxable franchise described in 26 U.S.C. Subtitle A.
4. Is not an "alien" for which an Individual Taxpayer Identification Number may lawfully be used pursuant to 26 CFR §301.6109-1(d)(3). Nonresident aliens are NOT "aliens" are not equivalent. A human being who is a "national" can be a "nonresident alien" with being an "alien". See 26 U.S.C. §7701(b)(1)(A) and 26 U.S.C. §7701(b)(1)(B).
5. May not lawfully use or possess any government identifying number because it is "public property" which belongs to the government pursuant to 20 CFR §422.103(d). Only "public officers" on official business may lawfully use public property, and only in strict accordance with law for the benefit of the government and not them as private individuals.
6. Is appearing as a private person and not a public officer. If you compel me to use a government identifying number, you are an accessory to criminal conversion of private property to a public use and a public purpose if you connect me or my assets with a public number in violation of 18 U.S.C. § 654. You could end up in jail for ten years if you put an identifying number on any records pertaining to me or my property, assets, or my earnings from PRIVATE employment.
7. Has been a victim of identity theft, compelled association, and conversion by the government and its agents in banks and financial institutions in the past by unlawfully and involuntarily connecting them with knowingly false and fraudulent identifying numbers in criminal violation of 18 U.S.C. §1028A, and a civil violation of 42 U.S.C. §408(a)(7) and 42 U.S.C. §405(c)(2)(C)(i). He would like to prevent a recurrence of this behavior again.
8. Will file a criminal complaint in connection with the use of any government issued identifying number connected with his exclusively PRIVATE life, property, and liberty and vociferously prosecute all those who unlawfully compel him to use a knowingly false number or any number at all in order to obtain any service or product in violation of 42 U.S.C. §408.

WARNING: Any Social Security Number or Taxpayer Identification Number you have on file is FALSE and must be removed from your records. Failure to abide by this absolute requirement of law is a criminal violation of 18 U.S.C. §1028(a)(7); 18 U.S.C. §1028A, and a civil violation of 42 U.S.C. §408 and 42 U.S.C. §405(c)(2)(C)(i).

14. DOMICILE AND RESIDENCE

1. My domicile and NOT "residence" is that indicated earlier on Item 12 above.
2. My domicile is outside the statutory but not constitutional "United States" and outside of federal territory. The Term "statutory United States" includes all statutory definitions of "United States" within any act of Congress.
3. I am not a statutory "resident". All "residents" are statutory "aliens" per 26 U.S.C. §7701(b)(4).
4. I DO NOT have a statutory "residence" anywhere within the statutory "United States" per 26 CFR §1.871-2(b) because I am not a statutory "alien".

If you believe that the term "residence" includes the domicile of those who are non-citizen nationals, nonresident alien NON-individuals, please produce a statute that expressly includes this status within the meaning of the term "residence".

2022-011769 MISC Page: 2054 of 2782
09/26/2022 03:35:37 PM Receipt #: 22-9381
Rec Fee: \$30.00 Darrell James Hill
Gila County, Az, Sadie Jo Bingham, Recorder



nship, D

DOCH 361061

11/27/2012 01:09 PM Page: 151 of 178
AFF R: \$10.00 J. C. Sloan, McKinley County



DOCH 361076

11/27/2012 04:15 PM Page: 152 of 183
AFF R: \$10.00 J. C. Sloan, McKinley County



AFFIDAVIT OF CITIZENSHIP, DOMICILE, AND TAX STATUS

5. **WARNING:** You may not lawfully withhold any amount from proceeds due to me. The remainder of this section provides legally admissible evidence proving why this is.
6. Your withholding is ONLY on "wages" as legally defined in 26 U.S.C. §3401. The earnings of nonresident alien NON-individuals not engaged in a "trade or business" as legally defined are excluded from "wages" per 26 U.S.C. §3401(a)(6) and 26 U.S.C. §3401(a)(11) and therefore may not lawfully become the subject of tax withholding. If you withhold, you will therefore be guilty of the following crimes:
- 6.1. 18 U.S.C. §654: Conversion of private property to a "public use" and a "public office". You are converting my PRIVATE proceeds as a class member into a public purpose and a "public office" by fraudulently and falsely connecting same with a "trade or business".
- 6.2. 18 U.S.C. §201: Bribery of public officials and witnesses. You are bribing public officials who will receive the money you STOLE from me in violation of the law. The punishment is a fine and up to 15 years in jail. I remind you that all tax withholdings are classified as "gifts" by the IRS. See IRS Document 6209, pp. 4-1 and 4-2, which identify W-2 forms as "Estate and gift taxes". All tax withholdings are "gifts" to public officials that also constitute bribes.
- 6.3. 18 U.S.C. §1956(a)(1)(A)(ii): Money laundering. You are laundering unlawfully withheld proceeds. The punishment is a fine up to \$500,000 and imprisonment for up to twenty years.
7. IRS Publication 515 indicates that nonresident alien individuals who give you IRS form W-8BEN are exempt from backup withholding. This requirement is also found in 26 U.S.C. § 3401(a)(6) or 26 CFR §31.3401(a)(6)-1(b). This Affidavit serves the equivalent of IRS Form W-8BEN because IRS doesn't have a form for those who are "nonresident aliens" but who are not "individuals", "persons", or "taxpayers".

"Foreign persons who provide Form W-8BEN, Form W-8ECI, or Form W-8EXP (or applicable documentary evidence) are exempt from backup withholding and Form 1099 reporting."
[IRS Publication 515, Year 2001, p.3]

8. You MAY NOT lawfully tamper with, reject, redact any portion of, or alter any withholding form that I give you. You must accept them AS IS and may not lawfully threaten me to change them. If you do, you could be prosecuted for extortion.

"The employer is not authorized to alter the form or to dishonor the employee's claim. The certificate goes into effect automatically in accordance with certain standards enumerated in §3402(f)(3)."
[U.S. v. Malinowski, 347 F.Supp. 347 (1972)]

9. The proceeds connected with our relationship do not constitute "income" and therefore cannot be the subject of any tax or withholding or reporting within the Internal Revenue Code. The only definition of "income" in the Internal Revenue Code is found in 26 U.S.C. §643(b) and it includes ONLY the earnings of a trust or estate. I am not representing a domestic trust or estate. My earnings and my entire estate instead are a "foreign estate" pursuant to 26 U.S.C. §7701(a)(31).

10. Any earnings that result from our relationship do not originate from "sources within the United States". The term "United States" is defined below.

If you dispute this definition, please provide the definition that expressly identifies states of the Union as being included in the meaning of "United States".

TITLE 26 > Subtitle F > CHAPTER 79 > Sec. 7701.
Sec. 7701. - Definitions

(a) Definitions

(9) United States

The term "United States" when used in a geographical sense includes only the States and the District of Columbia.

(10) State

The term "State" shall be construed to include the District of Columbia, where such construction is necessary to carry out provisions of this title.

TITLE 4 – FLAG AND SEAL, SEAT OF GOVERNMENT, AND THE S

Affidavit of Citizenship, Domicile,

DOC# 361061

11/27/2012 01:09 PM Page: 152 of 178
AFF R: \$10.00 J. C. Sloan, McKinley County

2022-011769 MISC Page: 2055 of 2782

09/26/2022 03:35:37 PM Receipt #: 22-9381
Darrell James Hill
Rec Fee: \$30.00
Saddle Creek, Birmingham, Recorder
Gila County, AZ

DOC# 361076

11/27/2012 04:15 PM Page: 153 of 183
AFF R: \$10.00 J. C. Sloan, McKinley County

AFFIDAVIT OF CITIZENSHIP, DOMICILE, AND TAX STATUS

CHAPTER 4 – THE STATES

Sec. 1210. Same; definitions

(d) The term "State" includes any Territory or possession of the United States.

"Expression unius est exclusio alterius. A maxim of statutory interpretation meaning that the expression of one thing is the exclusion of another. Burgin v. Forbes, 293 Ky. 456, 169 S.W.2d 321, 325; Newblock v. Bowles, 170 Okl. 487, 40 P.2d 1097, 1100. Mention of one thing implies exclusion of another. When certain persons or things are specified in a law, contract, or will, an intention to exclude all others from its operation may be inferred. Under this maxim, if statute specifies one exception to a general rule or assumes to specify the effects of a certain provision other exceptions of effects are excluded."

[Black's Law Dictionary, Sixth Edition, p. 581]

11. The financial transactions likely to result from relationship are excluded from (not "subject to" but not "exempt") taxation pursuant to the following authorities and therefore not subject to withholding:
- 11.1. 26 U.S.C. § 861(a)(3)(C)(i): Earning from labor of "nonresident aliens" not engaged in a "trade or business" and working in the "United States" is not deemed to be income from sources within the "United States".
 - 11.2. 26 U.S.C. § 3401(a)(6): Nonresident aliens do not earn "wages".
 - 11.3. 26 U.S.C. § 1402(b): Nonresident aliens do not earn "self-employment income".
 - 11.4. 26 U.S.C. § 864(b)(1)(A): Earning of "nonresident aliens" working for foreign employers such as private employers do not have earnings associated with a "trade or business in the United States"
 - 11.5. 26 CFR § 31.3401(a)(6)-1(b): Remuneration of nonresident aliens outside the "United States" is not subject to taxation.
 - 11.6. 26 CFR § 1.872-2(f): Earning of nonresident aliens outside "United States" do not constitute "gross income".
 - 11.7. 26 CFR § 1.871-7(a)(4): Nonresident aliens not engaged in a "trade or business" earn no "gross income".
12. Tax withholding is only appropriate for those having a tax liability. A nonresident alien NON-individual such as the submitter with no "income" or earning from "sources within the United States" under 26 U.S.C. § 871 can have no tax liability. If you think you, as a private employer or private institution constitutes a "source within the United States", then why did the IRS Internal Revenue Manual say the following and where are the states of the Union included in "United States" as defined above?:

IRM 5.14.10.2 (09-30-2004)

Payroll Deduction Agreements

2. Private employers, states, and political subdivisions are not required to enter into payroll deduction agreements. Taxpayers should determine whether their employers will accept and process executed agreements before agreements are submitted for approval or finalized.

[<http://www.irs.gov/irm/part5/ch14s10.html>]

13. You can only be an "employer" if I am an "employee", according to 26 U.S.C. § 3401(d). I am NOT an "employee", because all "employees" are "public officers" engaged in a "trade or business" who work for the United States government as the equivalent of "temps" or "Kelly Girls" on loan to private employers such as you. I DO NOT consent to act in such capacity, and therefore you cannot be an "employer" in the context of me"

26 CFR § 31.3401(c)-1 Employee:

"...the term [employee] includes [is limited to] officers and employees, whether elected or appointed, of the United States, a [federal] State, Territory, Puerto Rico or any political subdivision, thereof, or the District of Columbia, or any agency of instrumentality of any one of more of the foregoing. The term 'employee' also includes an officer of a corporation."

26 U.S.C. § 3401(c) Employee

For purpose of this chapter, the term "employee" includes [is limited to] an officer, employee, or elected official of the United States, a State, or any political thereof, or the District of Columbia, or any agency or instrumentality of any one or more of the foregoing. The term "employee" also includes an officer of a corporation.

Affidavit of Citizenship, Domicile

DOC# 361061

11/27/2012 01:09 PM Page: 153 of 178
AFF R: \$10.00 J. C. Sloan, Mckinley County

2022-011769 MISC Page: 2056 of 2782
09/26/2022 03:35:37 PM Receipt #: 22-9381
Reg Fee: \$30.00 Darrell James Hill
Gilla County, Az, Sadie Jo Bingham, Recorder

DOC# 361076

11/27/2012 04:15 PM Page: 154 of 183
AFF R: \$10.00 J. C. Sloan, Mckinley County

AFFIDAVIT OF CITIZENSHIP, DOMICILE, AND TAX STATUS

8 Federal Register, Tuesday, September 7, 1943, §404.104, pg 12267

Employee: "The term employee specifically includes officers and employees whether elected or appointed, of the United States, a state, territory, or political subdivision thereof or the District of Columbia or any agency or instrumentality of any one or more of the foregoing."

If you disagree with this item, please rebut the foregoing within 30 days or be held in default and estoppels to challenge later.

14. You are only liable to withhold if you are an "employer" and if I receive "wages". 26 CFR 31.3403-1, 26 CFR §31.3111-4, 26 CFR §3102-1(c). The only way I can receive "wages" is to sign a contract called a W-4 absent duress consenting to call what proceeds I receive "wages" as legally defined but not commonly understood. If I don't sign the contract, then I don't earn "wages" subject to any withholding or reporting:

"Every man has a natural right to the fruits of his own labor, is generally admitted; and no other person can rightfully deprive him of those fruits, and appropriate them against his will..."
[The antelope, 23 U.S. 66: 10 Wheat 66, 6 L.Ed. 268 (1825)]

"Included in the rights of personal liberty and the right of private property—partaking of the nature of each—is the right to make contracts for the acquisition of property. Chief among such contracts is that of personal employment, by which labor and other services are exchanged for money or other forms or property."

"...The right of a person to sell his labor upon such terms as he deems proper is, in its essence, the same as the right of the purchaser of labor to prescribe the conditions under which he will accept such labor from the person offering to sell it."

26 CFR §31.3401(a)-3 Amounts deemed wages under voluntary withholding agreements

(a) In general.

Notwithstanding the exceptions to the definition of wages specified in section 3401(a) and the regulations thereunder, the term "wages" includes the amounts described in paragraph (b)(1) of this section with respect to which there is a voluntary withholding agreement in effect under section 3402(p). References in this chapter to the definition of wages contained in section 3410(a) shall be deemed to refer also to this section (§31.3401(a)-3).

Title 26 - Internal Revenue

PART 31—EMPLOYMENT TAXES AND COLLECTION OF INCOME TAX AT SOURCE

Subpart E—Collection of Income Tax at Source

§31.3402(p)-1 Voluntary withholding agreements

(a) In general.

An employee and his employer may enter into an agreement under section 3402(b) to provide for the withholding of income tax upon payments of amounts described in paragraph (b)(1) of §31.3401(a)-3, made after December 31, 1970. An agreement may be entered into under this section only with respect to amounts which are includible in the gross income of the employee under section 61, and must be applicable to all such amounts paid by the employer to the employee. The amount to be withheld pursuant to an agreement under section 3402(p) shall be determined under the rules contained in section 3402 and the regulations thereunder. See §31.3405(c)-1, Q&A-3 concerning agreements to have more than 20-percent Federal income tax withheld from eligible rollover distributions with the meaning of section 402.

Affidavit of Citizenship, E

DOCH 361061

11/27/2012 01:09 PM Page: 154 of 178
AFF R: \$10.00 J. C. Sloan, McKinley County



2022-011769 MISC Page: 2057 of 2782

09/26/2022 03:35:37 PM Receipt #: 22-9381
Darrell James Hill Recorder
Rec Fee: \$30.00 Sadie Jo Bingham
Gila County, AZ



DOCH 361076

11/27/2012 04:15 PM Page: 155 of 183
AFF R: \$10.00 J. C. Sloan, McKinley County



AFFIDAVIT OF CITIZENSHIP, DOMICILE, AND TAX STATUS

15. If I never give you an IRS form W-4 and thereby consent to call what proceeds I am due "wages" as defined in the Internal Revenue Code, then you can't lawfully withhold or report anything:

15.1. Everything that goes on the IRS form W-2 constitutes "wages" as legally defined and not commonly understood.

15.2. Tax withholding ONLY pertains to "wages" as legally defined and NOT all earnings. The U.S. Supreme Court confirmed this:

"We must reject in this case, as we have rejected in cases arising under the Corporation Excise Tax Act of 1909 (Doyle, Collector, v. Mitchells Brother Co., 247 U.S. 179, 38 Sup. Ct. 467, 62 L. Ed. —) the broad contention submitted on behalf of the government that all receipts—everything that comes in—are income with the proper definition of the term 'gross income.' And that the entire proceeds of a conversion of capital assets, in whatever form and under whatever circumstances accomplished, should be treated as gross income. Certainly the term 'income' has no broader meaning in the 1913 act than in that of 1909 (See Stratton's Independence v. Howbert, 231 U.S. 399, 416, 417 S., 34 Sup. Ct. 136), and for the present purpose we assume there is no difference in its meaning as used in the two acts."
[Southern Pacific Co., v. Lowe, 247 U.S. 330, 335, 38 S. Ct 540 (1918)]

15.3. If you are ordered by the IRS, et al., to withhold proceeds because I refuse to submit an IRS for W-4, then you must withhold and report ONLY on "wages" as statutorily defined and limited pursuant to the I.R.C. "trade or business" franchise agreement. I don't earn "wages" if I never consented to call them "wages" using a private contract called an IRS form W-4.

16. On the subject of unlawful withholding the Bible say the following. "Wages" as used below implies the ordinary and excludes the statutory definition:

"Woe to him who builds his house by unrighteousness
And his chambers by injustice,
Who [whether individual or government] uses his neighbor's service without wages
And give him nothing for his work
[Jer. 22:13, Bible, NKJV]

"Come now, you rich, weep and howl for your miseries that are coming upon you! Your riches are corrupted, and your garments are moth-eaten. Your gold and silver are corroded, and their corrosion will be a witness against you and will eat your flesh like fire. You have heaped up treasure in the last days. Indeed the wages of the laborers who mowed your fields, which you kept back by fraud, cry out; and the cries of the reapers have reached the ears of the Lord of Saboath. You [business owner who control the purse of the workers] have lived on the earth in pleasure and luxury; you have fattened your hearts as in a day of slaughter. You have condemned, you have murdered the just, he does not resist you."
[James 5:1-6, Bible, NKJV]

"You shall not cheat your neighbor, nor rob him. The wages of him who is hired shall not remain with you all night until morning."
[Lev. 19:13, Bible, NKJV]

16. TAX REPORTING LEGAL REQUIREMENTS:

1. **WARNING:** It is a criminal offense to file information returns against any payments you make in connection with our relationship. Filing of false information returns carries severe civil and criminal penalties. Information returns include IRS Forms W-2, 1042S, 1098, and 1099.

I can only earn "wages" reportable on an IRS form W-2 if I am lawfully engaged in a "public office" in the U.S. Government as required by 26 U.S.C. §6041(a). Voluntarily signing a contract/agreement called an IRS form W-4 is the only way that a nonresident alien NON-individual not engaged in a "trade or business" can engage in such a "public office" per 26 CFR §31.3401(a)-3(a), and 26 CFR 31.3402(p)-1. Otherwise, it is a crime to impersonate a public officer in violation of 18 U.S.C. §912 to file an information return. If you file any kind of information return relating to me, you will be guilty of conspiracy to commit all the following crimes and civil infractions:

- 1.1. False information returns submitted in violation of 26 U.S.C. §7434. Punishment is all attorney fees plus twice the false amount reported.
- 1.2. Impersonating a public officer in violation of 18 U.S.C. §912. Punishment is a fine and up to three years in jail. Only "public officers" can act as "taxpayers", and you are creating a false presumption that I am a "taxpayer" by filing false information returns.

Affidavit of Citizenship, I

DOCH 361061

11/27/2012 01:09 PM Page: 155 of 178
AFF R:\$10.00 J. C. Sloan, McKinley County



2022-0111769 MISC Page: 2058 of 2782
09/26/2022 03:35:37 PM Receipt #: 22-9381
Rec Fee: \$30.00 Darrell James Hill
Gila County, Az, Sadie Jo Bingham, Recorder

DOCH 361076

11/27/2012 04:15 PM Page: 156 of 183
AFF R:\$10.00 J. C. Sloan, McKinley County

2049

AFFIDAVIT OF CITIZENSHIP, DOMICILE, AND TAX STATUS

the estate or trust for the taxable year determined under the terms of the governing instrument and the applicable local law. Items of gross income constituting extraordinary dividends or taxable stock dividends which the fiduciary, acting in good faith, determines to be allocable to corpus under the terms of the governing instrument and applicable local law shall not be considered income.

IRS Form 1042-S may only be prepared in the case of statutory "nonresident aliens" (per 26 U.S.C. §7701(b)(1)(B)) who have "income" from "sources within the statutory but not constitutional "United States" that is not connected with a "trade or business" and therefore constitutes "gross income" with the meaning of 26 U.S.C. §61. All such sources are expressly indicated in 26 U.S.C. §871(a). All of these sources are government payments. The transactions likely to occur between us are NOT government payments and are not listed in 26 U.S.C. §871(a), and therefore may not lawfully be reported.

SECTION 2: AFFIDAVIT OF TAX STATUS

Human being (but not statutory "Person") who signed this form hereby affirms under penalty of perjury from WITHOUT the statutory "United States" per 28 U.S.C. §1746(1) that:

1. Submitter has NO tax liability or "gross income" pursuant to 26 CFR §1.872-2(f), 26 CFR §1.871-1(a), and 26 U.S.C. §861(a)(C)(i) and therefore no need to deduct or withhold.

2. Submitter is not a statutory "taxpayer" as defined in 26 U.S.C. §7701(a)(14) and not subject to the revenue laws.

"Revenue Laws relate to taxpayers [instrumentalities, officers, employees, and elected officials of the Federal Government] and not to non-taxpayers [American Citizens/American Nationals not subject to the exclusive jurisdiction of the Federal Government and not engaged in the "trade or business" franchise as a public officer]. The latter are without their scope. No procedures are prescribed for non-taxpayers and no attempt is made to annul any of their Rights or Remedies in due course of law. With them [non-taxpayers] Congress does not assume to deal and they are neither of the subject nor of the object of federal revenue laws."

[Economy Plumbing & Heating v. U.S., 470 F.2d. 585 (1972)]

3. Submitter is not "exempt" or an "exempt individual" as defined in 26 U.S.C. §7701(b)(5) because one must otherwise be subject to the I.R.C. to be such a legal "person". Rather, Submitter is "not subject" to Internal Revenue Code Subtitle A franchise agreement and is a nonresident. Since IRS forms very deliberately do not have a block for "not subject" and are only for use by those who are "taxpayers", Submitter had to make his own form, THIS DOCUMENT, to avoid committing perjury on a government form in describing his status under penalty of perjury. Those who are "not subject" are described NOT as a "person", "individual", or "taxpayer", but simply as "foreign" or a "foreign estate" in 26 U.S.C. §7701(a)(31).

TITLE 26 > Subtitle F > CHAPTER 79 > § 7701
§7701. Definitions

(a) Definitions

(31) Foreign estate or trust

(A) Foreign estate

The term "foreign estate" means an estate the income of which, from sources without the United States which is not effectively connected with the conduct of a trade or business within the United States, is not includible in gross income under subtitle A.

4. Submitter is a "nonresident" as statutorily defined pursuant to 26 U.S.C. § 7701(b)(1)(B) but not a "nonresident alien individual". A "nonresident alien" is defined as one who is "neither a citizen nor a resident" of the "United States", which is exactly what an "American National", or national born in a state of the Union who is not domiciled on federal territory in the "United States" is. The only withholding form that a "nonresident" who is neither a statutory "alien" (per 26 U.S.C. §7701(b)(1)(A)) nor an "individual" (per 26 CFR §1.1441-1(c)(3) and 5 U.S.C. §2105(a)) and who is not engaged in federal franchises can fill out is a W-8BEN with block 3 modified to add the word "nontaxpayer" or "human being" to it. All statutory "taxpayers" and "individuals" are "aliens" per 26 CFR §1.1441-1(c)(3) and public officers in the national and not state government, and therefore submitter cannot check the "individual" block of the W-8BEN form without committing perjury. Even statutory "U.S. Citizens" per 26 CFR §1.1-1(c) and 26 U.S.C. §3121(e) must be aliens in relation to a foreign country under a tax treaty per 26 U.S.C. §911 in order to be "taxpayers".

DOCH 361061

Affidavit of Citizenship, C

11/27/2012 01:09 PM Page: 157 of 178
AFF R: \$10.00 J. C. Sloan, Mokinley County



2022-011769 MISC Page: 2059 of 2782
09/26/2022 03:35:37 PM Receipt #: 22-9381
Rec Fee: \$30.00 Darrell James Hill
Gila County, Az., Sadie Jo Bingham, Recorder

DOCH 361076

11/27/2012 04:15 PM Page: 158 of 183
AFF R: \$10.00 J. C. Sloan, Mokinley County

AFFIDAVIT OF CITIZENSHIP, DOMICILE, AND TAX STATUS

- 1.3. Conversion of private property to a public use, public purpose, and public office as a "withholding agent" in violation of 18 U.S.C. §654.
- 1.4. Impersonating a public officer in violation of 18 U.S.C. §911. Punishment is a fine and up to three years in jail. Only *statutory* and not *constitutional* "U.S. citizens" can lawfully act as "public officers" engaged in a "trade or business" and I am NOT a statutory "U.S. citizen" pursuant to 8 U.S.C. §1401 but rather a non-citizen national.
- 1.5. False information returns in violation of 26 U.S.C. §7206. Punishment is up to a \$100,000 fine and 3 years in jail to file a false information return.
- 1.6. False information returns in violation of 26 U.S.C. §7207. Punishment is up to \$10,000 and 1 year in jail to submit a false information return.
- 1.7. Perjury in violation of 18 U.S.C. §1001 and 18 U.S.C. §1621. The IRS Forms W-3 and 1096 submitted with the information return is signed under penalty of perjury and verifies the accuracy of the accompanying information return. These forms are submitted as a government officer and agent called a "withholding agent" defined in 26 U.S.C. 7701(a)(16). Those forms are FRAUDULENT now that you have been notified that they are false and you willfully refuse to either stop filing the false report or correct the false reports already filed.

2. IRS Publication 515 indicates that nonresident aliens who give you IRS form W-8BEN are exempt for 1099 reporting. This document serves the equivalent purpose and is a superset of that form.

"Foreign persons who provide Form W-8BEN, Form W-8ECI, or Form W-EXP (or applicable documentary evidence) are exempt from backup withholding and Form 1099 reporting."
[IRS Publication 515, Year 2001, p3]

3. 26 U.S.C. §6041 says that only earnings connected with a "trade or business" may be reported on an information return such as IRS forms W-2, W-3, 1042-S, 1096, and 1099.

TITLE 26 > Subtitle F > CHAPTER 61 > Subchapter A > PART III > § 6041
§ 6041. Information at source

(a) Payments of \$600 or more

All persons engaged in a trade or business and making payment in the course of such trade or business to another person, of rent, salaries, wages, premiums, annuities, compensations, remunerations, emoluments, or other fixed or determinable gains, profits and income (other than payments to which section 6042 (a)(1), 6044 (a)(1), 6047 (e), 6049 (a), or 6050N (a) applies, and other than payments with respect to which a statement is required under the authority of section 6042 (a)(2), 6044 (a)(2), or 6045), of \$600 or more in any taxable year, or in the case of such payments made by the United States, the officers or employees of the United States having information as to such payments and required to make returns in regard thereto by the regulations hereinafter provided for, shall render a true and accurate return to the Secretary, under such regulations and in such form and manner and to such extent as may be prescribed by the Secretary, setting forth the amount of such gains, profits, and income, and the name and address of the recipient of such payment.

4. None of the proceeds connected with our relationship pertains to a "trade or business" as statutorily defined below, and therefore is not subject to reporting:

26 U.S.C. Sec. 7701(a)(26)

"The term 'trade or business' includes the performance of the functions of a public office."

5. The term "income" is defined in 26 U.S.C. §643(b), and only "income" may be reported. Since I am NOT an "estate or trust" I earn no reportable "income".

TITLE 26 > Subtitle A > CHAPTER 1 > Subchapter J > PART I > Subpart A > §643
§643. Definitions applicable to subparts A, B, C, and D

(b) Income

For purpose of this subpart and subparts B, C, and D, the term "income, when not preceded by the words "taxable", "distributable net", "undistributed net", or "gross", means that amount of income of

Affidavit of Citizenship,

DOCH 361061

11/27/2012 01:09 PM Page: 156 of 178
AFF R: \$10.00 J. C. Sloan, McKinley County



2022-011769 MISC Page: 2060 of 2782

09/26/2022 03:35:37 PM Receipt #: 22-9381
Rec Fee: \$30.00 Darrell James Hill
Gila County, Az, Sadie Jo Bingham, Recorder



DOCH 361076

11/27/2012 04:15 PM Page: 157 of 183
AFF R: \$10.00 J. C. Sloan, McKinley County



2051

AFFIDAVIT OF CITIZENSHIP, DOMICILE, AND TAX STATUS

5. Submitter is not engaged in a "trade or business", which is defined in 26 U.S.C. § 7701(a)(26) as "the functions of a public office". Receipt of earnings from the District of Columbia in connection with a "trade or business" under 26 U.S.C. § 871(b) or not connected under 26 U.S.C. 871(a) are the only types of "gross income" or "taxable income" that nonresidents who are not aliens can have under I.R.C. Subtitle A.

6. Submitter is a "transient foreigner" but not a statutory "foreign person" or statutory "alien" in respect to the national government and federal territory. A human being or artificial entity such as a state corporation domiciled in a state of the Union is a "transient foreigner" but not a "person", "individual", or "foreign person" for the purposes of the Internal Revenue Code because the term "United States" is defined in 26 U.S.C. § 7701(a)(9) and (a)(10) as the District of Columbia and is nowhere expressly expanded to include any state of the Union.

7. Submitter is not in receipt of any treaty benefit under the terms of an income tax treaty with a foreign country.

8. Submitter has not made an election to be treated as a "resident alien" as defined in 26 U.S.C. 7701(b)(1)(A) under the authority of 26 U.S.C. § 6013(g) and (h).

9. Submitter is not a statutory "individual" as defined in 26 CFR §1.1441-1(c)(3) or a "person" as defined in 26 U.S.C. § 7701(c) because not domiciled or resident on federal territory and not eligible or consensually participating in any federal franchise or "benefit" in the context of this exclusively private and not public transaction. As such, he is not a "public officer" with the government but rather a private human being. The only thing the government can regulate or tax are public activities, public officers, and public "employees" who are the only "persons" mentioned in the I.R.C. franchise per 26 U.S.C. § 7343 and 6671(b). It is otherwise unconstitutional to regulate exclusively private conduct.

"The power to "legislate generally upon" [the PRIVATE] life, liberty, and property, as opposed to the "power to provide modes of redress' against offensive state [e.g. "public officer"/"employee"] action, was "repugnant" to the Constitution. Id., at 15. See also United States v. Reese, 92 U.S. 214, 218 (1876); United States v. Harris, 106 U.S. 629, 639 (1883); James v. Bowman, 190 U.S. 127, 139 (1903). Although the specific holdings of these early cases might have been superseded or modified, see, e.g., Heart of Atlanta Motel, Inc. v. United States, 379 U.S. 241 (1964); United States v. Guest, 383 U.S. 745 (1966), their treatment of Congress' § 5 power as corrective or preventive, not definitional, has not been questioned."

[City of Boerne v. Florez, Archbishop of San Antonio, 521 U.S. 507 (1997)]

10. Submitter is NOT subject to IRS Form 1099 reporting, withholding, or backup withholding pursuant to 26 U.S.C. § 3401(a)(6) or 26 CFR § 31.3401(a)(6)-1(b):

"Foreign persons who provide Form W-8BEN, Form W-8ECI, or Form W-8EXP (or applicable documentary evidence) are exempt from backup withholding and Form 1099 reporting."
[IRS Publication 515, year 2001, p. 3]

11. Submitter is not a "U.S. person" as statutorily defined pursuant to 26 U.S.C. 7701(a)(30). The term "U.S. person" is statutorily defined as follows:

TITLE 26 > Subtitle F > CHAPTER 79 > Sec. 7701.
Sec. 7701. - Definitions

(a)(30) United States person

The term "United States person" means -

(A) a citizen or resident of the United States,

(B) a domestic partnership,

(C) a domestic corporation,

(D) any estate (other than a foreign estate, within the meaning of paragraph (31)), and

(E) any trust if -

(i) a court within the United States is able to exercise primary supervision over the administration of the trust, and

(ii) one or more United States persons have the authority to control all substantial decisions of the trust.

The term "United States" as used in "U.S. person" above is defined in 26 U.S.C. § 7701(a)(9) and (a)(10) as follows:

Affidavit of Citizenship, E

DOCH 361061

11/27/2012 01:09 PM Page: 158 of 178
AFF R:\$10.00 J. C. Sloan, Mckinley County



2022-011769 MISC Page: 2061 of 2782
09/26/2022 03:35:37 PM Receipt # : 22-9381
Darrell James Hill
Sadie Jo Bingham, Recorder
Gila County, AZ

DOCH 361076

11/27/2012 04:15 PM Page: 159 of 183
AFF R:\$10.00 J. C. Sloan, Mckinley County

AFFIDAVIT OF CITIZENSHIP, DOMICILE, AND TAX STATUS

TITLE 26 > Subtitle F > CHAPTER 79 > Sec. 7701. [Internal Revenue Code]
Sec. 7701. - Definitions

(a) When used in this title, where not otherwise distinctly expressed or manifestly incompatible with the intent thereof—

(9) United States

The term "United States" when used in a geographical sense includes on the States and the District of Columbia.

(10) State

The term "State" shall be construed to include the District of Columbia, where such construction is necessary to carry out provisions of this title.

13. Pursuant to the rules for statutory construction, if the states of the Union are not mentioned anywhere in Subtitle A of the Internal Revenue code and are not included in the definition of "United States" above, they can be safely assumed to be EXCLUDED by implication:

"Expressio unius est exclusio alterius. A maxim of statutory interpretation meaning that the expression of one thing is the exclusion of another. Burgin v. Forbes, 293 Ky. 456, 169 S.W.2d 321, 325; Newblock v. Bowles, 170 Okl. 487, 40 P.2d 1097, 1100. Mention of one thing implies exclusion of another. When certain persons or things are specified in a law, contract, or will, an intention to exclude all others from its operation may be inferred. Under this maxim, if statute specifies one exception to a general rule or assumes to specify the effects of a certain provision other exceptions of effects are excluded."
[Black's Law Dictionary, Sixth Edition, p. 581]

14. Nonresidents not engaged in a "trade or business" such as the Submitter are not required to provide identifying number to open financial accounts. The regulation below mentions "nonresident aliens", and nonresidents who are not statutory "aliens" must be treated the same:

Title 31: Money and finance: Treasury
PART 103—FINANCIAL RECORDKEEPING AND REPORTING OF CURRENCY AND FOREIGN TRANSACTIONS
Subpart C—Records Required To Be Maintained
§103.34 additional records to be made and retained by banks.

(a)(3) A taxpayer identification number required under paragraph (a)(1) of this section need not be secured for accounts or transactions with the following:

(x) non-resident aliens who are not engaged in a trade of business in the United States.

In instances described in paragraph (a)(3), (viii) and (ix) of this section, the bank shall, within 15 days following the end of any calendar year in which the interest accrued in that year is \$10 or more use its best effort to secure and maintain the appropriate taxpayer identification number or application form therefor.

15. It amounts to "compelled to association" in violation of the First Amendment to force me to associate with and be identified as a "U.S. person" (under 26 U.S.C. § 7701(a)(30)), a statutory "U.S. Citizen" (under 8 U.S.C. § 1401), or a "taxpayer" (under 26 U.S.C. § 7701(a)(14)) or any status OTHER than that described above. I would also be committing perjury under penalty of perjury to sign any government form that identified me as any of the three types of entities.

16. I will not allow you to compel me to participate in the "trade or business" franchise or contract with the government by changing my status to be anything other than that described herein. All franchises are contracts between the grantor and the grantee:

As a rule, franchises spring from contracts between the sovereign power and private citizens, made upon valuable considerations, for purposes of individual advantage as well as public benefit, and thus a franchise partakes of a double nature and character. So far as it affects or concerns the public, it is

Affidavit of Citizenship, Dc

DOCH 361061

11/27/2012 01:09 PM Page: 159 of 178
AFF R:\$10.00 J. C. Sloan, McKinley County



2022-011769 MISC Page: 2062 of 2782
09/26/2022 03:35:37 PM Receipt #: 22-9381
Darrell James Hill
Rec Fee: \$30.00 Sadie Jo Bingham, Recorder
Gila County, Az.
2053

DOCH 361076

11/27/2012 04:15 PM Page: 150 of 183
AFF R:\$10.00 J. C. Sloan, McKinley County

AFFIDAVIT OF CITIZENSHIP, DOMICILE, AND TAX STATUS

*publici juris and is subject to governmental control. The legislature may prescribe the manner of granting it, to whom it may be granted, the condition and terms upon which it may be held, and the duty of the grantee to the public in exercising it, and may also provide for its forfeiture upon the failure of the grantee to perform that duty. But when granted, it becomes the property of the grantee, and is a private right, subject only to the governmental control growing out of its other nature as *publici juris*.*²
[Am.Jur.2d, Franchises, §4: Generally]

17. Pursuant to the Declaratory Judgment Act, 28 U.S.C. §2201(a) and the federal courts, the recipient of this form and any government agent handling this case has NO authority to assume any tax status other than that indicated on this form or to convert an innocent "nontaxpayer" into a "taxpayer".

*Specifically, Rowen seeks a declaratory judgment against the United States of America with respect to "whether or not the plaintiff is a taxpayer pursuant to, and/or under 26 U.S.C. § 7701(a)(14)." (See Compl. At 2.) The court lacks jurisdiction to issue a declaratory judgment "with respect to Federal taxes other than actions brought under section 7428 of the Internal Revenue code of 1986, "a code section that is not at issue in the instant action. See 28 U.S.C. §2201; see also *Huqhes v. United States*, 953 F.2d 531, 536-537 (9th Cir. 1991) (affirming dismissal of claim for declaratory relief under § 2201 where claim concerned question of tax liability). Accordingly, defendant's motion to dismiss is hereby GRANTED, and the instant action is hereby DISMISSED.
[*Rowen v. US.*, 05-3766MMC. (N.D.Cal. 11/02/2005)]*

*"And by statutory definition, 'taxpayer' includes any person, trust or estate subject to a tax imposed by the revenue act. ...Since the statutory definition of 'taxpayer' is exclusive, the federal courts do not have the power to create nonstatutory taxpayers for the purpose of applying the provisions of the Revenue Acts..."
[*C.I.R. v. Trustees of L. Inv. Ass'n*, 100 F.2d 18 (1939)]*

*"A reasonable construction of the taxing statutes does not include vesting any tax official with absolute power of assessment against individuals not specified in the statutes as a person liable for the tax without an opportunity for judicial review of this status before the appellation of 'taxpayer' is bestowed upon them and their property is seized..."
[*Botta v. Scanlon*, 288 F.2d 504, 508 (1961)]*

SECTION 3: DURESS STATEMENT

If any other government form with the Recipient of this form might have received or viewed which I might have signed contradicts anything contained herein, the reasons are that:

1. I was threatened or felt threatened:
 - 1.1. By the Recipient to either not be hired or be fired if I did not sign a W-4 agreement or submit to a specific government form from that doesn't pertain to me and thereby commit what I know to be fraud and/or perjury on a government form. . . OR
 - 1.2. By the Recipient because I was told that I would be denied the EQUAL right of all to engage in a business or financial account needed to sustain my life if I did not fill out and submit the form indicated and which I know misrepresented my status or had no options to correctly represent my status. . . OR
 - 1.3. By the government because I would become the target of unlawful or "selective" IRS/government enforcement that the legal profession, the courts, and the government routinely protect and encourage because of conflicts of interest, undue consolidation of power, and greed.

¹ Georgia R. & Power Co. v. Atlanta, 154 Ga 731, 115 SE 263; Lippencott v. Allander, 27 Iowa 460; State ex rel. Hutton v. Baton Rouge, 217 La 857, 47 So 2d 665; Tower v. Tower & S. Street R. Co. 68 Minn 500, 71 NW 691.

² Georgia R. & Power Co. v. Atlanta, 154 Ga 731, 115 SE 263; Lippencott v. Allander, 27 Iowa 460; State ex rel. Hutton v. Baton Rouge, 217 La 857, 47 So 2d 665; Tower v. Tower & S. Street R. Co. 68 Minn 500, 71 NW 691.

Affidavit of Citizenship, D

DOCH 361061

11/27/2012 01:09 PM Page: 160 of 178
AFF R: \$10.00 J. C. Sloan, McKinley County

2022-011769 MISC Page: 2063 of 2782

09/26/2022 03:35:37 PM Receipt #: 22-9381
Rec Fee: \$30.00 Darrell James Hill
Gila County, Az, Sadie Jo Bingham, Recorder



DOCH 361076

11/27/2012 04:15 PM Page: 161 of 183
AFF R: \$10.00 J. C. Sloan, McKinley County



AFFIDAVIT OF CITIZENSHIP, DOMICILE, AND TAX STATUS

"For the love of money is the root of all evil: which while some coveted after, they have erred from the faith, and pierced themselves through with many sorrows.

But thou, O man of God, flee these things' and follow after righteousness, godliness, faith, love, patience, meekness.

Fight the good fight of faith, lay hold on eternal life, whereunto thou art also called, and hast professed a good profession before many witnesses."
[1 Timothy 6:5-12, Bible, NKJV]

1.4 By the Recipient, who may have refused to accept this for or sent it back, because they knew they were violating both the law and my right and wanted to obstruct justice, destroy evidence of their wrongdoing, and tamper with a federal witness because this form is signed under penalty of perjury.

2. I was therefore under unlawful duress and the target of racketeering, extortion, and/or unconscionable "adhesion contracts" by the recipient/ government.

3. The origin of the duress was the Recipient of this form acting in a quasi-governmental and "public officer" capacity as a "withholding agent" pursuant to 26 U.S.C. §7701(a)(16) and who is therefore legally liable to respect my constitutional rights and REFUSED demands to do so.

... AND

4. The result of the unlawful duress was that I was compelled to contract with or engage in commerce within the government against my will and/or religious beliefs in violation of Article 1, section 10 of the United States Constitution, and to donate private property to a public use, public purpose, and/or public office in the government such as the "trade or business" franchise that is the heart of the Internal Revenue Code. Participation in all government franchises is an act of contracting because all franchises are contracts.

I hereby for the record declare as void, untrustworthy, and not admissible as evidence of any obligation on my part in any and all forms, declarations of status, or other correspondence in conflict with this form or any attached form I may have provided because such was submitted under unlawful duress.

"An agreement [consensual contract] obtained by duress, coercion, or intimidation is invalid, since the party coerced is not exercising his free will, and the test is not so much the means by which the party is compelled to execute the agreement as the state of mind induced."³ Duress, like fraud, rarely becomes material, except where a contract or conveyance has been made which the maker wishes to avoid. As a general rule, duress renders the contract or conveyance voidable, not void, at the option of the person coerced,⁴ and it is susceptible of ratification. Like other voidable contracts, it is valid until it is avoided by the person entitled to avoid it.⁵ However, duress in the form of physical compulsion, in which a party is caused to appear to assent when he has no intention of doing so, is generally deemed to render the resulting purported contract void.⁶
[American Jurisprudence 2d, Duress, Section 21]

This affidavit of duress and void declaration especially includes, but is not limited to, anything relating to government franchises, disclosures of government identifying numbers such as SSN or TIN, tax withholding or reporting forms such as the W-4 contract forms (26 CFR §31.3401(a)-3(a) and 26 CFR §31.3402(p)-1, tax returns, or any other declaration of status (e.g. "employee", "taxpayer", "individual", "inhabitant", "U.S. citizen") arising out of any tax, citizenship, or licensing forms provided to the government such as driver's license applications, applications for ID cards, voter registration, or benefit applications.

³ Brown v. Pierce, 74 U.S. 205, 7 Wall 205, 19 L.Ed 134

⁴ Barnette v. Wells Fargo Nevada Nat'l Bank, 270 U.S. 438, 70 L.Ed 669, 46 S Ct 326 (holding that acts induced by duress which operate solely on the mind, and fall short of actual physical compulsion, are not void at law, but are voidable only, at the election of him whose acts were induced by it); Fiske v. Gershman, 30 Misc 2d 442, 215 NYS2d 144; Glenney v. Crane (Tex Civ App Houston (1st Dist)) 352 SW2d 773, writ ref n r e (May 16, 1962); Carroll v. Fetty, 121 W.Va 215, 2 SE.2d 521, cert den 308 U.S. 571, 84 L.Ed 479, 60 S ct 85.

⁵ Fiske v. Gershman, 30 Misc 2d 442, 215 NYS2d 144; Heider v Unicume, 142 Or 416, 20 P2d 384; Glenney v. Crane (Tex Civ App Houston (1st Dist)) 352 SW2d 773, writ ref n r e (May 16, 1962)

⁶ Restatement 2d, Contracts § 174, stating that if conduct that appears to be a manifestation of assent by a party who does not intend to engage in that conduct is physically compelled by duress, the conducts is not effective as a manifestation of assent.

Affidavit of Citizenship, Dc

DOCH 361061

11/27/2012 01:09 PM Page: 161 of 178
AFF R: \$10.00 J. C. Sloan, McKinley County



2022-011769 MISC Page: 2064 of 2782

09/26/2022 03:35:37 PM Receipt #: 22-9381
James Hill, Darrell
Rec Fee: \$30.00 James Hill, Recorder
Gila County, Az, Sadie Jo Bingham



DOCH 361076

11/27/2012 04:15 PM Page: 162 of 183
AFF R: \$10.00 J. C. Sloan, McKinley County



2055

AFFIDAVIT OF CITIZENSHIP, DOMICILE, AND TAX STATUS

SECTION 4: DO NOT ATTEMPT TO ADVISE ME WHAT TO PUT ON ANY GOVERNMENT FORM OR TO CHANGE THE STATUS DESCRIBED IN THIS FORM

Per 26 U.S.C. §6065, all tax forms must be signed under penalty of perjury, just as this form is. As such, this form and ALL tax forms I submit to you constitute "testimony of a witness" and are protected by witness tampering laws. I remind the recipient that it is a federal offense to tamper with witnesses. Tampering includes, but is not limited to:

1. Advising me what to put on this form or any tax or withholding form and thereby conspire to commit PERJURY in violation of 18 U.S.C. §1542, 18 U.S.C. §911, 18 U.S.C. §1001, and 18 U.S.C. §1621. All such attempts shall form an inseparable part of the forms you both receive and must keep on file so that you may be held accountable.
 2. Refusing to honor that status that I describe here and thereby compelling me to commit perjury for the PRIVILEGE of being treated EQUALLY to everyone else you service.
 3. Telling me that what I put on the form is INCORRECT or FALSE and thereby refusing to accept the form, and yet refusing to offer legal evidence signed under penalty of perjury (as required by 26 U.S.C. §6065) PROVING that it is false.
 4. Threatening to withhold service or discriminate against me while acting as a public officer called a "withholding agent" defined in 26 U.S.C. §7701(a)(14). That would be a denial of equal protection of the law.
 5. Imputing or assuming a legal status OTHER than what I put here, and which might subject me to illegal enforcement or penalties against parties not subject. All such activities constitute an unconstitutional "Bill of Attainder" if implemented against those not consensually and lawfully engaged in government franchises. Not even federal judges can make such determinations.
- 28 22 U.S.C. 2201(a) forbids such determinations.

SECTION 5: SIGNATURE OF SUBMITTER

Worker Signature:	I certify under penalty of perjury from without the "United States" in accordance with <u>28 U.S.C. § 1746(1)</u> that the information provided on this form is true, correct, and complete.	Date signed:	
	 Darrell James, Hill	10/11/12	

NOTARY PUBLIC CERTIFICATION

BEFORE ME, the undersigned authority, a Notary Public, of the County of MCKINLEY, Republic of NEW MEXICO (statename), this 11th day of OCTOBER, 20 12

Darrell James Hill the above signed human being did appear and was identified by (circle one) driver's license/passport/other and who, upon first being duly sworn and/or affirmed, deposes and says that the foregoing asseveration is true to the best of his knowledge and belief.

I certify under PENALTY OF PERJURY under the laws of the State of NEW MEXICO that the foregoing paragraph is true and correct.

WITNESS my hand and official seal.

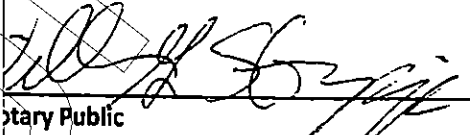
Notary Public Seal



OFFICIAL SEAL
WILLIAM G. STRIPP
NOTARY PUBLIC
STATE OF NEW MEXICO

My Commission Expires: 6/1/2016

My Commission Expires On: June 1, 2016

2022-011769 MISC Page: 2065 of 2782
09/26/2022 03:36:37 PM Receipt #: 22-9381
Rec Fee: \$30.00 Darrell James Hill
Gila County, AZ, Sadie Jo Bingham, Recorder

DOCH 361076
11/27/2012 04:15 PM Page: 163 of 183
AFF R:\$10.00 J. C. Sloan, McKinley County

DOCH 361061
11/27/2012 01:09 PM Page: 162 of 178
AFF R:\$10.00 J. C. Sloan, McKinley County

AFFIDAVIT OF CITIZENSHIP, DOMICILE, AND TAX STATUS

APPENDIX: LEGAL POINTS AND AUTHORITIES

(This section provided for those who seek supporting authorities of statement made in this document)

1. A "national" is statutorily defined as follows:

TITLE 8 > CHAPTER 12 > SUBCHAPTER 1 . Sec. 1101.

Sec. 1101. - Definitions

(a)(21) The term "national" means a person owing permanent allegiance to a state.

2. The "state" in the above definition is a state of the Union. All states of the Union are "foreign states" with respect to federal government legislative jurisdiction, and therefore are lower case. Federal territories are capitalized as "State" within federal law. For example:

TITLE 4 - FLAG AND SEAL, SEAT OF GOVERNMENT, AND THE STATES

CHAPTER 4 - THE STATES

Sec. 110. Same; definitions

(d) The term "state" includes any Territory or possession of the United States.

3. Even the "United States of America" passport recognizes the two types of citizenship defined in federal statutory law. On the inside cover of the passport it says the following. Note the phrase "citizen/national", which means "citizen OR national":

"The Secretary of State of the United States of America hereby request all whom it may concern to permit the citizen/national of the United States named herein to pass without delay or hindrance and in case of need to give all lawful aid and protection"

4. Below are some cites that establish the foreign relationship between the state and federal government for the purposes of legislative jurisdiction:

Foreign States: "Nations outside of the United States...Term may also refer to another state: i.e. a sister state. The term 'foreign nations', ...should be construed to mean all nations and states other than that in which the action is brought; and hence, one state of the Union is foreign to another, in that sense."
[Black's Law Dictionary, 6th Edition, p. 648]

Foreign Laws: "The laws of a foreign country or sister state."
[Black's Law Dictionary, 6th Edition, p. 647]

"Generally, the states of the Union sustain toward each other the relationship of independent sovereigns or independent foreign states, except in so far as the United States is paramount as the dominating government, and in so far as the states are bound to recognize the fraternity among sovereignties established by the federal Constitution, as by the provision requiring each state to give full faith and credit to the public acts, records, and judicial proceedings of the other states..."
[81A Corpus Juris Secundum (C.J.S.), United States, §29, legal encyclopedia]

"It is no longer open to question that the general government, unlike the states, Hammer v. Dagenhart, 247 U.S. 251, 275, 38 S.Ct. 529, 3 A.L.R. 649, Ann.Cas. 1918E 724, possesses no inherent power in respect of the internal affairs of the states; and emphatically not with regard to legislation. The question in respect of the inherent power of that government as to the external affairs of the Nation and in the field of international law is a wholly different matter which it is not necessary now to consider.
[Carter v. Carter Coal Co., 298 U.S. 238, 56 S.Ct. 855 (1936)]

The sole function of the federal government of the United States is to handle FOREIGN affairs with other countries, but it has no jurisdiction within states of the Union, including taxation. All of its revenues must derive only from the external affairs over which it has exclusive legislative jurisdiction. The rulings below occurred AFTER the passage of the Sixteenth Amendment and still mit the federal government exclusively to external matters in relation to states of the Union.

"The States, after they formed the Union, continued to have the same range of [INTERNAL] taxing power which they had before, barring only duties affecting exports, imports, and on tonnage [which all deal with FOREIGN/EXTERNAL commerce only]. 2 Congress, on the other hand, to lay taxes in order 'to pay the Debts and provide for the common Defence and general Welfare of the United States', Art. 1,

Affidavit of Citizenship, E

DOC# 361061

11/27/2012 01:09 PM Page: 163 of 178
AFF R:\$10.00 J. C. Sloan, McKinley County



2022-011769 MISC Page: 2066 of 2782
09/25/2022 03:35:37 PM Receipt #: 22-9381
James Hill, Recorder
Rec Fee: \$30.00 Darrell Jo Bingham, Recorder
Gila County, Az, Sadie Jo Bingham, Recorder

DOC# 361076

11/27/2012 04:15 PM Page: 164 of 189
AFF R:\$10.00 J. C. Sloan, McKinley County

AFFIDAVIT OF CITIZENSHIP, DOMICILE, AND TAX STATUS

Sec. 8, U.S.C.A. Const., can reach every person and every dollar in the land with due regard to Constitutional limitations as the method of laying taxes."
[Graves. V. People of State of New York, 306 U.S. 466 (1939)]

"The difficulties arising out of our dual form of government and the opportunities for differing opinions concerning the relative rights of state and national governments are many; but for a very long time this court has steadfastly adhered to the doctrine that the taxing power of Congress does not extend to the states of their political subdivisions. The same basic reasoning which leads to that conclusion, we think, requires like limitation upon the power which springs from the bankruptcy clause. United States v. Butler, supra."
[Ashton v. Cameron County Water Improvement District No. 1, 298 U.S. 513; 56 S.Ct. 892 (1936)]

Congress is authorized to lay and collect taxes, and to pay the debts, and provide for the common defence and general welfare of the United States. This does not interfere with the power of the States to tax [internally] for the support of their own governments: nor is the exercise of that power by the States [to tax INTERNALLY], an exercise of any portion of the power that is granted to the United States [to tax EXTERNALLY]. In imposing taxes for State purposes, they are not doing what Congress is empowered to do. Congress is not empowered to tax for those purposes which are within the exclusive province of the States. When, then, each government exercises the power to taxation, neither is exercising the power of the other. But, when a State proceeds to regulate commerce with foreign nations, or among the several States, it is exercising the very power that is granted to Congress, [22 U.S. 1, 200] and is doing the very thing which Congress is authorized to do. There is no analogy, then, between the power of taxation and the power of regulating commerce."
[Gibbons v. Ogden, 22 U.S. 1 (1824)]

"It will contribute to the elucidation of the question if we first consider the differences between the power of the federal government in respect of foreign or external affairs and those in respect of domestic or internal affairs. That there are differences between them, and that these differences are fundamental, may not be doubted. The two classes of powers are different, both in respect of their origin and their nature. The broad statement that the federal government can exercise no power except those specifically enumerated in the Constitution, and such implied power as are necessary and proper to carry into effect the enumerated power, is categorically true only in respect of our internal affairs. In that field, the primary purpose of the Constitution was to carve from the general mass of legislative powers then possessed by the states such portions as it was thought desirable to vest in the federal government, leaving those not included in the enumerations still in the states."
Carter v. Carter Coal Co., 298 U.S. 238, 294 56 S.Ct. 855, 865. . . .

The Union existed before the Constitution, which was ordained and established among other things to form 'a more perfect Union.' Prior to that event, it is clear that the Union, declared by the Articles of Confederation to be 'perpetual,' was the sole possessor of external sovereignty, and in the Union it remained without change save in so far as the Constitution in express terms qualified its exercise. The Framers' Convention was called and exerted its powers upon the irrefutable postulate that though the states were several their people in respect of foreign affairs were one."
[United States v. Curtiss-Wright Export Corporation, 299 U.S. 304 (1936)]

6. The states of the Union are "foreign" to federal legislative jurisdiction, because, as the U.S. Supreme Court held above, they are not subject to it. This is a result of what is called the "Separation of Powers Doctrine", which was explained by the Supreme Court as follows:

"... the Constitution divides authority [legislative jurisdiction] between federal and state governments for the protection of individuals. State sovereignty is not just an end in itself: "Rather, federalism secures to citizens the liberties that derive from the diffusion of sovereign power." Coleman v. Thompson, 501 U.S. 722, 759 (1991) (BLACKMUN, J., dissenting). "Just as the separation and independence of the coordinate branches of the Federal Government serve to prevent the accumulation of excessive power in any one branch, a health balance of power between the States and the Federal Government will reduce the risk of tyranny and abuse from either front." Gregory v. [505 U.S. 144, 182] Ashcroft, 501 U.S. at 458. See The Federalist No. 51, p. 323. (C. Rossiter ed. 1961)."
[New York v. United States, 505 U.S. 144 (1992)]

Affidavit of Citizenship, Do

DOCH 361061

11/27/2012 01:09 PM Page: 164 of 178
AFF R:\$10.00 J. C. Sloan, McKinley County



2022-0111769 MISC Page: 2067 of 2782
09/26/2022 03:35:37 PM Receipt #: 22-9381
Rec Fee: \$30.00 Darrell James Hill
C11a County/Az, Saddle Jo Bingham, Recorder

DOCH 361076

11/27/2012 04:15 PM Page: 165 of 183
AFF R:\$10.00 J. C. Sloan, McKinley County



AFFIDAVIT OF CITIZENSHIP, DOMICILE, AND TAX STATUS

7. The federal government has no legislative power outside of its "territory".

"Judge Story, in his treatise on the Conflicts of Laws, lays down, as the basis upon which all reasonings on the law of comity must necessarily rest, the following maxims: First 'that every nation [or state] possesses an exclusive sovereignty and jurisdiction within its own territory'; secondly, that no state or nation can by its laws directly affect or bind property out of its own territory, or bind persons not resident therein, whether they are natural born subjects or others.' The learned judge then adds: 'From these two maxims or propositions there follows a third, and that is that whatever force and obligation the laws of one country have in another depend solely upon the laws and municipal regulation of the latter; that is to say, upon its own proper jurisdiction and polity, and upon its own express or tacit [voluntary] consent.'" Story on Conflict of Laws §23. [Baltimore & Ohio Railroad Co. v. Chambers, 73 Ohio St. 16; 76 N.E. 91; 11 L.R.A., N.S., 1012 (1905)]

8. The states of the Union are NOT "territory" of the federal government. They are instead INDEPENDENT and SOVEREIGN states:

86 Corpus Juris Secundum (C.J.S.) Legal Encyclopedia, Territories:

"§1. Definitions, Nature, and Distinctions

"The word 'territory,' when used to designate a political organization has a distinctive, fixed, and legal meaning under the political institutions of the United States, and does not necessarily include all the territorial possessions of the United States, but may include only the portions thereof which are organized and exercise governmental functions under act of congress."

"While the term 'territory' is often loosely used, and has even been construed to include municipal subdivisions of a territory, and "territories of the " United States is sometimes used to refer to the entire domain over which the United States exercises dominion, the word "territory," when used to designate a political organization, has a distinctive, fixed, and legal meaning under the political institutions of the United States, and the term "territory" or "territories" does not necessarily include only a portion of the portions thereof which are organized and exercise government functions under act of congress. The term "territories" has been defined to be political subdivisions of the outlying dominion of the United States, and in this sense the term "territory" is not a description of a definite area of land but of a political unit governing and being governed as such. The question whether a particular subdivision or entity is a territory is not determined by the particular form of government with which it is, more or less temporarily, invested.

"Territories" or "territory" as including "state" or "states." While the term "territories of the" United States may, under certain circumstances, include the states of the Union, as used in the federal Constitution and in ordinary acts of congress "territory" does not include a foreign state.

"As used in this title, the term "territories" generally refers to the political subdivisions created by congress, and not within the boundaries of any of the several states."

9. States of the Union retain their essential character as independent nations and foreign countries with respect to the federal government except in the matter of EXTERNAL affairs delegated by them to the Federal Government in their corporate capacity as the "United States of America":

"The States between each other are sovereign and independent. They are distinct and separate sovereignties, except so far as they parted with some of the attributes of sovereignty by the Constitution. They continue to be nations, with all their rights, and under all their national obligations, and with all the rights of nations in every particular: except in the surrender by each to the common purposes and objects of the Union, under the Constitution. The rights of each State, when not so yielded up, remain absolute."
[Bank of Augusta v. Earle, 38 U.S. (13 Pet.) 519; 10 L.Ed. 274 (1839)]

"In determining the boundaries of apparently conflicting powers between states and the general government, the proper question is, not so much what has been, in terms, reserved to the states, as what has been, expressly or by necessary implication, granted by the people to the national government: for each state possess all the powers of an independent and sovereign nation, except so far as they have been ceded away by the constitution. The federal government is but a creature of the people of the states, and, like an agent appointed for definite and specific purposes, must show an express or necessarily implied authority in the charter of its appointment, to give validity to its acts."

Affidavit of Citizenship, D

DOC# 361061

11/27/2012 01:09 PM Page: 165 of 178
AFF R:\$10.00 J. C. Sloan, McKinley County



2022-011769 MISC Page: 2068 of 2782

09/26/2022 03:35:37 PM Receipt #: 22-9381

Rec Fee: \$30.00 Darrell James Hill, Recorder

Gila County, AZ, Sadie Jo Bingham

DOC# 361076

11/27/2012 04:15 PM Page: 166 of 183
AFF R:\$10.00 J. C. Sloan, McKinley County



AFFIDAVIT OF CITIZENSHIP, DOMICILE, AND TAX STATUS

[U.S. v. Wong Kim Ark, 169 U.S. 649 (1898)]

13. A human being who is a "national" but not a "citizen" under federal statutory law is identified as a "citizen of the United States" within the Fourteenth Amendment to the U.S. Constitution. The United States Constitution confines itself to describing citizenship within the states and the Union and therefore, the term "United States", as used within the Constitution, means the collective states of the Union [called "The United States of America"] and EXCLUDES federal territories and possessions and the District of Columbia. The "United States" mentioned in the Constitution and the "United States" mentioned in most federal enactments are two completely different and mutually exclusive places. This is VERY important and fundamental to understanding the Separation of Powers Doctrine.

14. If the recipient of this form disagrees with any of the facts stated in this section, then please provide the following within thirty calendar days or forever be stopped from challenging these statements of fact:

- 14.1. Written evidence signed under penalty of perjury (not opinion, but enacted positive law, regulations, and Supreme court rulings but not those of lower courts) of same.

The remainder of this is intentionally left blank.

2022-011769 MISC Page: 2069 of 2782
09/26/2022 03:35:37 PM Receipt #: 22-9381
Rec Fee: \$30.00 Darrell James Hill
Gila County, Az, Sadia Jo Bingham, Recorder

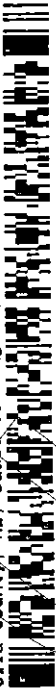

Affidavit of Citizenship, Dc

DOCH 361061

11/27/2012 01:09 PM Page: 167 of 178
AFF R: \$10.00 J. C. Sloan, McKinley County



DOCH 361076

11/27/2012 04:15 PM Page: 168 of 183
AFF R: \$10.00 J. C. Sloan, McKinley County



AFFIDAVIT OF CITIZENSHIP, DOMICILE, AND TAX STATUS

[People ex re. Atty. Gen V. Naglee, 1 Cal 234 (1850)]

10. A human being (but NOT "person") who is born in a state of the Union, which is outside of federal exclusive legislative jurisdiction, is called a "national". A person who is a "national" is subject to the "political jurisdiction" but not the "legislative jurisdiction" of their mother country because they are outside of the territorial reach of its general laws, because the Congress cannot write any law that governs what happens with states of the Union, as the above citations indicate (see, for instance, Carter v. Carter Coal Co., 298 U.S. 238, 56 S.Ct. 855, (1936)). The reason is that the states and the people in them are SOVEREIGN, and their creation, the federal government, cannot be greater than its Creator, which is the states and the people in them. The federal government is a SERVANT to the states, not their master: the equivalent of an independent contract that handles EXTERNAL affairs only. This was confirmed by the Federalist Papers, which were written prior to the ratification of the Constitution by the states of the Union in 1789:

"No legislative act [of Congress] contrary to the Constitution can be valid. To deny this would be to affirm that the deputy (agent) [which is the federal government] is greater than his principal [the States and the people in them]; that the servant is above the master; that the representatives of the people are superior to the people; that men, acting by virtue of powers may do not only what their powers do not authorize, but what they forbid...[text omitted] It is not otherwise to be supposed that the Constitution could intend to enable the representatives of the people to substitute their will to that of their constituents. It is far more rational to suppose, that the courts were designed to be an intermediate body between the people and the legislature, in order, among other things, to keep the latter within the limits assigned to their authority. The interpretation of the laws is the proper and peculiar province of the courts. A Constitution is, in fact, and must be regard by judges, as fundamental law. If there should happen to be an irreconcilable variance between the two, the Constitution is to be preferred to the statute."
[Alexander Hamilton, Federalist Paper # 78]

11. It is absurdly ridiculous to demand from the submitter a federal statute that confers but NOT defines citizenship status of a person born outside of federal jurisdiction. The laws of the States of the Union, and not federal law, govern the citizenship status of people born within their jurisdiction. States of the Union have exclusive and "plenary" jurisdiction to determine the status of people born with their jurisdiction and they have never yielded that authority to the federal government either in the Constitution or in any subsequent amendment or enactment. To conclude otherwise is to admit that states of the Union have NO SOVEREIGNTY, because the federal government could just pass a law to literally STEAL all of their citizens. If the federal government had jurisdiction to pass a law that allowed them to STEAL all citizens of the states, then the states would be left with not one to govern!

12. Congress has the power to "naturalize" people coming into America, and when they do this, these people become statutory "nationals" and constitutional but not statutory "Citizens".

"Provision of Nationality Act of 1940 that a person becoming a national by naturalization shall lose his nationality by residing continuously for three years in territory of a foreign state, being practically identical to its successor, which was condemned by United States Supreme Court as discriminatory, would have been invalid as a congressional attempt to expatriate regardless of intent."
[United States v. Lucienne D'Hotelle, 558 F.2d 37 (1976)]

The statutory definition of "naturalization" confirms that in America, naturalization means conferring the character of a statutory "national" and not a statutory "citizen":

8 U.S.C. §1101(a)(23) naturalization defined

(a)(23) The term "naturalization" means the conferring of nationality [NOT "citizen" or "U.S. citizen" status, but "nationality", which means "national"] of a state [of the Union] upon a person after birth, by any means whatsoever.

[NOTE: Compare with the definition of "expatriation"]

"The power of naturalization, vested in congress by the constitution, is a power to confer citizenship, not a power to take it away. 'A naturalized citizen,' said Chief Justice Marshall, 'becomes a member of the society, possessing all the rights of a native citizen, and standing, in the view of the constitution, on the footing of a native. The constitution does not authorize congress to enlarge or abridge those rights. The simple power of the national legislature [over citizenship] is to prescribe a uniform rule of naturalization, and the exercise of this power exhausts it, so far as respects the individual.'"

Affidavit of Citizenship, Do **DOCH 361061**

11/27/2012 01:09 PM Page: 166 of 178
AFF R: \$10.00 J. C. Sloan, McKinley County

2022-011769 MISC Page: 2070 of 2782
09/26/2022 03:35:37 PM Receipt #: 22-9381
Rec Fee: \$39.00 Darrell James Hill
Gila County, AZ, Sadie Jo. Birmingham, Recorder

DOCH 361076
11/27/2012 04:15 PM Page: 167 of 183
AFF R: \$10.00 J. C. Sloan, McKinley County

561

Registered No. RE430969752 US

Date Stamp



To Be Completed By Post Office

Reg. Fee	10.95	
Handling Charge		Return Receipt
Postage	5.15	Restricted Delivery
Received by <i>P. Manpugur</i>		

Customer Must Declare Full Value \$ 0 Domestic Insurance up to \$25,000 is included based upon the declared value. International Indemnity is limited. (See Reverse).

OFFICIAL USE

To Be Completed By Customer (Please Print) All Entries Must Be in Ballpoint or Typed

FROM	Darrell James, Hill
	28 Hilltop Court
	HC 61, Box 771
	Ramah, New Mexico
TO	President Barack Hossain Obama
	The White House
	1600 Pennsylvania Avenue NW
	Washington, D.C. 20500

PS Form 3806, Receipt for Registered Mail Copy 1 - Customer May 2007 (7530-02-000-9051) (See Information on Reverse) For domestic delivery information, visit our website at www.usps.com®

2022-011769 MISC Page: 2071 of 2782

09/26/2022 03:35:37 PM Receipt #: 22-9381
Reg Fee: \$30.00 Darrell James Hill
Gila County, AZ, Sadie Jo Bingham, Recorder



Official Copy

DOCH 361076

11/27/2012 04:15 PM Page: 169 of 183
AFF R: \$10.00 J. C. Sloan, McKinley County



DOCH 361061

11/27/2012 01:09 PM Page: 168 of 178
AFF R: \$10.00 J. C. Sloan, McKinley County



English Customer USPS

Register / Sign In



Service Mobile

Search USPS.com or Track Pa

Quick Tools

Ship a Package

Send Mail

Manage Your Mail

Shop

Business Solutions

Track & Confirm

GET EMAIL UPDATES PRINT DETAILS

YOUR LABEL NUMBER	SERVICE	STATUS OF YOUR ITEM	DATE & TIME	LOCATION	FEATURES
RE430969752US		Delivered	October 19, 2012, 4:20 am	WASHINGTON, DC 20066	Registered Mail™
		Arrival at Unit	October 18, 2012, 2:57 am	WASHINGTON, DC 20066	

Check on Another Item

What's your label (or receipt) number?

Find

LEGAL

- Privacy Policy ›
- Terms of Use ›
- FOIA ›
- No FEAR Act EEO Data ›

ON USPS.COM

- Government Services ›
- Buy Stamps & Shop ›
- Print a Label with Postage ›
- Customer Service ›
- Site Index ›

ON ABOUT.USPS.COM

- About USPS Home ›
- Newsroom ›
- Mail Service Updates ›
- Forms & Publications ›
- Careers ›

OTHER USPS SITES

- Business Customer Gateway ›
- Postal Inspectors ›
- Inspector General ›
- Postal Explorer ›

Copyright© 2012 USPS. All Rights Reserved.

2022-011769 MISC Page: 2072 of 2782
 09/26/2022 03:35:37 PM Receipt #: 22-9381
 Rec Fee: \$30.00 Darrell James Hill
 Gila County, Az, Sadie Jo Bingham, Recorder



DOCH 361076

11/27/2012 04:15 PM Page: 170 of 183
 AFF R:\$10.00 J. C. Sloan, McKinley County



DOCH 361061

11/27/2012 01:09 PM Page: 169 of 178
 AFF R:\$10.00 J. C. Sloan, McKinley County



ml:file://C:\Users\Jymison Family\Desktop

Unofficial Copy

Item No. 4

Item 4:
Encl. C
Oct. 2012

Response regarding Sorensen Oct. 31, 2012 FedEx letter, TRK #201, 5366 8192 2909

Mailing and Acceptance Information
Class Attorney David Sorensen, Philadelphia, Pennsylvania

USPO CMN: 7009 2820 0003 8851 6179

Accepted: October 19, 2012
Mailing and Acceptance Information

DOCH 361076

11/27/2012 04:15 PM Page: 171 of 183
AFF R:\$10.00 J. C. Sloan, Mckinley County



2064
2022-011769 MISC Page: 2073 of 2782
09/26/2022 03:35:37 PM Receipt #: 22-9381
Rec Fee: \$30.00 Darrell James Hill
Gila County, Az. Sadie Jo Bingham, Recorder



DOCH 361061

11/27/2012 01:09 PM Page: 170 of 178
AFF R:\$10.00 J. C. Sloan, Mckinley County



English

Customer Service

USPS Mobile

Register / Sign In



Search USPS.com or Track Packages

Quick Tools

Ship a Package

Send Mail

Manage Your Mail

Shop

Business Solutions

Track & Confirm

GET EMAIL UPDATES

PRINT DETAILS

YOUR LABEL NUMBER

SERVICE

STATUS OF YOUR ITEM

DATE & TIME

LOCATION

FEATURES

7009282000388516179

Delivered

November 13, 2012, 11:00 am

PHILADELPHIA, PA 19103

Certified Mail™

Notice Left (No Authorized Recipient Available)

November 10, 2012, 11:50 am

PHILADELPHIA, PA 19103

Arrival at Unit

November 10, 2012, 5:36 am

PHILADELPHIA, PA 19104

Check on Another Item

What's your label (or receipt) number?

Find

U.S. Postal Service™
CERTIFIED MAIL™ RECEIPT
(Domestic Mail Only; No Insurance Coverage Provided)

For delivery information visit our website at www.usps.com.

OFFICIAL USE

Postage	\$ 1.70
Certified Fee	2.95
Return Receipt Fee (Endorsement Required)	2.35
Restricted Delivery Fee (Endorsement Required)	7.00
Total Postage & Fees	\$ 14.00



LEGAL

- Privacy Policy
- Terms of Use
- FOIA
- No FEAR Act EEO Data

ON USPS.COM

- Government Services
- Buy Stamps & Shop
- Print a Label with Postage
- Customer Service
- Site Index

© 2012 USPS. All Rights Reserved.

2022-011769 MISC Page: 2074 of 2782
 09/26/2022 03:35:37 PM Receipt #: 22-9381
 Reg Fee: \$30.00 Darrell James Hill
 Gila County, AZ Sadie Jo Bingham, Recorder

SENDER: COMPLETE THIS SECTION

- Complete items 1, 2, and 3. Also complete item 4 if Restricted Delivery is desired.
- Print your name and address on the reverse so that we can return the card to you.
- Attach this card to the back of the mailpiece, or on the front if space permits.

1. Article Addressed to:

Berger & Montague, P.C.
David F. Sorensen
1622 Locust Street
Philadelphia, PA 19102-6305

COMPLETE THIS SECTION ON DELIVERY

A. Signature Agent Addressee
[Signature]

B. Received by (Printed Name) *H. Korte* C. Date of Delivery

D. Is delivery address different from item 1? Yes No
 If YES, enter delivery address below:

3. Service Type
 Certified Mail Express Mail
 Registered Return Receipt for Merchandise
 Insured Mail C.O.D.

4. Restricted Delivery? (Extra Fee) Yes

2. Article Number 700
 (Transfer from service label)

PS Form 3811, February 2004 Domestic Ret

DOCH 361061
 11/27/2012 04:15 PM Page: 171 of 178
 AFF R:\$10.00 J. C. Sloan, Mckinley County

DOCH 361076

11/27/2012 04:15 PM Page: 172 of 183
AFF R:\$10.00 J. C. Sloan, Mckinley County

Unofficial Copy

Item No. 5

Item 5:
Nov. 2012

Class Attorney(s) Corroborating Willful Fraud Against Class Member
Class Attorney David Sorensen, Philadelphia, Pennsylvania Nov. 7, 2012,
FedEx letter, TRK #201, 5366 8192 3342
Johnson, et al. v. AzHHA, et al., Class Member Darrell James, Hill
November 8, 2012
(document date)

DOCH 361076

11/27/2012 04:15 PM Page: 173 of 183
AFF R:\$10.00 J. C. Sloan, McKinley County



2022-011769 MISC Page: 2075 of 2782

09/26/2022 03:35:37 PM Receipt #: 22-9381
Rec Fee: \$30.00 Darrell James Hill
Gila County, Az, Sadie Jo Bingham, Recorder



DOCH 361061

11/27/2012 01:09 PM Page: 172 of 178
AFF R:\$10.00 J. C. Sloan, McKinley County



Berger & Montague, P.C.
ATTORNEYS AT LAW

DAVID F. SORENSEN
WRITER'S DIRECT DIAL 215/875-5705
WRITER'S DIRECT FAX 215/875-5707
WRITER'S DIRECT E-MAIL dsorensen@bm.net

November 7, 2012

VIA FED EX DELIVERY

Darrell James, Hill
28 Hilltop Court
HC 61, Box 771
Ramah, NM 87321

Re: Johnson, et al. v. Arizona Hospital and Healthcare Assoc., et al.

Dear Mr. Hill:

I am writing to follow up on my letter to you dated October 31, 2012. In that letter, I told you of our final determination denying your individual request that, as to the claim you submitted in connection with the settlements in the Johnson v. AzHHA matter, the claims administrator not withhold applicable taxes from any settlement distribution payment you might receive as a claimant because of your view that you have, in effect, withdrawn or "opted out" of the Social Security and/or tax system.

As I told you in the October 31, 2012, letter, if you wish to appeal to the Court overseeing this case, you may contact the Court at: Clerk of Court, Johnson v. Arizona Hospital and Healthcare et al., No. 07-1292, U.S. District Court for District of Arizona, Sandra Day O'Connor U.S. Courthouse, 401 W. Washington St., Phoenix, Arizona 85003. If you wish to appeal, you should do so within seven (7) days, because we intend to shortly ask the Court for permission to distribute funds.

Thank you. You may contact me if you have questions.

Sincerely,

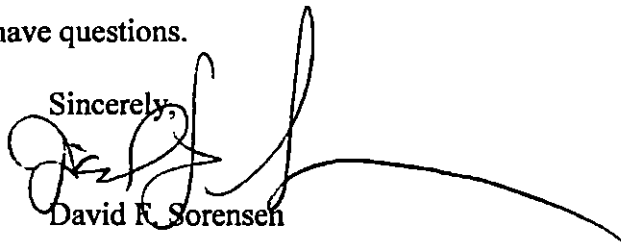

David F. Sorensen

cc: Mark Samson (by email)
Mike Lee (by email)

2022-011769 MISC Page: 2076 of 2782
09/26/2022 03:35:37 PM Receipt #: 22-9381
Rec Fee: \$30.00 Darrell James Hill
Gila County, Az, Sadie Jo Bingham, Recorder



DOCH 361061

11/27/2012 01:09 PM Page: 173 of 178
AFF R:\$10.00 J. C. Sloan, Mckinley County



DOCH 361076
11/27/2012 04:15 PM Page: 174 of 183
AFF R:\$10.00 J. C. Sloan, Mckinley County

COPY

2067

Item No. 6

Item 6:
Nov. 2012

Response and Reiteration:

Complaint of Class Attorney Willful Fraud Against Class Member
Complaint of Class Attorney(s) Sorensen Corroborating Willful Fraud Against Class Member
Johnson, et al. v. AzHHA, et al., Class Attorney David Sorensen c/o Harold Berger (Managing
Shareholder- Berger and Montague, P.C.) Philadelphia, Pennsylvania
cc: Mark Samson, Class Attorney
USPO CMN: 7010 1670 0001 1601 2344
Accepted: Nov. 19, 2012

DOCH 361076

11/27/2012 04:15 PM Page: 175 of 183
AFF R:\$10.00 J. C. Sloan, Mckinley County



2022-011769 MISC Page: 2077 of 2782

09/26/2022 03:35:37 PM Receipt #: 22-9381
Rec Fee: \$30.00 Darrell James Hill
Gila County, Az, Sadie Jo Bingham, Recorder



DOCH 361061

11/27/2012 01:09 PM Page: 174 of 178
AFF R:\$10.00 J. C. Sloan, Mckinley County



Darrell James, Hill
28 Hilltop Court, HC 61 771, Ramah, N. Mex.

David Sorensen
c/o Harold Berger, Managing Shareholder
Berger & Montague, P.C.
1622 Locust Street
Philadelphia, PA 19103

RE: c/o David Sorensen's Corroboration of Willful Fraud with RG2 Claims Against This Johnson v AzHHA Class Member Darrell James, Hill.

Shalom David, et al.:

This is likely my final letter to you I hope.
I hope you are well.

My provider is my God Yahweh (HVHY), not the federal government. The money in question in this case was stolen from me. Whoever curses me will be cursed.

Regarding your November 8, 2012, FedEx letter (Trk 0201, 5366 8192 3342, not attached) the facts remain, that:

- a) No withholding was, nor is now, authorized or allowed by me; no "applicable tax" ever "applied".
- b) You have never had authority on these issues beyond which I gave you: therein, you were never given direction nor latitude to ignore my position or my "status" statement which are one.
- c) RG2 Claims did as a federal "withholding agent" of the TD/IRS accepted my position statement in late 2011. RG2 accepted my "status" statement in early 2012. RG2 did not rebut a single point as required in writing to disagree in fact with any point in my "status" statement. Therefore, RG2 remains bound by the "status" statement according to applicable law and federal regulations.
- d) Your hand on these matters offends and hurts me deeply. This is very disturbing.

Sincerely,

2019
Darrell James, Hill,
Class Member
Johnson, et al. v. AzHHA

COPY

DOCH 361076

11/27/2012 04:15 PM Page: 176 of 183
AFF R:\$10.00 J. C. Sloan, Mckinley County

2022-011769 MISC Page: 2078 of 2782
09/26/2022 03:35:37 PM Receipt #: 22-9381
Rec Fee: \$30.00 Darrell James Hill
Gila County, Az, Sadie Jo Bingham, Recorder

DOCH 361061

11/27/2012 01:09 PM Page: 175 of 178
AFF R:\$10.00 J. C. Sloan, Mckinley County



Darrell James, Hill
28 Hilltop Court, HC 61 771, Ramah, N. Mex.

Harold Berger, Managing Shareholder
Berger & Montague, P.C.
1622 Locust Street
Philadelphia, PA 19103

RE: c/o David Sorensen's Corroboration of Willful Fraud with RG2 Claims Against This Johnson v
AzHHA Class Member Darrell James, Hill.

Mr. Berger;

This is a complaint and notice to you about this that has been going on. Essentially David is
corroborating with RG2 Claims against my authorization.

The entire correspondence will be placed into the public record for your general access soon.

Sincerely,

Darrell James, Hill,
Class Member
Johnson, et al. v. AzHHA

DOCH 361076

11/27/2012 04:15 PM Page: 177 of 183
AFF R:\$10.00 J. C. Sloan, McKinley County



2022-011769 MISC Page: 2079 of 2782
09/26/2022 03:35:37 PM Receipt #: 22-9381
Rec Fee: \$30.00 Darrell James Hill
Gila County, Az, Sadie Jo Bingham, Recorder



DOCH 361061

11/27/2012 01:09 PM Page: 176 of 178
AFF R:\$10.00 J. C. Sloan, McKinley County



Darrell James, Hill
28 Hilltop Court, HC 61 771, Ramah, N. Mex.

Mark D. Samson
3101 North Central Avenue, Suite 1400
Phoenix, Arizona 85012-2643

RE: letter attached from Johnson v. AzHHA class member

Mark,

This is likely the last letter about the RG2 claims and David Sorensen issue (see attached).

I do not agree with David's action on the limited matters. And, I certainly don't agree with David's compromise with RG2.

Sincerely,

Darrell James, Hill,
Class Member
Johnson, et al. v. AzHHA

Unofficial Copy

Unofficial

DOCH 361076

11/27/2012 04:15 PM Page: 178 of 183
AFF R:\$10.00 J. C. Sloan, Mckinley County



2022-011769 MISC Page: 2080 of 2782
09/26/2022 03:35:37 PM Receipt #: 22-9381
Rec Fee: \$30.00 Darrell James Hill
Gila County, Az, Sadie Jo Bingham, Recorder



DOCH 361061

11/27/2012 01:09 PM Page: 177 of 178
AFF R:\$10.00 J. C. Sloan, Mckinley County



Item No. 6

Item 6:

Encl. 1

Nov. 2012

Response and Reiteration:

Complaint of Class Attorney Willful Fraud Against Class Member
Mailing and Acceptance Information)

Johnson, et al. v. AzHHA, et al., Class Attorney David Sorensen c/o Harold Berger (Managing
Shareholder- Berger and Montague, P.C.) Philadelphia, Pennsylvania

cc: Mark Samson, Class Attorney

USPO CMN: 7010 1670 0001 1601 2344

Accepted: Nov. 19, 2012

Mailing and Acceptance Information

Unofficial Copy

2012

2022-011769 MISC Page: 2081 of 2782
09/26/2022 03:35:37 PM Receipt #: 22-9381
Rec Fee: \$30.00 Darrell James Hill
Gila County, Az: Sadie Jo Bingham, Recorder



DOCH 361076

11/27/2012 04:15 PM Page: 179 of 183
AFF R: \$10.00 J. C. Sloan, McKinley County



English Customer Service USPS Mobile

Register / Sign In



Search USPS.com or Track Packages

Quick Tools

Ship a Package

Send Mail

Manage Your Mail

Shop

Business Solutions

Track & Confirm

GET EMAIL UPDATES PRINT DETAILS

YOUR LABEL NUMBER	SERVICE	STATUS OF YOUR ITEM	DATE & TIME	LOCATION	FEATURES
70101670000116012344		Delivered	November 19, 2012, 11:50 am	PHILADELPHIA, PA 19103	Certified Mail™
		Notice Left (No Authorized Recipient Available)	November 16, 2012, 11:45 am	PHILADELPHIA, PA 19103	
		Arrival at Unit	November 16, 2012, 6:53 am	PHILADELPHIA, PA 19104	
		Processed through USPS Sort Facility	November 16, 2012, 12:31 am	PHILADELPHIA, PA 19176	

Check on Another Item

What's your label (or receipt) number?



LEGAL

- Privacy Policy ›
- Terms of Use ›
- FOIA ›
- No FEAR Act EEO Data ›

ON USPS.COM

- Government Services ›
- Buy Stamps & Shop ›
- Print a Label with Postage ›
- Customer Service ›
- Site Index ›

ON ABOUT.USPS.COM

- About USPS Home ›
- Newsroom ›
- Mail Service Updates ›
- Forms & Publications ›
- Careers ›

OTHER USPS SITES

- Business Customer Gateway ›
- Postal Inspectors ›
- Inspector General ›
- Postal Explorer ›

Copyright © 2012 USPS. All Rights Reserved.

U.S. Postal ServiceTM
CERTIFIED MAILTM RECEIPT
(Domestic Mail Only; No Insurance Coverage Provided)

For delivery information visit our website at www.usps.com

OFFICIAL USE

Postage	\$ 1.75
Certified Fee	2.95
Return Receipt Fee (Endorsement Required)	
Restricted Delivery Fee (Endorsement Required)	
Total Postage & Fees	\$ 3.40

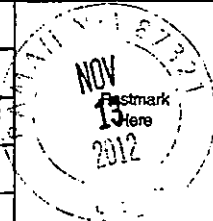

Sent To Harold Berger
 Street, Apt. No., or PO Box No. 1622 Locust Street
 City, State, ZIP+4[®] Philadelphia, Penn. 19103

PS Form 3800, August 2006 See Reverse for Instructions

2022-011769 MISC Page: 2082 of 2782
 09/26/2022 03:35:37 PM Receipt #: 22-9381
 Rec Fee: \$30.00 Darrell James Hill
 Gila County, Az, Sadie Jo Bingham, Recorder



DOC# 361076

11/27/2012 04:15 PM Page: 180 of 183
AFF R: \$10.00 J. C. Sloan, McKInley County



2013 Unofficial

Unofficial Copy

Item No. 7

Item 7:

Nov. 2012

John R. Davis/ RG2 document

Darrell James, Hill

FedEx TRK# 0215, 8005 2316 6974); received on November 26, 2012, (2 pages)

2014

2022-011769 MISC Page: 2083 of 2782
09/26/2022 03:35:37 PM Receipt #: 22-9381
Rec Fee: \$30.00 Darrell James Hill
Gila County, Az, Sadie Jo Bingham, Recorder



DOCH 361076

11/27/2012 04:15 PM Page: 161 of 163
AFF R: \$10.00 J. C. Sloan, McKinley County



RG2

Claims
Administration LLC

November 20, 2012

Via Federal Express

Darrell James, Hill
28 Hilltop Court, HC 62 Box 771
Ramah, NM 87321

Re: **Johnson, et al. v. Arizona Hospital & Healthcare Association, et al.**
Claim #: **AZA000000930**

Dear Mr. Hill:

We are writing in response to your request that RG/2 Claims not utilize your social security number or withhold taxes from any settlement payment you may be due.

The materials that you submitted in support of your claim are inconsistent with the above request. You provided as part of your submissions W-2 tax forms which include a social security number and demonstrate both the wages earned and federal and state taxes withheld. You also represented that you had rescinded your SSN as of May, 2006, but failed to provide proof that the Social Security Administration accepted this request.

In your letter dated December 1, 2011 you "prohibited" RG/2 Claims from (1) "us[ing] any SSN in [your] regard" and (2) "pay[ing] any tax obligations or making any distributions to any taxing authority for any obligation assumed or alleged owed." You stated that you (and your spouse) had terminated your SSA account and number in 2006. You provided your demand letter to the Social Security Administration without providing an acknowledgement from the Social Security Administration that they had acceded to your demand and terminated the account. Class Counsel informed you in a letter dated October 31, 2012 that you needed to produce documents from the Social Security Administration (not just to them) and/or from other taxing authorities officially agreeing with you in order for RG/2 Claims to evaluate your claim. In response, you produced a copy of a letter dated October 1, 2012 from the Social Security Administration which explains that you cannot voluntarily end your participation in the Social Security program. Similarly, you produced nothing from any government agency recognizing what you state in your "Affidavit of Citizenship, Domicile, and Tax Status" that your citizenship is "Nonresident alien NON-individual" and that your domicile is "Transient Foreigner." In sum, RG/2 Claims is required by law to withhold and remit taxes on any settlement payment you may be due.

COPY

DOCH 361076

11/27/2012 04:15 PM Page: 182 of 183
AFF R: \$10.00 J. C. Slean, McKinley County



2015

P.O. Box

2022-011769 MISC Page: 2084 of 2782
09/26/2022 03:35:37 PM Receipt #: 22-9381
Rec Fee: \$30.00 Darrell James Hill
Gila County, Az, Sadie Jo Bingham, Recorder



Darrell James, Hill
November 20, 2012
Page 2

RG2
Claims
Administration LLC

Please understand that this is our final determination regarding your individual request. If you wish to appeal to the Court overseeing this case, you may contact the Court at: *Clerk of Court, Johnson v. Arizona Hospital and Healthcare et al., No. 07-1292, U.S. District Court for District of Arizona, Sandra Day O'Connor U.S. Courthouse, 401 W. Washington St., Phoenix, Arizona 85003.*

Sincerely,

AzHHA Litigation
Claims Administrator
RG2 Claims Administration LLC

361076



[Handwritten signature]

2022-011769 MISC Page: 2085 of 2782
09/26/2022 03:35:37 PM Receipt #: 22-9381
Rec Fee: \$30.00 Darrell James Hill
Gila County, Az, Sadie Jo Bingham, Recorder

DOC# 361076
11/27/2012 04:15 PM Page: 183 of 183
AFF R: \$10.00 J. C. Sloan, Mckinley County

55
823-6866

Mckinley County, NM
Jacqueline C. Sloan
County Clerk
207 W Hill Ave
P.O. Box 1268
Gallup, NM 87301

Receipt: 0019227

Product	Name	Extended
AFF	Affidavit	\$10.00
# Pages 178, Document # 361061, Document Info: DARRELL JAMES-HILL, No Charge Item false		
Total		\$10.00
Tender (Cash)		\$10.00
Paid By DARRELL JAMES-HILL, Phone # 602.618.4595, Recorded By DCHAVEZ		

823

Mckinley County, NM
Jacqueline C. Sloan
County Clerk
207 W. Hill Ave
P.O. Box 1268
Gallup, NM 87301

Receipt: 0019241

Product	Name	Extended
AFF	Affidavit	\$10.00
# Pages 163, Document # 361076, Document Info: DARRELL JAMES HILL, No Charge Item: false		
Total		\$10.00
Tender (Cash)		\$10.00
Paid By DARRELL JAMES-HILL, Phone # 602.618.4595, Recorded By DCHAVEZ		

Thank You!

Unofficial Copy
2023

:Darrell-James: Hill, -:Ohioan- beneficiary, :Executor, and
:Beverly-Jean: Romero- Hill, :New-Mexican- beneficiary, -:Executor
~Hill-Executors: PE-2016-A.D.-covenant- agreements¹-
c/o: PO Box 3806
Apache-Junction, Arizona [85117]

:Sadie-Jo: Bingham², -:Recorder, -:Trustee
c/o: Gila-County-Recorder-Office
1400 East Ash, Globe, Arizona [85501]

:notice: For the obfuscation and slander-damage-imposed on the Hill-Executors is with the deprivation-penalty-covenant-agreements and mitigation-requests-made- herein of the Hill-Executors- PE-2016-A.D.- covenants with the Arizona-State-Gila- County-Trustee -Recorder -Doc.## -2005-022460³, 2007-007742⁴, and 2007-007743⁵ ⁶. recordation-obligations by the law of the PE-2016-A.D.- covenant-agreements.

Greetings Sadie-Jo:

1. :i- man- Darrell-James: Hill, -:Ohioan, et al., -:Executor, et al., and :Beverly-Jean: Romero- Hill, -:New-Mexican, et al., -:Executor, et al., accept your Loyalty-of-Oath of the Arizona-State-Gila-County-Trustee-Office.

Doc.#: 2005-022460- obfuscation and slander- damage upon the Hill-Executors

2) For the Mitigation⁷: obfuscation: Doc.#: 2005-022460, upon the receipt of this SOLE-request the -:view-ability and common-access -obfuscation of the Gila-County- Recorder-Doc.#:-:2005-022460 must-end-now-to-after by the law of the PE-2016-A.D.- covenant-agreement.

3) For the Mitigation: slander: Doc.#: 2005-022460, upon the receipt of this SOLE- request the -:'INCOME TAX PROTEST'-slander-damage in the record must-end-now-to- after by the law of the PE-2016-A.D.-covenant-agreement.

Doc.#: 2007-007742 – slander- damage upon the Hill-Executors

4) For the Mitigation: slander: Doc.#: 2007-007742, upon the receipt of this SOLE- request the -:'TAX PROTEST'-slander-damage in the record must-end-now-to-after by the law of the PE-2016-A.D.-covenant-agreement.

Doc.#: 2007-007743 – slander- damage upon the Hill-Executors

5) For the Mitigation: slander: Doc.#: 2007-007743, upon the receipt of this SOLE- request the -:'TAX PROTEST'-slander-damage in the record must-end-now-to-after by the law of the PE-2016-A.D.-covenant-agreement.

:i- man verify the above is true and correct to my best ability, and will state same in the open court.

Without prejudice,

December-30- 2021

Darrell-James Hill, -:Executor
:Darrell-James: Hill, -:Ohioan, -:Executor

December-30- 2021

Beverly-Jean Romero Hill, New-Mexican, -:Executor
:Beverly-Jean: Romero- Hill, -:New-Mexican, -:Executor

- 1 :Hill-Executors: PE-2016-A.D.- covenant-agreements means: See -:Gila-County-Rec.-Doc.#: 2017- 002378, pp. 1- 181.
- 2 :Sadie-Jo: Bingham means: man: Arizona-State-Gila-County-Office, -- See -:Gila-County-Rec.- Doc.##: 2017-000110; 2021-000771, -:Loyalty-of-Oath-of-Office. -- See: appended, 4 pages.
- 3 :Doc.#: 2005-022460 means: reference to :Gila-County-Rec.-Doc.#: 2005-022460.
- 4 :Doc.#: 2007-007742 means: reference to: Gila-County-Rec.-Doc.#: 2007- 007742.
- 5 :Doc.#: 2007-007743 means: reference to: Gila-County-Rec.-Doc.#: 2007- 007743.
- 6 See: appended: Gila-County-Rec.-doc.Summary: GrantorID for: Hill, darrell- copy; 2 pgs.
- 7 :Mitigation means: Damage-alleviation, -:remedy, :abatement or diminution of the penalty or punishment imposed by the law; in the nature of the Black's-Law-Dict., 4th Ed., p. 1153.

:Necessary-Doc.-:Corrections- request: Dec.30.2021-



2078

:Darrell-James: Hill, -:Ohioan- beneficiary, :Executor, and
:Beverly-Jean: Romero- Hill, :New-Mexican- beneficiary, -:Executor
~Hill-Executors: PE-2016-A.D.-covenant- agreements¹~
c/o: PO Box 3806
Apache-Junction, Arizona [85117]

:Sadie-Jo: Bingham², -:Recorder, -:Trustee
c/o: Gila-County-Recorder-Office
1400 East Ash, Globe, Arizona [85501]

:notice: For the obfuscation and slander-damage-imposed on the Hill-Executors is with the deprivation-penalty-covenant-agreements and mitigation-requests-made- herein of the Hill-Executors- PE-2016-A.D.- covenants with the Arizona-State-Gila- County-Trustee -Recorder -Doc.## -2005-022460³, 2007-007742⁴, and 2007-007743^{5 6}. recordation-obligations by the law of the PE-2016-A.D.- covenant-agreements.

Greetings Sadie-Jo:

1. :i- man- Darrell-James: Hill, -:Ohioan, et al., -:Executor, et al., and :Beverly-Jean: Romero- Hill, -:New-Mexican, et al., -:Executor, et al., accept your Loyalty-of-Oath of the Arizona-State-Gila-County-Trustee-Office.

Doc.#: 2005-022460- obfuscation and slander- damage upon the Hill-Executors

2) For the Mitigation⁷: obfuscation: Doc.#: 2005-022460, upon the receipt of this SOLE-request the -:view-ability and common-access -obfuscation of the Gila-County- Recorder-Doc.#-:2005-022460 must-end-now-to-after by the law of the PE-2016-A.D.- covenant-agreement.

3) For the Mitigation: slander: Doc.#: 2005-022460, upon the receipt of this SOLE- request the -:'INCOME TAX PROTEST'-slander-damage in the record must-end-now-to- after by the law of the PE-2016-A.D.-covenant-agreement.

Doc.#: 2007-007742 – slander- damage upon the Hill-Executors

4) For the Mitigation: slander: Doc.#: 2007-007742, upon the receipt of this SOLE- request the -:'TAX PROTEST'-slander-damage in the record must-end-now-to-after by the law of the PE-2016-A.D.-covenant-agreement.

Doc.#: 2007-007743 – slander- damage upon the Hill-Executors

5) For the Mitigation: slander: Doc.#: 2007-007743, upon the receipt of this SOLE- request the -:'TAX PROTEST'-slander-damage in the record must-end-now-to-after by the law of the PE-2016-A.D.-covenant-agreement.

:i- man verify the above is true and correct to my best ability, and will state same in the open court.

Without prejudice,

December-30- 2021 :Darrell-James: Hill, -:Executor
:Darrell-James: Hill, -:Ohioan, -:Executor

December-30- 2021 :Beverly-Jean: Romero: Hill, -:New-Mexican, -Creator
:Beverly-Jean: Romero- Hill, -:New-Mexican, -:Executor

- 1 :Hill-Executors: PE-2016-A.D.- covenant-agreements means: See -:Gila-County-Rec.-Doc.#: 2017-002378, pp. 1- 181.
- 2 :Sadie-Jo: Bingham means: man: Arizona-State-Gila-County-Office, – See -:Gila-County-Rec.- Doc.##: 2017-000110; 2021-000771, -:Loyalty-of-Oath-of-Office. – See: appended, 4 pages.
- 3 :Doc.#: 2005-022460 means: reference to :Gila-County-Rec.-Doc.#: 2005-022460.
- 4 :Doc.#: 2007-007742 means: reference to: Gila-County-Rec.-Doc.#: 2007- 007742.
- 5 :Doc.#: 2007-007743 means: reference to: Gila-County-Rec.-Doc.#: 2007- 007743.
- 6 See: appended: Gila-County-Rec.-doc.Summary: GrantorID for: Hill, darrell- copy; 2 pgs.
- 7 :Mitigation means: Damage-alleviation, -:remedy, :abatement or diminution of the penalty or punishment imposed by the law; in the nature of the Black's-Law-Dict., 4th Ed., p. 1153.

Necessary-Doc.-:Corrections- request: Dec.30.20;





When recorded, Return to

Attention: Eric Mariscal
Gila County Division of Elections



UNOFFICIAL COPY

Loyalty of Oath of Office

Do Not remove this sheet, it is part of the Recorded Document

UNOFFICIAL COPY



2080

OATH OF OFFICE

I, the undersigned, hereby execute this document in compliance with A.R.S. § 38-231:

OFFICERS AND EMPLOYEES REQUIRED TO TAKE LOYALTY OATH: CLASSIFICATION: DEFINITION

- A. In order to ensure the statewide application of this section on a uniform basis, each board, commission, agency and independent office of this state, and of any of its political subdivisions, and of any county, city, town, municipal corporation, school district and public educational institution, shall completely reproduce this section so that the form of written oath or affirmation required in this section contains all of the provisions of this section for use by all officers and employees of all boards, commissions, agencies and independent offices.
- B. Any officer or employee who fails to take and subscribe to the oath or affirmation provided by this section within the time limits prescribed by this section is not entitled to any compensation until the officer or employee does so take and subscribe to the form of oath or affirmation prescribed by this section.
- C. Any officer or employee having taken the form of an oath or affirmation prescribed by this section and knowingly at the time of subscribing to the oath or affirmation, or at any time thereafter during the officer's or employee's term of office or employment, does commit or aid in the commission of any act to overthrow by force, violence or terrorism defined in section 13-2301 the government of this state or any of its political subdivisions, or advocates the overthrow by force, violence or terrorism as defined in section 13-2301 of the government of this state or of any of its political subdivisions, is guilty of a class 4 felony and, on conviction under this section, the officer or employee is deemed discharged from the office or employment and is not entitled to any additional compensation or any other emoluments or benefits which may have been incident or appurtenant to the office or employment.
- D. Any of the persons referred to in article XVIII, section 10, Constitution of Arizona, as amended, relating to the employment of aliens, are exempted from any compliance with this section.
- E. In addition to any other form of oath or affirmation specifically provided by law for an officer or employee, before any officer or employee enters upon the duties of the office or employment, the officer or employee shall take and subscribe the following oath or affirmation: (Below)
- F. For the purposes of this section, "officer or employee" means any person elected, appointed or employed, either on a part-time or full time basis, by this state or any of its political subdivisions or any county, city, town, municipal corporation, school district or public educational institution or any board, commission or agency of any county, city, town, municipal corporation, school district or public educational institution.

A.R.S. § 38-231 (E) Oath:

State of Arizona, County of Gila

I, Sadie Jo Bingham do solemnly swear (or affirm) that I will support the Constitution of the United States and the Constitution and laws of the State of Arizona; that I will bear true faith and allegiance to the same, and defend them against all enemies, foreign and domestic, and that I will faithfully and impartially discharge the duties of Gila County Recorder according to the best of my ability, so help me God (or so do I affirm).

Sadie Jo Bingham
Signature

Subscribed and sworn (or affirmed) to before me on this 19th day of January, 2021.

(SEAL)

Erica Mariscal
Notary Public



ERICA MARISCAL
Notary Public - State of Arizona
GILA COUNTY
My Commission Expires
August 11, 2021





When recorded, Mail to

Attention: Eric Mariscal
Gila County Division of Elections

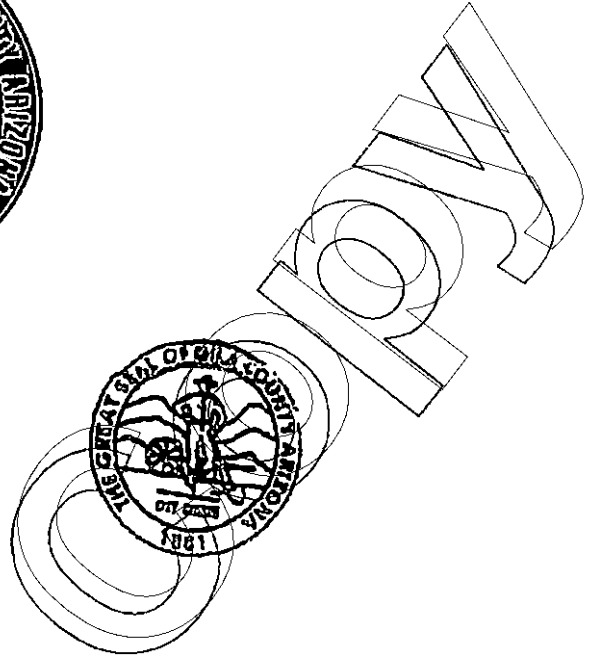

Loyalty of Oath of Office

Do Not remove this sheet, it is part of the Recorded Document

2022-011769 MISC Page: 2091 of 2782
09/26/2022 03:35:37 PM Receipt #: 22-9381
Rec Fee: \$30.00 Darrell James Hill
Gila County, Az, Sadie Jo Bingham, Recorder



2017-000110 OATH Page: 1 of 2
01/04/2017 03:42:58 PM Receipt #: 17-0073
Rec Fee: \$0 Gila County Elections
Gila County, Az, Sadie Jo Bingham, Recorder



OATH OF OFFICE

Gila County Recorder

I, the undersigned, hereby execute this document in compliance with A.R.S. § 38-231 and § 11-542: OFFICERS AND EMPLOYEES REQUIRED TO TAKE LOYALTY OATH: CLASSIFICATION: DEFINITION

- A. In order to ensure the statewide application of this section on a uniform basis, each board, commission, agency and independent office of this state, and of any of its political subdivisions, and of any county, city, town, municipal corporation, school district and public educational institution, shall completely reproduce this section so that the form of written oath or affirmation required in this section contains all of the provisions of this section for use by all officers and employees of all boards, commissions, agencies and independent offices.
B. Any officer or employee who fails to take and subscribe to the oath or affirmation provided by this section within the time limits prescribed by this section is not entitled to any compensation until the officer or employee does so take and subscribe to the form of oath or affirmation prescribed by this section.
C. Any officer or employee having taken the form of an oath or affirmation prescribed by this section and knowingly at the time of subscribing to the oath or affirmation, or at any time thereafter during the officer's or employee's term of office or employment, does commit or aid in the commission of any act to overthrow by force, violence or terrorism defined in section 13-2301 the government of this state or any of its political subdivisions, or advocates the overthrow by force, violence or terrorism as defined in section 13-2301 of the government of this state or of any of its political subdivisions, is guilty of a class 4 felony and, on conviction under this section, the officer or employee is deemed discharged from the office or employment and is not entitled to any additional compensation or any other emoluments or benefits which may have been incident or appurtenant to the office or employment.
D. Any of the persons referred to in article XVIII, section 10, Constitution of Arizona, as amended, relating to the employment of aliens, are exempted from any compliance with this section.
E. In addition to any other form of oath or affirmation specifically provided by law for an officer or employee, before any officer or employee enters upon the duties of the office or employment, the officer or employee shall take and subscribe the following oath or affirmation: (Below)
For the purposes of this section, "officer or employee" means any person elected, appointed or employed, either on a part-time or full time basis, by this state or any of its political subdivisions or any county, city, town, municipal corporation, school district or public educational institution or any board, commission or agency of any county, city, town, municipal corporation, school district or public educational institution.

A.R.S. § 38-231 (E) Oath:

State of Arizona, County of Gila

I, Sadie Jo Bingham do solemnly swear (or affirm) that I will support the Constitution of the United States and the Constitution and laws of the State of Arizona; that I will bear true faith and allegiance to the same, and defend them against all enemies, foreign and domestic, and that I will faithfully and impartially discharge the duties of office of Gila County Recorder according to the best of my ability, so help me God (or so do I affirm).

Sadie Jo Bingham Signature

Subscribed and sworn (or affirmed) to before me on this 3rd day of January, 2017

Kaycee Stratton Notary Public

KAYCEE STRATTON Notary Public, State of Arizona Gila County My Commission Expires February 17, 2017

2017-000110 OATH Page: 2 of 2 01/04/2017 03:42:58 PM Receipt #: 17-0073 Rep Fee: \$0 Gila County Elections Gila County, Az, Sadie Jo Bingham, Recorder

2022-011769 MISC Page: 2092 of 2782 09/26/2022 03:35:37 PM Receipt #: 22-9381 Rec Fee: \$30.00 Darrell James Hill Gila County, Az, Sadie Jo Bingham, Recorder



2085

[New Search](#) [Modify Search](#) [Printable Version](#)

You searched for: RecDateID >= Sat Feb 02 00:00:00 MST 1985 and <= Tue Dec 21 00:00:00 MST 2021 and exact search in GrantorID for Hill, darrell

10 items found, displaying all items.1

Description	Summary	Add All to My Images
Affidavit 2005-022460	<p>Rec Date: 12/07/2005 02:18:00 PM LiberPage: Related: Grantor: HILL DARRELL J, ROMERO HILL BEVERLY J, HILL BEVERLY J ROMERO, SUPERIOR CLAIMS MANAGEMENT Legal: Grantee: HILL DARRELL J, ROMERO HILL BEVERLY J, HILL BEVERLY J ROMERO, SUPERIOR CLAIMS MANAGEMENT Notes: INCOME TAX PROTEST, MANY, EXHIBITS NOT LEGIBLE ENOUGH, TO, REPRODUCE WELL</p>	<p>View Image Add to My Images</p>
Miscellaneous Instrument 2006-008777	<p>Rec Date: 05/22/2006 02:49:00 PM LiberPage: Related: Grantor: HILL DARRELL JAMES Legal: Grantee: HILL DARRELL JAMES Notes:</p>	<p>View Image Add to My Images</p>
Miscellaneous Instrument 2007-007742	<p>Rec Date: 05/04/2007 02:17:00 PM LiberPage: Related: Grantor: HILL DARRELL JAMES Legal: Grantee: HILL DARRELL JAMES Notes: TAX PROTEST CV 05 0877 PHX DGC</p>	<p>View Image Add to My Images</p>
Miscellaneous Instrument 2007-007743	<p>Rec Date: 05/04/2007 02:17:00 PM LiberPage: Related: Grantor: HILL DARRELL JAMES Legal: Grantee: HILL DARRELL JAMES Notes: TAX PROTEST RB 898 807 966 US</p>	<p>View Image Add to My Images</p>
Miscellaneous Instrument 2017-002378	<p>Rec Date: 03/10/2017 12:35:10 PM LiberPage: Related: Grantor: HILL DARRELL JAMES, HILL BEVERLY JEAN ROMERO Legal: Grantee: HILL DARRELL JAMES, HILL BEVERLY JEAN ROMERO Notes:</p>	<p>View Image Add to My Images</p>
Affidavit 2017-006522	<p>Rec Date: 07/07/2017 10:09:05 AM LiberPage: Related: 2017-002378 Grantor: HILL DARRELL JAMES Legal: Grantee: HILL DARRELL JAMES Notes: PROOF OF CLAIM</p>	<p>View Image Add to My Images</p>
Miscellaneous Instrument 2018-005176	<p>Rec Date: 05/14/2018 02:29:31 PM LiberPage: Related: 2017-002378 Grantor: HILL DARRELL JAMES, ROMERO HILL BEVERLY JEAN, HILL BEVERLY JEAN ROMERO Legal: Grantee: HILL DARRELL JAMES, ROMERO HILL BEVERLY JEAN, HILL BEVERLY JEAN ROMERO Notes: AFFIDAVIT STATEMENT OF CLAIM</p>	<p>View Image Add to My Images</p>
Miscellaneous Instrument 2019-009291	<p>Rec Date: 08/30/2019 02:24:05 PM LiberPage: Related: 2017-002378, 2017-006522, 2018-005176 Grantor: HILL DARRELL JAMES Legal: Grantee: HILL DARRELL JAMES Notes:</p>	<p>View Image Add to My Images</p>
Miscellaneous Instrument 2019-011722	<p>Rec Date: 10/29/2019 11:47:58 AM LiberPage: Related: 2017-002378, 2017-006522, 2018-005176, 2019-009291 Grantor: HILL DARRELL JAMES, ROMERO HILL BEVERLY JEAN, HILL BEVERLY JEAN ROMERO, Legal:</p>	<p>View Image Add to My Images</p>

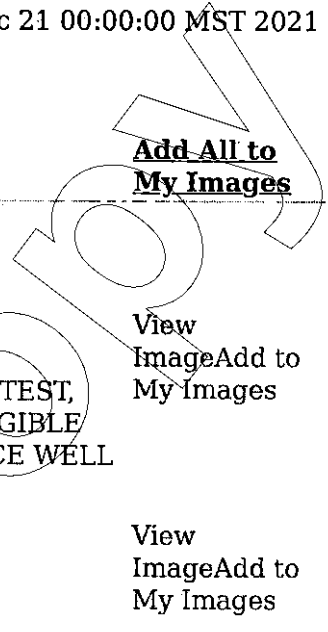

2022-011769 MISC Page: 2093 of 2782
09/26/2022 03:35:37 PM Receipt #: 22-9981
Rec Fee: \$30.00 Darrell James Hill
Gila County, Az, Sadie Jo Bingham, Recorder

2084

Description	Summary	Add All to My Images
Miscellaneous Instrument 2021-016195	<p>INGOLD JAY ROY , CALHOUN TRACY ROBERT , ...</p> <p>Grantee: HILL DARRELL JAMES , Notes: ROMERO HILL BEVERLY JEAN, HILL BEVERLY JEAN ROMERO, INGOLD JAY ROY , CALHOUN TRACY ROBERT , ...</p> <p>Rec Date: 12/02/2021 10:19:01 AM LiberPage: Related: 2005-022460, 2006-008777, 2007-007742, 2007-007743, 2017-002378, ...</p> <p>Grantor: HILL DARRELL-JAMES, Legal: HILL BEVERLY-JEAN ROMERO-, ROMERO-HILL BEVERLY-JEAN, INGOLD JAY-ROY</p> <p>Grantee: HILL DARRELL-JAMES, Notes: CV20181825, HILL BEVERLY-JEAN ROMERO-, CV202000723 ROMERO-HILL BEVERLY-JEAN, INGOLD JAY-ROY</p>	View ImageAdd to My Images

10 items found, displaying all items.1

[New Search](#)[Modify Search](#)[Printable Version](#)

Unofficial Copy

2022-011769 MISC Page: 2094 of 2782
 09/26/2022 03:35:37 PM Receipt #: 22-9381
 Rec Fee: \$30.00 Darrell James Hill
 Gila County, Az, Sadie Jo Bingham, Recorder





APACHE JUNCTION
151 W SUPERSTITION BLVD
APACHE JUNCTION, AZ 85120-9998
(800)275-8777

12/30/2021 10:35 AM

Product	Qty	Unit Price	Price
---------	-----	------------	-------

First-Class Mail® Large Envelope	1		\$2.56
-------------------------------------	---	--	--------

Florence, AZ 85132
Weight: 0 lb 7.20 oz
Estimated Delivery Date
Mon 01/03/2022

Registered Mail®			\$14.35
------------------	--	--	---------

Amount: \$21.00
Tracking #:
RE322390840US

Return Receipt			\$3.05
----------------	--	--	--------

Tracking #:
9590 9402 4718 8344 9618 32

Total			\$19.96
-------	--	--	---------

First-Class Mail® Letter	1		\$0.78
-----------------------------	---	--	--------

Globe, AZ 85501
Weight: 0 lb 1.40 oz

Registered Mail®			\$14.35
------------------	--	--	---------

Amount: \$21.00
Tracking #:
RE322398358US

Return Receipt			\$3.05
----------------	--	--	--------

Tracking #:
9590 9402 4718 8344 9594 19

Total			\$18.18
-------	--	--	---------

Grand Total:			\$38.14
--------------	--	--	---------

Cash			\$50.00
------	--	--	---------

Change			-\$11.86
--------	--	--	----------

Registered No.
RE322398358US

Date Stamp

0130

24

Reg. Fee	\$0.78	
Handling Charge	\$14.35	Return Receipt
Postage	\$3.05	Restricted Delivery
	\$0.00	
Received by	\$0.00	\$18.18

To Be Completed By Post Office

Customer Must Declare Full Value \$21.00
Domestic Insurance up to \$25,000 is included on the declared value. International delivery is limited. (See Reverse)

OFFICIAL USE

To Be Completed By Customer (Please Print) All Entries Must Be In Ballpoint or Typed	FROM	APACHE JUNCTION, AZ 85120 Darrell James Hill, Executor Barely Jean Romero Hill, Executor P.O. Box 3806 Apache Junction Arizona (85117)
	TO	Sadie Jo Bingham - Trustee Gila County Recorder office 1400 East Ash Ave Globe Arizona (85501)

PS Form 3806, Receipt for Registered Mail - Copy - Customer
May 2007 (7530-02-000-9051)
For domestic delivery information, visit our website at www.usps.com®

Unofficial



Delivered, Left with Individual
GLOBE, AZ 85501

Your item was delivered to an individual at the address at 8:05 am on
December 31, 2021 in GLOBE, AZ 85501.

December 31, 2021, 8:05 am
Arrived at Post Office
GLOBE, AZ 85501

December 30, 2021, 10:18 pm
Departed USPS Facility
PHOENIX, AZ 85026

December 30, 2021, 10:17 pm
Arrived at USPS Facility
PHOENIX, AZ 85026

December 30, 2021, 4:41 pm
Departed Post Office
APACHE JUNCTION, AZ 85120

December 30, 2021, 10:31 am
USPS in possession of item
APACHE JUNCTION, AZ 85120

Feedback

2087
2022-011769 MISC Page: 2096 of 2782
09/26/2022 03:35:37 PM Receipt #: 22-9381
Rec Fee: \$30.00 Darrell James Hill
Gila County, Az, Sadie Jo Bingham, Recorder



USPS Tracking®

[FAQs >](#)

[Track Another Package +](#)

Tracking Number: RE322398358US

[Remove X](#)

Your item was delivered to an individual at the address at 8:05 am on December 31, 2021 in GLOBE, AZ 85501.

Feedback

Delivered, Left with Individual

December 31, 2021 at 8:05 am
GLOBE, AZ 85501

Get Updates

Text & Email Updates

Tracking History

December 31, 2021, 8:05 am

2022-011769 MISC Page: 2097 of 2782
09/26/2022 03:35:37 PM Receipt #: 22-9381
Rec Fee: \$30.00 Darrell James Hill
Gila County, Az, Sadie Jo Bingham, Recorder



Handwritten: 2688

US Laws, Statutes, etc.

UNITED STATES
STATUTES AT LARGE

CONTAINING

Title 10 and Title 32,
United States Code

*Enacted During the Second Session of the
Eighty-Fourth Congress
of the United States of America*

1956



VOLUME 70A

IN ONE PART

2089
AUTHENTICATED
U.S. GOVERNMENT
INFORMATION
GPO

2022-011769 MISC Page: 2098 of 2782
09/26/2022 03:35:37 PM Receipt #: 22-9381
Rec Fee: \$30.00 Darrell James Hill
Gila County, Az, Sadie Jo Bingham, Recorder



KF50
U.S.
COPY 106
V01.70A

PUBLISHED BY AUTHORITY OF LAW UNDER THE DIRECTION OF THE
ADMINISTRATOR OF GENERAL SERVICES BY THE FEDERAL REGISTER
DIVISION, NATIONAL ARCHIVES AND RECORDS SERVICE

4 NOV 1.
Copy 106 1956

UNITED STATES
GOVERNMENT PRINTING OFFICE
WASHINGTON : 1956

For sale by the
Superintendent of Documents
U. S. Government Printing Office, Washington 25, D. C.
Price \$5.50 (Buckram)

2090

2022-011769 MISC Page: 2099 of 2782
09/26/2022 03:35:37 PM Receipt #: 22-9381
Rec Fee: \$30.00 Darrell James Hill
Gila County, Az, Sadie Jo Bingham, Recorder



TABLE OF CONTENTS

TITLE 10—ARMED FORCES

SUBTITLE	Page
A. GENERAL MILITARY LAW.....	2
B. ARMY.....	158
C. NAVY AND MARINE CORPS.....	275
D. AIR FORCE.....	488

SUBTITLE A—GENERAL MILITARY LAW

PART I. ORGANIZATION AND GENERAL MILITARY POWERS

CHAP.	Page
1. DEFINITIONS.....	3
3. GENERAL POWERS.....	6
5. JOINT CHIEFS OF STAFF.....	6
7. BOARDS, COUNCILS, AND COMMITTEES.....	8
9. REGULAR COMPONENTS. [No present sections]	
11. RESERVE COMPONENTS.....	10
13. THE MILITIA.....	14
15. INSURRECTION.....	15
17. ARMING OF AMERICAN VESSELS.....	16

PART II. PERSONNEL

CHAP.	Page
31. ENLISTMENTS.....	17
33. APPOINTMENTS IN REGULAR COMPONENTS.....	19
35. APPOINTMENTS AS RESERVE OFFICERS.....	24
37. SERVICE REQUIREMENTS FOR RESERVES.....	27
39. ACTIVE DUTY.....	27
41. SPECIAL APPOINTMENTS, ASSIGNMENTS, DETAILS, AND DUTIES.....	32
43. RANK AND COMMAND.....	33
45. THE UNIFORM.....	34
47. UNIFORM CODE OF MILITARY JUSTICE.....	38
49. MISCELLANEOUS PROHIBITIONS AND PENALTIES. [No present sections]	
51. RETENTION OF RESERVES.....	79
53. MISCELLANEOUS RIGHTS AND BENEFITS.....	80
55. VOTING BY MEMBERS OF ARMED FORCES.....	81
57. DECORATIONS AND AWARDS.....	88
59. SEPARATION.....	89
61. RETIREMENT OR SEPARATION FOR PHYSICAL DISABILITY.....	91
63. RETIREMENT FOR AGE.....	100
65. RETIREMENT FOR LENGTH OF SERVICE.....	101
67. RETIRED PAY FOR NON-REGULAR SERVICE.....	102
69. RETIRED GRADE.....	104
71. COMPUTATION OF RETIRED PAY.....	106
73. ANNUITIES BASED ON RETIRED OR RETAINER PAY.....	108
75. DEATH BENEFITS: CARE OF THE DEAD.....	112
77. POSTHUMOUS COMMISSIONS AND WARRANTS.....	115
79. CORRECTION OF MILITARY RECORDS.....	116
81. CIVILIAN EMPLOYEES.....	117

(iii)

2022-011769 MISC Page: 2100 of 2782

09/26/2022 03:35:37 PM Receipt #: 22-9381
 Rec Fee: \$30.00 Darrell James Hill

Gila County, Az, Sadie Jo Bingham, Recorder



COPY

2021

IV

PART III. TRAINING

CHAP.		Page
101.	TRAINING GENERALLY.....	110

PART IV. SERVICE, SUPPLY, AND PROCUREMENT

CHAP.		Page
131.	PLANNING AND COORDINATION.....	119
133.	FACILITIES FOR RESERVE COMPONENTS.....	120
135.	ENCOURAGEMENT OF AVIATION.....	123
137.	PROCUREMENT GENERALLY.....	127
139.	RESEARCH AND DEVELOPMENT.....	133
141.	MISCELLANEOUS PROCUREMENT PROVISIONS.....	135
143.	PRODUCTION BY MILITARY AGENCIES.....	138
145.	CATALOGING AND STANDARDIZATION.....	138
147.	UTILITIES AND SERVICES.....	141
149.	ISSUE TO ARMED FORCES.....	141
151.	ISSUE OF SERVICEABLE MATERIAL OTHER THAN TO ARMED FORCES.....	142
153.	EXCHANGE OF MATERIAL AND DISPOSAL OF OBSOLETE, SURPLUS, OR UNCLAIMED PROPERTY.....	143
155.	ACCEPTANCE OF GIFTS AND SERVICES.....	144
157.	TRANSPORTATION.....	146
159.	REAL PROPERTY; RELATED PERSONAL PROPERTY; AND LEASE OF NON-EXCESS PROPERTY.....	147
161.	PROPERTY RECORDS.....	152
163.	MILITARY CLAIMS.....	152
165.	ACCOUNTABILITY AND RESPONSIBILITY.....	155

PART I. ORGANIZATION AND GENERAL MILITARY POWERS

CHAPTER 1.—DEFINITIONS

Sec.		
101.	Definitions.....	3

CHAPTER 3.—GENERAL POWERS

Sec.		
121.	Regulations.....	6

CHAPTER 5.—JOINT CHIEFS OF STAFF

Sec.		
141.	Composition; functions.....	6
142.	Chairman.....	7
143.	Joint Staff.....	7

CHAPTER 7.—BOARDS, COUNCILS, AND COMMITTEES

Sec.		
171.	Armed Forces Policy Council.....	8
172.	Ammunition storage board.....	8
173.	Advisory personnel.....	8
174.	Advisory personnel: research and development.....	9
175.	Reserve Forces Policy Board.....	9

CHAPTER 9.—REGULAR COMPONENTS

[No present sections]

Unofficial
2092



CHAPTER 11.—RESERVE COMPONENTS

Sec.	Page
261. Reserve components named.....	10
262. Purpose.....	10
263. Basic policy for order into Federal service.....	11
264. Reserve affairs: responsibility for.....	11
265. Policies and regulations: participation of reserve officers in preparation and administration.....	11
266. Boards for appointment, promotion, and certain other purposes: composition.....	11
267. Ready Reserve; Standby Reserve; Retired Reserve: placement and status of members.....	12
268. Ready Reserve.....	12
269. Ready Reserve: placement in; transfer from.....	12
273. Standby Reserve: composition; inactive-status list.....	13
274. Retired Reserve.....	13
275. Personnel records.....	13
276. Mobilization forces: maintenance.....	13
277. Regular and reserve components: discrimination prohibited.....	14
278. Dissemination of information.....	14
280. Regulations.....	14

CHAPTER 13.—THE MILITIA

Sec.	Page
311. Militia: composition and classes.....	14
312. Militia duty: exemptions.....	15

CHAPTER 16.—INSURRECTION

Sec.	Page
331. Federal aid for State governments.....	15
332. Use of militia and armed forces to enforce Federal authority.....	15
333. Interference with State and Federal law.....	15
334. Proclamation to disperse.....	16

CHAPTER 17.—ARMING OF AMERICAN VESSELS

Sec.	Page
351. During war or threat to national security.....	16

PART II.—PERSONNEL

CHAPTER 31.—ENLISTMENTS

Sec.	Page
501. Enlistment oath: who may administer.....	17
510. Reserve components: qualifications.....	17
511. Reserve components: terms.....	18
512. Reserve components: transfers.....	18
513. Reserve components: promotions.....	18
514. Bounties prohibited; substitutes prohibited.....	19
515. Reenlistment after discharge as warrant officer.....	19

CHAPTER 33.—APPOINTMENTS IN REGULAR COMPONENTS

Sec.	Page
541. Graduates of the United States Military, Naval, and Air Force Academies.....	19
553. Warrant officers: grades.....	20
556. Warrant officers: original appointment; service credit.....	20
557. Warrant officers: promotion; qualifications.....	20
558. Warrant officers: promotion; selection boards.....	20
559. Warrant officers: eligibility for promotion.....	21
560. Warrant officers: promotion; selection procedure.....	21
561. Warrant officers: effect of failure of selection for promotion.....	22
562. Warrant officers: disapproval of promotion by Secretary concerned, President, or Senate.....	22
563. Warrant officers: promotion; effective date.....	22
564. Warrant officers: effect of second failure of promotion.....	22
565. Warrant officers: suspension of laws for promotion or mandatory retirement or separation during war or emergency.....	24



2023

Copy

**TITLE 10 AND TITLE 32,
UNITED STATES CODE**

Unofficial Copy

2094

2022-011769 MISC Page: 2103 of 2782
09/26/2022 03:35:37 PM Receipt #: 22-9381
Rec Fee: \$30.00 Darrell James Hill
Gila County, Az, Sadie Jo Bingham, Recorder



PUBLIC LAW 1028 - 84TH CONGRESS
CHAPTER 1041 - 2D SESSION
APPROVED AUGUST 10, 1956
H. R. 7049

Title 10 and Title 32, United States Code

ENACTED DURING THE
SECOND SESSION OF THE EIGHTY-FOURTH CONGRESS
OF THE UNITED STATES OF AMERICA

*Began and held at the City of Washington on
Tuesday, January 3, 1956*

An Act

To revise, codify, and enact into law, title 10 of the United States Code, entitled "Armed Forces", and title 32 of the United States Code, entitled "National Guard".

Be it enacted, by the Senate and House of Representatives of the United States of America in Congress assembled, That title 10 of the United States Code, entitled "Armed Forces", is revised, codified, and enacted into law, and may be cited as "Title 10, United States Code, §—", as follows:

TITLE 10—ARMED FORCES

SUBTITLE	Sec.
A. GENERAL MILITARY LAW.....	101
B. ARMY.....	3001
C. NAVY AND MARINE CORPS.....	5001
D. AIR FORCE.....	8001

1

2095

2022-011769 MISC Page: 2104 of 2782
09/26/2022 03:35:37 PM Receipt #: 22-9381
Rec Fee: \$30.00 Darrell James Hill
Gila County, Az, Sadie Jo Bingham, Recorder



Subtitle A—General Military Law

PART I. ORGANIZATION AND GENERAL MILITARY POWERS

CHAP.		Sec.
1.	Definitions	101
3.	General Powers	121
5.	Joint Chiefs of Staff	141
7.	Boards, Councils, and Committees	171
9.	Regular Components. [No present sections]	
11.	Reserve Components	261
13.	The Militia	311
15.	Insurrection	331
17.	Arming of American Vessels	351

PART II. PERSONNEL

CHAP.		Sec.
31.	Enlistments	501
33.	Appointments in Regular Components	541
35.	Appointments as Reserve Officers	591
37.	Service Requirements for Reserves	651
39.	Active Duty	671
41.	Special Appointments, Assignments, Details, and Duties	711
43.	Rank and Command	741
45.	The Uniform	771
47.	Uniform Code of Military Justice	801
49.	Miscellaneous Prohibitions and Penalties. [No present sections]	
51.	Retention of Reserves	1001
53.	Miscellaneous Rights and Benefits	1031
55.	Voting by Members of Armed Forces	1071
57.	Decorations and Awards	1121
59.	Separation	1161
61.	Retirement or Separation for Physical Disability	1201
63.	Retirement for Age	1255
65.	Retirement for Length of Service	1293
67.	Retired Pay for Non-Regular Service	1331
69.	Retired Grade	1371
71.	Computation of Retired Pay	1401
73.	Annuities Based on Retired or Retainer Pay	1431
75.	Death Benefits: Care of the Dead	1481
77.	Posthumous Commissions and Warrants	1521
79.	Correction of Military Records	1551
81.	Civilian Employees	1581
+		

2096

2022-011769 MISC Page: 2105 of 2782

09/26/2022 03:35:37 PM Receipt #: 22-9381

Rec Fee: \$30.00 Darrell James Hill

Gila County, Az, Sadie Jo Bingham, Recorder



PART III. TRAINING

101. Training Generally..... 2001

PART IV. SERVICE, SUPPLY, AND PROCUREMENT

131. Planning and Coordination..... 2201
133. Facilities for Reserve Components..... 2231
135. Encouragement of Aviation..... 2271
137. Procurement Generally..... 2301
139. Research and Development..... 2351
141. Miscellaneous Procurement Provisions..... 2381
143. Production by Military Agencies..... 2421
145. Cataloging and Standardization..... 2451
147. Utilities and Services..... 2481
149. Issue to Armed Forces..... 2511
151. Issue of Serviceable Material Other Than to Armed Forces..... 2541
153. Exchange of Material and Disposal of Obsolete, Surplus, or Unclaimed Property..... 2571
155. Acceptance of Gifts and Services..... 2601
157. Transportation..... 2631
159. Real Property; Related Personal Property; and Lease of Non-Excess Property..... 2661
161. Property Records..... 2701
163. Military Claims..... 2731
165. Accountability and Responsibility..... 2771

PART I. ORGANIZATION AND GENERAL MILITARY POWERS

1. Definitions..... 101
3. General Powers..... 121
5. Joint Chiefs of Staff..... 141
7. Boards, Councils, and Committees..... 171
9. Regular Components. [No present sections]
11. Reserve Components..... 201
13. The Militia..... 311
15. Insurrection..... 331
17. Arming of American Vessels..... 351

CHAPTER 1.—DEFINITIONS

Sec.

101. Definitions.

§ 101. Definitions

In addition to the definitions in sections 1-5 of title 1, the following definitions apply in this title:

- (1) "United States", in a geographic sense, means the States and the District of Columbia.
(2) "Territory" means Alaska, Hawaii, or any Territory organized after this title is enacted, so long as it remains a Territory.
(3) "Possessions" includes the Virgin Islands, the Canal Zone, Guam, American Samoa, and the guano islands, so long as they remain possessions, but does not include any Territory or Commonwealth.
(4) "Armed forces" means the Army, Navy, Air Force, Marine Corps, and Coast Guard.
(5) "Department", when used with respect to a military department, means the executive part of the department and all

UN 2097

2022-011769 MISC Page: 2106 of 2782
09/26/2022 03:35:37 PM Receipt #: 22-9381
Rec Fee: \$30.00 Darrell James Hill
Gila County, Az, Sadie Jo Bingham, Recorder



field headquarters, forces, reserve components, installations, activities, and functions under the control or supervision of the Secretary of the department. When used with respect to the Department of Defense, it means the executive part of the department, including the executive parts of the military departments, and all field headquarters, forces, reserve components, installations, activities, and functions under the control or supervision of the Secretary of Defense, including those of the military departments.

(6) "Executive part of the department" means the executive part of the Department of Defense, Department of the Army, Department of the Navy, or Department of the Air Force, as the case may be, at the seat of government.

(7) "Military departments" means the Department of the Army, the Department of the Navy, and the Department of the Air Force.

(8) "Secretary concerned" means—

(A) the Secretary of the Army, with respect to matters concerning the Army;

(B) the Secretary of the Navy, with respect to matters concerning the Navy, the Marine Corps, and the Coast Guard when it is operating as a service in the Navy;

(C) the Secretary of the Air Force, with respect to matters concerning the Air Force; and

(D) the Secretary of the Treasury, with respect to matters concerning the Coast Guard when it is not operating as a service in the Navy.

(9) "National Guard" means the Army National Guard and the Air National Guard.

(10) "Army National Guard" means that part of the organized militia of the several States and Territories, Puerto Rico, the Canal Zone, and the District of Columbia, active and inactive, that—

(A) is a land force;

(B) is trained, and has its officers appointed, under the sixteenth clause of section 8, article I, of the Constitution;

(C) is organized, armed, and equipped wholly or partly at Federal expense; and

(D) is federally recognized.

(11) "Army National Guard of the United States" means the reserve component of the Army all of whose members are members of the Army National Guard.

(12) "Air National Guard" means that part of the organized militia of the several States and Territories, Puerto Rico, the Canal Zone, and the District of Columbia, active and inactive, that—

(A) is an air force;

(B) is trained, and has its officers appointed, under the sixteenth clause of section 8, article I, of the Constitution;

(C) is organized, armed, and equipped wholly or partly at Federal expense; and

(D) is federally recognized.

2022-011769 MISC Page: 2107 of 2782

09/26/2022 03:35:37 PM Receipt #: 22-9381

Rec Fee: \$30.00 Darrell James Hill

Gila County, Az, Sadie Jo Bingham, Recorder



2098

(13) "Air National Guard of the United States" means the reserve component of the Air Force all of whose members are members of the Air National Guard.

(14) "Officer" means commissioned or warrant officer.

(15) "Commissioned officer" includes a commissioned warrant officer.

(16) "Warrant officer" means a person who holds a commission or warrant in a warrant officer grade.

(17) "Enlisted member" means a person in an enlisted grade.

(18) "Grade" means a step or degree, in a graduated scale of office or military rank, that is established and designated as a grade by law or regulation.

(19) "Rank" means the order of precedence among members of the armed forces.

(20) "Rating" means the name (such as "boatswain's mate") prescribed for members of an armed force in an occupational field. "Rate" means the name (such as "chief boatswain's mate") prescribed for members in the same rating or other category who are in the same grade (such as chief petty officer or seaman apprentice).

(21) "Authorized strength" means the largest number of members authorized to be in an armed force, a component, a branch, a grade, or any other category of the armed forces.

(22) "Active duty" means full-time duty in the active military service of the United States. It includes duty on the active list, full-time training duty, annual training duty, and attendance, while in the active military service, at a school designated as a service school by law or by the Secretary of the military department concerned.

(23) "Active duty for a period of more than 30 days" means active duty under a call or order that does not specify a period of 30 days or less.

(24) "Active service" means service on active duty.

(25) "Supplies" includes material, equipment, and stores of all kinds.

(26) "Pay" includes basic pay, special pay, retainer pay, incentive pay, retired pay, and equivalent pay, but does not include allowances.

(28) "Shall" is used in an imperative sense.

(29) "May" is used in a permissive sense. The words "no person may . . ." mean that no person is required, authorized, or permitted to do the act prescribed.

(30) "Includes" means "includes but is not limited to".

(31) "Inactive-duty training" means—

(A) duty prescribed for Reserves by the Secretary concerned under section 301 of title 37 or any other provision of law; and

(B) special additional duties authorized for Reserves by an authority designated by the Secretary concerned and performed by them on a voluntary basis in connection with the prescribed training or maintenance activities of the units to which they are assigned.

It includes those duties when performed by Reserves in their status as members of the National Guard.

2022-011769 MISC Page: 2108 of 2782

09/26/2022 03:35:37 PM Receipt #: 22-9381

Rec Fee: \$30.00 Darrell James Hill

Gila County, Az, Sadie Jo Bingham, Recorder



2099

- (32) "Spouse" means husband or wife, as the case may be.
 (33) "Regular", with respect to an enlistment, appointment, grade, or office, means enlistment, appointment, grade, or office in a regular component of an armed force.
 (34) "Reserve", with respect to an enlistment, appointment, grade, or office, means enlistment, appointment, grade, or office held as a Reserve of an armed force.

CHAPTER 3.—GENERAL POWERS

Sec.
 121. Regulations.

§ 121. Regulations

The President may prescribe regulations to carry out his functions, powers, and duties under this title.

CHAPTER 5.—JOINT CHIEFS OF STAFF

Sec.
 141. Composition; functions.
 142. Chairman.
 143. Joint Staff.

§ 141. Composition; functions

(a) There are in the Department of Defense the Joint Chiefs of Staff consisting of—

- (1) a Chairman, who has no vote;
- (2) the Chief of Staff of the Army;
- (3) the Chief of Naval Operations; and
- (4) the Chief of Staff of the Air Force.

(b) The Joint Chiefs of Staff are the principal military advisers to the President, the National Security Council, and the Secretary of Defense.

(c) The Commandant of the Marine Corps shall indicate to the Chairman any matter scheduled for consideration by the Joint Chiefs that directly concerns the Marine Corps. Unless, upon request of the Chairman for a determination, the Secretary of Defense determines that such a matter does not concern the Marine Corps, the Commandant shall meet with the Joint Chiefs of Staff when that matter is under consideration. While the matter is under consideration and with respect to it, the Commandant has co-equal status with the members of the Joint Chiefs of Staff.

(d) Subject to the authority and direction of the President and the Secretary of Defense, the Joint Chiefs of Staff shall—

- (1) prepare strategic plans and provide for the strategic direction of the armed forces;
- (2) prepare joint logistic plans and assign logistic responsibilities to the armed forces in accordance with those plans;
- (3) establish unified commands in strategic areas;
- (4) review the major material and personnel requirements of the armed forces in accordance with strategic and logistic plans;
- (5) formulate policies for the joint training of the armed forces;

2022-011769 MISC Page: 2109 of 2782
 09/26/2022 03:35:37 PM Receipt #: 22-9381
 Rec Fee: \$30.00 Darrell James Hill
 Gila County, Az. Sadie Jo Bingham, Recorder



- (6) formulate policies for coordinating the military education of members of the armed forces;
- (7) provide for representation of the United States on the Military Staff Committee of the United Nations in accordance with the Charter of the United Nations; and
- (8) perform such other duties as the President or the Secretary of Defense may prescribe.

§ 142. Chairman

(a) The Chairman of the Joint Chiefs of Staff shall be appointed by the President, by and with the advice and consent of the Senate, from the officers of the regular components of the armed forces. He serves at the pleasure of the President for a term of two years, and may be reappointed in the same manner for one additional term. However, in time of war declared by Congress there is no limit on the number of reappointments.

(b) In addition to his other duties as a member of the Joint Chiefs of Staff, the Chairman shall, subject to the authority and direction of the President and the Secretary of Defense—

- (1) preside over the Joint Chiefs of Staff;
- (2) provide agenda for the meetings of the Joint Chiefs of Staff and assist them in carrying on their business as promptly as practicable; and
- (3) inform the Secretary of Defense, and, when the President or the Secretary of Defense considers it appropriate, the President, of those issues upon which the Joint Chiefs of Staff have not agreed.

(c) While holding office, the Chairman outranks all other officers of the armed forces. However, he may not exercise military command over the Joint Chiefs of Staff or any of the armed forces.

(d) The Chairman is entitled to the pay and allowances provided by law for the Chief of Staff of the Army.

§ 143. Joint Staff

(a) There is under the Joint Chiefs of Staff a Joint Staff consisting of not more than 210 officers selected by the Joint Chiefs of Staff with the approval of the Chairman. The Joint Staff shall be selected in approximately equal numbers from—

- (1) the Army;
- (2) the Navy and the Marine Corps; and
- (3) the Air Force.

The tenure of the members of the Joint Staff is subject to the approval of the Chairman of the Joint Chiefs of Staff.

(b) The Joint Chiefs of Staff, with the approval of the Secretary of Defense, shall select the Director of the Joint Staff. The tenure of the Director is subject to the Secretary's approval. The Director must be an officer junior in grade to each member of the Joint Chiefs of Staff.

(c) The Joint Staff, operating under the Director, shall perform such duties as the Joint Chiefs of Staff direct. The Chairman of the Joint Chiefs of Staff manages the Joint Staff and its director.



2101

CHAPTER 7.—BOARDS, COUNCILS, AND COMMITTEES

Sec.

171. Armed Forces Policy Council.
 172. Ammunition storage board.
 173. Advisory personnel.
 174. Advisory personnel: research and development.
 175. Reserve Forces Policy Board.

§ 171. Armed Forces Policy Council

(a) There is in the Department of Defense an Armed Forces Policy Council consisting of—

- (1) the Secretary of Defense, as Chairman, with the power of decision;
- (2) the Deputy Secretary of Defense;
- (3) the Secretary of the Army;
- (4) the Secretary of the Navy;
- (5) the Secretary of the Air Force;
- (6) the Chairman of the Joint Chiefs of Staff;
- (7) the Chief of Staff of the Army;
- (8) the Chief of Naval Operations; and
- (9) the Chief of Staff of the Air Force.

(b) The Armed Forces Policy Council shall advise the Secretary of Defense on matters of broad policy relating to the armed forces and shall consider and report on such other matters as the Secretary of Defense may direct.

§ 172. Ammunition storage board

(a) The Secretaries of the military departments, acting through a joint board of officers selected by them, shall keep informed on stored supplies of ammunition and components thereof for use of the Army, Navy, Air Force, and Marine Corps, with particular regard to keeping those supplies properly dispersed and stored and to preventing hazardous conditions from arising to endanger life and property inside or outside of storage reservations.

(b) The board shall confer with and advise the Secretaries of the military departments in carrying out the recommendations in House Document No. 199 of the Seventieth Congress.

§ 173. Advisory personnel

(a) The Secretary of Defense may establish such advisory committees and employ such part-time advisers as he considers necessary for the performance of his functions and those of the agencies under his control.

(b) A person who serves as a member of a committee may not be paid for that service while holding another position or office under the United States for which he receives compensation. Other members and part-time advisers may serve without compensation or may be paid not more than \$50 for each day of service, as the Secretary determines.

(c) Sections 281, 283, and 284 of title 18 do not apply to a person because of his service on a committee, or as a part-time adviser, under subsection (a), unless he performs an act which is unlawful under one of those sections and which relates to a matter directly involving a

2022-011769 MISC Page: 2111 of 2782
 09/26/2022 03:35:37 PM Receipt #: 22-9381
 Rec Fee: \$30.00 Darrell James Hill
 Gila County, Az, Sadie Jo Bingham, Recorder



2102

department or agency which he is advising or to a matter in which that department or agency is directly interested.

§ 174. Advisory personnel: research and development

(a) The Secretary of each military department may establish such advisory committees and panels as are necessary for the research and development activities of his department and may employ such part-time advisers as he considers necessary to carry out those activities.

(b) A person who serves as a member of such a committee or panel may not be paid for that service while holding another position or office under the United States for which he receives compensation. Other members and part-time advisers may serve without compensation or may be paid not more than \$50 for each day of service, as the Secretary concerned determines.

(c) The Secretary concerned may delegate any authority under this section to—

- (1) the Under Secretary of his department;
- (2) an Assistant Secretary of his department; or
- (3) the chief, and one assistant to the chief, of any technical service, bureau, or office.

§ 175. Reserve Forces Policy Board.

(a) There is in the Office of the Secretary of Defense a Reserve Forces Policy Board consisting of—

- (1) a civilian chairman appointed by the Secretary of Defense;
- (2) the Secretary, the Under Secretary, or an Assistant Secretary designated under section 264 (b) of this title, of each of the military departments;
- (3) an officer of the Regular Army designated by the Secretary of the Army;
- (4) an officer of the Regular Navy or Regular Marine Corps designated by the Secretary of the Navy;
- (5) an officer of the Regular Air Force designated by the Secretary of the Air Force;
- (6) four reserve officers designated by the Secretary of Defense upon the recommendation of the Secretary of the Army, two of whom must be members of the Army National Guard of the United States, and two of whom must be members of the Army Reserve;
- (7) four reserve officers designated by the Secretary of Defense upon the recommendation of the Secretary of the Navy, two of whom must be members of the Naval Reserve, and two of whom must be members of the Marine Corps Reserve;
- (8) four reserve officers designated by the Secretary of Defense upon the recommendation of the Secretary of the Air Force, two of whom must be members of the Air National Guard of the United States, and two of whom must be members of the Air Force Reserve; and
- (9) a reserve officer of the Army, Navy, Air Force, or Marine Corps who is a general officer or flag officer designated by the Chairman of the Board with the approval of the Secretary of Defense, and who serves without vote as military adviser to the Chairman and as executive officer of the Board.



2103

(b) Whenever the Coast Guard is not operating as a service in the Navy, the Secretary of the Treasury may designate an officer of the Regular Coast Guard or the Coast Guard Reserve to serve without vote as a member of the Board.

(c) The Board, acting through the Assistant Secretary of Defense designated under section 264 (a) of this title, is the principal policy adviser to the Secretary of Defense on matters relating to the reserve components.

(d) This section does not affect the committees on reserve policies prescribed by section 3033 or 8033 of this title.

(e) A member of a committee under section 3033 or 8033 of this title may, if otherwise eligible, be a member of the Reserve Forces Policy Board.

CHAPTER 9.—REGULAR COMPONENTS

[No present sections]

CHAPTER 11.—RESERVE COMPONENTS

Sec.

- 261. Reserve components named.
- 262. Purpose.
- 263. Basic policy for order into Federal service.
- 264. Reserve affairs: responsibility for.
- 265. Policies and regulations: participation of reserve officers in preparation and administration.
- 266. Boards for appointment, promotion, and certain other purposes: composition.
- 267. Ready Reserve; Standby Reserve; Retired Reserve: placement and status of members.
- 268. Ready Reserve.
- 269. Ready Reserve: placement in; transfer from.
- 273. Standby Reserve: composition; inactive-status list.
- 274. Retired Reserve.
- 275. Personnel records.
- 276. Mobilization forces: maintenance.
- 277. Regular and reserve components: discrimination prohibited.
- 278. Dissemination of information.
- 280. Regulations.

§ 261. Reserve components named

- (a) The reserve components of the armed forces are:
- (1) The Army National Guard of the United States.
 - (2) The Army Reserve.
 - (3) The Naval Reserve.
 - (4) The Marine Corps Reserve.
 - (5) The Air National Guard of the United States.
 - (6) The Air Force Reserve.
 - (7) The Coast Guard Reserve.

(b) Except as otherwise provided in this title, no person may be a member of more than one reserve component at the same time.

§ 262. Purpose

The purpose of the reserve components is to provide trained units and qualified persons available for active duty in the armed forces, in time of war or national emergency and at such other times as the national security requires, to fill the needs of the armed forces whenever, during, and after the period needed to procure and train additional units and qualified persons to achieve the planned mobiliza-

2104

2022-011769 MISC Page: 2113 of 2782
 09/26/2022 03:35:37 PM Receipt #: 22-9381
 Rec Fee: \$30.00 Darrell James Hill
 Gila County, Az, Sadie Jo Bingham, Recorder



tion, more units and persons are needed than are in the regular components.

§ 263. Basic policy for order into Federal service

Whenever Congress determines that more units and organizations are needed for the national security than are in the regular components of the ground and air forces, the Army National Guard of the United States and the Air National Guard of the United States, or such parts of them as are needed, together with units of other reserve components necessary for a balanced force, shall be ordered to active duty and retained as long as so needed.

§ 264. Reserve affairs: responsibility for

(a) The Secretary of Defense shall designate an Assistant Secretary of Defense to have, in addition to his other duties, principal responsibility for reserve affairs of the Department of Defense.

(b) In addition to his other duties, the Secretary concerned, or, as he may prescribe, the Under Secretary or an Assistant Secretary of his department, has the principal responsibility for supervising the activities of the reserve components under that department.

(c) The Secretary concerned shall designate a general or flag officer of each armed force under his jurisdiction to be directly responsible for reserve affairs to the Chief of Staff of the Army, the Chief of Naval Operations, the Chief of Staff of the Air Force, the Commandant of the Marine Corps, and the Commandant of the Coast Guard, as the case may be. This subsection does not affect the functions of the Chief of the National Guard Bureau.

§ 265. Policies and regulations: participation of reserve officers in preparation and administration

Within such numbers and in such grades and assignments as the Secretary concerned may prescribe, each armed force shall have officers of its reserve components on active duty (other than for training) at the seat of government, and at headquarters responsible for reserve affairs, to participate in preparing and administering the policies and regulations affecting those reserve components. While so serving, such an officer is an additional number of any staff with which he is serving.

§ 266. Boards for appointment, promotion, and certain other purposes: composition

(a) Each board convened for the appointment, promotion, demotion, involuntary release from active duty, discharge, or retirement of Reserves shall include an appropriate number of Reserves, as prescribed by the Secretary concerned under standards and policies prescribed by the Secretary of Defense.

(b) Each member of a board convened for the selection for promotion, or for the demotion or discharge, of Reserves must be senior in rank to the persons under consideration by that board. However, a member serving in a legal advisory capacity may be junior in rank to any person, other than a judge advocate or law specialist, being considered by that board; and a member serving in a medical advisory capacity may be junior in rank to any person, other than a medical officer, being considered by that board.

2022-011769 MISC Page: 2114 of 2782
 09/26/2022 03:35:37 PM Receipt #: 22-9381
 Rec Fee: \$30.00 Darrell James Hill
 Gila County, Az, Sadie Jo Bingham, Recorder



2105

§ 267. Ready Reserve; Standby Reserve; Retired Reserve: placement and status of members

(a) There are in each armed force a Ready Reserve, a Standby Reserve, and a Retired Reserve. Each Reserve shall be placed in one of those categories.

(b) Reserves who are on the inactive status list of a reserve component, or who are assigned to the inactive Army National Guard or the inactive Air National Guard, are in an inactive status. Members in the Retired Reserve are in a retired status. All other Reserves are in an active status.

§ 268. Ready Reserve

The Ready Reserve consists of units or Reserves, or both, liable for active duty as provided in sections 672 and 673 of this title. The authorized strength of the Ready Reserve is 1,500,000.

§ 269. Ready Reserve: placement in; transfer from

(a) Each person required under law to serve in a reserve component shall, upon becoming a member, be placed in the Ready Reserve of his armed force for his prescribed term of service, unless he is eligible to transfer to the Standby Reserve under subsection (e).

(b) The units and members of the Army National Guard of the United States and of the Air National Guard of the United States are in the Ready Reserve of the Army and the Ready Reserve of the Air Force, respectively.

(c) All Reserves assigned to units organized to serve as units and designated as units in the Ready Reserve are in the Ready Reserve.

(d) Under such regulations as the Secretary concerned may prescribe, any qualified Reserve may, upon his request, be placed in the Ready Reserve.

(e) Except in time of war or of national emergency declared by Congress, a Reserve who is not on active duty, or who is on active duty for training, shall, upon his request, be transferred to the Standby Reserve for the rest of his term of service, if—

(1) he served on active duty (other than for training) in the armed forces for an aggregate of at least five years;

(2) he served on active duty (other than for training) in the armed forces for an aggregate of less than five years, but satisfactorily participated, as determined by the Secretary concerned, in an accredited training program in the Ready Reserve for a period which, when added to his period of active duty (other than for training), totals at least five years, or such shorter period as the Secretary concerned, with the approval of the Secretary of Defense in the case of a Secretary of a military department, may prescribe for satisfactory participation in an accredited training program designated by the Secretary concerned;

(3) he served on active duty (other than for training) in the armed forces for an aggregate of at least 12 months after December 6, 1941, and before September 3, 1945, and for an aggregate of at least 12 months after June 25, 1950; or

(4) he was a member of one or more reserve components for an aggregate of at least eight years after September 2, 1945.

2106

2022-011769 MISC Page: 2115 of 2782

09/26/2022 03:35:37 PM Receipt #: 22-9381
 Rec Fee: \$30.00 Darrell James Hill
 Gila County, Az, Sadie Jo Bingham, Recorder



This subsection does not apply to a member of the Ready Reserve while he is serving under an agreement to remain in the Ready Reserve for a stated period.

(f) Subject to subsection (g), a member in the Ready Reserve may be transferred to the Standby Reserve or, if he is qualified and so requests, to the Retired Reserve, under such regulations as the Secretary concerned, with the approval of the Secretary of Defense in the case of a Secretary of a military department, may prescribe.

(g) A member of the Army National Guard of the United States or the Air National Guard of the United States may be transferred to the Standby Reserve only with the consent of the governor or other appropriate authority of the State or Territory, Puerto Rico, the Canal Zone, or the District of Columbia, whichever is concerned.

§ 273. Standby Reserve: composition; inactive status list

(a) The Standby Reserve consists of those units or members, or both, of the reserve components, other than those in the Ready Reserve or Retired Reserve, who are liable for active duty only as provided in sections 672 and 674 of this title.

(b) An inactive status list shall be maintained in the Standby Reserve. Whenever an authority designated by the Secretary concerned considers that it is in the best interest of the armed force concerned, a member in the Standby Reserve who is not required to remain a Reserve, and who cannot participate in prescribed training, may, if qualified, be transferred to the inactive status list under regulations to be prescribed by the Secretary concerned. These regulations shall fix the conditions under which such a member is entitled to be returned to an active status.

(c) While in an inactive status, a Reserve is not eligible for pay or promotion.

§ 274. Retired Reserve

The Retired Reserve consists of Reserves—

- (1) who have been transferred to it upon their request;
- (2) who retain their status as Reserves; and
- (3) who are otherwise qualified.

§ 275. Personnel records

Each armed force shall maintain adequate and current personnel records of each member of its reserve components showing—

- (1) his physical condition;
- (2) his dependency status;
- (3) his military qualifications;
- (4) his civilian occupational skills;
- (5) his availability for service; and
- (6) such other information as the Secretary concerned may prescribe.

§ 276. Mobilization forces: maintenance

(a) Whenever units or members of the reserve components are ordered to active duty (other than for training) during a period of partial mobilization, the Secretary concerned shall continue to maintain mobilization forces by planning and budgeting for the continued



2107

organization and training of the reserve components not mobilized, and make the fullest practicable use of the Federal facilities vacated by mobilized units, consistent with approved joint mobilization plans.

(b) In this section "partial mobilization" means the mobilization resulting from action by Congress or the President, under any law, to bring units of any reserve component, and members not assigned to units organized to serve as units, to active duty for a limited expansion of the active armed forces.

§ 277. Regular and reserve components: discrimination prohibited

Laws applying to both Regulars and Reserves shall be administered without discrimination—

- (1) among Regulars;
- (2) among Reserves; and
- (3) between Regulars and Reserves.

§ 278. Dissemination of information

The Secretary of Defense shall require the complete and current dissemination to all Reserves and to the public, of information of interest to the reserve components.

§ 280. Regulations

Subject to standards, policies, and procedures prescribed by the Secretary of Defense, the Secretary of each military department shall prescribe such regulations as he considers necessary to carry out chapters 11, 35, 39, and 59, and sections 715, 1003, 1004, 1032, 1376, 2001, 2511, 3077, 3079, 3221, 3224, 3259, 3260, 3261, 3351, 3352, 3353, 3495, 3498, 3685, 3686, 5251, 5252, 5456, 5597, 6150, 6327, 6483, 7225, 7226, 7854, 8077, 8079, 8221, 8224, 8259, 8260, 8261, 8351, 8352, 8353, 8495, 8498, 8685, and 8686 of this title. The Secretary of the Treasury, with the concurrence of the Secretary of the Navy, shall prescribe such regulations as he considers necessary to carry out chapters 11, 35, 39, and 59, and sections 513, 715, 742, 1003, 1004, 1032, 1376, 2001, and 2511 of this title, so far as they relate to the Coast Guard, except when the Coast Guard is operating as a service in the Navy. So far as practicable, regulations for all reserve components shall be uniform.

CHAPTER 13.—THE MILITIA

- Sec.
311. Militia: composition and classes.
312. Militia duty: exemptions.

§ 311. Militia: composition and classes

(a) The militia of the United States consists of all able-bodied males at least 17 years of age and, except as provided in section 313 of title 32, under 45 years of age who are, or who have made a declaration of intention to become, citizens of the United States.

(b) The classes of the militia are—

- (1) the organized militia, which consists of the National Guard and the Naval Militia; and
- (2) the unorganized militia, which consists of the members of the militia who are not members of the National Guard or the Naval Militia.



§ 312. Militia duty: exemptions

(a) The following persons are exempt from militia duty:

- (1) The Vice President.
- (2) The judicial and executive officers of the United States, the several States and Territories, Puerto Rico, and the Canal Zone.
- (3) Members of the armed forces, except members who are not on active duty.
- (4) Customhouse clerks.
- (5) Persons employed by the United States in the transmission of mail.
- (6) Workmen employed in armories, arsenals, and naval shipyards of the United States.
- (7) Pilots on navigable waters.
- (8) Mariners in the sea service of a citizen of, or a merchant in, the United States.

(b) A person who claims exemption because of religious belief is exempt from militia duty in a combatant capacity, if the conscientious holding of that belief is established under such regulations as the President may prescribe. However, such a person is not exempt from militia duty that the President determines to be noncombatant.

CHAPTER 15.—INSURRECTION

Sec.

331. Federal aid for State governments.
 332. Use of militia and armed forces to enforce Federal authority.
 333. Interference with State and Federal law.
 334. Proclamation to disperse.

§ 331. Federal aid for State governments

Whenever there is an insurrection in any State against its government, the President may, upon the request of its legislature or of its governor if the legislature cannot be convened, call into Federal service such of the militia of the other States, in the number requested by that State, and use such of the armed forces, as he considers necessary to suppress the insurrection.

§ 332. Use of militia and armed forces to enforce Federal authority

Whenever the President considers that unlawful obstructions, combinations, or assemblages, or rebellion against the authority of the United States, make it impracticable to enforce the laws of the United States in any State or Territory by the ordinary course of judicial proceedings, he may call into Federal service such of the militia of any State, and use such of the armed forces, as he considers necessary to enforce those laws or to suppress the rebellion.

§ 333. Interference with State and Federal law

The President, by using the militia or the armed forces, or both, or by any other means, shall take such measures as he considers necessary to suppress, in a State, any insurrection, domestic violence, unlawful combination, or conspiracy, if it—

- (1) so hinders the execution of the laws of that State, and of the United States within the State, that any part or class of its

2022-011769 MISC Page: 2118 of 2782
 09/26/2022 03:35:37 PM Receipt #: 22-9381
 Rec Fee: \$30.00 Darrell James Hill
 Gila County, Az, Sadie Jo Bingham, Recorder



2109

people is deprived of a right, privilege, immunity, or protection named in the Constitution and secured by law, and the constituted authorities of that State are unable, fail, or refuse to protect that right, privilege, or immunity, or to give that protection; or

(2) opposes or obstructs the execution of the laws of the United States or impedes the course of justice under those laws.

In any situation covered by clause (1), the State shall be considered to have denied the equal protection of the laws secured by the Constitution.

§ 334. Proclamation to disperse

Whenever the President considers it necessary to use the militia or the armed forces under this chapter, he shall, by proclamation, immediately order the insurgents to disperse and retire peaceably to their abodes within a limited time.

CHAPTER 17.—ARMING OF AMERICAN VESSELS

Sec.

351. During war or threat to national security.

§ 351. During war or threat to national security

(a) The President, through any agency of the Department of Defense designated by him, may arm, have armed, or allow to be armed, any watercraft or aircraft that is capable of being used as a means of transportation on, over, or under water, and is documented, registered, or licensed under the laws of the United States.

(b) This section applies during a war and at any other time when the President determines that the security of the United States is threatened by the application, or the imminent danger of application, of physical force by any foreign government or agency against the United States, its citizens, the property of its citizens, or their commercial interests.

(c) Section 463 of title 22 does not apply to vessels armed under this section.

PART II.—PERSONNEL

CHAP.	Sec.
31. Enlistments.....	501
33. Appointments in Regular Components.....	541
35. Appointments as Reserve Officers.....	591
37. Service Requirements for Reserves.....	651
39. Active Duty.....	671
41. Special Appointments, Assignments, Details, and Duties.....	711
43. Rank and Command.....	741
45. The Uniform.....	771
47. Uniform Code of Military Justice.....	801
49. Miscellaneous Prohibitions and Penalties. [No present sections]	
51. Retention of Reserves.....	1001
53. Miscellaneous Rights and Benefits.....	1031
55. Voting by Members of Armed Forces.....	1071
57. Decorations and Awards.....	1121
59. Separation.....	1161
61. Retirement or Separation for Physical Disability.....	1201
63. Retirement for Age.....	1255
65. Retirement for Length of Service.....	1293
67. Retired Pay for Non-Regular Service.....	1331
69. Retired Grade.....	1371

2110



Book[Holy Bible]

- [Full Record](#)¹
- [MARC Tags](#)

Uniform title

•

Main title

- [Holy Bible]

Published/Created

- [Philadelphia: Printed by Mathew Carey, No. 121 Chesnut street. 1814]

[Request this Item](#) [LC Find It opens in a new window](#) [Item Availability](#)

[Request this Item](#) [LC Find It opens in a new window](#) [Item Availability](#) [Top](#)

Links

Links

- <http://hdl.loc.gov/loc.gdc/scd0001.00141659017> opens in a new window

More Information

LCCN Permalink

- <https://lcn.loc.gov/unk82045005>

Description

- [814] p. 17 cm.

LC classification

- BS185 1814 .P52

Browse by shelf order

- [BS185 1814](#)

Additional formats

- Also available in digital form.

LCCN

- unk82045005

Type of material

- Book

Item Availability

CALL NUMBER

- Electronic Resource

Request in

- Online

¹ [Full Record](#) means: <https://catalog.loc.gov/vwebv/holdingsInfo?searchId=12456&recPointer=0&recCount=25&searchType=1&bibId=6734061>. Last accessed: January-6-2022-A.D.

2022-011769 MISC Page: 2120 of 2782

09/26/2022 03:35:37 PM Receipt #: 22-9381

Reg Fee: \$30.00 Darrell James Hill

Gila County, Az, Sadie Jo Bingham, Recorder



Gospel of the Good-news Scriptures

For all have sinned, and come short of the glory of God (KJV: Romans: 3.23);

As it is written,

"There is none righteous, no, not one:

There is none that understandeth, there is none that seeketh after God.

They are all gone out of the way, they are together become unprofitable; there is none that doeth good, no, not one (KJV: Romans: 3.10- 12);

For the wages of sin is death; but the gift of God is eternal life through Yeshua the Messiah (Jesus Christ) our Lord. (KJV: Romans: 6.23);

And almost all things are by the law purged with blood; and without shedding of blood is no remission (*of sin*). (KJV:);

And as it is appointed unto men[,] once to die, but after this the judgment: (KJV: Hebrews: 9.27);

For we (saints) must all appear before the judgment seat of the Messiah; that every one may receive the things *done* in *his* body, according to that he (which we- each) hath done, whether *it* be good or bad. (KJV: II. Corinthians: 5.10);

And whosoever was not found written in the book of life was cast into the lake of fire. (KJV: Revelation: 20.15);

The LORD is not slack concerning His promise, as some men count slackness; but is longsuffering to us-ward (toward us), not-willing that any should perish (eternally-decay), but that all should come to *the* repentance. (KJV: II. Peter: 3.9);

But God commendeth His love toward us, in that while we were yet sinners, the Messiah-Christ died for us. (KJV: Romans: 5.8);

Yet it pleased the LORD to bruise Him; He hath put *Him* to grief: when thou shalt make His soul an offering for sin, He shall see *His* seed, He shall prolong *His* days, and the pleasure of the LORD shall prosper in His hand. (KJV: Isaiah: 53.10);

All we like sheep have gone astray; we have turned every one to his own way; and the LORD hath laid on Him the iniquity of us all. (KJV: Isaiah: 53.6);

For God so loved the world, that He gave His only begotten Son, that whosoever believeth in Him should not perish-everlasting, but have *an* everlasting life. (KJV: John: 3.16);

And, from -: *Yeshua-the-Messiah- Jesus-Christ, Who is the faithful Witness, and the First Begotten of the dead, and the Prince of the kings of the earth[,] Unto Him That loved us, and washed us from our sins in His own blood, (KJV: Revelation: 1.5)... ;*



To him give all the prophets witness, that through His name whosoever believeth in Him shall receive remissions of sins. (KJV: Acts: 10.43);

[:]Forasmuch -then[,] as we are the offspring of God, we ought not to think that the Godhead is like unto gold, or silver, or stone graven [-image] by *the* art and man's devise. –

And the times of this ignorance God winked at; but now commandeth all [man] every where to repent: –

Because He hath appointed a day, in the which He will judge the world in righteousness by *that* Man Whom He hath ordained; *whereof* He hath given assurance unto all [man], in that He [the Father] hath raised Him [the Son] from the dead. (KJV: Acts: 17.29- 31);

Not every one that saith unto me, 'Lord, Lord,' shall enter into the kingdom of heaven; but he that doeth the will of My Father Which is in heaven. (KJV: Matthew: 7.21);

He that covereth his sins shall not prosper: But whoso confesseth and forsaketh *them* shall have mercy. (KJV: Proverbs: 28.13);

That if thou shalt confess with thy mouth the Lord Yushuah-Jesus, and shalt believe in thine heart that God that raised Him from the dead, thou shalt be saved. –

For with the heart man believeth unto righteousness; and with the mouth confession is made unto salvation. –

For the Scripture saith, 'Whosoever believeth on Him shall not be ashamed.' –

For there is no difference between the Jew and the Greek; for the same Lord over all is rich unto all that call upon Him. –

For 'whosoever shall call upon the name of the Lord shall be saved.' (KJV: Romans 10.9-13);

But God, Who is rich in mercy, for His great love wherewith He loved us, Even when we were dead in sins, hast quickened us together with the Messiah-Christ, (by grace ye are saved;) –

And hath raised *us* up together, and made *us* sit together in heavenly *places* in the Messiah-Christ Yushuah-Jesus;

For by grace are ye saved through faith; and that not of yourselves: *it is* the gift of God: ... (KJV: Ephesians: 2.4- 8);

Psalms 103: 2- 4, 10- 11 Bless the LORD, O my soul; And all that is with me, *bless* His holy name. – Bless the LORD, O my soul, And forget not all His benefits; –

Who forgiveth all thine iniquities; Who healeth all thy diseases; –

Who redeemeth thy life from destruction; Who crowneth thee with lovingkindness and tender mercies; ... – Who hath not dealt with us after our sins; Nor rewarded us according to our iniquities. –

For as the heaven is high above the earth, So great is His mercy toward them that fear [revere] Him.



Public Law 97-280
97th Congress

Joint Resolution

Authorizing and requesting the President to proclaim 1983 as the "Year of the Bible".

Oct. 4, 1982
[S.J. Res. 165]

Whereas the Bible, the Word of God, has made a unique contribution in shaping the United States as a distinctive and blessed nation and people;

Whereas deeply held religious convictions springing from the Holy Scriptures led to the early settlement of our Nation;

Whereas Biblical teachings inspired concepts of civil government that are contained in our Declaration of Independence and the Constitution of the United States;

Whereas many of our great national leaders—among them Presidents Washington, Jackson, Lincoln, and Wilson—paid tribute to the surpassing influence of the Bible in our country's development, as in the words of President Jackson that the Bible is "the rock on which our Republic rests";

Whereas the history of our Nation clearly illustrates the value of voluntarily applying the teachings of the Scriptures in the lives of individuals, families, and societies;

Whereas this Nation now faces great challenges that will test this Nation as it has never been tested before; and

Whereas that renewing our knowledge of and faith in God through Holy Scripture can strengthen us as a nation and a people: Now, therefore, be it

Resolved by the Senate and House of Representatives of the United States of America in Congress assembled, That the President is authorized and requested to designate 1983 as a national "Year of the Bible" in recognition of both the formative influence the Bible has been for our Nation, and our national need to study and apply the teachings of the Holy Scriptures.

Year of the Bible.

Approved October 4, 1982.

LEGISLATIVE HISTORY—S.J. Res. 165:

CONGRESSIONAL RECORD, Vol. 128 (1982):

Mar. 31, considered and passed Senate;
Sept. 21, considered and passed House.

AUTHENTICATED
U.S. GOVERNMENT
INFORMATION
GPO

2022-011769 MISC Page: 2123 of 2782
09/26/2022 03:35:37 PM Receipt #: 22-9381
Rec Fee: \$30.00 Darrell James Hill
Gila County, Az. Sadie Jo Bingham, Recorder



Public Law 101-209
101st Congress

Joint Resolution

Dec. 7, 1989
[S.J. Res. 164]

Designating 1990 as the "International Year of Bible Reading".

Whereas the Bible has made a unique contribution in shaping the United States as a distinctive and blessed Nation and people; Whereas deeply held values springing from the Bible led to the early settlement of our Nation;

Whereas many of our great national leaders, such as Presidents Washington, Jackson, Lincoln, and Wilson, paid tribute to the important influence the Bible has had in the development of our Nation;

Whereas President Jackson called the Bible "the rock on which our Republic rests";

Whereas the history of our Nation illustrates the value of voluntarily applying the teachings of the Bible in the lives of individuals and of families; and

Whereas numerous individuals and organizations around the world are joining hands to encourage international Bible reading in 1990: Now, therefore, be it

Resolved by the Senate and House of Representatives of the United States of America in Congress assembled, That 1990 is designated as the "International Year of Bible Reading". The President is authorized and requested to issue a proclamation recognizing both the formative influence the Bible has had on many societies of the world and the value of the study of the Bible.

Approved December 7, 1989.

LEGISLATIVE HISTORY—S.J. Res. 164:

CONGRESSIONAL RECORD, Vol. 135 (1989):

Oct. 20, considered and passed Senate.

Nov. 20, considered and passed House, amended. Senate concurred in House amendments.

2115
AUTHENTICATED
U.S. GOVERNMENT
INFORMATION
GPO

2022-011769 MISC Page: 2124 of 2782
09/26/2022 03:35:37 PM Receipt #: 22-9381
Rec Fee: \$30.00 Darrell James Hill
Gila County, Az, Sadie Jo Bingham, Recorder



Calling on the President to proclaim 2007 as the "National Year of the Bible".

IN THE HOUSE OF REPRESENTATIVES

June 21, 2006

Mrs. Musgrave (for herself and Mr. Rush) submitted the following concurrent resolution; which was referred to the Committee on Government Reform

CONCURRENT RESOLUTION

Calling on the President to proclaim 2007 as the "National Year of the Bible".

Whereas 2007 is the 275th anniversary of the birth of George Washington, the father and first President of our great Nation and for whom the Bible was a primary inspiration for his life, as is manifested in the many direct Biblical references and Biblical allusions in his writings and speeches;

Whereas 2007 is the 225th anniversary of the Aitken Bible, the first English Bible printed in America;

Whereas 2007 is the 225th anniversary of the creation of the Great Seal of the United States, a "coat of arms" whose Biblical imagery was considered by the founders to represent the beliefs and values of an independent nation and a free people with grand aspirations for the future;

Whereas 2007 is the 200th anniversary of the abolition of slavery in England, a cause which was largely driven by William Wilberforce who drew his inspiration from scripture and who played a major role in the creation of the first British Bible Society;

Whereas 2007 is the 175th anniversary of the founding of the New England Anti-Slavery Society, similarly inspired by Biblical principles;

Whereas the Bible has had a profound impact in shaping America into a great nation;



Whereas many of our Presidents have recognized the importance of God and the Bible, including George Washington and Abraham Lincoln, and Ronald Reagan who declared 1983 the ``National Year of the Bible";

Whereas the Bible has inspired Americans from all walks of life, especially the early settlers whose faith, spiritual courage, and moral strength enabled them to endure intense hardships in this new land;

Whereas shared Biblical beliefs unified the colonists and gave our Founding Fathers the wisdom to write the Declaration of Independence and the Constitution of the United States, both of which recognized the inherent divine worth, dignity, and inalienable rights of each individual, thus unifying a diverse people with the right to vote and the freedoms of speech and religion;

Whereas the Bible has been the world's best-selling book since first published in English in 1526 and has influenced more people than any other book;

Whereas the Bible has been a cornerstone in the development of Western civilization, influencing the nations in the areas of history, legal and political systems, culture, music, literature, art, drama, and moral philosophy;

Whereas the Bible was the primary inspiration for the work of Rev. Dr. Martin Luther King, Jr., in advancing the civil rights movement in the United States, as evidenced by many biblical references in his speeches and writings; and

Whereas the Bible, used as a moral compass, has inspired compassion, love for one's neighbor, and the sanctity of life and marriage, and has stimulated many benevolent initiatives that have healed and strengthened our families, communities and the entire nation: Now, therefore, be it

Resolved by the House of Representatives (the Senate concurring),

That the Congress calls upon the President to issue a proclamation--

- (1) designating the ``National Year of the Bible";
- (2) calling upon citizens of all faiths to rediscover and apply the priceless and timeless message of the Bible; and
- (3) encouraging the people of the United States to join the President and the Congress in observance of this year of national celebration of the Bible with appropriate programs, ceremonies, and activities.

<all>

109th CONGRE

2022-011769 MISC Page: 2126 of 2782
09/26/2022 03:35:37 PM Receipt #: 22-9381
Rec Fee: \$30.00 Darrell James Hill
Gila County, Az, Sadie Jo Bingham, Recorder



[Congressional Bills 110th Congress]
[From the U.S. Government Printing Office]
[H. Con. Res. 284 Introduced in House (IH)]

110th CONGRESS
2d Session
H. CON. RES. 284

Encouraging the President to proclaim 2008 as "The National Year of the Bible".

IN THE HOUSE OF REPRESENTATIVES

January 29, 2008

Mr. Akin (for himself and Mr. Cleaver) submitted the following concurrent resolution; which was referred to the Committee on Oversight and Government Reform

CONCURRENT RESOLUTION

Encouraging the President to proclaim 2008 as "The National Year of the Bible".

Whereas the Bible has had a profound impact in shaping America into a great nation;

Whereas deep religious beliefs stemming from the Old and New Testament of the Bible have inspired Americans from all walks of life, especially the early settlers, whose faith, spiritual courage, and moral strength enabled them to endure intense hardships in this new land;

Whereas many of our Presidents have recognized the importance of God and the Bible, including George Washington and Abraham Lincoln, FDR, Harry Truman, John F. Kennedy, and especially Ronald Reagan, who declared 1983 as "The National Year of the Bible";

Whereas shared Biblical beliefs unified the colonists and gave our early leaders the wisdom to write the Declaration of Independence and the Constitution of the United States, both of which recognized the inherent worth, dignity, and inalienable rights of each individual, thus unifying a diverse people with the right to vote and the freedoms of speech and

110th CONGRESS ; 2d Session ; H.

2118

2022-011769 MISC Page: 2127 of 2782
09/26/2022 03:35:37 PM Receipt #: 22-9381
Rec Fee: \$30.00 Darrell James Hill
Gila County, Az, Sadie Jo Bingham, Recorder



religion which gave men like Dr. Martin Luther King Jr. the courage to lead the Civil Rights Movement;

Whereas the Bible has been the world's best selling book since it was first published in English in 1526, and has influenced more people than any other book;

Whereas the Bible has been a cornerstone in the development of Western civilization, influencing the nations in the areas of history, legal and political systems, culture, music, literature, art, drama, and especially moral philosophy;

Whereas the Bible, used as a moral guide, has inspired compassion, love for our neighbor, and the preciousness of life and marriage, and has stimulated many benevolent, faith-based and community initiatives which have healed and blessed our families, communities, and our entire Nation, especially in times of crises and tragedies;

Whereas the Bible has inspired acts of patriotism that have unified Americans, commemorated through shared celebrations such as Dr. Martin Luther King Jr. Day, Thanksgiving, Independence Day, and Memorial Day, as well as Labor Day and Presidents Day; and

Whereas 2008 is an appropriate year to name "The National Year of the Bible" since it is the 25th anniversary of the 1983 Year of the Bible: Now, therefore, be it

Resolved by the House of Representatives (the Senate concurring), That the President is encouraged--

(1) to designate an appropriate year as "The National Year of the Bible"; and

(2) to issue a proclamation calling upon citizens of all faiths to rediscover and apply the priceless, timeless message of the Holy Scriptures which has profoundly influenced and shaped the United States and its great democratic form of self government, as well as its rich spiritual heritage, and which has unified, healed, and strengthened its people for over 200 years.

<all>

2119



[Congressional Bills 111th Congress]
[From the U.S. Government Printing Office]
[H. Con. Res. 121 Introduced in House (IH)]

111th CONGRESS
1st Session
H. CON. RES. 121

Encouraging the President to designate 2010 as "The National Year of the Bible".

IN THE HOUSE OF REPRESENTATIVES

May 7, 2009

Mr. Broun of Georgia (for himself, Mr. Westmoreland, Mr. Forbes, Mr. Pence, Mr. Gingrey of Georgia, Mr. Franks of Arizona, Mr. Jordan of Ohio, Mr. Wamp, Mr. Lamborn, Mr. Gohmert, Mr. Marchant, Mr. Carter, Mr. Akin, and Mr. McGovern) submitted the following concurrent resolution; which was referred to the Committee on Oversight and Government Reform

CONCURRENT RESOLUTION

Encouraging the President to designate 2010 as "The National Year of the Bible".

Whereas the Bible has had a profound impact in shaping America into a great Nation;

Whereas deep religious beliefs stemming from the Old and New Testament of the Bible have inspired Americans from all walks of life, especially the early settlers, whose faith, spiritual courage, and moral strength enabled them to endure intense hardships in this new land;

Whereas many of our Presidents have recognized the importance of God and the Bible, including George Washington; Franklin D. Roosevelt; Harry Truman; John F. Kennedy; Ronald Reagan, who declared 1983 as "The National Year of the Bible"; and especially Abraham Lincoln, whose 200th Birthday Celebration in 2009 highlighted freedom for the slaves;

Whereas shared Biblical beliefs unified the colonists and gave our early leaders the wisdom to write the Declaration of Independence and the Constitution of the United States, both of which recognized the inherent worth, dignity, and inalienable rights of each individual, thus unifying a diverse people with the right to vote, and the freedoms of speech and vast religious freedoms, which inspired courageous men like Dr. Martin

111th CONGRESS; 1st Session; H. C

2022-011769 MISC Page: 2129 of 2782
09/26/2022 03:35:37 PM Receipt #: 22-9381
Rec Fee: \$30.00 Darrell James Hill
Gila County, Az, Sadie Jo Bingham, Recorder



Luther King Jr. to lead the Civil Rights Movement;
Whereas the Bible has been the world's best selling book since it was first published in English in 1526, and has influenced more people than any other book;
Whereas the Bible has been a cornerstone in the development of Western civilization, influencing the nations in the areas of history, law, politics, culture, music, literature, art, drama, and especially moral philosophy;
Whereas the Bible, used as a moral guide, has inspired compassion, love for our neighbor, and the preciousness of life and marriage, and has stimulated many benevolent, faith-based community initiatives and neighborhood partnerships that have healed and blessed our families, communities, and our entire Nation, especially in times of war, tragedy, and economic and social crisis;
Whereas the Bible has inspired acts of patriotism that have unified Americans, commemorated through shared celebrations such as Dr. Martin Luther King Jr. Day, Presidents Day, Memorial Day, Independence Day, Labor Day, Thanksgiving, and Christmas; and
Whereas 2010 is an appropriate year to designate as "The National Year of the Bible": Now, therefore, be it

Resolved by the House of Representatives (the Senate concurring),
That the President is encouraged--

(1) to designate an appropriate year as "The National Year of the Bible"; and

(2) to issue a proclamation calling upon citizens of all faiths to rediscover and apply the priceless, timeless message of the Holy Scripture which has profoundly influenced and shaped the United States and its great democratic form of Government, as well as its rich spiritual heritage, and which has unified, healed, and strengthened its people for over 200 years.

<all>

111th CONGRESS; 1st Session; H. CO

2022-011769 MISC Page: 2130 of 2782
09/26/2022 03:35:37 PM Receipt #: 22-9381
Rec Fee: \$30.00 Darrell James Hill
Gila County, Az, Sadie Jo Bingham, Recorder



[Congressional Bills 112th Congress]
[From the U.S. Government Publishing Office]
[H. Con. Res. 38 Introduced in House (IH)]

112th CONGRESS
1st Session
H. CON. RES. 38

Recognizing the 400th anniversary of the publication of the King James
Version of the Bible.

IN THE HOUSE OF REPRESENTATIVES

April 12, 2011

Mr. Aderholt (for himself and Mr. Rahall) submitted the following
concurrent resolution; which was referred to the Committee on Oversight
and Government Reform

CONCURRENT RESOLUTION

Recognizing the 400th anniversary of the publication of the King James
Version of the Bible.

Whereas the King James Version of the Bible was the first English language Bible
to be published in the United States;

Whereas the King James Bible, also called the Authorized Version, has made a
unique contribution in shaping the English language, including hundreds
of common everyday expressions;

Whereas the language of the King James Bible has entered into the very culture
of the United States through a myriad of poetry, speeches, sermons,
music, songs, and literature;

Whereas the teachings of the Scriptures, particularly read from the King James
Scriptures, have inspired concepts of civil government contained in our
founding documents, and subsequent laws;

Whereas public officials on all levels of governments, including presidents,
have taken their oath of office with the King James Bible;

Whereas many national leaders, have paid tribute to the surpassing influence of
the Bible in the United States development, among them the words of
Democratic President Andrew Jackson, calling it "the rock upon which
our republic rests";

Whereas Republican President Ronald Reagan also said of the King James Bible,
"Indeed, it is an incontrovertible fact that all the complex and

112th CONGRESS; 1st Session; H

2122

2022-011769 MISC Page: 2131 of 2782
09/26/2022 03:35:37 PM Receipt #: 22-9381
Rec Fee: \$30.00 Darrell James Hill
Gila County, Az, Sadie Jo Bingham, Recorder



horrendous questions confronting us at home and worldwide have their answer in that single book";
Whereas in the history of the United States, the King James Bible has played a significant role in the education of countless individuals, families, and societies;
Whereas the King James Bible, the most printed and widely distributed work in history, is now in its 400th year of publication;
Whereas in 2011, the 400th anniversary of publishing the King James Bible will be celebrated in churches, public events, and conferences with further research, discussions, speeches, and sermons; and
Whereas the King James Bible's relevance and contributions continue to formatively influence the United States: Now, therefore, be it Resolved by the House of Representatives (the Senate concurring), That Congress--

- (1) recognizes the 400th anniversary of the Authorized King James Version of the Bible being published;
- (2) recognizes its lasting influence on countless families, individuals, and institutions in the United States; and
- (3) expresses its gratitude for the influence it has bestowed upon the United States.

<all>

2022-011769 MISC Page: 2132 of 2782
09/26/2022 03:35:37 PM Receipt #: 22-9381
Rec Fee: \$30.00 Darrell James Hill
Gila County, Az, Sadie Jo Bingham, Recorder



Unofficial Copy

2123

Recognizing the opening of the nonsectarian Museum of the Bible in Washington, D.C., the only museum of its size and scope in the world devoted exclusively to the Bible.

IN THE HOUSE OF REPRESENTATIVES

November 17, 2017

Mr. Pittenger (for himself, Mr. Pearce, Mrs. Hartzler, Mr. Weber of Texas, Mr. Franks of Arizona, Mr. Grothman, Mr. Hultgren, Mr. Babin, Mr. Shimkus, Mr. Harris, Mr. Allen, Mr. Westerman, Mr. Kelly of Mississippi, Mr. Cole, Mr. Ross, Mr. Estes of Kansas, Mr. Loudermilk, Mr. Posey, Mr. Chabot, Mr. Olson, Mr. Banks of Indiana, Mr. Wilson of South Carolina, Mr. Jody B. Hice of Georgia, Mr. Norman, Mr. LaMalfa, Mr. Aderholt, Mr. Walberg, Mr. Jones, Mr. Flores, Mr. Hudson, Mr. Harper, Mr. Poliquin, Mr. Cleaver, Mr. Johnson of Louisiana, and Mr. Lamborn) submitted the following concurrent resolution; which was referred to the Committee on Natural Resources

CONCURRENT RESOLUTION

Recognizing the opening of the nonsectarian Museum of the Bible in Washington, D.C., the only museum of its size and scope in the world devoted exclusively to the Bible.

Whereas the Bible has played a prominent role in the culture of the United States and has been a significant influence throughout the history of our Nation;

Whereas, in 1956, Congress passed a Joint Resolution adopting "In God We Trust" as the official motto of the United States;

Whereas, in 1982, Congress passed the Joint Resolution entitled "Joint Resolution authorizing and requesting the President to proclaim 1983 as the "Year of the Bible" (Public Law 97-280), finding that the Bible "has made a unique contribution in shaping the United States as a distinctive and blessed nation and people";

Whereas, on November 17, 2017, the Museum of the Bible opened a 430,000-square-foot nonprofit museum in Washington, D.C., 3 blocks from the Capitol, and will be free to all visitors;

Whereas the Museum of the Bible is a nonsectarian institution that does not



promote any faith or denomination;

Whereas, in 2014, the architectural concept submission for the Museum of the Bible was approved by the Commission of Fine Arts, the local Washington, D.C., Advisory Neighborhood Commission, and the Historic Preservation ;

Review Board, and the primary building of the Museum of the Bible was awarded historical status by the Historic Preservation Review Board;

Whereas the Museum of the Bible will have 3 primary exhibit floors focused on the history, narrative, and impact of the Bible;

Whereas the entrance to the Museum of the Bible will feature 2, 40-foot-tall bronze panels that contain the first lines of Genesis in Latin, as originally printed in the Gutenberg Bible, and art glass panels featuring a papyrus containing the 19th psalm; and

Whereas the Museum of the Bible is an innovative, global, nonsectarian, educational institution the purpose of which is to permit all people to engage with the Bible: Now, therefore, be it

Resolved by the House of Representatives (the Senate concurring),

That Congress--

(1) recognizes the opening of the Museum of the Bible in Washington, D.C., the first nonsectarian museum of its kind in the capital of the United States focused exclusively on the history, narrative, and impact of the Bible; and

(2) commends the leadership, staff, scholars, designers, construction workers, and volunteers who worked tirelessly to realize the goal of opening a museum, free to the public, with the nonsectarian purpose of "inviting all people to engage with the Bible".

<all>



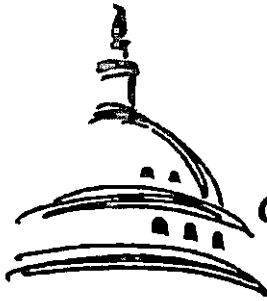

**Congressional
Research
Service**

Federal Government Corporations: An Overview

Kevin R. Kosar
Analyst in American National Government

June 8, 2011

Congressional Research Service

7-5700

www.crs.gov

CRS Report for Congress
Prepared for Members and Committees of Congress

2022-011769 MISC Page: 2135 of 2782
09/26/2022 03:35:37 PM Receipt #: 22-9381
Rec Fee: \$30.00 Darrell James Hill
Gila County, Az, Sadie Jo Bingham, Recorder



Summary

To assist Congress in its oversight activities, this report provides an overview of the government corporation as an administrative model. As defined in this report, a government corporation is a government agency that is established by Congress to provide a market-oriented public service and to produce revenues that meet or approximate its expenditures. By this definition, currently there are 17 government corporations.

In the typical contemporary Congress, several bills are introduced to establish government corporations. At the time of publication of this report, two bills had been introduced in the 112th Congress to improve U.S. infrastructure by establishing government corporations—H.R. 404 and S. 652. Similarly, in the 111th Congress, government corporations bills included ones that would have created an Indian Development Finance Corporation (H.R. 1607), a Green Bank (H.R. 1698), and a National Infrastructure Development Bank (H.R. 2521).

The government corporation model has been utilized by the federal government for over a century. Today's government corporations cover the spectrum in size and function from large, well-known entities, such as the U.S. Postal Service and the Federal Deposit Insurance Corporation, to small, low-visibility corporate bodies, such as the Federal Financing Bank in the Department of the Treasury and Federal Prison Industries in the Department of Justice.

The federal government does not possess a general incorporation statute as states do. Each government corporation is chartered through an act of Congress. The use of separate acts to charter each corporation has resulted in wide variance in the legal and organizational structure of government corporations. That said, the Government Corporation Control Act of 1945, as amended, does provide for the standardized budget, auditing, debt management, and depository practices for those corporations listed in the act.

Within the executive branch, no one agency is responsible for the oversight and supervision of government corporations. Neither the House nor the Senate have single committees with the responsibility to oversee all government corporations. Instead, each corporation is overseen by the committee(s) with jurisdiction over its policy area.

Many government corporations, such as the Tennessee Valley Authority, have been established to exist in perpetuity. Other government corporations, such as the U.S. Enrichment Corporation, though, have been designed to serve as transition vehicles to transform from governmental entities into private firms.

Congress at times has found the government corporation an attractive governance option. A well-designed and -operated government corporation does not require annual appropriations because it generates revenues from the provision of goods and services. Moreover, each government corporation may be endowed with the administrative flexibilities required to accomplish its goals while remaining responsive to Congress and the President. Finally, as noted above, the government corporation may be established to serve an enduring purpose or may serve as a vehicle for privatization.

This report will be updated in the event of a significant development.



Contents

Context..... 1

The Government Corporation: Contested Definitions 2

Evolution of the Federal Government Corporation 3

Characteristics of a Government Corporation..... 5

 Legal Status 5

 Budget and Finance..... 7

 Location and Governance..... 8

Oversight..... 10

Government Corporations as Transition Organizations 11

Conclusion..... 13

Appendixes

Appendix. Federal Government Corporations..... 15

Contacts

Author Contact Information 15

Acknowledgments 15

Unofficial

2128



Context

The federal government has employed government corporations to achieve policy goals for over a century. Among Members of Congress, the executive branch, and the scholarly community, interest in the government corporation option, and variations on this class of agency, has increased in recent decades.¹

In the typical contemporary Congress, several bills are introduced to establish government corporations. At the time of publication of this report, two bills had been introduced in the 112th Congress to improve U.S. infrastructure by establishing government corporations—H.R. 404 and S. 652. Similarly, in the 111th Congress, government corporations bills included ones that would have created an Indian Development Finance Corporation (H.R. 1607), a Green Bank (H.R. 1698), and a National Infrastructure Development Bank (H.R. 2521).

At least three factors may contribute to the interest in government corporations. First, the restrictive character of the federal budget encourages agencies to develop new sources of revenue (e.g., outsourcing services to the private sector and to other agencies) and to attempt to avoid increasing outlays.² Second, experience suggests that it is politically easier for corporate bodies to be exempted by Congress from the federal government's general management laws (e.g., the Freedom of Information Act and employee compensation restrictions) than it is for traditional agencies. Finally, the corporate concept appears to many, correctly or otherwise, to be supportive of the "New Public Management" that emphasizes entrepreneurship, risk-taking, and private sector practices in federal administration.³

The continuing interest in the government corporation prompts questions as to their legal character, their utility vis-à-vis traditional agencies, and their limitations as units of governmental institutions. A government corporation is not always an the optimal administrative entity for achieving governance objectives. There are times when it may be an appropriate choice and times when it may not. Understanding the unique character of government management, based as it is upon tenets of public law, provides guidance in weighing these choices.⁴

¹ Thomas H. Stanton and Ronald C. Moe, "Government Corporations and Government-Sponsored Enterprises" in Lester M. Salamon, ed., *The Tools of Government: A Guide to the New Governance* (New York: Oxford University Press, 2002), pp. 80-116; Jerry Mitchell, *The American Experiment with Government Corporations* (Armonk, NY: M.E. Sharpe, 1999); A. Michael Froomkin, "Reinventing the Government Corporation," *University of Illinois Law Review* (1995), pp. 543-634; Harold Sedman, *Politics, Position and Power: The Dynamics of Federal Organization*, 5th ed. (New York: Oxford University Press, 1998), pp. 189-196; U.S. General Accounting Office, *Government Corporations: Profiles of Recent Proposals*, GAO/GGD-95-57FS (Washington: GAO, 1995); and U.S. Senate, Committee on Governmental Affairs, *Managing the Public's Business: Federal Government Corporations*, by Ronald C. Moe, S.Prt. 104-18, 104th Cong., 1st sess. (Washington: GPO, 1995).

² For a discussion of how the Patuxent River Naval Air Station contracts out its services to state governments and private organizations, including use of their Defense Department aircraft, see Steve Vogel, "Pentagon Recruits New Business: Military Turns to Private Enterprise to Help Pay Bills," *Washington Post*, August 8, 1998, p. B1.

³ The term "New Public Management" refers to the literature, propositions, and practices that promote the conceptual convergence of governmental and private sector management. OECD, *Governance in Transition: Public Management Reforms in OECD Countries* (Paris: OECD, 1995); Donald F. Kettl, *The Transformation of Governance: Public Administration for 21st Century America* (Baltimore: The Johns Hopkins University Press, 2002); and Robert D. Behm, *Rethinking Democratic Accountability: Performance and the New Public Management* (Washington: The Brookings Institution, 2001).

⁴ See, for example, Ronald C. Moe, "The Importance of Public Law: New and Old Paradigms of Government Management," in Phillip J. Cooper and Chester A. Newland, eds. *Handbook of Public Law and Administration* (San ... (continued...)



2129

The Government Corporation: Contested Definitions

What is a federal government corporation, and what are the essential characteristics of a government corporation?

As defined in this report, a federal government corporation is an agency of the federal government, established by Congress to perform a public purpose, which provides a market-oriented product or service and is intended to produce revenue that meets or approximates its expenditures. By this definition, there are 17 entities that are government corporations.⁵

The U.S. Code does not provide a single definition of the term "government corporation." Title 5 of the *U.S. Code* defines a "government corporation" as "a corporation owned or controlled by the Government of the United States" (5 U.S.C. 103).⁶ Meanwhile, the Government Corporation Control Act (GCCA) 31 U.S.C. 9101-10) states that the term "government corporation" means "a mixed-ownership Government corporation and a wholly-owned government corporation." It then lists 28 entities—some, like the Pennsylvania Avenue Development Corporation, now defunct—as being "government corporations" for the purposes of chapter 91 of Title 31.

In addition to the enumeration of corporations provided in the GCCA, there have been several other listings of corporations available, each different and based upon the definition employed by the compiler. Corporations cover the spectrum from such large, well-known corporations as the United States Postal Service and the Federal Deposit Insurance Corporation to such small, low-visibility corporate bodies as the Federal Financing Bank in the Treasury Department and Federal Prison Industries (UNICOR) in the Justice Department.

The number of federal corporations is in moderate flux. New corporations are established from time to time (e.g., the Valles Caldera Trust in 2000),⁷ and existent ones are dissolved (e.g., the Rural Telephone Bank in 2008).⁸

Government corporations should not be confused with quasi governmental entities, such as government-sponsored enterprises (GSEs). A GSE (e.g., Fannie Mae) is a privately owned, federally chartered financial institution with nationwide scope and lending powers that benefits

(...continued)

Francisco: Jossey-Bass Publishers, 1997), pp. 41-57.

⁵ For a list of federal government corporations, as defined in this report, please consult the **Appendix**. This report's definition of "government corporation" excludes a great many federal entities. It excludes private corporations created by federal statute (e.g., the American National Red Cross, the Securities Investor Protection Corporation, and Fannie Mae). It also excludes some corporations that Congress itself has called "government corporations." For example, the 108th Congress established the Millennium Challenge Corporation (MCC) as a "government corporation" (P.L. 108-199). Though clearly a federal entity, the MCC is not included on this report's list because MCC does not provide market-oriented products or services—the MCC is a grant-awarding agency that is not designed to be financially self-sufficient.

⁶ This definition holds only for "the purpose of this title," i.e., Title 5 of the *U.S. Code*.

⁷ P.L. 106-248; 114 Stat. 603; 16 U.S.C. 696v-4.

⁸ With Congress's assent, both the Rural Telephone Bank and the Pennsylvania Avenue Development Corporation and dissolved themselves under their own corporate authorities.



from an implicit federal guarantee to enhance its ability to borrow money.⁹ GSEs are important institutions worthy of separate analysis, but they are not discussed, except in passing, in this report.¹⁰ Unlike government corporations, with GSEs and other quasi governmental entities, the legal and political lines of accountability can be ambiguous.¹¹ In 1996, for instance, the Office of Personnel Management (OPM) created the United States Investigation Services Corporation as an employee stock-ownership plan (ESOP), an entry into the quasi government category that sparked debate regarding its status and authority.¹²

Evolution of the Federal Government Corporation

Historically, the federal government has been involved in few commercial enterprises. There were some early instances of the federal government participating in otherwise private corporate enterprises on a shared ownership basis, most notably the first and second Banks of the United States. This practice came into question, however, as a consequence of a Supreme Court ruling in 1819.¹³ From that time to today, the federal government has tended to avoid sharing ownership with private entities.

The first time the federal government acquired a corporation outright occurred in 1903, when the Panama Railroad Company was purchased from the French Panama Canal Company.¹⁴ Since then, a number of corporate bodies have been established as part of the federal government, with growth in that number tending to come in spurts and generally in response to emergencies. The

⁹ In 1996, the board of directors of the Federal National Mortgage Association changed its name to Fannie Mae, although the law still refers to the organization by its former name.

¹⁰ For a discussion of GSEs, see CRS Report RS21663, *Government-Sponsored Enterprises (GSEs): An Institutional Overview*, by Kevin R. Kosar, and Thomas H. Stanton, *Government-Sponsored Enterprises: Mercantilist Companies in the Modern World* (Washington: AEI Press, 2002).

¹¹ Harold Seidman, "The Quasi World of the Federal Government," *The Brookings Review*, vol. 2, summer 1988, pp. 23-27; CRS Report RL30533, *The Quasi Government: Hybrid Organizations with Both Government and Private Sector Legal Characteristics*, by Kevin R. Kosar, Jonathan G.S. Koppel, *The Politics of Quasi Government: Hybrid Organizations and the Dynamics of Bureaucratic Control* (Cambridge, UK: Cambridge University Press, 2003); and Ronald C. Moe, "The Emerging Federal Quasi Government: Issues of Management and Accountability," *Public Administration Review*, vol. 61, May/June 2001, pp. 290-312.

The congressionally chartered National Veterans Business Development Corporation (NVBDC) is a case in point. The 2004 Omnibus Appropriations Act (P.L. 108-447, Div. K, Sec. 146) declared the NVBDC, thought by some to be a government corporation, to be "a private entity" and "not an agency, instrumentality, authority, entity, or establishment of the United States Government." The Department of Justice did not agree with this characterization. See Office of the Legal Counsel, United States Department of Justice, *Memorandum for Jennifer Newstead, General Counsel, Office of Management and Budget*, March 19, 2004.

¹² U.S. General Accounting Office, *Privatization of OPM's Investigations Service*, GAO/GGD-96-97 (Washington: GAO, 1996); Ronald P. Sanders and James Thompson, "Live Long and Prosper: How One Former Federal Organization Is Adjusting to Life After Government," *Government Executive*, vol. 29, April 1997, pp. 51-53; Stephen Barr, "OPM, in a First, Acts to Convert an Operation into Private Firm," *Washington Post*, April 14, 1996, p. A4; and Dan Broidy, *The Iron Triangle: Inside the Secret World of the Carlyle Group* (New York: John Wiley, 2003).

¹³ *McCulloch v. Maryland* (17 U.S. (4 Wheat.) 315 (1819)). The Supreme Court's ruling implied that partial federal ownership of a corporation, in this instance the Bank of the United States, assigned the corporation certain attributes normally reserved to the sovereign authority (e.g., non-taxable status). The Court also declared that the Necessary and Proper Clause of the Constitution (Art. I, sec. 8, cl. 18) permitted Congress to establish corporations. See also *Osborn v. Bank of the United States*, 17 U.S. (4 Wheat.) 738 (1824).

¹⁴ Marshall Dimock, *Government-Operated Enterprises in the Panama Canal Zone* (Chicago: University of Chicago Press, 1934).



2131

first large-scale use of the corporate option accompanied the mobilization for World War I.¹⁵ Later, the Depression of the 1930s fostered numerous corporations (e.g., the Reconstruction Finance Corporation, and the Tennessee Valley Authority).¹⁶ Finally, World War II prompted the establishment of additional federal corporations. After the passing of each of these emergencies, many of the corporations that dealt with them were abolished or absorbed into the permanent executive branch agencies.

In 1945, partly in response to the proliferation of corporate bodies created for the war effort, Congress passed the Government Corporation Control Act (GCCA; 59 Stat. 841; 31 U.S.C. 9101-9110). The act standardized budget, auditing, debt management, and depository practices for corporations. Notwithstanding unusual provisions that may be present in their enabling statute, government corporations remain "agencies" of the United States,¹⁷ and are therefore subject to all laws governing agencies, except where exempted from coverage by provisions of general management laws.¹⁸

The GCCA is not a general incorporation act such as is in effect in the states. The charter for each federal government corporation is the separate enabling legislation passed by Congress. The GCCA also does not offer a general definition of what constitutes a government corporation. It simply enumerates the organizations covered by the act.

In addition to the enumeration of corporations in the GCCA, there have been several other listings of corporations available, each different and based upon the definition employed by the compiler.¹⁹ The corporations cover the spectrum from such large, well-known corporations as the United States Postal Service and the Federal Deposit Insurance Corporation to such small, low-visibility corporate bodies as the Federal Financing Bank and Federal Prison Industries (UNICOR).

In the absence of a general incorporation act with organizational definitions, how is one to know when a government corporation is the most suitable option, and what criteria should be met before a government corporation is established? In an effort to provide criteria to determine when the corporate option was appropriate, President Harry Truman, in his 1948 budget message, stated:

¹⁵ Harold A. Van Dom, *Government Owned Corporations* (New York: Alfred A. Knopf, 1926).

¹⁶ John Thurston, *Government Proprietary Corporations in English-Speaking Countries* (Cambridge: Harvard University Press, 1937).

¹⁷ CRS Report RL30795, *General Management Laws: A Compendium* by Clinton T. Brass et al.

¹⁸ In the 1946 case of *Cherry Cotton Mills v. United States* (327 U.S. 536), the Supreme Court held that government corporations are agencies of the United States. "That the Congress chose to call it [Reconstruction Finance Corporation] a corporation does not alter its character so as to make it something other than what it actually is, an agency selected by the Government to accomplish purely governmental purposes."

¹⁹ In a 1988 report the GAO profiled some 44 government corporations. U.S. General Accounting Office, *Profiles in Existing Government Corporations*, GAO/AFMD-89-43FS (Washington: GAO, 1988). In 1995, using a more precise and narrow definition, the GAO concluded that there were actually 22 government corporations. U.S. General Accounting Office, *Government Corporations: Profiles of Existing Corporations*, GAO/GGD-96-14 (Washington: GAO, 1995). Some years earlier, in 1981, the National Academy of Public Administration issued a substantial report on government corporations and listed 39 corporations. *Report on Government Corporations, 2v.* (Washington: National Academy of Public Administration, 1981). Finally, in a major study of government corporations, A. Michael Froomkin, using a somewhat eclectic definition, simply concluded that there were "more than forty" government corporations. "Reinventing the Government Corporation," *University of Illinois Law Review*, 1995, p. 549.



Experience indicates that the corporate form of organization is peculiarly adapted to the administration of government programs which are predominately of a commercial character—those which are revenue producing, are at least potentially self-sustaining and involve a large number of business-type transactions with the public. In their business operations such programs require greater flexibility than the customary type of appropriations budget ordinarily permits. As a rule, the usefulness of a corporation rests on its ability to deal with the public in a manner employed by private enterprise for similar work.²⁰

That said, Congress has created many entities titled “government corporations” and “corporations” that do not meet these criteria. The Legal Services Corporation (LSC), the Corporation for Public Broadcasting (CPB), and the newly established International Clean Energy Foundation are examples of “corporations” that do not perform commercial functions and rely upon annual appropriations.²¹ A principal intention behind assigning this status and title was to provide considerable insulation from oversight by the central management agencies and the application of the general management laws.

Characteristics of a Government Corporation

No two federal government corporations are completely alike. However, there are sufficient commonalities among the several corporations, that it is possible to make some generalizations about their authorities, organization, mission, and behavior.²²

Legal Status

Government corporations, no matter what function they perform or how “private” they may appear to the public or to themselves, are agents of the state subject to constitutional limitations.²³ As the Supreme Court concluded in the 1995 *Lebron* case, a government corporation has certain inherent legal characteristics that cannot be shed simply by legislative language or by corporate fiat.²⁴ The nature of the function performed (e.g., managing a railroad) has no effect upon its

²⁰ U.S. Congress, House, *Document No. 19*, 80th Congress, 2nd session (Washington: GPO, 1948), pp. M57-M62.

²¹ By statute, both the CPB and the LSC are not-for-profit corporations chartered under the laws of the District of Columbia (47 U.S.C. 396 and 42 U.S.C. 2996). That said, the *Cherry Cotton Mills* decision indicates that the Supreme Court, not Congress, is the ultimate arbiter of what is and is not a government corporation.

²² For further information on the legal status and laws on budgeting and finances of government corporations, see General Accounting Office, *Principles of Federal Appropriations Laws*, vol. iv, pp. 17-119 - 17-216.

²³ Ronald C. Moe and Robert S. Gilmour, “Rediscovering Principles of Public Administration: The Neglected Foundation of Public Law,” *Public Administration Review*, vol. 55, March/April 1995, pp. 135-46.

²⁴ The Supreme Court in a 1995 case faced the issue of distinguishing between a governmental and private corporation. The National Railroad Passenger Corporation (AMTRAK) established by Congress (45 U.S.C. 451), and enumerated as a “mixed-ownership corporation” under 31 U.S.C. 9101, was sued by Michael Lebron for rejecting, on political grounds, an advertising sign he had contracted with them to display. Lebron claimed that his First Amendment rights had been abridged by AMTRAK because it is a government corporation, and therefore an agency of the United States. AMTRAK argued, on the other hand, that its legislation provides that it “will not be an agency or establishment of the United States Government” and thus is not subject to constitutional provisions governing freedom of speech. The Court decided that, although Congress can determine AMTRAK’s governmental status for purposes within Congress’s control (e.g., whether it is subject to statutes such as the Administrative Procedure Act), Congress cannot make the final determination of AMTRAK’s status as a government entity for purposes of determining constitutional rights of citizens affected by its actions. To do so, in the Court’s view, would mean that the government could evade its most solemn (continued...)



2133

governmental character. The governmental and private sectors are fundamentally separate and distinct, with the distinctions based largely in legal theory, not economic theory.²⁵ This understanding is essential to recognizing both the potentialities and limitations of the government corporate concept. The government corporation remains governmental in character until Congress determines it shall be fully private, thereby coming under private law.

As a general proposition, the attorney general is vested with central control over the litigation to which the U.S. government is a party.²⁶ Various statutes recognize that the attorney general is the chief legal officer for all departments and agencies. However, in an uneven pattern over the years, exceptions have been permitted to this central authority. The independent regulatory commissions, for instance, have some independence (although the degree of independence varies considerably from commission to commission) in their litigation authority.²⁷ While the Justice Department has consistently favored central coordination of litigation, this view has been difficult to maintain in practice. With the relatively small staff of the department and its understandable reluctance to become responsible for routine litigation, there has been a trend toward awarding greater authority and flexibility to the departments and agencies in their legal affairs. With respect to government corporations, though, often their enabling legislation assigns them a legal personality distinct from that of the United States. Most are subject to, and may initiate, civil suits. Government corporations, being agencies of the United States, have their employees come under the limited waiver of immunity provided in the Federal Tort Claims Act (FTCA).²⁸

Distinguished public administrator Harold Seidman notes: "As a body corporate, a government corporation has a separate legal personality distinct from that of the United States. A corporation, therefore, does not enjoy the traditional immunity of the United States from being sued without its consent." Generally, a corporation is provided authority "to determine the character and the necessity for its expenditures, and the manner in which they shall be incurred, allowed and paid." Some corporations may borrow funds through the Federal Financing Bank of the Treasury Department.²⁹

(...continued)

constitutional obligations by simply resorting to the corporate form of organization. *Michael A. Lebron v. National Railroad Passenger Corporation*, 513 U.S. 374 (1995). The AMTRAK Reform and Accountability Act of 1997 (P.L. 105-134; 111 Stat. 2570) removed AMTRAK from the GCCA list of mixed-ownership government corporations.

²⁵ Robert S. Gilmour and Laura S. Jensen, "Reinventing Government Accountability: Public Function, Privatization and the Meaning of 'State Action,'" *Public Administration Review*, vol. 58, May/June 1998, pp. 247-58; Harold J. Sullivan, "Privatization of Public Services: A Growing Threat to Constitutional Rights," *Public Administration Review*, vol. 47, November/December 1987, pp. 461-68; and Ronald C. Moe, "Exploring the Limits of Privatization," *Public Administration Review*, vol. 47, November/December 1987, pp. 453-460.

²⁶ 28 U.S.C. 519: "Except as otherwise authorized by law, the Attorney General shall supervise all litigation to which the United States, an agency, or officer thereof is a party, and shall direct all United States attorneys, assistant United States attorneys, and special attorneys appointed under section 543 of this Title in the discharge of their respect duties."

²⁷ For a discussion of litigation authority being delegated to agencies, see U.S. Congress, Senate, Committee on Governmental Affairs, *Study on Federal Regulations*, 5v. (Washington: GPO, 1974), vol. 5 (Regulatory Organization), pp. 54-67; and U.S. Administrative Conference of the United States, "Multi-Member Independent Regulatory Agencies: A Preliminary Survey of Their Organization" (revised edition), May 21, 1990.

²⁸ The Federal Tort Claims Act defines federal agencies to include "the executive departments, ... independent establishments of the United States, and corporations (other than contractors) primarily acting as instrumentalities or agencies of the United States" (28 U.S.C. 2671).

²⁹ Seidman, *Politics, Position, and Power*, 5th ed., p. 190.



In practical terms, the purpose of permitting corporations to sue and be sued in their own name is to enable a private business to contract with a government corporation under the assurance that if something goes amiss, it can go to court to settle the matter. With a regular government agency, however, a contractual dispute must normally go through a laborious process in the Court of Claims; if the contractor wins, he must wait for an appropriation; the Departments of Justice and Treasury, the Office of Management and Budget (OMB), the President, and both houses of Congress may become involved in the claim. With the government corporation, however, this process is simplified, and when a contractor prevails, he can usually obtain a prompt settlement.

Budget and Finance

The budget process is a useful management tool for planning as well as for maintaining accountability. Regular agencies of the executive branch, with few exceptions, are subject to uniform rules and regulations with respect to the budgets. Both the President and Congress use agency budgets as management tools. Government corporations, on the other hand, are exempt either individually or collectively from many executive branch budgetary regulations.³⁰ These exemptions are predicated, for the most part, on the idea that with the corporate structure, consumers of corporations' products and services, rather than the general taxpayer, are the principal source of revenue.

The GCCA, as amended in 1982 (96 Stat. 1042), provides that each wholly owned government corporation shall prepare and submit to the President a "business-type budget"

in a way and before a date the President prescribes by regulation for the budget program. This budget program shall contain estimates of the financial condition and operation of the corporation for the current and following fiscal years and the condition and results of operations of the last fiscal year. Further, it shall contain statements of financial condition, income and expense, and sources and uses of money, an analysis of surplus and deficit, and additional statements and information to make known the financial condition and operations of the corporation, including estimates of operations by major activities, administrative expenses, borrowings, the amount of U.S. Government capital that will be returned to the Treasury during the fiscal year, and appropriations needed to restore capital impairment." (31 U.S.C. 9104)

The objective of the budget program is to permit the corporation sufficient financial flexibility to carry out its activities. The President, after review and revision, submits these budget programs to Congress with the executive branch budget. Under the Chief Financial Officers Act of 1990 (CFOA), government corporations must submit to Congress annual management reports, which are to include statements of financial position, operations, and cash flows, a reconciliation to the budget report of the government corporation (if applicable), and a statement on internal accounting and administrative control systems.³¹

Traditional agencies of the United States receive the preponderance of their financial support from funds appropriated by Congress. Government corporations, on the other hand, generally receive most, if not all, their funds from users of their services. Thus, the latter relationship has a

³⁰ That said, government corporations are covered by some budgetary laws and regulations (e.g., the Government Performance and Results Act of 1993). See OMB, *Circular No. A-11* (2008), section 200, pp. 2-3.

³¹ P.L. 101-576; 104 Stat. 2854; 31 U.S.C. 9106.



2135

business character in which it is the obligation of the corporate body to provide services as long as the buyers are willing to pay. This being the case, revenues, expenditures, and even personnel will tend to fluctuate according to consumer demand.

Many Members of Congress feel somewhat uneasy with broad, "business type budgets," also referred to as "budget programs." To be sure, Congress can alter these budget programs and can limit the use of corporate funds for any purpose, but this option is seldom employed. Faced with complex projections and agencies with little direct budgetary impact, Members understandably give corporate bodies marginal attention. As a general assessment, the corporations come under comparatively little congressional scrutiny, except when there is some political or financial threat evident. As Seidman notes, "In essence, the business-type budget provides for a qualitative rather than a quantitative review of proposed corporate expenses."³²

Until 1975, GAO was responsible under the GCCA for performing annual financial audits of government corporations. At the request of GAO, the GCCA was amended to provide for audits of the financial transactions of wholly owned corporations at least once every three years, rather than annual audits. In 1990, as part of the CFOA, GAO's recommendation that government corporations be subject once again to annual audits was accepted. Henceforth, however, the audit is to be conducted by the corporation's inspector general "or by an independent external auditor, as determined by the inspector general or, if there is no inspector general, the head of the corporation," according to accepted government auditing standards.³³ The Comptroller General, however, continues to be authorized to review the financial statements of government corporations.

Location and Governance

The location, structure, and governance of government corporations varies greatly. Corporations have been located in executive departments (e.g., the St. Lawrence Seaway Development Corporation in the Department of Transportation), or assigned independent status (e.g., the Export-Import Bank). Government corporations have been structured so that they are but financial entities whose employees are actually employees of the parent agency (e.g., the Federal Financing Bank in the Department of the Treasury and the Commodity Credit Corporation in the Department of Agriculture).

There is no one form of governance necessarily associated with government corporations. Whether a government corporation is best managed by a full-time board (e.g., TVA, formerly),³⁴ a chief executive officer selected by a part-time board and responsible to it (e.g., TVA currently), a part-time board consisting of Cabinet-level officials of other agencies (e.g., Pension Benefit Guaranty Corporation),³⁵ a mixed board of governmental and private appointees (e.g., Overseas

³² Seidman, *Politics, Position, and Power*, p. 192.

³³ P.L. 101-576, Secs. 305-306; 104 Stat. 2853; 31 U.S.C. 9105.

³⁴ In 2004, P.L. 108-447, Div. C, Sec. 601 changed TVA's three-member, full-time board to a nine-member, part-time board.

³⁵ Cabinet secretaries placed on corporate boards, or any boards for that matter, rarely attend such meetings, sending subordinates instead to protect departmental interests. For approval of this process, see U.S. Department of Justice, 6 Op. Off. Legal Counsel 257, *Delegation of Cabinet Members' Functions as Ex-Officio Members of the Board of Directors of the Solar Energy and Energy Conservation Bank* (1982). The Pension Benefit Guaranty Corporation (PBGC), an agency within the Department of Labor, provides evidence of the problems that some analysts contend are associated with boards of directors that include officials of other departments. The board of directors of the PBGC has (continued...)



Private Investment Corporation), or a single administrator responsible to a department secretary, and ultimately to the President (e.g., Government National Mortgage Association, "Ginnie Mae"), is an open question. There are positives and negatives to the various options for corporate governance.

A board of directors is the trademark of a government corporation, according to many lawmakers and attorneys. Marshall Dimock, an academic writing in 1949, argued that a board of directors was considered an essential element for an "authentic" government corporation. "Being a separate and distinct entity, headed by its own board of directors, the corporation is inherently better able to succeed than the ordinary department of government."³⁶

A few years later, Harold Seidman challenged the view that a board of directors was an essential and necessarily desirable element for a government corporation. Dimock's view, he asserted, was based on an inappropriate borrowing of state practice by the federal government. State incorporation laws require boards of directors for private corporations to insure representation where ownership is held by more than one party. In government corporations, under this reasoning, because ownership resides in the government alone, there is no inherent need for a board of directors.³⁷ Government corporations, Seidman pointed out, have existed and operated without boards of directors. A board of directors may well be found advisable and useful under some circumstances, but, Seidman said, it is not the *sine qua non* of a government corporation.³⁸

Whether or not a board of directors is essential or desirable for a government corporation, the fact is that all but two federal government corporations presently have boards of directors. The two exceptions are Ginnie Mae and the St. Lawrence Seaway Development Corporation. In a study published in 1981, the National Academy of Public Administration was critical of boards of directors in general:

We believe that this arrangement, borrowed from the private corporation model, has more drawbacks than advantages and that in most cases the governing board would be better replaced by an advisory board and the corporation managed by an administrator with full executive powers. A governing board may cut or confuse the normal lines of authority from the President or departmental secretary to the corporation's chief executive officer. With an advisory board, the secretary's authority to give that officer policy instruction is clear, as is the officer's right to report directly to the secretary and to work out any exemptions from or

(...continued)

three members: the Secretary of the Treasury, the Secretary of Commerce, and as chairman, the Secretary of Labor. "Such arrangements," according to the National Academy of Public Administration Report, "inherently cause confusion as to the corporation's status and the role of the Secretary of Labor. To have Cabinet officers serve as directors of a subordinate unit of an executive department other than their own, places him and the head of that department in an anomalous position. Can the Secretaries of the Treasury and Commerce give orders to the Secretary of Labor? On the other hand, are the Secretaries of Treasury and Commerce, when acting as PBGC directors, in any way required in formulating policies to conform to the policies of the Secretary of Labor?" Perhaps because of such anomalies, although the bylaws call for "regular meetings," the board never met between March 1982 and April 1991. National Academy of Public Administration, *Study of the Pension Benefit Guaranty Corporation's Corporate Status* (Washington: NAPA, 1991), pp. 5-6.

³⁶ Marshall E. Dimock, "Government Corporations: A Focus on Policy and Administration," *American Political Science Review*, vol. 43, October 1949, p. 914.

³⁷ Harold Seidman, "The Theory of the Autonomous Government Corporation," *Public Administration Review*, vol. 12, spring 1952, pp. 93-111.

³⁸ *Ibid.*



qualifications of administration or departmental policies and practices which the corporation requires.³⁹

There is little doubt that a board of directors, particularly a part-time, "outsiders" board, is a "buffer" between the corporation's top executive and political officials, including the President. Whether such a buffer is a desirable feature in the overall administrative system, however, is a question subject to debate. Notably, it is also argued that corporation board appointments are patronage plums for the White House since the jobs are not generally demanding.

The effectiveness and utility of boards is dependent upon a number of factors: the coherency of the enabling legislation, the conceptual integrity and soundness of the program itself, and the number and quality of membership. Large boards (comprising more than 12 members), for instance, may experience difficulty in making decisions. The play of internal factors, such as the size of the board, the primary loyalties of board members (whether to the corporation or to an outside constituency group), and the relationship of the board to the corporate management all also have their place in the managerial equation.

Oversight

There is, at present, little central management agency oversight or supervision of government corporations as a category of agency in the executive branch. Nor is there any central unit charged with designing government corporations from the perspective of presidential or central management interests.⁴⁰ Government corporations today are largely perceived as discrete entities, each with its own political and administrative requirements, and each with its own route and degree of political accountability. Individual corporations come under scrutiny from time to time by OMB and Congress, or more precisely, a congressional committee responsible for oversight. More often than not, the immediate impetus for the oversight follows from indications that a corporation is operating at financial risk or there is an appearance of wrongdoing.

The current absence of systematic oversight of corporations as a class runs counter to the intentions of the sponsors of the GCCA. The Bureau of the Budget (BOB), predecessor organization to OMB, was instrumental in the passage of the GCCA, and created a separate office to oversee the formation, and monitor the operation, of government corporations on behalf of the President. During the 1960s, this specialized staff function atrophied until at some point in the 1970s it is fair to conclude that there was little remaining central executive staff capacity to provide information, expert advice, or oversight of government corporations or to develop and implement consistent policies governing their formation, authorities, and operations.⁴¹

³⁹ National Academy of Public Administration, *NAPA Report on Government Corporations*, 2 vols. (Washington: NAPA, 1981), I, pp. 31-32.

⁴⁰ See, for example, Alan Dean, Dwight Ink, and Harold Seidman, "OMB's 'M' Fading Away," *Government Executive*, vol. 26, June 1994, pp. 62-64; and Ronald C. Moe, "At Risk: The President's Role as Chief Manager," in James Pfiffner, ed., *The Managerial Presidency*, 2nd ed. (Lawrence, KS: University Press of Kansas, 1999), pp. 265-284.

⁴¹ BOB ceased to monitor government corporations and enterprises during the 1960s. Charles Bingman, speaking to a 1978 conference on public enterprises, noted that he had been the last person in the BOB to undertake this monitoring role. He stated that he ceased the monitoring when it became apparent that the leadership of the agency was no longer interested in this role. In his view, both the executive branch and Congress had effectively abandoned the intent of the GCCA. *Proceedings, Research Conference in Public Enterprises*, June 1, 1978 (Charlottesville, VA: Federal Executive Institute, 1978), p. 18.



Government corporations are not considered by OMB to be a category of organization to be supervised collectively. OMB, in support of its position, contends:

The responsibility for oversight of government corporations was not changed by the OMB 2000 reorganization. That is, government corporations will continue to be reviewed by the Resource Management Office (RMO) which has responsibility for the functional area most closely associated with the corporation's mission.... OMB does not review government corporations separately from other government organizations that perform similar functions.⁴²

The executive branch treatment of management responsibilities respecting government corporations as a class of organization tends to place additional burdens on Congress and its committees to determine if the corporations are respecting the provisions of the general management laws (e.g., the National Environmental Protection Act, 42 U.S.C. 4321).

One corollary of limited central management oversight of government corporations is the lack of answers to fundamental issues regarding when and how government corporations ought to be created and utilized. There are at least two schools of thought respecting the proper use of the government corporation option relating to its structure, authority, and financial systems. One school holds that government corporations, including agencies called corporations but which do not perform commercial activities, should be encouraged, provided maximum policy and financial autonomy, and be subject to such oversight as is appropriate for other agencies and instrumentalities in the same policy field. The legal responsibilities of the corporation should be located in its enabling statute.

The position of the second school is that government corporations should be established only when appropriate criteria and standards, developed by a central management agency, are met. Such standards should be reflected in a national incorporation law and apply to all proposed and functioning corporate bodies properly defined. Government corporations should be considered to be part of the executive branch, but with recognition of their distinctive needs and oversight requirements as a category of institutions.

Government Corporations as Transition Organizations

The government corporation concept may be considered a useful alternative to privatization of some agency, or it may be employed as a transition step toward eventual full privatization.⁴³ Our interest here is limited to the corporation as a transition option. The principal utility of the transitional government corporation is that it can demonstrate marketability and asset value, critical elements in any successful privatization venture.

⁴² Letter dated May 24, 1994, from OMB Director Leon Panetta to Senators David Pryor and Carl Levin of the Senate Governmental Affairs Committee, p. 4.

⁴³ In this report, privatization is defined narrowly to embrace only those actions resulting in ultimate full divestiture. The term privatization has been defined and interpreted in different ways. See CRS Report RL33777, *Privatization and the Federal Government: An Introduction*, by Kevin R. Kosar.



An early successful example of the government corporation concept as a transition vehicle involved Conrail. Conrail was created by Congress as a government corporation in 1976 from the remnants of seven private, bankrupt railroads. It took some 10 years and an investment of \$8 billion by the federal government to bring Conrail up to industry standards before entertaining a reasonable expectation that the railroad would be attractive to private investors.⁴⁴ The federal government received approximately \$2 billion from the sale, but the real payoff was that the northeastern region of the country was once again provided a viable freight rail system. The transition period as a government corporation was necessary to develop a record as a potentially profit-making venture prior to a successful privatization (divestiture) effort.⁴⁵

More recently, the U.S. Enrichment Corporation (USEC) has completed its transitional process toward full privatization, with mixed results. The USEC, until 1993 a regular agency in the Department of Energy (DOE), operated uranium enrichment plants in Kentucky and Ohio. In the 1950s, the plants produced highly enriched uranium (HEU) for defense purposes. Times changed and the United States was successfully challenged by new international entrants into the market.

The Energy Policy Act of 1992 (P.L. 102-486; 106 Stat. 2776) established the U.S. Enrichment Corporation as a wholly owned government corporation. The general intent of the legislation was to "privatize" the two plants and let them compete in the world market. A privatization plan was delivered by the USEC to the President and Congress in 1995. The plan suggested that there were two primary methods of corporate divestiture: an initial public offering (IPO) and a merger or acquisition with another corporation or group of corporations.⁴⁶ After considerable discussion, the IPO option was selected, as it had been with Conrail.

The IPO of stock was completed on July 28, 1998, and raised an estimated \$1.9 billion for the federal government. The USEC transition process highlighted, however, one of the perennial problems in privatization efforts. Congress may intend a corporation to be private, but it also may want the corporation to continue to be involved in public policy implementation. In this instance, Congress wanted the corporation to participate in implementing a foreign policy objective, which was to purchase at above market rates a substantial amount of Russian enriched uranium otherwise destined for Russian weapons. Under the HEU agreement, the USEC received enriched uranium from Russian nuclear weapons and, in addition to its payment for the material, returned an equivalent amount of natural (unenriched) uranium to Russia to sell on the world market. This arrangement, from the corporation's perspective, was not viable and in October 1999, the USEC solicited Congress for "relief."⁴⁷

Another characteristic of a private corporation, legally organized and defined as such, is the right to cancel a program or withdraw from an activity if it is not deemed in the fiduciary interests of

⁴⁴ National Academy of Public Administration, *Conrail and the Uranium Enrichment Corporation: A Comparison*, by Alan Dean (Washington: NAPA, 1989), p. 5.

⁴⁵ It should not be forgotten that before Conrail could be privatized, it first had to be nationalized. Seven private railroad corporations went bankrupt and it required the federal government to resolve bankruptcy issues, establish a long-term, comprehensive commercial rail plan, develop corporate management capacity, invest capital funds, renegotiate contracts, and get the whole project functioning in a short period of time. The federal government was successful and only then was the private sector interested in "buying" the railroad.

⁴⁶ Peter Passell, "The Sticky Side of Privatization: Sale of U.S. Nuclear Fuel Plants Raises Host of Conflicts," *New York Times*, August 31, 1997, p. 29.

⁴⁷ Martha M. Hamilton, "Uranium Company Seeks Federal Aid: Privatized USEC Warns of Losses," *Washington Post*, October 30, 1999, p. E8.



the shareholders. To the consternation of DOE officials, such a decision was reached recently by the USEC board of directors. One of the assets transferred from the DOE to the USEC in the divestiture was the right to commercialize a new enrichment technology called "atomic vapor laser and isotope separation" (AVLIS), a technology in which DOE had invested over \$2 billion. On June 9, 1999, the board of directors of the USEC determined that AVLIS was not commercially viable and canceled the program. The board's decision made manifest the fiduciary distinctions between a government and private corporation.⁴⁸

The federal government may, for whatever reason, choose to directly divest itself of a commercial activity or asset and not follow the transition corporation option to establish its value in the market. Although a transition corporation had been recommended by an outside study,⁴⁹ the Department of Energy determined to directly divest itself of the California fields of the Elk Hills National Petroleum Reserves.⁵⁰

Conclusion

The government corporation form of federal agency is a useful option to consider when establishing or reorganizing an agency with revenue potential. It is helpful to bear in mind, however, that there is no general provision in law that defines what, precisely, government corporations are. When writing the GCCA, Congress and the executive branch simply viewed the various corporate bodies, and defined them by enumeration, rather than by required characteristics. This relatively unstructured approach has meant that some corporate bodies (e.g., the U.S. Postal Service) are not included in the GCCA enumeration, whereas other bodies, arguably non-corporate in function and authority (e.g., the Corporation for National and Community Service) are listed.

There is little managerial oversight at present of government corporations as an institutional category by either the President or Congress. What oversight there is tends to be corporation-specific. In the case of Congress, corporations are assigned to committees of subject-matter jurisdiction. A GAO report recommended that corporations properly require both subject matter and management oversight, and that the GCCA should be reconstituted to establish in law the characteristics of various types of corporate bodies.⁵¹

Government corporations may be viewed as permanent agencies to perform a continuing governmental function (e.g., the Federal Deposit Insurance Corporation); a temporary agency

⁴⁸ Daniel Guttman, "The United States Enrichment Corporation: A Failing Privatization," *Asian Journal of Public Administration*, vol. 23, December 2001, pp. 247-272.

⁴⁹ National Academy of Public Administration, *Restructuring the Naval Petroleum and Oil Shale Reserves* (Washington: NAPA, 1994).

⁵⁰ The problems associated with estimating the value, both to the federal government and to the would-be buyer, are discussed in Elizabeth Davis, "Once a Teapot in a Tempest, Now Just a Lonely Outpost: Navy Oversees Unwanted Oil Field," *Washington Post*, August 14, 1998, p. A23. The attractiveness of the "unwanted" Naval Petroleum Reserve increased with the rise in the world price of oil, and the Reserve was sold outright by the Department of Energy in February 1999 to Occidental Petroleum for \$3.65 billion. Susan Klann, "U.S. Oil Reserve Sale Sets Record," *Denver Post*, March 2, 1999, p. C2; and Thomas H. Stanton, "Lessons Learned: Obtaining Value from Federal Asset Sales," *Public Budgeting and Finance*, vol. 43, spring 2003, pp. 22-44.

⁵¹ U.S. General Accounting Office, *Congress Should Consider Revising Basic Corporate Controls Laws*, GAO/PAD-83-3 (Washington: GAO, 1983).



2141

(e.g., the Pennsylvania Avenue Development Corporation); or a transition agency to facilitate the process whereby a governmental agency or program is divested and transferred to the private sector (e.g., the U.S. Enrichment Corporation). These options indicate the flexibility of the government corporation concept and may provide models for extending the corporate organization to other appropriations-funded agencies (e.g., the U.S. Patent and Trademark Office and the U.S. Mint). Both the latter agencies and their programs meet the basic criteria for a government corporation and suggestions to this effect have been made.

The future of government corporations as a category of federal organization appears generally bright although they are not widely understood in executive management circles. The need for the executive branch and Congress to develop new organizational structures that take into account both the public law requirements of governmental status, and the flexibility that properly accompanies corporate bodies dependent upon revenues for services may increase.⁵² The managerial quality of the law establishing a corporation, may be a critical variable in determining the success or failure of that enterprise. If the conceptual basis of the law establishing a corporation or economic assumptions therein are faulty, as was allegedly the case with the Synthetic Fuels Corporation in the late 1970s, a government corporation may become a liability to the executive branch and face a short tenure.⁵³ On the other hand, if a federal government corporation is designed to conform with public law, governmental management principles, and sound economics, a corporate agency may provide a creative instrument to promote the public policy objectives of elected officials.

Although it has been the purpose of this report to emphasize the distinctive characteristics of federal government corporations, it is important to conclude with a statement of their shared characteristics with other federal agencies. The mission of both regular, appropriations-financed agencies and of government corporations is the same, to implement the laws passed by Congress.

⁵² Most recently, the corporate option was considered, although not adopted, for what became the Transportation Security Administration in the Department of Homeland Security.

⁵³ Ronald C. Moe, "Government Corporations and the Erosion of Accountability: The Case of the Proposed Energy Security Corporation," *Public Administration Review*, vol. 39, November/December 1979, pp. 566-572; and Doug Bandow, "Synfuels, NoWinFuels," *New York Times*, September 1, 1983, p. 25.



Appendix. Federal Government Corporations

1. Commodity Credit Corporation	(15 U.S.C. 714)
2. Export-Import Bank	(12 U.S.C. 635)
3. Federal Crop Insurance Corporation	(7 U.S.C. 1501)
4. Federal Deposit Insurance Corporation	(12 U.S.C. 1811)
5. Federal Financing Bank	(12 U.S.C. 2281)
6. Federal Prison Industries (UNICOR)	(18 U.S.C. 4121)
7. Financing Corporation	(12 U.S.C. 1441)
8. Government National Mortgage Corporation	(12 U.S.C. 1717)
9. National Railroad Passenger Corporation (AMTRAK)	(49 U.S.C. 241)
10. Overseas Private Investment Corporation	(22 U.S.C. 2191)
11. Pension Benefit Guaranty Corporation	(29 U.S.C. 1301)
12. Presidio Trust of San Francisco	(16 U.S.C. 460bb)
13. Resolution Funding Corporation	(12 U.S.C. 1441(b))
14. St. Lawrence Seaway Development Corporation	(33 U.S.C. 981)
15. Tennessee Valley Authority	(16 U.S.C. 831)
16. U.S. Postal Service	(39 U.S.C. 101)
17. Valles Caldera Trust	(16 U.S.C. 698-v4)

Author Contact Information

Kevin R. Kosar
Analyst in American National Government
kkosar@crs.loc.gov, 7-3968

Acknowledgments

This report was originally written by Ronald C. Moe, who retired from CRS.



:Darrell-James: Hill, -:Ohioan- beneficiary-civilian,
-:Executor: DOI-1776-A.D.- :PE-2016-A.D.- covenant,
-:Executor- Procurator: EBA-1933-A.D.-covenant, acting-officer,
-:Executor- Procurator: Ingold-Pinal-2017-A.D.- covenant;
-:Ambassador: Concession-1213-A.D.-covenant¹

:Beverly-Jean: Romero- Hill, -:New-Mexican-beneficiary-civilian,
-:Executor: DOI-1776-A.D.- :PE-2016-A.D.- covenant,
-:Executor: EBA-1933-A.D.-covenant,
-:Executor: Ingold-Pinal-2017-A.D.-covenant²

PO Box 3806, Apache-Junction, Arizona [85117]

:Stephen-Q.: Miller, -:Chairman -Trustee -:USPO-RMN: RE 322 390 840 US
c/o Natasha: Kennedy, -:Clerk- Trustee
135 N. Pinal Street, :Admin.- Complex
Florence, Arizona [85132]

:notice :December-30-2021-A.D. -:45-day-notice -:RE 322 390 840 US , -:Bill of the Particulars – with -:

A) December-16-2021-A.D. -:30-day-notice -:RE 322 390 751 US, -:Bill of the Particulars;
appended: 4 pg.; with -:

B) November-18-2021-A.D. -:15-day-notice -:RE 322 398 344 US, -:Bill of the Particulars;
appended: 4 pg.; with -:

C) November-15- 2021-A.D. -:Notice: Hill- Executors- Procurator- Jurisdiction, et al.- :Render-
Pinal-county-Bill-Remedy to -:Stephen-Q, -:Pinal-County-Arizona-State-Trustee, -:USPO RMN
RE 322 398 361 US is with the Render of the -Pinal-county-Arizona-state-Trustee- Dereliction-
Bill of the Particulars with the remedy of the Ingold-Pinal-2017-A.D.- covenant by the law of the
PE-2016-A.D.- covenant, -:appended -26 pages;

:Demand for the Payment-due-Now!

Without prejudice,

day: December 30, 2021

Darrell James Hill, -:Executor
:Darrell-James: Hill, -:Ohioan- Executor,
-:Executor: DOI-1776-A.D.- :PE-2016-A.D.- covenant,
-:Executor- Procurator: EBA-1933-A.D.-covenant,
-:Executor- Procurator: Ingold-Pinal-2017-A.D.- covenant;

day: December 30, 2021

Beverly Jean Romero Hill, -:New Mexican, -:Executor
:Beverly-Jean: Romero- Hill, -:New-Mexican- Executor,
-:Executor: DOI-1776-A.D.- :PE-2016-A.D.- covenant,
-:Executor: EBA-1933-A.D.-covenant,
-:Executor in -procurator: Ingold-Pinal-2017-A.D.-covenant

cc: Mark: Lamb, -:Sheriff -:USPO-CMN: 7008 1300 0002 2256 4620
971 Jason-Lopez- Circle, Bldg.-C
Florence, Arizona [85132]

1 :Darrell-James: Hill, -:Ohioan- beneficiary-civilian, Executor: DOI-1776-A.D.- :PE-2016-A.D.-
covenant; -:Executor- Procurator: EBA-1933-A.D.- covenant, acting-officer; -:Executor-
Procurator: Ingold-Pinal-2017-A.D.- covenant; -:Ambassador: Concession-1213-A.D.-covenant
means: Gila-County-Recorder-Doc.#: 2021-016195, p. 2 , - ':PE-2017-A.D.- non-consent to -:DOI-
1776-A.D.- deprivation of unalienable-rights by the man- Pinal-County-Arizona-State-Office-Trustee-
Dereliction of Loyalty-Oath of Office; :Hill-Executor-Procurator: Ingold-Pinal-2017-Covenant:
Executor-Procurator: Darrell-James: Hill, -:Ohioan- Beneficiary'.

2 :Beverly-Jean: Romero- Hill, -:New-Mexican-beneficiary-civilian, -:Executor: DOI-1776-
A.D.- :PE-2016-A.D.- covenant, -:Executor: EBA-1933-A.D.-covenant, -:Executor: Ingold-Pinal-
2017-A.D.-covenant means: Gila-County-Recorder-Doc.#: 2021-016195, p. 2, - ':PE-2017-A.D.-
non-consent to -:DOI-1776-A.D.- deprivation of unalienable-rights by the man- Pinal-County-Arizona-
State-Office-Trustee-Dereliction of Loyalty-Oath of Office; Hill-Executor-Procurator: Ingold-Pinal-
2017-Covenant: Executor in -:procurator: Beverly-Jean: Romero- Hill, -:New-Mexican-Beneficiary'.

:notice :December-30-2021-A.D. -:45-day-notice -:RE 322 390 840 US , -:Bill of the Particulars – with -:

2022-011769 MISC Page: 2153 of 2782

09/26/2022 03:35:37 PM Receipt #: 22-9381

Rec Fee: \$30.00 Darrell James Hill
Gila County, Az, Sadie Jo Bingham, Recorder





APACHE JUNCTION
151 W SUPERSTITION BLVD
APACHE JUNCTION, AZ 85120-9998
(800)275-8777

12/30/2021 10:35 AM

Product	Qty	Unit Price	Price
First-Class Mail® Large Envelope	1		\$2.56
Florence, AZ 85132 Weight: 0 lb 7.20 oz Estimated Delivery Date Mon 01/03/2022 Registered Mail® Amount: \$21.00 Tracking #: RE322390840US Return Receipt Tracking #: 9590 9402 4718 8344 9618 32			
			\$14.35
			\$3.05
Total			\$19.96
First-Class Mail® Letter	1		\$0.78
Globe, AZ 85501 Weight: 0 lb 1.40 oz Registered Mail® Amount: \$21.00 Tracking #: RE322398358US Return Receipt Tracking #: 9590 9402 4718 8344 9594 19			
			\$14.35
			\$3.05
Total			\$18.18
Grand Total:			\$38.14
Cash			\$50.00
Change			\$11.86

Registered No. RE322390840US

Date Stamp

Reg. Fee	\$2.56	
Handling Charge	\$14.35	Return Receipt
Postage	\$3.05	Restricted Delivery
Received by	\$0.00	
\$19.96		



Customer Must Declare Full Value \$21.00 12/30/2021 Domestic parcels up to \$500 are included by default with international indemnity coverage (See Reverse)

OFFICIAL USE

FROM: Daniel James Hill, Executor
Beverly Jean Romab-Hill, Executor
c/o P.O. Box 3806
Apache Junction, Arizona 85117

TO: Stephen Q. Miller, Chairman-Trustee
Natasia Kennedy-Clerk-Trustee
135 N Pinal Street, Admin
Florence, Arizona 85132

PS Form 3806, Receipt for Registered Mail Copy 1 - Customer
May 2007 (7530-02-000-9051) (See Information on Reverse)
For domestic delivery information, visit our website at www.usps.com®

COMPLETE THIS SECTION ON DELIVERY

A. Signature Agent Addressee
 B. Received by (Printed Name) Laura Loreano
 C. Date of Delivery 1/3/2022
 D. Is delivery address different from item 1? Yes No
 If YES, enter delivery address below:

COMPLETE THIS SECTION

1. Article Addressed to:
 Stephen Q. Miller, Chairman Trustee
 c/o Natasia Kennedy-Clerk-Trustee
 135 N Pinal Street, Admin
 Florence, Arizona 85132

2. Article Number (Transfer from service label)
 9590 9402 4718 8344 9618 32
 RE 322 390 840 US

3. Service Type
 Adult Signature
 Adult Signature Restricted Delivery
 Certified Mail
 Collect on Delivery
 Collect on Delivery Restricted Delivery
 Insured Mail
 Insured Mail Restricted Delivery (over \$500)

4. Priority Mail Express®
 Registered Mail
 Registered Mail Restricted Delivery
 Return Receipt for Merchandise
 Signature Confirmation™
 Signature Confirmation Restricted Delivery

PS Form 3811, July 2015 PSN 7530-02-000-8055N

2022-011769 MISC Page: 2154 of 2782
 09/25/2022 03:35:37 PM Receipt #: 22-9381
 Rec Fee: \$30.00 Darrell James Hill
 Gila County, AZ, Sadie Jo Bingham, Recorder

USPS Tracking®

[FAQs >](#)

[Track Another Package +](#)

Tracking Number: RE322390840US

[Remove X](#)

Your item was delivered at 3:40 pm on January 3, 2022 in FLORENCE, AZ 85132.

 **Delivered**

January 3, 2022 at 3:40 pm
FLORENCE, AZ 85132

[Get Updates v](#)

[Text & Email Updates](#)

[Tracking History](#)

2/1/22

January 3, 2022, 3:40 pm

Delivered

FLORENCE, AZ 85132

Your item was delivered at 3:40 pm on January 3, 2022 in FLORENCE, AZ 85132.

[Feedback](#)

2022-011769 MISC Page: 2155 of 2782
 09/25/2022 03:35:37 PM Receipt #: 22-9981
 Rec Fee: \$30.00 Darrell James Hill
 Gila County, Az, Sadie Jo Bingham, Recorder



December 30, 2021, 11:56 pm

Departed USPS Facility

PHOENIX, AZ 85026

December 30, 2021, 11:55 pm

Arrived at USPS Facility

PHOENIX, AZ 85026

December 30, 2021, 4:41 pm

Departed Post Office

APACHE JUNCTION, AZ 85120

December 30, 2021, 10:29 am

USPS in possession of item

APACHE JUNCTION, AZ 85120

Feedback

Product Information



See Less ^

Can't find what you're looking for?

Go to our FAQs section to find answers to your tracking questions.

2022-011769 MISC Page: 2156 of 2782
09/26/2022 03:35:37 PM Receipt #: 22-9381
Rec Fee: \$30.00 Darrell James Hill
Gila County, Az, Sadie Jo Bingham, Recorder



:Darrell-James: Hill, -:Ohioan- beneficiary-civilian,
-:Executor: DOI-1776-A.D.- :PE-2016-A.D.- covenant,
-:Executor- Procurator: EBA-1933-A.D.-covenant, acting-officer,
-:Executor- Procurator: Ingold-Pinal-2017-A.D.- covenant;
-:Ambassador: Concession-1213-A.D.-covenant¹
:Beverly-Jean: Romero- Hill, -:New-Mexican-beneficiary-civilian,
-:Executor: DOI-1776-A.D.- :PE-2016-A.D.- covenant,
-:Executor: EBA-1933-A.D.-covenant,
-:Executor: Ingold-Pinal-2017-A.D.-covenant²
PO Box 3806, Apache-Junction, Arizona [85117]

:Stephen-Q.: Miller, -:Chairman -Trustee -:USPO-RMN: RE 322 390 751 US
c/o Natasha: Kennedy, -:Clerk- Trustee
135 N. Pinal Street, :Admin.- Complex
Florence, Arizona [85132]

:December-16-2021-A.D. -:30-day-notice -

Re: November-18-2021-A.D. -:PE-2017-A.D. -:Non-consent to -:DOI-1776-A.D.-
deprivations-of-unalienable-rights by the man- Pinal-County-Arizona-State-Office-Trustee-
Dereliction of -:Loyalty-Oath-of-Office; :Hill- Executors- Procurator: Ingold-Pinal-2017-
Covenant: USPO RMN RE 322 398 344 US; with:

Re: November-15- 2021-A.D. -:Notice: Hill- Executors- Procurator- Jurisdiction, et
al.- :Render- Pinal-county-Bill-Remedyto -:Stephen-Q, -:Pinal-County-Arizona-State-Trustee,
-:USPO RMN RE 322 398 361 US is with the Render of the -Pinal-county-Arizona-state-
Trustee- Dereliction- Bill of the Particulars for the remedy by the law of the PE-2016-A.D.-
covenant³, -:appended -30 pages; -

:Demand for the Payment-due-Now!

Without prejudice,

day: December 16, 2021

Darrell James Hill: Executor

:Darrell-James: Hill, -:Ohioan- Executor,
-:Executor: DOI-1776-A.D.- :PE-2016-A.D.- covenant,
-:Executor- Procurator: EBA-1933-A.D.-covenant,
-:Executor- Procurator: Ingold-Pinal-2017-A.D.- covenant;

day: December 16, 2021

Beverly Jean Romero Hill: Executor

:Beverly-Jean: Romero- Hill, -:New-Mexican- Executor,
-:Executor: DOI-1776-A.D.- :PE-2016-A.D.- covenant,
-:Executor: EBA-1933-A.D.-covenant,
-:Executor in -procurator: Ingold-Pinal-2017-A.D.-covenant

cc: Mark: Lamb, -:Sheriff -:USPO-CMN: 7008 1300 0002 2256 4620
971 Jason-Lopez- Circle, Bldg.-C
Florence, Arizona [85132]

1 :Darrell-James: Hill, -:Ohioan- beneficiary-civilian, Executor: DOI-1776-A.D.- :PE-2016-A.D.-
covenant; -:Executor- Procurator: EBA-1933-A.D.- covenant, acting-officer; -:Executor-
Procurator: Ingold-Pinal-2017-A.D.- covenant; -:Ambassador: Concession-1213-A.D.-covenant
means: Gila-County-Recorder-Doc.#: 2021-016195, p. 2, - :PE-2017-A.D.- non-consent to -:DOI-
1776-A.D.- deprivation of unalienable-rights by the man- Pinal-County-Arizona-State-Office-Trustee-
Dereliction of Loyalty-Oath of Office; :Hill-Executor-Procurator: Ingold-Pinal-2017-Covenant:
Executor-Procurator: Darrell-James: Hill, -:Ohioan- Beneficiary'.

2 :Beverly-Jean: Romero- Hill, -:New-Mexican-beneficiary-civilian, -:Executor: DOI-1776-
A.D.- :PE-2016-A.D.- covenant, -:Executor: EBA-1933-A.D.-covenant, -:Executor: Ingold-Pinal-
2017-A.D.-covenant means: Gila-County-Recorder-Doc.#: 2021-016195, p. 2, - :PE-2017-A.D.-
non-consent to -:DOI-1776-A.D.- deprivation of unalienable-rights by the man- Pinal-County-Arizona-
State-Office-Trustee-Dereliction of Loyalty-Oath of Office; Hill-Executor-Procurator: Ingold-Pinal-
2017-Covenant: Executor in -:procurator: Beverly-Jean: Romero- Hill, -:New-Mexican-Beneficiary'.

3 :Ibid. p. 3, - :Proof-of-Claim - D.1/1, pp. 533 - .



2148



APACHE JUNCTION
151 W SUPERSTITION BLVD
APACHE JUNCTION, AZ 85120-9998
(800)275-8777

12/16/2021 01:59 PM

Product	Qty	Unit Price	Price
First-Class Mail® Large Envelope	1		\$2.36
Florence, AZ 85132 Weight: 0 lb 6.50 oz Estimated Delivery Date Mon 12/20/2021			
Registered Mail®			\$22.05
Amount: \$2,100.00 Tracking #: RE322390751US			
Total			\$24.41
Grand Total:			\$24.41
Cash			\$25.00
Change			-\$0.59

USPS is experiencing unprecedented volume increases and limited employee availability due to the impacts of COVID-19. We appreciate your patience.

Registered No. RE 322390751US

Date Stamp: APACHE JUNCTION, AZ 85120
DEC 16 2021

Reg. Fee	\$2.36	
Handling Charge	\$22.05	Return Receipt
Postage	\$0.00	Restricted Delivery
Received by	\$0.00	
\$24.41		

Customer Must Declare Full Value: \$2,100.00
Domestic insurance up to \$5,000 is included. International indemnity is limited. (See Reverse)

OFFICIAL USE

APACHE JUNCTION, AZ 85120

FROM: Darrell James Hill, Beneficiary Chairman
P.O. Box 3806
Apache Junction, Arizona [85117]

TO: Stephen D. Miller - Chairman - Trustee
% Nicholas Kennedy - Clerk - Trustee
135N Pinal Street, Admin-Complex
Florence, Arizona [85132]

PS Form 3806, Receipt for Registered Mail Copy 1 - Customer
May 2007 (7530-02-000-9051) (See Information on Reverse)
For domestic delivery information, visit our website at www.usps.com®

Official

2149

2022-011769 MISC Page: 2158 of 2782
09/26/2022 03:35:37 PM Receipt #: 22-9381
Rec Fee: \$30.00 Darrell James Hill
Gila County, Az, Sadie Jo Bingham, Recorder



USPS Tracking®

[FAQs >](#)

Track Another Package +

Tracking Number: RE322390751US

Remove X

Your item was picked up at the post office at 3:15 pm on December 17, 2021 in FLORENCE, AZ 85132.

Delivered, Individual Picked Up at Post Office

December 17, 2021 at 3:15 pm
FLORENCE, AZ 85132

Feedback

Get Updates ▾

Text & Email Updates ▾

Tracking History ▲

December 17, 2021, 3:15 pm
Delivered, Individual Picked Up at Post Office
FLORENCE, AZ 85132

Your item was picked up at the post office at 3:15 pm on December 17, 2021 in FLORENCE, AZ 85132.

2022-011769 MISC Page: 2159 of 2782
09/26/2022 03:35:37 PM Receipt #: 22-9381
Rec Fee: \$30.00 Darrell James Hill
Gila County, Az, Sadie Jo Bingham, Recorder



December 17, 2021, 8:14 am

Available for Pickup

FLORENCE, AZ 85132

December 17, 2021, 8:07 am

Arrived at Post Office

FLORENCE, AZ 85132

December 17, 2021, 12:33 am

Departed USPS Facility

PHOENIX, AZ 85026

December 17, 2021, 12:33 am

Arrived at USPS Facility

PHOENIX, AZ 85026

December 16, 2021, 4:15 pm

Departed Post Office

APACHE JUNCTION, AZ 85120

December 16, 2021, 1:57 pm

USPS in possession of item

APACHE JUNCTION, AZ 85120

Feedback

2151

Product Information 

See Less 

2022-011769 MISC Page: 2160 of 2782
09/26/2022 03:35:37 PM Receipt #: 22-9381
Rec Fee: \$30.00 Darrell James Hill
Gila County, Az, Sadie Jo Bingham, Recorder



:Darrell-James: Hill, -:Ohioan,
:-beneficiary,-:Executor: PE-2016-A.D.
PO Box 3806.
Apache Junction, Arizona [85117];
and,
:Beverly-Jean: Romero- Hill, -:New- Mexican,
:-beneficiary, -:Executor: PE-2016-A.D.
PO Box 3806
Apache Junction, Arizona [85117], **~Hill-Executors~**

Arizona-state
Pinal-county

RE: Pinal-county-Arizona -Trustees c/o the man-Jay-Roy: Ingold, -:Indianan -
Executor, -:postmaster for the delivery of the:
:Notice: Hill- Executors- Procurator- Jurisdiction, et al. **:-Render- Pinal-county-Bill-**
Remedy,
:Stephen-Q, -Pinal-county-Arizona-state-Trustee, -:USPO RMN RE 322 398 361
US, **appended: , 19- pages.**

Greetings, Stephen-Q, -:Pinal-county-Arizona-state-Trustee, et al.;

See: the Stephen-Q.-Pinal-notice of status, standing, right and the bill-due-now-paid for
the deprivation-damage-covenant-agreement in the Pinal-Ingold-2017-A.D.- covenant for the
Hill-Executors- beneficiary, -:procurators in the accordance with the Pinal-Ingold-2017-A.D.-
covenant by the law of the PE-2016-A.D. -Hill-Executors- covenant-procuration- agreement. -
:concerning:

Notice: No-presumptive or authorized -jurisdiction under the Pinal-county- Arizona-statute(s),
:Notice: Hill-Executor- Procuration- overstanding :Pinal-county-Arizona- Trustee-Offices, and,
:Notice: Bill of Particulars to the Pinal-county-Trustee- Dereliction: -Payment is demanded.

:Delivery of the document was made to the November 2021, -:Pinal-county v. :man-Jay-
Roy first meeting as the postman.

For the document with the rebuttal of the Pinal-county-offer-presumptions is with the
delivery and receipt to the November 15th, 2021-A.D. -first-meeting to the Superior Court- Pinal-
county-Trustee v. man-Jay-Roy: Ingold, -Indianan- Executor by the man-Jay-Roy: Ingold, -
Indianan- Executor- postal- delivery and notice in the accordance with the procuration, and
delivered to the man-Stephen-Q, -:Pinal-county-Arizona-state-Trustee, -:USPO RMN RE 322
398 361 US by the USPO- RMN RMN RE 322 398 361 US.

:Bill -rendered is with the Payment now-demanded.

:i- man verify that the above is true and correct to the best-ability, and will-state-same onto the
record in the open-court.

Cc: :Mark-Lamb, -:Sheriff- Trustee: USPO CMN 7009 1410 0099 7868 5802

:Without-prejudice,

Darrell-James Hill
:Darrell-James: Hill, -:Ohioan, -:beneficiary, -:Executor;
-:Executor- Procurator: Hill-Executors

:Jurat

:Verified under the oath and autographed before me this **18th** day, :November- 2021- A.D.
:Type of Identification: Arizona-Driver-License

Cheryl Smith
:Notary-Public

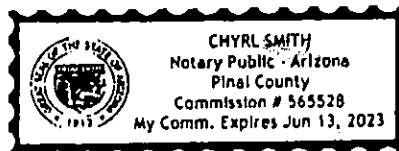

The UPS Store #3750
 5301 S Superstition Mountain Dr Ste
 Gold Canyon, AZ 85118-1917
 480-474-9838



APACHE JUNCTION
 151 W SUPERSTITION BLVD
 APACHE JUNCTION, AZ 85120-9998
 (800)275-8777

Terminal.....: P033750A Date.: 11/18/2021
 Employee.....: 118382 Time.: 12:51 PM

11/18/2021 01:20 PM

ITEM NAME	QTY	PRICE	TOTAL
Notary	1 @	\$10.00	\$10.00
Tax			\$0.00
8.5x11 Copies	2 @	\$0.11	\$0.22
Tax			\$0.01
Subtotal			\$10.22
Shipping/Other Charges			\$0.00
Total tax			\$0.01
Total			\$10.23
Cash			\$20.00
Change back (Cash)			(\$9.77)

Product	Qty	Unit Price	Price
First-Class Mail® Large Envelope	1		\$1.96
Florence, AZ 85132 Weight: 0 lb 4.70 oz Estimated Delivery Date Mon 11/22/2021			
Registered Mail®			\$14.35
Amount: \$21.00 Tracking #: RE322398344US			
Total			\$16.31
Grand Total:			\$16.31
Cash			\$20.00
Change			-\$9.69

 USPS is experiencing unprecedented volume increases and limited employee availability due to the impacts of COVID-19. We appreciate your patience.

REGISTERED MAIL RECEIPT

Complete items 1, 2, and 3.
 Print your name and address on the reverse so that we can return the card to you.
 Attach this card to the back of the envelope, or on the front if space permits.

1. Addressed to:
 Stephen Q. Miller - Trustee
 135 N. Pinal Street, Florence, Arizona 85132

2. Article Number (Transfer from service label)
 RE 322 398 344 US

3. In delivery address different from item 1? Yes No
 If YES, enter delivery address below:

Service Type:
 Adult Signature
 Adult Signature Restricted Delivery
 Certified Mail
 Certified Mail Restricted Delivery
 Certified Mail Return Receipt for Merchandise
 Collect on Delivery
 Collect on Delivery/Restricted Delivery
 Insured Mail
 Insured Mail Restricted Delivery (over \$500)
 Priority Mail Express
 Registered Mail
 Registered Mail Restricted Delivery
 Return Receipt for Merchandise
 Signature Confirmation
 Signature Confirmation Restricted Delivery

Domestic Return Receipt

Registered No. RE322398344US		Date Stamp
Reg. Fee	\$1.96	0130 19
Handling Charge	\$14.35	Return Receipt
Postage	\$0.00	Restricted Delivery
Received by	\$0.00	
Customer Must Declare		Domestic Insurance up to \$25,000 is included
Full Value	\$21.00	Applied upon the declared value. International indemnity is limited. (See Reverse).

OFFICIAL USE

APACHE JUNCTION, AZ 85120

FROM: Darrell James Hill, Chairman
 PO Box 3806
 Apache Junction, Arizona 85117

TO: Stephen Q. Miller - Trustee
 135 N. Pinal Street, Admin Complex
 Florence, Arizona 85132

PS Form 3806, Receipt for Registered Mail Copy 1 - Customer
 May 2007 (7530-02-000-9051)
 For domestic delivery information, visit our website at www.usps.com

2022-011769 MISC Page: 2162 of 2782
 09/26/2022 03:35:37 PM Receipt #: 22-9381
 Rec Fee: \$30.00 Darrell James Hill
 Gila County, Az, Sadie Jo Bingham, Recorder

2153

USPS Tracking®

[FAQs >](#)

[Track Another Package +](#)

Tracking Number: RE322398344US

[Remove X](#)

Your item was picked up at the post office at 3:42 pm on November 19, 2021 in FLORENCE, AZ 85132.

Delivered, Individual Picked Up at Post Office

November 19, 2021 at 3:42 pm
FLORENCE, AZ 85132

[Get Updates ▾](#)

[Feedback](#)

[Text & Email Updates ▾](#)

[Tracking History ▴](#)

November 19, 2021, 3:42 pm
Delivered, Individual Picked Up at Post Office
FLORENCE, AZ 85132

Your item was picked up at the post office at 3:42 pm on November 19, 2021 in FLORENCE, AZ 85132.

November 19, 2021, 8:13 am
Available for Pickup
FLORENCE, AZ 85132

November 19, 2021, 8:05 am
Arrived at Post Office
FLORENCE, AZ 85132

November 19, 2021, 1:17 am

2022-011769 MISC Page: 2163 of 2782
 09/26/2022 03:35:37 PM Receipt #: 22-9381
 Rec Fee: \$30.00 Darrell James Hill
 Gila County, Az, Sadie Jo Bingham, Recorder



Departed USPS Facility
PHOENIX, AZ 85026

November 19, 2021, 1:16 am
Arrived at USPS Facility
PHOENIX, AZ 85026

November 18, 2021, 4:06 pm
Departed Post Office
APACHE JUNCTION, AZ 85120

November 18, 2021, 1:18 pm
USPS in possession of item
APACHE JUNCTION, AZ 85120

Product Information



Feedback

See Less ^

Can't find what you're looking for?

Go to our FAQs section to find answers to your tracking questions.

FAQs

2155

2022-011769 MISC Page: 2164 of 2782
09/26/2022 03:35:37 PM Receipt #: 22-9381
Rec Fee: \$30.00 Darrell James Hill
Gila County, Az, Sadie Jo Bingham, Recorder



:Notice: No-presumptive or authorized -jurisdiction under the Pinal-county-Arizona- statute
:Notice: Hill-Executor- Procuration- overstanding :Pinal-county-Arizona- Trustee- Offices
:Notice: Bill of Particulars to the Pinal-county-Trustee- Dereliction: -Payment is demanded

:Darrell-James: Hill, -:Ohioan,
:-beneficiary, -:Executor: PE¹-2016-A.D.²
PO Box 3806.

Apache Junction, Arizona [85117];
and,

:Beverly-Jean: Romero- Hill, -:New- Mexican,
:-beneficiary, -:Executor: PE-2016-A.D.³
PO Box 3806

Apache Junction, Arizona [85117], ~Hill-Executors~

Arizona-state
Pinal-county

Re: **Setting of the Presumption of the Hill-Executors' jurisdiction⁴**
**Setting of the Procuration of the Hill-Executors⁵ over the Pinal-county-
Arizona- Trustee⁶**
Render :the -Pinal-county-Arizona-state-Trustee- Dereliction⁷- Bill of the
Particulars for the remedy⁸ by the law of the PE-2016-A.D.-
covenant⁹; -See :Proof-of-Claim: A) :2017-Ingold-Pinal-county- RE
322 399 225 US- covenant -Bill-of-Particulars, et seq. -

Demand for the Payment-due-Now!

Greetings :Jay, et al.- :man- Pinal-county-Arizona -Trustees

:Hill-Executors-

1~ :The -status of the Hill-Executors are of the spirit, soul, and flesh- :i- man¹⁰ creations with
the life: breathing, blood-flowing- habitats on the Arizona-state-country-land as the non-
political-aggregate- people of the united-States-of-America in the accordance with the

1 **:PE means:** political-election, express- covenant with the trustee in the nature of the Foreign-
Sovereign-Immunity-Act ~FSIA~ of 1976-A.D. Public Law 94-583, 90 Stat. 2891.

2 **:Darrell-James: Hill, -:Ohioan-beneficiary, -:Executor means:** See: historical-documents: Superior
constructive Notice and Demand: Permanent Non-Commerical Presumption, and: Constructive Notice
: 'DARRELL JAMES HILL' of 'Darrell-James: of the family Hill', authorized Representative. -:Gila-
county-Arizona-Doc.#: 2017-002378; pp. 1-24, 93-95.

3 **:Beverly-Jean: Romero- Hill, -:New-Mexican-beneficiary, -:Executor -:PE-2016-A.D. means:**
See: historical-documents: Superior constructive Notice and Demand: Permanent Non-Commerical
Presumption, and: Constructive Notice : 'BEVERLY JEAN ROMERO- HILL' of 'Beverly-Jean; of the
family Romero- Hill', authorized Representative. -:Gila-county-Arizona-Doc.#: 2017-002378; pp. 1-4,
26-44, 93-95.

4 **:Setting of the Presumption of the Hill-Executors' jurisdiction means:** Ibid. 1, 2, 3.

5 **:Procuration of the Hill-Executors means:** the- ministrative- overstanding of the Pinal-county-
Arizona-state-Trustee- offices for the purpose of the assurance and ensurance of the absolute-
advantage in the obtenance of the right of the remedy-now-past-due unto the benefit of the Hill-
Executors- beneficiary.

6 **:Setting of the Procuration of the Hill-Executors over the Pinal-county-Arizona- Trustee means:**
2, 3, 4 with the Pinal-county-Arizona-state-Trustee- deprivation of the DOI-1776-A.D.- rights.

7 **:Pinal-county-Arizona-state-Trustee- Dereliction means:** gross-breach of the contract-obligations
with the willful-harm upon the Hill-Executors- beneficiary.

8 **:Render :the -Pinal-county-Arizona-state-Trustee- Dereliction- Bill of the Particulars for the
remedy means;** See :the- Bill of the Particulars for the verified- Proof of the Claim. :Proof-of-Claim: A)
:2017-Ingold-Pinal-county- RE 322 399 225 US- covenant -:Bill of Particulars of the Dishonored -
remedy of the matter-now in the procuration unto the date of the verification of
the resolve of these matters

9 **:covenant means:** express-contract of the verified-chain of the command unto the agreement- in the
fact.

10 **:i- man means:** i~ refers to the Creator, -man~- refers to the species-created to be stewards over the
Creator's- planet and affairs, as the appointed.

:Notice: Hill- Executors- Procurator- Jurisdiction, et al.- :Render- Pinal-county-Bill-Remedy

1 / 9

:Stephen-Q, -:Pinal-county-Arizona-state-Trustee, -:USPO RMN RE 322 398 361 US,

:Mark, -:Pinal-county-Arizona- state-Trustee, -:USPO RMN: RE 322 398 327 US

2022-011769 MISC Page: 2165 of 2782

09/26/2022 03:35:37 PM Receipt #: 22-9381
Rec Fee: \$30.00 Darrell James Hill

Gila County, Az, Sadie Jo Bingham, Recorder



:Notice: No-presumptive or authorized -jurisdiction under the Pinal-county-Arizona- statute
:Notice: Hill-Executor- Procurator- overstanding :Pinal-county-Arizona- Trustee- Offices
:Notice: Bill of Particulars to the Pinal-county-Trustee- Dereliction: -Payment is demanded

Declaration-of-Independence -1776 -DOI-1776-A.D.¹¹- covenant by the law of the PE-2016-A.D- covenants overstanding the Pinal-county-Arizona-state-Trustee, et seq.-derelictions.

2~ :i- man- Darrell-James: Hill, -:Ohioan-beneficiary, -:Executor, and -wife-Beverly-Jean: Romero- Hill, -:New-Mexican-beneficiary, -:Executor, -:Hill-Executors~, are with the status of the living-soul -:united-States-of-America- countryman in the accordance with the PE-2016-A.D- DOI-1776-A.D.- covenants by the law of the PE-2016-A.D.-covenant, -:sovereign-status¹².

:Hill-Executors- EXPRESS- TRUST¹³

:Trustee- Non-Jurisdiction over the Hill-Executors

:Pinal-county-Arizona-state-Trustee -

:No- Presumption of the Pinal-county-Arizona-state-Trustee-Authority over the Hill-Executors

5~ For the presumption-set-forth in the October 2021-A.D.- notice is with no mention of the Trustee-Claim to have derived authority over the Hill-Executors.

The any-Presumption of the Pinal-county-Arizona-state-Trustee- any-adhesion-jurisdiction or authority over-standing of the Hill-Executors is without the merit and denied by the Hill-Executors.

:Limited-diplomatic-immunity of the Hill-Executors

6~ In the accordance with the DOI-1776-A.D.-covenant, et seq. is with the no-obligation for the Hill-Executors -acceptation of the Pinal-county-Arizona-state-Trustee-presumption of the jurisdiction over the Hill-Executors by the law of the PE-2016-A.D.-covenant- agreement.

For the limited-diplomatic-immunity of the Hill-Executors, :Ohioan and New-Mexican-man-kind is within the law of the DOI-1776-A.D.-covenant with the law by the PE-2016-A.D. overstanding the Pinal-county-Arizona-Trustee-oath with the fidelity-obligation.

:No- Claim of the Parens-Patriae -Doctrine over the Hill- Executors

7~ :No-unrevealed or unauthorized-presumption for the enforcement of the Parens-Patriae-Doctrine is permitted except by the express-written authorization by the Hill-Executors.

8~ For the no-further-error in the presumption of the authority or jurisdiction over the Hill-Executors is-now with this covenant-document- express-denial of the Pinal-county-Arizona-state-Trustee-Parens-Patriae-Doctrine with the Hill-Executors over-standing the Pinal-county-Trustee-Arizona-Trustee by the law of the PE-2016-A.D.-covenant-agreement.

:Hill- Executors- Jurisdiction-notice:

:no-authorization for the representation or procuration by the man- Jay-Roy: Ingold, et al.

9~ :the man-Jay-Roy: Ingold is with the no-authorization for the representation or procuration in the regard to or on the behalf of the Hill- Executors: man-Darrell-James: Hill-Ohioan- Executor or -wife -Beverly-Jean: Romero- Hill, -New-Mexican-Executor by the severance of that relationship on or about October- 2019- A.D.;

:no-authorization for the representation or procuration by the PINAL/ Pinal-county-Arizona-Trustee or JAY ROY INGOLD/ Jay-Roy: Ingold- man

10~ :neither the legal-entity- PINAL/ Pinal-county-Arizona-state-Trustee or legal-entity- JAY ROY INGOLD/ Jay-Roy: Ingold- Indianan-Executor is with the authorization or jurisdiction over the any-affairs of the Hill-Executors in the accordance with the DOI-1776-A.D.-covenant by the law of the PE-2016-A.D. -covenant, et al.- agreements; and,

:no-authorization for the representation or procuration

11 :DOI-1776-A.D.- covenant means: Law with the Almighty-God of the man:-covenant-governing-sovereigns, et al.- and: Darrell-James: Hill, -:Ohioan; and Beverly-Jean: Romero- Hill- New-Mexican

12 :sovereign-status means: Ohioan, :New- Mexican is with the DOI-1776-A.D. -state-countryman-status and non-U.S.-Corp.-citizen- status, as the sovereign-status. :DOI-1776-A.D.- covenant means: Law with the Almighty-God of the man:-covenant-governing- sovereigns, et al.- and: Darrell-James: Hill, -:Ohioan; and Beverly-Jean: Romero- Hill- New-Mexican

13 :Hill-Executors- EXPRESS- TRUST means: Ibid. 1, 2, 3.

:Notice: Hill- Executors- Procurator- Jurisdiction, et al.- :Render- Pinal-county-Bill-Remedy

2 / 9

:Stephen-Q, -:Pinal-county-Arizona-state-Trustee, -:USPO RMN RE 322 398 361 US,

:Mark, -:Pinal-county-Arizona- state-Trustee, -:USPO RMN RE 322 398 361 US



2157

:Notice: No-presumptive or authorized -jurisdiction under the Pinal-county-Arizona- statute
:Notice: Hill-Executor- Procurator- overstanding :Pinal-county-Arizona- Trustee- Offices
:Notice: Bill of Particulars to the Pinal-county-Trustee- Dereliction: -Payment is demanded

11- a) :this-lawful-notice gives :no-authorization for the representation or procurator over the any-affairs over the Hill-Executors to the man- Jay-Roy: Ingold -Indianan- beneficiary-Executor or to the Pinal-county-Arizona-state-Trustee; furthermore,

b) :this -notice must be made upon the JAY ROY INGOLD/ man- Jay-Roy: Ingold -Indianan-beneficiary -Executor and PINAL/Pinal-county-Arizona-state BY the PINAL/Pinal-county-Arizona-state-Trustee in the legal-manner.

**:Hill- Executors- Procurators Over-stand
the Pinal-county-Arizona-state-Trustee-offices**

:Notice: Hill-Executors- Procurators Now-Time- Over-stand the Pinal-county-Arizona-state-Trustee- Dereliction

12- :The -Hill- Executors are-now with the procurator and overstanding the Pinal-county-Arizona-state-Trustee in the result- of and accordance- with the 2017-Ingold-Pinal-county- RE 322 399 225 US- covenant¹⁴- Trustee- dereliction of the duty in the accordance with the 2017-Ingold-Pinal-county- RE 322 399 225 US- covenant by the law of the PE-2016-A.D.- Pinal-county- covenant- agreement. see :the- Fee-Schedule- obligation- clause for the remedy of the Pinal-county-Arizona-state-Trustee- derelictions, wrong-doings and Hill-Executors- damage by the law of the PE-2016-A.D.- covenant. **See: the- B) :the -Procurator-Obligation of the Equity-Covenant- RE 322 399 225 US , May 8th, 2017 A.D., appended: pp. 9- 13 of 222 -et al., -:Gila-county-Arizona- Doc.# 011722: Proof of the Claim; clause: Fee-Schedule for the remedy of the Pinal-county-Arizona-state-Trustee- damage upon the Hill-Executor-beneficiary with the law of the Equity-Covenant- RE 322 399 225 US by the law of the PE-2016-A.D.- covenant- agreement.**

:Notice- :appointment: Hill-Executor- Procurator: Darrell-James: Hill -:Ohioan, -:Executor overstanding the Pinal-county-Arizona-state-Trustee- dereliction for the Remedy

13- :Darrell-James: Hill, -:Ohioan-beneficiary, -:Executor is with the acceptance of the appointment of the procurator-obligation by the Hill- Executors.

:Hill- Executors- Procurator-Obligation:

14- For this procurator¹⁵-obligation is with the obtenance of the right to the remedy in the accordance with the law of the DOI-1776-A.D. by the law of the PE-2016-A.D.- covenant overstanding the Pinal-county-Arizona-state-Trustee-Derelictions for the obtenance of the Hill-Executors- beneficiary- remedy in the accordance with the law of the Covenant-RE 322 399 225 US , :May 8th, 2017 A.D. as-verified in the Proof-of-Claim, -:RE 322 404 169 US -Covenant - October 29, 2019 A.D. - see: Gila-county-Arizona- Doc.# 011722- as-relates to the man- Darrell-James: Hill, -:Ohioan -beneficiary, and -wife -Beverly-Jean: Romero- Hill, -:New- Mexican -beneficiary by the law of the PE-2016-A.D.- covenant.

:Procurator- Charge for the Pinal-county-Arizona-state-Trustee- derelict- remedy:

15- :The -Trustee-derelict- goal of the remedy is with the obedience of the Pinal-county-Arizona-state-Trustee-office with the obtenance of the remedy unto the Hill-Executors-

14 :2017-Ingold-Pinal-county- RE 322 399 225 US- covenant means: See: **PROOF OF CLAIM B)** Procurator: Proof of Claim -RE 322 404 169 US - October 29, 2019 A.D. - see: Gila-county-Arizona- Doc.# 011722 Proof-of-Claim.

:Gila-county-Arizona- Doc.# 011722 means: Proof of Claim (USPO-RMN) RE 322 404 169 US - October 29, 2019 A.D. of the Equity-covenant-Agreement (USPO-RMN) RE 322 399 225 US - May 8, 2017 A.D., with the activation at the June 8, 2017 A.D.- hearing with the DOI-1776-A.D.- covenant, et seq. by the law of the Equity-covenant-Agreement (USPO-RMN) RE 322 399 225 US and PE-2016-A.D.- covenant- agreements within the regard of the Hill-Executors- Procurators, -:man- Darrell-James: Hill and -wife- Beverly-Jean: Romero- Hill.

5 :Executor- **:Procurator- Claim means:** Procurator in the accordance with the PE-2016-A.D.- covenant: Covenant- #RE 322 399 225 US , May 8th, 2017 A.D.- Agreement where :in the fact of the matter of the Trustee-Dereliction with the harms upon the man- Darrell-James: Hill, -Ohioan-beneficiary and Beverly-Jean: Romero- Hill, -New-Mexican- beneficiary by the law of the **Gila-county-Arizona- Doc.# 011722 means: Proof of Claim (USPO-RMN) RE 322 404 169 US - October 29, 2019 A.D. of the Equity-covenant-Agreement (USPO-RMN) RE 322 399 225 US - May 8, 2017 A.D., with the activation at the June 8, 2017 A.D.- hearing with the DOI-1776-A.D.- covenant, et seq. by the law of the Equity-covenant-Agreement (USPO-RMN) RE 322 399 225 US and PE-2016-A.D.- covenant- agreements within the regard of the man- Darrell-James: Hill and -wife- Beverly-Jean: Romero- Hill.**

Notice: Hill- Executors- Procurator- Jurisdiction, et al.- :Render- Pinal-county-Bill-Remedy Stephen-Q, -:Pinal-county-Arizona-state-Trustee, -:USPO RMN RE 322 398 361 US, Mark, -:Pinal-county-Arizona- state-Trustee, -:USPO RMN: RE 322 398 327 US ,



:Notice: No-presumptive or authorized -jurisdiction under the Pinal-county-Arizona- statute
:Notice: Hill-Executor- Procurator- overstanding :Pinal-county-Arizona- Trustee- Offices/
:Notice: Bill of Particulars to the Pinal-county-Trustee- Dereliction: -Payment is demanded

beneficiary in the accordance with the (USPO RMN#) RE 322 399 225 US- March 8, 2017 A.D. -
covenant- agreement and the law of the PE-2016-A.D.-covenant by the Hill-Executor-
Procurator. -

16- For this verified-document with the I) Setting of the Presumption of the Hill-Executors' jurisdiction, II) Setting of the Procurator of the Hill-Executors over the Pinal-county-Arizona-state-Trustee-Offices, and III) Render of the -Pinal-county-Arizona-state-Trustee-Dereliction- :Bill of the Particulars for the remedy with the law of the PE-2016-A.D. is with the PINAL/Pinal-county-Arizona-state-Trustee-Offices-express- expedient- ministration for the a) cease and desist all- Trustee-competition, deception, persecution and otherwise dereliction in the every- Pinal-county-Arizona-state-Trustee- office, and b) assertive- Remedy of the Bill of Particulars in the accordance with the (USPO RMN#) RE 322 399 225 US- March 8, 2017 A.D. - covenant- agreement and the law of the PE-2016-A.D.-covenant by the Hill-Executor-
Procurator.

**:Pinal-county-Arizona-state-Trustee- man-oath-takers
for the gain of the Pinal-county-Arizona-state-Trustee- offices**

See: Proof-of-Claim: C) :Notice of Hearing ... CV202000723: 2 pages.

17- **See: Proof-of-Claim: C.** The-Pinal-county-Arizona-state-Trustee- derelictions in the direct-competition with the harms upon the Indianan-beneficiary- Jay-Roy: Ingold, -:Executor, et al. with the commercial-court- color-of-law- proceedings with the direct-contest against the Trustee-obligation are with the harm of the beneficiary-trust by the dishonor of the Pinal-county-Arizona-state-Trustee-office in the discordance with the (USPO RMN#) RE 322 399 225 US- March 8, 2017 A.D.- covenant-agreement and PE-2016-A.D.-covenant- agreement by the law of the (USPO RMN#) RE 322 399 225 US- March 8, 2017 A.D.- covenant-agreement and PE-2016-A.D.-covenant- agreement..

18- See: Proof-of-Claim -B and Gila-county-Arizona- Doc.# 011722¹⁶, -:Proof of the Claim with the deprivation-of-right- Fee-Schedule for the remedy of the damage as verified and demonstrated- herewith by the law of the Ingold-Pinal-county- RE 322 399 225 US, pp. 9- 13 of 222, et seq. -covenant in the relationship to a November- 2021 A.D. -commercial-matter - imposing :Notice-of-Hearing ... -:CV202000723 under the duress of the color-of-law without-of the Pinal-county-Trustee- jurisdiction or authorization from the beneficiary -- See: Proof-of-Claim -C.

:Pinal-county-Arizona- Trustee- has- Exceeded the Jurisdiction with the direct-beneficiary- harms within a color-of-law- process against the beneficiary.

See: Proof-of-Claim -C. :CV202000723 -:Notice of Hearing, et al.

19- See: Proof-of-Claim -C. :The- PINAL -COUNTY/Pinal-county-Arizona-state-Trustee-commerical- competiton with the beneficiary is with the unavoidable-propagation of the harms upon the beneficiary- Jay-Roy: Ingold, Indianan- beneficiary- Executor, et al.- and the Hill-Executors with the use of an abusive-commercial-process in the violation of the Ingold-Pinal-county- RE 322 399 225 US-covenant- agreement¹⁷ with the damage-intend upon the man-beneficiary, et al.- and upon the man- Hill-Executor- procurators-now overstanding the Pinal-county-Aizona-state-Trustee-offices with the law of the ngold-Pinal-county- RE 322 399 225 US-covenant- agreement by the law of the PE-2016-A.D. -covenant.

20- :On or about the October -2021-A.D. with-when the Notice-of-Hearing ... -:CV202000723 under the duress of the color-of-law by the beneficiary-subrogation: JAY ROY INGOLD- wrong-doing and harm-created upon the man- Jay-Roy: ingold- Indianan- beneficiary in the frank-breach of the Ingold-Pinal-county- RE 322 399 225 US-covenant- agreement¹⁸ is

16 :Gila-county-Arizona- Doc.# 011722 means: Proof of Claim (USPO-RMN) RE 322 404 169 US - October 29, 2019 A.D. of the Equity-covenant-Agreement (USPO-RMN) RE 322 399 225 US - May 8, 2017 A.D., with the activation at the June 8, 2017 A.D.- hearing with the DOI-1776-A.D.- covenant, et seq. by the law of the Equity-covenant-Agreement (USPO-RMN) RE 322 399 225 US and PE-2016-A.D. -covenant- agreements within the regard of the man- Darrell-James: Hill and -wife- Beverly-Jean: Romero- Hill.

17 :Ingold-Pinal-county- RE 322 399 225 US-covenant- agreement means: See: Proof-of-Claim -B

18 :Ingold-Pinal-county- RE 322 399 225 US-covenant- agreement means: See: Proof-of-Claim -B

:Notice: Hill- Executors- Procurator- Jurisdiction, et al.- :Render- Pinal-county-Bill-Remedy 4 / 9

:Stephen-Q, -:Pinal-county-Arizona-state-Trustee, -:USPO RMN RE 322 398 361 US,

:Mark, -:Pinal-county-Arizona- state-Trustee, -:USPO RMN RE 322 399 225 US,

2022-011769 MISC Page: 2168 of 2782

09/26/2022 03:35:37 PM Receipt #: 22-9381

Rec Fee: \$30.00 Darrell James Hill

Gila County, Az, Sadie Jo Bingham, Recorder



:Notice: No-presumptive or authorized -jurisdiction under the Pinal-county-Arizona- statute
:Notice: Hill-Executor- Procuration- overstanding :Pinal-county-Arizona- Trustee- Offices
:Notice: Bill of Particulars to the Pinal-county-Trustee- Dereliction: -Payment is demanded

with-when the man- Jay-Roy: Ingold- Indianan-beneficiary with the beneficiary-subrogation: JAY ROY INGOLD- noticed to the Hill-Executors of the PE-2016-A.D- DOI-1776-A.D.- covenants with the procuration-authority-now for the remedy with the fidelity for the assurance and ensurance of the beneficiary-absolute- advantage in the accordance with the (USPO RMN#) RE 322 399 225 US- March 8, 2017 A.D.- covenant- agreement by the law of the PE-2016-A.D.- covenant.

:Conclusion -

21~ :For the lot of the damages-imposed upon the Hill-Executors is with the remedy-now-due for the Pinal-county-Trustee-dereliction with the deprivation of the DOI-1776-A.D.-covenant, et seq.-property with the remedy-now-due upon this demand by the law of the PE-2016-A.D.- covenant-deprivation- agreement; and:

22~ This-Pinal-county-Arizona -matter-operating under the color-of-law is with the undermining of the DOI-1776-A.D. and with the posturing unto the harm upon the Hill-Executors by the Pinal-county-Arizona-state-Trustee with the use of the color of the law with the legal-machinery in the continued-violation of the DOI-1776-A.D. by the law of the PE-2016-A.D. :Evidence of the use of the color-of-law with the competition harm upon the beneficiary is with the violation of the express-covenant-Agreement (USPO-RMN) RE 322 399 225 US – May 8, 2017 A.D.; and:

23~ JAY ROY INGOLD/Jay-Roy: Ingold- Indianan-beneficiary is with the non-Trust-authority of the matters for the man- Hill-Executors by the Hill-Executors, and:

24~ The- Presumption of the Pinal-county-Arizona-state-Trustee- adhesion-jurisdiction or authority over-standing of the Hill-Executors is without the merit and denied by the Hill-Executors, and:

25~ For the limited-diplomatic-immunity with the Hill-Executors is within the limit of the law of the DOI-1776-A.D.-covenant by the law of the PE-2016-A.D.- covenant- agreement; and:

26~ No-unrevealed or unauthorized presumption for the enforcement of the Parens-Patria-Doctrine is permitted except by the express-written-authorization by the Hill-Executors.

**:Remedy-now-due- NOTICE with the Executor-Hills' procuration
with the law of the RE 322 399 225 US- March 8, 2017 A.D.-
covenant- Agreement by the he law of the PE-2016-A.D.**

27~ For the RE 322 399 225 US- March 8, 2017 A.D. -procuration-agreement-matter of the Pinal-county-Trustee-dereliction with the competition and damage upon the Hill-Executors is with the remedy by the procuration-now-time by the law of the PE-2016-A.D.- covenant between the Hill-Executors and the Pinal-county-Arizona- Trustees.

Cc: :Pinal-county-Arizona-state-Trustees
c/o :Jay-Roy: Ingold, -:Executor
5124 East 18th Avenue
Apache-Junction, Arizona

:Mark, -:Sheriff -:Lamb-
-:Pinal-county-Arizona- Trustee – :USPO RMN: RE 322 398 327 US
971 Jason Lopez Circle, Building C
Florence, Arizona [85132]

:Kevin: Cavanaugh- :District 1, -:Trustee,
:Mike: Goodman- :District 2, -:Vice-Chairman, -:Trustee,
:Stephen-Q: Miller- :District 3, -:Chairman, -:Trustee, – :USPO RMN RE 322 398 361 US
:Jeffrey: McCJure- :District 4, -:Trustee,
:Jeff:Serdy- :District 5, -:Trustee;
:man, -:Board of the Pinal-county-Arizona- Trustees
-:Pinal-county-Arizona- Trustee -office

:Notice: Hill- Executors- Procurator- Jurisdiction, et al.- :Render- Pinal-county-Bill-Remedy
:Stephen-Q, -:Pinal-county-Arizona-state-Trustee, -:USPO RMN RE 322 398 361 US,
:Mark, -:Pinal-county-Arizona- state-Trustee, -:USPO RMN: RE 322 398 327 US.

2022-011769 MISC Page: 2169 of 2782

09/26/2022 03:35:37 PM Receipt #: 22-9381

Rec Fee: \$30.00 Darrell James Hill

Gila County, Az, Sadie Jo Bingham, Recorder



:Notice: No-presumptive or authorized -jurisdiction under the Pinal-county-Arizona- statute
:Notice: Hill-Executor- Procurator- overstanding :Pinal-county-Arizona- Trustee- Offices
:Notice: Bill of Particulars to the Pinal-county-Trustee- Dereliction: -Payment is demanded

c/o :Natasha: Kennedy, -:Clerk, -:Trustee
135 N. Pinal Street, Administrative-Complex
Florence, Arizona [85132]

:James: Woods -:beneficiary-Executor,
:Lisa: Loeffler -:beneficiary-Executor,
:Tracy-Robert: Calhoun -:beneficiary-Executor;
:Damaged- countryman
c/o :Jay-Roy: Ingold -:beneficiary-Executor
5124 East 18th Avenue
Apache Junction, Arizona

:i- man verify that the above is true and correct to the best-ability, and will-state-same onto the record in the open-court.

:Without-prejudice,

Darrell-James Hill Executor

:Darrell-James: Hill,
-:Ohioan, -:beneficiary, -:Executor;
-:Executor- Procurator: Hill-Executors

Beverly-Jean Romero Executor

:Beverly-Jean: Romero- Hill,
-:New-Mexican, -:beneficiary, -:Executor

:i- autographer below, know the man and witnessed their verification and autograph.

Witness: 11/15/21

Duncan Birtington Plaintiff

Witness: 11/15/21

By: Jay Roy Ingold

Witness: 11/15/21

Wesley Gene Witness

:i- man verify that the above is true and correct to the best-ability, and will-state-same onto the record in the open-court.

:Without-prejudice,

Darrell-James Hill
:Darrell-James: Hill,
-:Ohioan, -:beneficiary, -:Executor;
-:Executor- Procurator: Hill-Executors

Beverly-Jean Romero
:Beverly-Jean: Romero- Hill,
-:New-Mexican, -:beneficiary, -:Executor

:Jurat -

:Verified under the oath and autographed before me this ___ day, :November- 2021- A.D.
:Type of Identification: Arizona-Driver-License

:Notary-Public

:SEAL

2/6/21
:Notice: Hill- Executors- Procurator- Jurisdiction, et al. -:Render- Pinal-county-Bill-Remedy
:Stephen-Q, -:Pinal-county-Arizona-state-Trustee, -:USPO RMN RE 322 398 361 US,
:Mark, -:Pinal-county-Arizona- state-Trustee, -:USPO RMN: RE 322 398 327 US.

6 / 9

2022-011769 MISC Page: 2170 of 2782

09/26/2022 03:35:37 PM Receipt #: 22-9381
Rec Fee: \$30.00 Darrell James Hill
Gila County, Az, Sadie Jo Bingham, Recorder



:Notice: No-presumptive or authorized -jurisdiction under the Pinal-county-Arizona- statute
:Notice: Hill-Executor- Procurator- overstanding :Pinal-county-Arizona- Trustee- Offices
:Notice: Bill of Particulars to the Pinal-county-Trustee- Dereliction: -Payment is demanded

c/o :Natasha: Kennedy, -:Clerk, -:Trustee
135 N. Pinal Street, Adminstrative-Complex
Florence, Arizona [85132]

:James: Woods -:beneficiary-Executor,
:Lisa: Loeffler -:beneficiary-Executor,
:Tracy-Robert: Calhoun -:benficiary-Executor;
:Damaged- countryman
c/o :Jay-Roy: Ingold -:beneficiary-Executor
5124 East 18th Avenue
Apache Junction, Arizona

:i- man verify that the above is true and correct to the best-ability, and will-state-same onto the record in the open-court.

:Without-prejudice,

Darrell-James Hill Executor

:Darrell-James: Hill,
-:Ohioan, -:beneficiary, -:Executor;
-:Executor- Procurator: Hill-Executors

Beverly-Jean Romero Hill Executor

:Beverly-Jean: Romero- Hill,
-:New-Mexican, -:beneficiary, -:Executor

:i- autographer below, know the man and witnessed their verification and autograph.

Witness: 11/15/21

Duncan Sturtington Ph

Witness: 11/15/21

By: Jay Roy Ingold

Witness: 11/15/21

Wesley-Gene: Wheeler

:i- man verify that the above is true and correct to the best-ability, and will-state-same onto the record in the open-court.

:Without-prejudice,

Darrell-James Hill Executor

:Darrell-James: Hill,
-:Ohioan, -:beneficiary, -:Executor;
-:Executor- Procurator: Hill-Executors

Beverly-Jean Romero Hill Executive

:Beverly-Jean: Romero- Hill,
-:New-Mexican, -:beneficiary, -:Executor

:Jurat -

:Verified under the oath and autographed before me this 15th day, :November- 2021- A.D.

:Type of Identification: Arizona-Driver-License

Cheryl Smith
:Notary-Public

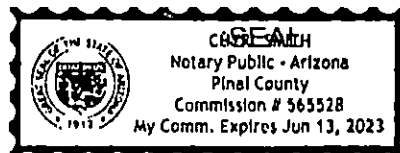

:Notice: Hill- Executors- Procurator- Jurisdiction, et al.- :Render- Pinal-county-Bill-Remedy
:Stephen-Q, -:Pinal-county-Arizona-state-Trustee, -:USPO RMN RE 322 398 361 US,
:Mark, -:Pinal-county-Arizona- state-Trustee, -:USPO RMN: RE 322 398 327 US.

2022-011769 MISC Page: 2171 of 2782
09/26/2022 03:35:37 PM Receipt #: 22-9981
Rec Fee: \$30.00 Darrell James Hill
Gila County, Az, Sadie Jo Bingham, Recorder



:Notice: No-presumptive or authorized -jurisdiction under the Pinal-county-Arizona- statute
:Notice: Hill-Executor- Procuration- overstanding :Pinal-county-Arizona- Trustee- Offices
:Notice: Bill of Particulars to the Pinal-county-Trustee- Dereliction: -Payment is demanded

2022-011769 MISC Page: 2172 of 2782
09/29/2022 09:35:37 PM Receipt #: 22-9381
Rec/Fee: \$30.00 Darrell James Hill
Gila County, Az, Sadie Jo Bingham, Recorder

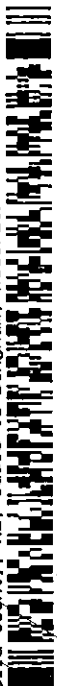

:Notice: Hill- Executors- Procurator- Jurisdiction, et al.- :Render- Pinal-county-Bill-Remedy 7 / 9
:Stephen-Q, -:Pinal-county-Arizona-state-Trustee, -:USPO RMN RE 322 398 361 US,
:Mark, -:Pinal-county-Arizona- state-Trustee, -:USPO RMN: RE 322 398 327 US.

:Proof-of-Claim: A)
:2017-Ingold-Pinal-county-
RE 322 399 225 US- covenant -
:Bill of Particulars of the Dishonored

-remedy of the matter-now
in the procuration unto the date
of the verification of
the resolve of these matters

Unofficial Copy

Bill of Particulars for the Immediate-Payment and Closure of the Matter

:Darrell-James: Hill, -:Ohiona -beneficiary- Executor;
 :Procurator- Darrell-James: Hill': RE 322 399 225 US
 PO Box 3806
 Apache Junction, Arizona [85117]

:Mark, -Sheriff- :Lamb,
 -:Pinal-county-Arizona- Trustee - :USPO RMN: RE 322 398 327 US
 971 Jason Lopez Circle, Building C
 Florence, Arizona [85132]

:Kevin: Cavanaugh- :District 1, -:Trustee,
 :Mike: Goodman- :District 2, -:Vice-Chairman, -:Trustee,
 :Stephen-Q: Miller- :District 3, -:Chairman, -:Trustee - :USPO RMN RE 322 398 361 US,
 :Jeffrey: McClure- :District 4, -:Trustee,
 :Jeff:Serdy- :District 5, -:Trustee;
 :Board of supervisor
 -:Pinal-county-Arizona- Trustee -office
 c/o :Natasha: Kennedy, -:Clerk, -:Trustee
 135 N. Pinal Street, Administrative-Complex
 Florence, Arizona [85132]

COPY

:Bill- Payment-Agreement: Due-Now

:Day: **Deprivation-Covenant-Agreement*: June 8, 2017, 5:00 pm.** for
 the Time distribution- obligation- period- date: April 5, 2017, 5:00 pm to the
 November 14, 2021, 5:00 pm., -:Agreement: one- silver- dollar per
 the minute (unit of time) until the resolve of the matter by the express-
 covenant.

:Start-Day	:End-Day	:minues to- day	Deprivation-payment	Payment- total-date	Payment-minute- due-Now
04/05/17 05:00 PM	11/14/21 05:00 PM	2423520*	one- silver- dollar -in- specie per the minute	0	2423520
Totals:		2423520		0	2423520

*:Time-Calculation with the 'timeanddate.com/date/timeduration.html'²

:Immediate- Payment is Required and Demanded- now, -:post- haste.

**:Please send payment to: :Darrell-James: Hill, -:Exector-
 c/o :Darrell-James: Hill, -:Procurator: RE 322 399 225 US
 PO Box 3806
 Apache Junction, Arizona [85117**

1 :Darrell-James: Hill, -:Ohioan -beneficiary- Executor; -:Procurator means: :Procurator for the man- :Darrell-James: Hill, -:Ohioan- Executor in the Procuration of the non-resolved- RE 322 399 225 US- March 8, 2017 A.D. -:covenant -deprivation-payment -agreement: one- silver- dollar per the minute (unit of time) until the resolve of the matter.
 2 :timeanddate.com/date/timeduration.html means: See: Calculation sheer attached, 1 page.

2022-011769 MISC Page: 2173 of 2782
 09/26/2022 03:35:37 PM Receipt #: 22-9381
 Rec Fee: \$30.00 Darrell James Hill
 Gila County, Az, Sadie Jo Bingham, Recorder



COPY

2164

Bill of Particulars for the Immediate-Payment and Closure of the Matter

:Beverly-jean: Romero- Hill, -:New-Mexican -beneficiary- Executor;
 :Procurator- Darrell-James: Hill': RE 322 399 225 US
 PO Box 3806
 Apache Junction, Arizona [85117]

:Mark, -Sheriff- :Lamb,
 -:Pinal-county-Arizona- Trustee - :USPO RMN: RE 322 398 327 US
 971 Jason Lopez Circle, Building C
 Florence, Arizona [85132]

:Kevin: Cavanaugh- :District 1, -:Trustee,
 :Mike: Goodman- :District 2, -:Vice-Chairman, -:Trustee,
 :Stephen-Q: Miller- :District 3, -:Chairman, -:Trustee - :USPO RMN RE 322 398 361 US,
 :Jeffrey: McClure- :District 4, -:Trustee,
 :Jeff:Serdy- :District 5, -:Trustee;
 :Board of supervisor
 -:Pinal-county-Arizona- Trustee -office
c/o :Natasha: Kennedy, -:Clerk, -:Trustee
 135 N. Pinal Street, Adminstrative-Complex
 Florence, Arizona [85132]

:Bill- Payment-Agreement: Due-Now

:Day: **Deprivation-Covenant-Agreement*: June 8, 2017, 5:00 pm. for**
 the Time distribution- obligation- period- date: April 5, 2017, 5:00 pm to the
 November 14, 2021, 5:00 pm., -:Agreement: one- silver- dollar per
 the minute (unit of time) until the resolve of the matter by the express-
 covenant.

:Start-Day	:End-Day	:minues to day	Deprivation-payment	Payment-total-date	Payment-minute-due-Now
04/05/17 05:00 PM	11/14/21 05:00 PM	2423520*	one- silver- dollar -in- specie per the minute	0	2423520
Totals:				0	2423520

*:Time-Calculation with the 'timeanddate.com/date/timeduration.html'²

:Immediate- Payment is Required and Demanded- now, -:post- haste.

**:Please send payment to: :Beverly-Jean: Romero- Hill, -:Execotor-
 c/o :Darrell-James: Hill, -:Procurator: RE 322 399 225 US
 PO Box 3806
 Apache Junction, Arizona [85117**

1 :Darrell-James: Hill, -:Ohioan -beneficiary- Executor; -:Procurator means: :Procuator for the man-:Beverly-Jean: Romero- Hill, -:New-Mexican- Executor in the Procuration of the non-resolved- RE 322 399 225 US- March 8, 2017 A.D. -:covenant -deprivation-payment -agreement: one- silver- dollar per the minute (unit of time) until the resolve of the matter.
 2 :timeanddate.com/date/timeduration.html means: See: Calculation sheet attached, 1 page.

Page: 2174 of 2782
 Receipt #: 22-9981

MISC
 09/26/2022 03:35:37 PM
 Rec Fee: \$30.00
 Darrell James Hill
 Recorder
 Gila County, Az



2165

Days Calculator: Days Between Two Dates

How many days, months, and years are there between two dates?

Count Days Add Days Workdays Add Workdays Weekday Week No

From: **Wednesday, April 5, 2017 at 5:00:00 pm**
To: **Saturday, November 13, 2021 at 5:00:00 pm**

Result: 1683 days, 0 hours, 0 minutes and 0 seconds

The duration is 1683 days, 0 hours, 0 minutes and 0 seconds

Or 4 years, 7 months, 8 days excluding the end date.

Or 55 months, 8 days excluding the end date.

Alternative time units

1683 days, 0 hours, 0 minutes and 0 seconds can be converted to one of these units:

- 145,411,200 seconds
- 2,423,520 minutes
- 40,392 hours
- 1683 days
- 240 weeks and 3 days
- 461.10% of a common year (365 days)

April 2017						
26 days included						
Sun	Mon	Tue	Wed	Thu	Fri	Sat
						1
2	3	4	5	6	7	8
9	10	11	12	13	14	15
16	17	18	19	20	21	22
23	24	25	26	27	28	29
30						

May 2017						
31 days included						
Sun	Mon	Tue	Wed	Thu	Fri	Sat
	1	2	3	4	5	6
7	8	9	10	11	12	13
14	15	16	17	18	19	20
21	22	23	24	25	26	27
28	29	30	31			

June 2017–October 2021	
June 2017–December 2017:	214 days included
Year 2018:	365 days included
Year 2019:	365 days included
Year 2020:	366 days included
January 2021–October 2021:	304 days included

November 2021						
12 days included						
Sun	Mon	Tue	Wed	Thu	Fri	Sat
	1	2	3	4	5	6
7	8	9	10	11	12	13
14	15	16	17	18	19	20
21	22	23	24	25	26	27
28	29	30				

□ = First day included (Apr 5, 2017) □ = Last day included (Nov 12, 2021)

Make a New Calculation

- Make adjustment and calculate again
- New calculation between two other dates and times
- New calculation between two dates (no time)



Time & Date Calculator App for iOS

See how long remains before a deadline or exactly when those 30 days are up.



:Notice: No-presumptive or authorized -jurisdiction under the Pinal-county-Arizona- statute
:Notice: Hill-Executor- Procurator- overstanding :Pinal-county-Arizona- Trustee- Offices
:Notice: Bill of Particulars to the Pinal-county-Trustee- Dereliction: -Payment is demanded

Proof-of-Claim: B)
:the -Procurator-Obligation of the
Equity-Covenant- RE 322 399 225 US ,
May 8th, 2017 A.D.
; appended: pp. 9- 13 of 222 -et al.

2167
:Notice: Hill- Executors- Procurator- Jurisdiction, et al.- :Render- Pinal-county-Bill-Remedy
:Stephen-Q, -:Pinal-county-Arizona-state-Trustee, -:USPO RMN RE 322 398 361 US,
:Mark, -:Pinal-county-Arizona- state-Trustee, -:USPO RMN: RE 322 398 327 US.

Page: 2176 of 2782

Receipt #: 22-9381

2022-011769 MISC
09/26/2022 03:35:37 PM
Rec Fee: \$30.00
Gila County, Az

Darrell James Hill
Sadle Jo Bingham, Recorder





Jay- Roy: Ingold
 c/o 5142 East 18th Avenue
 Apache Junction, Arizona ZIP CODE EXEMPT
 DMM 602.1.3.e2. Title 18 U.S.C. § 1342

Himanshu, acting as Director, Community Development
 Paula, acting as Code Compliance Manager
 c/o Terrilyn, acting as Code Compliance Officer RE 322 399 225 US
 575 North Idaho Street, Suite 800
 Apache Junction, Arizona 85119

Re: 5124 East 18th Avenue, Apache Junction, Arizona

NOTICE	a)	EX POST FACTO LAW VIOLATON;
	b)	CRIMINAL COMPLAINT;
	c)	FEE SCHEDULE
DEMAND	i)	DISCHARGE COMPLAINT - CANCEL HEARING, and
	ii)	CEASE AND DESIST; or,
	iii)	COMMON LAW PROCEEDING

Himanshu, Paula, Terrilyn, Greetings:

i: man am writing: because i have received various requests for changes i voluntarily made upon my property in good faith. i made significant changes and sent you photos, etc. improving the general appearance of my property. However, you have violated your Oath of Office and duty to persist to impose upon me further DEMAND LETTER(s) and a COMPLAINT seeking further to impose Code Violations for my parcel "103-14-012B" that you knew or should have known was ACQUIRED in 2008!

Address Above: It is a felony for you to send mail to an address that is not a proper mailing address, or a fictitious mailing address. My proper mailing address is as indicated above; if you intend to send mail to another address then you intend to be guilty of mail fraud.

NOTICE:

Your actions are repugnant to the Constitution for the United States of America people, and the subsequent-subordinate-laws. You have mistakenly presumed that your code violations AND counts somehow applied to me; so, let me be clear:

a)	your application of code violations AND counts do Not apply to me;
b)	you have threatened to impose fines and/or create other hardship that Never before existed! if i do not comply with your demands;
c)	you have progressed to: a) threat of abuse, b) under the color of law; and,
d)	Your "CODE ENFORCEMENT OFFICER VERIFICATION", on the April 5,



2017, COMPLAINT, is perjury if a) you knew or should have known that b) my parcel at 5124 E. 18th Ave. has been in my ownership since 2008; that: c) the codes were contrived years later, even 2010; d) no man has made a claim; and, e) your verification is repugnant to the United States and Arizona constitutions Ex post facto law prohibitions.

Moreover, your use of code to DECEIVE ME evidences a perverse application with willful criminal intent.

DEMAND

- **Withdraw the Complaint and Cancel the Hearing post haste;**
- **CEASE and DESIST; No Further Trespass about my property.**
- **FEE SCHEDULE:** If you choose Not to withdraw your complaint post haste, then from the time of your receipt of this NOTICE and DEMAND; I) you have 5 days to complete Items 1) & 2); thereafter, II) any further intrusion from you, et al., any actions to date, you a) agree to pay to me post haste upon request(s) one silver dollar per minute period of time from April 5, 2017, 5:00 pm., until this matter is resolved; and, b) you agree to pay post haste upon request any and all legal service charges incurred in resolve of- and collection from you- any amounts accrued.
- **COMMON LAW PROCEEDING:** If you choose to Not withdraw your complaint post haste, then i Demand a June 8, 2017, Court of Record to proceed in Common Law with trial by jury to hear and decide a) the controversy of your actions against me, and b) the Item 3) Fee Schedule, matter in controversy greater than twenty dollars at this writing.
- My Next Friend, the man steward-at-my-property, will accompany and assist me as i deem may be necessary.

Jay-Roy: Ingold

	Jay-Roy: Ingold
	May 7, 2017

Because of these hassles I am putting my house up for sale.

I witness and acknowledge that all statements herein are true.

Lisa: Ingold
May 7, 2017



Registered No. RE322399225US

Date Stamp
0130
07

Reg. Fee	\$0.49	
Handling Charge	\$11.70	Return Receipt
Postage	\$2.75	Restricted Delivery
Received by	\$0.00	
		\$14.94

To Be Completed By Post Office

Customer Must Declare Full Value \$0.00 05/08/2017 Domestic business up to \$2,000 is included. International business up to \$500 is included. (See Reverse.)

APACHE JUNCTION, AZ 85120
OFFICIAL USE

To Be Completed By Customer (Please Print) All Entries Must Be In Ink/Print or Typed	FROM	Jay-Roy England, employed man c/o 5142 East 18 th Avenue Apache Junction, Arizona ZIP CODE EXEMPT without the US tax. 85120
	TO	Elizabeth, acting as Director, Crime Devt Apache Junction, AZ 85120 66 Durbin, acting as Code Compl Off 573 North Idaho Street, Suite 200 Apache Junction, Arizona 85119

PS Form 3806, Receipt for Registered Mail Copy 1 - Customer
May 2007 (7530-02-000-9051) (See Information on Reverse)
For domestic delivery information, visit our website at www.usps.com

SENDER: COMPLETE THIS SECTION:		COMPLETE THIS SECTION FOR DELIVERY:	
<ul style="list-style-type: none"> Complete items 1, 2, and 3. Print your name and address on the reverse so that we can return the card to you. Attach this card to the back of the mailpiece, or on the front if space permits. 		<p>A. Signature <input type="checkbox"/> Agent <input type="checkbox"/> Addressee</p> <p>B. Received by (Printed Name) <input type="checkbox"/> C. Date of Delivery</p> <p>D. Is delivery address different from item 1? <input type="checkbox"/> Yes <input type="checkbox"/> No If YES, enter delivery address below:</p>	
<p>1. Article Addressed to:</p> <p>Elizabeth, acting as Director, Crime Devt Apache Junction, acting as Code Compl Manager c/o Durbin, acting as Code Compl Off 573 North Idaho Street, Suite 200 Apache Junction, Arizona 85119</p>		<p>2. Service Type:</p> <p><input type="checkbox"/> Adult Signature <input type="checkbox"/> Priority Mail Express</p> <p><input type="checkbox"/> Adult Signature Restricted Delivery <input type="checkbox"/> Registered Mail</p> <p><input type="checkbox"/> Certified Mail <input type="checkbox"/> Registered Mail Restricted Delivery</p> <p><input type="checkbox"/> Certified Mail Restricted Delivery <input type="checkbox"/> Return Receipt for Merchandise</p> <p><input type="checkbox"/> Collect on Delivery <input type="checkbox"/> Signature Confirmation</p> <p><input type="checkbox"/> Collect on Delivery Restricted Delivery <input type="checkbox"/> Signature Confirmation Restricted Delivery</p> <p><input type="checkbox"/> Insured Mail <input type="checkbox"/> Signature Confirmation Restricted Delivery</p> <p><input type="checkbox"/> Insured Mail Restricted Delivery (over \$500)</p>	
<p>3. Article Number (Transfer from service label)</p> <p>RE 322399225US</p>		<p>9590 9402 2073 6132 0269 54</p>	
PS Form 3811, July 2016 PSN 7530-02-000-9063		Domestic Return Receipt	

Umm
2170

2022-011769 MISC Page: 2179 of 2782
09/26/2022 03:35:37 PM Receipt #: 22-9381
Rec Fee: \$30.00 Darrell James Hill
Gila County, Az, Sadie Jo Bingham, Recorder

2019-011722 MISC Page: 11 of 222
10/29/2019 11:47:58 AM Receipt #: 19-8874
Rec Fee: \$30.00 Darrell James Hill
Gila County, Az, Sadie Jo Bingham, Recorder

SENDER: COMPLETE THIS SECTION

- Complete items 1, 2, and 3.
- Print your name and address on the reverse so that we can return the card to you.
- Attach this card to the back of the mailpiece, or on the front if space permits.

1. Article Addressed to:
Pinal County Civil Hearing Office
31 N. Pinal Street
Florence, Arizona



9590 9402 2795 7069 4407 33

2. Article Number (Transfer from service label)
7015 0640000158837648

PS Form 3811, July 2016 PSN 7530-02-000-9053

COMPLETE THIS SECTION ON DELIVERY

A. Signature
 X *[Signature]* Agent Addressee

B. Received by (Printed Name)
SPRINA GARCIA Certified Delivery

C. Date of Delivery
5/13/17

D. Is delivery address different from item 1? Yes No
 If YES, enter delivery address below:
P O Box 1346
Florence AZ
85132

3. Service Type
 Adult Signature Priority Mail Express®
 Adult Signature Restricted Delivery Registered Mail®
 Certified Mail® Registered Mail Restricted Delivery
 Certified Mail Restricted Delivery Return Receipt for Merchandise
 Collect on Delivery Signature Confirmation™
 Collect on Delivery Restricted Delivery Signature Confirmation Restricted Delivery
 Insured Mail Signature Confirmation Restricted Delivery (over \$500)
 Insured Mail Restricted Delivery (over \$500)

Domestic Return Receipt

SENDER: COMPLETE THIS SECTION

- Complete items 1, 2, and 3.
- Print your name and address on the reverse so that we can return the card to you.
- Attach this card to the back of the mailpiece, or on the front if space permits.

1. Article Addressed to:
 Inmate, acting as Director, Court David
 Fuchs, acting as Cook Camp Manager
 of Thursday, acting as Cook Camp Off
 573 North Idaho Street, Suite 800
 Apache Junction, Arizona 85119



9590 9402 2073 6132 0269 54

2. Article Number (Transfer from service label)
RE 322 399 225 US

PS Form 3811, July 2016 PSN 7530-02-000-9053

COMPLETE THIS SECTION ON DELIVERY

A. Signature
 X *[Signature]* Agent Addressee

B. Received by (Printed Name)
[Signature] Certified Delivery

C. Date of Delivery
[Signature]

D. Is delivery address different from item 1? Yes No
 If YES, enter delivery address below:

3. Service Type
 Adult Signature Priority Mail Express®
 Adult Signature Restricted Delivery Registered Mail®
 Certified Mail® Registered Mail Restricted Delivery
 Certified Mail Restricted Delivery Return Receipt for Merchandise
 Collect on Delivery Signature Confirmation™
 Collect on Delivery Restricted Delivery Signature Confirmation Restricted Delivery
 Insured Mail Signature Confirmation Restricted Delivery (over \$500)
 Insured Mail Restricted Delivery (over \$500)

Domestic Return Receipt

COPY

2019-011722 MISC Page: 12 of 222
 10/29/2019 11:47:59 AM Receipt # 111
 Rec Fee: \$30.00 Darrell James Hill
 Gila County, Az, Sadie Jo Bingham, Recorder

UNRECORDED
 2/17/

2022-011769 MISC Page: 2180 of 2782
 09/26/2022 03:35:37 PM Receipt #: 22-9381
 Rec Fee: \$30.00 Darrell James Hill
 Gila County, Az, Sadie Jo Bingham, Recorder



U.S. Postal Service
CERTIFIED MAIL® RECEIPT
 Domestic Mail Only

For delivery information, visit our website at www.usps.com.

OFFICIAL USE

Certified Mail Fee \$3.35

Extra Services & Fees (check box, add fee to postage)

<input type="checkbox"/> Return Receipt (hardcopy)	\$0.00
<input type="checkbox"/> Return Receipt (electronic)	\$0.00
<input type="checkbox"/> Certified Mail Restricted Delivery	\$0.00
<input type="checkbox"/> Adult Signature Required	\$0.00
<input type="checkbox"/> Adult Signature Restricted Delivery	\$0.00

Postage \$0.49

Total Postage and Fees \$6.59

0130 02

Postmark Here

05/09/2017

Sent To Mark, acting as Pinal County Sheriff
 Street and Apt. No., or P.O. 971 Mason Circle, Building C
 Florence, Arizona 85131
 City, State, ZIP+4®

PS Form 3800, April 2015 (59) 753 J 02-200-517 See Reverse for Instructions

U.S. Postal Service
CERTIFIED MAIL® RECEIPT
 Domestic Mail Only

For delivery information, visit our website at www.usps.com.

OFFICIAL USE

Certified Mail Fee \$3.35

Extra Services & Fees (check box, add fee to postage)

<input type="checkbox"/> Return Receipt (hardcopy)	\$0.00
<input type="checkbox"/> Return Receipt (electronic)	\$0.00
<input type="checkbox"/> Certified Mail Restricted Delivery	\$0.00
<input type="checkbox"/> Adult Signature Required	\$0.00
<input type="checkbox"/> Adult Signature Restricted Delivery	\$0.00

Postage \$0.49

Total Postage and Fees \$6.59

0130 02

Postmark Here

05/09/2017

Sent To Mark, acting as Pinal County Sheriff
 Street and Apt. No., or P.O. 971 Mason Circle, Building C
 Florence, Arizona 85131
 City, State, ZIP+4®

PS Form 3800, April 2015 (59) 753 J 02-200-517 See Reverse for Instructions

2019-011722 MISC Page: 13 of 222
 10/28/2019 11:47:58 AM
 Rec Fee: \$30.00
 Darrell James Hill
 Gila County, Az, Sadie Jo Bingham, Recorder

2022-011769 MISC Page: 2181 of 2782
 09/26/2022 03:35:37 PM Receipt #: 22-9381
 Rec Fee: \$30.00 Darrell James Hill
 Gila County, Az, Sadie Jo Bingham, Recorder

Umo
 2/72

:Notice: No-presumptive or authorized -jurisdiction under the Pinal-county-Arizona- statute
:Notice: Hill-Executor- Procurator- overstanding :Pinal-county-Arizona- Trustee- Offices
:Notice: Bill of Particulars to the Pinal-county-Trustee- Dereliction: -Payment is demanded

Unofficial Copy

1.

Proof-of-Claim: C)
:Notice of Hearing ... CV202000723; 2 pages;
PINAL/Pinal-county-Arizona-state-Trustee against
Jay-Roy: Ingold- Indianan-beneficiary

2773

2022-011769 MISC Page: 2182 of 2782
09/26/2022 03:35:37 PM Receipt #: 22-9381
Rec Fee: \$30.00 Darrell James Hill
Gila County, Az, Sadie Jo Bingham, Recorder



:Notice: Hill- Executors- Procurator- Jurisdiction, et al.- :Render- Pinal-county-Bill-Remedy
:Stephen-Q, -:Pinal-county-Arizona-state-Trustee, -:USPO RMN RE 322 398 361 US,
:Mark, -:Pinal-county-Arizona- state-Trustee, -:USPO RMN: RE 322 398 327 US.

1 **KENT VOLKMER**
2 **PINAL COUNTY ATTORNEY**
3 Craig Cameron (013176)
4 Deputy County Attorney
5 Post Office Box 887
6 Florence, AZ 85132
7 Telephone (520) 866-6466
8 Fax: (520) 866-6521
9 E-mail: craig.cameron@pinal.gov
10 *Attorney for Plaintiff*

11 **IN THE SUPERIOR COURT OF THE STATE OF ARIZONA**
12 **IN AND FOR THE COUNTY OF PINAL**

13 **PINAL COUNTY**, a political subdivision of
14 the State of Arizona

15 Plaintiff,

16 vs.

17 **JAY ROY INGOLD**,

18 Defendant.

19 Case No. CV202000723

20 **NOTICE OF HEARING FOR ENTRY**
21 **OF DEFAULT JUDGMENT AND**
22 **ISSUANCE OF PERMANENT**
23 **MANDATORY INJUNCTION**

24 Hon. JOSEPH R. GEORGINI

25 PLEASE TAKE NOTICE the Plaintiff PINAL COUNTY's Motion for Entry of
26 Default Judgment and Issuance of Permanent Mandatory Injunction will come on for hearing
27 before the Honorable JOSEPH R. GEORGINI, of the Superior Court of the State of Arizona, in
28 and for Pinal County, located at **PINAL COUNTY COURTHOUSE, 971 N. JASON LOPEZ**
29 **CIR; BLDG A, FLORENCE, ARIZONA, on the 15TH day of NOVEMBER, 2021 at 10:00**
30 **am** or as soon thereafter as counsel may be heard, and Plaintiff will request the entry of
31 judgment by default for the relief prayed for in the Verified Complaint to Enjoin Violations of
32 the Pinal County Development Services Code and issuance of a Permanent Mandatory
33 Injunction.

34 ///

35 ///

36 ///

2174



1
2
3
4
5
6
7
8
9
10
11
12
13
14
15
16
17
18
19
20
21
22
23
24

RESPECTFULLY SUBMITTED this 8th day of October, 2021.

KENT VOLKMER
PINAL COUNTY ATTORNEY

/s/ Craig Cameron
Craig Cameron
Deputy County Attorney

ORIGINAL of the foregoing e-filed
this 8th day of October, 2021 with:

CLERK OF THE SUPERIOR COURT
PINAL COUNTY COURTHOUSE
971 N. JASON LOPEZ CIR; BLDG A
FLORENCE, AZ 85132

COPIES of the foregoing delivered/
personal service/mailed this
8th day of October, 2021 to:

JOSEPH R. GEORGINI
JUDGE OF THE SUPERIOR COURT

JAY ROY INGOLD
5124 E. 18TH AVE
APACHE JUNCTION, AZ 85119

By: /s/ Kelly Pite
CC/kp

2175

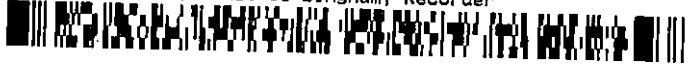

APACHE JUNCTION
151 W SUPERSTITION BLVD
APACHE JUNCTION, AZ 85120-9998
(800)275-8777

11/15/2021 12:19 PM

Product	Qty	Unit Price	Price
First-Class Mail® Large Envelope	1		\$1.96
Florence, AZ 85132 Weight: 0 lb 4.20 oz Estimated Delivery Date Thu 11/18/2021			
Registered Mail®			\$14.35
Amount: \$21.00 Tracking #: RE322398327US			
Total			\$16.31
First-Class Mail® Large Envelope	1		\$1.96
Florence, AZ 85132 Weight: 0 lb 4.10 oz Estimated Delivery Date Thu 11/18/2021			
Registered Mail®			\$14.35
Amount: \$21.00 Tracking #: RE322398361US			
Total			\$16.31
Grand Total:			\$32.62
Cash			\$40.00
Change			-\$7.38

The UPS Store #3750
5301 S Superstition Mountain Dr Ste
Gold Canyon, AZ 85118-1917
480-474-9838

Terminal...: POS3750R Date.: 11/15/2021
Employee...: 179634 Time.: 11:42 AM

ITEM NAME	QTY	PRICE	TOTAL
Notary	1	\$10.00	\$10.00
Tax		\$0.00	\$0.00

Subtotal	\$10.00
Shipping/Other Charges	\$0.00
Total tax	\$0.00
Total	\$10.00
Cash	\$50.00
Change back (Cash)	(\$40.00)

Items Designated HR are NOT eligible for Returns, Refunds or Exchanges.

US Postal Rates Are Subject to Surcharge.



View The UPS Store, Inc.'s privacy notice at
<https://www.theupsstore.com/privacy-policy>

To Be Completed By Customer (Please Print)
May 2007 (7530-02-000-9051)

COMPLETE THIS SECTION ON DELIVERY

A. Signature Agent
 Address
 B. Received by (Printed Name) 1000 SAYER C. Date of Delivery 11-16-21
 D. Is delivery address different from item 1? Yes No
 If YES, enter delivery address below

SENDER: COMPLETE THIS SECTION

Complete items 1, 2, and 3.
 Print your name and address on the reverse so that we can return the card to you.
 Attach this card to the back of the mailpiece, or on the front if space permits.

1. Article Addressed to:
Stephen-Q Miller - Trustee
60 Natascha Kennedy - Clerk
135 N. Pinal Street - Admin
Florence, Arizona 85132

2. Article Number (Transfer from service label)
RE 322 398 361 US

3. Service Type
 Priority Mail Express®
 Registered Mail™
 Registered Mail Restricted Delivery
 Certified Mail®
 Certified Mail Restricted Delivery
 Collect on Delivery
 Collect on Delivery Restricted Delivery
 Insured Mail
 Insured Mail Restricted Delivery (over \$500)

Domestic Return Receipt
 PS Form 3811, July 2015 PSN 7530-02-000-9053

Registered No. RE322398361US

Reg. Fee	\$1.96	Return Receipt	
Handling Charge	\$14.35	Restricted Delivery	
Postage	\$0.00	Received by	\$0.00
Customer Must Declare Full Value	\$21.00	Domestic Insurance	Only up to \$500 is covered in the declared value. International indemnity is limited. (See Reverse).

APACHE JUNCTION, AZ 85120
 NOV 15 2021

OFFICIAL USE

APACHE JUNCTION, AZ 85120

FROM: Darrell James Hill, Executor
Beverly Jean Romero Hill, Executor
P.O. Box 3806
Apache Junction, Arizona 85117

TO: Stephen-Q Miller - Chairman - Trustee
60 Natascha Kennedy - Clerk - Trustee
135 N. Pinal Street, Admin - Complex
Florence, Arizona 85132

PS Form 3806, Receipt for Registered Mail Copy 1 - Customer
 May 2007 (7530-02-000-9051) (See information on Reverse)
 For domestic delivery information, visit our website at www.usps.com

2176

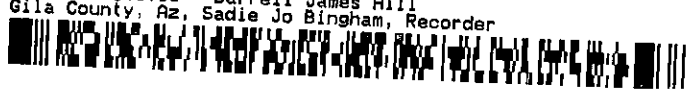

Track Another Package +

Tracking Number: RE322398361US

Remove X

Your item was picked up at the post office at 3:27 pm on November 16, 2021 in FLORENCE, AZ 85132.

✓ **Delivered, Individual Picked Up at Post Office**

November 16, 2021 at 3:27 pm
FLORENCE, AZ 85132

Get Updates ▾

Feedback

Text & Email Updates ▾

Tracking History ▴

November 16, 2021, 3:27 pm
Delivered, Individual Picked Up at Post Office
FLORENCE, AZ 85132

Your item was picked up at the post office at 3:27 pm on November 16, 2021 in FLORENCE, AZ 85132.

November 16, 2021, 8:16 am
Available for Pickup
FLORENCE, AZ 85132

November 16, 2021, 8:11 am
Arrived at Post Office
FLORENCE, AZ 85132

November 15, 2021, 10:27 pm

2/7

2022-011769 MISC Page: 2186 of 2782
09/26/2022 03:35:37 PM Receipt #: 22-9381
Rec Fee: \$30.00 Darrell James Hill
Gila County, Az, Sadie Jo Bingham, Recorder



Departed USPS Facility
PHOENIX, AZ 85026

November 15, 2021, 10:25 pm
Arrived at USPS Facility
PHOENIX, AZ 85026

November 15, 2021, 5:07 pm
Departed Post Office
APACHE JUNCTION, AZ 85120

November 15, 2021, 12:15 pm
USPS in possession of item
APACHE JUNCTION, AZ 85120

Product Information



Feedback

See Less ^

Can't find what you're looking for?

Go to our FAQs section to find answers to your tracking questions.

[FAQs](#)

Unofficial Copy
2178

2022-011769 MISC Page: 2187 of 2782
09/26/2022 03:35:37 PM Receipt #: 22-9381
Rec Fee: \$30.00 Darrell James Hill
Gila County, Az, Sadie Jo Bingham, Recorder



RE322398327US

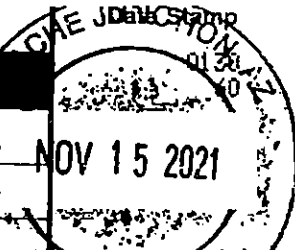

APACHE JUNCTION
151 W SUPERSTITION BLVD
APACHE JUNCTION, AZ 85120-9998
(800) 275-8777

11/15/2021 12:19 PM

To Be Completed By Post Office

Reg. Fee	\$1.96	Return Receipt
Handling Charge	\$14.35	Restricted Delivery
Postage	\$0.00	
Received by	\$0.00	
		\$16.31

Customer Must Declare
Full Value \$21.00
Domestic Insurance up to \$25,000 is included on the declaration. Liability indemnity is limited. (See Reverse).

Product	Qty	Unit Price	Price
First-Class Mail® Large Envelope	1		\$1.96
Florence, AZ 85132 Weight: 0 lb 4.20 oz Estimated Delivery Date Thu 11/18/2021			
Registered Mail®			\$14.35
Amount: \$21.00 Tracking #: RE322398327US			
Total			\$16.31

OFFICIAL USE

To Be Completed By Customer (Please Print) All Entries Must Be in Ballpoint or Typed

FROM: APACHE JUNCTION, AZ 85121
Darrell - James Hill, Executor
Deerly - Jean Romero Hill, Executor
PO Box 3806
Apache Junction, Arizona 85117

TO: Mark - Lamb, Sheriff
971 Jackson Lopez Circle, Bldg. C
Florence, Arizona 85132

First-Class Mail® Large Envelope	1		\$1.96
Florence, AZ 85132 Weight: 0 lb 4.10 oz Estimated Delivery Date Thu 11/18/2021			
Registered Mail®			\$14.35
Amount: \$21.00 Tracking #: RE322398361US			
Total			\$16.31

PS Form 3806, Receipt for Registered Mail Copy 1 - Customer
May 2007 (7530-02-000-9051) (See Information on Reverse)
For domestic delivery information, visit our website at www.usps.com®

Grand Total:	\$32.62
Cash Change	\$40.00 -\$7.38

The UPS Store #3750
5301 S Superstition Mountain Dr Ste
Gold Canyon, AZ 85118-1917
480-474-9838

Terminal: POS3750A Date: 11/15/2021
Employee: 179634 Time: 11:42 AM

ITEM NAME	QTY	PRICE	TOTAL
Notary			\$10.00
Tax	13	\$10.00	\$0.00

Subtotal	\$10.00
Shipping/Other Charges	\$0.00
Total tax	\$0.00
Total:	\$10.00
Cash	\$50.00
Change back (Cash)	(\$40.00)

Items Designated MR are NOT eligible for Returns, Refunds or Exchanges.

US Postal Rates Are Subject to Surcharge.



View The UPS Store, Inc.'s privacy notice at
<https://www.theupsstore.com/privacy-policy>

COMPLETE THIS SECTION ON DELIVERY

To Be Completed By Customer

1. Article Addressed to:
Mark - Lamb, Sheriff
971 Jackson Lopez Circle
Bldg. C
Florence, Arizona
[85132]

2. Article Number (transfer from service label)
RE 322 398 327 US

3. Service Type
 Certified Mail
 Registered
 Insured Mail
 C.O.D.

4. Restricted Delivery? (Extra Fee) Yes

PS Form 3811, February 2004 Domestic Return Receipt

To Be Completed By Customer

A. Signature Agent
B. Received by (Printed Name) Addressee
C. Date of Delivery 11/16/2021
D. Is delivery address different from that on the mailpiece? Yes No
If YES, enter delivery address below:

3. Express Mail
4. Return Receipt for Merchandise
5. Restricted Delivery? (Extra Fee) Yes

SENDER: COMPLETE THIS SECTION

- Complete items 1, 2, and 3. Also complete item 4 if Restricted Delivery is desired.
- Print your name and address on the reverse so that we can return the card to you.
- Attach this card to the back of the mailpiece, or on the front if space permits.

1. Article Addressed to:

Mark - Lamb, Sheriff
971 Jackson Lopez Circle
Bldg. C
Florence, Arizona
[85132]

2. Article Number (transfer from service label)

PS Form 3811, February 2004

Domestic Return Receipt

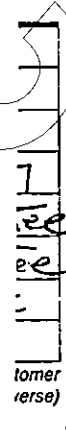

Reverse



2179

USPS Tracking®

[FAQs >](#)

[Track Another Package +](#)

Tracking Number: RE322398327US

[Remove X](#)

Your item was delivered at 11:55 am on November 16, 2021 in FLORENCE, AZ 85132.

✓ Delivered

November 16, 2021 at 11:55 am
FLORENCE, AZ 85132

[Get Updates ▾](#)

Feedback

[Text & Email Updates ▾](#)

[Tracking History ▾](#)

November 16, 2021, 11:55 am

Delivered

FLORENCE, AZ 85132

Your item was delivered at 11:55 am on November 16, 2021 in FLORENCE, AZ 85132.

November 16, 2021, 11:20 am

Refused

FLORENCE, AZ 85132

November 16, 2021, 8:16 am

Available for Pickup

FLORENCE, AZ 85132

November 16, 2021, 8:11 am

Arrived at Post Office

2180

2022-011769 MISC Page: 2189 of 2782

09/26/2022 09:35:37 PM Receipt #: 22-9381

Rec Fee: \$30.00 Darrell James Hill

Gila County, Az, Sadie Jo Bingham, Recorder



FLORENCE, AZ 85132

November 15, 2021, 10:27 pm
Departed USPS Facility
PHOENIX, AZ 85026

November 15, 2021, 10:26 pm
Arrived at USPS Facility
PHOENIX, AZ 85026

November 15, 2021, 5:07 pm
Departed Post Office
APACHE JUNCTION, AZ 85120

November 15, 2021, 12:15 pm
USPS in possession of item
APACHE JUNCTION, AZ 85120

Product Information

Feedback

See Less ^

2081

Can't find what you're looking for?

Go to our FAQs section to find answers to your tracking questions.

FAQs

2022-011769 MISC Page: 2190 of 2782
09/26/2022 03:35:37 PM Receipt #: 22-9361
Rec Fee: \$30.00 Darrell James Hill
Gila County, Az, Sadie Jo Bingham, Recorder



:2022 A.D.

#	:man- trustee	:association	:year, :day	USPO, other	:covenant
1	:c/o: Sadie-Jo: Bingham	:Arizona-State-Gila-County-Trustee: Recorder	12/30/21	RMN RE 322 390 358 US	Mitigation -request for the removal of the libel-statements-made into the public-record in the violation by the right: DOI-1776-AD.
2	:Taylor: Holland	↓	01-03-2022	↓	:Return with a charge with the no- mention of the ceasing of the libel-required.
3	:Stev: Christensen	:Arizona-State-Gila-County-Trustee: Board-Officer	01-12-2022	CMN 7009 1410 0000 7868 5826	Notice of the Default with the Choice for the Correction: 12-30-21: RMN 322 390 358 US - Request for the cease of the Libel.
4	:Tim-R: Humphrey	↓	↓	↓	↓
5	:Woody: Cline	↓	↓	↓	↓
6	:Marian: Shephard	:Arizona-State-Gila-County-Trustee: Board-Clerk of the Board	↓	↓	↓
7	:c/o: Sadie-Jo: Bingham	:Arizona-State-Gila-County-Trustee: Recorder	↓	[RMN RE 322 390 836 US]	NOT MAILED

2022-011769 MISC Page: 2191 of 2782
 09/26/2022 03:35:37 PM Receipt #: 22-9381
 Rec Fee: \$30.00 Darrell James Hill
 Gila County, Az, Sadie Jo/Bingham, Recorder





REGISTERED MAIL™



RE 322 390 836 US

Label 200, August 2005 PSN 7690-03-000-9311

USPO CMN 7009 1410 0000 7868 5826

USPO RMN RE 322 390 836 US

:Darrell-James: Hill, -:Ohioan,
-:beneficiary, -:Executor: PE¹-2016-A.D.²,
:Beverly-Jean: Romero- Hill, -:New- Mexican,
-:beneficiary, -:Executor: PE-2016-A.D.³
USPO- General-Delivery-Mail
Mayer, Arizona [86333]

to: Steve: Christensen, -:Trustee,
:Tim-R.: Humphrey, -:Trustee,
:Woody: Cline, -:Trustee,
-:Arizona-State-Gila-County-Board-Officers;
c/o: Marian: Shephard, -:Trustee,
-:Clerk of the Board: Gila-County
1400 East Ash Street
Globe, Arizona [85501];

c/o: Sadie-Jo: Bingham, -:Trustee,
-:Arizona-State-Gila-County-Recorder-Officer
with: Taylor: Holland⁴
1400 East Ash, Globe, Arizona [85501]

:notice of the default with the option-to-cure

:notice: Default in the Dishonor upon the Beneficiary- Hill-Executors-mitigation of the
indictment-damages with the notice- RE 322 398 358 US to the Arizona-State-Gila-County-
Recorder-Trustee-Officer -:Sadie-Jo: Bingham. -See: the- response by the Taylor-
Holland -:Proof-of-Claim: A~

Greetings: Steve, Tim, Woody, Marian, Sadie, Taylor,
:- man accept your Loyalty-of-Oaths-of-Office⁵.

- 1 :PE means: political election, express- covenant with the trustee in the nature of the Foreign-Sovereign-Immunity Act -FSIA- of 1976-A.D.: Public Law 94-583, 90 Stat. 2891.
- 2 :Darrell-James: Hill, -:Ohioan-beneficiary, -:Executor means: See: historical-documents: Superior constructive Notice and Demand: Permanent Non-Commerical Presumption, and: Constructive Notice : 'DARRELL JAMES HILL' of 'Darrell-James: of the family Hill', authorized Representative. -:Gila-county-Arizona-Doc.#: 2017-002378: pp. 1-24, 93-95.
- 3 :Beverly-Jean: Romero- Hill, -:New-Mexican-beneficiary, -:Executor -:PE-2016-A.D. means: See: historical-documents: Superior constructive Notice and Demand: Permanent Non-Commerical Presumption, and: Constructive Notice. 'BEVERLY JEAN ROMERO- HILL' of 'Beverly-Jean; of the family Romero- Hill', authorized Representative. -:Gila-county-Arizona-Doc.#: 2017-002378: pp. 1-4, 26-44, 93-95.
- 4 :Taylor: Holland means: signum/signor for the Trustee. See: Proof-of-Claim: A: RE 322 398 358 US, with the :January 3, 2002, -:Letter with -:Receipt: 22-0058 from the Sadie-Joe: Bingham: Gila-County-Recorder for the USPO-RMN: RE 322 398 358 US- Correction-request in the mitigation of the damage upon the beneficiary:Darrell-James: Hill, -:Ohioan, and: Beverly-Jean: Romero- Hill, New-Mexican, Appended: 13 pages.
- 5 :Loyalty-of-Oaths-of-Office means: See: Proof-of-Claim: B: man- Shephard, Adam: Gila-County-Recorder-Doc.##: 2013-000101, 2016-011592, 2020-015882, :man- Christensen, Steve: Doc.#: 2021-000513, :man-Humphrey, Tim: Doc.##: 2016-011648, 2020-015881, :man- Cline, Woody: Doc.##:

:notice: Default with Option to Cure: RE 322 390 822 US

1 / 5

2083

2022-011769 MISC Page: 2192 of 2782
 09/26/2022 03:35:37 PM Receipt #: 22-9381
 Rec Fee: \$30.00 Darrell James Hill
 Gila County, Az, Sadie Jo Bingham, Recorder

:Mitigation of the damages

:The -Necessary-notice-RE 322 398 358 US-made for the non-competition-mitigation of :damages is-now-after-made with the competition-harm upon the beneficiary with the non-hope of the Trustee-honor by the Trustee -:Sadie-Jo: Arizona-State-Gila-County-Recorder-Officer. See the -:response of the signum: TAYLOR HOLLAND by the Arizona-State-Gila-County-Recorder-Trustee-Officer: Sadie-Jo: Bingham -:Proof-of-Claim: A-

:Damage to the Exclusive-absolute-private-property by the Declaration-of-Independence of 1776 -DOI-1776-A.D.- -covenant

For the necessary-notice- RE 322 398 358 US- made with the honor and specific law-request to the Arizona-State-Gila-County-Recorder-Trustee-Officer: Sadie-Jo: Bingham is-now with the Trustee-derelection in the wrong-doing-status in the accordance with the First-Offense-Damage⁶: PE-2016-A.D. -:DOI-1776-A.D.- covenant by the law of the PE-2016-A.D.-covenant.

:Bill-of-Particulars

For the deprivation of the rights without the due-process or express-authorization with the damage upon the Beverly-Jean: Romero- Hill and Darrell-James: Hill- beneficiary- :DOI-1776-A.D.-rights is with the deprivation in the denial/ignoring of the mitigation-remedy-sought by the law of the PE-2016-A.D.-covenant- agreement: notice-RE 322 398 358 US-made for the non-competition-mitigation of :damages. See: **Proof-of-Claims: C: Darrell-James and Beverly-Jean: Bills-of-Particulars: December-30-2021-A.D. - January-11-2022-A.D.- 5:00 P.M., -Now -DUE-paid-now?**; appended: 3 pages.

Notice to the Principal is the Notice to the Agent.

:Adam: Shepherd, -:Trustee,
-:Gila-County-Arizona-State-Sheriff
1425 E. South Street, PO Box 311
:Globe, Arizona [85502];

USPO RMN RE 322 390 822 US

:i- man verify that the above is true and correct to the best-ability, and will-state-same onto the record in the open-court.

:Without-prejudice,

Jan-12-2022

Darrell-James Hill, Executor

:Darrell-James: Hill,
-:Ohioan, -:beneficiary, -:Executor,
-:Executor- Procurator: Hill-Executors

Jan-12, 2022

Beverly-Jean Romero Hill, Executor

:Beverly-Jean: Hill,
-:New-Mexican, -:beneficiary, -:Executor

2016-011650, 2020-015885, :man- Marian: Shephard: Doc.#: 2005-007467, :man- Holland, Taylor:Doc.#: 2021-017314; appended: 25 pages.

6 :PE-2016-A.D.- :First-Offense-Damages -:covenant- agreements means: I bid 1, 2, 3. For: Darrell- James, see: Gila-County-Recorder-Doc.#: 2017-002378, p 16: First-Offense-Damage. For: Beverly-Jean: Romero- Hill, see: Gila-County-Recorder-Doc.#: 2017-002378, p 41: First-Offense-Damage.

7 :See: **Proof-of-Claims: C: Darrell-James and Beverly-Jean: Bills-of-Particulars Bills-of-Particulars: December-30-2021-A.D. - January-11-2022-A.D.- 5:00 P.M., -Now -DUE-paid-now?**; appended: 4 pages.

:notice: Default with Option to Cure: RE 322 390 822 US

215

2084

2022-011769 MISC Page: 2193 of 2782

09/26/2022 03:35:37 PM Receipt #: 22-9381
Rec Fee: \$30.00 Darrell James Hill
Gila County, Az, Sadie Jo Bingham, Recorder



**See: Proof-of-Claim: A:
RE 322 398 358 US, with the :January 3, 2002 -:response-
Letter with -:Receipt: 22-0058
from the Sadie-Joe: Bingham: Gila-County-Recorder
for the USPO-RMN: RE 322 398 358 US- Correction-request
in the mitigation of the damage upon the beneficiary:
Darrell-James: Hill, -:Ohioan, and:
Beverly-Jean: Romero- Hill, New-Mexican,
Appended: 13 pages.**

2085
:notice: Default with Option to Cure: RE

2022-011769 MISC Page: 2194 of 2782
09/26/2022 03:35:37 PM Receipt #: 22-9391
Rec Fee: \$30.00 Darrell James Hill
Gila County, Az, Sadie Jo Bingham, Recorder



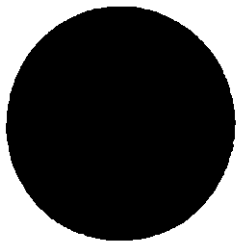

Sadie Jo Bingham
 Gila County Recorder
 1400 East Ash Street
 Globe, AZ 85501
 928-402-8740

Gila County, AZ
 Sadie Jo Bingham, Recorder
 1400 East Ash
 Globe, Arizona 85501

Date: January 3, 2022

To: DARRELL-JAMES HILL
 P.O. BOX 3806
 APACHE JUNCTION, AZ 85117

Receipt: 22-0058

Product	Name	Extended
REJ	Rejection Letter	\$0.00
Document# REJ-2022-001830, Document Info: DARRELL-JAMES HILL, Document Pages 7		
Total		\$0.00
Change (Cash)		\$0.00

Returned Item(s): MISC

Check Number(s): NO CHECK

Thank You!

Mon Jan 03 14:28:58 MST 2022 TLH

Your document(s) is/are being returned due to:
 Insufficient fees

Remarks:

There is a \$30.00 fee to record this document. Please note there has been a \$2.00 notification fee added for the return. Please make the necessary changed and resubmit.

Unofficial

2088

Total amount due when returning this document for recording: \$32.00

If you have any questions call (928) 425-3231 ext 8740.

Thank you,

TAYLOR HOLLAND

2022-011769 MISC Page: 2195 of 2782
 09/26/2022 03:35:37 PM Receipt #: 22-9381
 Rec Fee: \$30.00 Darrell James Hill
 Gila County, Az, Sadie Jo Bingham, Recorder



:Darrell-James: Hill, -:Ohioan- beneficiary, :Executor, and
:Beverly-Jean: Romero- Hill, :New-Mexican- beneficiary, -:Executor
-Hill-Executors: PE-2016-A.D.-covenant- agreements¹-
c/o: PO Box 3806
Apache-Junction, Arizona [85117]

:Sadie-Jo: Bingham², -:Recorder, -:Trustee
c/o: Gila-County-Recorder-Office
1400 East Ash, Globe, Arizona [85501]

:notice: For the obfuscation and slander-damage-imposed on the Hill-Executors is with the deprivation-penalty-covenant-agreements and mitigation-requests-made- herein of the Hill-Executors- PE-2016-A.D.- covenants with the Arizona-State-Gila- County-Trustee -Recorder -Doc.## -2005-022460³, 2007-007742⁴, and 2007-007743⁵ 6. recordation-obligations by the law of the PE-2016-A.D.- covenant-agreements.

Greetings Sadie-Jo:

1. :i- man- Darrell-James: Hill, -:Ohioan, et al., -:Executor, et al., and :Beverly-Jean: Romero- Hill, -:New-Mexican, et al., -:Executor, et al., accept your Loyalty-of-Oath of the Arizona-State-Gila-County-Trustee-Office.

Doc.#: 2005-022460- obfuscation and slander- damage upon the Hill-Executors

2) For the Mitigation⁷: obfuscation: Doc.#: 2005-022460, upon the receipt of this SOLE-request the -:view-ability and common-access -obfuscation of the Gila-County-Recorder-Doc.#-:2005-022460 must-end-now-to-after by the law of the PE-2016-A.D.- covenant-agreement.

3) For the Mitigation: slander: Doc.#: 2005-022460, upon the receipt of this SOLE-request the -:'INCOME TAX PROTEST'-slander-damage in the record must-end-now-to- after by the law of the PE-2016-A.D.- covenant-agreement.

Doc.#: 2007-007742 - slander- damage upon the Hill-Executors

4) For the Mitigation: slander: Doc.#: 2007-007742, upon the receipt of this SOLE-request the -:'TAX PROTEST'-slander-damage in the record must-end-now-to-after by the law of the PE-2016-A.D.-covenant-agreement.

Doc.#: 2007-007743 - slander- damage upon the Hill-Executors

5) For the Mitigation: slander: Doc.#: 2007-007743, upon the receipt of this SOLE-request the -:'TAX PROTEST'-slander-damage in the record must-end-now-to-after by the law of the PE-2016-A.D.-covenant-agreement.

:i- man verify the above is true and correct to my best ability, and will state same in the open court.

Without prejudice,

December-30- 2021

Darrell-James Hill, -:Executor
:Darrell-James: Hill, -:Ohioan, -:Executor

December-30- 2021

Beverly-Jean Romero Hill, New Mexican, -Executor
:Beverly-Jean: Romero- Hill, -:New-Mexican, -:Executor

1 :Hill-Executors: PE-2016-A.D.- covenant-agreements means: See -:Gila-County-Rec.-Doc.#: 2017-002378, pp. 1- 181.

2 :Sadie-Jo: Bingham means: man: Arizona-State-Gila-County-Office, - See -:Gila-County-Rec.-Doc.##: 2017-000110; 2021-000771, -:Loyalty-of-Oath-of-Office. - See: appended, 4 pages.

3 :Doc.#: 2005-022460 means: reference to :Gila-County-Rec.-Doc.#: 2005-022460.

4 :Doc.#: 2007-007742 means: reference to: Gila-County-Rec.-Doc.#: 2007- 007742.

5 :Doc.#: 2007-007743 means: reference to: Gila-County-Rec.-Doc.#: 2007- 007743.

6 See: appended: Gila-County-Rec.-doc.Summary: GrantorID for: Hill, darrell- copy; 2 pgs.

7 :Mitigation means: Damage-alleviation, -:remedy, :abatement or diminution of the penalty or punishment imposed by the law; in the nature of the Black's-Law-Dict., 4th Ed., p. 1153.

:Necessary-Doc.-:Corrections- request: Dec.30.2021-A.D.-P.M.N.D.E. 2022-011769



2087



When recorded, Return to

Attention: Eric Mariscal
Gila County Division of Elections



UNOFFICIAL COPY

Loyalty of Oath of Office

Do Not remove this sheet, it is part of the Recorded Document

UNOFFICIAL COPY
2088



OATH OF OFFICE

I, the undersigned, hereby execute this document in compliance with A.R.S. § 38-231:

OFFICERS AND EMPLOYEES REQUIRED TO TAKE LOYALTY OATH: CLASSIFICATION: DEFINITION

- A. In order to ensure the statewide application of this section on a uniform basis, each board, commission, agency and independent office of this state, and of any of its political subdivisions, and of any county, city, town, municipal corporation, school district and public educational institution, shall completely reproduce this section so that the form of written oath or affirmation required in this section contains all of the provisions of this section for use by all officers and employees of all boards, commissions, agencies and independent offices.
- B. Any officer or employee who fails to take and subscribe to the oath or affirmation provided by this section within the time limits prescribed by this section is not entitled to any compensation until the officer or employee does so take and subscribe to the form of oath or affirmation prescribed by this section.
- C. Any officer or employee having taken the form of an oath or affirmation prescribed by this section and knowingly at the time of subscribing to the oath or affirmation, or at any time thereafter during the officer's or employee's term of office or employment, does commit or aid in the commission of any act to overthrow by force, violence or terrorism defined in section 13-2301 the government of this state or any of its political subdivisions, or advocates the overthrow by force, violence or terrorism as defined in section 13-2301 of the government of this state or of any of its political subdivisions, is guilty of a class 4 felony and, on conviction under this section, the officer or employee is deemed discharged from the office or employment and is not entitled to any additional compensation or any other emoluments or benefits which may have been incident or appurtenant to the office or employment.
- D. Any of the persons referred to in article XVIII, section 10, Constitution of Arizona, as amended, relating to the employment of aliens, are exempted from any compliance with this section.
- E. In addition to any other form of oath or affirmation specifically provided by law for an officer or employee, before any officer or employee enters upon the duties of the office or employment, the officer or employee shall take and subscribe the following oath or affirmation: (Below)
- F. For the purposes of this section, "officer or employee" means any person elected, appointed or employed, either on a part-time or full time basis, by this state or any of its political subdivisions or any county, city, town, municipal corporation, school district or public educational institution or any board, commission or agency of any county, city, town, municipal corporation, school district or public educational institution.

A.R.S. § 38-231 (E) Oath:

State of Arizona, County of Gila

I, Sadie Jo Bingham do solemnly swear (or affirm) that I will support the Constitution of the United States and the Constitution and laws of the State of Arizona; that I will bear true faith and allegiance to the same, and defend them against all enemies, foreign and domestic, and that I will faithfully and impartially discharge the duties of Gila County Recorder according to the best of my ability, so help me God (or so do I affirm).

Sadie Jo Bingham
Signature

Subscribed and sworn (or affirmed) to before me on this 19th day of January, 2021.

(SEAL)

Erica Mariscal
Notary Public

 ERICA MARISCAL
Notary Public - State of Arizona
GILA COUNTY
My Commission Expires
August 11, 2021





When recorded, Mail to

Attention: Eric Mariscal
Gila County Division of Elections

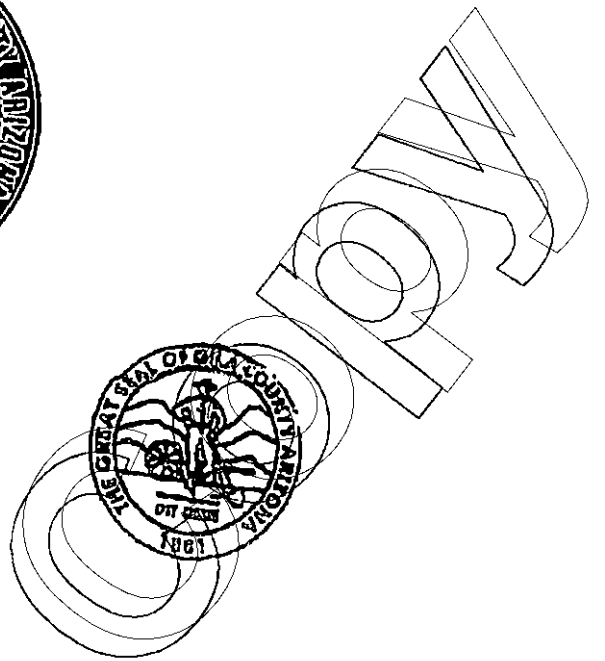

Loyalty of Oath of Office

Do Not remove this sheet, it is part of the Recorded Document

2022-011769 MISC Page: 2199 of 2782
09/26/2022 03:35:37 PM Receipt #: 22-9381
James Hill
Rec Fee: \$30.00 Darrell Jo Bingham, Recorder
Gila County, Az, Sadie Jo Bingham, Recorder

2017-000110 OATH Page: 1 of 2
01/04/2017 03:42:58 PM Receipt #: 17-0073
Rec Fee: \$0 Gila County Elections
Gila County, Az, Sadie Jo Bingham, Recorder

OATH OF OFFICE
Gila County Recorder

I, the undersigned, hereby execute this document in compliance with A.R.S. § 38-231 and § 11-542:
OFFICERS AND EMPLOYEES REQUIRED TO TAKE LOYALTY OATH; CLASSIFICATION; DEFINITION

- A. In order to ensure the statewide application of this section on a uniform basis, each board, commission, agency and independent office of this state, and of any of its political subdivisions, and of any county, city, town, municipal corporation, school district and public educational institution, shall completely reproduce this section so that the form of written oath or affirmation required in this section contains all of the provisions of this section for use by all officers and employees of all boards, commissions, agencies and independent offices.
- B. Any officer or employee who fails to take and subscribe to the oath or affirmation provided by this section within the time limits prescribed by this section is not entitled to any compensation until the officer or employee does so take and subscribe to the form of oath or affirmation prescribed by this section.
- C. Any officer or employee having taken the form of an oath or affirmation prescribed by this section and knowingly at the time of subscribing to the oath or affirmation, or at any time thereafter during the officer's or employee's term of office or employment, does commit or aid in the commission of any act to overthrow by force, violence or terrorism defined in section 13-2301 the government of this state or any of its political subdivisions, or advocates the overthrow by force, violence or terrorism as defined in section 13-2301 of the government of this state or of any of its political subdivisions, is guilty of a class 4 felony and, on conviction under this section, the officer or employee is deemed discharged from the office or employment and is not entitled to any additional compensation or any other emoluments or benefits which may have been incident or appurtenant to the office or employment.
- D. Any of the persons referred to in article XVIII, section 16, Constitution of Arizona, as amended, relating to the employment of aliens, are exempted from any compliance with this section.
- E. In addition to any other form of oath or affirmation specifically provided by law for an officer or employee, before any officer or employee enters upon the duties of the office or employment, the officer or employee shall take and subscribe the following oath or affirmation: (Below)
- F. For the purposes of this section, "officer or employee" means any person elected, appointed or employed, either on a part-time or full time basis, by this state or any of its political subdivisions or any county, city, town, municipal corporation, school district or public educational institution or any board, commission or agency of any county, city, town, municipal corporation, school district or public educational institution.

A.R.S. § 38-231 (E) Oath:

State of Arizona, County of Gila

Sadie Jo Bingham do solemnly swear (or affirm) that I will support the Constitution of the United States and the Constitution and laws of the State of Arizona; that I will bear true faith and allegiance to the same, and defend them against all enemies, foreign and domestic, and that I will faithfully and impartially discharge the duties of office of Gila County Recorder according to the best of my ability, so help me God (or so do I affirm).

Sadie Jo Bingham
Signature

Subscribed and sworn (or affirmed) to before me on this 3rd day of January 2017

Kaycee Stratton
Notary Public

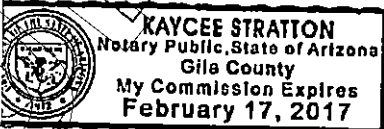

2017-000110 OATH Page: 2 of 2
01/04/2017 03:42:58 PM Receipt #: 17-0073
Rec Fee: \$0 Gila County Elections
Gila County, Az, Sadie Jo Bingham, Recorder

2022-011769 MISC Page: 2200 of 2782
09/26/2022 03:35:37 PM Receipt #: 22-9381
Rec Fee: \$30.00 Darrell James Hill
Gila County, Az, Sadie Jo Bingham, Recorder

2091



APACHE JUNCTION
151 W SUPERSTITION BLVD
APACHE JUNCTION, AZ 85120-9998
(800)275-8777

12/30/2021 10:35 AM

Product	Qty	Unit Price	Price
---------	-----	------------	-------

First-Class Mail® Large Envelope	1		\$2.56
----------------------------------	---	--	--------

Florence, AZ 85132
Weight: 0 lb 7.20 oz
Estimated Delivery Date
Mon 01/03/2022

Registered Mail®		\$14.35
------------------	--	---------

Amount: \$21.00
Tracking #: RE322390840US

Return Receipt		\$3.05
----------------	--	--------

Tracking #: 9590 9402 4718 8344 9618 32

Total		\$19.96
-------	--	---------

First-Class Mail® Letter	1		\$0.78
--------------------------	---	--	--------

Globe, AZ 85501
Weight: 0 lb 1.40 oz

Registered Mail®		\$14.35
------------------	--	---------

Amount: \$21.00
Tracking #: RE322398358US

Return Receipt		\$3.05
----------------	--	--------

Tracking #: 9590 9402 4718 8344 9594 19

Total		\$18.18
-------	--	---------

Grand Total:		\$38.14
--------------	--	---------

Cash		\$50.00
------	--	---------

Change		-\$11.86
--------	--	----------

Registered No. RE322398358US

Date Stamp

0130

24

Reg. Fee	\$0.78	
Handling Charge	\$14.35	Return Receipt
Postage	\$3.05	Restricted Delivery
Received by	\$0.00	
		\$18.18

To Be Completed By Post Office

Customer Must Declare Full Value \$21.00
Domestic Insurance up to \$5,000 included
\$21.00 from the declared value. International
insurance is limited. (See Reverse).

OFFICIAL USE

To Be Completed By Customer (Please Print) All Entries Must Be In Ballpoint or Typed

FROM
Darrell James Hill, Executor
Beverly Jean Romero Hill, Executor
P.O. Box 3806
Apache Junction Arizona (85117)
TO
Sadie Jo Bingham - Trustee
Gila County Recorder Office
1400 East Ash Ave
Globe Arizona (85501)

PS Form 3806, Receipt for Registered Mail - Copy 1 - Customer
May 2007 (7530-02-000-9051) (See Information on Reverse)
For domestic delivery information, visit our website at www.usps.com®

CLIP

2022-011769 MISC Page: 2201 of 2782

09/25/2022 03:35:37 PM Receipt #: 22-9981
Darrell James Hill
Beverly Jean Romero Hill
Sadie Jo Bingham, Recorder
Gila County, Az

SENDER: COMPLETE THIS SECTION

- Complete items 1, 2, and 3.
- Print your name and address on the reverse so that we can return the card to you.
- Attach this card to the back of the mailpiece, or on the front if space permits.

1. Article Addressed to:
Sadie Jo Bingham, Recorder
Trustee
Co. Gila County Recorder Office
1400 East Ash,
Globe, Arizona (85501)



9590 9402 4718 8344 9594 19

2. Article Number (Transfer from service label)
RE 322 398 358 US

PS Form 3811, July 2015 PSN 7530-02-000-9053

COMPLETE THIS SECTION ON DELIVERY

A. Signature
X *J. Nello Green* Agent Addressee

B. Received by (Printed Name) C. Date of Delivery
Jo Nello Green 1/3/22

D. Is delivery address different from item 1? Yes No
If YES, enter delivery address below:

3. Service Type
- Adult Signature
 - Adult Signature Restricted Delivery
 - Certified Mail®
 - Certified Mail Restricted Delivery
 - Collect on Delivery
 - Collect on Delivery Restricted Delivery
 - Insured Mail
 - Insured Mail Restricted Delivery (over \$500)
 - Priority Mail Express®
 - Registered Mail™
 - Registered Mail Restricted Delivery
 - Return Receipt for Merchandise
 - Signature Confirmation™
 - Signature Confirmation Restricted Delivery

Domestic Return Receipt

USPS Tracking®

[FAQs >](#)

[Track Another Package +](#)

Tracking Number: RE322398358US

[Remove X](#)

Your item was delivered to an individual at the address at 8:05 am on December 31, 2021 in GLOBE, AZ 85501.

Delivered, Left with Individual

December 31, 2021 at 8:05 am
GLOBE, AZ 85501

[Feedback](#)

[Get Updates v](#)

Text & Email Updates



Tracking History



December 31, 2021, 8:05 am
Delivered, Left with Individual
GLOBE, AZ 85501

Your item was delivered to an individual at the address at 8:05 am on December 31, 2021 in GLOBE, AZ 85501.

2093
2022-011769 MISC Page: 2202 of 2782
09/26/2022 03:35:37 PM Receipt #: 22-9381
Rec Fee: \$30.00 Darrell James Hill
Gila County, Az, Sadie Jo Bingham, Recorder



December 31, 2021, 8:05 am

Arrived at Post Office

GLOBE, AZ 85501

December 30, 2021, 10:18 pm

Departed USPS Facility

PHOENIX, AZ 85026

December 30, 2021, 10:17 pm

Arrived at USPS Facility

PHOENIX, AZ 85026

December 30, 2021, 4:41 pm

Departed Post Office

APACHE JUNCTION, AZ 85120

December 30, 2021, 10:31 am

USPS in possession of item

APACHE JUNCTION, AZ 85120

Feedback

Product Information



See Less ^

Can't find what you're looking for?

Go to our FAQs section to find answers to common questions.

2022-011769 MISC Page: 2203 of 2782
09/26/2022 03:35:37 PM Receipt #: 22-9381
Rec Fee: \$30.00 Darrell James Hill
Gila County, Az, Sadie Jo Bingham, Recorder



[New Search](#) [Modify Search](#) [Printable Version](#)

You searched for: RecDateID >= Sat Feb 02 00:00:00 MST 1985 and <= Tue Dec 21 00:00:00 MST 2021 and exact search in GrantorID for Hill, darrell

10 items found, displaying all items.1

Description	Summary	
Affidavit 2005-022460	<p>Rec Date: 12/07/2005 02:18:00 PM LiberPage: Related: Grantor: HILL DARRELL J, ROMERO Legal: HILL BEVERLY J, HILL BEVERLY J ROMERO, SUPERIOR CLAIMS MANAGEMENT Grantee: HILL DARRELL J, ROMERO Notes: INCOME TAX PROTEST, HILL BEVERLY J, HILL BEVERLY J MANY, EXHIBITS NOT LEGIBLE ROMERO, SUPERIOR CLAIMS ENOUGH, TO, REPRODUCE WELL MANAGEMENT</p>	<p>Add All to My Images View Image Add to My Images</p>
Miscellaneous Instrument 2006-008777	<p>Rec Date: 05/22/2006 02:49:00 PM LiberPage: Related: Grantor: HILL DARRELL JAMES Legal: Grantee: HILL DARRELL JAMES Notes:</p>	<p>View Image Add to My Images</p>
Miscellaneous Instrument 2007-007742	<p>Rec Date: 05/04/2007 02:17:00 PM LiberPage: Related: Grantor: HILL DARRELL JAMES Legal: Grantee: HILL DARRELL JAMES Notes: TAX PROTEST CV 05 0877 PHX DGC</p>	<p>View Image Add to My Images</p>
Miscellaneous Instrument 2007-007743	<p>Rec Date: 05/04/2007 02:17:00 PM LiberPage: Related: Grantor: HILL DARRELL JAMES Legal: Grantee: HILL DARRELL JAMES Notes: TAX PROTEST RB 898 807 966 US</p>	<p>View Image Add to My Images</p>
Miscellaneous Instrument 2017-002378	<p>Rec Date: 03/10/2017 12:35:10 PM LiberPage: Related: Grantor: HILL DARRELL JAMES, Legal: HILL BEVERLY JEAN ROMERO Grantee: HILL DARRELL JAMES, Notes: HILL BEVERLY JEAN ROMERO</p>	<p>View Image Add to My Images</p>
Affidavit 2017-006522	<p>Rec Date: 07/07/2017 10:09:05 AM LiberPage: Related: 2017-002378 Grantor: HILL DARRELL JAMES Legal: Grantee: HILL DARRELL JAMES Notes: PROOF OF CLAIM</p>	<p>View Image Add to My Images</p>
Miscellaneous Instrument 2018-005176	<p>Rec Date: 05/14/2018 02:29:31 PM LiberPage: Related: 2017-002378 Grantor: HILL DARRELL JAMES, Legal: ROMERO HILL BEVERLY JEAN, HILL BEVERLY JEAN ROMERO Grantee: HILL DARRELL JAMES, Notes: AFFIDAVIT STATEMENT OF ROMERO HILL BEVERLY JEAN, HILL CLAIM BEVERLY JEAN ROMERO</p>	<p>View Image Add to My Images</p>
Miscellaneous Instrument 2019-009291	<p>Rec Date: 08/30/2019 02:24:05 PM LiberPage: Related: 2017-002378, 2017-006522, 2018-005176 Grantor: HILL DARRELL JAMES Legal: Grantee: HILL DARRELL JAMES Notes:</p>	<p>View Image Add to My Images</p>
Miscellaneous Instrument 2019-011722	<p>Rec Date: 10/29/2019 11:47:58 AM LiberPage: Related: 2017-002378, 2017-006522, 2018-005176, 2019-009291 Grantor: HILL DARRELL JAMES, Legal: ROMERO HILL BEVERLY JEAN, HILL BEVERLY JEAN ROMERO, INGOLD JAY ROY, CALHOUN TRACY ROBERT, ... Grantee: HILL DARRELL JAMES, Notes: ROMERO HILL BEVERLY JEAN, HILL BEVERLY JEAN ROMERO, INGOLD JAY ROY, CALHOUN TRACY ROBERT ...</p>	<p>View Image Add to My Images</p>

2022-011769 MISC Page: 2204 of 2782
 09/26/2022 03:35:37 PM Receipt #: 22-9381
 Rec Fee: \$30.00 Darrell James Hill
 Gila County, Az, Sadie Jo Bingham, Recorder



Description	Summary	Add All to My Images
Miscellaneous Instrument 2021-016195	<p>Rec Date: 12/02/2021 10:19:01 AM LiberPage: Related: 2005-022460, 2006-008777, 2007-007742, 2007-007743, 2017-002378, ...</p> <p>Grantor: HILL DARRELL-JAMES, HILL BEVERLY-JEAN ROMERO-, ROMERO-HILL BEVERLY-JEAN, INGOLD JAY-ROY</p> <p>Grantee: HILL DARRELL-JAMES, HILL BEVERLY-JEAN ROMERO-, ROMERO-HILL BEVERLY-JEAN, INGOLD JAY-ROY</p>	View Image Add to My Images
10 items found, displaying all items.1		
New Search Modify Search Printable Version		

2696

Unofficial Copy

2022-011769 MISC Page: 2205 of 2782
 09/26/2022 03:35:37 PM Receipt #: 22-9381
 Rec Fee: \$30.00 Darrell James Hill
 Gila County, Az, Sadie Jo Bingham, Recorder



2022-011769 MISC Page: 2206 of 2782
09/26/2022 03:35:37 PM Receipt #: 22-9381
Rec Fee: \$30.00 Darrell James Hill
Gila County, Az, Sadie Jo Bingham, Recorder



SADIE JO BINGHAM
Gila County Recorder
1400 E. Ash St.
Globe, Arizona 85501

PHOENIX AZ 852

4 JAN 2022 PM 5

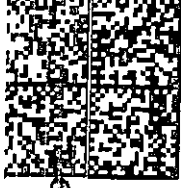

quivalent

FIRST-CLASS MAIL
IMI

\$000.73⁰⁰

01/03/2022 ZIP 85501
043M31219966

US POSTAGE

Ref: REJ-2022-001830
DARRELL-JAMES HILL
P.O. BOX 3806
APACHE JUNCTION, AZ 85117

85117-413706

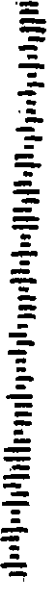

Official Copy

2022-011769 / MISC Page: 2207 of 2782
09/28/2022 03:35:37 PM Receipt #: 22-9381
Rec Fee: \$20.00 Darrell James Hill
Gila County, Az, Sadie Jo Bingham, Recorder



Official Copy

See: Proof-of-Claim: B:
man- Shepherd, Adam: Gila-County-Recorder-Doc.##: 2013-
000101, 2016-011592, 2020-015882,
:man- Christensen, Steve: Doc.#: 2021-000513,
:man-Humphrey, Tim: Doc.#: 2016-011648, 2020-015881,
:man- Cline, Woody: Doc.##: 2016-011650, 2020-015885,
:man- Marian: Shephard: Doc.#: 2005-007467,
:man- Holland, Taylor: Doc.#:2021-017314;
appended: 25 pages.

:notice: Default with Option to Cure: RE 322 390 822 US

[New Search](#) [Modify Search](#) [Printable Version](#)

You searched for: RecDateID >= Sat Feb 02 00:00:00 MST 1985 and <= Thu Jan 06 00:00:00 MST 2022 and exact search in GrantorID for SHEPHERD ADAM

3 items found, displaying all items.1

Description	Summary	Add All to My Images
Oath 2013-000101	Rec Date: 01/04/2013 10:51:26 AM LiberPage: Related: Grantor: SHEPHERD ADAM, SHEPHERD J ADAM Legal: Grantee: SHEPHERD ADAM, SHEPHERD J ADAM Notes: LOYALTY OATH	View ImageAdd to My Images
Oath 2016-011592	Rec Date: 12/14/2016 10:04:46 AM LiberPage: Related: Grantor: SHEPHERD ADAM Legal: Grantee: SHEPHERD ADAM Notes: GILA COUNTY SHERIFF, LOYALTY OATH	View ImageAdd to My Images
Oath 2020-015882	Rec Date: 12/23/2020 12:30:13 PM LiberPage: Related: Grantor: SHEPHERD ADAM Legal: Grantee: SHEPHERD ADAM Notes:	View ImageAdd to My Images

3 items found, displaying all items.1

[New Search](#) [Modify Search](#) [Printable Version](#)

Unofficial

2022-011769 MISC Page: 2208 of 2782
 09/26/2022 03:35:37 PM Receipt #: 22-9381
 Rec Fee: \$30.00 Darrell James Hill
 Gila County, Az, Sadie Jo Bingham, Recorder





When recorded, Return to

Attention: Eric Mariscal
Gila County Division of Elections

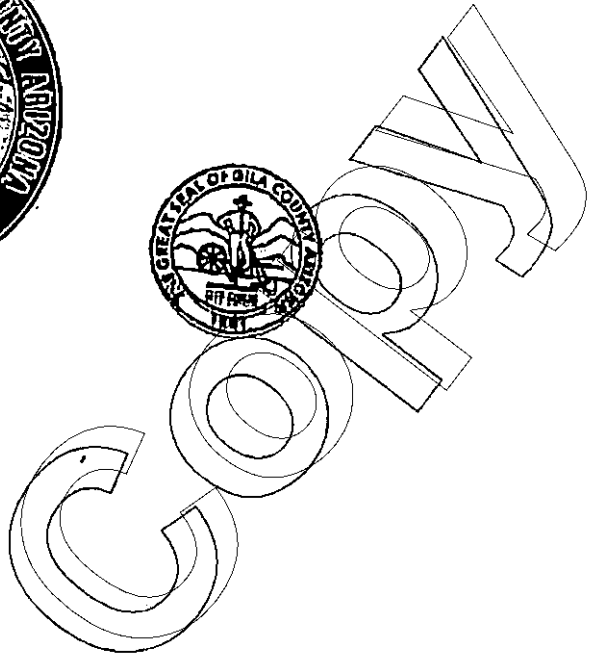

Loyalty of Oath of Office

Do Not remove this sheet, it is part of the Recorded Document

2022-011769 MISC Page: 2209 of 2782
09/26/2022 03:35:37 PM Receipt #: 22-9381
Rec Fee: \$30.00 Darrell James Hill
Gila County, Az, Sadie Jo Bingham, Recorder



2020-015882 OATH - Page: 1 of 2
12/23/2020 12:30:13 PM Receipt #: 20-12958
Rec Fee: \$0 Gila County Elections Dept
Gila County, Az, Sadie Jo Bingham, Recorder



OATH OF OFFICE

2020 DEC 16 PM 1:02

I, the undersigned, hereby execute this document in compliance with A.R.S. § 38-231:

OFFICERS AND EMPLOYEES REQUIRED TO TAKE LOYALTY OATH: CLASSIFICATION: DEFINITION

- A. In order to ensure the statewide application of this section on a uniform basis, each board, commission, agency and independent office of this state, and of any of its political subdivisions, and of any county, city, town, municipal corporation, school district and public educational institution, shall completely reproduce this section so that the form of written oath or affirmation required in this section contains all of the provisions of this section for use by all officers and employees of all boards, commissions, agencies and independent offices.
- B. Any officer or employee who fails to take and subscribe to the oath or affirmation provided by this section within the time limits prescribed by this section is not entitled to any compensation until the officer or employee does so take and subscribe to the form of oath or affirmation prescribed by this section.
- C. Any officer or employee having taken the form of an oath or affirmation prescribed by this section and knowingly at the time of subscribing to the oath or affirmation, or at any time thereafter during the officer's or employee's term of office or employment, does commit or aid in the commission of any act to overthrow by force, violence or terrorism defined in section 13-2301 the government of this state or any of its political subdivisions, or advocates the overthrow by force, violence or terrorism as defined in section 13-2301 of the government of this state or of any of its political subdivisions, is guilty of a class 4 felony and, on conviction under this section, the officer or employee is deemed discharged from the office or employment and is not entitled to any additional compensation or any other emoluments or benefits which may have been incident or appurtenant to the office or employment.
- D. Any of the persons referred to in article XVIII, section 10, Constitution of Arizona, as amended, relating to the employment of aliens, are exempted from any compliance with this section.
- E. In addition to any other form of oath or affirmation specifically provided by law for an officer or employee, before any officer or employee enters upon the duties of the office or employment, the officer or employee shall take and subscribe the following oath or affirmations: (Below)

For the purposes of this section, "officer or employee" means any person elected, appointed or employed, either on a part-time or full time basis, by this state or any of its political subdivisions or any county, city, town, municipal corporation, school district or public educational institution or any board, commission or agency of any county, city, town, municipal corporation, school district or public educational institution.

A.R.S. § 38-231 (E) Oath:

State of Arizona, County of Gila

I, Adam Shepherd do solemnly swear (or affirm) that I will support the Constitution of the United States and the Constitution and laws of the State of Arizona; that I will bear true faith and allegiance to the same, and defend them against all enemies, foreign and domestic, and that I will faithfully and impartially discharge the duties of Gila County Sheriff according to the best of my ability, so help me God (or so do I affirm).

Signature

Adam Shepherd

Subscribed and sworn (or affirmed) to before me on this 15 day of December, 2020

(SEAL)

Notary Public

Ky Feezor

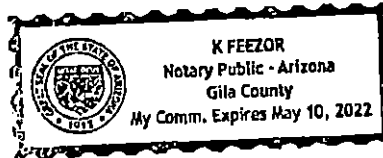

2022-011769 MISC Page: 2210 of 2782

09/25/2022 03:35:37 PM Receipt #: 22-9981
Darrell James Hill
Gila County, Az, Sadie Jo Bingham, Recorder

2020-015882 OATH Page: 2 of 2
12/23/2020 12:30:13 PM Receipt #: 20-12958
Rec Fee: \$0 Gila County Elections Dept
Gila County, Az, Sadie Jo Bingham, Recorder



When recorded, Mail to

Attention: Eric Mariscal
Gila County Division of Elections



Loyalty of Oath of Office

Do Not remove this sheet, it is part of the Recorded Document

2022-011769 MISC Page: 2211 of 2782
09/26/2022 03:55:37 PM Receipt #: 22-9381
Rec Fee: \$30.00 Darrell James Hill
Gila County, Az, Sadie Jo Bingham, Recorder

2016-011592 OATH Page: 1 of 2
12/14/2016 10:04:46 AM Receipt #: 16-8973
Rec Fee: \$0 Gila County Division of Elections
Gila County, Az, Sadie Jo Bingham, Recorder

OATH OF OFFICE

Gila County Sheriff

I, the undersigned, hereby execute this document in compliance with A.R.S. § 38-231 and § 11-542: OFFICERS AND EMPLOYEES REQUIRED TO TAKE LOYALTY OATH: CLASSIFICATION: DEFINITION

- A. In order to ensure the statewide application of this section on a uniform basis, each board, commission, agency and independent office of this state, and of any of its political subdivisions, and of any county, city, town, municipal corporation, school district and public educational institution, shall completely reproduce this section so that the form of written oath or affirmation required in this section contains all of the provisions of this section for use by all officers and employees of all boards, commissions, agencies and independent offices.
B. Any officer or employee who fails to take and subscribe to the oath or affirmation provided by this section within the time limits prescribed by this section is not entitled to any compensation until the officer or employee does so take and subscribe to the form of oath or affirmation prescribed by this section.
C. Any officer or employee having taken the form of an oath or affirmation prescribed by this section and knowingly at the time of subscribing to the oath or affirmation, or at any time thereafter during the officer's or employee's term of office or employment, does commit or aid in the commission of any act to overthrow by force, violence or terrorism defined in section 13-2301 the government of this state or any of its political subdivisions, or advocates the overthrow by force, violence or terrorism as defined in section 13-2301 of the government of this state or of any of its political subdivisions, is guilty of a class 4 felony and, on conviction under this section, the officer or employee is deemed discharged from the office or employment and is not entitled to any additional compensation or any other emoluments or benefits which may have been incident or appurtenant to the office or employment.
D. Any of the persons referred to in article XVIII, section 10, Constitution of Arizona, as amended, relating to the employment of aliens, are exempted from any compliance with this section.
E. In addition to any other form of oath or affirmation specifically provided by law for an officer or employee, before any officer or employee enters upon the duties of the office or employment, the officer or employee shall take and subscribe the following oath or affirmation: (Below)
F. For the purposes of this section, "officer or employee" means any person elected, appointed or employed, either on a part-time or full time basis, by this state or any of its political subdivisions or any county, city, town, municipal corporation, school district or public educational institution or any board, commission or agency of any county, city, town, municipal corporation, school district or public educational institution.

R.S. § 38-231 (E) Oath:

State of Arizona, County of Gila

Adam Shepherd do solemnly swear (or affirm) that I will support the Constitution of the United States and the Constitution and laws of the State of Arizona; that I will bear true faith and allegiance to the same, and defend them against all enemies, foreign and domestic, and that I will faithfully and impartially discharge the duties of office of Gila County Sheriff according to the best of my ability, so help me God (or so do I affirm).

Signature

Subscribed and sworn (or affirmed) to before me on this Dec 7 day of 2016

Notary Public

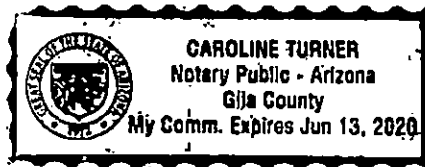

2022-011769 MISC Page: 2212 of 2782

09/26/2022 03:35:37 PM Receipt #: 22-9381 Darrell James Hill Gila County, Az, Sadie Jo Bingham, Recorder



1592 OATH Page: 2 of 2

12/14/2016 10:04:46 AM Receipt #: 16-8973 Rec Fee: \$0 Gila County Division Of Elections Gila County, Az, Sadie Jo Bingham, Recorder



When recorded deliver to:

Gila County Board of Supervisors
Attention: Linda Eastlick, Elections Director



**Oath of Office
County Sheriff
Adam Shepherd**

DO NOT REMOVE

This is part of the official document



UNOFFICIAL
2105

OATH OF OFFICE

Gila County Sheriff

I, the undersigned, hereby execute this document in compliance with A.R.S. § 38-231 and § 11-542:

OFFICERS AND EMPLOYEES REQUIRED TO TAKE LOYALTY OATH: CLASSIFICATION: DEFINITION

- A. In order to ensure the statewide application of this section on a uniform basis, each board, commission, agency and independent office of this state, and of any of its political subdivisions, and of any county, city, town, municipal corporation, school district and public educational institution, shall completely reproduce this section so that the form of written oath or affirmation required in this section contains all of the provisions of this section for use by all officers and employees of all boards, commissions, agencies and independent offices.
- B. Any officer or employee who fails to take and subscribe to the oath or affirmation provided by this section within the time limits prescribed by this section is not entitled to any compensation until the officer or employee does so take and subscribe to the form of oath or affirmation prescribed by this section.
- C. Any officer or employee having taken the form of an oath or affirmation prescribed by this section and knowingly at the time of subscribing to the oath or affirmation, or at any time thereafter during the officer's or employee's term of office or employment, does commit or aid in the commission of any act to overthrow by force, violence or terrorism defined in section 13-2301 the government of this state or any of its political subdivisions, or advocates the overthrow by force, violence or terrorism as defined in section 13-2301 of the government of this state or of any of its political subdivisions, is guilty of a class 4 felony and, on conviction under this section, the officer or employee is deemed discharged from the office or employment and is not entitled to any additional compensation or any other emoluments or benefits which may have been incident or appurtenant to the office or employment.
- D. Any of the persons referred to in article XVIII, section 10, Constitution of Arizona, as amended, relating to the employment of aliens, are exempted from any compliance with this section.
- E. In addition to any other form of oath or affirmation specifically provided by law for an officer or employee, before any officer or employee enters upon the duties of the office or employment, the officer or employee shall take and subscribe the following oath or affirmation: (Below)
- F. For the purposes of this section, "officer or employee" means any person elected, appointed or employed, either on a part-time or full time basis, by this state or any of its political subdivisions or any county, city, town, municipal corporation, school district or public educational institution or any board, commission or agency of any county, city, town, municipal corporation, school district or public educational institution.

A.R.S. § 38-231 (E) Oath:

State of Arizona, County of Gila

I, Adam Shepherd do solemnly swear (or affirm) that I will support the Constitution of the United States and the Constitution and laws of the State of Arizona; that I will bear true faith and allegiance to the same, and defend them against all enemies, foreign and domestic, and that I will faithfully and impartially discharge the duties of office of Gila County Sheriff according to the best of my ability, so help me God (or so do I affirm).

Adam Shepherd
 Signature

Subscribed and sworn (or affirmed) to before me on this 19TH day of DECEMBER, 2013
 (SEAL)

Pam Fisher
 Notary Public

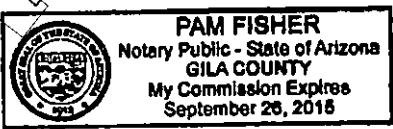

2022-011769 MISC Page: 2214 of 2782
 09/26/2022 03:35:37 PM Receipt #: 22-9381
 Rec Fee: \$30.00 Darrell James Hill
 Gila County, Az, Sadie Jo Bingham, Recorder

2013-000101 OATH Page: 2 of 2
 01/04/2013 10:51:26 AM Receipt #: 13-0081
 Rec Fee: \$0 Gila Co Bos
 Gila County, Az, Sadie Tomerlin Dalton, Recorder

[New Search](#)[Modify Search](#)[Printable Version](#)

You searched for: RecDateID >= Sat Feb 02 00:00:00 MST 1985 and <= Thu Jan 06 00:00:00 MST 2022 and exact search in GrantorID for Christensen steve

One item found.1

Description Summary

[Add All to My Images](#)

Rec Date: 01/13/2021 10:10:46 AM **LiberPage:**

Related:

[View Image](#)[Add to My Images](#)

Oath **Grantor:** CHRISTENSEN **Legal:**
2021-000513 STEVE

Grantee: CHRISTENSEN **Notes:** GILA COUNTY
STEVE SUPERVISOR DISTRICT 1

One item found.1

[New Search](#)[Modify Search](#)[Printable Version](#)

Unofficial Copy

2107

2022-011769 MISC Page: 2215 of 2782
 09/26/2022 03:35:37 PM Receipt #: 22-9381
 Rec Fee: \$30.00 Darrell James Hill
 Gila County, Az, Sadie Jo Bingham, Recorder



[New Search](#)[Modify Search](#)[Printable Version](#)

You searched for: RecDateID >= Sat Feb 02 00:00:00 MST 1985 and <= Thu Jan 06 00:00:00 MST 2022 and exact search in GrantorID for Christensen steve

One item found.1

Description	Summary	Add All to My Images
--------------------	----------------	--------------------------------------

Rec Date: 01/13/2021 10:10:46 AM **LiberPage:** Related:

Oath **Grantor:** CHRISTENSEN **Legal:**
2021-000513 STEVE

Grantee: CHRISTENSEN **Notes:** GILA COUNTY
STEVE SUPERVISOR DISTRICT 1

[View Image](#)[Add to My Images](#)

One item found.1

[New Search](#)[Modify Search](#)[Printable Version](#)

Unofficial

2022-011769 MISC Page: 2216 of 2782
09/26/2022 03:35:37 PM Receipt #: 22-9381
Rec Fee: \$30.00 Darrell James Hill
Gila County, Az, Sadie Jo Bingham, Recorder





When recorded, Return to

Attention: Eric Mariscal
Gila County Division of Elections

COPIES

Loyalty of Oath of Office

Do Not remove this sheet, it is part of the Recorded Document

2022-011769 MISC Page: 2217 of 2782
09/26/2022 03:35:37 PM Receipt #: 22-9381
Rec Fee: \$30.00 Darrell James Hill
Gila County, Az, Sadie Jo Bingham, Recorder



2021-000513 OATH Page: 1 of 2
01/13/2021 10:10:46 AM Receipt #: 21-0434
Rec Fee: \$0 Gila County Division Of Elections
Gila County, Az, Sadie Jo Bingham, Recorder



OATH OF OFFICE

I, the undersigned, hereby execute this document in compliance with A.R.S. § 38-231:

OFFICERS AND EMPLOYEES REQUIRED TO TAKE LOYALTY OATH: CLASSIFICATION: DEFINITION

- A. In order to ensure the statewide application of this section on a uniform basis, each board, commission, agency and independent office of this state, and of any of its political subdivisions, and of any county, city, town, municipal corporation, school district and public educational institution, shall completely reproduce this section so that the form of written oath or affirmation required in this section contains all of the provisions of this section for use by all officers and employees of all boards, commissions, agencies and independent offices.
- B. Any officer or employee who fails to take and subscribe to the oath or affirmation provided by this section within the time limits prescribed by this section is not entitled to any compensation until the officer or employee does so take and subscribe to the form of oath or affirmation prescribed by this section.
- C. Any officer or employee having taken the form of an oath or affirmation prescribed by this section and knowingly at the time of subscribing to the oath or affirmation, or at any time thereafter during the officer's or employee's term of office or employment, does commit or aid in the commission of any act to overthrow by force, violence or terrorism defined in section 13-2301 the government of this state or any of its political subdivisions, or advocates the overthrow by force, violence or terrorism as defined in section 13-2301 of the government of this state or of any of its political subdivisions, is guilty of a class 4 felony and, on conviction under this section, the officer or employee is deemed discharged from the office or employment and is not entitled to any additional compensation or any other emoluments or benefits which may have been incident or appurtenant to the office or employment.
- D. Any of the persons referred to in article XVIII, section 10, Constitution of Arizona, as amended, relating to the employment of aliens, are exempted from any compliance with this section.
- E. In addition to any other form of oath or affirmation specifically provided by law for an officer or employee, before any officer or employee enters upon the duties of the office or employment, the officer or employee shall take and subscribe the following oath or affirmation: (Below)
- F. For the purposes of this section, "officer or employee" means any person elected, appointed or employed, either on a part-time or full time basis, by this state or any of its political subdivisions or any county, city, town, municipal corporation, school district or public educational institution or any board, commission or agency of any county, city, town, municipal corporation, school district or public educational institution.

R.S. § 38-231 (E) Oath:

State of Arizona, County of Gila

I, STEVE CHRISTENSEN, (do solemnly swear (or affirm) that I will support the Constitution of the United States and the Constitution and laws of the State of Arizona; that I will bear true faith and allegiance to the same, and defend them against all enemies, foreign and domestic, and that I will faithfully and impartially discharge the duties of Gila County Supervisor District 1 according to the best of my ability, so help me God (or so do I affirm).

Signature

Subscribed and sworn (or affirmed) to before me on this 12th day of January, 2021

(SEAL)

Notary Public

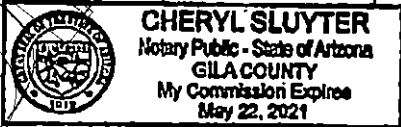

2022-011769 MISC Page: 2218 of 2782
09/26/2022 03:35:37 PM Receipt #: 22-9381
Rec Fee: \$30.00 Darrell James Hill
Gila County, Az, Sadie Jo Bingham, Recorder

2110

[New Search](#)[Modify Search](#)[Printable Version](#)

You searched for: RecDateID >= Sat Feb 02 00:00:00 MST 1985 and <= Thu Jan 06 00:00:00 MST 2022 and exact search in GrantorID for Humphrey and docsearchPOST.DocTypeSearchOver=Oath

2 items found, displaying all items.1

Description Summary

[Add All to My Images](#)

Rec Date: 12/15/2016 12:16:15 PM **LiberPage:** Related:

Oath **Grantor:** HUMPHREY TIM **Legal:**
2016-011648 **Grantee:** HUMPHREY TIM **Notes:** GILA COUNTY SUPERVISOR DISTRICT II, LOYALTY OATH

[View Image](#)[Add to My Images](#)

Rec Date: 12/23/2020 12:30:13 PM **LiberPage:** Related:

Oath **Grantor:** HUMPHREY TIM **Legal:**
2020-015881 **Grantee:** HUMPHREY TIM **Notes:**

[View Image](#)[Add to My Images](#)

2 items found, displaying all items.1

[New Search](#)[Modify Search](#)[Printable Version](#)

Unofficial
2411

2022-011769 MISC Page: 2219 of 2782
09/26/2022 03:35:37 PM Receipt #: 22-9381
Rec Fee: \$30.00 Darrell James Hill
Gila County, Az, Sadie Jo Bingham, Recorder





When recorded, Return to
Attention: Eric Mariscal
Gila County Division of Elections



Copy

Loyalty of Oath of Office

Do Not remove this sheet, it is part of the Recorded Document

2022-011769 MISC Page: 2220 of 2782
09/26/2022 03:35:37 PM Receipt #: 22-9381
Rec Fee: \$90.00 Darrell James Hill
Gila County, Az, Sadie Jo Bingham, Recorder



2020-015881 OATH Page: 1 of 2
12/23/2020 12:30:13 PM Receipt #: 20-12958
Rec Fee: \$0 Gila County Elections Dept
Gila County, Az, Sadie Jo Bingham, Recorder



OATH OF OFFICE

I, the undersigned, hereby execute this document in compliance with A.R.S. § 38-231:

OFFICERS AND EMPLOYEES REQUIRED TO TAKE LOYALTY OATH: CLASSIFICATION: DEFINITION

- A. In order to ensure the statewide application of this section on a uniform basis, each board, commission, agency and independent office of this state, and of any of its political subdivisions, and of any county, city, town, municipal corporation, school district and public educational institution, shall completely reproduce this section so that the form of written oath or affirmation required in this section contains all of the provisions of this section for use by all officers and employees of all boards, commissions, agencies and independent offices.
- B. Any officer or employee who fails to take and subscribe to the oath or affirmation provided by this section within the time limits prescribed by this section is not entitled to any compensation until the officer or employee does so take and subscribe to the form of oath or affirmation prescribed by this section.
- C. Any officer or employee having taken the form of an oath or affirmation prescribed by this section and knowingly at the time of subscribing to the oath or affirmation, or at any time thereafter during the officer's or employee's term of office or employment, does commit or aid in the commission of any act to overthrow by force, violence or terrorism defined in section 13-2301 the government of this state or any of its political subdivisions, or advocates the overthrow by force, violence or terrorism as defined in section 13-2301 of the government of this state or of any of its political subdivisions, is guilty of a class 4 felony and, on conviction under this section, the officer or employee is deemed discharged from the office or employment and is not entitled to any additional compensation or any other emoluments or benefits which may have been incident or appurtenant to the office or employment.
- D. Any of the persons referred to in article XVIII, section 10, Constitution of Arizona, as amended, relating to the employment of aliens, are exempted from any compliance with this section.
- E. In addition to any other form of oath or affirmation specifically provided by law for an officer or employee, before any officer or employee enters upon the duties of the office or employment, the officer or employee shall take and subscribe the following oath or affirmation: (Below)
- F. For the purposes of this section, "officer or employee" means any person elected, appointed or employed, either on a part-time or full time basis, by this state or any of its political subdivisions or any county, city, town, municipal corporation, school district or public educational institution or any board, commission or agency of any county, city, town, municipal corporation, school district or public educational institution.

A.R.S. § 38-231 (E) Oath:

State of Arizona, County of Gila

I, Tim Humphrey do solemnly swear (or affirm) that I will support the Constitution of the United States and the Constitution and laws of the State of Arizona; that I will bear true faith and allegiance to the same, and defend them against all enemies, foreign and domestic, and that I will faithfully and impartially discharge the duties of Gila County Board of Supervisors District 2 according to the best of my ability, so help me God (or so do I affirm).

[Handwritten Signature]

Signature

Subscribed and sworn (or affirmed) to before me on this 22nd day of December, 2020.
(SEAL)

[Handwritten Signature]

Notary Public

ERICA MARISCAL
Notary Public - State of Arizona
GILA COUNTY
My Commission Expires
August 11, 2021

2022-011769 MISC Page: 2221 of 2782
09/26/2022 03:35:37 PM Receipt #: 22-9381
Rec Fee: \$30.00 Darrell James Hill
Gila County, Az, Sadie Jo Bingham, Recorder

2020-015881 OATH Page: 2 of 2
12/23/2020 12:30:13 PM Receipt #: 20-12958
Rec Fee: \$0 Gila County Elections Dept
Gila County, Az, Sadie Jo Bingham, Recorder



When recorded, Mail to

Attention: Eric Mariscal
Gila County Division of Elections



Loyalty of Oath of Office

Do Not remove this sheet, it is part of the Recorded Document

2022-011769 MISC Page: 2222 of 2782
09/26/2022 03:35:37 PM Receipt #: 22-9381
Rec Fee: \$30.00 Darrell James Hill
Gila County, Az, Sadie Jo Bingham, Recorder

2016-011648 ORTH Page: 1 of 2
12/15/2018 12:16:15 PM Receipt #: 16-9016
Rec Fee: \$0 Gila County Division of Elections
Gila County, Az, Sadie Jo Bingham, Recorder

2114

OATH OF OFFICE

Gila County Supervisor District II

I, the undersigned, hereby execute this document in compliance with A.R.S. § 38-231 and § 11-542:

OFFICERS AND EMPLOYEES REQUIRED TO TAKE LOYALTY OATH: CLASSIFICATION: DEFINITION

- A. In order to ensure the statewide application of this section on a uniform basis, each board, commission, agency and independent office of this state, and of any of its political subdivisions, and of any county, city, town, municipal corporation, school district and public educational institution, shall completely reproduce this section so that the form of written oath or affirmation required in this section contains all of the provisions of this section for use by all officers and employees of all boards, commissions, agencies and independent offices.
B. Any officer or employee who fails to take and subscribe to the oath or affirmation provided by this section within the time limits prescribed by this section is not entitled to any compensation until the officer or employee does so take and subscribe to the form of oath or affirmation prescribed by this section.
C. Any officer or employee having taken the form of an oath or affirmation prescribed by this section and knowingly at the time of subscribing to the oath or affirmation, or at any time thereafter during the officer's or employee's term of office or employment, does commit or aid in the commission of any act to overthrow by force, violence or terrorism defined in section 13-2301 the government of this state or any of its political subdivisions, or advocates the overthrow by force, violence or terrorism as defined in section 13-2301 of the government of this state or of any of its political subdivisions, is guilty of a class 4 felony and, on conviction under this section, the officer or employee is deemed discharged from the office or employment and is not entitled to any additional compensation or any other emoluments or benefits which may have been incident or appurtenant to the office or employment.
D. Any of the persons referred to in article XVIII, section 10, Constitution of Arizona, as amended, relating to the employment of aliens, are exempted from any compliance with this section.
E. In addition to any other form of oath or affirmation specifically provided by law for an officer or employee, before any officer or employee enters upon the duties of the office or employment, the officer or employee shall take and subscribe the following oath or affirmations: (Below)
F. For the purposes of this section, "officer or employee" means any person elected, appointed or employed, either on a part-time or full time basis, by this state or any of its political subdivisions or any county, city, town, municipal corporation, school district or public educational institution or any board, commission or agency of any county, city, town, municipal corporation, school district or public educational institution.

A.R.S. § 38-231 (E) Oath:

of Arizona, County of Gila

I, Humphrey do solemnly swear (or affirm) that I will support the Constitution of the United States and the Constitution and laws of the State of Arizona; that I will bear true faith and allegiance to the same, and defend them against all enemies, foreign and domestic, and that I will faithfully and impartially discharge the duties of my office of Gila County Supervisor District II according to the best of my ability, so help me God (or so do I).

[Signature]
Signature

scribed and sworn (or affirmed) to before me on this 12th day of Dec. 2016

WENDY K. HUNSAKER
Notary Public - Arizona
Gila County
My Commission Expires
May 17, 2018

[Signature]
Notary Public

2022-011769 MISC Page: 2223 of 2782
09/26/2022 03:35:37 PM Receipt #: 22-9381
Reg Fee: \$30.00 Darrell James Hill
Gila County, Az, Sadie Jo Bingham, Recorder

2115

2016-011648 OATH Page: 2 of 2
12/15/2016 12:16:15 PM Receipt #: 16-9016
Reg Fee: \$0 Gila County Division of Elections
Gila County, Az, Sadie Jo Bingham, Recorder

[New Search](#)[Modify Search](#)[Printable Version](#)

You searched for: RecDateID >= Sat Feb 02 00:00:00 MST 1985 and <= Thu Jan 06 00:00:00 MST 2022 and exact search in GrantorID for Cline woody and docsearchPOST.DocTypeSearchOver=Oath --

2 items found, displaying all items.1

Description	Summary	Add All to My Images
Oath 2016-011650	<p>Rec Date: 12/15/2016 12:16:15 PM LiberPage: Related:</p> <p>Grantor: CLINE WOODY Grantee: CLINE WOODY</p>	<p>View ImageAdd to My Images</p>
Oath 2020-015885	<p>Rec Date: 12/23/2020 12:30:13 PM LiberPage: Related:</p> <p>Grantor: CLINE WOODY Grantee: CLINE WOODY</p>	<p>View ImageAdd to My Images</p>

2 items found, displaying all items.1

[New Search](#)[Modify Search](#)[Printable Version](#)

Unofficial

2022-011769 MISC Page: 2224 of 2782
 09/26/2022 03:35:37 PM Receipt #: 22-9381
 Rec Fee: \$30.00 Darrell James Hill
 Gila County, Az, Sadie Jo Bingham, Recorder





When recorded, Return to

Attention: Eric Mariscal
Gila County Division of Elections

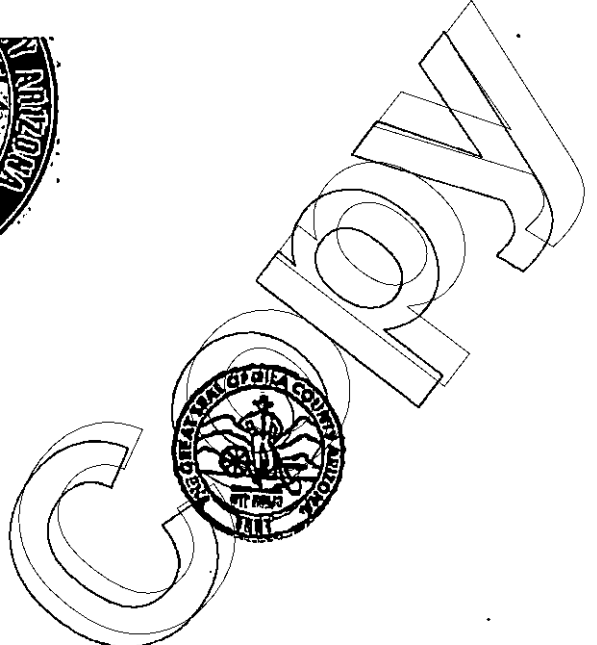

Loyalty of Oath of Office

Do Not remove this sheet, it is part of the Recorded Document

UNOFFICIAL COPY
2117



OATH OF OFFICE

2020 DEC 17 PM 3:07

I, the undersigned, hereby execute this document in compliance with A.R.S. § 38-231:

OFFICERS AND EMPLOYERS REQUIRED TO TAKE LOYALTY OATH: CLASSIFICATION: DEFINITION

- A. In order to ensure the statewide application of this section on a uniform basis, each board, commission, agency and independent office of this state, and of any of its political subdivisions, and of any county, city, town, municipal corporation, school district and public educational institution, shall completely reproduce this section so that the form of written oath or affirmation required in this section contains all of the provisions of this section for use by all officers and employees of all boards, commissions, agencies and independent offices.
- B. Any officer or employee who fails to take and subscribe to the oath or affirmation provided by this section within the time limits prescribed by this section is not entitled to any compensation until the officer or employee does so take and subscribe to the form of oath or affirmation prescribed by this section.
- C. Any officer or employee having taken the form of an oath or affirmation prescribed by this section and knowingly at the time of subscribing to the oath or affirmation, or at any time thereafter during the officer's or employee's term of office or employment, does commit or aid in the commission of any act to overthrow by force, violence or terrorism defined in section 13-2301 the government of this state or any of its political subdivisions, or advocates the overthrow by force, violence or terrorism as defined in section 13-2301 of the government of this state or of any of its political subdivisions, is guilty of a class 4 felony and, on conviction under this section, the officer or employee is deemed discharged from the office or employment and is not entitled to any additional compensation or any other emoluments or benefits which may have been incident or appurtenant to the office or employment.
- D. Any of the persons referred to in article XVIII, section 10, Constitution of Arizona, as amended, relating to the employment of aliens, are exempted from any compliance with this section.
- E. In addition to any other form of oath or affirmation specifically provided by law for an officer or employee, before any officer or employee enters upon the duties of the office or employment, the officer or employee shall take and subscribe the following oath or affirmation: (Below)
- F. For the purposes of this section, "officer or employee" means any person elected, appointed or employed, either on a part-time or full time basis, by this state or any of its political subdivisions or any county, city, town, municipal corporation, school district or public educational institution or any board, commission or agency of any county, city, town, municipal corporation, school district or public educational institution.

R.S. § 38-231 (E) Oath:

State of Arizona, County of Gila

I, Woody Cline do solemnly swear (or affirm) that I will support the Constitution of the United States and the Constitution and laws of the State of Arizona; that I will bear true faith and allegiance to the same, and defend them against all enemies, foreign and domestic, and that I will faithfully and impartially discharge the duties of Gila County Board of Supervisors District 3 according to the best of my ability, so help me God (or so do I affirm).

Woody Cline
Signature

Subscribed and sworn (or affirmed) to before me on this 16th day of December, 2020
(SEAL)

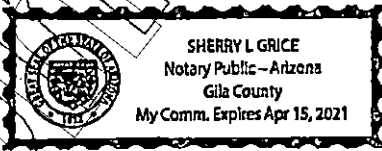

Sherry L. Grice
Notary Public

2118

2022-011769 MISC Page: 2226 of 2782
09/26/2022 03:35:37 PM Receipt #: 22-9381
Rec Fee: \$30.00 Darrell James Hill
Gila County, Az, Sadie Jo Bingham, Recorder

2020-015885 OATH Page: 2 of 2
12/23/2020 12:30:13 PM Receipt #: 20-12958
Rec Fee: \$0 Gila County Elections Dept
Gila County, Az, Sadie Jo Bingham, Recorder



When recorded, Mail to

Attention: Eric Mariscal
Gila County Division of Elections

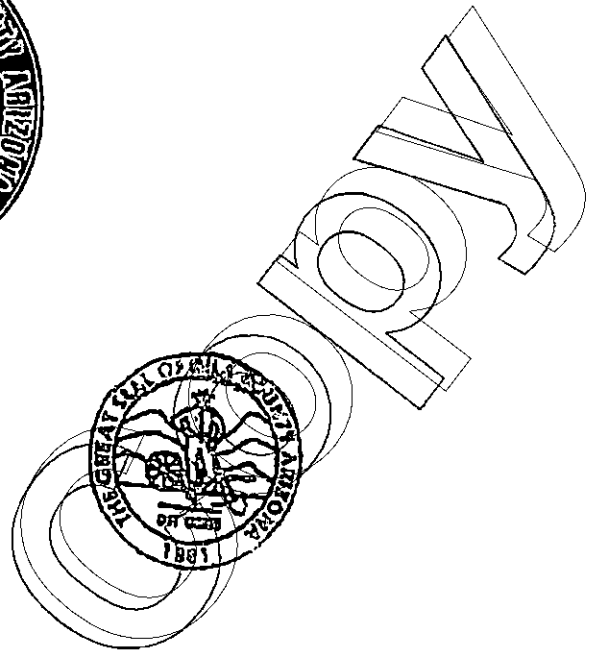

Loyalty of Oath of Office

Do Not remove this sheet, it is part of the Recorded Document

2022-011769 MISC Page: 2227 of 2782
09/26/2022 03:35:37 PM Receipt #: 22-9381
Rec Fee: \$30.00 Darrell James Hill
Gila County, Az, Sadie Jo Bingham, Recorder



2016-011650 OATH Page: 1 of 2
12/15/2016 12:16:15 PM Receipt #: 16-9016
Rec Fee: \$0 Gila County Division Of Elections
Gila County, Az, Sadie Jo Bingham, Recorder

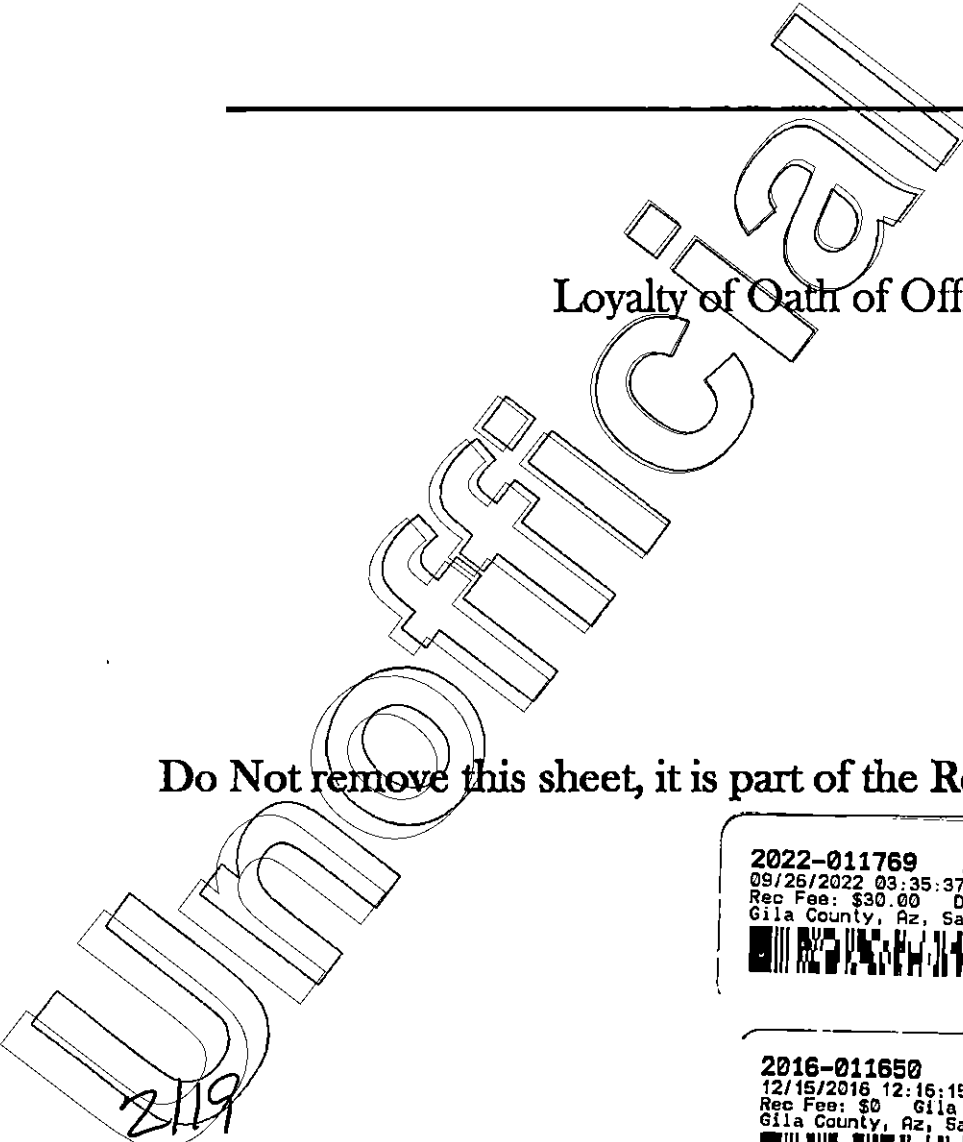

2/19

OATH OF OFFICE

Gila County Supervisor District III

I, the undersigned, hereby execute this document in compliance with A.R.S. § 38-231 and § 11-542: OFFICERS AND EMPLOYEES REQUIRED TO TAKE LOYALTY OATH; CLASSIFICATION; DEFINITION

- A. In order to ensure the statewide application of this section on a uniform basis, each board, commission, agency and independent office of this state, and of any of its political subdivisions, and of any county, city, town, municipal corporation, school district and public educational institution, shall completely reproduce this section so that the form of written oath or affirmation required in this section contains all of the provisions of this section for use by all officers and employees of all boards, commissions, agencies and independent offices.
B. Any officer or employee who fails to take and subscribe to the oath or affirmation provided by this section within the time limits prescribed by this section is not entitled to any compensation until the officer or employee does so take and subscribe to the form of oath or affirmation prescribed by this section.
C. Any officer or employee having taken the form of an oath or affirmation prescribed by this section and knowingly at the time of subscribing to the oath or affirmation, or at any time thereafter during the officer's or employee's term of office or employment, does commit or aid in the commission of any act to overthrow by force, violence or terrorism defined in section 13-2301 the government of this state or any of its political subdivisions, or advocates the overthrow by force, violence or terrorism as defined in section 13-2301 of the government of this state or of any of its political subdivisions, is guilty of a class 4 felony and, on conviction under this section, the officer or employee is deemed discharged from the office or employment and is not entitled to any additional compensation or any other emoluments or benefits which may have been incident or appurtenant to the office or employment.
D. Any of the persons referred to in article XVIII, section 10, Constitution of Arizona, as amended, relating to the employment of aliens, are exempted from any compliance with this section.
E. In addition to any other form of oath or affirmation specifically provided by law for an officer or employee, before any officer or employee enters upon the duties of the office or employment, the officer or employee shall take and subscribe the following oath or affirmation: (Below)
F. For the purposes of this section, "officer or employee" means any person elected, appointed or employed, either on a part-time or full time basis, by this state or any of its political subdivisions or any county, city, town, municipal corporation, school district or public educational institution or any board, commission or agency of any county, city, town, municipal corporation, school district or public educational institution.

R.S. § 38-231 (E) Oath:

State of Arizona, County of Gila

Woody Cline do solemnly swear (or affirm) that I will support the Constitution of the United States and the Constitution and laws of the State of Arizona; that I will bear true faith and allegiance to the same, and defend them against all enemies, foreign and domestic, and that I will faithfully and impartially discharge the duties of office of Gila County Supervisor District III according to the best of my ability, so help me God (or so do I affirm).

Woody Cline Signature

Subscribed and sworn (or affirmed) to before me on this 8th day of December, 2016

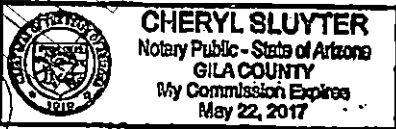

Cheryl Sluyter Notary Public

2022-011769 MISC Page: 2228 of 2782 09/26/2022 09:35:37 PM Receipt #: 22-9381 Rec Fee: \$30.00 Darrell James Hill Gila County, Az, Sadie Jo Bingham, Recorder

2120

Gila County, AZ
Linda Haught Ortega, Recorder
05/05/2005
02:51PM
Doc Code: OATH

Doc Id: 2005-007467
Receipt #: 33494
Rec Fee: 0.00

When Recorded, Mail to:

GILA CO PERSONNEL



2005-007467
Page: 1 of 2
05/05/2005 02:51P
0.00

Gila County Personnel
1400 E. Ash Street
Globe, Arizona 85501

Gila County, AZ

OATH



GILA COUNTY LOYALTY OATH

Caption Heading/Title:

Do Not Remove This Sheet, It Is Part Of The Recorded Document

UNOFFICIAL

2022-011769 MISC Page: 2229 of 2782
09/26/2022 03:35:37 PM Receipt #: 22-9381
Rec Fee: \$30.00 Darrell James Hill
Gila County, Az, Sadie Jo Bingham, Recorder



BOARD OF SUPERVISORS
Gila County, Arizona
Office of Personnel Director

LOYALTY OATH

I, the undersigned, hereby execute this document in compliance with Chapter 108 (House Bill 115) Laws 1961, First Regular Session, Sec. 38-231, Arizona Revised Statutes:

OFFICERS AND EMPLOYEES REQUIRED TO TAKE LOYALTY OATH; FORM; CLASSIFICATION; DEFINITION

A. In order to ensure the statewide application of this section on a uniform basis, each board, commission, agency and independent office of this state, and of any of its political subdivisions, and of any county, city, town, municipal corporation, school district, and public educational institution, shall completely reproduce this section so that the form of the written oath or affirmation required in this section contains all of the provisions of this section for use by all officers and employees of all boards, commissions, agencies and independent offices.

B. Any officer or employee who fails to take and subscribe to the oath or affirmation provided by this section within the time limits prescribed by this section is not entitled to any compensation until the officer or employee does so take and subscribe to the form of oath or affirmation prescribed by this section.

C. Any officer or employee having taken the form of oath or affirmation prescribed in this section, and knowingly at the time of subscribing to the oath or affirmation, or at any time thereafter during the officer's or employee's term of office or employment, does commit or aid in the commission of any act to overthrow by force, violence or terrorism as defined in section 13-2301 the government of this state or of any of its political subdivisions, or advocates the overthrow by force, violence or terrorism as defined in section 13-2301 of the government of this state or of any of its political subdivisions, is guilty of a class 4 felony and, on conviction under this section, the officer or employee is deemed discharged from the office or employment and is not entitled to any additional compensation or any other emoluments or benefits which may have been incident or appurtenant to the office or employment.

D. Any of the persons referred to in article XVIII, section 16, Constitution of Arizona, as amended, relating to the employment of aliens, are exempted from any compliance with this section.

E. In addition to any other form of oath or affirmation specifically provided by law for an officer or employee, before any officer or employee enters upon the duties of the office or employment, the officer or employee shall take and subscribe the following oath or affirmation:

STATE OF ARIZONA)
) ss.
COUNTY OF GILA)

I, Marian Sheppard do solemnly swear (or affirm) that I will support the Constitution of the United States and (type or print name)
Constitution and laws of the State of Arizona, that I will bear true faith and allegiance to the same and defend them
at all enemies, foreign and domestic, and that I will faithfully and impartially discharge the duties of the office of an
employee of the Gila County Board of Supervisors according to the best of my ability, so help me God (or so I do affirm).
(name of office)

Marian Sheppard
(Signature of officer or employee)

SCRIBED AND SWORN to before me this 5th day of May, 2005.

Stacy C. Edwards
Notary Public in and for the County of Gila
State of Arizona

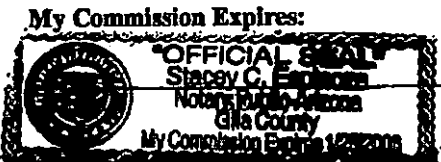

For the purposes of this section, "officer or employee" means any person, whether on a part-time or full-time basis, by this state or any of its political subdivisions or any county, city, town, municipal corporation, school district, public educational institution or any board, commission or agency of any county, city, town, municipal corporation, school district or public educational institution.



2005-007467
Page: 2 of 2
05/05/2005 02:51P
0.00

Gila County, AZ

OATH

2022-011769 MISC
Page: 2230 of 2782
09/26/2022 09:35:37 PM
Receipt #: 22-9981
James Hill
Rec Fee: \$30.00
Barrell
Gila County, Az, Sadie Jo Bingham, Recorder

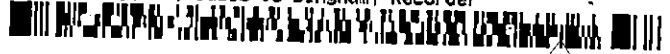

When Recorded, Mail to:

Gila County Human Resources
1400 E. Ash Street
Globe, Arizona 85501



Caption Heading / Title: Gila County Loyalty Oath

Do Not Remove This Sheet, It Is Part Of The Recorded Document

UNOFFICIAL COPY
2023



BOARD OF SUPERVISORS
Gila County, Arizona
Office of Human Resources Director

LOYALTY OATH

I, the undersigned, hereby execute this document in compliance with Chapter 108 (House Bill 115) Laws 1961, First Regular Session, Sec. 38-231, Arizona Revised Statutes:

OFFICERS AND EMPLOYEES REQUIRED TO TAKE LOYALTY OATH; FROM; PENALTY

A. In order to ensure the state wide application of this section on a uniform basis, each board, commission, agency and independent office of the state, any of its political subdivisions, and of any county, city, town, municipal corporation, school district, and public educational institution, shall immediately upon the effective date of this act completely reproduce section 39-231 as set forth herein, to the end that the form of written oath or affirmation required herein shall contain all of the provisions of said section for use by all officers and employees of all boards, commissions, agencies and independent offices.

B. For the purpose of this section, the term officer or employee means any person elected, appointed or employed either on a part-time basis, by the state, or any of its political subdivisions or any county, city, town, municipal corporation, school district, public educational institution, or any board, commission or agency of any of the foregoing.

C. Any officer or employee elected, appointed, or employed prior to the effective date of this act shall not later than ninety days after the effective date of this act take and subscribe the form of oath or affirmation set forth in this section.

D. Any officer or employee within the meaning of this section who fails to take and subscribe the oath or affirmation provided by this section within the time limits prescribed by this section shall not be entitled to any compensation unless and until such officer or employee does so take and subscribe to the form of oath or affirmation set forth in this section.

E. Any of the persons referred to in Article XVIII, Section 10 of the Arizona Constitution as amended, related to the employment of aliens, shall be exempted from any compliance with the provisions of this section.

F. In addition to any other form of oath or affirmation specifically provided by law for an officer or employee before any officer or employee enters upon the duties of his office or employment, he shall take and subscribe the following oath or affirmation:

STATE OF ARIZONA)

COUNTY OF GILA)

I, Taylor Holland do solemnly swear (or affirm) that I will support the United States and the Constitution and laws of the State of Arizona; that I will bear true faith and allegiance to the same, and defend them against all enemies, foreign and domestic; and that I will faithfully and impartially discharge the duties of the office of an employee of the Gila County Courthouse according to the best of my ability, so help me God (or so I do affirm).

Taylor Holland
(Signature of officer or employee)

SUBSCRIBED AND SWORN to before me this 22nd day of December, 2021.

Christina Castaneda
Notary Public in and for the County of Gila
State of Arizona

My Commission Expires:
12-31-2022

2021-017314 OATH Page: 2 of 2
12/30/2021 10:44:53 AM Receipt #: 21-14411
Rec Fee: \$0 Gila County Human Resources
Gila County, Az, Sadie Jo Bingham, Recorder

2022-011769 MISC Page: 2232 of 2782
09/26/2022 03:35:37 PM Receipt #: 22-9381
Rec Fee: \$30.00 Darrell James Hill
Gila County, Az, Sadie Jo Bingham, Recorder

2024

**See: Proof-of-Claims: C:
Darrell-James and Beverly-Jean: Bills-of-Particulars:
December-30-2021-A.D.- 10:35 A.M. – January-11-2022-A.D.-
5:00 P.M., -:Now -DUE-paid-now; appended: 4 pages.**

:notice: Default with Option to Cure: RE

2022-011769 MISC Page: 2233 of 2782
09/26/2022 03:35:37 PM Receipt #: 22-9381
Rec Fee: \$30.00 Darrell James Hill
Gila County, Az, Sadie Jo Bingham, Recorder



09/26/2022 03:35:37 PM Receipt #: 22-9381
Rec Fee: \$30.00 Darrell James Hill
Gila County, Az, Sadie Jo Bingham, Recorder



:Beverly-Jean: Romero- Hill, -:New- Mexican,
-:beneficiary, -:Executor: PE-2016-A.D.¹
USPO- General-Delivery-Mail
Mayer, Arizona [86333]

Sadie-Jo: Bingham, -:Trustee, USPO RMN RE 322 390 836 US
-:Arizona-State-Gila-County-Recorder-Officer
1400 East Ash, Globe, Arizona [85501]

Bill of Particulars: RE322398358US

12/30/21 – 10:30 A.M.	Deprivation- RE322398358US	Hours:	Amount due now	Amount-paid-todate	:Amount-now due-paid-now
to:	penalty-by the				
01/11/22 – 17:00 pm	covenant-agreement				
	(a)	(b)	(a x b)		
	One thousand one hundred fifty --1,150--	Hours			
	0.9999- oz. Ag - U.S.-coin in specie per hour				
	1	295 (294.5 ²)	339250	0	339,250 - one ounce: 0.9999 Ag :U.S.- coin - in -specie
:Totals		295	339250	0	339,250 - one ounce: 0.9999 Ag :U.S.- coin - in -specie

Pay amount demanded-due now.

i- man affirm the above is true and correct to the best of my ability, and will state same in the open court.

Without prejudice

January 11, 2022

Beverly Jean Romero Hill, New Mexican, Executor
:Beverly-Jean: Romero- Hill, -:New-Mexican-
beneficiary, -:Executor

1 :Beverly-Jean: Romero- Hill, -:New-Mexican-beneficiary, -:Executor -:PE-2016-A.D. means: See: historical-documents: Superior constructive Notice and Demand: Permanent Non-Commerical Presumption, and: Constructive Notice : 'BEVERLY JEAN ROMERO- HILL' of 'Beverly-Jean; of the family Romero- Hill', authorized Representative. -:Gila-county-Arizona-Doc.#: 2017-002378: pp. 1-4, 26-44, 93-95.
294.5 means: See: Hours Calculation by: <http://www.calculator.net/hours-calculator.html>

2022



:Darrell-James: Hill, -:Ohioan,
 -:beneficiary,-:Executor: PE-2016-A.D.¹,
 USPO- General-Delivery-Mail
 Mayer, Arizona [86333]

Sadie-Jo: Bingham, -:Trustee, USPO RMN RE 322 390 836 US
 -:Arizona-State-Gila-County-Recorder-Officer
 1400 East Ash, Globe, Arizona [85501]

Bill of Particulars: RE322398358US

12/30/21 – 10:30 A.M. to: 01/11/22 – 17:00 pm	Deprivation- RE322398358US penalty-by the covenant-agreement	Hours:	Amount due now	Amount-paid-todate	:Amount-now due- paid- now
	(a)	(b)	(a x b)		
	One thousand one hundred fifty ~1,150~ 0.9999- oz. Ag - U.S.-coin in specie per hour	Hours			
1		295 (294.5 ²)	339250	0	339,250 - one ounce: 0.9999 Ag :U.S.- coin -in -specie
:Totals		295	339250	0	339,250 - one ounce: 0.9999 Ag :U.S.- coin -in -specie

Pay amount demanded-due now.

:i- man affirm the above is true and correct to the best of my ability and will state same in the open court.

Without prejudice,

January 11, 2022

Darrell James Hill, Ohioan, -:Executor
 :Darrell-James: Hill, -:Ohioan -beneficiary; -:Executor

1 :Darrell-James: Hill, -:Ohioan-beneficiary, -:Executor means: See: historical-documents: Superior constructive Notice and Demand: Permanent Non-Commerical Presumption, and: Constructive Notice : 'DARRELL JAMES HILL' of 'Darrell-James: of the family Hill', authorized Representative. -:Gila-county-Arizona-Doc.#: 2017-002378: pp. 1-24, 93-95.

2 294.5 means: See: Hours Calculation by: <http://www.calculator.net/hours-calculator.html>

2022

FINANCIAL

FITNESS & HEALTH

MATH

home / other / hours calculator

Hours Calculator

Use the calculators below to find the number of hours and minutes between two times card, please use the Time Card Calculator.

Start Time:	<input type="text" value="8:30"/>	<input type="text" value="AM"/>	<input type="text" value="Now"/>
End Time:	<input type="text" value="5:30"/>	<input type="text" value="PM"/>	<input type="text" value="Now"/>
<input type="button" value="Calculate"/>		<input type="button" value="Clear"/>	

Hours Between Two Dates

Result

The time between Dec. 30, 2021, 10:30 AM and Jan. 11, 2022, 5:00 PM is:

12 days 6 hours 30 minutes

294 hours 30 minutes

294.5 hours

17,670 minutes

Start Time:	<input type="text" value="Dec"/>	<input type="text" value="30"/>	<input type="text" value="2021"/>	<input type="button" value="Calendar"/>
	<input type="text" value="10:30"/>	<input type="text" value="AM"/>	<input type="text" value="Now"/>	
End Time:	<input type="text" value="Jan"/>	<input type="text" value="11"/>	<input type="text" value="2022"/>	<input type="button" value="Calendar"/>
	<input type="text" value="5:00"/>	<input type="text" value="PM"/>	<input type="text" value="Now"/>	

2022-011769 MISC Page: 2236 of 2782
 09/26/2022 03:35:37 PM Receipt #: 22-9381
 Rec Fee: \$30.00 Darrell James Hill
 Gila County, Az, Sadie Jo Bingham, Recorder





APACHE JUNCTION
151 W SUPERSTITION BLVD
APACHE JUNCTION, AZ 85120-9998
(800)275-8777

01/13/2022 10:55 AM

Product	Qty	Unit Price	Price
---------	-----	------------	-------

First-Class Mail®	1		\$2.16
Large Envelope			

Globe, AZ 85501
Weight: 0 lb 5.90 oz
Estimated Delivery Date
Tue 01/18/2022

Registered Mail®			\$14.35
------------------	--	--	---------

Amount: \$21.00

Tracking #:

RE322390822US

Return Receipt			\$3.05
----------------	--	--	--------

Tracking #:

9590 9402 4718 8344 9801 61

Total			\$19.56
-------	--	--	---------

First-Class Mail®	1		\$2.16
Large Envelope			

Globe, AZ 85501
Weight: 0 lb 5.70 oz
Estimated Delivery Date
Tue 01/18/2022

Certified Mail®			\$3.75
-----------------	--	--	--------

Tracking #:

70091410000078685826

Return Receipt			\$3.05
----------------	--	--	--------

Tracking #:

9590 9402 5799 0034 8156 49

Total			\$8.96
-------	--	--	--------

Grand Total:			\$28.52
--------------	--	--	---------

Cash			\$50.00
------	--	--	---------

Change			-\$21.48
--------	--	--	----------

RE322390822US

Reg. Fee	\$2.16
----------	--------

Handling Charge	\$14.35
-----------------	---------

Postage	\$3.05
Restricted Delivery	\$0.00

Received by	\$0.00
-------------	--------

\$19.56

Customer Must Declare

Full Value \$21.00

Domestic Insurance to \$25,000 is included at no charge. The liability for loss or damage is limited to the actual cash value of the contents.

OFFICIAL USE

To Be Completed By Post Office	To Be Completed By Customer (Please Print) All Entries Must Be In Ballpoint or Typed
FROM	APACHE JUNCTION, AZ 85120 Darrell James Hill, Executor Barbara Jean Romero Hill, Executor USPO General Delivery Mail Mayer Arizona [86333]
TO	Adam Shepherd, Trustee Gila County Sheriff 1425 East South Street, PO Box 311 Globe, Arizona 85502

PS Form 3806, Receipt for Registered Mail Copy 1 - Customer
May 2007 (7530-02-000-9051) (See Information on Reverse)

**U.S. Postal Service™
CERTIFIED MAIL™ RECEIPT**

(Domestic Mail Only; No Insurance Coverage Provided)

For delivery information visit our website at www.usps.com

OFFICIAL USE

Postage	\$3.05
Certified Fee	\$0.00
Return Receipt Fee (Endorsement Required)	\$0.00
Restricted Delivery Fee (Endorsement Required)	\$0.00
Total Postage & Fees	\$8.96

0130
55

Postmark
Here

01/13/2022

Sent to	Marian Shepherd, Trustee, Gila
Street, Apt. No., or PO Box No.	1400 East Ash Street
City, State, ZIP+4	Globe, Arizona 85501

PS Form 3800, August 2006

See Reverse for Instructions

7009 1410 0000 7868 5826

Unofficial

2022-011769 MISC Page: 2237 of 2782

09/26/2022 03:35:37 PM Receipt #: 22-9381

Reg Fee: \$30.00 Darrell James Hill

Gila County, Az, Sadie Jo Bingham, Recorder



January 13, 2022, 10:07 pm
Arrived at USPS Facility
PHOENIX, AZ 85026

January 13, 2022, 4:27 pm
Departed Post Office
APACHE JUNCTION, AZ 85120

January 13, 2022, 10:50 am
USPS in possession of item
APACHE JUNCTION, AZ 85120

Product Information



See Less ^

Feedback

Can't find what you're looking for?

Go to our FAQs section to find answers to your tracking questions.

FAQs

2031

2022-011769 MISC Page: 2238 of 2782
09/26/2022 03:35:37 PM Receipt #: 22-9381
Rec Fee: \$30.00 Darrell James Hill
Gila County, Az, Sadie Jo Bingham, Recorder



[Track Another Package +](#)

Tracking Number: RE322390822US

[Remove X](#)

Your item was picked up at the post office at 9:24 am on January 20, 2022 in GLOBE, AZ 85501.

✓ Delivered, Individual Picked Up at Post Office

January 20, 2022 at 9:24 am
GLOBE, AZ 85501

[Get Updates ▾](#)

[Feedback](#)

[Text & Email Updates ▾](#)

[Tracking History ▾](#)

January 20, 2022, 9:24 am
Delivered, Individual Picked Up at Post Office
GLOBE, AZ 85501
Your item was picked up at the post office at 9:24 am on January 20, 2022 in GLOBE, AZ 85501.

January 14, 2022, 2:38 pm
Held at Post Office, At Customer Request
GLOBE, AZ 85501

January 13, 2022, 10:07 pm
Departed USPS Facility
PHOENIX, AZ 85026

2030

2022-011769 MISC Page: 2239 of 2782
09/26/2022 03:35:37 PM Receipt #: 22-9381
Rec Fee: \$30.00 Darrell James Hill
Gila County, Az, Sadie Jo Bingham, Recorder



USPS Tracking®

[FAQs >](#)

[Track Another Package +](#)

Tracking Number: 70091410000078685826

[Remove X](#)

Your item has been delivered to an agent for final delivery in GLOBE, AZ 85501 on January 18, 2022 at 8:40 am.

USPS Tracking Plus™ Available

Delivered to Agent for Final Delivery

January 18, 2022 at 8:40 am
GLOBE, AZ 85501

[Feedback](#)

[Get Updates](#)

Text & Email Updates

Tracking History

January 18, 2022, 8:40 am

Delivered to Agent for Final Delivery
GLOBE, AZ 85501

Your item has been delivered to an agent for final delivery in GLOBE, AZ 85501 on January 18, 2022 at 8:40 am.

January 15, 2022, 8:55 am

Delivery Attempted - No Access to Delivery Location
GLOBE, AZ 85501

January 15, 2022, 6:58 am

Out for Delivery

2022-011769 MISC Page: 2240 of 2782
09/26/2022 03:35:37 PM Receipt #: 22-9381
Rec Fee: \$30.00 Darrell James Hill
Gila County, Az, Sadie Jo Bingham, Recorder



2032
2032

GLOBE, AZ 85501

January 15, 2022, 6:47 am

Arrived at Post Office

GLOBE, AZ 85501

January 14, 2022, 4:18 pm

Departed USPS Regional Facility

PHOENIX AZ DISTRIBUTION CENTER ANNEX

January 14, 2022, 9:25 am

Arrived at USPS Regional Facility

PHOENIX AZ DISTRIBUTION CENTER ANNEX

January 13, 2022, 4:27 pm

Departed Post Office

APACHE JUNCTION, AZ 85120

January 13, 2022, 10:53 am

USPS in possession of item

APACHE JUNCTION, AZ 85120

Feedback

USPS Tracking Plus™



Product Information



See Less ^

Can't find what you're looking for?

Go to our FAQs section to find answers to your tracking questions.

FAQ:

2022-011769 MISC Page: 2241 of 2782

09/26/2022 03:35:37 PM Receipt #: 22-9381

Rec Fee: \$30.00 Darrell James Hill

Gila County, Az, Sadie Jo Bingham, Recorder



2033

**:Claim-#: RF 645 167 639 US -Claim of the
Completion of the Record**

**:Complement-Claim: C ~ :Claim of the Social-Media-
Twitter-usage-timed for the protection of the right: DOI-
1776-AD in the concordance with the PE-2022-AD -
1933-AD -Covenant;**

**:Complement-Claim: C ~ :Claim of the Social-Media-
Twitter-usage-timed for the protection of the right: DOI-
1776-AD in the concordance with the PE-2022-AD -
1933-AD -Covenant;**

**:Complement-Claim: C ~ :Claim of the Social-Media-
Twitter-usage-timed for the protection of the right: DOI-
1776-AD in the concordance with the PE-2022-AD -
1933-AD -Covenant;**

:Darrell-James: Hill, :Ohioan- beneficiary-Executor-Procurator, -:mitigation of the Trustee-derelict- damages: Twitter: September 24th, 2020, 7:05 p.m. - :March 9, 2021, 3:35 p.m.

September 24,
2020
7:05 p.m.

Darrell James hill

644 Tweets
See new Tweets

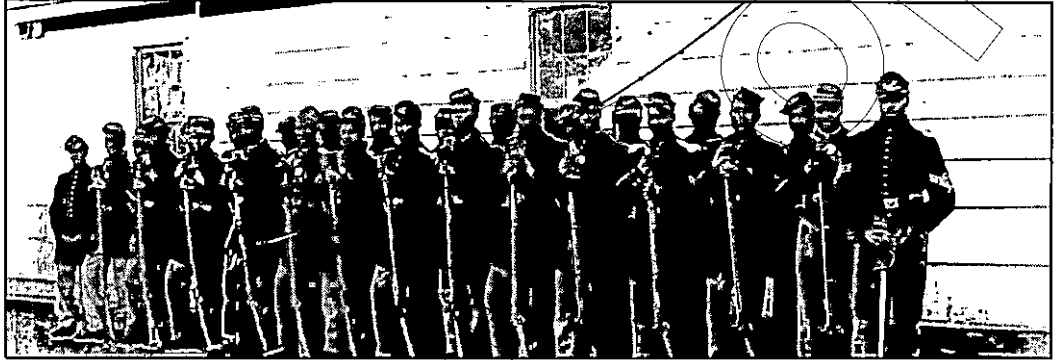

Darrell James hill
@DarBenThu1

:Negro-Ysrael, -:civilian, -:Ohioan, -:beneficiary: DOI-1776-A.D., EBA-1933-A.D.;
Amb. of :Yushuah to kinsman-redeemer/ Ysrael & :Trustee: Concession-1213-A.D.
ONLY THE PROFILE IS SALIENT blackandbluesoulsmatter.wordpress.com

Joined September 2020

[0 Following](#)

[5 Followers](#)

[Tweets](#)

[Tweets & replies](#)

[Media](#)

[Likes](#)

2022-011769 MISC Page: 2243 of 2782
09/26/2022 03:35:37 PM Receipt #: 22-9381
Rec Fee: \$30.00 Darrell James Hill
Gila County, AZ, Sadie Jo Bingham, Recorder

2034

:Executor-Procurator, -:mitigation of the Trustee-derelict- damages ~

:Darrell-James: Hill, :Ohioan- beneficiary-Executor-Procurator, -:mitigation of the Trustee-derelict- damages: Twitter: September 24th, 2020, 7:05 p.m. - :March 9, 2021, 3:35 p.m.

Darrell James hill's Tweets

Pinned Tweet



Darrell James hill
[@DarBenThu1](#)

:i- man am wanting you to send this information to others so :Donald-John: Trump may be known to get this. :i- man have been robbed.

A: Cover to the Generals

<https://blackandbluesoulsmatter.files.wordpress.com/2020/09/a-2020-09-20-cover-to-cjos-and-net-all.pdf>

B: Body of the Document to :Donald,

<https://blackandbluesoulsmatter.files.wordpress.com/2020/09/b-1020-intro-to-finale-67-djt-compile-final-x-done-110-pages.pdf>

[Show this thread](#)

Darrell James hill
[@DarBenThu1](#)

:Just disposed this '

<https://blackandbluesoulsmatter.files.wordpress.com/2020/10/2020-ltr-to-the-barons-final-2-all-2.pdf>

, to the barons, et al. at the Inns of the :Crown -:Temple, London. with cc: to :Donald-John: Trump, -:POTUSA, and: Michael: Pompeo, -:U.S. -SOS.

re: :i- man am Now Trustee!

4:55 PM · Oct 16, 2020 · Twitter Web App

Replying to

[@DarBenThu1](#)

#PromotingFreeSpeechandReligiousLiberty2017 POTUS, -: Donald-John: Trump; Executive Order 13798 of May 4, 2017 Promoting Free Speech and Religious Liberty file:///tmp/mozilla_dj0/2017-09574.pdf US AG, -:Sessions file:///tmp/mozilla_dj0/2017-23269.pdf

2022-011769 MISC Page: 2244 of 2782
09/25/2022 03:35:37 PM Receipt #: 22-9981
Rec Fee: \$30.00 Darrell James Hill
Gila County, Az, Sadie Jo Bingham, Recorder

:Executor-Procurator, -:mitigation of the Trustee-derelict- damages ~

2 / 206

20235

2022-011769

09/26/2022 03:35:37 PM Receipt #: 22-9381
Reg Fee: \$30.00 Darrell James Hill
Gila County, Az, Sadie Jo Bingham, Recorder



Darrell James Hill on Twi... trump may be known to get this. :- man have been robbed. A: Cover to the Generals https://L.co/6Ettq4EOJAS B: Body of the Document to:Do...

File Edit View History Bookmarks Tools Help

All Mail - qmail X New Tab X Onkya receive X Apache Junction X WunderMap X M Inbox (107) - d X Total Präse X Darrell James Hill X b-1020-intro X a-2020-09-20 X New Tab X

https://twitter.com/DarBenThu1/status/1309313123183017984/analytics 150%

Getting Started EXECUTIVE ORDERS REF COMMERCE DAVID STRAIGHTERS AJ

Thread

A: Cover to the Generals
...blackandbluesouls
/a-2020...

B: Body of the Document to: Donald
...blackandbluesouls
/b-1020...

7:05 PM Sep 24, 2022

View Tweet activity

Tweet by Darrell James Hill

Replying to Darrell James Hill

Benefit Session

Tweet Analytics

Darrell James Hill @DarBenThu1

:- man am wanting you to send this information to others so :Donald-John: Trump may be known to get this. :- man have been robbed.
A: Cover to the Generals
...https://blackandbluesoulsmatter.files.wordpress.com/2020/09/a-2020-09-20-cover-to-cjos-and-net-all.pdf ...

B: Body of the Document to: Donald
...https://blackandbluesoulsmatter.files.wordpress.com/2020/09/b-1020-intro-to-finale-67-djt-compile-final-x-done-110-pages.pdf ...

Impressions	1,105
times people saw this Tweet on Twitter	
Media views	1
all views (autoplay and click) of your media are counted across videos, vines, gifs, and images	
Total engagements	93
times people interacted with this Tweet	

n-redeemer/Israel & Trustee
ston-1216 A.D.

pening

airing on ABC

ture today
in Bloom

Earlier today
iana's revenge
relevant, 27 years

4 hours ago
ew And Aaron

messages

Tuesday, November 9, 21:30

:Darrell-James: Hill, :Ohioan- beneficiary-Executor-Procurator, -:mitigation of the Trustee-derelict- damages: Twitter: September 24th, 2020, 7:05 p.m. - :March 9, 2021, 3:35 p.m.

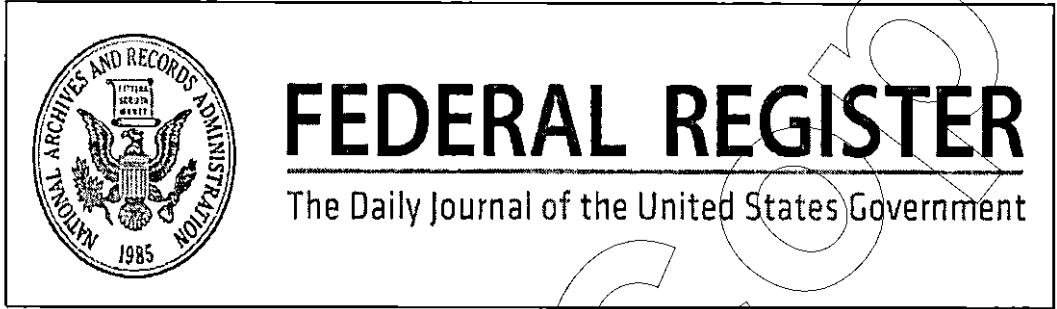

federalregister.gov

Federal Law Protections for Religious Liberty

This notice provides the text of the Attorney General's Memorandum of October 6, 2017, for all executive departments and agencies entitled "Federal Law Protections for Religious Liberty" and the...



September 22,
2020
8:35 p.m.

Darrell James hill
[@DarBenThu1](#)

and possessed by :i- man- Darrell-James: Hill. Very much property has been stolen in violation of all law or right.

September 22,
2020
8:42 p.m.

Darrell James hill
[@DarBenThu1](#)

Please check the evidence in the Gila county, Arizona state, Records office with records starting during 2017. <https://t.co/rhVCCM3iUq?amp=1>
:i- man wish the :all property restored post-haste.

September 22,
2020
6:55 p.m.

Darrell James hill
[@DarBenThu1](#)

. #ADOS Hello, :i- man am new of :09/2020. Please check the Twitter
[@DarBenThu1](#)
. :i- man believe this may resolve the problem.

September 24,
2020
11:49 a.m.

Got: <https://blackandbluesoulsmatter.wordpress.com> open. Plan to put necessary information onto the site for easier access.

2037

:Executor-Procurator, -:mitigation of the Trustee-derelict- damages ~

3 / 206

2022-011769 MISC Page: 2246 of 2782
09/26/2022 03:35:37 PM Receipt #: 22-9381
Rec Fee: \$30.00 Darrell James Hill
Gila County, Az, Sadie Jo Bingham, Recorder

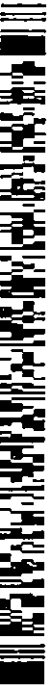

:Darrell-James: Hill, :Ohioan- beneficiary-Executor-Procurator, -:mitigation of the Trustee-derelict- damages: Twitter: September 24th, 2020, 7:05 p.m. - :March 9, 2021, 3:35 p.m.

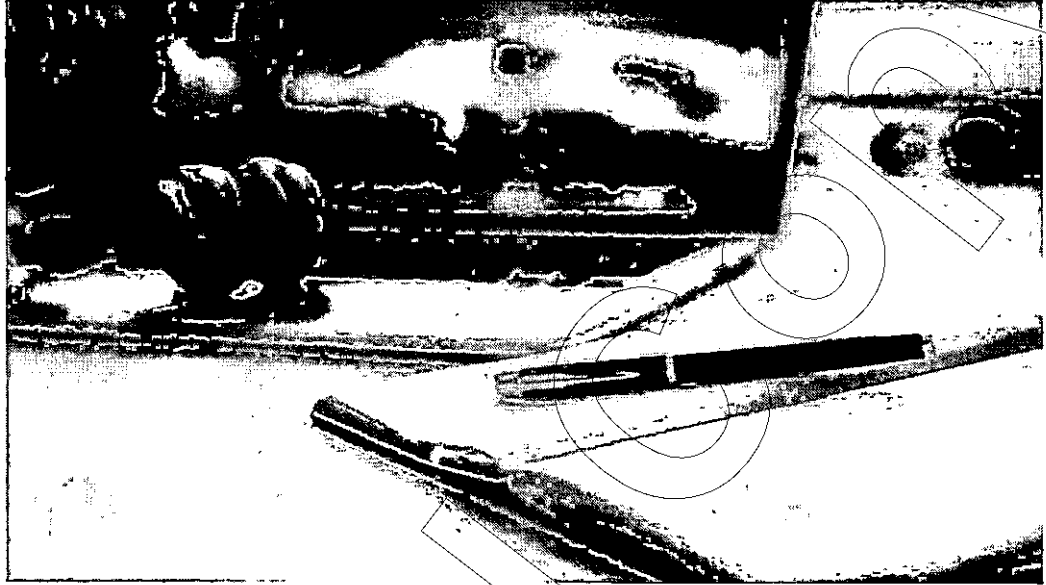

September 24, 2020
7:09 p.m.

Darrell James hill
@DarBenThu1

These are the lots of property: that have have been stolen from :i- man.

Lot#1
https://blackandbluesoulsmatter.files.wordpress.com/2020/09/c-lot-1-gila-cnty-ariz.-rec.-doc-2017_002378.pdf

Lot #2 <https://blackandbluesoulsmatter.files.wordpress.com/2020/09/d-lot-2-gila-cnty-ariz.-rec.-doc-2019-0009291.pdf>

Lot #3 <https://blackandbluesoulsmatter.files.wordpress.com/2020/09/e-lot-3-gila-cnty-ariz.-rec.-doc-2019-0009291.pdf>

September 24, 2020
7:11 p.m.

Darrell James hill
@DarBenThu1

Finally, these are two of the mail filings re: this theft of the property of :i- man

Gila county, 2017_002378
https://blackandbluesoulsmatter.files.wordpress.com/2020/09/gila-county-2017_002378.pdf Gila, county 2019_009291
<https://blackandbluesoulsmatter.files.wordpress.com/2020/09/gila-c>

September 24, 2020
@DarBenThu1

2038

:Executor-Procurator, -:mitigation of the Trustee-derelict- damages ~

2022-011769 MISC Page: 2247 of 2782
09/26/2022 03:35:37 PM Receipt #: 22-9381
Rec Fee: \$30.00 Darrell James Hill
Gila County, Az, Sadie Jo Birmingham, Recorder



Tweet

Tweet Analytics

Darrell James hill @DarBenThu1
 Just opened-up this page to address the deprivation of :rights by the :Donald-John: Trump, -:POTUS-corp Trustee, -:POTUSA- CIC with the :theft of property-claimed and possessed by :i- man- Darrell-James: Hill. Very much property has been stolen in violation of all law or right.

Impressions 283
 times people saw this Tweet on Twitter

Total engagements 3
 times people interacted with this Tweet

[View all engagements](#)

Promote your Tweet

People

James hill
 enThu1
 Ysrael, -:civilian, -:Ohioan,
 iciary; DOI-1776-A.D.,
 33-A.D.; Amb. of Yushuah to
 n-redeemer/Ysrael & Trustee:
 ision-1213-A.D.

Opening

Slago
 te airing on ABC
 hn

uture today!
 min Bloom

Messages

2022-011769 MISC Page: 2248 of 2782
 09/26/2022 08:36:07 PM
 Receipt #: 22-9381
 Darrell James Hill
 Gila County, AZ, Saddle JO Birmingham, Recorder

Tweet

Darrell James hill @DarBenThu1

Please check the evidence in the Gila county, Arizona state, Recorders office with records starting during 2017. [https://www.gilacountyaz.gov/government/recorder/ ...](https://www.gilacountyaz.gov/government/recorder/)

:- man wish the :all property restored post-haste.

8:42 PM · Sep 22, 2022

View Tweet activity

Tweet Analytics

Darrell James hill @DarBenThu1

Please check the evidence in the Gila county, Arizona state, Recorders office with records starting during 2017. [https://www.gilacountyaz.gov/government/recorder/ ...](https://www.gilacountyaz.gov/government/recorder/)

:- man wish the :all property restored post-haste.

Impressions	301
times people saw this Tweet on Twitter	
Total engagements	4
times people interacted with this Tweet	

[View all engagements](#)

Promote your Tweet

People

James hill @DarBenThu1

Ysrael :-civilian, :-Ohioan, :-Secretary: DOI-1776-A.D., :-33-A.D.; Amb. of Yushuah to :-n-redeemer/Ysrael & :-Trustee: :-sion-1213-A.D.

Opening

Stago

teairing on ABC

hn

iture today!

win Bloom

Tweet

Darrell James hill
@DarBenThu1

#ADOS
Hello, :- man am new of :09/2020.
Please check the Twitter @DarBenThu1.

:- man believe this may resolve the problem.

8:55 PM - Sep 22, 2020

View Tweet activity

Tweet your photo

Tweet Analytics

Darrell James hill @DarBenThu1
#ADOS
Hello, :- man am new of :09/2020.
Please check the Twitter @DarBenThu1.

:- man believe this may resolve the problem.

Impressions times people saw this Tweet on Twitter	328
Total engagements times people interacted with this Tweet	7

[View all engagements](#)

Promote your Tweet

People

James hill
@DarBenThu1

Ysrael, :-civilian, :-Ohioan, :-
iciary, DOI-1776-A.D.,
33-A.D.; Amb. of Yushuah to
n-redeemer/Ysrael & Trustee:
ssion-1213-A.D.

Opening

slago
tearing on ABC
hm, Bela

uture today!
min Bloom



2022-011769

Tweet Analytics

Darrell James hill @DarBenThu1
 Got: https://blackandbluesoulsmatter.wordpress.com/ open. Plan to put necessary information onto the site for easier access.

Impressions	244
times people saw this Tweet on Twitter	
Total engagements	9
times people interacted with this Tweet	

[View all engagements](#)

Promote your Tweet
 Your Tweet has 244 total impressions so far.
 Get more impressions on this Tweet!

blackandbluesouls

Home

Black and Blue Liv

11:49 AM - Sep 24, 2

View Tweet activ

Tweet ya

uture today!

rain Bloom

etball - Trending

ternoon

f told to report

lasas 'Smurfs'

day

arily removed

of controlled

ge rules

Privacy Policy Cookie Policy

©2021 Twitter, Inc.

Messages

2022-011769 MISC Page: 2251 of 2782

09/26/2022 03:35:37 PM Receipt #: 22-9381

Rec Fee: \$30.00

Darrell James Hill

Sadie Jo Bingham, Recorder

Gila County, Az, Sadie Jo Bingham, Recorder

Tuesday November 9, 22:12

lot...
Lot #2
...ndbluesouls
lot...
Lot #3
...ndbluesouls
lot...
7:09 PM · Sep 24, 2020
View Tweet activity

Tweet Analytics

Darrell James hill @DarBenThu1
 These are the lots of property: that have have been stolen from :-i- man.
 Lot#1
 ...https://blackandbluesoulsmatter.files.wordpress.com/2020/09/c-lot-1-gila-cnty-ariz.-rec.-doc-2017_002378.pdf ...
 Lot #2
 ...https://blackandbluesoulsmatter.files.wordpress.com/2020/09/d-lot-2-gila-cnty-ariz.-rec.-doc-2019-0009291.pdf ...
 Lot #3
 ...https://blackandbluesoulsmatter.files.wordpress.com/2020/09/e-lot-3-gila-cnty-ariz.-rec.-doc-2019-0009291.pdf ...

Impressions 288
 times people saw this Tweet on Twitter

Total engagements 13
 times people interacted with this Tweet

View all engagements

n-redeemer/ Ysrael & Trustee:
 sion-1213-A.D.
 pening
 Slago
 tearing on ABC
 Jim, Balla
 ture today!
 min Bloom
 fier today
 first city
 join the
 ending
 StreetMOREpolitical

Messages

Tuesday November 9, 22:12

2776

2022-011769 MISC Page: 2252 of 2782
 09/26/2022 09:55:37 PM Receipt #: 22-9381
 Rec Fee: \$30.00 Darrell James Hill
 Gila County, Az, Sadie Jo Bingham, Recorder

Tweet

Darrell James hill
@DarBenThu1

Finally, these are two of the mail filings re: this theft of the property of :i- man Gila county, 2017_002378
...https://blackandbluesoulsmatter.files.wordpress.com/2020/09/gila-county-2017_002378.pdf ...
Gila, county 2019_009291
...https://blackandbluesoulsmatter.files.wordpress.com/2020/09/gila-county-2019_009291.pdf ...

7:11 PM · Sep 24, 2020

View Tweet activity

Tweet Analytics

Darrell James hill @DarBenThu1

Finally, these are two of the mail filings re: this theft of the property of :i- man Gila county, 2017_002378
...https://blackandbluesoulsmatter.files.wordpress.com/2020/09/gila-county-2017_002378.pdf ...
Gila, county 2019_009291
...https://blackandbluesoulsmatter.files.wordpress.com/2020/09/gila-county-2019_009291.pdf ...

Impressions	330
times people saw this Tweet on Twitter	
Total engagements	3
times people interacted with this Tweet	

View all engagements

People

James hill
@DarBenThu1

Ysrael, -civilian, -Ohioan, -Trustee; DOI-1776-A.D., 1776-A.D.; Amb. of Yushuah to the United States; h-redeemer/Ysrael & Trustee; Ysrael-1213-A.D.

Opening

Slago

tearing on ABC

ture today!

min Bloom

Page: 2253 of 2782

MISC

2022-011769

Receipt #: 22-9381

Darrell James Hill

09/26/2022 03:35:37 PM

Rec Fee: \$30.00

Saddle Jo Bingham, Recorder

Gila County, Az

11/9/2022



:Darrell-James: Hill, :Ohioan- beneficiary-Executor-Procurator, -:mitigation of the Trustee-derelict- damages: Twitter: September 24th, 2020, 7:05 p.m. - :March 9, 2021, 3:35 p.m.

10:05 p.m.

#Reparationist Please check the/my DarBenThu1 profile for to help me with getting property restored to me that has been stolen by :Donald-John: Trump. See: pdf, A and B. and etx. data.

September 25, Darrell James hill
2020 @DarBenThu1

4:43 p.m.

#GenMilley :Donald-John: Trump has stolen lots of property from me, and :i-man want it restored. See <https://twitter.com/DarBenThu1> help get this property restored please. :i- man do not want to be ignored.

September 27, Darrell James hill
2020 @DarBenThu1

1:06 a.m.

:i- man am :Darrell-James: Hill, Negro-Ysrael,-:American. :Donald-John: Trump has stolen lots of property from :i- man. See: B.on Twitter- @DarBenThu1, et al. for explanation. Help expose.

October 2, Darrell James hill
2020 @DarBenThu1

11:40 a.m.

Dr. Frances Cress Welsing - The Psychological Slavery of Black People in The Media <https://youtube.com/watch?v=jrEikj30uY8> wow

Oct 5, 2020
4:45 p.m.

See: Twitter- Witness List for the Common-Law, -:Public Notice on the matter of the :Notary-Public- Dishonor Upon the :Trespass and Violation of the :Duty and Obligations by the Trustee of the Legislative- Covenant(s).

Unofficial
2045

:Darrell-James: Hill, :Ohioan- beneficiary-Executor-Procurator, -:mitigation of the Trustee-derelict- damages: Twitter: September 24th, 2020, 7:05 p.m. -:March 9, 2021, 3:35 p.m.

**:Darrell-James: Hill, -:ambassador of the Almighty-God, -Jehovah:
PO Box 3806, Apache Junction, Arizona 85117 - Twitter: @DarBenThut**

1/3

From: :Darrell-James: Hill, man-Adam- ambassador of the Almighty-God -covenanter to the :Declaration-of-Independence -1776 A.D., et seq., kinsman-redeemer of :Negro-Ysrael, Ysrael, and the Holy-Church.

To: uSoIA- All- peoples in total, and also including :Donald-John: Trump, et al., :who have ears and eyes to see ('shema'- hebrew meaning doing), and :who stand for the survival of the uSoIA- people, and including the blind and the deaf.

c/o- cc: :Twitter, YouTube, Verizon, and Gmail' accesses, for the effect of the :six-degrees-of-separation' to :all-man-kind - i.e., witnesses, in the order to :1) Notice the documents sent to :Donald-John, that :they would be now recognized to and by the man :Donald-John, -:Trustee, -:Trump. :In- that done is by the will of the Almighty-God of this nation for the :all- people to benefit in the fair equity and right to :life, liberty and property - unalienable. :In The context, to wit:

- 1) You seen or have been sent the message(s) -See: Appendix: Table 1, a-1- re: the 'book' of information by the way of the simple-design portals;
- 2) God does not see it the way :- man do. To:Almighty-God-:this is Not the joke. And,
- 3) The uSoIA- people are numbered as :... :400,000,000 -soul-journer, - 'cestui-que-vie - beneficiaries'. Thereto: do the math: Trust-fund:real money value (not fiat -FRN-value) divided by 400,000,000 uSoIA- people equals: 1,875 gold, 0.9997 U.S. coin :in- specie (surety-yield into the EBA- 1933 A.D., et seq.). The trust is with 'man' in 'money'... not fiat. It is a larger amount/ uSoIA person; and,
- 4) :- man have demanded to close the :dry-brust -ended: 2003 A.D.-. Careful: B.A.P. attorneys cannot help you in this Common Law- Equity matter, as, they cannot work for the benefit of 'man,' right? and,
- 5) :None of the trust principle is spendable by the Trustee, But they can/and do BORROW against the trust, and create United States-corp debt- yes, two: 1) POTUS- United States-corp; 2) POTUSA of the uSoIA- people original and sustained, derived- authority of the 'Declaration of Independence, 1776 A.D.', unalienable;
- 6) :Donald-John cannot break the :Emergency-Banking-Act of 1933 A.D., et seq., UNLESS :you-all say-so, e.g., Let's do this :Donald-John. He will need MORE SECURITY;
- 7) :It is time; we are of age. It is the Father's will be done!

Cc:

@perrybaconjr, @myykeclark, @WNYC, @Les_Gingerables, @coffeeshopjihad, @KatySKennedy, @ruthymunoz, @tamond03, @LeifhallyJane, @MLK50Memphis, @msanchezMLA, @mym_jm, @EdLaimore, @propublica, @CaitlinNolan, @CoreyGJohnson, @TB_Times, @myyke, @efsaosoguoda, @SairaWPLG, @AshleyCBS48, @gwenlawless, @malonebarry, @LaurenFedor, @ndungca, @Tenfikowski, @ccnyderj, @BibiDahi, @BlackinCMBio, @DrShardeDavis, @_ericson, @_CharlesPreston, @Devin_Eleven, @alzhargriva, @BlackinCancer, @Tykeo_James, @cliza_morey, @critter_jm, @ScottWhitmore14, @VeganRachel, @LisaWalkerWhite, @nuariak, @cailinzeneta, @meganmckinley23, @ayyeenadgoyy, @ca_mcmulch, @brianmalyman2, @dianegr35390748, @gretchenvheimex, @irvinolribes, @Lbazydo, @SNFRides, @natlex, @Aaralogan, @ProfessorMFitz, @m_dot_philly, @NBA, @ArizonaDOT, @DHSgov, @AZCourts, @PimaSheriff, @mezoaz, @Shane, @WalchChad, @BreakingBrown, @mister18900, @ericfordham, @dnvotz, @RandalOisTV, @RealDysonGray, @SecondCityCop, @ABC7NY, @ClassicalThis, @JarryFig1974, @JessicaSwint, @matthias_romau, @RokoMijicUK, @gardnerams, @JordanSchachtel, @TheDamasFelder, @amandalaninacci, @IlyabeAmes, @KaseHydeNY, @EricTendian, @SamuelAJones, @supischokirch, @S_Fitzpatrick, @BytMktBaker, @ABC, @VenturaReport, @sav_says, @ThePost, @DruJordan, @HuffPost, @hasia, @wildcats, @SebGorka, @hollyfeld, @CaliforniaPanda, @hodgepwns, @thornton, @ali, @DrZuhdJasser, @rebeccahallhaus, @LibertarianBlue, @BoSnerdley, @mad_tberals,

Ambassadorial doc to Beneficiary Witnesses 1/3

:Executor-Procurator, -:mitigation of the Trustee-derelict- damages

2022-011769 MISC Page: 2255 of 2782

09/28/2022 03:35:37 PM Receipt #: 22-9381
Rec Fee: \$30.00 Darrell James Hill
Gila County, Az, Sadie Jo Bingham, Recorder



Darrell James hill on Twitter: See: Twitter- Witness List for the Common-Law, -:Public Notice on the matter of the :Notary-Public- Dishonor Upon the :Trespass and Violation of the :Duty and Obligations by the Trustee of the Legislative- Covenant(s)...

File Edit View History Bookmarks Tools Help

All Mail - d... X New Tab X Onkya receive... X Apache Junc... X WunderMap... X Inbox (107)-... X Total Praise - Y X Darrell James X b-1020-intro-t X a-2020-09-20- X New Tab X

https://twitter.com/DarBenThu1/status/131326377299623936/analytics 150% I'll never be more loved

Getting Started EXECUTIVE ORDERS REF COMMERCE DAVID STRAIGHTERS AJ

Thread

4:44 PM • Oct 5, 2022

View Tweet activity

Darrell James Hill @DarBenThu1

Replying to @DrEdwinV

Can we arrange a meeting with you on youtube.com

Add another photo or video

Promote your Tweet

Messages

Privacy Policy Cookie Policy ©2021 Twitter, Inc.

Tweet Analytics

Darrell James Hill @DarBenThu1

See: Twitter- Witness List for the Common-Law, -:Public Notice on the matter of the :Notary-Public- Dishonor Upon the :Trespass and Violation of the :Duty and Obligations by the Trustee of the Legislative- Covenant(s). pic.twitter.com/lbjVxI5XTI

Impressions	363
times people saw this Tweet on Twitter	
Total engagements	28
times people interacted with this Tweet	

View all engagements



Darrell James Hill on Twitter: "#Reparationist Please check the/my DarBenThu1 profile for to help me with getting property restored to me that has been stolen by :Donald-John: Trump. See: pdf, A and B. and etx. data." / Twitter - Mozilla Firefox

File Edit View History Bookmarks Tools Help

All Mail - djhill X New Tab X Onlyko receive X Apache Junct X WunderMap X My Inbox (107) X Total Praise X Darrell James X b-1020-intro-1 X a-2020-09-20 X New Tab X

https://twitter.com/DarBenThu1/status/1309358294348173319/analytics

Getting Started EXECUTIVE ORDERS REF COMMERCE DAVID STRAIGHTERS AJ

Tweet

Darrell James Hill @DarBenThu1

#Reparationist
Please check the/my DarBenThu1 profile for to help me with getting property restored to me that has been stolen by :Donald-John: Trump. See: pdf, A and B. and etx. data.

10:05 PM · Sep 24, 2022

[View Tweet activity](#)

Tweet Analytics

Darrell James Hill @DarBenThu1

#Reparationist
Please check the/my DarBenThu1 profile for to help me with getting property restored to me that has been stolen by :Donald-John: Trump. See: pdf, A and B. and etx. data.

Impressions	326
times people saw this Tweet on Twitter	
Total engagements	3
times people interacted with this Tweet	

[View all engagements](#)

[Promote your Tweet](#)

People

James Hill @DarBenThu1

Ysrael, --civilian, --Ohioan, --Redeemer; DOJ-1776-A.D., --Amb. of Yushuah to the U.S.; n-redeemer/Ysrael & Trustee; --Amb. of Yushuah to the U.S.; DOJ-1213-A.D.

Opening

Sago

te airing on ABC

nn: Bella

ture today!

min Bloom

Messages

Tuesday November 9, 22:12



Darrell James Hill on Twitter

File Edit View History Bookmarks Tools Help

All Mail - djhill X New Tab X Onkyo receive X Apache Juncr X WunderMap X Inbox (107) X Total Praise X Darrell James X b-1020-intro X a-2020-09-20 X New Tab X

https://twitter.com/DarBenThu1/status/1309639635785579969/analytics

Getting Started EXECUTIVE ORDERS REF COMMERCE DAVID STRAIGHTERS AJ

Tweet

Darrell James Hill
@DarBenThu1

#GenMilley : Donald John Trump has stolen lots of property from me, and I want it restored. See <https://twitter.com/DarBenThu1>

help get this property restored please. I do not want to be ignored.

4:43 PM · Sep 25, 2022

View Tweet activity

Tweet Analytics

Darrell James Hill @DarBenThu1

#GenMilley : Donald John Trump has stolen lots of property from me, and I want it restored. See <https://twitter.com/DarBenThu1>

help get this property restored please. I do not want to be ignored.

Impressions	307
times people saw this Tweet on Twitter	
Total engagements	11
times people interacted with this Tweet	

View all engagements

Promote your Tweet

People

James Hill
@DarBenThu1

Ysrael, -civilian, -Ohioan,
ficiary: DOI-1776-A.D.,
33-A.D.; Amb. of Yushuah to
n-redeemer/Ysrael & trustee;
sion-1213-A.D.

Opening

Slago
teairing on ABC
nn, Bella

uture today!
min Bloom

Messages

Tuesday November 9, 22:11

0500

09/26/2022 03:35:37 PM Receipt #: 22-9381
Rec Fee: \$30.00 Darrell James Hill
Gila County, Az, Sadie Jo Bingham, Recorder



Darrell James Hill on Twitter - property from :i- man. See: B.on Twitter- @DarBenThu1 , et al. for explanation. Help expose. / Twitter - Mozilla Firefox

File Edit View History Bookmarks Tools Help

All Mail - dhill X New Tab X Onkyo receive X Apache Juncos X WunderMap X Inbox (107) X Total Praise X Darrell James X b-1020-intro X a-2020-09-20 X New Tab X

https://twitter.com/DarBenThu1/status/1310128586469171202/analytics 150% I'll never be more loved

Getting Started EXECUTIVE ORDERS REF COMMERCE DAVID STRAIGHTERS AJ

Tweet

Darrell James Hill @DarBenThu1

#i-man-am-Ysrael,-American of property from @DarBenThu1

1:06 AM - Sep 27, 2022

View Tweet activity

Tweet your thoughts

Tweet Analytics

Darrell James Hill @DarBenThu1

:i- man am :Darrell-James: Hill, Negro-Ysrael,-American. :Donald-John: Trump has stolen lots of property from :i- man. See: B.on Twitter- @DarBenThu1 , et al. for explanation. Help expose.

Impressions 245

times people saw this Tweet on Twitter

Promote your Tweet

Your Tweet has 245 total impressions so far. Get more impressions on this Tweet!

Promote your tweet

People

James Hill
enThu1
Ysrael,-civilian,-Ohioan,
iciary:DOI-1776-A.D.,
33-A.D.; Amb. of Yushuah to
n-redeemer/Ysrael & Trustee;
sion-1213-A.D.

Opening

siago
te airing on ABC
hn, Bella

ture today!
min Bloom

Messages

2051

09/26/2022 03:35:37 PM Receipt #: 22-9381
Rec Fee: \$30.00 Darrell James Hill
Gila County, Az, Sadie Jo Bingham, Recorder



Black People In The Media https://t.co/0VjyUBub6wow / Twitter - Mozilla Firefox

File Edit View History Bookmarks Tools Help

All Mail - djhill X New Tab X Onkyo receive X Apache Junct X WunderMap X Mi Inbox (107) X Total Praise X Darrell James X b-1020-intro X a-2020-09-20 X New Tab X

https://twitter.com/DarBenThu1/status/1312100143219396608/analytics 150%

Getting Started EXECUTIVE ORDERS REF COMMERCE DAVID STRAIGHTERS AJ

Tweet Analytics

Darrell James hill @DarBenThu1
Dr. Frances Cress Welsing - The Psychological Slavery of Black People in The Media
<https://www.youtube.com/watch?v=jrEikj30uY8> ...
wow

Impressions	399
Media views	3
Total engagements	17

View all engagements

Dr. Frances Cress Welsing
of Black People
[youtube.com](https://www.youtube.com/watch?v=jrEikj30uY8)
WOW
11:40 AM - Oct 2, 2022
View Tweet activity
1 Quote Tweet

James Hill
@DarBenThu1
Ysrael - civilian, -Ohioan,
-Michigan; DOI-1776-A.D.,
-1833-A.D.; Amb. of Ysrahel to
the U.S.; -redeemer/ Ysrahel & Trustee
of the U.S. - 1213-A.D.

Opening
Biago
te airing on ABC
John, Billa

ture today!
min Bloom

messages

Tuesday November 9, 22:11

:Darrell-James: Hill, :Ohioan- beneficiary-Executor-Procurator, -:mitigation of the Trustee-derelict- damages: Twitter: September 24th, 2020, 7:05 p.m. - :March 9, 2021, 3:35 p.m.

:Darrell-James: Hill, -ambassador of the Almighty-God, -Jehovah.
 PO Box 3806, Apache Junction, Arizona 85117 - Twitter: @DarBenThut

2 / 3

@SurgeArellano, @OhioJASU, @AldoTV, @ehandlamb1, @PhilPHalalman, @ZachCrenshaw, @Keyana, @Amyalvomanaz, @ReallyAmerican1, @CesarChavezAZ, @predjedrak_cg, @lauren_casita, @DrPaulGosar, @dinovak, @AZ4Aging, @yasminv, @BrianaWhitney, @Jenniler_Fox10, @Fabian_Estrada, @kokanovich, @jeremiahcota, @Renekyl, @DE_DOJ, @JeremiaWifeit, @elisanayjohnson, @lombaki, @matthewjpagano, @olonghi, @WayneSchutsky, @katsymo_news, @randana_jav, @hvanbickland, @abimbetsanna, @khalawhite, @DyMcK14, @merissahamilton, @zhenryaz, @megocconnor13, @mhborger, @lonhunnichit, @az_woods, @SadoghMokarize, @AZMarinoBral, @dhickman1, @azirshooter, @GingersnapMts, @belindainaz, @The_ACRU, @WaltBlackmanAZ, @TaylorKinnep, @MonWilliamsTV, @pear33, @Brandon_MejiaTV, @kashh1, @_MelissaEgan, @GeneralBmovich, @NFL_Webb, @ANANursingWorld, @UCSFNurse, @BSU_UCF, @BSU_PSU, @BSUNYU, @AARP, @UR_at_MSU, @richardabonero, @MausitusPM, @GabonEmbassyDC, @MarthaMukawa, @GhanduroilIbya, @SAADO_SSD, @BeninDiplomatie, @edmanagwa, @BrookingsInst, @nwkonya, @USEmbKinshasa, @DiGelahun, @NotatPeaceOslo, @BashirAhmad, @ThomasGnau, @sil, @emolick, @natashantrost, @ArashMassoudi, @UnionFanAccount, @spetypi, @RogueWhitehouse, @codeovets, @ScrippsNational, @kailancolms, @TucsonRamen, @KTAR923, @DrUmarJohnson, @MsBaldot46, @6thbyn, Ms. Ballo #ADOS lol, @Chad_Boogie

APPENDIX TABLE 1:
STATEMENTS MADE THROUGH THE TECH-MEDIA- ACCESSES, et al, for the effect of the six-degrees
-of-separation-to-all-man-kind in the order to NOTICE THE DOCUMENTS SENT TO THE MAN
:Donald-John, that the document, et al. would be made known-about to and by the man :Donald-John,
-Trustee, -Trump.

a	Heho. :- man am :Darrel-James: Hill. Point :Donald-John: Trump has stolen lots of property from :me. :- want the property restored. See: B, et al. At: https://blackandbluesoutsmatter.wordpress.com/2020/09/25/a-2020-09-20-cover-to-cjos-and-net-all/
b	:- man am :Darrel-James: Hill. Point :Donald-John: Trump has stolen my property from :me. See: B: https://blackandbluesoutsmatter.wordpress.com/2020/09/25/a-2020-09-20-cover-to-cjos-and-net-all/
c	Twitter took down @DarBenThut about -- :- man am :Darrel-James: Hill. Point :Donald-John: Trump has stolen my property from :me. See: B :- https://blackandbluesoutsmatter.wordpress.com/2020/09/25/a-2020-09-20-cover-to-cjos-and-net-all/
d	:Donald-John: Trump has stolen property from :me that :- want restored. See: B, et al. At: https://blackandbluesoutsmatter.wordpress.com/2020/09/25/a-2020-09-20-cover-to-cjos-and-net-all/ . :Donald-John finally received the delivery Sept. 30, 2020.
e	:Donald-John: Trump has stolen property from :me that :- want restored. See: B, et al. At: https://blackandbluesoutsmatter.wordpress.com/2020/09/25/a-2020-09-20-cover-to-cjos-and-net-all/ . :Donald-John finally received the delivery Sept. 30, 2020. :- man just want my property.
f	:Donald-John: Trump has stolen property from :- man :Darrel-James: Hill. See Notice: B, Twitter: @DarBenThut, : Donald-John received Sept. 30, 2020, OR: https://blackandbluesoutsmatter.wordpress.com/2020/09/25/a-2020-09-20-cover-to-cjos-and-net-all/

Ambassadorial doc to Beneficiary Witnesses 2 / 3

2022-0111769 MISC Page: 2261 of 2782

09/26/2022 03:35:37 PM Receipt #: 22-9381

Rec Fee: \$30.00 Darrell James Hill

Gila County, Az, Santa Jo Bingham, Recorder



:Executor-Procurator, -:mitigation of the Trustee-derelict- damages ~

7 / 206

:Darrell-James: Hill, :Ohioan- beneficiary-Executor-Procurator, -:mitigation of the Trustee-derelict- damages: Twitter: September 24th, 2020, 7:05 p.m. - :March 9, 2021, 3:35 p.m.

:Darrell-James: Hill, -:ambassador of the Almighty-God, -Jehovah.
PO Box 3806, Apache Junction, Arizona 85117 - Twitter: @DarBenThu1

3/3

POSTMASTER: PLEASE POST IN A CONSPICUOUS PLACE. — JAMES A. FARLEY, Postmaster General

UNDER EXECUTIVE ORDER OF THE PRESIDENT

Issued April 5, 1933

all persons are required to deliver ON OR BEFORE MAY 1, 1933 all GOLD COIN, GOLD BULLION, AND GOLD CERTIFICATES now owned by them to a Federal Reserve Bank, branch or agency, or to any member bank of the Federal Reserve System.

Executive Order

WHEREAS the Federal Reserve Act, as amended, and the Gold Certificate Act, as amended, authorize the Secretary of the Treasury to issue such orders as may be necessary to carry out the purposes of such Acts; and

WHEREAS it is the policy of the Government to maintain the gold standard and to prevent the circulation of gold coin and gold bullion and gold certificates outside the Federal Reserve System; and

WHEREAS it is the policy of the Government to prevent the export of gold coin and gold bullion and gold certificates from the United States; and

WHEREAS it is the policy of the Government to prevent the hoarding of gold coin and gold bullion and gold certificates; and

WHEREAS it is the policy of the Government to prevent the use of gold coin and gold bullion and gold certificates as a medium of exchange outside the Federal Reserve System; and

WHEREAS it is the policy of the Government to prevent the use of gold coin and gold bullion and gold certificates as a store of value outside the Federal Reserve System; and

WHEREAS it is the policy of the Government to prevent the use of gold coin and gold bullion and gold certificates as a unit of account outside the Federal Reserve System; and

WHEREAS it is the policy of the Government to prevent the use of gold coin and gold bullion and gold certificates as a standard of value outside the Federal Reserve System; and

WHEREAS it is the policy of the Government to prevent the use of gold coin and gold bullion and gold certificates as a measure of wealth outside the Federal Reserve System; and

WHEREAS it is the policy of the Government to prevent the use of gold coin and gold bullion and gold certificates as a means of payment outside the Federal Reserve System; and

WHEREAS it is the policy of the Government to prevent the use of gold coin and gold bullion and gold certificates as a medium of exchange, a store of value, a unit of account, a standard of value, and a means of payment outside the Federal Reserve System;

NOW, THEREFORE, I, FRANKLIN D. ROOSEVELT, President of the United States of America, do hereby order that all persons who are in possession or control of gold coin, gold bullion, or gold certificates shall deliver the same to a Federal Reserve Bank, branch or agency, or to any member bank of the Federal Reserve System, on or before May 1, 1933, and that any person who fails to do so shall be deemed to be in violation of the law.

Special attention is directed to the exceptions allowed under Section 2 of the Executive Order.

CRIMINAL PENALTIES FOR VIOLATION OF EXECUTIVE ORDER
\$10,000 fine or 10 years imprisonment, or both, as provided in Section 9 of the order.

FRANKLIN D. ROOSEVELT
The White House
April 5, 1933.
Secretary of the Treasury

U.S. Government Printing Office: 1933 O-50824

Ambassadorial doc to Beneficiary Witnesses 3/3

4:44 PM · Oct 5, 2020 · Twitter Web App

2022-011769 MISC Page: 2262 of 2782
09/26/2022 03:35:37 PM Receipt #: 22-9381
Rec Fee: \$30.00 Darrell James Hill
Gila County, Az, Sadie Jo Bingham, Recorder

Oct 7, 2020 · Darrell James hill
5:57 a.m. @DarBenThu1

2053

:Executor-Procurator, -:mitigation of the Trustee-derelict- damages ~

:Darrell-James: Hill, :Ohioan- beneficiary-Executor-Procurator, -:mitigation of the Trustee-derelict- damages: Twitter: September 24th, 2020, 7:05 p.m. - :March 9, 2021, 3:35 p.m.

Can we arrest politicians who violate the Constitution? <https://youtube.com/watch?v=fLGwqDjkgIg>
:Dr. Edwin Vieira, Jr. 1'28"
5:57 AM · Oct 7, 2020 · Twitter Web App

Darrell James hill
@DarBenThu1
:Jeff: Sessions said this:



Office of the Attorney General
Washington, D. C. 20530

President Donald J. Trump
The White House
Washington, D.C. 20500

Dear Mr. President,

At your request, I am submitting my resignation.

Since the day I was honored to be sworn in as Attorney General of the United States, I came to work at the Department of Justice every day determined to do my duty and serve my country. I have done so to the best of my ability, working to support the fundamental legal processes that are the foundation of justice.

The team we assembled embraced your directive to be a law and order Department of Justice. We prosecuted the largest number of violent offenders and firearm defendants in our country's history. We took on transnational gangs that are bringing violence and death across our borders and protected national security. We did our part to restore immigration enforcement. We targeted the opioid epidemic by prosecuting doctors, pharmacists, and anyone else who contributes to this crisis with new law enforcement tools and determination. And we have seen results. After two years of rising violent crime and homicides prior to this administration, those trends have reversed—thanks to the hard work of our prosecutors and law enforcement around the country.

I am particularly grateful to the fabulous men and women in law enforcement all over this country with whom I have served. I have had no greater honor than to serve alongside them. As I have said many times, they have my thanks and I will always have their backs.

Most importantly, in my time as Attorney General we have restored and upheld the rule of law—a glorious tradition that each of us has a responsibility to safeguard. We have operated with integrity and have lawfully and aggressively advanced the policy agenda of this administration.

I have been honored to serve as Attorney General and have worked to implement the law enforcement agenda based on the rule of law that formed a central part of your campaign for the Presidency.

Thank you for the opportunity, Mr. President.

Sincerely,

Jefferson B. Sessions III
Attorney General

2022-011769 MISC Page: 2263 of 2782
09/26/2022 03:35:37 PM Receipt #: 22-9381
Rec Fee: \$30.00 Darrell James Hill
Gila County, Az, Sadie Jo Bingham, Recorder

**:Darrell-James: Hill, :Ohioan- beneficiary-Executor-Procurator, -:mitigation of the Trustee-
derelict- damages: Twitter: September 24th, 2020, 7:05 p.m. - :March 9, 2021, 3:35 p.m.**

11:34 PM · Oct 7, 2020 · Twitter Web App

Oc. 16, 2020
4:55 p.m.

Darrell James hill
[@DarBenThu1](#)

Replying to
[@DarBenThu1](#)
:Just disposed this '
<https://blackandbluesoulsmatter.files.wordpress.com/2020/10/2020-ltr-to-the-barons-final-2-all-2.pdf> , to the barons, et al. at the Inns of the :Crown -:Temple, London. with cc: to :Donald-John: Trump, -:POTUSA, and: Michael: Pompeo, -:U.S. -SOS. re: :i- man am Now Trustee!

November 2,
2020
12:19 a.m.

Darrell James hill
[@DarBenThu1](#)
[#PromotingFreeSpeechandReligiousLiberty2017](#) POTUS, -: Donald-John: Trump; Executive Order 13798 of May 4, 2017 Promoting Free Speech and Religious Liberty file:///tmp/mozilla_dj0/2017-09574.pdf US AG, -:Sessions file:///tmp/mozilla_dj0/2017-23269.pdf

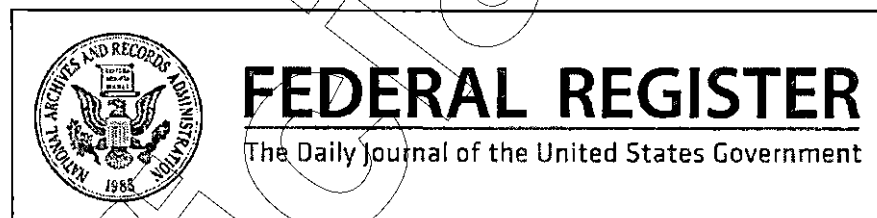

federalregister.gov
[Federal Law Protections for Religious Liberty](#)
[This notice provides the text of the Attorney General's Memorandum of October 6, 2017, for all executive departments and agencies entitled "Federal Law Protections for Religious Liberty" and the...](#)
12:19 AM · Nov 2, 2020 · Twitter Web App

September 24,
2020
7:05 p.m.

Darrell James hill
[@DarBenThu1](#)
:i- man am wanting you to send this information to others so :Donald-John: Trump may be known to get this. :i- man have been robbed. A: Cover to the Generals
<https://blackandbluesoulsmatter.files.wordpress.com/2020/09/a-2020-09-20-cover-to-cjos-and-net-all.pdf>
B: Body of the Document to :Donald.
<https://blackandbluesoulsmatter.files.wordpress.com/2020/09/b-1020-intro-to-finale->

:Executor-Procurator, -:mitigation of the Trustee-d

2022-011769 MISC Page: 2264 of 2782
09/26/2022 03:35:37 PM Receipt #: 22-9381
Rec Fee: \$30.00 Darrell James Hill
Gila County, Az, Sadie Jo Bingham, Recorder



2055

2056



File Edit View History Bookmarks Tools Help

https://t.co/Xf2w0ufvLb :Dr. Edwin Vieira, Jr. 1'28" / Twitter - Mozilla Firefox

All Mail - djhl X New Tab X Onkyo receive X Apache Juncx X WunderMap X In inbox (107) X Total Praise X Darrell James X b-1020-intro X a-2020-09-20 X New Tab X

https://twitter.com/DarBenThu1/status/1313825752744292357/analytics 150% I'll never be more loved

Getting Started EXECUTIVE ORDERS REF COMMERCE DAVID STRAIGHTERS AJ

Thread

Darrell James Hill @DarBenThu1

Can we arrest politicians who violate the Constitution?
youtube.com/watch?v=fLGwqDjkglg ...
:Dr. Edwin Vieira, Jr. 1'28"

5:57 AM - Oct 7, 2022

View Tweet activity

Tweet your thoughts

Tweet Analytics

Darrell James Hill @DarBenThu1
Can we arrest politicians who violate the Constitution?
<https://www.youtube.com/watch?v=fLGwqDjkglg> ...
:Dr. Edwin Vieira, Jr. 1'28"

Impressions times people saw this Tweet on Twitter	290
Media views all views (autoplay and click) of your media are counted across videos, vines, gifs, and images	1
Total engagements times people interacted with this Tweet	3

View all engagements

People

James Hill
@DarBenThu1
Ysrael, -civilian, -Ohioan, -politician; DOI-1776-A.D., 33-A.D.; Amb. of Yushuah to n-redeemer/Ysrael & Trustee; Mission-1213-A.D.

Opening

Sago
tearing on ABC
in, Bella

ture today!
min Bloom

Messages

Tuesday November 9, 22:11

2057

09/26/2022 03:35:37 PM Receipt #: 22-9381

Rec Fee: \$30.00 Darrell James Hill

Gila County, Az, Sadie Jo Bingham, Recorder



File Edit View History Bookmarks Tools Help

https://t.co/14hAngk3Li / Twitter - Mozilla Firefox

All Mail - djhill X New Tab X Onkyo receive X Apache Junct X WunderMap X Mi Inbox (107) X Total Praise X Darrell James X b-1020-intro X a-2020-09-20 X New Tab X

https://twitter.com/DarBenThu1/status/1314091751309668352/analytics 150%

Getting Started EXECUTIVE ORDERS REF COMMERCE DAVID STRAIGHTERS AJ

Thread

integrity and have

I have been

enforcement agen

Presidency.

Thank you

11:34 PM - Oct 7, 20

View Tweet activity

Tweet yo

Darrell James Hill @DarBenThu1 • Oct 16, 2020

Tweet Analytics

Darrell James Hill @DarBenThu1

:Jeff: Sessions said this: pic.twitter.com/14hAngk3Li

Impressions

times people saw this Tweet on Twitter

317

Total engagements

times people interacted with this Tweet

28

[View all engagements](#)

Classic

college basketball season

@Champions @Classic at

Garden, with Kansas taking

te and Kentucky facing Duke

sh K. Duke

ternoon

f told to report

fies as Smurfs!

States

Privacy Policy · Cookie Policy

© 2021 Twitter, Inc.

Messages

Promote your Tweet

Messages

858

09/26/2022 03:35:37 PM Receipt #: 22-9381
Rec Fee: \$30.00 Darrell James Hill
Gila County, Az, Sadie Jo Bingham, Recorder



Darrell James Hill on Twitter: "Just disposed this 'https://t.co/tvPM530sRS', to the barons, et al. at the Inns of the Crown - Temple, London. with cc: to :Donald-John: Trump, -POTUSA, and: Michael: Pompeo, -U.S. -SOS. re: i- man am Now Trustee!" /...

File Edit View History Bookmarks Tools Help

All Mail - djhill X New Tab X Onkyo receive X Apache Junt X WunderMap X Ms Inbox (107) - d X Total Praise - Y X Darrell James X b-1020-intro-t X a-2020-09-20 X New Tab X

https://twitter.com/DarBenThu1/status/1317252671184764928/analytics

Getting Started EXECUTIVE ORDERS REF. COMMERCE DAVID STRAIGHTERS AJ

Thread

Darrell James Hill @DarBenThu1

Just disposed of '...ndbluesoul /2020-1... , to :Crown -:Tem with cc: to :D Michael: Pom Trustee!

4:55 PM - Oct 16, 2020

View Tweet activity

Tweet Analytics

Darrell James Hill @DarBenThu1

:Just disposed this '...https://blackandbluesoulsmatter.files.wordpress.com/2020/10/2020-ltr-to-the-barons-final-2-all-2.pdf ...', to the barons, et al. at the Inns of the Crown - Temple, London. with cc: to :Donald-John: Trump, -POTUSA, and: Michael: Pompeo, -U.S. -SOS. re: i- man am Now Trustee!

Impressions	278
times people saw this Tweet on Twitter	
Total engagements	21
times people interacted with this Tweet	

[View all engagements](#)

Promote your Tweet

People

James Hill @DarBenThu1

Ysrael, -civilian, -Ohioan, -licianty, DOI-1776-A.D., 33-A.D.; Amb. of Yushuah to n-redeemer/ Ysrael & Trustee: sion-1213-A.D.

pening

s ago

te airing on ABC

hin, Bella

ture today!

tmn Bloom

:Darrell-James: Hill, :Ohioan- beneficiary-Executor-Procurator, -:mitigation of the Trustee-derelict- damages: Twitter: September 24th, 2020, 7:05 p.m. - :March 9, 2021, 3:35 p.m.

67-djt-compile-final-x-done-110-pages.pdf
7:05 PM · September 24, 2020 · Twitter Web App

October 16,
2020
4:55 p.m.

Darrell James hill
@DarBenThu1

.
:Just disposed this '
https://blackandbluesoulsmatter.files.wordpress.com/2020/10/2020-ltr-to-the-barons-final-2-all-2.pdf , to the barons, et al. at the Inns of the :Crown -:Temple, London. with cc: to :Donald-John: Trump, -:POTUSA, and: Michael: Pompeo, -:U.S. -SOS. re: :i- man am Now Trustee!

October 16,
2020
4:55 p.m.

:Just disposed this
'https://blackandbluesoulsmatter.files.wordpress.com/2020/10/2020-ltr-to-the-barons-final-2-all-2.pdf , to the barons, et al. at the Inns of the :Crown -:Temple, London. with cc: to :Donald-John: Trump, -:POTUSA, and: Michael: Pompeo, -:U.S. -SOS. re: :i- man am Now Trustee!

Replying to
@DarBenThu1
#PromotingFreeSpeechandReligiousLiberty2017 POTUS, -: Donald-John: Trump; Executive Order 13798 of May 4, 2017 Promoting Free Speech and Religious Liberty file:///tmp/mozilla_dj0/2017-09574.pdf US AG, -:Sessions file:///tmp/mozilla_dj0/2017-23269.pdf

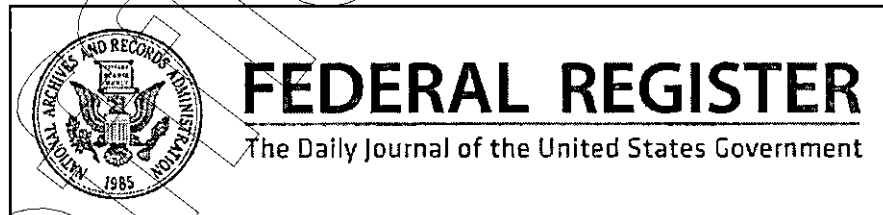

federalregister.gov
Federal Law Protections for Religious Liberty
This notice provides the text of the Attorney General's Memorandum of October 6, 2017, for all executive departments and agencies entitled "Federal Law Protections for Religious Liberty" and the...

2022-011769 MISC Page: 2268 of 2782
09/26/2022 03:35:37 PM Receipt #: 22-9381
Rec Fee: \$30.00 Darrell James Hill
Gila County, Az, Sadie Jo Bingham, Recorder



USA

COPY

:Darrell-James: Hill, :Ohioan- beneficiary-Executor-Procurator, -:mitigation of the Trustee-derelict- damages: Twitter: September 24th, 2020, 7:05 p.m. - :March 9, 2021, 3:35 p.m.

October 19,
2020
4:14 p.m.



Darrell James hill
[@DarBenThu1](#)

See: "Sentinel Events for the Restoration of the Deprived- Property~the 'Concession of 1213 A.D', Concession-1213-A.D., et seq.~ stolen by Trustee-Derelicts; so to recover properly both, solely, and as the :kinsman-redeemer for :Negro-Ysrael, Ysrael and the Holy-church"

2022-011769 MISC Page: 2269 of 2782
09/26/2022 03:35:37 PM Receipt #: 22-9381
Rec Fee: \$30.00 Darrell James Hill
Gila County, Az, Sadie Jo Bingham, Recorder



2060
:Executor-Procurator, -:mitigation of the Trustee-derelict- damages ~

12 / 206

09/26/2022 03:35:37 PM Receipt #: 22-9381
Rec Fee: \$30.00 Darrell James Hill
Gila County, Az, Sadie Jo Bingham, Recorder



Darrell James Hill on Twitter: "Just disposed this 'https://c.co/vtPM530sk9 to the barons, et al. at the Inns of the Crown, with cc: to :Donald John: Trump, :-POTUSA, and: Michael: Pompeo, :-U.S. -SOS. re: :-man am Now Trustee!"

File Edit View History Bookmarks Tools Help

All Mail: djhill X New Tab X Onkyo receive: X Apache Juncti: X WunderMap: X Inbax (107): X Total Praise: X Darrell James Hill X b-1020-intro: X a-2020-09-20: X New Tab X

https://twitter.com/DarBenThu1/status/1317252871184764928/analytics 150%

Getting Started EXECUTIVE ORDERS REF COMMERCE DAVID STRAIGHTERS AJ

Tweet Analytics

Darrell James Hill @DarBenThu1
:Just disposed this '...https://blackandbluesoulsmatter.files.wordpress.com/2020/10/2020-ltr-to-the-barons-final-2-all-2.pdf ... , to the barons, et al. at the Inns of the Crown :-Temple, London. with cc: to :Donald John: Trump, :-POTUSA, and: Michael: Pompeo, :-U.S. -SOS. re: :-man am Now Trustee!

Impressions	277
times people saw this Tweet on Twitter	
Total engagements	20
times people interacted with this Tweet	

[View all engagements](#)

Promote your Tweet

Thread

Just dispose
'...ndbluesoul
/2020-ltr-to
:Crown :-Tem
with cc: to :D
Michael: Pom
Trustee!

4:55 PM - Oct 16, 2022

View Tweet activity

Tweet yo

Darrell Jam
Replying to

#PromotingFreeSpeechandReligiousLiberty2017

people

James Hill
enThu1

Ysrael :-civilian, :-Ohioan,
iciary DOI-1776-A.D.,
33-A.D.; Amb. of Yushuah to
n-redeemer/ Ysrael & Trustee:
sion-1213-A.D.

pening

ago

re airing on ABC

inn, Bell)

ture today!

min Bloom

messages

Tuesday November 9, 2022



Darrell James Hill on Twitter: See: "Sentinel Events for the Restoration of the Deprived-Property-the Concession of 1213 A.D., et seq.- stolen by Trustee-Derelicts; so to recover properly both, solely, and as the :kinsman-red...

File Edit View History Bookmarks Tools Help

All Mail - dhill X New Tab X Onkyo receive X Apache Junction X WunderMap X Inbox (107) X Total Praise X Darrell James Hill X b-1020-Intro X a-2020-09-20 X New Tab X

https://twitter.com/DarBenThu1/status/1318329697042771969/analytics 150% i'll never be more loved

Getting Started EXECUTIVE ORDERS REF COMMERCE DAVID STRAIGHTERS AJ

Tweet Analytics

Darrell James Hill @DarBenThu1
 See: "Sentinel Events for the Restoration of the Deprived-Property-the Concession of 1213 A.D., Concession-1213-A.D., et seq.- stolen by Trustee-Derelicts; so to recover properly both, solely, and as the :kinsman-redeemer for :Negro-Ysrael, Ysrael and the Holy-church" pic.twitter.com/!8LmdkTRHP

Impressions times people saw this Tweet on Twitter	261
Total engagements times people interacted with this Tweet	19

[View all engagements](#)

Tweet

4:14 PM · Oct 19, 2022

View Tweet activity

Search Twitter

future today!
 min Bloom
 States
 classic
 college basketball season
 @Champions Classic at
 Garden, with Kansas taking
 te and Kentucky facing Duke
 shK, Duke

stand updates for

Promote your Tweet

Messages

:Darrell-James: Hill, :Ohioan- beneficiary-Executor-Procurator, -:mitigation of the Trustee-derelict- damages: Twitter: September 24th, 2020, 7:05 p.m. - :March 9, 2021, 3:35 p.m.

:Darrell-James: Hill, Negro-Ysrael, :civilian, :Ohioan, :Executor- beneficiary;
:Ambassador of the Messiah-Yushuah
PO Box 3806, Apache Junction, Arizona 85117

Twitter.com/DarBenThu1 1/3

:Sentinel -Events for the Restoration of the Deprived- Property-the 'Concession of 1213 A.D',
Concession-1213-A.D., et seq. - stolen by Trustee-Derelicts; so to recover property-stolen,
solely, and as the :kinsman-redeemer for :Negro-Ysrael, Ysrael and the Holy-church.

Sole-man, and Kinsman-redeemer, Contact:

- 1 :i- man- :Darrell-James: Hill, :Negro-Ysrael, Ohioan-Ø/1958, -executor- Beneficiary,
:Ambassador of the Messiah-Yushuah ~Jesus~ and the kinsman-redeemer, -Trustee of the
Concession-1213-A.D, for the Negro-Ysrael, Ysrael and the Holy-church of the Messiah-
Yushuah.

Roman-church Dereliction: Jorge-Mario: Bergoglio dereliction

- 2 On April 2nd, 2020 A.D., the 'Pope- Francis' of the Roman-church -Trustee-Derelict to the
Concession-1213-A.D.- Covenant, tacitly abandoned the :Concession-1213-A.D.
Trusteeship denying a) the 'Pope' as the 'vicar' of the Messiah-Yushuah; and: b) succession
of Peter, -both designations were false and from the beginning, -dereliction, and
with c) asserting this -appellation: Jorge- Mario without relevance to the Messiah-Yushuah.

Exercised- Claim for the Emergency Banking Act of 1933, et seq., 'EBA-1933-A.D.':
Legislative, -Dry-Trust

- 3 On May 18th, 2020 A.D., the USPS- RMN RE 047 610 440 US, the :Equity-Claim,
Presentment: Express Trust: Emergency Banking Act of 1933 A.D. - Trust' is disposed to:
Donald-John: Trump, POTUSA-CIC; POTUS -:TRUSTEE, with the USPS -CMN 7008 1300
0002 2256 4705 to :Steve-Turner; Maughin, U.S.- SOT, -trustee, and with the USPS RE 047
610 438 US to: William-Pelham: Barr, U.S.-A.G, et al., for the presumption- set for you the
authorization to account, settle and close the :EBA-1933-2003-A.D. :legislative-dry-trust
for :i- man sole, and, as the kinsman-redeemer, for :Negro-Ysrael, Ysrael and the Holy-
church.

Area- Trustee-actors informed of :Responsible-truth- actions taken by i- man which
commonly-historically results in the Danger of: harms against and upon the :Negro-
Ysraelite kind of man that :i- man am

- 4 On May 20th, 2020 A.D., the USPS -RMN RE 322 387 576 US, -:Specialty- Presentment: ...
'is disposed to the man: Mark; Lamb, the :Pinal-county, Arizona state, Sheriff with copy
to: all of the Arizona-state -county-Sheriffs; and, subsequently, to: all of the Arizona-
state -county-Attorneys, for the notice, recordation, and administrative and bodily-
protection from the U.S.-government, et al.- malefactors

Notice to the Pinal, et al.- Arizona Trustees to :i- man Accepting and Taking the :Trusteeship
Authority of the Concession-1213-A.D. from the Roman-church- Derelict, et al.- Jorge-Mario:
Bergoglio

- 5 On July 24th, 2020 A.D., the USPS -RMN RE 322 387 576 US, -:Specialty- Presentment,
To The Roman -Church, et al.- Usurpers, For the Cure and Relief in the :Equity-Claim, and
For the Remedy-Required For the Trespassing Upon The Children of Ysrael/Israel, et al.' is

1: Ambassador of the Messiah-Yushuah means: context of the love of the Most-High-God, and with
His :Son the Messiah-Yushuah who came to us as a man as we are, taught us, healed us and died for us,
for the atonement required for man-kind's :sin for :all of :mankind for :whosoever will accept :that gift: the
:Righteous-Judge, and Not the respecter of persons. His will be done. Amen.

History of Sentinel-Events for the Restoration of the Property of :i- man, sole, and as :Kinsman-redeemer for :Negro-Ysrael, Ysrael and the Holy-church

1/3

2022-011769 MISC Page: 2272 of 2782
09/26/2022 03:35:37 PM Record #: 22-9381
Rec Fee: \$30.00 Darrell James Hill
Gila County, Az, Sadie Jo Bingham, Recorder

2023 :Executor-Procurator, -:mitigation of the Trustee-derelict- damages ~

13 / 206

:Darrell-James: Hill, :Ohioan- beneficiary-Executor-Procurator, -:mitigation of the Trustee-derelict- damages: Twitter: September 24th, 2020, 7:05 p.m. - :March 9, 2021, 3:35 p.m.

**:Darrell-James: Hill, Negro-Ysrael, :civilian, :Ohioan, :Executor- beneficiary;
:Ambassador of the Messiah-Yushuah
PO Box 3806, Apache Junction, Arizona 85117**

Twitter.com/DarBenThu1 2/3

disposed to the man :Jorge-Mario: Bergoglio with :copy to the man :Donald-John: Trump, by :- man, :-ambassador addressing the :dereliction of the Trustee-duty, on behalf of self, and as kinsman-redoemer for :Negro-Ysrael, Ysrael and the Holy-church, The :USPS -RMN RE 322 387 576 US, :Specialty- Presentment: To The Roman-Church, et al. is received on :August 2020 A.D.

Reiteration of items above: 1-6: Demand for the Restoration of :All-Property Stolen, Intangible and Tangible

6 On September 18th, 2020 A.D., the :USPS -RMN RE 322 398 401 US, :-Specialty Presentment: USPS RMN RE 322 387 562 US to: Donald-John: Trump, :-Trustee, for Theft of Covenant Property: unalienable-Rights-From-God-Almighty :-Covenant, for :Restoration of: intangible and tangible stolen-property with remedy to: :Darrell-James: Hill, :-Negro-Ysrael, :-Ohioan-o-1958-A.D., :-civilian, :-Executor :-beneficiary, :-Ambassador, is disposed to :Donald-John: Trump with :copy to :Steve-Turner: Mnuchin, :-US-SOT -Minister by :USPS CMN 7003 1360 0002 2256 4705, for the restoration of all property claimed and thereby-possessed by :- man, solely, and as kinsman-redoemer.

:United States of America' -military Informed of the Deprivation-without-right of administration over the Private-Property of :-man, with the evidence of :same, in violation of :all-law, and the Emancipation Proclamation of 1863, EP-1863-A.D. and General Order 100 of 1863, 'Liber-Code'

7 On September 21, 2020 A.D., the USPS -RMN RE 322 387 580 US, specially presentment 'Regarding: Stolen Property-claimed and possessed by :-man, Stolen by the POTUS, :-Trustee, :- POTUSA-CIC, and aided and abetted by you, et al.' is disposed to the man: James-Charles: McConville, :-COS, Army of the United States of America- Army, et al. for the restoration of all property claimed and thereby-possessed by :- man, solely, and as kinsman-redoemer, and, for the protection from the Roman-church and the U.S.-corp-Trustee, :-deep-state- actors or malefactors, Received: September 26th, 2020 A.D.

:Fraud-action by :Jorge-Mario: Bergoglio, et al., in the violation of the Concession-1213-A.D.

8 On October 10, 2020 A.D., the man :Jorge-Mario: Bergoglio, with no authority and in-fraud to the Concession-1213-A.D., without the right, and with No consent from :- man :Darrell-James: Hill, Trustee of the Concession-1213-A.D, reportedly presumed to administer the :property of the Holy-church in the agreement with the anti-Messianic-national :government of :China -with the 'CCP'- leader, 'Xi: Jinping', et al., for the CCP to administer matters of the 'Holy-church' oversteering the Messiah-Yushuah-Jesus-.

:Crown-Temple- in-Chancery Notified: :-man, Negro-Ysrael am now-to-appear- Trustee of the Concession-1213-A.D.: To Account, and Cease :All-Concession-1213-A.D.-related- Expenditures' Demanded

9 On October 19, 2020 A.D., the 'Specialty Presentment: USPS RMN: RE 322 397 593 US, To: Crown - Trustee For Report of the Completed change of Trustee: For :Restoration of: intangible and tangible stolen-property' is disposed to the Crown-Temple -Chancery, et al. - to :-man- 1) :David :Richards, :The-Rt-Hon-Lord-Justice, Treasurer - Honourable Society of Lincoln's Inn, 2) :Brian :Leveson, :The-Rt-Hon-Sir, Treasurer - The Honourable Society of the Middle Temple, 3) :Guy :Fetherstonhaugh, :-QC, Treasurer -- The Honourable Society of the Inner Temple, and 4) :Anthony :Harking, :-Brigadier, OBE, Under Treasurer - The

History of Several Events for the Restoration of the Property of :- man, sole, and as 100% owner-redoemer for :Jorge-Torres, Thron and the Holy-church

2/3

2022-011769 MISC Page: 2273 of 2782
09/26/2022 03:35:37 PM Receipt #: 22-9381
Rec Fee: \$30.00 Darrell James Hill
Gila County, AZ, Sadie Jo Bingham, Recorder



:Executor-Procurator, -:mitigation of the Trustee-derelict- damages ~

14 / 206

:Darrell-James: Hill, :Ohioan- beneficiary-Executor-Procurator, -:mitigation of the Trustee-derelict- damages: Twitter: September 24th, 2020, 7:05 p.m. - :March 9, 2021, 3:35 p.m.

:Darrell-James: Hill, Negro-Ysrael, :civilian, :Ohioan, :Executor- beneficiary;
:Ambassador of the Messiah-Yushuah
PO Box 3806, Apache Junction, Arizona 85117

Twitter.com/DarBenThu1 3/3

Honourable Society of Gray's Inn with :USPS -RMN 322 398 392 US copy to: Michael-R.: Pompo, U.S. - S.O.S. c/o: Lisa-D.: Konna, Executive Secretary, AND to: Donald-John: Trump, for the matter of the tacitly-acquiesced that :- man be Trustee to the Concession- 1213-A.D. on and by the July 24th, 2020 A.D., :USPS -RMN-RE 322 397 576 US, -:Specialty- Prosement: To The Roman -Church, et al - Usurers... - (#5 above).

:Summary of the Property -Claimed and Possessed

10 **Summary of the Rights of the Claimed and thereon Possessed Property by :- man, -Darrell-James: Hill, Negro-Ysrael, -civilian, -Executor- beneficiary, solely, and as the Kinsman-Redeemer:**

- Property a) with regard to the Concession-1213-A.D., the adherence to the protection to the House of Ysrael and the 'Holy-church'; individuals and property;
- Property b) with regard to the Declaration-of-Independence-1776-A.D., the adherence to the protection of the Almighty-God -given-unalienable -rights;
- Property c) :Restoration in-specie of the three (3) lots of :property-stolen from :- man:
 - i) :USPS -RMN RE 322 399 279 US disposed to: U.S. - A.G. - :Loretta Lynch; see: LOT #1 Gila cnty, Ariz. Rec. Doc# 2017-002378; pp. 240-548;
 - ii) :USPS -RMN RE 322 399 251 US disposed to: U.S. -A.G. - :Jeff Sessions; see LOT #2 Gila cnty, Ariz. Rec. Doc# 2019-0009291; pp. 10 -335;
 - iii) :USPS -RMN RE 322 399 248 US disposed to: U.S. -A.G. - :Jeff Sessions; see LOT #3 Gila cnty, Ariz. Rec. Doc# 2019-0009291; pp. 376- 737;
- Property d) with regard to the 'Property c)', to the adherence to the law of the 'deprivation of :property- contract agreements in honor for the each one of the three (3) -lots- contract -agreements for the deprivation of :property-presently unlawfully-held or stolen;
- Property e) The exercise of the contractual-right for the 'cestui-que-usage' of the EBA-1933-A.D. - :FRA-1913-A.D. : periodic-trust-fund upon the request-receipt of :FRNs, by the law of the contract for the private-use of the trust proceeds by the right of the beneficiary. 'cestui-que-usage' -right ~ :process is completed and stolen.
- Property f) The exercise of the right for the accounting, settle and closure of the 'cestui-que-via'- EBA-1933- A.D. -trust-dobenture- accounts for :- man ~ :process is presently completed and stolen.

Without prejudice.

Darrell-James Hill, Amb.

:Darrell-James: Hill, :Negro-Ysrael, -civilian, -Ohioan;
:Executor- beneficiary; :Ambassador of the Messiah-Yushuah.

History of Selected Events by the Distribution of the Property of :- man, solely, and as Kinsman-Redeemer for (Negro-Ysrael, Ysrael and the Holy-church

3/3

2022-011769 MISC Page: 2274 of 2782
09/26/2022 03:35:37 PM Receipt #: 22-9381
Rec Fee: \$30.00 Darrell James Hill
Gila County, Az, Sadie Jo Bingham, Recorder

October 19, 2020 Darrell James hill @DarBenThu1

4:14 PM · Oct 19, 2020 · Twitter Web App

:Executor-Procurator, -:mitigation of the Trustee-derelict- damages ~

15 / 206

:Darrell-James: Hill, :Ohioan- beneficiary-Executor-Procurator, -:mitigation of the Trustee-derelict- damages: Twitter: September 24th, 2020, 7:05 p.m. - :March 9, 2021, 3:35 p.m.

4:41 p.m. See: Specialty-Presentment to :Crown- :Temple -Inns, that :Roman-church: 1) Acquiesced ..., and 2) thereby, have NO Authority to Negotiate for the Holy-church; and 3) cc: to Donald-John: Trump, -:POTUSA and :Michael: Pompeo, -:U.S.- :SOS.

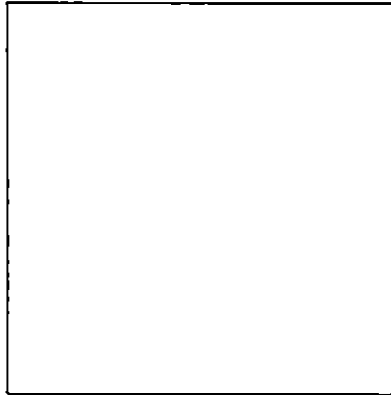

blackandbluesoulsmatter.wordpress.com
B) Specialty-Presentment to :Crown- :Temple -Inns, that :Roman-church: 1) Acquiesced Vacated the...
See: Specialty-Presentment to the Crown Temple
4:41 PM · Oct 19, 2020 · Twitter Web App

October 20, 2020
2:59 p.m. Darrell James hill
[@DarBenThu1](https://twitter.com/DarBenThu1)
#Concession1213AD The Concession-1213-A.D. refers to the "Concession of 1213 A.D." when Britain's King John I conceded Ireland and England over the Roman-church. Why? He was losing the war, and needed to get help from the Roman-church- Knights- Templar.
2:59 PM · Oct 20, 2020 · Twitter Web App

November 2, 2020
12:00 a.m. Darrell James hill
[@DarBenThu1](https://twitter.com/DarBenThu1)
Replying to
[@DarBenThu1](https://twitter.com/DarBenThu1)
John I: Concession Of England To The Pope Innocent III, 1213
<https://sourcebooks.fordham.edu/source/john1a.asp>
Magna Carta, 1215 <https://avalon.law.yale.edu/medieval/magframe.asp>
https://en.wikipedia.org/wiki/Magna_Carta#13th_century
'.... The charter was annulled by Pope Innocent III.

:Executor-Procurator, -:mitigation of the Trustee-derelict- damages ~

2022-011769 MISC Page: 2275 of 2782
09/29/2022 03:35:37 PM Receipt #: 22-9381
Rec Fee: \$30.00 Darrell James Hill
Gila County, AZ, Sadie Jo Bingham, Recorder



2066

1967

09/26/2022 03:35:37 PM Receipt #: 22-9381

Rec Fee: \$30.00 Darrell James Hill
Gila County, Az, Sadie Jo Bingham, Recorder



Darrell James Hill on Twitter

File Edit View History Bookmarks Tools Help

https://twitter.com/DarBenThu1/status/1318336427227107328/analytics

Getting Started EXECUTIVE ORDERS REF COMMERCE DAVID STRAIGHTERS AJ

Home

Search Twitter

See: Specialty- Presentment to :Crown- :Temple -Inns, that :Roman-church: 1) Acquiesced ... and 2) thereby, have NO Authority to Negotiate for the Holy-church; and 3) cc: to Donald-John: Trump, -POTUSA and :Michael: Pompeo, -U.S.- :SOS. https://blackandbluesoulsmatter.wordpress.com/2020/10/16/b-specialty-presentment-to-crown-temple-inns-that-roman-church-1-acquiesced-vacated-the-concession-1213-a-d-covenant-trustee-replacement-in-august-2020-a-d-and-2-thereby-have-no-author/ ...

4:41 PM · Oct 19, 2020

View tweet activity

Tweet Analytics

Darrell James Hill @DarBenThu1

See: Specialty- Presentment to :Crown- :Temple -Inns, that :Roman-church: 1) Acquiesced ... and 2) thereby, have NO Authority to Negotiate for the Holy-church; and 3) cc: to Donald-John: Trump, -POTUSA and :Michael: Pompeo, -U.S.- :SOS. https://blackandbluesoulsmatter.wordpress.com/2020/10/16/b-specialty-presentment-to-crown-temple-inns-that-roman-church-1-acquiesced-vacated-the-concession-1213-a-d-covenant-trustee-replacement-in-august-2020-a-d-and-2-thereby-have-no-author/ ...

Impressions	235
times people saw this Tweet on Twitter	
Total engagements	6
times people interacted with this Tweet	

[View all engagements](#)

People

James Hill
@DarBenThu1
Ysrael - a civilian - Oniban
clay DO-1776-A.D.,
33-A.D; Amb. of Yushuah to
n-redaemer/ Ysrael & Trustee
sion-1213-A.D.

pening

teaching on ABC

ture today!
min Bloom

Messages



Darrell James Hill on Twitter: "#Concession1213AD The Concession-1213-A.D. refers to the 'Concession of 1213 A.D.' when Britain's King John I conceded Ireland and England over the Roman-church. Why? He was losing the war, and needed to get help from the Roman-church- Knights- Templar."

File Edit View History Bookmarks Tools Help

All Mail - dhill X New Tab X Onkyo receiver X Apache Juno X WunderMap X Inbox (107) - c X Total Prize X Darrell James Hill X b-1020-intro X a-2020-09-20 X New Tab X

https://twitter.com/DarBenThu1/status/1318673094270054400/analytics 150%

Getting Started EXECUTIVE ORDERS REF COMMERCE DAVID STRAIGHTERS AJ

Tweet Analytics

Darrell James Hill @DarBenThu1
#Concession1213AD The Concession-1213-A.D. refers to the "Concession of 1213 A.D." when Britain's King John I conceded Ireland and England over the Roman-church. Why? He was losing the war, and needed to get help from the Roman-church- Knights- Templar.

Impressions 292
times people saw this Tweet on Twitter

Total engagements 6
times people interacted with this Tweet

[View all engagements](#)

[Promote your Tweet](#)

Thread

Darrell James Hill @DarBenThu1

#Concession1213AD The Concession-1213-A.D. refers to the "Concession of 1213 A.D." when Britain's King John I conceded Ireland and England over the Roman-church. Why? He was losing the war, and needed to get help from the Roman-church- Knights- Templar.

2:59 PM · Oct 20, 2021

View Tweet activity

Replying to @DarBenThu1

Liberty Concession of 1213 AD to The Papacy - 1012

people

James Hill
@DarBenThu1
Ysrael - civilian - Ohioan
iciary - DOI 1776-A.D.
33-A.D.; Amb. of Ysrahel to
n-redeemer/ Ysrahel & Trustees
sion-1213-A.D.

opening

te airing on ABC

pure today!

with Bloom

messages

Tuesday November 9, 22:07

:Darrell-James: Hill, :Ohioan- beneficiary-Executor-Procurator, -:mitigation of the Trustee-derelict- damages: Twitter: September 24th, 2020, 7:05 p.m. - :March 9, 2021, 3:35 p.m.

en.wikipedia.org
Magna Carta - Wikipedia

October 20,
2020
3:05 p.m.

Darrell James hill
@DarBenThu1
#EP1863AD The Emancipation Proclamation was the effective :January 1, 1863 A.D. for the southern states named; that, if the secession wasn't over then their immoral-slave- trade was over by Executive Order under the Emergency Powers of the POTUSA-CIC.
3:05 PM · Oct 20, 2020 · Twitter Web App

November 2,
2020
12:05 a.m.

Darrell James hill
@DarBenThu1
.
Replying to
@DarBenThu1
American Civil War, 1861-1865 https://en.wikipedia.org/wiki/American_Civil_War
The Preliminary Emancipation Proclamation, 1862 September 22, 1862
https://archives.gov/exhibits/american-origins_iv/sections/transcript_preliminary_emancipation.html <https://avalon.law.yale.edu/medieval/magframe.asp>
Emancipation Proclamation, 1863 January 1, 1863
<https://archives.gov/exhibits/featured-documents/emancipation-proclamation/transcript.html> <https://avalon.law.yale.edu/medieval/magframe.asp>

archives.gov
Transcript of the Proclamation
January 1, 1863 A Transcription By the Presid

October 20,
2020
3:13 p.m.

Darrell James hill
@DarBenThu1
#DOI1776AD The Declaration of Independence of 1776 A.D. was the underdog-agreement with the Almighty-God with the :United-Colonies for God's UN-ALIEN-ABLE -Rights to supercede the :British- Empire's imperialist-tax or kill policy. And, then the war heated-up: 1775-1783 A.D.
3:13 PM · Oct 20, 2020 · Twitter Web App

:Executor-Procurator, -:mitigation of the Trustee-d

2022-011769 MISC Page: 2278 of 2782
09/26/2022 03:35:37 PM Receipt #: 22-9381
Rec Fee: \$30.00 Darrell James Hill
Gila County, Az, Sadie Jo Bingham, Recorder



:Darrell-James: Hill, :Ohioan- beneficiary-Executor-Procurator, -:mitigation of the Trustee-derelict- damages: Twitter: September 24th, 2020, 7:05 p.m. - :March 9, 2021, 3:35 p.m.

November 2,
2020
12:10 a.m.



Darrell James hill
[@DarBenThu1](#)

Replying to
[@DarBenThu1](#)

American Revolutionary War, 1775–1783

https://en.wikipedia.org/wiki/American_Revolutionary_War

Declaration of Independence, July 4, 1776

<https://avalon.law.yale.edu/medieval/magframe.asp>

The ARW would-should have been lost Except for the Almighty-God-given 'UN-ALIEN- ABLE RIGHTS' -covenant to all of God's Negro-Ysrael on the land

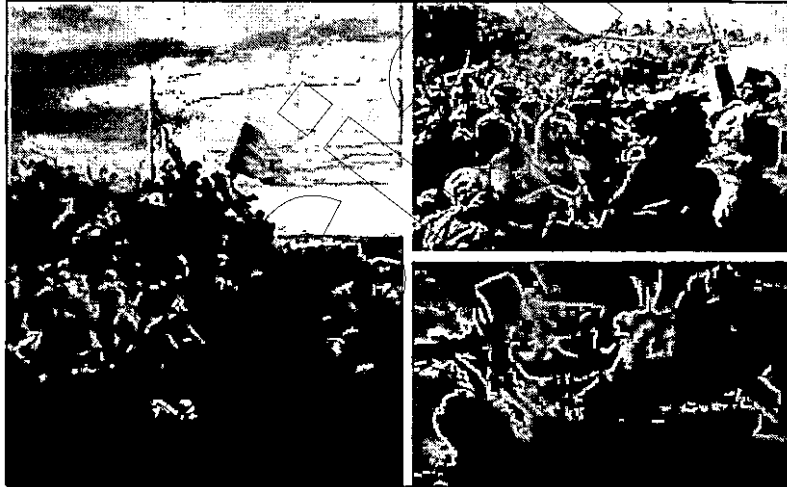

[en.wikipedia.org](https://en.wikipedia.org/wiki/American_Revolutionary_War)
[American Revolutionary War - Wikipedia](#)

October 21,
2020
1:05 p.m.

Darrell James hill
[@DarBenThu1](#)

MORE SIMPLER WORDS: WHAT ARE MY INTENTIONS, AND WHAT YOU WANT DONE? FROM I. See: Response to :Sister-L.

2022-011769 MISC Page: 2279 of 2782
09/25/2022 09:35:37 PM Receipt #: 22-9381
Rec Fee: \$30.00 Darrell James Hill
Gila County, Az, Sadie Jo Bingham, Recorder

UN
2070

:Executor-Procurator, -:mitigation of the Trustee-derelict- damages ~

Tweet Analytics

Darrell James hill @DarBenThu1
 #EP1863AD The Emancipation Proclamation was the effective :January 1, 1863 A.D. for the southern states named; that, if the secession wasn't over then their immoral-slave-trade was over by Executive Order under the Emergency Powers of the POTUSA-CIC.

Impressions times people saw this Tweet on Twitter	293
Total engagements times people interacted with this Tweet	6

[View all engagements](#)

[Promote your Tweet](#)

Thread

Darrell James hill @DarBenThu1

#EP1863AD The Emancipation Proclamation was the effective January 1, 1863 A.D. for the southern states named; that, if the secession wasn't over then their immoral-slave-trade was over by Executive Order under the Emergency Powers of the POTUSA-CIC.

3:05 PM · Oct 20 2020

View tweet analytics

Tweet your photos

Darrell James hill @DarBenThu1

Replying to @DarBenThu1

American @Millenn 1861-1865

people

James hill @DarBenThu1

Ysrael, -civilian, -Ohioan, -Secretary: DOI-1776-A.D., 1776-1863-A.D., Amb. of Yushuah to the Redeemer/ Ysrael & Trustee: Ysrael-1213-A.D.

opening

on The CW

future today!

with Bloom

Messages



2021

Tweet Analytics

Darrell James hill @DarBenThu1
 American Revolutionary War, 1775-1783
[https://en.wikipedia.org/wiki/American_Revolutionary_War ...](https://en.wikipedia.org/wiki/American_Revolutionary_War...)

Declaration of Independence, July 4, 1776
[https://avalon.law.yale.edu/medieval/magframe.asp ...](https://avalon.law.yale.edu/medieval/magframe.asp...)

The ARW would-should have been lost Except for the Almighty-God-given 'UN-ALIEN- ABLE RIGHTS' -covenant to all of God's Negro-Ysrael on the land

Impressions	191
times people saw this Tweet on Twitter	
Total engagements	4
times people interacted with this Tweet	

[View all engagements](#)

Transferring data from ton.twimg.com...

Tuesday November 9, 22:06

2022-011769 MISC Page: 2281 of 2782
 Receipt #: 22-9381
 Rec Fee: \$30.00
 Darrell James Hill
 Sadie Jo Bingham, Recorder
 Gila County, Az, Sadie Jo Bingham, Recorder

Handwritten: 2022

Thread

Darrell James Hill
@DarBenThu1

#DOI1776AD
A.D. was the
God with the
ABLE -Rights
imperialist-tax
up: 1775-1783

3:18 PM - Oct 20, 2020

View Tweet

Tweet your thoughts

Darrell James Hill @DarBenThu1 · Nov 2, 2020

Tweet Analytics

Darrell James Hill @DarBenThu1
#DOI1776AD The Declaration of Independence of 1776 A.D. was the underdog-agreement with the Almighty-God with the :United-Colonies for God's UN-ALIEN-ABLE-Rights to supercede the :British-Empire's imperialist-tax or kill policy. And, then the war heated-up: 1775-1783 A.D.

Impressions times people saw this Tweet on Twitter	304
Total engagements times people interacted with this Tweet	7

[View all engagements](#)

Promote your Tweet

People

James Hill
@DarBenThu1
Ysrael -civilian, -Ontoan,
iciary: DOI-1776-A.D.,
33-A.D.; Amb. of Yushuah to
n-redeemer/ Ysrael & Trustea
sion-1213-A.D.

Opening

teairing on ABC

ture today!

Messages

2022-011769 MISC Page: 2282 of 2782
09/26/2022 03:35:37 PM Receipt #: 22-9381
Rec Fee: \$30.00 Darrell James Hill
Gila County, R2, Sadie Jo Bingham, Recorder

2022

Tweet Analytics

Darrell James hill @DarBenThu1
 MORE SIMPLER WORDS:
 WHAT ARE MY INTENTIONS, AND
 WHAT YOU WANT DONE? FROM L.
 See: Response to :Sister-L. pic.twitter.com/1mWWadVGVA

Impressions times people saw this Tweet on Twitter	254
Total engagements times people interacted with this Tweet	16

[View all engagements](#)

Promote your Tweet

Tweet

The Emergency Ba
 egol. That EmERGE
 must be REQUES
 coins.

TCSSCPSC mean
 method language fi
 intentions in the fac

1:05 PM • Oct 21, 2021

View tweet activity

Tweet yo

Search Twitter

more today
 min Bloom

This afternoon
 al Just Got
 Wedding Photos

ffer today
 e first city
 join the

States

Privacy Policy · Cookie Policy
 ©2021 Twitter, Inc.

messages

Tuesday November 9, 22:09

2021

2022-011769 MISC Page: 2283 of 2782
 09/26/2022 03:35:37 PM Receipt #: 22-9381
 Rec Fee: \$30.00 Darrell James Hill
 Gila County, Az, Sadie Jo Bingham, Recorder

:Darrell-James: Hill, :Ohioan- beneficiary-Executor-Procurator, -:mitigation of the Trustee-derelict- damages: Twitter: September 24th, 2020, 7:05 p.m. - :March 9, 2021, 3:35 p.m.

Response to :Sister- L.'s,

"The verbiage used is difficult to understand.
Will you restate
what your intentions are
and what you want done in
using simpler words."

Ans. :- man will try, 'might need help in translation from here.
Speaking-form is easy to comprehend in some video, Vimeo/You-Tube, presentation. BUT

The written-form of the complexity of :- man's intentions is the CSSCPG¹-commercial- language-format
in dealing within business and especially with the national government(s) is simply-complex.

Often-times within business the CSSCPG or its derivative-form is the technical -form required. -- Some
statements are pure CSSCPG-form simply because they must be so.

Most people don't know about CSSCPG; :- man didn't create it.- :David-Wynn; Miller advanced it.

what your intentions are?

- 1) to assure that :Donald-John: Trump has been notified of all of the specially-presentments mailed by the big-splash public-spectacle (big-splash) with the rule of 'six-degrees of separation' to 2) before all of the people and you, the witnesses, that:
- 3) :- man want the property- claimed and possessed by :- man restored to :- man, along with
- 5) the deprivation of the private-property- contracts as agreed, which :- man have officially made.
- 6) The restoration of the un-alien-able -rights agreed by the Almighty-God in the Declaration of Independence covenant with God: 'intangible'-property stolen from :- man, which request :- man have officially made.
- 7) The restoration of access to the information of the Emergency Banking Act of 1933- Trust- account of :- man, which request :- man have officially made;
- 8) The restoration of the 'Emergency Banking Act of 1933 A.D.- Trust - Federal Reserve Act of 1913 A.D.'- access for us-ALL periodically-obtaining Federal Reserve Notes (FRNS), which request :- man have made;
- 9) The restoration of the accounting, settle and closure of the Emergency Banking Act of 1933 A.D.- Trust, which request :- man have made; and: that,
- 10) These restorations are made :in -honor by the POTUSA-CIC and Army of: 'The Constitution for the United States of America', et seq:- the Emancipation Proclamation of 1863 A.D. and the Lieber-Code of 1863 A.D., which requests :- man have made.

This all refers to help me stop the theft from :- man and YOURSELVES alike by the Trustees.

- 1) what you want done? :- man want for you to TELL :Donald-John a) stop this upon :- man. And,
- 2) :- man want you to TELL :Donald-John to account, settle and close YOUR dead- Emergency Banking Act of 1933 A.D.- Trust accounts; (What better time than NOW.).

The Emergency Banking Act of 1933 A.D. is a dead legislative trust, defunct in 2003 A.D. ~17 years ago! :That Emergency of 1933 A.D. - U.S.-corp -bankruptcy is over! Restoring the money back!!! must be REQUESTED by you! How much?! Much More than 1350 -0.9999 -gold one-ounce U.S. coins,

Without prejudice, from the desk of: Twitter.com/@DarBenThu1
:Darrell-James: Hill, -Negro-Ysrael, -civilian, -Ohioan;
Ambassador of the Messiah- Yushuah.

¹ CSSCPG means: Complete Sentence Sense Correct Parse Syntax Grammar. CSSCPG is the method-language for use of grammar and syntax logic in a systematic-way for communicating the spoken-intentions in the fact forms that are required to be specific with government, e.g. treaties.

2022-011769 MISC Page: 2284 of 2782

09/26/2022 09:35:37 PM Receipt #: 22-9381
Rec Fee: \$30.00 Darrell James Hill
Gila County, Az, Saddle Jo Bingham, Recorder



:Darrell-James: Hill, :Ohioan- beneficiary-Executor-Procurator, -:mitigation of the Trustee-derelict- damages: Twitter: September 24th, 2020, 7:05 p.m. - :March 9, 2021, 3:35 p.m.

October 25,
2020
3:23 p.m.

Darrell James hill
[@DarBenThu1](#)

Needle in the haystack!! TY AI. professor richard williams, born 1950 A.D. Truth: " They Stole It But You Must Return It" <https://youtube.com/watch?v=uiJVMp70z> A The :root -source -problem of :abject-slavery is the :substance which the wrong- doings imposed upon :Negro-Ysrael heals PTSD -America

2022-0111769 MISC Page: 2285 of 2782
09/26/2022 03:35:37 PM Receipt #: 22-9381
Rec Fee: \$30.00 Darrell James Hill
Gila County, Az, Sadie Jo Bingham, Recorder

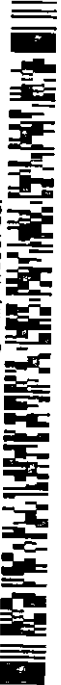

youtube.com
Richard Williams - They Stole It But You Must Return It

Subscribe to Transatlantic Productions Smash The LIKE Button Share

& hit the Notifications Bell Donate so we can complete the upload <https://www.gof...>

October 25,
2020
3:30 p.m.

Darrell James hill
[@DarBenThu1](#)

Neely Fuller Jr How Racism Got Started <https://youtube.com/watch?v=7-4ENR-135A>

We Americans think whatever but 'White genetic survival' is the core-deception controlled by the Black-Nobility. Funny, Ireland, Scotland, etc. are Ysrael. Did you know that? Concession of 1213 A.D. was for Ysrael.

UN
2076

Tweet

The :root -so
:substance w
:Negro-Ysrael



3:23 PM · Oct 25, 2020

View Tweet activity

Tweet yo

Tweet Analytics

Darrell James hill @DarBenThu1
Needle in the haystack!! TY AL professor richard williams, born 1950 A.D. Truth: "They Stole It But You Must Return It" https://www.youtube.com/watch?v=uiJVMp70z_A ...

The :root -source -problem of :abject-slavery is the :substance which the wrong-doings imposed upon :Negro-Ysrael heals PTSD -America

Impressions times people saw this Tweet on Twitter	253
Media views all views (autoplay and click) of your media are counted across videos, vines, gifs, and images	1
Total engagements times people interacted with this Tweet	3

[View all engagements](#)

Search Twitter

n-redeemer/ Ysrael & Trustee
sion-1213-A.D.

pening

ago
tearing on ABC

ture today!
Bloom

iller today
e first city
join the

oming
lance on

messages

2022-011769 MISC Page: 2286 of 2782

09/26/2022 03:35:37 PM Receipt #: 22-9381

Rec Fee: \$30.00 Darrell James Hill

Gila County, Az, Sadie Jo Bingham, Recorder

Not

:Darrell-James: Hill, :Ohioan- beneficiary-Executor-Procurator, -:mitigation of the Trustee-derelict- damages: Twitter: September 24th, 2020, 7:05 p.m. - :March 9, 2021, 3:35 p.m.

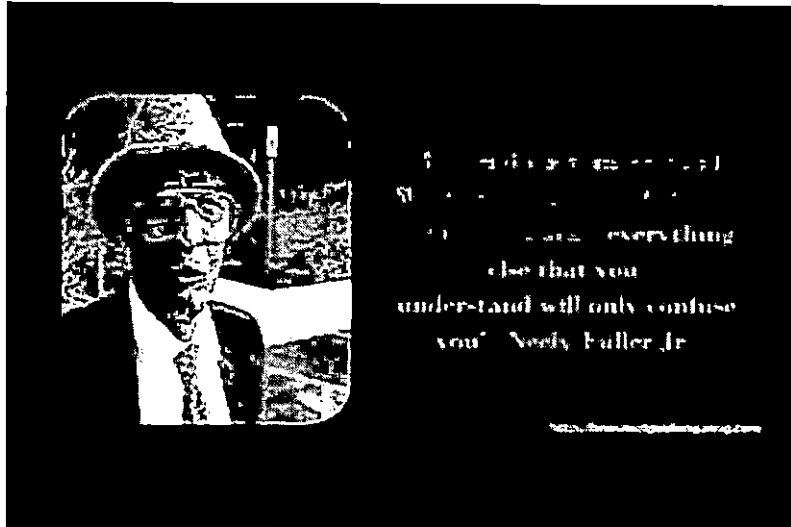

youtube.com
Neely Fuller Jr How Racism Got Started

October 27,
2020
3:43 p.m.

Darrell James hill
[@DarBenThu1](#)

TO:
[@Facebook](#)
c/o :
[@TwitterSupport](#)
[@Policy](#)
[@POTUS](#)
[@realDonaldTrump](#)
[@VP](#)
[@Cabinet](#)
[@WHNSC](#)
[@DarBenThu1](#)
[@TheJusticeDept](#)

Without prejudice. :- man claim the following attached, re: the licensed-corp., - trustees understanding the POTUSA-CIC: Facebook; et al. -:Twitter. Shalom

2022-011769 MISC Page: 2287 of 2782
09/26/2022 03:35:37 PM Receipt #: 22-9381
Rec Fee: \$30.00 Darrell James Hill
Gila County, Az, Sadie Jo Bingham, Recorder

:Executor-Procurator, -:mitigation of the Trustee-derelict- damages ~



2019
~:Executor-Procurement;-mitigation of the Trustee-derelict- damages ~

22 / 206

Confirm Your Identity With Facebook | Facebook https://www.facebook.com/help/contact/183000765122339

How can we help?

Help Center (10/23/21)

- Creating an Account
- Friending
- Your Home Page
- Messaging
- Stories
- Your Photos and Videos
- Pages
- Groups
- Events
- Fundraisers and Donations
- Payments
- Marketing
- Apps
- Facebook Mobile Apps
- Accessibility

Confirm Your Identity With Facebook

Before we can review your account, please fill out the forms below to help us verify your identity.

Please attach a copy of your ID(s). Learn more about why we require ID verification and what types of ID we'll accept below.

Submitting ID

- What types of ID does Facebook accept?
- How do I upload my ID to Facebook?
- Why am I being asked to upload an ID to Facebook?
- What happens to my ID after I send it to Facebook?

Your ID(s)

Saved as JPEGs, if possible. You may attach up to 3 files.

No files selected.
FACEBOOK 1000 1000 1000

We may encrypt and store your ID for up to one year to improve our automated systems for detecting fake IDs. Your ID will be stored securely and will not be visible to anyone on Facebook.

If you don't want Facebook to use your ID to improve our automated systems for detecting fake IDs, you can adjust your Identity Confirmation Settings. If you turn this option off, the copy of your ID will be deleted within 30 days of submission or when you turn this option off.

1 of 2 10/27/20, 2:33 PM

~:Darrell-James: Hill, :Ohioan- beneficiary-Executor-Procurement;-mitigation of the Trustee-derelict- damages: Twitter: September 24th, 2020, 7:05 p.m. - :March 9, 2021, 3:35 p.m.

Neely Fuller Jr
How Racism
youtube.com
We American
'survival' is the
Nobility. Funny
you know that
Ysrael.

3:30 PM - Oct 25, 2022

View Tweet activity

Tweet Analytics

Darrell James hill @DarBenThu1
Neely Fuller Jr
How Racism Got Started
<https://www.youtube.com/watch?v=7-4ENR-135A...>
We Americans think whatever but 'White genetic survival' is the core-deception controlled by the Black-Nobility. Funny, Ireland, Scotland, etc. are Ysrael. Did you know that? Concession of 1213 A.D. was for Ysrael.

Impressions times people saw this Tweet on Twitter	276
Media views all views (autoplay and click) of your media are counted across videos, vines, gifs, and images	1
Total engagements times people interacted with this Tweet	2

[View all engagements](#)

James Hill
antiJude
Ysrael, -civilian, -Ohoan,
iciary DOI-1776-A.D.,
33-A.D.; Amb. of Yushuah to
n-redeemer/Ysrael & trustee
sion-1213-A.D.

opening
SAGE
teating on ABC
in Bala
future today!
in Bloom
States

2022-011769 MISC Page: 2289 of 2782
09/28/2022 09:35:37 PM Receipt #: 22-9981
Rec Fee: \$30.00 Darrell James Hill
Gila County, Az, Sadie Jo Bingham, Recorder

Tweet Analytics

Darrell James Hill @DarBenThu1
 TO: @Facebook c/o : @TwitterSupport @Policy @POTUS @realDonaldTrump @VP @Cabinet @WHNSC @DarBenThu1 @TheJusticeDept Without prejudice. :i- man claim the following attached, re: the licensed-corp., -trustees understanding the POTUSA-CIC: Facebook; et al. :Twitter. Shalom pic.twitter.com/LGcccfnUIU

Impressions	245
times people saw this Tweet on Twitter	
Total engagements	24
times people interacted with this Tweet	

[View all engagements](#)

3:43 PM - Oct 27, 20

View Tweet activity

Tweet your

Support

Follow

opening

te airing on ABC

ture today!

min Bloom

orning

lence on

edy: 'My heart is

Messages

Tuesday November 9, 22:08

2022-011769 MISC Page: 2290 of 2782

09/26/2022 09:36:37 PM Receipt #: 22-9381

Rec Fee: \$30.00 Darrell James Hill

611a County, Az, Sadie Jo Bingham, Recorder

2022-011769

:Darrell-James: Hill, :Ohioan- beneficiary-Executor-Procurator, -:mitigation of the Trustee-derelict- damages: Twitter: September 24th, 2020, 7:05 p.m. - :March 9, 2021, 3:35 p.m.

Re: Acct: blackandbluelivesmatter@gmail.com 2 / 3

Hacked and Fake Accounts ~ https://www.facebook.com/help/1216349518398624?helpref=hc_global_nav

This category does not apply to the :i- man, -Darrell-James: Hill - www.facebook.com/blackandbluelivesmatter@gmail.com .

:This-attempt is made for to strive to be Not marginalized; e.g., see: Community Standards; INTRODUCTION; Every day, Facebook (is) to be a place where people feel empowered to communicate, and we take seriously our role in keeping abuse off our service. That's why we've developed a set of Community Standards that outline what is and is not allowed on Facebook. Our policies are based on feedback from our community and the advice of experts in fields such as technology, public safety and human rights. To ensure that everyone's voice is valued, we take great care to craft policies that are inclusive of different views and beliefs, in particular those of people and communities that might otherwise be overlooked or marginalized. ~ <https://www.facebook.com/communitystandards/> ~

Your option for to 'Confirm Your Identity With Facebook,' et seq.- 'Before we can review your account, please fill out the form below to help us verify your identity. - Please attach a copy of your ID(s). Learn more about why we require ID verification and what types of ID we'll accept below]' has been done as a matter of record, as established above; and , the documents presented to you are the types of information for which your policy is to receive; e.g. - 'Submitting ID; What types of ID does Facebook accept?

We have fewer people available to review IDs because of the coronavirus (COVID-19) pandemic. We're trying hard to prioritize reviews for the most urgent cases. This means we may be unable to review your ID or it may take longer than usual.

If you need to confirm your name on Facebook, or if you've lost access to your account, you may be asked to send us a copy of something with your name on it. You have several different options for this, including photo IDs issued by the government, IDs from non-government organizations, official certificates or licenses that include your name or other physical items like a magazine subscription or a piece of mail.

In some cases, such as authorization for advertisers running ads about social issues, elections or politics, there may be special ID requirements. Learn more in ID Requirements for Ads About Social Issues, Elections or Politics below.

Please only submit the required documents. Submitting more documents than necessary may delay the review process.

You can also learn more about what happens to your ID after you send it to Facebook. .

Don't digitally conceal ID information

To help us prevent fake IDs and other abuses, we don't accept photos that have been digitally modified to hide information.

You can also physically cover any non-essential information on your ID, before you take a photo of the document.

Group One

You can send us one of the items from group one to confirm your name or get back into your account. Anything that you send us should contain either your name and date of birth or your name and photo.

- Birth certificate
- Driver's license
- Passport
- Marriage certificate

Re: Acct: blackandbluelivesmatter@gmail.com 2 / 3

2022-011769 MISC Page: 2291 of 2782
09/28/2022 03:35:37 PM Receipt #: 22-9381
Rec Fee: \$30.00 Darrell James Hill
Cilla County, Rz, Sadie Jo Bingham, Recorder



:Executor-Procurator, -:mitigation of the Trustee-derelict- damages ~

23 / 206

:Darrell-James: Hill, :Ohioan- beneficiary-Executor-Procurator, -:mitigation of the Trustee-derelict- damages: Twitter: September 24th, 2020, 7:05 p.m. - :March 9, 2021, 3:35 p.m.

Re: Acct: blackandbluelivesmatter@gmail.com 1 / 3

RE: blackandbluelivesmatter@gmail.com -Account Is Disabled

:Substantial-information-access has been sent by/ from :- man ~ [Twitter.com/DarBenThu1](https://twitter.com/DarBenThu1) ~ to :you- corp.-service-provider, :-trustee ~ at twitter.com/Facebook ~ concerning :- man -Darrell-James: Hill, -civilian, -Executor-beneficiary, -natural-individual and ;ambassador of the Messiah-Yushuah, in which :- man openly-inferred, and set the presumption, that the demanded-detailed-digital-recording for the Facebook-corp-records is endangering for :- man -beneficiary at this time and until such the time after-when the required -body-security-detail is fully-in-place and active in the protection of :- man, -beneficiary.

:i believe and declare now to :you that this limitation imposed for the safety of :- man the :mortal- man is as the Almighty-God has instructed :- man to do; the :same is indicated in the data-access provided to you in the www.twitter.com/DarBenThu1 account sent to :you.

:Where, as the digital- ID of :- man in unacceptable and not required by the Facebook policy the information-access provided to :you with the general-access -granted to :you, information you required explains that the :digital-rendering is not-required. Moreover,

:Where :-any- 'picture-setting' for the 'www.facebook.com/blackandbluelivesmatter@gmail.com' -account in this matter is obviously incorrect or otherwise ;in error and endangers the :- man-beneficiary then that setting must be changed to be consistent with :- man's highest-level-of-protection and security. However, all attempts to make this setting- change at the blackandbluelivesmatter@gmail.com- account is not possible because the :account has been disabled for no reason given; e.g.,

<p>FACEBOOK ACCOUNT Why was my account disabled? Your account was disabled for violating the Facebook Terms. Our Policies</p> <ul style="list-style-type: none"> • Your account must list your authentic name. • Personal accounts must represent individual people only. It's a violation of our policies to use a personal profile to represent anything other than yourself (ex: celebrities, pets, ideas, objects, etc.). • Impersonating anyone or anything is not allowed. • Maintaining multiple accounts is a violation of our policies. • Accounts created for the purpose of spamming or harassing others are strictly prohibited. <p>Learn More For more information about our policies, please review the Facebook Community Standards. If you think your account was disabled by mistake, please let us know.</p>	
---	--

:This -address is :- man, -Darrell-James: Hill ~ www.facebook.com/blackandbluelivesmatter@gmail.com ~ LETTING YOU KNOW by the only means available since the account has been disabled thereby dis-enabling the :any- picture -requirement-setting to be changed.

Re: Acct: blackandbluelivesmatter@gmail.com 1 / 3

2022-011769 MISC Page: 2292 of 2782
 09/26/2022 03:35:37 PM Receipt #: 22-9381
 Rec Fee: \$30.00 Darrell James Hill
 Gila County, Az, Sadie Jo Bingham, Recorder

2083
 Unofficial

:Executor-Procurator, -:mitigation of the Trustee-derelict- damages ~

:Darrell-James: Hill, :Ohioan- beneficiary-Executor-Procurator, -:mitigation of the Trustee-derelict- damages: Twitter: September 24th, 2020, 7:05 p.m. - :March 9, 2021, 3:35 p.m.

Re: Acct: blackandbluelivesmatter@gmail.com 3 / 3

- Driver's license
- Passport
- Marriage certificate
- Official name change paperwork
- Personal or vehicle insurance card
- Non-driver's government ID (ex: disability, SNAP card, national ID card, pension card)
- Green card, residence permit or immigration papers
- Tribal identification or status card
- Voter ID card
- Family certificate
- Visa
- National age card
- Immigration registration card
- Tax identification card

<https://www.facebook.com/help/contact/183000765122339>.

:This- information has been provided to you-corporate-trustee at: www.twitter.com/facebook.

And, adding to the unreasonable request is that any information is made available for the 'The Facebook Business Tools, e.g., -See: 'Share Article'. The Facebook Business Tools are technologies offered by Facebook Inc. and Facebook Ireland Limited that help website owners and publishers, app developers, and business partners, including advisors and others, integrate with Facebook, understand and measure their products and services, and better reach and serve people who use or might be interested in their products and services. These Business Tools include Facebook Pixel, Conversions PI, Pp Events via Facebook SD, Offline Conversions, and Pp Events PI. We also receive Business Tools data in the form of impression data sent by Facebook Social Plug ins (for example the Like and Share buttons) and Facebook Login, as well as data from certain APIs such as Messenger Customer Match via the Send PI and from certain pilot, test, alpha, or beta programs that we may offer from time to time. Please see the Facebook Business Tools Terms for more information. [HTTP://subcomputation/help/331508497253687](http://subcomputation/help/331508497253687)

The fact is that in this individual case your policy endangers a man, -Darrell-James: Hill, beneficiary for the reasons described in the information made available to you- twitteror/face book from/ by a man- beneficiary -@DarBenThu1 in regards to the subcomputation/indistinguishableness -disabled-account.

Without prejudice,

Darrell-James: Hill, A.P.

October 28th, 2020 A.D.
2100.

:Darrell-James: Hill, -Negro-Yeast- citizen, -Ohioan; -Executor- beneficiary; -Ambassador of the Messiah, Yeshua -; Trustee- Concession-1213-A.D.

Re: Acct: blackandbluelivesmatter@gmail.com 3 / 3

2022-011769 MISC Page: 2293 of 2782
09/26/2022 09:35:37 PM Receipt #: 22-9381
Req Fee: \$30.00 Darrell James Hill
Gila County, Az, Sadie Jo Bingham, Recorder

October 29,
2020
9:31 a.m.

Darrell James hill
[@DarBenThu1](https://twitter.com/DarBenThu1)

2084 :Executor-Procurator, -:mitigation of the Trustee-derelict- damages ~

25 / 206

:Darrell-James: Hill, :Ohioan- beneficiary-Executor-Procurator, -:mitigation of the Trustee-derelict- damages: Twitter: September 24th, 2020, 7:05 p.m. - :March 9, 2021, 3:35 p.m.

#EBA1933AD The EMERGENCY BANKING ACT OF 1933, IS THE LARGEST TRUST-FUND EVER CREATED for the uSofA-people to be surety for the U.S.-corp 1933 'bankruptcy'. See: pdf: https://fraser.stlouisfed.org/files/docs/historical/federal%20reserve%20history/bank_holiday/bank_emerg_pt1_19330225.pdf

November 2, 2020 12:00 a.m.

Darrell James hill
[@DarBenThu1](#)

John I: Concession Of England To The Pope Innocent III, 1213 <https://sourcebooks.fordham.edu/source/john1a.asp>
Magna Carta, 1215 <https://avalon.law.yale.edu/medieval/magframe.asp>
https://en.wikipedia.org/wiki/Magna_Carta#13th_century
'.... The charter was annulled by Pope Innocent III.

[en.wikipedia.org](https://en.wikipedia.org/wiki/Magna_Carta)
[Magna Carta - Wikipedia](https://en.wikipedia.org/wiki/Magna_Carta)

November 2, 2020 12:02 a.m.

Darrell James hill
[@DarBenThu1](#)

American Civil War, 1861-1865 https://en.wikipedia.org/wiki/American_Civil_War
The Preliminary Emancipation Proclamation, 1862 September 22, 1862 https://archives.gov/exhibits/american_originals_iv/sections/transcript_preliminary_emancipation.html <https://avalon.law.yale.edu/medieval/magframe.asp>
Emancipation Proclamation, 1863 January 1, 1863 <https://archives.gov/exhibits/featured-documents/emancipation-proclamation/transcript.html> <https://avalon.law.yale.edu/medieval/magframe.asp>

[archives.gov](https://www.archives.gov)
[Transcript of the Proclamation](https://www.archives.gov/exhibits/featured-documents/emancipation-proclamation/transcript.html)

r-Procurator, -:mitigation of the Trustee-derelict- damages ~

2022-011769 MISC Page: 2294 of 2762
09/26/2022 03:35:37 PM Receipt #: 22-9381
Rec Fee: \$30.00 Darrell James Hill
Gila County, Az, Sadie Jo Bingham, Recorder



206

09/26/2022 03:35:37 PM Receipt #: 22-9381
Rec Fee: \$30.00 Darrell James Hill
Gila County, Az, Sadie Jo Bingham, Recorder



Darrell James Hill on Twitter: #EBA1933AD The EMERGENCY BANKING ACT OF 1933, IS THE LARGEST TRUST-FUND EVER CREATED for the uSofA-people to be surety for the U.S.-corp 1933 'bankruptcy'. See: pdf: https://L.co/6B35bBlgXP /Twitter

File Edit View History Bookmarks Tools Help

All Mail Onkyo receive Apache Junction WunderMap Mt. Inbox (107) Total Prase Darrell James Hill b-1020-intro a-2020-09-20 New Tab

https://twitter.com/DarBenThu1/status/1321836952337874948/analytics 150%

Getting Started EXECUTIVE ORDERS REF COMMERCE DAVID STRAIGHTERS AJ

Tweet

Darrell James Hill
@DarBenThu1

#EBA1933AD The EMERGENCY BANKING ACT OF 1933, IS THE LARGEST TRUST-FUND EVER CREATED for the uSofA-people to be surety for the U.S.-corp 1933 'bankruptcy'. See: pdf: https://fraser.stlouisfed.org/files/docs/historical/federal%20reserve%20history/bank_holiday/bank_emerg_pt1_19330225.pdf ...

8:31 AM · Oct 29, 2020

View tweet activity

Tweet Analytics

Darrell James Hill @DarBenThu1
#EBA1933AD The EMERGENCY BANKING ACT OF 1933, IS THE LARGEST TRUST-FUND EVER CREATED for the uSofA-people to be surety for the U.S.-corp 1933 'bankruptcy'. See: pdf: https://fraser.stlouisfed.org/files/docs/historical/federal%20reserve%20history/bank_holiday/bank_emerg_pt1_19330225.pdf ...

Impressions times people saw this Tweet on Twitter	212
Total engagements times people interacted with this Tweet	3

View all engagements

Promote your Tweet

James Hill
@DarBenThu1

Ysrael - civilian - Ohioan, beneficiary: DOI-1776-A.D., 1933-A.D., Amb. of Yushuah to n-redeemer/ Ysrael & Trustee: sion-1213-A.D.

Opening

ago

te airing on ABC

on Balla

ture today!

min:Beamz

09/26/2022 03:35:37 PM Receipt #: 22-9381
Rec Fee: \$30.00 Darrell James Hill
Gila County, Az, Sadie Jo Bingham, Recorder



Darrell James Hill on Twitter: "John I: Concession Of England To The Pope Innocent III, 1213 https://c.co/ujkmmmmw magna Carta, 1215 https://c.co/KoikPFDIU https://c.co/Zz9ttNYXOI ... The charter was annulled by Pope Innocent III." / Twitter

File Edit View History Bookmarks Tools Help

All Mail - dhill X New Tab Onkyo receiver X Apache Junction X WunderMap X Inbox (107) X Total Praise X Darrell James Hill X b-1020-intro-c X a-2020-09-20 X New Tab X

https://twitter.com/DarBenThu1/status/1323157926488334337/analytics 150%

Getting Started EXECUTIVE ORDERS REF COMMERCE DAVID STRAIGHTERS AJ

Thread

Tweet Analytics

Darrell James Hill @DarBenThu1
John I: Concession Of England To The Pope Innocent III, 1213
<https://sourcebooks.fordham.edu/source/john1a.asp> ...

Magna Carta, 1215
<https://avalon.law.yale.edu/medieval/magframe.asp> ...
https://en.wikipedia.org/wiki/Magna_Carta#13th_century ... '.... The charter was annulled by Pope Innocent III.

Impressions 179
times people saw this Tweet on Twitter

Total engagements 6
times people interacted with this Tweet

[View all engagements](#)

12:00 AM · Nov 2, 2021

View tweet activity

Tweet your photos

messages

Tuesday November 9, 2021

2022

09/26/2022 03:35:37 PM Receipt #: 22-9381

Rec Fee: \$30.00 Darrell James Hill

Gila County, Az, Sadie Jo Bingham, Recorder



Thread

12:02 AM - Nov 2, 2022

View Tweet activity

Tweet Analytics

Darrell James Hill @DarBenThu1
 American Civil War, 1861-1865
[https://en.wikipedia.org/wiki/American_Civil_War ...](https://en.wikipedia.org/wiki/American_Civil_War...)
 The Preliminary Emancipation Proclamation, 1862
 September 22, 1862
[https://www.archives.gov/exhibits/american_originals_iv/sections/transcript_preliminary_emancipation.html ...](https://www.archives.gov/exhibits/american_originals_iv/sections/transcript_preliminary_emancipation.html...)
[https://avalon.law.yale.edu/medieval/magframe.asp ...](https://avalon.law.yale.edu/medieval/magframe.asp...)

Emancipation Proclamation, 1863
 January 1, 1863
[https://www.archives.gov/exhibits/featured-documents/emancipation-proclamation/transcript.html ...](https://www.archives.gov/exhibits/featured-documents/emancipation-proclamation/transcript.html...)
[https://avalon.law.yale.edu/medieval/magframe.asp ...](https://avalon.law.yale.edu/medieval/magframe.asp...)

Impressions 185
 times people saw this Tweet on Twitter

Total engagements 5
 times people interacted with this Tweet

Messages

Tuesday November 9, 22:07

:Darrell-James: Hill, :Ohioan- beneficiary-Executor-Procurator, -:mitigation of the Trustee-derelict- damages: Twitter: September 24th, 2020, 7:05 p.m. - :March 9, 2021, 3:35 p.m.

January 1, 1863 A Transcription By the President of the United States of America: A Proclamation.

**October 20,
2020
3:05 p.m.**

Darrell James hill
@DarBenThu1

#EP1863AD The Emancipation Proclamation was the effective :January 1, 1863 A.D. for the southern states named; that, if the secession wasn't over then their immoral-slave- trade was over by Executive Order under the Emergency Powers of the POTUSA-CIC.

**November 2,
2020
12:10 a.m.**

Darrell James hill
@DarBenThu1

American Revolutionary War, 1775–1783
https://en.wikipedia.org/wiki/American_Revolutionary_War
Declaration of Independence, July 4, 1776
<https://avalon.law.yale.edu/medieval/magframe.asp>

The ARW would-should have been lost Except for the Almighty-God-given 'UN-ALIEN- ABLE RIGHTS' -covenant to all of God's Negro-Ysrael on the land

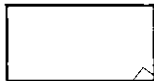

en.wikipedia.org
American Revolutionary War - Wikipedia

**Oct 20, 2020
3:13 p.m.**

Darrell James hill
@DarBenThu1

#DOI1776AD The Declaration of Independence of 1776 A.D. was the underdog-agreement with the Almighty-God with the :United-Colonies for God's UN-ALIEN- ABLE -Rights to supercede the :British- Empire's imperialist-tax or kill policy. And, then the war heated-up: 1775-1783 A.D.

2022-011769 MISC Page: 2298 of 2782
09/26/2022 03:35:37 PM Receipt #: 22-9381
Rec Fee: \$30.00 Darrell James Hill
Gila County, Az, Sadie Jo Bingham, Recorder



:Darrell-James: Hill, :Ohioan- beneficiary-Executor-Procurator, -:mitigation of the Trustee-derelict- damages: Twitter: September 24th, 2020, 7:05 p.m. - :March 9, 2021, 3:35 p.m.

**November 2,
2020
12:19 p.m.**

Darrell James hill
[@DarBenThu1](https://twitter.com/DarBenThu1)

[#PromotingFreeSpeechandReligiousLiberty2017](#) POTUS, -: Donald-John: Trump; Executive Order 13798 of May 4, 2017 Promoting Free Speech and Religious Liberty file:///tmp/mozilla_dj0/2017-09574.pdf US AG, -:Sessions file:///tmp/mozilla_dj0/2017-23269.pdf



FEDERAL REGISTER

The Daily Journal of the United States Government

federalregister.gov

Federal Law Protections for Religious Liberty

This notice provides the text of the Attorney General's Memorandum of October 6, 2017, for all executive departments and agencies entitled "Federal Law Protections for Religious Liberty" and the...

**November 2,
2020
12:36 p.m.**

Darrell James hill
[@DarBenThu1](https://twitter.com/DarBenThu1)

[#TheCftUSofA](#) The Constitution for the United States of America covenant parameters SET between the people and the Almighty-God is the [#DOI1776AD](#). After the war the Trustees ignored the covenant and enslaved :Negro-Ysrael, et seq., :in- dereliction through [#EBA1933AD](#) -Trust-2003

**November 12,
2020
12:51 p.m.**

Darrell James hill
[@DarBenThu1](https://twitter.com/DarBenThu1)

This [@DarBenThu1](https://twitter.com/DarBenThu1) is for remedy against theft by :Donald-John: Trump, -:POTUS-corp, -:Trustee, et al.-. These 'Bill of Particulars' rendered are required for the agreed-upon :penalty-compensation until the stolen property is restored :in- specie. See:

2090

:Executor-Procurator, -:mitigation of the Trustee-derelict- damages: Twitter: September 24th, 2020, 7:05 p.m. - :March 9, 2021, 3:35 p.m.

2022-011769 MISC Page: 2299 of 2782
09/28/2022 03:35:37 PM Receipt #: 22-9381
Rec Fee: \$30.00 Darrell James Hill
Gila County, Az, Sadie Jo Bingham, Recorder





Darrell James Hill on Twitter: "#PromotingFreeSpeechandReligiousLiberty2017 POTUS, -: Donald-John: Trump; Executive Order 13798 of May 4, 2017 Promoting Free Speech and Religious Liberty file:///tmp/mozilla_dj0/2017-09574.pdf US AG, -: Sessions file:///tmp/mozilla_dj0/2017-23269.pdf https://www.federalregister.gov/documents/2017/10/26/2017-23269/federal-law-protections-for-religious-liberty ..."

File Edit View History Bookmarks Tools Help

All Mail - djhill X New Tab X Onkyo receive X Apache Junit X WunderMap X M Inbox (107) X Total Praise - Y X Darrell James Hill X b-1020-intro X 2020-09-20 X New Tab X

https://twitter.com/DarBenThu1/status/1323162898563170305/analytics 150% Q I'll never be more loved

Getting Started EXECUTIVE ORDERS REF COMMERCE DAVID STRAIGHTERS AJ

Thread

#PromotingFreeSpeechandReligiousLiberty2017 POTUS, -: Donald-John: Trump; Executive Order 13798 of May 4, 2017 Promoting Free Speech and Religious Liberty file:///tmp/mozilla_dj0/2017-09574.pdf US AG, -: Sessions file:///tmp/mozilla_dj0/2017-23269.pdf https://www.federalregister.gov/documents/2017/10/26/2017-23269/federal-law-protections-for-religious-liberty ...

Journal of the U.S. Supreme Court

12:19 AM · Nov 2, 2022

View Tweet activity

messages

Twitter

people

James Hill

Yisrael, -civilian, -Ohtoon, -Secretary: DOI-1776-A.D. 33-A.D.; Amb. of Yisrael to n-redeemer/ Yisrael & Trustees: sion-1213-A.D.

pening

Sago

tearing on ABC

ture today!

min Bloom

Twitter Analytics

Darrell James Hill @DarBenThu1

#PromotingFreeSpeechandReligiousLiberty2017

POTUS, -: Donald-John: Trump; Executive Order 13798 of May 4, 2017 Promoting Free Speech and Religious Liberty

file:///tmp/mozilla_dj0/2017-09574.pdf

US AG, -: Sessions

file:///tmp/mozilla_dj0/2017-23269.pdf

https://www.federalregister.gov/documents/2017/10/26/2017-23269/federal-law-protections-for-religious-liberty ...

Impressions 218

times people saw this Tweet on Twitter

Total engagements 2

times people interacted with this Tweet

View all engagements



...the United States of America covenant parameters SET between the people and the Almighty-God is the #DOI1776AD . After the war the Trustees ignored the covenant and enslaved...

File Edit View History Bookmarks Tools Help

All Mail - djhill x New Tab x Onlyo receive x Apache Junct: x WunderMap x M (Inbox (107) - c x Total Praise - y x Darrell James! x b-1020-Intro-1 x a-2020-09-20 x New Tab x

https://twitter.com/DarBenThu1/status/1323167187574480897/analytics 150% i'll never be more loved

Getting Started EXECUTIVE ORDERS REF COMMERCE DAVID STRAIGHTERS AJ

Tweet

Darrell James Hill
@DarBenThu1

#TheCftUSofA
The Constitution for the United States of America covenant parameters SET between the people and the Almighty-God is the #DOI1776AD . After the war the Trustees ignored the covenant and enslaved :Negro-Ysrael, et seq., :in- dereliction through #EBA1933AD -Trust-2003

12:36 AM Nov 2, 2022

View tweet activity

Tweet Analytics

Darrell James Hill @DarBenThu1
#TheCftUSofA
The Constitution for the United States of America covenant parameters SET between the people and the Almighty-God is the #DOI1776AD . After the war the Trustees ignored the covenant and enslaved :Negro-Ysrael, et seq., :in- dereliction through #EBA1933AD -Trust-2003

Impressions	175
times people saw this Tweet on Twitter	
Total engagements	1
times people interacted with this Tweet	

[View all engagements](#)

Promote your Tweet

People

James Hill
@DarBenThu1
Ysrael, -civilian, -Onion, Secretary, DOI-1776-A-D., 1776-1777, Amb. of Yushuah to the United States of America, -redeemer/ Ysrael & Trustees, -1213-A.D.

:Darrell-James: Hill, :Ohioan- beneficiary-Executor-Procurator, -:mitigation of the Trustee-
derelict- damages: Twitter: September 24th, 2020, 7:05 p.m. - :March 9, 2021, 3:35 p.m.

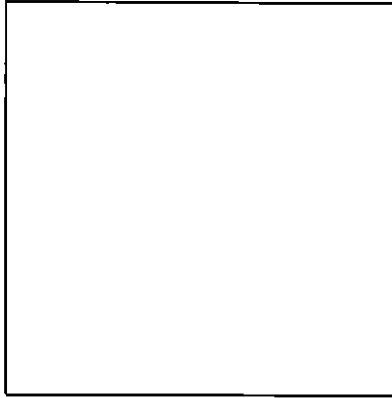

blackandbluesoulsmatter.wordpress.com

Bill of Particulars- Lot 1, 2 and 3 of 3 rendered to :Donald-John: Trump; due
paid now.

Bill of Particulars- Lot 1, 2 and 3 of 3 rendered t

December 13,
2020
3:49 p.m.

Darrell James hill
@DarBenThu1

Replying to
@DarBenThu1
Please see into this for
@DarBenThu1
@AOC
@AndreaSCousins
@francescamari
@ronmknox
@byHeatherLong
@JenniferJJacobs
@perrybaconjr
@DrJasonJohnson
@HexPositive
@ CharlesPreston

December 12,
2020
1:49 a.m.

Darrell James hill
@DarBenThu1

Waking-up is hard to do. Man-kind is oppressed by the heavy and cruel hand in
TheUSofA for to sustain 'white-genetic-survival -- Dr. Welsing ~ [https://twitter.com/
DarBenThu1/status/1312100143219396608](https://twitter.com/DarBenThu1/status/1312100143219396608)
~ Yet, :we- are single-sourced 6,000 year-old progeny by DNA. So, what is white?
Ans: Willie Lynch letter slave.

:Executor-Procurator, -:mitigation of the Trustee-

2022-011769 MISC Page: 2302 of 2782
09/26/2022 03:35:37 PM Receipt #: 22-9381
Rec Fee: \$30.00 Darrell James Hill
Gila County, Az, Sadie Jo Bingham, Recorder



:Darrell-James: Hill, :Ohioan- beneficiary-Executor-Procurator, -:mitigation of the Trustee-
derelict- damages: Twitter: September 24th, 2020, 7:05 p.m. - :March 9, 2021, 3:35 p.m.

Quote Tweet



Darrell James hill
@DarBenThu1

Dr. Frances Cress Welsing - The Psychological Slavery of Black People in The Media <https://youtube.com/watch?v=jrEikj30uY8>
wow

Dec 12, 2020
1:49 a.m.

Darrell James hill
@DarBenThu1

Healing the PTSD can be done. Start here:
<https://psycom.net/depression.central.grief.html>
. :i- man got help with this:For Those Just Now Awakening
<http://annavonreitz.com/justnowawakening.pdf>
. From these and life :i- man wrote this: ... My experience: Grief-Sheet jpg. :i- man
hope this can help you; soul- health matters

2024

:Executor-Procurator, -:mitigation of the Trustee:

2022-011769 MISC Page: 2303 of 2782
09/26/2022 03:35:37 PM Receipt #: 22-9381
Rec Fee: \$30.00 Darrell James Hill
Gila County, Az, Sadie Jo Bingham, Recorder





... on Twitter: Waking-up is hard to do. Man-kind is oppressed by the heavy and cruel hand in TheUSofA for to sustain 'white-genetic-survival -- Dr. Welsing -- https://t.co/1stYfaCQJl -- Yet, we- are single-sourced 6,000 year-old progeny

File Edit View History Bookmarks Tools Help

M: All Mail - djhill X New Tab X Onkyo receive X Apache Jundi X WunderMap X M: Inbox (107) X Total Prize X Darrell James X b-1020-Intro X a-2020-09-20 X New Tab X

https://twitter.com/DarBenThu1/status/1326809272861122560/analytics 150% i'll never be more loved

Getting Started EXECUTIVE ORDERS REF COMMERCE DAVID STRAIGHTERS AJ

Thread

Darrell James

Dr. Frances Cress

Media

youtube.com/wate

wow

1:49 AM · Nov 12, 20

View Tweets

Tweet yo

Darrell Jam

Replying to

Healing the

if man got

this: My experiences

with health matters

Tweet Analytics

Darrell James hill @DarBenThu1

Waking-up is hard to do. Man-kind is oppressed by the heavy and cruel hand in TheUSofA for to sustain 'white-genetic-survival -- Dr. Welsing -- https://twitter.com/DarBenThu1/status/1312100143219396608 ... --'

Yet, we- are single-sourced 6,000 year-old progeny by DNA. So, what is white? Ans: Willie Lynch letter slave.

Impressions	179
times people saw this Tweet on Twitter	
Total engagements	6
times people interacted with this Tweet	

View all engagements

Promote your Tweet

if you want to open this channel for you,

ago

tearing on ABC

ture today!

maison

teamon

f told to report

fies as 'Smurfs'

5 hours ago

ay And Aaron

New Statements

Controversial

ments

ending

messages



Thread

April 1, 2019

2:11 AM · Nov 12, 2021

View Tweet

Tweet your

Messages

Privacy Policy Cookie Policy © 2021 Twitter, Inc.

Tuesday November 9, 22:05

Tweet Analytics

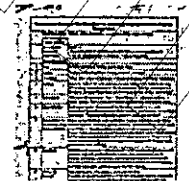

Darrell James Hill @DarBenThu1
 Healing the PTSD can be done. Start here: <https://www.psycom.net/depression.central.grief.html> ...
 i- man got help with this:For Those Just Now Awakening <http://annavonreitz.com/justnowawakening.pdf> From these and life i- man wrote this: ... My experience: Grief-Sheet.jpg. i- man hope this can help you; soul- health matters <pic.twitter.com/wQGTGfaXT6>

Impressions	145
times people saw this Tweet on Twitter	
Total engagements	13
times people interacted with this Tweet	

[View all engagements](#)

:Darrell-James: Hill, :Ohioan- beneficiary-Executor-Procurator, -:mitigation of the Trustee-
 derelict- damages: Twitter: September 24th, 2020, 7:05 p.m. - :March 9, 2021, 3:35 p.m.

From a review of change: "For Those Just Now Awakening" from Ann Von Reitz. Com site.
 My experience:

	Soul Knowledge and Assumptions v truth conflict	Shock, reflex disbelief v. Acceptance of the unknown facts
	Soul Mental-Emotional disturbance	Grief → Bargaining that +/- conditions need to balance new input facts for = for the Establishment of Balance → Soul Alignment
	Soul alignment	
1	Fear	Soulful emotional. Feeling panic, fight-flight
2	Anger	Soulful mental-emotional. Feeling betrayal, wronged.
3	Questions	Who? Why? Ideas of immoral → moral correction, restitution/ vengeance.
4	Testing	Begin to walk in the new, exercise by use; seeing other skills to develop. Developing comprehension of the phenomenon. Voicing contemplation. Research. Seeing other people functioning in the lies of the "fore-fathers".
5	Connection	Talking to ID consensus : Red v. Blue Pill-ers → rejection, sadness → Cour/ testing. Truth of the non-support despite more truth burden-state.
6	Clear Resolve	Soul-Spirit nexus: "Let the truth be the truth, Not the 'I, I, I - ish whatsoever' protective insecurity of the opinion- justifications for the lies I was taught." Seeking truth resolve; just how many lies are there?
7	Perseverance in the despite of the embarrassments	Calm, by the hardwork won maturation: skeletal formation, multi-linear traction in terms, concepts, deceits, systems, success&failures in the scope of problem w/ dispelling false assumptions and presumptions versus deeply taught ignorance, distraction, and onion layers of the disinformation for/by which one perpetuated one's own abuse and losses. Desire to help others and grieving the deleterious ignorance they proudly display, badly oblivious to their suffering.
8	American	Definition of American = that versus #7 → #1 because people are trapped, most are lazy self-gratificationists; i: man: God Almighty's Law, by History, knowledge and wisdom and comprehension am: aware of the state, it's problems, and necessary corrections/ options for the correction, and daily strive unto righteous equity in every regard.
9	History & Strength	Reported history; DNA history: truth sets one free. Freedom by the defragmentation of the mis-education and lies from one's journey restores to the one that loss of competence and strength once lost/consumed by the chaos of the propaganda, deceptions and misdirection. Strength and Learning increase; as the loss of the soulful drains programmed to burden one are eliminated.

406217

April 1, 2019 = An American by sheer naturalization a ward; components of soul & spirit are immature & must be protected by the community, then after by the state law

2097

Show this thread

:Executor-Procurator, -:mitigation of the Trustee-d

2022-011769 MISC Page: 2306 of 2782

09/26/2022 03:35:37 PM Receipt #: 22-9381

Rec Fee: \$30.00 Darrell James Hill

Gila County, Az, Sadie Jo Bingham, Recorder



:Darrell-James: Hill, :Ohioan- beneficiary-Executor-Procurator, -:mitigation of the Trustee-derelict- damages: Twitter: September 24th, 2020, 7:05 p.m. - :March 9, 2021, 3:35 p.m.

November 13,
2020
11:57 p.m.



Darrell James hill
[@DarBenThu1](#)

The BOPs, 'Bills of Particulars' changed. Here is second attempt:
file:///tmp/mozilla_dj0/law-thou-shalt-not-steal.-final-twitter-blackout-2.pdf

Quote Tweet



Darrell James hill
[@DarBenThu1](#)

This [@DarBenThu1](#) is for :remedy against theft by :Donald-John: Trump, -:POTUS-corp, -:Trustee, et al.-. These 'Bill of Particulars' rendered are required for the agreed-upon :penalty-compensation until the stolen property is restored :in- specie. See: <https://blackandbluesoulsmatter.wordpress.com/2020/11/12/bill-of-particulars-lot-1-2-and-3-of-3-rendered-to-donald-john-trump-due-paid-now/>
Show this thread

November 13,
2020
11:57 p.m.

Darrell James hill
[@DarBenThu1](#)

The BOPs, 'Bills of Particulars' changed. Here is second attempt:
file:///tmp/mozilla_dj0/law-thou-shalt-not-steal.-final-twitter-blackout-2.pdf

Quote Tweet



Darrell James hill
[@DarBenThu1](#)

This [@DarBenThu1](#) is for :remedy against theft by :Donald-John: Trump, -:POTUS-corp, -:Trustee, et al.-. These 'Bill of Particulars' rendered are required for the agreed-upon :penalty-compensation until the stolen property is restored :in- specie. See: <https://blackandbluesoulsmatter.wordpress.com/2020/11/12/bill-of-particulars-lot-1-2-and-3-of-3-rendered-to-donald-john-trump-due-paid-now/>

utor-Procurator, -:mitigation of the Trustee-derelict- damages ~

2022-011769 MISC Page: 2307 of 2782
09/26/2022 03:35:37 PM Receipt #: 22-9381
Darrell James Hill, Recorder
Sadie Jo Bingham, Recorder
Galla County, AZ



Browser address bar: <https://twitter.com/DarBenThu1/status/1327505970839265281/analytics>

Browser tabs: All Mail - djhtr, New Tab, Onkyo receive, Apache Jundak, WunderMap, Inbox (107), Total Probe, Darrell James, b-1020-Intro, a-2020-09-20, New Tab

Browser search: I'll never be more loved

Browser bookmarks: Getting Started, EXECUTIVE ORDERS, REF, COMMERCE, DAVID STRAIGHTERS, AJ

← Thread

Show this thread

11:57 PM, Nov 13 2022

View Tweet activity

Tweet your reply

Tweet Analytics

Darrell James Hill @DarBenThu1
 The BOPs, 'Bills of Particulars' changed. Here is second attempt: file:///tmp/mozilla_dj0/law-thou-shalt-not-steal-final-twitter-blackout-2.pdf
<https://twitter.com/DarBenThu1/status/1326794848029040641?s=20>

Impressions	191
times people saw this Tweet on Twitter	
Total engagements	9
times people interacted with this Tweet	

View all engagements

Promote your Tweet

Search Twitter

ago

te airing on ABC

future today!

removed

f told to report

fesas 'Smurfs'

classic

college basketball season

e Champions Classic at

Garden, with Kansas taking

to and Kentucky facing Duke

messages

Navigation icons: Home, Search, Messages, Activity, Profile, etc.

System tray: Tuesday November 9, 22:05

:Darrell-James: Hill, :Ohioan- beneficiary-Executor-Procurator, -:mitigation of the Trustee-derelict- damages: Twitter: September 24th, 2020, 7:05 p.m. - :March 9, 2021, 3:35 p.m.

Show this thread
[11:57 PM · Nov 13, 2020 · Twitter Web App](#)

Darrell James hill
[@DarBenThu1](#)

"Sublimus Dei; On the Enslavement and Evangelization of Indians [and others] Pope Paul III - 1537 . ."...without exception..., are by no means to be deprived of their liberty or the possession of their property... ; nor should they be in any way enslaved"

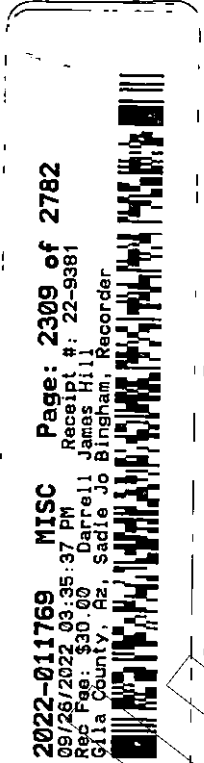

:Darrell-James: Hill, :Ohioan- beneficiary-Executor-Procurator, -:mitigation of the Trustee-derelict- damages: Twitter: September 24th, 2020, 7:05 p.m. - :March 9, 2021, 3:35 p.m.

<https://www.papalencyclicals.net/category/paul03>

Sublimus Dei

On the Enslavement and Evangelization of Indians

Pope Paul III - 1537

Pope Paul III (Topic: the enslavement and evangelization of Indians)
To all faithful Christians to whom this writing may come, health in Christ our Lord and the apostolic benediction.

The sublime God so loved the human race that He created man in such wise that he might participate, not only in the good that other creatures enjoy, but endowed him with capacity to attain to the inaccessible and invisible Supreme Good and behold it face to face; and since man, according to the testimony of the sacred scriptures, has been created to enjoy eternal life and happiness, which none may obtain save through faith in our Lord Jesus Christ, it is necessary that he should possess the nature and faculties enabling him to receive that faith; and that whoever is thus endowed should be capable of receiving that same faith. Nor is it credible that any one should possess so little understanding as to desire the faith and yet be destitute of the most necessary faculty to enable him to receive it. Hence Christ, who is the Truth itself, that has never failed and can never fail, said to the preachers of the faith whom He chose for that office 'Go ye and teach all nations.' He said all, without exception, for all are capable of receiving the doctrines of the faith.

The enemy of the human race, who opposes all good deeds in order to bring men to destruction, beholding and envying this, invented a means never before heard of, by which he might hinder the preaching of God's word of Salvation to the people: he inspired his satellites who, to please him, have not hesitated to publish abroad that the Indians of the West and the South, and other people of whom We have recent knowledge should be treated as dumb brutes created for our service, pretending that they are incapable of receiving the Catholic Faith.

We, who, though unworthy, exercise on earth the power of our Lord and seek with all our might to bring those sheep of His flock who are outside into the fold committed to our charge, consider, however, that the Indians are truly men and that they are not only capable of understanding the Catholic Faith but, according to our information, they desire exceedingly to receive it. Desiring to provide ample remedy for these evils, We define and declare by these Our letters, or by any translation thereof signed by any notary public and sealed with the seal of any ecclesiastical dignitary, to which the same credit shall be given as to the originals, that, notwithstanding whatever may have been or may be said to the contrary, the said Indians and all other people who may later be discovered by Christians, are by no means to be deprived of their liberty or the possession of their property, even though they be outside the faith of Jesus Christ; and that they may and should, freely and legitimately, enjoy their liberty and the possession of their property; nor should they be in any way enslaved; should the contrary happen, it shall be null and have no effect.

By virtue of Our apostolic authority We define and declare by these present letters, or by any translation thereof signed by any notary public and sealed with the seal of any ecclesiastical dignitary, which shall thus command the same obedience as the originals, that the said Indians and other peoples should be converted to the faith of Jesus Christ by preaching the word of God and by the example of good and holy living.

[Dated: May 29, 1537]

This entry was posted in [Pope Paul III \(October 13, 1534 - November 10, 1549\)](#)
<https://www.papalencyclicals.net/category/paul03>
<https://www.papalencyclicals.net/category/paul03> by Pope Paul III. Bookmark the [permalink](#).

For more information about this site.
Last updated February 20, 2020
library, Kindle, Nook, EPUB
© Copyright 2000-2020
Catholic Web Design: Hyperdo Media

2022-011769 MISC Page: 2310 of 2782
09/25/2022 03:35:37 PM Receipt #: 22-9381
Rec Fee: \$30.00 Darrell James Hill
811a County, Rz, Sadie Jo Bingham, Recorder



2101

:Executor-Procurator, -:mitigation of the Trustee-derelict- damages ~

09/26/2022 03:35:37 PM Receipt #: 22-9381

Rec Fee: \$30.00 Darrell James Hill
Gila County, Az, Sadie Jo Bingham, Recorder



Darrell James Hill on Twitter: "Sublimus Dei; On the Enslavement and Evangelization of Indians [and others] Pope Paul III - 1537: "...without exception... are by no means to be deprived of their liberty or the possession of their property...; nor should they be..."

File Edit View History Bookmarks Tools Help

All Mail - djhil X New Tab Onkyo receive X Apache Junct X WunderMap X Inbox (107) - c X Total Prize X Darrell James Hill X b-1020-intro X a-2020-09-20 X New Tab X

https://twitter.com/DarBenThu1/status/1329000676769218562/analytics 150% Q I'll never be more loved

Getting Started EXECUTIVE ORDERS REF COMMERCE DAVID STRAIGHTERS AJ

Tweet

By way of Order
translating the
liberty of
the Indians which
other people should
the example of god

ID: 4 May 29, 15

The way we speak
supposed to people
to prevent the

2:57 AM · Nov 18, 2021

View Tweet activity

Tweet Analytics

Darrell James Hill @DarBenThu1
"Sublimus Dei; On the Enslavement and Evangelization of Indians [and others] Pope Paul III - 1537 .
"...without exception... are by no means to be deprived of their liberty or the possession of their property... ; nor should they be in any way enslaved" pic.twitter.com/kiyP0k4Hx

Impressions	126
times people saw this Tweet on Twitter	
Total engagements	5
times people interacted with this Tweet	

[View all engagements](#)

Search Twitter

temon
f told to report
sas 'Smurfs'

5 hours ago
ey And Aaron
New Statements
Controversial
nments

Privacy Policy Cookie Policy
© 2021 Twitter, Inc.

Messages

:Darrell-James: Hill, :Ohioan- beneficiary-Executor-Procurator, -:mitigation of the Trustee-derelict- damages: Twitter: September 24th, 2020, 7:05 p.m. - :March 9, 2021, 3:35 p.m.

November 18, 2020 4:51 a.m. Darrell James hill
[@DarBenThu1](https://twitter.com/DarBenThu1)

... GOVERNMENT OF ARMIES OF THE [FEDERAL-] UNITED STATES IN THE FIELD: ... by Francis Lieber, ... General Orders No. 100 by President Lincoln, 24 April 1863. Art. 45(b) "Prize money, whether on sea or land, can now only be claimed under local law." :i- man -civilian -Ohioan.

2022-011769 MISC Page: 2312 of 2782
09/26/2022 03:35:37 PM Receipt #: 22-9381
Rec Fes: \$30.00 Darrell James Hill
Gila County, Az. Sadie Jo Bingham, Recorder



:Executor-Procurator, -:mitigation of the Trustee-derelict- damages ~

:Darrell-James: Hill, :Ohioan- beneficiary-Executor-Procurator, -:mitigation of the Trustee-derelict- damages: Twitter: September 24th, 2020, 7:05 p.m. - :March 9, 2021, 3:35 p.m.

General Orders No. 100 : The Lieber Code
https://avalon.law.yale.edu/19th_century/lieber.asp#sec2

INSTRUCTIONS FOR THE GOVERNMENT OF ARMIES OF THE UNITED STATES IN THE FIELD

Prepared by Francis Lieber, promulgated as General Orders No. 100 by President Lincoln, 24 April 1863.

... Art. 16.
Military necessity does not admit of cruelty - that is,.... It does not admit of the use of poison in any way, nor of the wanton devastation of a district. It admits of deception, but disclaims acts of perfidy¹; and, in general, military necessity does not include any act of hostility which makes the return to peace unnecessarily difficult.

... Art. 37.
The United States acknowledge and protect, in hostile countries occupied by them, religion and morality; strictly private property; the persons of the inhabitants, especially those of women; and the sacredness of domestic relations. Offenses to the contrary shall be rigorously punished. This rule does not interfere with the right of the victorious invader to tax the people or their property, to levy forced loans, to billet soldiers, or to appropriate property, especially houses, lands, boats or ships, and churches, for temporary and military uses

Art. 38.
Private property, unless forfeited by crimes or by offenses of the owner, can be seized only by way of military necessity, for the support or other benefit of the army or of the United States. If the owner has not fled, the commanding officer will cause receipts to be given, which may serve the spoliated owner to obtain indemnity.

... Art. 42.
Slavery, complicating and confounding the ideas of property, (that is of a thing,) and of personality, (that is of humanity,) exists according to municipal or local law only. The law of nature and nations has never acknowledged it. The digest of the Roman law enacts the early dictum of the pagan jurist, that "so far as the law of nature is concerned, all men are equal." Fugitives escaping from a country in which they were slaves, villains, or serfs, into another country, have, for centuries past, been held free and acknowledged free by judicial decisions of European countries, even though the municipal law of the country in which the slave had taken refuge acknowledged slavery within its own dominions.

Art. 43.
Therefore, in a war between the United States and a belligerent which admits of slavery, if a person held in bondage by that belligerent be captured by or come as a fugitive under the protection of the military forces of the United States, such person is immediately entitled to the rights and privileges of a freeman. To return such person into slavery would amount to enslaving a free person, and neither the United States nor any officer under their authority can enslave any human being. Moreover, a person so made free by the law of war is under the shield of the law of nations, and the former owner or State can have by the law of positivism no belligerent lien or claim of service.

Art. 44.
All wanton violence committed against persons in the invaded country, all destruction of property not commanded by the authorized officer, all robbery, all pillage or sacking, even after taking a place by main force, all rape, wounding, maiming, or killing of such inhabitants, are prohibited under the penalty of death, or such other severe punishment as may seem adequate for the gravity of the offense. A soldier, officer or private, in the act of committing such violence, and disobeying a superior ordering him to abstain from it, may be lawfully killed on the spot by such superior.

Art. 45.
All captures and booty belong, according to the modern law of war, primarily to the government of the captor.

Prize money, whether on sea or land, can now only be claimed under local law.

Art. 46.
Neither officers nor soldiers are allowed to make use of their position or power in the hostile country for private gain, not even for commercial transactions otherwise legitimate. Offenses to the contrary committed by commissioned officers will be punished with cashiering or such other punishment as the nature of the offense may require; if by soldiers, they shall be punished according to the nature of the offense

....

¹ perfidy means: breach of faith or trust

2022-011769 MISC Page: 2313 of 2782
09/26/2022 03:35:37 PM Receipt #: 22-9381
Darrell James Hill
Rec Fee: \$30.00
Gila County, Az, Sadie Jo Bingham, Recorder

:Executor-Procurator, -:mitigation of the Trustee-derelict- damages ~

Tweet Analytics

Darrell James hill @DarBenThu1
 ... GOVERNMENT OF ARMIES OF THE [FEDERAL-] UNITED STATES IN THE FIELD: ... by Francis Lieber, ... General Orders No. 100 by President Lincoln, 24 April 1863. Art. 45(b) "Prize money, whether on sea or land, can now only be claimed under local law."
 si- man -civilian -Ohioan. pic.twitter.com/ePJ0xJRrQ7

Impressions 230
 times people saw this Tweet on Twitter

Total engagements 6
 times people interacted with this Tweet

[View all engagements](#)

4:51 AM Nov 8, 2022
 View Tweet activity
 1 Quote Tweet

Privacy Policy Cookies Policy © 2022 Twitter, Inc

Tuesday November 9, 22:04

2022-011769 MISC Page: 2314 of 2782
 Receipt #: 22-9881
 09/26/2022 03:35:37 PM
 Rec Fee: \$30.00
 Darrell James Hill
 Recorder
 Az, Saddle No Bingham, Recorder
 Gila County, Az

:Darrell-James: Hill, :Ohioan- beneficiary-Executor-Procurator, -:mitigation of the Trustee-derelict- damages: Twitter: September 24th, 2020, 7:05 p.m. - :March 9, 2021, 3:35 p.m.

No.. 19, 2020 Darrell James hill
4:43 a.m. @DarBenThu1

American state citizens are owed all the protection of the Geneva Convention Protocols of 1949 ~Anna Von Reitz, :Belcher~. Why? Because: 'American state citizens' - 'United States Citizens' are the :legalized- 'enemy' by the TWEA-1917, as amended: See: 1933 Emergency Banking Act.

2022-011769 MISC Page: 2315 of 2782
09/26/2022 03:35:37 PM Receipt # 22-9381
Rep Fee: \$30.00 Darrell James Hill
Gila County, Az. Sadie Jo Bingham, Recorder



:Executor-Procurator, -:mitigation of the Trustee-derelict- damages ~

37 / 206

:Darrell-James: Hill, :Ohioan- beneficiary-Executor-Procurator, -:mitigation of the Trustee-derelict- damages: Twitter: September 24th, 2020, 7:05 p.m. - :March 9, 2021, 3:35 p.m.

I. Trading With The Enemy Act, 1917 A.D., "TWEA-1917-A.D.

<https://www.uscourts.gov/uscourt/courts/tribunals/2019/09/STATUTE-40-Pd-11.pdf>

CHAP. 106.—An Act to define regulations and punish trading with the enemy, and for other purposes.

Be it enacted by the Senate and House of Representatives of the United States of America in Congress assembled, That this Act shall be known as the "Trading with the enemy" Act.
SEC. 2. That the word "enemy," as used herein, shall be deemed to mean, for the purposes of such trading and of this Act:— (1) The government of any nation with which the United States is at war or any political or municipal subdivision thereof, or any officer, official, agent, or agency thereof.

II. Emergency Banking Act of 1933-A.D. amended the TWEA-1917-A.D.

Trading with the enemy Act, 1917, as amended: 1933 to include The USA-people

<https://www.uscourts.gov/uscourt/courts/tribunals/2019/09/STATUTE-40-Pd-11.pdf>
SEC. 2. Subdivision (b) of section 5 of the Act of October 6, 1917 (40 Stat. 1, 411), as amended, is hereby amended to read as follows:

"(b) During time of war or during any other period of national emergency declared by the President, the President may, through any agency that he may designate, or otherwise, investigate, regulate or prohibit, under such rules and regulations as he may prescribe, by means of licenses or otherwise, any transactions in foreign exchange, transfers of credits between or payments by banking institutions as defined by the President, and export, hoarding, melting, or re-marking of gold or silver coin or bullion or currency, by any person within the United States or any place subject to the jurisdiction thereof; and the President may require any person engaged in any transaction referred to in this subdivision to furnish under oath, complete information relative thereto, including the production of any books of account, contracts, letters or other papers, in connection therewith in the custody or control of such person, either before or after such transaction is completed. Whoever willfully violates any of the provisions of this subdivision or of any license, order, rule or regulation issued hereunder, shall, upon conviction, be fined not more than \$10,000, or if a natural person, may be imprisoned for not more than ten years, or both; and any officer, director, or agent of any corporation who knowingly participates in such violation may be punished by a like fine, imprisonment, or both. As used in this subdivision the term "person" means an individual, partnership, association, or corporation."

https://en.wikipedia.org/wiki/Trading_with_the_Enemy_Act_of_1917

Enemy: the United States Citizens
 Franklin D. Roosevelt used the Trading with the Enemy Act to shut financial institutions and declare a "bank holiday" to prevent runs on the banks during the Great Depression in 1933. ... In 1982 the United States Treasury Department announced the termination of the Presidential Proclamations and executive orders for the emergency relating to the 1933 Great Depression ending all domestically oriented Trading with the Enemy Act related programs (BUT MAINTAINED people's 'enemy' status-presumption, -non-benefit.)

The three (3) "United States"

	1	2	3
Sovereign:	People Royals	Britannic Royalty, et al.	Rome: Trustee: Concession-1213-A.D.
Name:	"The United States of America"	"United States of America"	"UNITED STATES"
Leader:	PFTUSA - Pres. For The	POTUSA - President Of The	POTUS
Citizens:	'American state citizens'	'United States Citizens'	'UNITED STATES CITIZENS'
Republic:	Constitutional Republic	Democracy	Democratic Oligarchy
Laws:	Holy Bible; DOI-1776-A.D.; The Constitution for the United States of America -1787-A.D.	the "Constitution of the United States of America"- 1863 A.D.; et al.'	the "UNITED STATES CONSTITUTION" - 1933- A.D.; et al.
Presumptions of Law:	1) Common: Law w/, Equity, w/ Admiralty	1) Common 2) Commercial	1) Commercial 2) Common discouraged

Page: 2316 of 2782

MISC 2022-011769

09/26/2022 03:35:37 PM
 Rec/Fee: \$30.00
 Darrell James Hill
 Sedie Jo Bingham, Recorder
 Gila County, AZ



:Executor-Procurator, -:mitigation of the Trustee-derelict- damages ~



Convention Protocols of 1949 - Anna Von Reitz, Belcher - Why? Because: 'American state citizens' - 'United States Citizens' are the legalized 'enemy' b...

File Edit View History Bookmarks Tools Help

All Mail <@hill> X New Tab X Onkyo receiv X Apache Junct X WunderMap@ X Inbox (107) X Total Praise X Darrell James I X b-1020-intro X a-2020-09:20 X New Tab X

https://twitter.com/DarBenThu1/status/1329382658070044672/analytics 150% i'll never be more loved

Getting Started EXECUTIVE ORDERS REF COMMERCE DAVID STRAIGHTERS AJ

Tweet

#

4:14 AM - Nov 19, 2021

View Tweet activity

Tweet you

Tweet Analytics

Darrell James hill @DarBenThu1
 American state citizens are owed all the protection of the Geneva Convention Protocols of 1949 -Anna Von Reitz, :Belcher-. Why? Because: 'American state citizens' - 'United States Citizens' are the :legalized- 'enemy' by the TWEA-1917, as amended: See: 1933 Emergency Banking Act. pic.twitter.com/ultioMMt1U

Impressions times people saw this Tweet on Twitter	105
Total engagements times people interacted with this Tweet	8

View all engagements

Promote your Tweet

Timeline

told to report fees as 'Smurfs'

5 hours ago

ey And Aaron New Statements Controversial mments

[Privacy Policy](#) [Cookie Policy](#)

© 2021 Twitter, Inc.

Messages

Tuesday November 9, 22:04

:Darrell-James: Hill, :Ohioan- beneficiary-Executor-Procurator, -:mitigation of the Trustee-derelict- damages: Twitter: September 24th, 2020, 7:05 p.m. - :March 9, 2021, 3:35 p.m.

"American state citizens are owed all the protection of the Geneva Convention Protocols of 1949.

Article 3 of those Conventions makes it a capital crime (death penalty) to change the citizenship status of an American State Citizen to that of United States Citizen, but the perpetrators of the vast fraud scheme have nonetheless contrived to do this via "redefinition" of living people and their property assets as "ESTATES" -that is, corporate entities, which fall within the international jurisdiction of the sea, and which can be snatched at will." You Know Something Is WRONG When... Anna Von Reitz :Bekker: 2014 A.D. : p.50.

<https://www.krcr.com/doc/assets/files/publications/krcr-002-0123.pdf>
GENEVA CONVENTION RELATIVE TO THE TREATMENT OF PRISONERS OF WAR OF 12 AUGUST 1949; ratified by :UNITED- STATES-corp, June 9, 1955; ~protocol III ratified~.

CHAPTER I
 General Provisions

Article 1

The High Contracting Parties undertake to respect and to ensure respect for the present Convention in all circumstances. ...

Article 3

In the case of armed conflict not of an international character occurring in the territory of one of the High Contracting Parties, each Party to the conflict shall be bound to apply, as a minimum, the following provisions:

1) Persons taking no active part in the hostilities... shall in all circumstances be treated humanely, without any adverse distinction founded on race, colour, religion or faith, sex, birth or wealth, or any other similar criteria.

The three (3) 'United States'

	1	2	3
Sovereign:	People Royals	Britannic Royalty, et al.	Rome: Trustee: Concession-1213-A.D.
Name:	"The United States of America"	"United States of America"	"UNITED STATES"
Leader:	PFTUSA -Pres. For The	POTUSA -President Of The	POTUS
Citizens:	'American state citizens'	'United States Citizens'	'UNITED STATES CITIZENS'
Republic:	Constitutional Republic	Democracy	Democratic Oligarchy
Laws:	Holy Bible; DOI-1776-A.D.; The Constitution for the United States of America -1787-A.D.	the 'Constitution of the United States of America' - 1863 A.D.; et al.'	the 'UNITED STATES CONSTITUTION' - 1933- A.D.; et al.
Presumptions of Law:	1) Common: Law w/, Equity, w/ Admiralty	1) Common 2) Commercial	1) Commercial 2) Common discouraged

2022-011769 MISC Page: 2318 of 2782
 09/26/2022 03:35:37 PM Receipt #: 22-9381
 Rec Fee: \$30.00 Darrell James Hill
 Gilla County, Az, Sadie Jo Bingham, Recorder

November 20, 2020
 1:42 p.m.
 Darrell James Hill
 @DarBenThu1

The Emancipation Proclamation of 1863 is active today with re: to the 2016- 2017- property claimed and possessed by :i- man, not abandoned.- 5.17.4.1. -Pillage. DEPARTMENT OF DEFENSE LAW OF WAR MANUAL Description of Changes Promulgated on May 31, 2016
https://dod.defense.gov/Portals/1/Documents/law_war_manual15.pdf

:Executor-Procurator, -:mitigation of the Trustee-derelict- damages ~

39 / 206

:Darrell-James: Hill, :Ohioan- beneficiary-Executor-Procurator, -:mitigation of the Trustee-derelict- damages: Twitter: September 24th, 2020, 7:05 p.m. - :March 9, 2021, 3:35 p.m.

DEPARTMENT OF DEFENSE LAW OF WAR MANUAL
Description of Changes Promulgated on May 31, 2016
https://dod.defense.gov/Portals/1/Documents/law_war_manual15.pdf

DEPARTMENT OF DEFENSE LAW OF WAR MANUAL
Description of Changes Promulgated on May 31, 2016
https://dod.defense.gov/Portals/1/Documents/law_war_manual15.pdf

INTRO:

This manual has many distinguished antecedents that have provided important guidance to the U.S. Armed Forces. For example, General Order No. 100, the instructions for the Government of Armies of the United States in the Field, commonly known as the Lieber Code, ... President Abraham Lincoln during the Civil War in 1863. ... This manual is an institutional publication and reflects the views of the Department of Defense ... by the DoD Law of War Working Group, which is chaired by a representative of the DoD General Counsel and includes representatives of the Judge Advocates General of the Army, Navy, and Air Force; ... Commandant of the Marine Corps; the offices of the General Counsels of the Military Departments; and the Legal Counsel to the Chairman of the Joint Chiefs of Staff. This manual has been reviewed by principals of these offices... do not necessarily reflect the views of those Departments or the U.S. Government as a whole.

[p. 327]

5.17 SEIZURE AND DESTRUCTION OF ENEMY PROPERTY

Outside the context of attacks, certain rules apply to the seizure and destruction of enemy property:

- Enemy property may not be seized or destroyed unless imperatively demanded by the necessities of war;
- Public movable property and certain types of private movable property may customarily be captured as war booty;
- Enemy private movable property that is not susceptible of direct military use may be appropriated only to the extent that such taking is permissible in occupied areas;
- Pillage is prohibited; and
- Feasible precautions should be taken to mitigate the burden on civilians, but there is no obligation to compensate the owners of enemy property that is lawfully damaged.

During occupation, other rules relating to the treatment of enemy property apply.

5.17.1 Definition of Enemy Property. All property located in enemy territory is regarded as enemy property regardless of its ownership.

5.17.2 Enemy Property - Military Necessity Standard. Enemy property may not be seized or destroyed unless imperatively demanded by the necessities of war ... In particular, devastation or destruction may not be pursued as an end in itself. ... The measure of permissible seizure or destruction of enemy property is found in the strict necessities of war. ... There must be some reasonable connection between the seizure or destruction of the enemy property and the overcoming of enemy forces. ...

Extensive destruction and appropriation of property protected by the GC, not justified by military necessity and carried out unlawfully and wantonly, constitutes a grave breach of the GC. ...

5.17.3 Enemy Movable Property on the Battlefield (War Booty). Any enemy public movable property on the battlefield may be seized. ... Property is public if it belongs to the enemy State or an agency of that State. ...

5.17.3.1 Private Military Property Not Susceptible to Direct Military Use.

Private enemy property that is not susceptible to direct military use (e.g., arms, ammunition, military papers, or military equipment) may be appropriated only to the extent such taking is permissible in occupied areas. ... In particular, receipts should be given and compensation paid, when feasible. ...

2022-011769 MISC Page: 2319 of 2782
09/26/2022 03:35:37 PM Receipt #: 22-9981
Rec Fee: \$30.00 Darrell James Hill
Gila County, Az, Sadie Jo Bingham, Recorder



:Executor-Procurator, -:mitigation of the Trustee-derelict- damages ~



File Edit View History Bookmarks Tools Help

https://twitter.com/DarBenThu1/status/1329887907088220160/analytics

Getting Started EXECUTIVE ORDERS REF COMMERCE DAVID STRAIGHTERS AJ

Tweet

4:42 PM Nov 20, 2021

View Tweet activity

Tweet Analytics

Darrell James hill @DarBenThu1

The Emancipation Proclamation of 1863 is active today with re: to the 2016- 2017- property claimed and possessed by :- man, not abandoned.- 5.17.4.1. -Pillage.

DEPARTMENT OF DEFENSE LAW OF WAR MANUAL
Description of Changes Promulgated on May 31, 2016
https://dod.defense.gov/Portals/1/Documents/law_war_manual15.pdf ... <https://twitter.com/DarBenThu1/status/1329029446536347649> ... <pic.twitter.com/kynHQR0le>

Impressions	102
times people saw this Tweet on Twitter	
Total engagements	13
times people interacted with this Tweet	

View all engagements

Tuesday November 9, 22:04

:Darrell-James: Hill, :Ohioan- beneficiary-Executor-Procurator, -:mitigation of the Trustee-derelict- damages: Twitter: September 24th, 2020, 7:05 p.m. - :March 9, 2021, 3:35 p.m.

DEPARTMENT OF DEFENSE LAW OF WAR MANUAL
Description of Changes Promulgated on May 31, 2016
https://dod.defense.gov/Portals/1/Documents/law_war_manual15.pdf

5.17.3.2 Ownership of Captured or Found Property on the Battlefield. All enemy property that is captured or found on the battlefield becomes the property of the capturing State. ... During international armed conflict, personal property recovered from enemy dead becomes the property of the capturing State for the purpose of returning it to the next-of-kin of the deceased. ... The individual military member or person accompanying the armed forces who captures or finds enemy property acquires no title or claim. ...

Failure to turn over such property to the proper authorities, or disposal of such property for personal profit, is punishable under Article 103 of the Uniform Code of Military Justice.¹

5.17.4 Pillage Prohibited. Pillage is prohibited, both in general ... and specifically with respect to:

- ...
- persons in occupied territory ... and in areas of non-international armed conflict;
- ...

In certain cases, there is an affirmative obligation to prohibit and prevent pillage. ...

5.17.4.1 Pillage - Definition and Notes on Terminology.

Pillage is the taking of private or public movable property (including enemy military equipment) for private or personal turn over to the proper authority without delay. He does not acquire any proprietary interest. His taking possession of it is done as an agent of the Government, and if it is not reclaimed by the owner who abandoned it, it belongs to the Government.²....

5.17.5.1 Compensation for Property Seizure or Damage. Although reasonable efforts should be made to spare civilians from unnecessary harm when seizing or destroying enemy property, the law of war imposes no obligation to compensate for loss of, or damage to, private property imperatively demanded by the necessities of war, including damage incidental to combat operations. ...

However, if time allows, a record of the use or damage should be kept, or given to the owner, so that in the event of funds being provided by either belligerent at the close of hostilities to compensate the owners, there may be evidence to assist the assessors. ...

As a matter of practice, during counter-insurgency operations, U.S. forces have often made payments to, or taken other actions on behalf of, civilians suffering loss.³ ...

¹ See 10 U.S.C. § 9034^(b) All persons subject to this chapter shall secure all public property taken from the enemy for the service of the United States, and shall give notice and turn over to the proper authority without delay all captured or abandoned property in their possession, custody, or control. (b) Any person subject to this chapter who—(1) fails to carry out the duties prescribed in subsection (a); (2) buys, sells, trades, or in any way deals in or disposes of captured or abandoned property, whereby he receives or expects any profit, benefit, or advantage to himself or another directly or indirectly connected with himself; or (3) engages in looting or pillaging; shall be punished as a court-martial may direct.”

² For example, DEPARTMENT OF THE ARMY FIELD MANUAL 3-24.2, Tactics in Counterinsurgency, 17-69 (Apr.2009) (“Recent experiences have shown the effectiveness of using money to win popular support and further the interests and goals of units conducting counterinsurgency operations. ... A counterinsurgency force can use money to ... • Repair damage resulting from combined and coalition operations. • Provide condolence payments to civilians for casualties from combined and coalition operations.”).

Quote Tweet



Darrell James hill

2022-01-17 69 MISC Page: 2321 of 2762

09/26/2022 03:35:37 PM

Receipt #: 22-9381

Rec Fee: \$30.00

Darrell James Hill

Gila County, Az, Sadia Jo Birmingham, Recorder



:Executor-Procurator, -:mitigation of the Trustee-derelict- damages ~

:Darrell-James: Hill, :Ohioan- beneficiary-Executor-Procurator, -:mitigation of the Trustee-derelict- damages: Twitter: September 24th, 2020, 7:05 p.m. - :March 9, 2021, 3:35 p.m.

@DarBenThu1

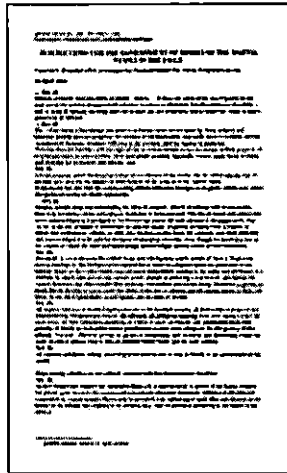

... GOVERNMENT OF ARMIES OF THE [FEDERAL-] UNITED STATES IN THE FIELD: ... by Francis Lieber, ... General Orders No. 100 by President Lincoln, 24 April 1863. Art. 45(b) "Prize money, whether on sea or land, can now only be claimed under local law." :i- man -civilian -Ohioan.

November 20, 2020
5:22 p.m.

Darrell James hill
[@DarBenThu1](#)

For the Three (3) Constitutions with the Transition incidents. Apply more.

:Executor-Procurator, -:mitigation of the Trustee-derelict- damages ~

42 / 206

2022-0111769 MISC Page: 2322 of 2762

09/26/2022 03:35:37 PM Receipt #: 22-9381

Rec Fee: \$30.00 Darrell James Hill
Gila County, AZ, Sadie Jo Birmingham, Recorder





Tweet

Tweet Analytics

Darrell James hill @DarBenThu1
 For the Three (3) Constitutions with the Transition incidents. Apply more. [pic.twitter.com/yJVPZTqLsG](https://t.co/yJVPZTqLsG)

5:22 PM · Nov 26, 2021

View Tweet activity

Impressions 92
 times people saw this Tweet on Twitter

Total engagements 8
 times people interacted with this Tweet

[View all engagements](#)

Promote your Tweet

Messages

Tuesday November 9, 2021 9:22:03

:Darrell-James: Hill, :Ohioan- beneficiary-Executor-Procurator, -:mitigation of the Trustee-derelict- damages: Twitter: September 24th, 2020, 7:05 p.m. - :March 9, 2021, 3:35 p.m.

The Three (3) Constitutions 1 / 2					
	1	What Transaction Happened in Transition?	2	What Transaction Happened in Transition?	3
Sovereign:	<p>People Royals; each owner-individuals: spirit, soul and body; inhabitants born or inhabit the geography of the Creator's Nature and Nature's God; Beneficiaries: Concession-1213-A.D., as expressed about the Magna Carta-1215-A.D., and the then prevailing Britanic Royalty, et al-dereliction</p>	<p>a) In 1861, Congress met and tactically disbanded the government by resigning and abandoning Congress-government -, with</p> <p>b) impending war-actions from unlawful civil-warred for secession in violation of the Confederation and under obligation</p> <p>3) from The Constitution for the united States of America-people who are guaranteed the republic form of government.</p> <p>POTUSA, Lincoln</p> <p>1) Freed the slaves: January 1, 1863 A.D.</p> <p>2) Set-up Licker Code= April 24, 1863 A.D.</p> <p>3) April 25, 1863 A.D., bankrupted The UnionA (not corp.) government; and,</p> <p>4) Lincoln: set up an idiosyncratic corporation for government services, the United States of America, Inc.</p> <p>5) Federal district overlays system started</p>	<p>Britanic Royalty*, et al- Temple Crown in Chancery*</p> <p>*Britanic Royalty is a "big-deal" with many intelligent participants, and the ancients, missing think-tank: literally ahead by centuries.</p> <p>*POTUSA Lincoln was another member of the B.A.R., who was assassinated, V.P.: Andrew Johnson.</p> <p>*See: the "13* Amendment to the Constitution of the United States of America" - POTUSA Andrew Johnson - prohibits members of the B.A.R. in government.</p>	<p>The American Civil-War: Hegelian-dialectic, massive borrowing, worse than the COVID-19, et al. virus, with infrastructure total destruction, PTSD freed-slaves, Bankruptcy before the borrower.</p> <p>National bankruptcy in 70 year long, So, 1863 + 70 years = 1933 A.D. + 70 years = 2013 A.D. (Just sayin!)</p> <p>Debt-ratio: Under payment demand-obligations.</p> <p>Federal Reserve Act 1913, (with 20 years no changes rule - 1933 A.D. ...)</p> <p>Engineered Market Crash?</p> <p>Plan: The New Deal; Emergency Banking Act of 1933 A.D.</p> <p>1) take of the money; give certificates of ownership</p> <p>2) create FICs</p> <p>3) license everybody</p> <p>4) all presumed to be corp.</p>	<p>Rome: Trustee-Derelict: Concession-1213-A.D.- 2019-A.D.</p>

2022-011769 MISC Page: 2324 of 2782
 09/26/2022 03:35:37 PM Receipt #: 22-9381
 Darrell James Hill
 Recorder
 Gila County, Az, Sadie Jo Birnham

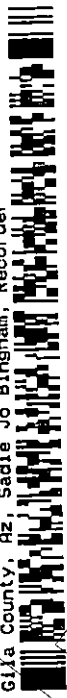

:Executor-Procurator, -:mitigation of the Trustee-derelict- damages ~

:Darrell-James: Hill, :Ohioan- beneficiary-Executor-Procurator, -:mitigation of the Trustee-derelict- damages: Twitter: September 24th, 2020, 7:05 p.m. - :March 9, 2021, 3:35 p.m.

	1	What Transaction Happened in Transition?	2	What Transaction Happened in Transition?	3
The Three (3) Constitutions 1/2					
				citizens under commercial law	
Name:	"The United States of America" (not incorporated)		"United States of America, Inc."		"UNITED STATES"
Rel. to People	Authorized citizenry agency	POUSA set-up another Gov. Service Agency in Fall-spring, 1863 (add: 70 years + 1933 A.D. - just saying)	Government subcontractor under the protectorate of the Army of the United States of America, under the organic Constitution.		
Gov. Svc. Leader:	PPTUSA - Pres. For The		POUSA - President Of The		PTUSA
Citizens:	"American state citizens"		"United States Citizens"		"UNITED STATES CITIZENS"
Republic:	Constitutional Republic		Democracy		Democratic Oligarchy
Laws:	Holy Bible, DOI-1776-A.D.; The Constitution for the United States of America -1787-A.D.		the "Constitution of the United States of America" - 1863 A.D.; et al. "Corporation charter Under the Lieber Code of The United States of America.		the "UNITED STATES CONSTITUTION" - 1933-A.D.; et al. Corporation charter Under the Lieber Code of The United States of America.
Presumption of Law:	1) Common Law w/ Equity, w/ Admiralty		1) Common 2) Commercial		1) Commercial 2) Common discouraged

November 23, 2020
8:26 p.m.

Darrell James hill
@DarBenThu1
De-mo-crat-Re-pub-lic-an-...'UNITED-STATES-CORP'-private-:gov.-service-provider-;EBA-1933-2003-A.D.-Dry-Legislative-Trustee is derelict with the souless- 'commercial'-public(-private)-policy over public-law. See: Authorization: 'Establish Lawful Government': man- money and laws

:Executor-Procurator, -:mitigation of the Trustee-derelict- damages ~

44 / 206

2022-011769 MISC Page: 2325 of 2782

09/26/2022 03:35:37 PM Receipt #: 22-9381
Rec Fee: \$30.00 Darrell James Hill
Gila County, Az, Sadie Jo Bingham, Recorder



:Darrell-James: Hill, :Ohioan- beneficiary-Executor-Procurator, -:mitigation of the Trustee-derelict- damages: Twitter: September 24th, 2020, 7:05 p.m. - :March 9, 2021, 3:35 p.m.

:Sovereign :Darrell-James: Hill, :-Negro-Yisrael, :-civilian, :-Ohioan, :-Executor, :-Kinsman-redemptor PO Box 3808, Apache Junction, Arizona 85117 173

To: Donald-John: Trump, :-POTUSA-CIC, :-POTUSCorp, :-Trustee, :-PFTUSA-CIC, President for the United States of America- 1787 A.D., not incorporated- William-Peterson: Barr, :-Common Law Trustee,

:General James-Charles: McCoville, Army, et al. :-Trustees c/o General -COS Army- Trustee :USPS CMN 7012 2210 0300 4269 7553 9999 Joint Staff Pentagon Washington, District of Columbia 20310-9999 .

:Stephen-G.: Breyer, et al. :-Trustee Justice c/o Scott-Session: Harris- Trustee :USPS CMN 7012 2210 0300 4269 7300 Supreme Court of the United States 1 First Street, NE Washington, District of Columbia 20543 . and

:Mark: Lamb, et al. :-Shontz, Gila county, Ariz. state c/o Mark Lamb, :-Trustee :USPS CMN 7012 2210 0300 4269 7877 971 N Jason Lopez Circle Building C PO Box 887 Florence, Arizona state 06102 .

c/o Donald-John: Trump :USPS RAN RB 022 907 620 US 1600 Pennsylvania Ave NW Washington, District of Columbia 20500

:Sovereign- Authorization to Establish :Lawful -Government: :Kinsman-redemptor- 'Declaration of Independence of 1776 A.D.' -Sovereign- Authorization for the Present/Restoration of: 1) Common Law, 2) Lawful Money, and 3) 'The Constitution for the United States of America' for the United States of America- people- beneficiaries

Greetings Donald-John, et al. William-Peterson, James-Charles, McCoville, et al. , Scott-Session: Harris, et al. justices, Mark: Lamb, et al. RTCC;

:Affairs: Soul -Sovereign -Kinsman-redemptor of Negro-Yisrael, Yisrael, and the Holy-Church (I must name) Darrell-James: Hill on the Earth-Ohioan-born-man-child- sovereign with the Almighty-God- given, unalienable-rights of man -where Nothing exists between the Almighty-God and 3- man- [-children of the non-political -aggregate-] - a) :Son of Negro-Yisrael, son of Clarence, son of James, ... son of Shem, son of Noah... non of Adam', son of God; b) :Ohioan, -Executor- beneficiary to the EPA-1900-A.D., -Legislative- Dry- Trust; c) :Kinsman-redemptor for

- 1 :POTUSA means: President, The United States of America, Inc. -1900- Presumption: Common Law
- 2 :CIC: :-Trustee means: man -trustee under the duty, obligation and moral-Dom of Office 207 day of January the year our Lord 2016 A.D. - , merely as President of 'The United States of America' -unincorporated, 1787 A.D. with the :General Order 100 -Lieber Code- 24th day April, the year of our Lord 1863 A.D. under the Declaration of Independence for the United States of America -people by 'The Constitution for the United States of America' . Accountable to the EPA-1900-A.D. for 3- man
- 3 :POTUS-Corp means: President of The UNITED STATES corp', Trustee EPA-1900-2003 A.D . Legislative-Trust-Dry-Trust. Presumption: commercial law policy, common-law is discouraged
- 4 :Trustee means: the maintenance of the principal, and the active distributor of the benefit to the beneficiary of the proceeds of the Trust- instrument and litigation in accordance with the prevailing agreement.
- 5 :PFTUSA-CIC means: President for the United States of America, not incorporated, akin to the Emancipation Proclamation and Lieber Code-1863 -day, to assure the republic form of government to the people by my government serves people serving the American state citizens and citizens
- 6 :Earth-Ohioan-born-man-child- sovereign means: beneficiary of the Concession of 1783 A.D., et seq. Declaration of Independence of 1776 A.D., et seq
- 7 born- sovereign-status :-Ohio-state with the Almighty-God- given, unalienable-rights of the man, -civilian, of the non-political -aggregate-] means: the 6- Principle, -common-law man
- 8 :Son of Negro-Yisrael-Father -Clarence, son of James, ... son of Shem, son of Noah... son of Adam means: born man-kind Adam, Progeny of Abraham, Isaac and Jacob/Yisrael, House of Judah.
- 9 :EPA-1900-A.D., -Dry, -Legislative- Trust means: Emergency-Banking-Act of 1933 to 2009-2019 which is defunct, and must be dissolved of the mere request of ALL beneficiary upon the Trustee

Page: 2326 of 2782
Receipt #: 22-9381
09/26/2022 03:35:37 PM
MISC
Darrell James Hill
Rec Fee: \$30.00
Gila County, Az, Sadie Jo Bingham, Recorder



:Executor-Procurator, -:mitigation of the Trustee-derelict- damages ~

:Darrell-James: Hill, :Ohioan- beneficiary-Executor-Procurator, -:mitigation of the Trustee-derelict- damages: Twitter: September 24th, 2020, 7:05 p.m. - :March 9, 2021, 3:35 p.m.

:Sovereign :Darrell-James: Hill, -:Negro-Yisrael, -:civilian, -:Ohioan, -:Executor,
:Kinsman-redeemer P.O. Box 3806, Apache Junction, Arizona, 85117 3/3

Providence:

At no time in recent years has the option or man-power presented the nation with this opportunity to affirm and break all of the bonds that devour our resources and equander our freedoms in our elections and our republic for profit.

Wealth and Greed and Misogyny :No the people do not need another civil war to again benefit the wealthy-greedy-misogynist- profiteers that inhabit our pasts and drink our baby's blood. Rather, we need the full-accounting in the Truth of the Truth, the whole truth, and Nothing but the truth from the Concession of 1213 A.D., at seq.- Declaration of Independence of 1776 A.D. by the power of :Nature and Nature's -God on the footing of that covenanter :in -spirit and :in -truth.

:I- man affirm that the aforesaid is the true and correct demand upon the property-claim, and will state same in the open court.

Without prej

Darrell-James Hill, Executor
:Darrell-James: Hill, -:Negro-Yisrael, -:civilian,
:Ohioan- beneficiary- Executor, Ambassador
of the Messiah-Yushuah

Affirmed and autographed before me this 25 day, November 2020 A.D.
Type of Identification: Arizona Driver License

Charles Smith
Notary Public

SEAL



2022-011769 MISC Page: 2327 of 2782
09/26/2022 03:35:37 PM Receipt # 22-9381
Rec Fee: \$30.00 Darrell James Hill
Gila County, Az, Sadie Jo Bingham, Recorder

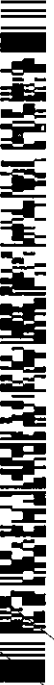

:Executor-Procurator, -:mitigation of the Trustee-derelict- damages ~

:Darrell-James: Hill, :Ohioan- beneficiary-Executor-Procurotor, -:mitigation of the Trustee-derelict- damages: Twitter: September 24th, 2020, 7:05 p.m. - :March 9, 2021, 3:35 p.m.

:Sovereign :Darrell-James: Hill, -:Negro-Yisrael, -civilian, -Ohioan, -Executor;
-Kinsman-redemptor P.O. Box 3866, Apache Junction, Arizona 85117 2/3

the :Negro-Yisrael, Yisrael, and the Holy-Church, of al- similarly-chained shobfards on the lands of the united States of America,

Authorization to Establish Lawful Government

For that Here-before in the history has been the open embossance by the UNITED STATES-CORP -governance- services- provider illuminously -sparely implemented against the people-beneficiaries of the national-trust by the UNITED STATES-CORP-governance- services- provider with the policy to steal the every election now-after by any and every corrupt means; this is the ultimate prospect forged-upon the people-sovereigns of the United States of America determined by their essence of same.

These actions by the firing -UNITED STATES-CORP are noticed by All of the people and, in fact, the entire world has witnessed the wanton abuse in the occupation of the American-size citizens by enemy water-doings. For example, the continued policy of abuse upon the Negro of Judah Yisrael, onto the enslavement of all- people under the EBA-1833-A.D. Negative-dry trust, to now the full-force insidery by the UNITED STATES-CORP leadership- despotic for its own purposes, with the abandonment of the fiduciary duty and obligations to the defense of the rights and wife of the people- sovereigns of the united States of America.

AFFIRMED: I-man- Executor-beneficiary- sole, and, as Kinsman-redemptor, according to the Almighty-God, -covenant in the Declaration of Independence of 1776 A.D., declare that the service-provider :UNITED STATES-CORP- DERELICT is demonstratively unfit to maintain the minimum righteous- standard necessary for the trust by the American-state-citizens.

Whereas, as the election processes under the UNITED STATES-CORP, of al- franchises, and fictitious entities- system has demonstrated itself desecrate to honor the sanctity of the fair election-process with dishonesty for nearly three years with the 'Munster-investigation'; and, has proven itself, et al- franchises, desecrate to conduct fair elections for the people of The united States of America, and to prefer the law, and:

Whereas; Donald-John- Trump is the President for The United States of America- incorporated, 'POTUSA'- 1787; as well as the President of the United States of America -incorporated-, 1863; as well as the President of the UNITED STATES-CORP of 1833, as created; 2016 A.D., and:

Whereas, as the POTUSA-CIC is the only possible oversight at this time for the based-system- failure the by UNITED STATES-CORP-apparatus, I-man -Darrell-James: Hill, sovereign- Executor- beneficiary to the Concepcion of 1213 A.D., et seq.- Declaration of Independence, et seq., and the Kinsman-redemptor for the unalienable-rights of the American-state-citizen and create sovereigns in their right for the guaranteed republican-form- of- government, ...

I-man -sole/and, as Kinsman-redemptor, demand and command that:

- 1) The sitting-President, mya- Trustee of The united States of America, :Donald-John- Trump, must now act without restraint to assure to protect the election-process this day forward, November 23, 2020 A.D. at this signing, until:
- 2) the settle and closure of the EBA-1833-A.D. -property-claimed and possessed by I-man -Darrell-James: Hill, sole, and as the Kinsman-redemptor of the people of the 'united States of America'; and,
- 3) thereafter establish the 'common-law' and demand the 'letter of law'; and,
- 4) thereafter establish money with currency (redeemable to money and demand the fiat currency- system); and,
- 5) thereafter establish the 'Declaration of Independence of 1776 A.D., et seq.- The Constitution for the United States of America of 1787 A.D.' restored in the full-truth and disclosure.

This signing-exact is complex obligation to meet, but is your accepted DUTY as the POTUSA-CIC, POTUSA-CIC

The POTUSA-CIC with the POTUSA-CIC and the Army, et al., are the obligate to our Declaration of Independence of 1776 A.D., et seq.- The Constitution for the United States of America, 1787 A.D., EP- 1863-A.D. -demand. Where, as the 'UNITED STATES-CORP'- firing- Trustee; EBA-1833-A.D. is antithetical is now harm.

The POTUSA-CIC must may-only be a civilian non-B.A.R.- member qualified under The Constitution for the United States of America, 1787 A.D. until the 13th Amendment. Thereof: the administration of the nation-trust to the present embossment cannot ever again be distributed away to the lawyer -B.A.R.- members nor other foreign governments, etc.- corporation(s).

:Donald-John: I-man now appoint you to achieve this high and lofty goal.
:You-man can do this.

Page: 2328 of 2782

MISC

2022-011769

09/26/2022 03:35:37 PM
Rec Fee: \$30.00
Gila County, Az.

James Hill
Darrell James Hill
Sadie Jo Bingham, Recorder



:Darrell-James: Hill, :Ohioan- beneficiary-Executor-Procurator, -:mitigation of the Trustee-derelict- damages: Twitter: September 24th, 2020, 7:05 p.m. - :March 9, 2021, 3:35 p.m.

UNITED STATES POSTAL SERVICE

APACHE JUNCTION
151 W SUPERSTITION BLVD
APACHE JUNCTION, AZ 85120-3998
(602)275-8177

11/23/2020 02:53 PM

Product	Qty	Unit Price	Price
First-Class Mail®	1		\$0.55
Letter			
Washington, DC 20500			
Weight: 0 lb 0.80 oz			
Estimated Delivery Date			
Sat 11/28/2020			
Registered Mail®			\$13.20
Amount: \$21.00			
Tracking #:			
PS22387620LS			
Return Receipt			\$2.05
Tracking #:			
9590 9402 4718 8344 9800 55	X		
Total			\$16.60
First-Class Mail®	1		\$0.55
Letter			
Washington, DC 20543			
Weight: 0 lb 0.50 oz			
Estimated Delivery Date			
Sat 11/28/2020			
Certified Mail®			\$3.55
Tracking #:			
70122210000042697960	X		
Total			\$4.10
First-Class Mail®	1		\$0.55
Letter			
Flint, AZ 85122			
Weight: 0 lb 0.68 oz			
Estimated Delivery Date			
Fri 11/27/2020			
Certified Mail®			\$3.55
Tracking #:			
70122210000042697977	X		
Total			\$4.10
First-Class Mail®	1		\$0.55
Letter			
Washington, DC 20018			
Weight: 0 lb 0.60 oz			
Estimated Delivery Date			
Sat 11/28/2020			
Certified Mail®			\$3.55
Tracking #:			
70122210000042697953	X		
Total			\$4.10
Grand Total:			\$28.50
Cash:			\$30.00
Cash:			\$30.00
Change:			-\$71.50

Postage & Fees: \$16.60
Registered Mail Fee: \$13.20
Return Receipt Fee: \$2.05
Certified Mail Fee: \$3.55

NOV 23 2020

OFFICIAL USE

To: Darrell James Hill
PO Box 3806
Apache Junction, Arizona
85117

Donald J. James - Trustee
1601 Pennsylvania Ave NW
Washington, District of Columbia
20050

PS Form 3806, Registered Mail Receipt
Date: 11/23/2020
Quantity: 1

2022-011769 MISC Page: 2329 of 2762
09/26/2022 09:35:37 PM Receipt #: 22-9381
Rec Fee: \$30.00 Darrell Hill
Gila County, Az, Sadie Jo Bingham, Recorder



8:26 PM · Nov 23, 2020 · Twitter Web App

January 15, 2020 Darrell James hill @DarBenThu1

:Darrell-James: Hill, :Ohioan- beneficiary-Executor-Procurator, -:mitigation of the Trustee-derelict- damages: Twitter: September 24th, 2020, 7:05 p.m. - :March 9, 2021, 3:35 p.m.

6:15 p.m. Abraham Lincoln the 16th PFTUSA on Monday, March 4, 1861, at East Portico - United States Capitol Washington, Dist of Columbia. Donald-John, you are the PFTUSA until March 4, 1861 A.D. for a reason. Please not make that si- man must suit for remedy!

6:15 PM · Jan 15, 2021 · Twitter Web App

December 6, 2020 Darrell James hill @DarBenThu1

12:38 p.m. Will you stand in the gap too?; KJV: Isaiah 58; Ephesians 6? It starts here: <https://twitter.com/DarBenThu1> . Your future is now.

Quote Tweet



Haymarket Books

@haymarketbooks

Abolitionist John Brown was executed by the state of Virginia on December 2, 1859. Show this thread

2022-011769 MISC Page: 2330 of 2782
09/26/2022 03:35:37 PM Receipt #: 22-9381
Rec Fee: \$30.00 Darrell James Hill
Gila County, Az, Sadie Jo Bingham, Recorder



:Darrell-James: Hill, :Ohioan- beneficiary-Executor-Procurator, -:mitigation of the Trustee-derelict- damages: Twitter: September 24th, 2020, 7:05 p.m. - :March 9, 2021, 3:35 p.m.

2022-011769 MISC Page: 2331 of 2782
09/26/2022 03:35:37 PM Receipt #: 22-9981
Rec Fee: \$30.00 Darrell James Hill
Gila County, Az, Sadie Jo Bingham, Recorder

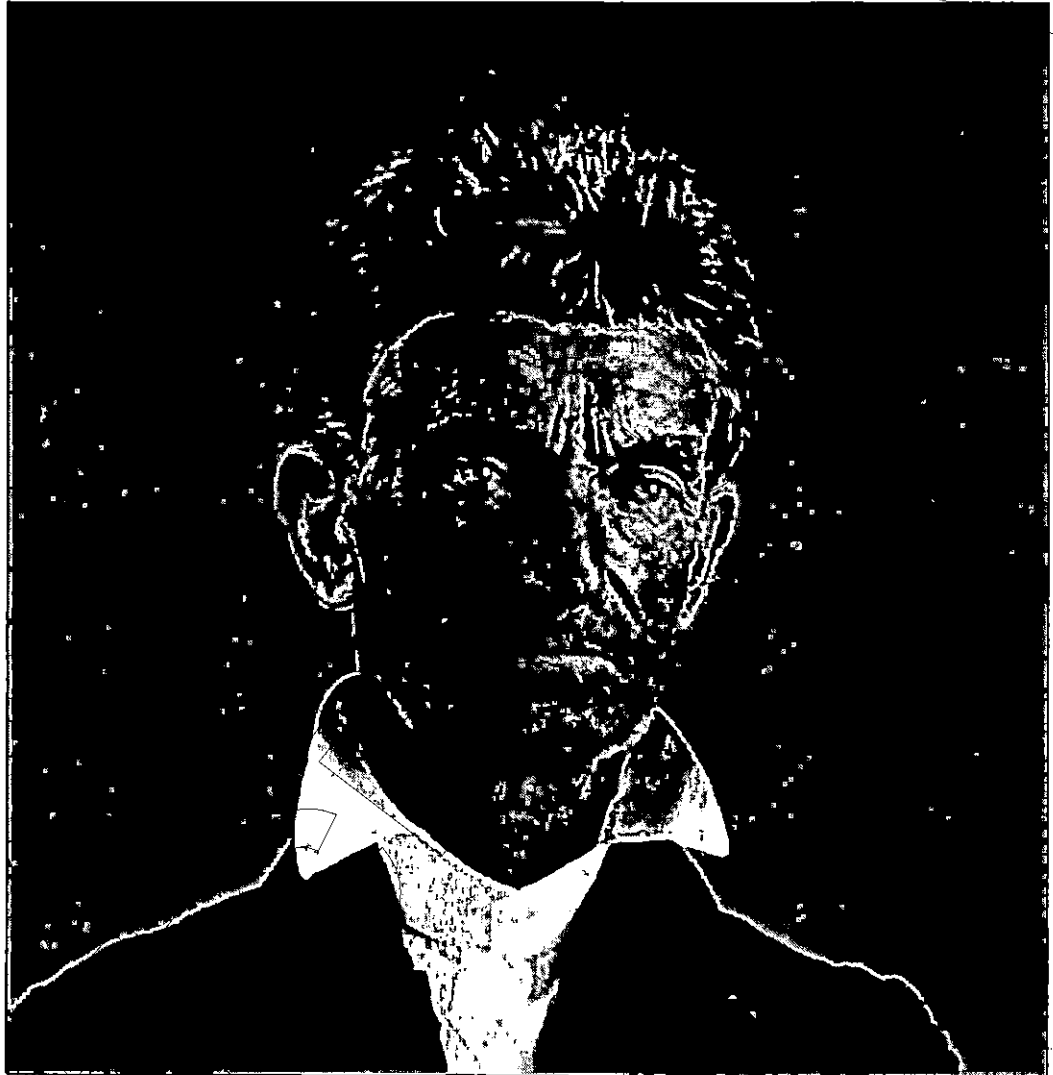

12:38 PM · Dec 6, 2020 · Twitter Web App

December 11,
2020
11:23 p.m.



Darrell James hill
[@DarBenThu1](#)

:RIGHT OF :CONUSANCE ~USPS RMN RE 322 387 616 US...[:] :DEMAND:
Authorization for the Restoration of the Lawful-Government. This is done as the
'kinsman-redeemer': Is. 58, et al. --

2/22

:Executor-Procurator, -:mitigation of the Trustee-derelict- damages ~

Tweet

Tweet Analytics

Darrell James hill @DarBenThu1
Will you stand in the gap too?; KJV: Isaiah 58; Ephesians 6?
It starts here: https://twitter.com/DarBenThu1 . Your future is now. https://twitter.com/haymarketbooks/status/1334195113694814209 ...

Impressions	112
times people saw this Tweet on Twitter	
Total engagements	2
times people interacted with this Tweet	

[View all engagements](#)

Promote your Tweet

messages

Tuesday November 9, 22:03



Tweet Analytics

Darrell James hill @DarBenThu1
 "RIGHT OF :CONUSANCE -USPS RMN RE 322 387 616 US...[:]
 :DEMAND: Authorization for the Restoration of the Lawful Government. This is done as the 'kinsman-redeemer': Is. 58, et al.
 --
<https://blackandbluesoulsmatter.wordpress.com/2020/12/12/right-of-conusance-usps-rmn-re-322-387-616-us-demand-authorization-for-the-restoration-of-the-lawful-government-this-is-done-as-the-kinsman-redeemer-is-58-et-al/> ... <https://twitter.com/DarBenThu1/status/1331076820402357022> pic.twitter.com/Co7v02eLDP

<https://blackandbluesoulsmatter.wordpress.com/2020/12/12/right-of-conusance-usps-rmn-re-322-387-616-us-demand-authorization-for-the-restoration-of-the-lawful-government-this-is-done-as-the-kinsman-redeemer-is-58-et-al/>

Impressions	117
times people saw this Tweet on Twitter	
Total engagements	12
times people interacted with this Tweet	

[View all engagements](#)

6:23 PM · Dec 11, 2021

View Tweet activity

Twitter

Privacy Policy Cookie Policy © 2021 Twitter, Inc.

Tuesday November 9, 22:01



:Darrell-James: Hill, :Ohioan- beneficiary-Executor-Procurator, -:mitigation of the Trustee-derelict- damages: Twitter: September 24th, 2020, 7:05 p.m. - :March 9, 2021, 3:35 p.m.

<https://blackandbluesoulsmatter.wordpress.com/2020/12/12/right-of-conusance-usps-rmn-re-322-387-616-us-demand-authorization-for-the-restoration-of-the-lawful-government-this-is-done-as-the-kinsman-redeemer-is-58-et-al/>

RE: No. 220186 ; Title: Texas, v. Pennsylvania, et al. 1 / 6

:Darrell-James: Hill, -Negro, -civilian, -Ohioan, -Executor -beneficiary;
:Kinsman-redeemer: Negro-Yusef, :Yusef and :Holy-Church of the :Almighty-God².
:Ambassador of :Messiah-Yushuah for :Health and :Wholeness;
:Trustee: Concession-1213-A D.¹
PO Box 3606
Apache Junction, Arizona 85117
:
:Torah-KJV :Book :Isaiah :Chap 58, et al.; :man, -present.

Arizona state
Pinal county
:
:Stephen-G: Breyer, et al.; Trustee Justices
c/o Scott-Sessions; Harris- Trustee
Supreme Court of the United States
1 First Street, NE
Washington, District of Columbia 20543

:RIGHT OF CONUSANCE -USPS-RMN RE 322 387 616 US- For the united States of America-state- :civilians and citizens, holders in due course, over-standing the Declaration of Independence- 1776 A.D., et seq., The Constitution for the United States of America-1787 A.D., et seq., The Emancipation Proclamation- 1863 A.D. with the claim of the right-hereto now-exercised for the Restoration of the common-law government and monetary- system now-due status-post the Emergency Banking Act- 1933-A.D., "EBA-1933-A.D."- 2003 A.D., Legislative Dry-Trust:

:DEMAND: Authorization for the Restoration of the Lawful-Government*
:Right and Demand for the Extinction of the Proxy - "UNITED-STATES-Corp"- government- Trustee-Derelict: EBA-1933 A.D., -Dry- Legislative-Trust by the Accounting, Settle, and Closure of same With Reser and Restoration to "The Constitution for the United States of America" with Lawful- money in the Guaranteed-Obligation for the Republican-form of :government

:Affiant to :Conusance; i- man, -Darrel-James: Hill, :Executor-beneficiary of the wherent trust from :Almighty-God, -where nothing stands between the :Almighty-God and i- man-;
:Executor- beneficiary in the Concession-1213-A.D., :Declaration of Independence-1776-A D., et seq., the Constitution for the united States of America- 1787, et seq., -Emancipation-

- 1 :beneficiary means: of the inherent:Almighty-God, given -Trust, :Concession-1213-A.D., et seq., -Declaration of Independence-1776-A.D., et seq., -EBA-1933-A.D., et al. See:
- 2 :kinsman-redeemer means: Title; :Receiver-redeemer for :Zesty-right. See:
- 3 :Trustee: Concession-1213 A.D. means: ambassador of the Messiah-Yushuah in the office. See:
- 4 :Authorization for the Restoration of the Lawful-Government means: "U.S." call Agents; See: :Statement of Opposition to Establish Lawful-Government, Kinsman-redeemer, Declaration of Independence of 1776 A.D., :Sovereign-Authorization for the Proper-Restoration of: 1) Common Law, 2) Lawful Money, and 3) The Constitution for the United States of America for the United States of America; people, beneficiaries
- 5 :Donald-John: Trump, -FOIUSA-CIC, -FOTUSCorp- Trustee, -PETUSA-CIC, :President for the united States of America- 1787 A.D., not-incorporated-
William-Brian: East, -Common Law- Trustee,
c/o :Donald-John: Trump USPS RMN RE 322 387 620 US,
1050 Pennsylvania Ave NW Washington, District of Columbia 20007 .
:General-James-Charles: MacCorville, Army, et al., -Trustees
c/o General - COS-Army- Trustee USPS CMN 7912 2210 0000 4209 7353 ;
:Stephen-G: Breyer, et al., -Trustee Justices
c/o Scott-Sessions; Harris- Trustee USPS CMN 7912 2210 0000 4209 7360 ;
:Mark: Lamb, et al., -Sheriff, Gila County, AZ- Ship
c/o :Mark: Lamb, -Trustee USPS CMN 7912 2210 0000 4209 7377

Darrel-James Hill -Negro, -civilian, -Ohioan, -Executor -beneficiary, kinsman-redeemer Negro-Yusef, Yusef and the Holy-Church of the Almighty-God, Yushuah-James- the Messiah, ambassador for the Messiah Yushuah, Trustee Concession-1213 A.D USPS RMN RE 322 387 616 US 1 / 6

Page: 2334 of 2782

MISC
09/25/2022 03:35:37 PM
Receipt #: 22-9381

Darrell James Hill
Sadle Jo Bingham, Recorder



:Executor-Procurator, -:mitigation of the Trustee-derelict- damages ~

51 / 206

:Darrell-James: Hill, :Ohioan- beneficiary-Executor-Procurator, -:mitigation of the Trustee-derelict- damages: Twitter: September 24th, 2020, 7:05 p.m. - :March 9, 2021, 3:35 p.m.

RE: No. 220185 ; Title: Texas, v. Pennsylvania, et al. 3 / 6

Where, as nullification-rights are Not transferable or surrenderable; and:

Where, as upon the solemn-Oath by the swearing or affirmative that the statement is true and correct that none, -servant of the people will be bound to the covenant: -Declaration of Independence, at seq - 'The Constitution for the United States of America' at seq., explicitly invites punishment if that commitment is untrue or the covenant is broken; and;

Where, as the all evidence reports verify that the UNITED-STATES-Corp, et seq - Trustee-Derelict: EBA-1933-A.D. -Legislative-Dry-Trust is broken; and

Where, as the evidence- reports verify that the UNITED-STATES-Corp, et seq - Trustee-Derelict: EBA-1033-A.D. -Legislative-Dry-Trust is exact; and

Whereas, by the sovereign-people -authority, :- man, sole, and as the kinman-redemptor- uncontented, operates under the common-law obligation by the Declaration of Independence- 1776 A.D.; - Thereby,

:The -common-law -remedy exercises to allow the rights of, by and for the United-States-of-America- people-beneficiaries over-standing; in this demand to the obligor -man-poor-present, :- Donald-John- Trump, in the authority of the office of the President of The United States of America face the united- States-of-America - people to: a) terminate the UNITED-STATES-Corp., -Trustee-derelict: EBA-1933-A.D., and b) to restore to the people the lawful-government with lawful money, with under the common-law- presumption, with under the Declaration of Independence, -1776 A.D. -righteous- authority over- ords: The-Constitution for the United States of America', -1787 A.D., of 999 -Emancipation Proclamation-1863 A.D., et al -Liber-Code- 1863 A.D., post haste, is now required, absolutely -guaranteed and completely now-ordained demanded -herewith.

cc:

Ken Paxton
Council of Record
Attorney General of Texas
P.O. Box 12548 (JAC 068)
Austin, TX 78711-2548
ken.paxton@ag.texas.gov
512-806-1414
Party name: State of Texas

John Bentley CoLore
Council of Record
Attorney General's Office
Pennsylvania Office of Attorney General
Appellate Litigation Section
15th Floor, Strawberry Square
Harrisburg, PA 17120
jcolore@attorneygeneral.gov
717-763-3228
Party name: Commonwealth of Pennsylvania

Andrew Alan Pinson
Council of Record
Office of the Georgia Attorney General
40 Capital Square SW
Atlanta, GA 30334-1300
apinson@ag.ga.gov
404-458-3409
Party name: State of Georgia

Donald W. MacPherson
Council of Record

Darrell James Hill - Negro, -Chican, -Chican, -Executor -beneficiary, Kinman-redemptor, Negro-Yeast, -Yeast and the Holy-Church unto the Almighty-God, Trustee-Jesus-the Messiah, ambassador for the Messiah-Yeshua, Thereby -Concession-1213 A.D. UCPS RJAN RE 222 297 010 US 3 / 6

Thomas Charles Bellava
Council of Record
Wisconsin Department of Justice
17 W. Main Street
PO Box 7857
Madison, WI 53707-7857
tblava@doj.state.wis.gov
6083337518
Party name: State of Wisconsin

Fedoa A. Hammond
Council of Record
Michigan Department of Attorney General
P.O. Box 30212
Lansing, MI 48900
HammondF1@Michigan.gov
517-335-7028
Party name: State of Michigan

Charles R. Gerow
Council of Record
4725 Charles Road
Mechanicsburg, PA 17055
Cgerow@quebecmccomm.com
717-877-8104
Party name: Members of the Pennsylvania General Assembly

D. John Sauer
Council of Record
Office of the Attorney General
Supreme Court Building,

2022-011769 MISC
09/26/2022 03:35:37 PM
Rec Fee: \$30.00
Gila County, Az; Sadie Jo Bingham, Recorder

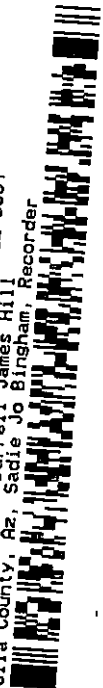

2126
UNOFFICIAL

:Executor-Procurator, -:mitigation of the Trustee-derelict- damages ~

:Darrell-James: Hill, :Ohioan- beneficiary-Executor-services-Procurement, -:mitigation of the Trustee-derelict- damages: Twitter: September 24th, 2020, 7:05 p.m. - :March 9, 2021, 3:35 p.m.

RE: No. 220155 ; Titled: Texas, v. Pennsylvania, et al. 2 / 5

Proclamation-1863-A.D. and EBA-1863-A.D., sole, and as :kinsman-redemptor.

:Obligors -to :Consensus; The 'U.S.' :as Agents', elected and/or appointed of the 'UNITED STATES Corporation', -government-services-provider, -:Trustee: EBA-1863-A.D., -Legislative-Dry-Trust; and: the de-pure man: Donald-John: Trump, -:PFTUSA-1787 A.D., -:POTUSA-1863 A.D., -:POTUS-1933 A.D., et al - SCOTUS under the covenant. Thank-you, in advance.

:Cause -for :Harm: Gross Usurpation: Violation of the Right to the Fair, -Accurate -Election Process: For the UNITED STATES, -2020 A.D.- general-election with the establishment of the factus-habitus of the 'UNITED-STATES- corp -government- services-provider, -:Trustee: EBA-1863-A.D. to proactively assure and ensure the -efficient and accurate -election -service to the beneficiary- united-States-of-America- people since the mid-1880's against the thieving-conspiring-technology and -espionage-therewith- and other-methods-, was the required-duty and obligation set in the covenant by 'The Constitution for the United States of America' for to preserve the :sanctity for the covenant-people- beneficiaries' elections is now fully in the -violation necessitating the chose-relinquishment of the UNITED STATES-Corporate -government -services- provider, -:Trustee-Derelict: EBA-1863-A.D. for the commonly-known -violation of this thieving- technology- and other-methods- with the great harm to The united States of America-people by the at-will -espionage-technology with impunity -usurpation of the unalienable- rights of the entire -civilian-voter-body.

Where, as the UNITED STATES-corp., -:Trustee: EBA-1863-A.D., et al, presume all people are UNITED STATES -citizens by the -media-appearances that the service-organization openly presumes no-obligation to fulfill the :covenant, guarantee to the people for the :republican-form of government; and:

Where, as the UNITED STATES-corp., -:Trustee: EBA-1863-A.D., et al, oath, duty and obligation as the servant-government-service- provider was to first-know and protect the fundamental rights and freedom ensured upon the united :States-of-America- people; and:

Where, as the UNITED STATES-corp., -:Trustee: EBA-1863-A.D., et al, must-needed to safeguard the united-States-of-America- people from the any :systematic, -politically-organized, -social-pressure and force of the B.A.R., -legal- system in the first; and:

Where, as the moral-principles and :divine-justice produced the :Declaration-of-Independence- 1776-A.D.- natural-rights- inalienable and absolutely-guaranteed; and:

Where, as the natural rights exist independently of any government-services- provider, the unalienable rights to life, liberty and property-claimed and possessed remain unalienable-rights, and.

Where, as the natural man-rights and freedoms are not created by the any government- services-provider(s) is cognizable and recognized by the every government-services-provider, and.

5 'U.S.' :and Agents: See, -Sovereign- Authorization to Establish Lawful Government, Kinsman-redemptor -Declaration of Independence of 1776 A.D.' -Sovereign-Authorization to the President -Restoration of, 1) Common Law, 2) Lawful Money, and 3) The Constitution for the United States of America for the United States of America- people- beneficiaries :Donald John: Trump, -:POTUSA-CIC, -:POTUScorp- Trustee, -:PFTUSA-CIC, President for the United States of America'- 1787 A.D., not incorporated- William-Edmund-Burke, -Common Law Trustee, et al :Donald John: Trump, :USPS #121 RD 322 307 620 US, 1000 Pennsylvania Ave NW, Washington, District of Columbia 20500;

:General James-Charles: McCormick, Army, et al, :Trustees et al General -COS Army Trustee USPS CAN 7012 2210 0000-4263 7363 ;

:Stephen-G.: Broyles, et al -Trustee Justices et al Scott-See-both; Home- Trustee USPS CAN 7012 2210 0000-4263 7363 ;

Martin Lamb, et al -Sheriffs, Gra county, ANZ state et al :Marti Lamb, - Trustee USPS CAN 7012 0210 0000-4263 7377

:Darrell-James Hill -Negro- -Cuban, -Chiban, -Executor -Beneficiary; Kinsman-redemptor Negro-Yerai, Yurad and the Holy Church under the Almighty-God, Yusufah-Jinnah- the Messiah, ambassador for the Messiah Turkish, Trustee Conception-1213 A.D USPS #121 RD 322 307 610 US 2 / 6

2022-0111769 MISC Page: 2336 of 2782
09/26/2022 03:35:37 PM Receipt #: 22-9381
Rec Fee: \$30.00 Darrell James Hill
Gila County, Az, Sadie Jo Bingham, Recorder



:Executor-Procurement, -:mitigation of the Trustee-derelict- damages ~

53 / 206

:Darrell-James: Hill, :Ohioan- beneficiary-Executor-Procurator, -:mitigation of the Trustee-derelict- damages: Twitter: September 24th, 2020, 7:05 p.m. - :March 9, 2021, 3:35 p.m.



APACHE JUNCTION
151 W SUPERSTITION BLVD
APACHE JUNCTION, AZ 85120-9968
(800)275-8777

12/11/2020 04:21 PM

Product	Qty	Unit Price	Price
First-Class Mail® Letter	1		\$0.70
Registered Mail®			\$13.20
Return Receipt			\$2.65
Total			\$16.75
Grand Total:			\$16.75
Cash			\$16.75

Due to limited transportation availability as a result of national health issues

Registered No. **RE32238761615**

Package \$ 10.70	Extra Services & Fees \$13.20
Registered Mail® \$13.20	Registered Mail® \$13.20
Postage & Fees \$10.70	Postage & Fees \$10.70
Customer Label Declare \$11.00	Customer Label Declare \$11.00

12/11/2020

OFFICIAL USE

TO: **Darrell James Hill**
PO Box 3806
Apache Junction Arizona
85117

FROM: **Slaven G. Bruyer**
Supreme Court of the United States
1 First Street NE
Washington, DC 20543

PS Form 3806, Registered Mail Receipt
Use Only with Registered Mail

2022-011769 MISC Page: 2337 of 2782
09/26/2022 03:35:37 PM Receipt #: 22-9381
Rec Fee: \$30.00 Darrell James Hill
Gila County, Az, Sadie Jo Birmingham, Recorder

Quote Tweet



Darrell James Hill

:Executor-Procurator, -:mitigation of the Trustee-derelict- damages ~

:Darrell-James: Hill, :Ohioan- beneficiary-Executor-Procurator, -:mitigation of the Trustee-derelict- damages: Twitter: September 24th, 2020, 7:05 p.m. - :March 9, 2021, 3:35 p.m.

@DarBenThu1

De-mo-crat-Re-pub-lic-an-...'UNITED-STATES-CORP'-private-:gov.-service-provider,-:EBA-1933-2003-A.D.-Dry-Legislative-Trustee is derelict with the soulless- 'commercial' -public(-private)-policy over public-law. See: Authorization: 'Establish Lawful Government': man- money and laws
Show this thread

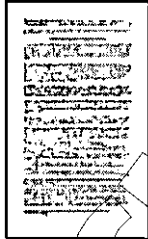
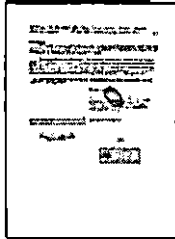
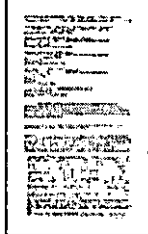

6:23 PM · Dec 11, 2020 · Twitter Web App

2129 BJK
2128
November 23, 2020 8:26 p.m.

Darrell James hill
@DarBenThu1
De-mo-crat-Re-pub-lic-an-...'UNITED-STATES-CORP'-private-:gov.-service-provider,-:EBA-1933-2003-A.D.-Dry-Legislative-Trustee is derelict with the

:Executor-Procurator, -:mitigation of the Trustee-derelict- damages ~

2022-011769 MISC Page: 2338 of 2782
09/26/2022 03:35:37 PM Receipt #: 22-9381
Rec Fee: \$30.00 Darrell James Hill
Gila County, Az, Sadie Jo Bingham, Recorder

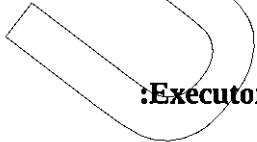
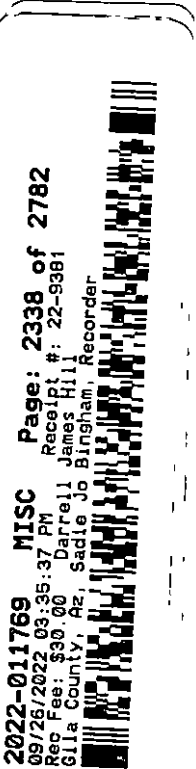

:Darrell-James: Hill, :Ohioan- beneficiary-Executor-Procurator, -:mitigation of the Trustee-derelict- damages: Twitter: September 24th, 2020, 7:05 p.m. - :March 9, 2021, 3:35 p.m.

souless- 'commercial' -public(-private)-policy over public-law. See: Authorization: 'Establish Lawful Government': man- money and laws

:Sovereign :Darrell-James: Hill, :-Negro-Yisrael, :-civilian, :-Ohioan, :-Executive, :-Kinsman-redemptor PO Box 3869, Apache Junction, Arizona 85117 1 / 3

To :Donald-John: Trump, :-POTUSA-CIC, :-POTUScorp, :-Trustee, :-PFTUSA-CIC, :-President for the United States of America- 1776 A.D., not incorporated
William-Peterson: Barr, :-Common Law Trustee,

:General James-Charles: McConville, Army, et al.: Trustees
c/o General -COS Army- Trustee :USPS-CMN 7012 2210 0000 4200 7353
9090 Joint Staff Pentagon
Washington, District of Columbia 20318-9999,

:Stephen-G: Breyer, et al.: Trustee Justice
c/o Scott-Sessions: Harris Trustee :USPS-CMN 7012 2210 0000 4200 7360
Supreme Court of the United States
1 First Street, NE
Washington, District of Columbia 20543, and:

Mark: Lamb, et al.:-Sherris, Gila county, AZ, state
c/o Mark: Lamb, :-Trustee :USPS-CMN 7012 2210 0000 4268 7377
971 N Jason Lopez Circle
Building C
PO Box 567
Florence, Arizona state 85122,

c/o :Donald-John: Trump :USPS-RMN RR 322 387 620 US
1500 Pennsylvania Ave NW
Washington, District of Columbia 20500

:Sovereign-Authorization to Establish :Lawful-Government:
:Kinsman-redemptor- 'Declaration of Independence of 1776 A.D.' -Sovereign-
:Authorization for the Present-Restoration of: 1) Common Law, 2) Lawful Money,
and 3) 'The Constitution for the United States of America' for the United States of
America- people- beneficiaries

Greetings: Donald-John, et al.: William-Peterson, James-Charles: McConville, et al., :Scott-
Sessions: Harris, et al.: Justice, Mark: Lamb, et al.: RTCC;

:Affiant: Soul -Sovereign -Kinsman-redemptor of :Negro-Yisrael, Yisrael, and the Holy-Church
:- married: Darrell-James: Hill on the Earth-Ohioan-born-man-child- sovereign with the
:Almighty-God- given, unalienable-rights of man -where Nothing exists between the :Almighty-God
and :-man-, :-civilian, of the non-political-aggregate, :- a) :Son of Negro-Yisrael: son of
:Canaan, son of James, ... son of Shem, son of Noah, ... son of Adam, son of God; b) :Ohioan,
:-Executor- beneficiary to the EBA-1933-A.D., -Legislative-Dry-Trust'; c) :Kinsman-redemptor for

- 1 :POTUSA means: President: The United States of America, Inc-1863- Presumption: Common Law
:-CIC-Trustee means: man - trustee who the duty, obligation and moral-Oath of Office-27th day of
:January, the year of Lord 2020 A.D., - hereby as :President of The United States of America
:-incorporated 1787 A.D. with the :General Order 100 -Letter Code- 24th day, April, the year of our
:Lord 1929 A.D. under the Declaration of Independence for the United States of America -people by
:'The Constitution for the United States of America', -Accountable to the EPA 1863 A.D. for :-man
:POTUS-Corp means: President of The UNITED STATES corp', Trustee: EBA-1933-2003-A.D. -
:Legislative-Trust-Dry-Trust- Presumption 'commercial law policy; common-law discouraged
2 :Trustee means: the maintainer of the principal, and pro-active distributor of the benefit to the
beneficiary of the prospect of the Trust- instrument and obligation in- accordance with the prevailing
agreement /
- 2 :PFTUSA-CIC means: President for the United States of America- not incorporated, -oblige to the
:Emergency-Proclamation and Letter Code-1863 -duty to ensure republic form of government to
the people by my government-services-provider serving the American state citizens and citizens.
- 3 :Earth-Ohioan-born-man-child- sovereign means: beneficiary of the Concession of 1813 A.D., of
neg. /Declaration of Independence of 1776 A.D., et seq.
- 4 born- sovereign status:- Ohio-state with the :Almighty-God- given, unalienable-rights of the
man, :-civilian, of the non-political-aggregate [] means: Ad B. Pringle, -common-law man
- 5 :Son of :Negro-Yisrael-Father :-Canaan, son of James, ... son of Shem, son of Noah, ... son of
:Adam means: born man-kind Adam, Progeny of Abraham, Isaac and Jacob/Yisrael, Heir of
:Judah,
- 6 :EBA-1933-A.D., -Dry -Legislative-Trust means: Emergency-Banking-Aid of 1933 to 2009-2013
which is defunct, and must be dissolved at the mere request of ANY Beneficiary upon the Trustee

2022-011769 MISC Page: 2339 of 2782
09/28/2022 03:35:37 PM Receipt #: 22-9381
Rec Fee: \$30.00 Darrell James Hill
Gila County, AZ, Sadie Jo Bingham, Recorder

2130
2130

:Executor-Procurator, -:mitigation of the Trustee-derelict- damages ~

:Darrell-James: Hill, :Ohioan- beneficiary-Executor-Procurator, -:mitigation of the Trustee-derelict- damages: Twitter: September 24th, 2020, 7:05 p.m. - :March 9, 2021, 3:35 p.m.

:Soveroign :Darrell-James: Hill, -:Negro-Ysrael, -:civilian, -:Ohioan, -:Executor;
:Kinsman-redeemer PO Box 3906, Apache Junction, Arizona 85117 3 / 3

Providence:

At no time in recent years has the option or man-power presented the nation with this opportunity to affirm and break call of the bonds that devour our resources and squander our freedoms in our elections and our republic for profit.

Wealth and Greed and Misogyny 'Wo the people' do not need another civil-war to again benefit the wealthy-groody-misogynist- profiteers that inhabit our pasts and drink our baby's blood. Rather, we need the full-accounting in the Truth of the Truth, the whole truth, and Nothing but the truth from the Concession of 1213 A.D., et seq.- Declaration of Independence of 1776 A.D. by the power of :Nature and Nature's -God on the footing of that covenantor :in -spirit and :in -truth.

:i- man affirm that the aforesaid is the true and correct demand upon the property-claim, and will state same in the open court.

Without prejudice

Darrell James Hill :Executor
:Darrell-James: Hill, -:Negro-Ysrael, -:civilian,
:Ohioan- beneficiary- Executor, Ambassador
of the Messiah-Yeshua

Affirmed and autographed before me this 23 day, November 2020 A.D.
Type of Identification: Arizona Driver License

Charles Smith
Notary-Public

SEAL



2022-011769 MISC Page: 2340 of 2782
09/26/2022 03:35:37 PM Receipt #: 22-9381
Rec Fee: \$30.00 Darrell James Hill
Gila County, AZ; Sadie Jo Bingham, Recorder

2131

:Darrell-James: Hill, :Ohioan- beneficiary-Executor-Procurator, -:mitigation of the Trustee-derelict- damages: Twitter: September 24th, 2020, 7:05 p.m. - :March 9, 2021, 3:35 p.m.

:Sovereign :Darrell-James: Hill, -[Negro-Yersei, -civilian, -Ohioan, -[Executor, -Kinsman-redeemer PO Box 3906, Apache Junction, Arizona 85117 213

the [Negro-Yersei, Yersei, and the Holy Church, et al., similarly-situated inhabitants on the lands of the United States of America,

Authorization to Establish a Lawful Government

For that Never-before in the history has been the open malfeasance by the UNITED STATES CORP government- services- provider immediately -openly implemented against the people-beneficiaries of the national-trust by the 'UNITED STATES CORP- government- services- provider with the policy to steal the every election now- after by any and every corrupt means; this is the ultimate disrespect forged-upon the people-sovereignty of the 'United States of America' determined by the evidence of same.

These actions by the firing -UNITED STATES CORP are noticed by All of the people and, in fact, the entire world has witnessed the rampant abuse in the manipulation of the American state- elections by sundry wrong-doings. For example, the continued policy of abuse upon the trust of Jason Yersei, unto the enslavement of self- people under the EBA-1933-A.D. -Judicial- dry-trust, to now the full-force instilled by the -UNITED STATES CORP- leadership- derelict for its own purposes, with the abandonment of the fiduciary duty and obligations to the defense of the rights and wills of the people- sovereignty of the United States of America.

AFFIRMED: I- man- Executor-beneficiary- sole, and, as :Kinsman-redeemer, according to the Almighty-God, -covenant in the Declaration of Independence of 1776 A.D., declare that the service-provider :UNITED STATES CORP- DERELICT is demonstratively unfit to maintain the minimum righteous- standard necessary for the trust by the American-state-citizens.

Where, as the election-process under the UNITED STATES CORP, et al- franchises, and fiat-law- system has demonstrated itself desecrator in honor of the sanctity of the law elections-process with dishonesty for nearly three years with the Justice-investigator; and, has proven itself, et al- franchises, derelict to conduct law elections for the people of The United States of America, and to prefer the lie, and,

Whereas: Donald-John: Trump is the President for (The United States of America- unincorporated, 'PTUSA'- 1787; as well as the President of the United States of America -incorporated-, 1863; as well as the President of the 'UNITED STATES CORP' of 1833, as created: 2010 A.D. and:

Where, as the PTUSA-CIC is the only possible oversight at this time for the trust-system failure the by UNITED STATES CORP- apparatus, I- man -Darrell-James: Hill, sovereign- Executor-beneficiary to the Constitution of 1787 A.D., et seq. - Declaration of Independence, et seq., and the Kinsman-redeemer for the inalienable rights of the American-citizen-civilian and citizen- sovereignty in their right for the guaranteed republican-form- of- government, ...

- 1) The sitting-President, man- Trustee of The United States of America, (Donald-John: Trump, may not and without request to please to protect the election-process this day onward, November 23, 2020 A.D. at this signing, and;
- 2) the petty and closure of the EBA-1933-A.D. -property-claimed and possessed by I- man -Darrell-James: Hill, sole, and as the Kinsman-redeemer of the people of the United States of America; and,
- 3) thereafter establish the common-law and demand the 'rule of law'; and,
- 4) thereafter establish money with currency redeemable to money and demand the full currency-system; and,
- 5) thereafter establish the 'Declaration of Independence of 1776 A.D., et seq.' -The Constitution for the United States of America of 1787 A.D.,' restored in the full-truth and disclosure.

This resolution -rests in Complex obligation to meet, but is your accepted DUTY as the POTUSA-CIC, POTUSA-CIC

The POTUSA-CIC with the POTUSA-CIC and the Army, et al., are the obligors to the Declaration of Independence of 1776 A.D., et seq. -The Constitution for the United States of America, 1787 A.D., EP-1863-A.D. -demand. Where, as the 'UNITED STATES CORP- firing- Trustee: EBA-1933-A.D. is unfaithful to now harm.

The POTUSA-CIC must necessarily be a civilian non-B.A.R.- member qualified under The Constitution for the United States of America, 1787 A.D. unto the 13th Amendment. Therefore the administration of the nation-trust to the present embarrassment cannot ever again be distributed- away to the lawyer -B.A.R.-members nor other foreign governments, etc.- corporations).

:Donald-John: I- man now appoints you to achieve this high and lofty goal. :You-man can do this.

2022-0111769 MISC Page: 2341 of 2782
09/28/2022 03:36:37 PM Receipt #: 22-9381
Rec Fee: \$30.00 Darrell James Hill
Gila County, Az, Sadie Jo Bingham, Recorder



2132
UNOFFICIAL

:Darrell-James: Hill, :Ohioan- beneficiary-Executor-Procurator, -:mitigation of the Trustee-derelict- damages: Twitter: September 24th, 2020, 7:05 p.m. - :March 9, 2021, 3:35 p.m.

UNITED STATES POSTAL SERVICE
 APACHE JUNCTION
 551 W SUPERSTITION BLVD
 APACHE JUNCTION, AZ 85120-9998
 (602)775-8777

11/23/2020 02:59 PM

Product	Qty	Unit Price	Price
First-Class Mail® Letter	1		\$0.55
Washington, DC 20500 Weight: 0 to 0.50 oz Estimated Delivery Date Sat 11/28/2020			
Registered Mail®			\$10.20
Amount: \$21.00 Tracking #: Return Receipt Tracking #: 9590 9402 4738 8344 9800 55			
Total			\$16.60
First-Class Mail® Letter	1		\$0.55
Washington, DC 20543 Weight: 0 to 0.50 oz Estimated Delivery Date Sat 11/28/2020			
Certified Mail®			\$3.55
Tracking #: 70122210000042697360			
Total			\$4.10
First-Class Mail® Letter	1		\$0.55
Florence, AZ 85132 Weight: 0 to 0.50 oz Estimated Delivery Date Fri 11/27/2020			
Certified Mail®			\$3.55
Tracking #: 70122210000042697377			
Total			\$4.10
First-Class Mail® Letter	1		\$0.55
Washington, DC 20318 Weight: 0 to 0.50 oz Estimated Delivery Date Sat 11/28/2020			
Certified Mail®			\$3.55
Tracking #: 70122210000042697353			
Total			\$4.10
Grand Total:			\$28.90
Cash			\$10.00
Cash			\$30.00
Change			-\$71.10

Postage & A/C \$22.00
 Extra Services \$13.20
 Registered Mail \$10.20
 Certified Mail \$3.55
 Return Receipt \$3.55
 Tracking # \$3.55
 Total \$76.05

NOV 23 2020

OFFICIAL USE

PO Box 3806
 Apache Junction, Arizona
 85117
 Donald - Mrs. Temp - Justice
 140 Pennsylvania Ave NW
 Washington, District of Columbia
 20500

PS Form 3806, Registered Mail Receipt
 Date of Issue: 11/23/2020

8:26 PM · Nov 23, 2020 · Twitter Web App

Replying to
 @DarBenThu1

:Executor-Procurator, -:mitigation of the Trustee-derelict- damages ~

59 / 206

2022-011769 MISC Page: 2342 of 2782
 09/26/2022 03:35:37 PM Receipt #: 22-9361
 Rec Fee: \$30.00 Darrell James Hill
 Gila County, Az, Sadie Jo Bingham, Recorder



:Darrell-James: Hill, :Ohioan- beneficiary-Executor-Procurator, -:mitigation of the Trustee-derelict- damages: Twitter: September 24th, 2020, 7:05 p.m. - :March 9, 2021, 3:35 p.m.

Abraham Lincoln the 16th PFTUSA on Monday, March 4, 1861, at East Portico - United States Capitol Washington, Dist of Columbia. Donald-John, you are the PFTUSA until March 4, 1861 A.D. for a reason. Please not make that :- man must suit for remedy!



Darrell James hill
[@DarBenThu1](#)

**December 11,
2020
10:12 p.m.**

Darrell James hill
[@DarBenThu1](#)
:RIGHT OF :CONUSANCE ~USPS RMN RE 322 387 616 US...[:] :DEMAND:
Authorization for the Restoration of the Lawful-Government. --
[@mSidneyPowell1](https://blackandbluesoulsmatter.wordpress.com/2020/12/12/rig)
#Republic
[@RealRLimbaugh](#)
[@realDonaldTrump](#)
[@Scavino45](#)
[@GenFlynn](#)
[@LLinWood](#)
[@KrakenWood](#)

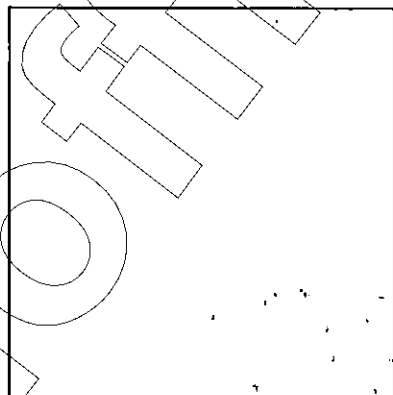

blackandbluesoulsmatter.wordpress.com
:RIGHT OF :CONUSANCE ~USPS RMN RE 322 387 616.US...[:] :DEMAND:
Authorization for the Restoration of...

:Executor-Procurator, -:mitigation of the Trustee-derelict- damages ~

2022-011769 MISC Page: 2343 of 2782
09/26/2022 03:35:37 PM Receipt #: 22-9381
Rep Fee: \$30.00 Darrell James Hill
Gila County, Az, Sadie Jo Bingham, Recorder

4
33

U

OFFICIAL COPY

COPY

Tweet Analytics

Darrell James Hill @DarBenThu1
 "RIGHT OF CONUSANCE -USPS RMN RE 322 387 616 US...[:]:DEMAND: Authorization for the Restoration of the Lawful-Government. - https://blackandbluesoulsmatter.wordpress.com/2020/12/12/rig"

@mSidneyPowell1
 #Republic
 @RealRLimbaugh
 @realDonaldTrump
 @Scavino45
 @GenFlynn
 @LLinWood
 @KrakenWood

Impressions 91
 times people saw this Tweet on Twitter

Total engagements 2
 times people interacted with this Tweet

[View all engagements](#)

10:12 PM · Dec 11, 2020

Messages

2022-011769 MISC Page: 2344 of 2782
 Receipt #: 22-9381
 Darrell James Hill
 Reg Fee: \$30.00
 Gila County, Az, Sadle Jo Bingham, Recorder

2130

:Darrell-James: Hill, :Ohioan- beneficiary-Executor-Procurator, -:mitigation of the Trustee-derelict- damages: Twitter: September 24th, 2020, 7:05 p.m. - :March 9, 2021, 3:35 p.m.

second-letter-to-us-sc-aftr-tx-v-pa-finale-allDownload
10:12 PM · Dec 11, 2020 · Twitter Web App

**Dec 11, 2020
10:21 p.m.**

Darrell James hill
@DarBenThu1
:RIGHT OF :CONUSANCE ~USPS RMN RE 322 387 616 US...[:] :DEMAND:
Authorization for the Restoration of the Lawful-Government. --
<https://blackandbluesoulsmatter.wordpress.com/2020/12/12/rig>
@HIT Evidence
@DrPaulGosar
@AZGOP
@anonpatriotq
@blckriflecoffee
@15poundstogo
@propublica
@Barnes Law
@Snowden
@wikileaks

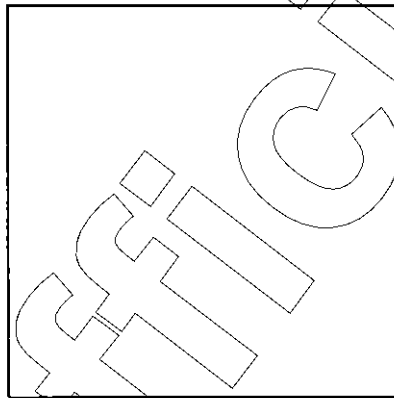

blackandbluesoulsmatter.wordpress.com
:RIGHT OF :CONUSANCE ~USPS RMN RE 322 387 616 US...[:] :DEMAND:
Authorization for the Restoration of...
second-letter-to-us-sc-aftr-tx-v-pa-finale-allDownload
10:21 PM · Dec 11, 2020 · Twitter Web App

**December 11,
2020
10:31 p.m.**

Darrell James hill
@DarBenThu1
:RIGHT OF :CONUSANCE ~USPS RMN RE 322 387 616 US...[:] :DEMAND:
Authorization for the Restoration of the Lawful-Government. --

:Executor-Procurator, -:mitigation of the Trustee-derelict- damages ~

2022-011769 MISC Page: 2345 of 2762
09/26/2022 03:35:37 PM Receipt #: 22-9381
Rep Fee: \$30.00 Darrell James Hill
Gila County, Az, Sadie Jo Bingham, Recorder



:Darrell-James: Hill, :Ohioan- beneficiary-Executor-Procurator, -:mitigation of the Trustee-derelict- damages: Twitter: September 24th, 2020, 7:05 p.m. - :March 9, 2021, 3:35 p.m.

<https://blackandbluesoulsmatter.wordpress.com/2020/12/12/rig>
[@UNHumanRights](#)
[@NLatUN](#)
[@UNTreatyBodies](#)
[@BerniceKing](#)
[@OHCHR_EARO](#)
[@womensmarchgbal](#)
[@FemiOke](#)
[@UNHumanRightsUA](#)
[@UN_CMW](#)

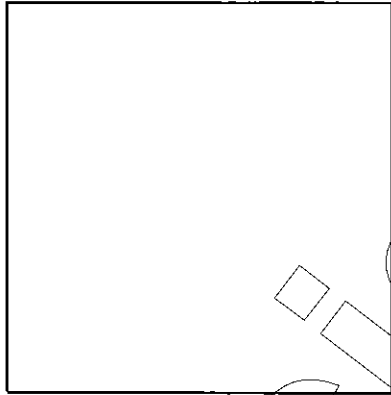

blackandbluesoulsmatter.wordpress.com
:RIGHT OF :CONUSANCE ~USPS RMN RE 322 387 616 US...[:] :DEMAND:
Authorization for the Restoration of...
second-letter-to-us-sc-aftr-tx-v-pa-finale-allDownload
10:31 PM · Dec 11, 2020 · Twitter Web App

**December 11,
2020
10:36 p.m.**

Darrell James hill
[@DarBenThu1](#)
:RIGHT OF :CONUSANCE ~USPS RMN RE 322 387 616 US...[:] :DEMAND:
Authorization for the Restoration of the Lawful-Government. --
<https://blackandbluesoulsmatter.wordpress.com/2020/12/12/rig>
[@LtGovHusted](#)
[@GovMikeDeWine](#)
[@Ohio_Trucking](#)
[@OhioEggFarmers](#)
[@Ohio_Cattlemen](#)
[@AGCOhio](#)
[@AUSAorg](#)
[@OhioPoliticsNow](#)

2136
2137

:Executor-Procurator, -:mitigation of the Trustee-derelict- damages ~

62 / 206

2022-011769 MISC Page: 2346 of 2782
05/25/2022 03:35:37 PM Receipt #: 22-9381
Rec Fee: \$36.00 Darrell James Hill
Gila County, AZ, Sadie Jo Bingham, Recorder

Original Copy

09/26/2022 03:35:37 PM Receipt #: 22-9381
Rec Fee: \$30.00 Darrell James Hill
Gila County, Az, Sadie Jo Bingham, Recorder



Darrell James hill on Twitter: "RIGHT OF :CONUSANCE -USPS RMN RE 322 387 616 US...[:]:DEMAND: Authorization for the restoration of the Lawful-Government. -- https://t.co/1Xz4IXxBZ @HIT_Evidence @DrPaulGosar @AZGOP @anonpatriotq @

File Edit View History Bookmarks Tools Help

All Mail - dhill X New Tab X Onkyo receiver X Apache Junction X WunderMap X Inbox (107) X Total Praise X Darrell James Hill X b-1020-Intro X a-2020-09-20 X New Tab X

https://twitter.com/DarBenThu1/status/1337628659834789888/analytics 150% Search: I'll never be more loved

Getting Started EXECUTIVE ORDERS REF COMMERCE DAVID STRAIGHTERS AJ

Twitter navigation icons: Home, Search, Notifications, Messages, Profile, Tweet, etc.

Timeline: @propublica, @Barnes_Law, @Snowden, @wikileaks

10:21 PM · Dec 11, 2021

View Tweets activity

Tweet Analytics

Darrell James hill @DarBenThu1

:RIGHT OF :CONUSANCE -USPS RMN RE 322 387 616 US...[:]:DEMAND: Authorization for the Restoration of the Lawful-Government. -- https://blackandbluesoulsmatter.wordpress.com/2020/12/12/rig

@HIT_Evidence
@DrPaulGosar
@AZGOP
@anonpatriotq
@blckriflecoffee
@15poundstogo
@propublica
@Barnes_Law
@Snowden
@wikileaks

Impressions 95
times people saw this Tweet on Twitter

Total engagements 4
times people interacted with this Tweet

Messages

Tuesday November 9, 2020

09/26/2022 03:35:37 PM Receipt #: 22-9381
Rec Fee: \$30.00 Darrell James Hill
Gila County, Az. Sadie Jo Bingham, Recorder



Darrell James Hill on Twitter: "RIGHT OF CONUSANCE -USPS RMN RE 322 387 616 US...[] :DEMAND: Authorization for the Restoration of the Lawful-Government. -- https://t.co/JXz4IXx82 @UNHumanRights @NLatUN @UNTreatyBodies @BerniceKing"

File Edit View History Bookmarks Tools Help

All Mail - djhill X New Tab Onkyo receive X Apache Junct X WunderMap X M Inbox (107) X Total Praise X Darrell James Hill X b-1020-intro X a-2020-09-20 X New Tab X

https://twitter.com/DarBenThu1/status/1337631074281684996/analytics 150%

Getting Started EXECUTIVE ORDERS REF COMMERCE DAVID STRAIGHTERS AJ

Tweet Analytics

Darrell James Hill @DarBenThu1
:RIGHT OF CONUSANCE -USPS RMN RE 322 387 616 US...[] :DEMAND: Authorization for the Restoration of the Lawful-Government. -- https://blackandbluesoulsmatter.wordpress.com/2020/12/12/rig

@UNHumanRights
@NLatUN
@UNTreatyBodies
@BerniceKing
@OHCHR_EARO
@womensmarchgbal
@FemiOke
@UNHumanRightsUA
@UN_CMW

Impressions 95
times people saw this Tweet on Twitter

Total engagements 3
times people interacted with this Tweet

← Tweet

@OHCHR_EA
@womensma
@FemiOke
@UNHumanR
@UN_CMW

10:31 PM · Dec 11, 2021

View Tweet activity

Tweet yo

at unitednationshumanrights.
Up Human Rights

lands at UN

ermanent Mission of the
n of the Netherlands to the
Nations in New York |
sadors: @yokebrandt &
Zeitenrath | Ministry
MFA

pening

ago
te airing on ABC
in, Bella

ture today!
in Bloom

messages

Tuesday November 9, 22:00

2140

09/26/2022 03:35:37 PM Receipt #: 22-9381
Rec Fee: \$30.00 Darrell James Hill
Gila County, Az, Sadie Jo Bingham, Recorder



Darrell James Hill on Twitter: "RIGHT OF :CONUSANCE -USPS RMN RE 322 387 616 US...[:] :DEMAND: Authorization for the Restoration of the Lawful-Government. -- https://t.co/1XccA1KxB2 @LtGovHusted @GovMikeDeWine @Ohio_Trucking @Ohi...

File Edit View History Bookmarks Tools Help

My All Mail - dhill X New Tab X Onkyo receiver X Apache Junct X WunderMap6 X M Inbox (107) - d X Total Prize - Y X Darrell James Hill X b-1020-intro-t X a-2020-09-20 X New Tab X

https://twitter.com/DarBenThu1/status/133763244587775424/analytics 150%

Getting Started EXECUTIVE ORDERS REF COMMERCE DAVID STRAIGHTERS AJ

Tweet Analytics

Darrell James Hill @DarBenThu1
:RIGHT OF :CONUSANCE -USPS RMN RE 322 387 616 US...[:] :DEMAND:
Authorization for the Restoration of the Lawful-Government. --
<https://blackandbluesoulsmatter.wordpress.com/2020/12/12/rig>

- @LtGovHusted
- @GovMikeDeWine
- @Ohio_Trucking
- @OhioEggFarmers
- @Ohio_Cattlemen
- @AGCOhio
- @AUSAorg
- @OhioPoliticsNow
- @POTUS

10:36 PM · Dec 14, 2021

View Tweet activity

Impressions	106
times people saw this Tweet on Twitter	
Total engagements	2
times people interacted with this Tweet	

Messages

Tuesday November 9, 22:00

:Darrell-James: Hill, :Ohioan- beneficiary-Executor-Procurator, -:mitigation of the Trustee-derelict- damages: Twitter: September 24th, 2020, 7:05 p.m. - :March 9, 2021, 3:35 p.m.

@POTUS

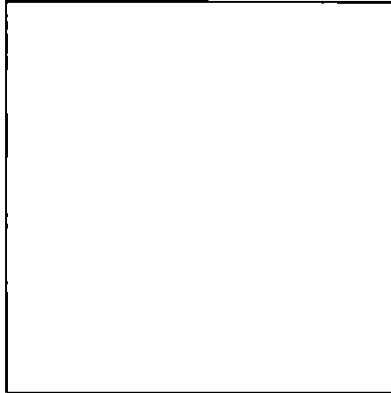

COPY

blackandbluesoulsmatter.wordpress.com
:RIGHT OF :CONUSANCE ~USPS RMN RE 322 387 616 US...[:] :DEMAND:
Authorization for the Restoration of...
second-letter-to-us-sc-aftr-tx-v-pa-finale-allDownload
10:36 PM · Dec 11, 2020 · Twitter Web App

December 11,
2020
10:41 p.m.

Darrell James hill
@DarBenThu1
:RIGHT OF :CONUSANCE ~USPS RMN RE 322 387 616 US...[:] :DEMAND:
Authorization for the Restoration of the Lawful-Government. --
https://blackandbluesoulsmatter.wordpress.com/2020/12/12/rig
@H2Ohio
@OHIOMFG
@DaytonChildrens
@OHSupremeCourt
@washingtonpost
@FLOTUS
@Ohio_OBM
@SinclairCC
@NatlGovsAssoc

2/4/21
2/4/21

:Executor-Procurator, -:mitigation of the Trustee-derelict- damages ~

63 / 206

2022-011769 MISC Page: 2350 of 2782
09/26/2022 03:35:37 PM Receipt #: 22-9381
Reg Fee: \$30.00 Darrell James Hill
Gila County, Az, Sadie Jo Bingham, Recorder



:Darrell-James: Hill, :Ohioan- beneficiary-Executor-Procurator, -:mitigation of the Trustee-derelict- damages: Twitter: September 24th, 2020, 7:05 p.m. - :March 9, 2021, 3:35 p.m.

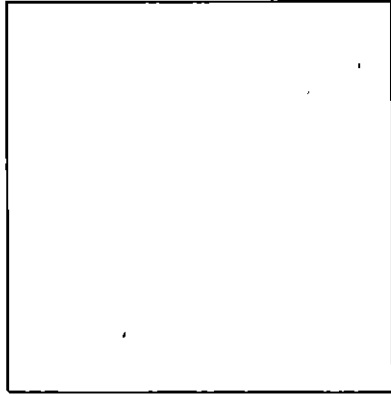

blackandbluesoulsmatter.wordpress.com
:RIGHT OF :CONUSANCE ~USPS RMN RE 322 387 616 US...[:] :DEMAND:
Authorization for the Restoration of...
second-letter-to-us-sc-aftr-tx-v-pa-finale-allDownload
10:41 PM · Dec 11, 2020 · Twitter Web App

Unofficial Copy

2142

:Executor-Procurator, -:mitigation of the Trustee-derelict- damages ~

64 / 206

2022-011769 MISC Page: 2351 of 2782

09/26/2022 03:35:37 PM Receipt #: 22-9381
Rec Fee: \$30.00 Darrell James Hill
Gila County, Az, Sadie Jo Bingham, Recorder



Tweet

@Ohio_OBM
@SinclairCC
@NatIGovsAss

10:41 PM · Dec 11, 2020

View tweet activity

Tweet Analytics

Darrell James Hill @DarBenThu1
 :RIGHT OF CONUSANCE -USPS RMN RE 322 387 616 US...[:] :DEMAND:
 Authorization for the Restoration of the Lawful-Government. -
<https://blackandbluesoulsmatter.wordpress.com/2020/12/12/rig>

@H2Ohio
 @OHMFG
 @DaytonChildrens
 @OHSupremeCourt
 @washingtonpost
 @FLOTUS
 @Ohio_OBM
 @SinclairCC
 @NatIGovsAssoc

Impressions	119
times people saw this Tweet on Twitter	
Total engagements	5
times people interacted with this Tweet	

to Manufactur...
MFG Follow

stion of The Ohio
cturers' Association is to
& grow Ohio manufacturing.

pening

te airing on ABC

ture today!

Wedding Photos

:Darrell-James: Hill, :Ohioan- beneficiary-Executor-Procurator, -:mitigation of the Trustee-derelict- damages: Twitter: September 24th, 2020, 7:05 p.m. - :March 9, 2021, 3:35 p.m.

**December 11, 2020
10:46 p.m.**

Darrell James hill
[@DarBenThu1](#)
:RIGHT OF :CONUSANCE ~USPS RMN RE 322 387 616 US...[:] :DEMAND:
Authorization for the Restoration of the Lawful-Government. --
<https://blackandbluesoulsmatter.wordpress.com/2020/12/12/rig>
[@BfarmerJustice1](#)
[@JhishawEsq](#)
[@shearm](#)
[@shawsebastian](#)
[@HEAL Food](#)
[@NBEJA](#)
[@navinakhanna](#)
[@michaelharriot](#)
[@RyanLizza](#)

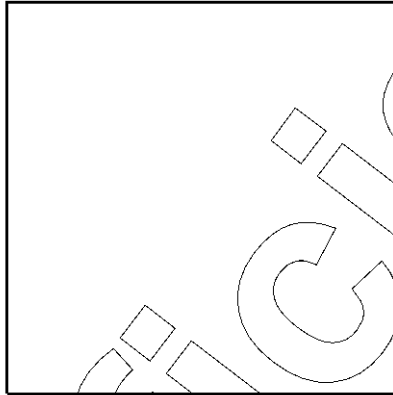

blackandbluesoulsmatter.wordpress.com
:RIGHT OF :CONUSANCE ~USPS RMN RE 322 387 616 US...[:] :DEMAND:
Authorization for the Restoration of...
[second-letter-to-us-sc-aftr-tx-v-pa-finale-allDownload](#)
10:46 PM · Dec 11, 2020 · Twitter Web App

**December 11, 2020
10:51 p.m.**



Darrell James hill
[@DarBenThu1](#)
:RIGHT OF :CONUSANCE ~USPS RMN RE 322 387 616 US...[:] :DEMAND:
Authorization for the Restoration of the Lawful-Government. --

:Executor-Procurator, -:mitigation of the Trustee-derelict- damages ~

65 / 206

2022-011769 MISC Page: 2353 of 2762

09/26/2022 03:35:37 PM Receipt #: 22-9381
Rec Fee: \$30.00 Darrell James Hill
Gila County, Az, Sadie Jo Bingham, Recorder



:Darrell-James: Hill, :Ohioan- beneficiary-Executor-Procurator, -:mitigation of the Trustee-derelict- damages: Twitter: September 24th, 2020, 7:05 p.m. - :March 9, 2021, 3:35 p.m.

<https://blackandbluesoulsmatter.wordpress.com/2020/12/12/rig>
[@BTFA ZA](#)
[@DrTurleyTalks](#)
[@AnnMorrison3](#)
[#Truth](#) [#GreatAwakening](#) [#MAGA](#) [#KAG](#) [#FIGHTBACK](#)

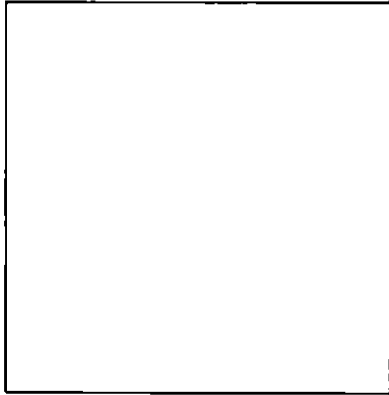

blackandbluesoulsmatter.wordpress.com
:RIGHT OF :CONUSANCE ~USPS RMN RE 322 387 616 US...[:] :DEMAND:
Authorization for the Restoration of...
second-letter-to-us-sc-aftr-tx-v-pa-finale-allDownload
10:51 PM · Dec 11, 2020 · Twitter Web App

December 12, 2020 9:20 p.m. Darrell James hill
@DarBenThu1
United States Colored Troops

*2/11/21
2/14/21*

:Executor-Procurator, -:mitigation of the Trustee-derelict- damages ~

66 / 206

2022-011769 MISC Page: 2354 of 2782
09/26/2022 03:35:37 PM Receipt #: 22-9381
Rec Fee: \$30.00 Darrell James Hill
Gila County, Az, Sadie Jo Bingham, Recorder



2022-011769 MISC Page: 2355 of 2782
09/26/2022 03:35:37 PM Receipt #: 22-9381
Rec Fee: \$30.00 Darrell James Hill
Gila County, Az, Sadie Jo Bingham, Recorder

Darrell James Hill on Twitter: :RIGHT OF CONUSANCE -USPS RMN RE 322 387 616 US...[] :DEMAND: Authorization for the Restoration of the Lawful-Government. -- https://t.co/1Xxz4IXx82 @BfarmerJustice1 @JhishawEsq @shearm @shawsebasti...

File Edit View History Bookmarks Tools Help

All Mail - dphill X New Tab Onkyo receive X Apache Junct X WunderMap X Inbox (107) - c X Total Praise - Y X Darrell James Hill X b-1020-Intro X a-2020-09-20 X New Tab X

https://twitter.com/DarBenThu1/status/1337635036930035713/analytics 150%

Getting Started EXECUTIVE ORDERS REF COMMERCE DAVID STRAIGHTERS AJ

Twitter navigation sidebar with icons for Home, Search, Notifications, Messages, and Profile.

Tweet Analytics

Darrell James Hill @DarBenThu1
:RIGHT OF CONUSANCE -USPS RMN RE 322 387 616 US...[] :DEMAND:
Authorization for the Restoration of the Lawful-Government. --
<https://blackandbluesoulsmatter.wordpress.com/2020/12/12/rig>

@BfarmerJustice1
@JhishawEsq
@shearm
@shawsebastian
@HEAL_Food
@NBFJA
@navinakhanna
@michaelharriot
@RyanLizza

Impressions 125
times people saw this Tweet on Twitter

Total engagements 2
times people interacted with this Tweet

Twitter feed sidebar with various tweet snippets and media thumbnails.

Handwritten notes:
2/11/22
2/11/22

Tweet
#FIGHTBACK

Tweet Analytics

Darrell James Hill @DarBenThu1
:RIGHT OF CONUSANCE -USPS RMN RE 322 387 616 US...[:] :DEMAND:
Authorization for the Restoration of the Lawful-Government. --
<https://blackandbluesoulsmatter.wordpress.com/2020/12/12/rig>

@BTFA_ZA
@DrTurleyTalks
@AnnMorrison3
#Truth #GreatAwakening
#MAGA
#KAG
#FIGHTBACK

10:51 PM · Dec 11, 2020
View Tweet activity

Impressions 199
times people saw this Tweet on Twitter

Total engagements 5
times people interacted with this Tweet

[View all engagements](#)

Messages

2022-011769 MISC Page: 2356 of 2782

09/26/2022 03:35:37 PM Receipt #: 22-9981
Rec Fee: \$30.00 Darrell James Hill
Gila County, Az, Sadie Jo Bingham, Recorder



Darrell James hill on Twitter: "United States Colored Troops https://t.co/n6DU7EwzSC" / Twitter - Mozilla Firefox

File Edit View History Bookmarks Tools Help

All Mail - dphill X New Tab X Onkyo receive X Apache Junda X WunderMap X Inbox (107) X Total Prize X Darrell James X b-1020-intro X a-2020-09-20 X New Tab X

https://twitter.com/DarBenThu1/status/1337975657502887938/analytics 150% i'll never be more loved

Getting Started EXECUTIVE ORDERS REF COMMERCE DAVID STRAIGHTERS AJ

Tweet

289,000+ total dead

- 147,000+ views
- 426,653+ impressions
- Total: 634,000+ views
- 50,000+ retweets
- 80,000+ likes
- Total: 610,222

9:20 PM · Dec 10

View Tweet

1 Quote Tweet

Tweet your photos

Tweet Analytics

Darrell James hill @DarBenThu1
United States Colored Troops pic.twitter.com/n6DU7EwzSC

Impressions	376
times people saw this Tweet on Twitter	
Total engagements	11
times people interacted with this Tweet	

View all engagements

ending
naughey

5 hours ago
by And Aaron
New Statements
Controversial
Comments

5 hours ago
Eddie Tiedley
non who could
charges in death of
S

Privacy Policy Cookie Policy
© 2021 Twitter, Inc

Promote your Tweet

Messages

Tuesday November 9, 21:58

2022-011769 MISC Page: 2357 of 2782

09/26/2022 03:35:37 PM Receipt #: 22-9381

Rec Fee: \$30.00 Darrell James Hill

Gila County, Az, Sadie Jo Bingham, Recorder



:Darrell-James: Hill, :Ohioan- beneficiary-Executor-Procurator, -:mitigation of the Trustee-derelict- damages: Twitter: September 24th, 2020, 7:05 p.m. - :March 9, 2021, 3:35 p.m.

Dec 13, 2020
3:49 p.m.

Darrell James hill
[@DarBenThu1](#)
Please see into this for
[@DarBenThu1](#)
[@AOC](#)
[@AndreaSCousins](#)
[@francescamari](#)
[@ronmknox](#)
[@byHeatherLong](#)
[@JenniferJJacobs](#)
[@perrybaconjr](#)
[@DrJasonJohnson](#)
[@HexPositive](#)
[@ CharlesPreston](#)
3:49 PM · Dec 13, 2020 · Twitter Web App

November 12,
2020
12:51 a.m.



Darrell James hill
[@DarBenThu1](#)
This
[@DarBenThu1](#)

is for :remedy against theft by :Donald-John: Trump, -:POTUS-corp, -:Trustee, et al.-. These 'Bill of Particulars' rendered are required for the agreed-upon :penalty-compensation until the stolen property is restored :in- specie. See:

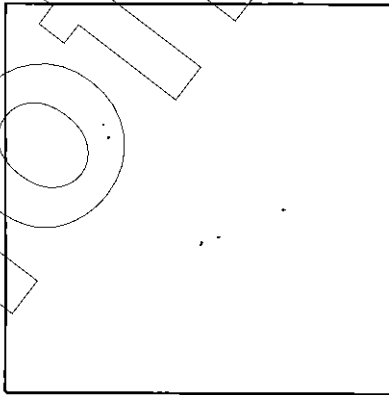

2149
2150

:Executor-Procurator, -:mitigation of the Trustee-derelict- damages ~

2022-011769 MISC Page: 2359 of 2782
09/26/2022 03:35:37 PM Receipt #: 22-9381
Rec Fee: \$30.00 Darrell James Hill
Gila County, Az, Sadie Jo Bingham, Recorder



2151
#H5032

Darrell James Hill on Twitter: "This @DarBenThu1 is for :remedy against theft by :Donald-John: Trump, -:POTUS-corp, -:Trustee, et al.-. These 'Bill of Particulars' rendered are required for the agreed-upon :penalty-compensation until the stolen property is restored in-specie. See: https://blackandbluesoulsmatter.wordpress.com/2020/11/12/bill-of-particulars-lot-1-2-and-3-of-3-rendered-to-donald-john-trump-due-paid-now/ ..."

File Edit View History Bookmarks Tools Help

https://twitter.com/DarBenThu1/status/1326794848029040641/analytics

Getting Started EXECUTIVE ORDERS REF COMMERCE DAVID STRAIGHTERS AJ

Thread

These 'Bill of agreed-upon property is re

2:51 AM Nov 12, 2021

View Tweet activity

1 Quote Tweet

Tweet by

Promote your Tweet

Messages

Tuesday November 9, 21:57

Tweet Analytics

Darrell James Hill @DarBenThu1
This @DarBenThu1 is for :remedy against theft by :Donald-John: Trump, -:POTUS-corp, -:Trustee, et al.-. These 'Bill of Particulars' rendered are required for the agreed-upon :penalty-compensation until the stolen property is restored in-specie. See: https://blackandbluesoulsmatter.wordpress.com/2020/11/12/bill-of-particulars-lot-1-2-and-3-of-3-rendered-to-donald-john-trump-due-paid-now/ ...

Impressions	717
times people saw this Tweet on Twitter	
Total engagements	47
times people interacted with this Tweet	

View all engagements

2022-011769 MISC Page: 2360 of 2782
 09/26/2022 03:35:37 PM Receipt #: 22-9381
 Rec Fee: \$30.00 Darrell James Hill
 Gila County, Az, Sadie Jo Bingham, Recorder

:Darrell-James: Hill, :Ohioan- beneficiary-Executor-Procurator, -:mitigation of the Trustee-derelict- damages: Twitter: September 24th, 2020, 7:05 p.m. - :March 9, 2021, 3:35 p.m.

blackandbluesoulsmatter.wordpress.com
Bill of Particulars- Lot 1, 2 and 3 of 3 rendered to :Donald-John: Trump: due paid now.
Bill of Particulars- Lot 1, 2 and 3 of 3 rendered to :Donald-John: Trump: due paid now. Law – Thou Shalt Not Steal. FINAL TWITTER BLACKOUT
12:51 AM · Nov 12, 2020 · Twitter Web App
1
Quote Tweet

Replying to
@DarBenThu1
Please see into this for
@DarBenThu1
@AOC
@AndreaSCousins
@francescamari
@ronmknox
@byHeatherLong
@JenniferJJacobs
@perrybaconjr
@DrJasonJohnson
@HexPositive
@ CharlesPreston



Darrell James hill
@DarBenThu1

December 13, 2020 3:56 p.m.
Darrell James hill
@DarBenThu1
Please see into this for
@DarBenThu1
@frfrankpavone
@Txejd
@TeresaRoeloffs
@jese
@MandyP15575406

:Executor-Procurator, -:mitigation of the Trustee-derelict- damages ~

2022-011769 MISC Page: 2361 of 2782
09/26/2022 03:35:37 PM Receipt #: 22-9981
Rec Fee: \$30.00 Darrell James Hill
Gila County, Az, Sadie Jo Bingham, Recorder



205132
2152

:Darrell-James: Hill, :Ohioan- beneficiary-Executor-Procurator, -:mitigation of the Trustee-derelict- damages: Twitter: September 24th, 2020, 7:05 p.m. - :March 9, 2021, 3:35 p.m.

@MikeGreerofCU
@ElaineBassill
@gmaithree
@JerusalemJones
3:56 PM · Dec 13, 2020 · Twitter Web App

December 13, 2020
4:08 p.m.

Darrell James hill
@DarBenThu1
Please see into this for
@DarBenThu1
@wambuizonzo
@_MeganPowers
@ShaneWenzel
@pelchat_gerald
@ScottMinerd
@cjtruth
@Mbali_porsh
@oceht
@Breaker1111Girl
@RebeccaHahn
@boldmovesdiary
@sisterkellyjo
@CMartingano
@BraudrickF
@benshapiro
@Truth_Person
4:08 PM · Dec 13, 2020 · Twitter Web App

December 13, 2020
4:16 p.m.

Darrell James hill
@DarBenThu1
Please see into this for
@DarBenThu1
@ProjectLincoln
@donlemon
@JoyVBehar
@sunny
@JoeBiden
@DrEricDing
@GeoRebekah
@TheView
@chrislhayes

2158
:Executor-Procurator, -:mitigation of the Trustee-derelict- damages ~



09/26/2022 09:35:37 PM Receipt #: 22-9381
Rec Fee: \$30.00 Darrell James Hill
Gila County, Az, Sadie Jo Bingham, Recorder



Browser window: Mozilla Firefox
Address bar: https://twitter.com/DarBenThu1/status/1339256605817630724/analytics
Tabs: All Mail - djhill, New Tab, Only receiver, Apache Junction, WunderMap, Inbox (107), Total Praise, Darrell James Hill, b-1020-intro, a-2020-09-20, New Tab

Tweet Analytics

Darrell James Hill @DarBenThu1
Please see into this for @DarBenThu1
@frfrankpavone
@Txejd
@TeresaRoeloffs
@jese
@MandyP15575406
@MikeGreerofCU
@ElaineBassill
@gmaithree
@JerusalemJones

Impressions 140
times people saw this Tweet on Twitter

Total engagements 1
times people interacted with this Tweet

[View all engagements](#)

Twitter interface elements: Tweet, @jese, @MandyP15575406, @MikeGreerofCU, @ElaineBassill, @gmaithree, @JerusalemJones, 3:56 PM Dec 13, 2021, Follow, @frfrankpavone, Catholic Priest, prolife leader, Was National, Prolife Voices for Trump, YouTube, Pavone, opening, airing on ABC, future today!

2155



Darrell James Hill on Twitter: Please see into this for @DarBenThu1

File Edit View History Bookmarks Tools Help

https://twitter.com/DarBenThu1/status/1338259604514381824/analytics

Getting Started EXECUTIVE ORDERS REF COMMERCE DAVID STRAIGHTERS AJ

← Tweet

@RebeccaHahn

@boldmovesdiary

@sisterkellyjo

@CMartingano

@BraudrickF

@benshapiro

@Truth_Person

1:08 PM · Dec 13, 2021

View Tweet activity

Tweet Analytics

Darrell James Hill @DarBenThu1

Please see into this for @DarBenThu1

@wambuizonzo

@MeganPowers

@ShaneWenzel

@pelchat_gerald

@ScottMinerd

@cjtruth

@Mball_porsh

@oceht

@Breaker1111Girl

@RebeccaHahn

@boldmovesdiary

@sisterkellyjo

@CMartingano

@BraudrickF

@benshapiro

@Truth_Person

Impressions 187

times people saw this Tweet on Twitter

Total engagements 16

messages

my own/fish | Digital

Wenzel

Wenzel Follow

Travel | Homebuilder |

neur | LGBTQ |

vative | President

promoting | BOD |

temp | Contrib

pening

tearing on ABC

ture today!

messages

09/26/2022 03:35:37 PM Receipt #: 22-9381
Rec Fee: \$30.00 Darrell James Hill
Gila County, Az, Sadie Jo Bingham, Recorder



2156

Darrell James hill on Twitter: "Please see into this for @DarBenThu1 @ProjectLincoln @donlemon @JoyVBehar @sunny @JoeBiden @DrEricDing @GeoRebekah @TheView @christhayes @amjoys show @maddow @JoyAnnReid @wsvn @nytimes @erikfinman @csdoctorsis" 4:16 PM - Dec 13, 2021

File Edit View History Bookmarks Tools Help

All Mail - djhill X New Tab Onkyo receiver X Apache Junction X WunderMap X Inbox (107) X Total Praise - Y X Darrell James Hill X b-1020-intro-t X a-2020-09-20 X New Tab X

https://twitter.com/DarBenThu1/status/1338261496489361409/analytics 150%

Getting Started EXECUTIVE ORDERS REF COMMERCE DAVID STRAIGHTERS AJ

Tweet Analytics

Darrell James hill @DarBenThu1
Please see into this for @DarBenThu1
@ProjectLincoln
@donlemon
@JoyVBehar
@sunny
@JoeBiden
@DrEricDing
@GeoRebekah
@TheView
@christhayes
@amjoys show
@maddow
@JoyAnnReid
@wsvn
@nytimes
@erikfinman
@csdoctorsis

Impressions 180
times people saw this Tweet on Twitter

Total engagements 4

Twitter interface with navigation icons on the left and a right sidebar. The main content area shows the tweet and its analytics. The right sidebar contains trending topics and suggested tweets.

Navigation icons: Home, Search, Activity, Messages, Profile, etc.

Right sidebar: Trending topics like "Earlier today at Just Got Wedding Photos", "Ending naughey", and "Trending".

Bottom status bar: Tuesday November 9, 21:57

:Darrell-James: Hill, :Ohioan- beneficiary-Executor-Procurator, -:mitigation of the Trustee-derelict- damages: Twitter: September 24th, 2020, 7:05 p.m. - :March 9, 2021, 3:35 p.m.

@amjoyshow
@maddow
@JoyAnnReid
@wsvn
@nytimes
@erikfinman
@csdoctorsister
4:16 PM · Dec 13, 2020 · Twitter Web App

December 13, 2020
4:30 p.m.

Darrell James hill
@DarBenThu1
Please see into this for
@DarBenThu1
@HouseDailyPress
@CNNPolitics
@latimespolitics
@stateoftheyan
@KrisB_Brown
@AyannaPressley
@NPR
@DukeMargolis
@AdelleNaz
@shaunasanford
@wandavazquezg
@RamonaWritesLA
@BrookingsInst
@timcraigpost
@ASAEcenter
4:30 PM · Dec 13, 2020 · Twitter Web App

December 13, 2020
4:39 p.m.

Darrell James hill
@DarBenThu1
Please see into this for:
@DarBenThu1
@ThePlymLineGS
@CivilWarTimes
@EmergingCWBlog
@CivilWarMonitor
@hfarmmuseum
@TheUSCivilWar
@CaptAndrewLuck

:Executor-Procurator, -:mitigation of the Trustee-derelict- damages ~

71 / 206

2022-011769 MISC Page: 2366 of 2782

09/26/2022 03:35:37 PM Receipt #: 22-9381
Rec Fee: \$30.00 Darrell James Hill
Gila County, Az; Sadie Jo Bingham, Recorder



2157
2156 BC

Official Copy

:Darrell-James: Hill, :Ohioan- beneficiary-Executor-Procurator, -:mitigation of the Trustee-derelict- damages: Twitter: September 24th, 2020, 7:05 p.m. - :March 9, 2021, 3:35 p.m.

- [@kurtluther](#)
- [@CharmedMagnolia](#)
- [@FortNegley](#)
- [@KentuckyCW](#)
- [@the_allm](#)
- [@USGrantLibrary](#)
- [@2ndMDCOA](#)
- [@CWPhotoSleuth](#)
- [@JGiesberg](#)
- [@JCWE1](#)

Quote Tweet



Darrell James hill
[@DarBenThu1](#)

United States Colored Troops

2/158

:Executor-Procurator, -:mitigation of the Trustee-derelict- damages ~

72 / 206

2022-011769 MISC Page: 2367 of 2782

09/26/2022 03:35:37 PM Receipt #: 22-9381

Rec Fee: \$30.00 Darrell James Hill

Gila County, Az, Sadie Jo Bingham, Recorder



Thread

4:39 PM - Dec 18, 2021

View Tweet activity

Tweet by Darrell James hill

Replying to You gotta see this from 'shour

video.com

messages

Privacy Policy Cookie Policy © 2021 Twitter, Inc.

Tweet Analytics

Darrell James hill @DarBenThu1
Please see into this for: @DarBenThu1 @ThePlumLineGS @CivilWarTimes @EmergingCWBlog @CivilWarMonitor @hfarmmuseum @TheUSCivilWar @CaptAndrewLuck @kurtluther @CharmedMagnolia @FortNegley @KentuckyCW @the_allin @USGrantLibrary @2ndMDCOA @CWPhotoSleuth @JGiesberg @JCWE1 <https://twitter.com/DarBenThu1/status/1337975657502887938> ...

Impressions 245
times people saw this Tweet on Twitter

Tweet Analytics

Darrell James hill @DarBenThu1
Please see into this for @DarBenThu1
@HouseDailyPress
@CNNPolitics
@latimespolitics
@stateoftheyan
@KrisB_Brown
@AyannaPressley
@NPR
@DukeMargolis
@AdelleNaz
@shaunasanford
@wandavazquez
@RamonaWritesLA
@BrookingsInst
@timcraigpost
@ASAEcenter

Impressions 168
times people saw this Tweet on Twitter

Total engagements 5
times people interacted with this Tweet



:Darrell-James: Hill, :Ohioan- beneficiary-Executor-Procurator, -:mitigation of the Trustee-derelict- damages: Twitter: September 24th, 2020, 7:05 p.m. - :March 9, 2021, 3:35 p.m.

December 13, 2020 5:09 p.m.

Darrell James hill
[@DarBenThu1](#)
Please Help With This For:
[@DarBenThu1](#)
[@DiamondandSilk](#)
[@chrispavlovski](#)
[@newsmax](#)
[@DanForestNC](#)
[@ChatDitPlatform](#)
[@SecretaryCarson](#)
[@RudyGiuliani](#)
[@PressSec](#)
[@JudgeJeanine](#)
[@MariaBartiromo](#)
[@MariaBartiromo](#)
[@TrumpGolf](#)
[@mschlapp](#)
[@BlackVoices4DJT](#)
[@WhiteHouse](#)
[@pnjaban](#)
[@TomFitton](#)

Quote Tweet



Darrell James hill
[@DarBenThu1](#)

This [@DarBenThu1](#) is for :remedy against theft by :Donald-John: Trump, -:POTUS-corp, -:Trustee, et al.-. These 'Bill of Particulars' rendered are required for the agreed-upon :penalty-compensation until the stolen property is restored :in- specie. See: <https://blackandbluesoulsmatter.wordpress.com/2020/11/12/bill-of-particulars-lot-1-2-and-3-of-3-rendered-to-donald-john-trump-due-paid-now/>

Show this thread
5:09 PM · Dec 13, 2020 · Twitter Web App

December 13, 2020 Darrell James hill
[@DarBenThu1](#)

:Executor-Procurator, -:mitigation of the Trustee-derelict- damages ~

2022-011769 MISC Page: 2371 of 2782
09/26/2022 09:35:37 PM Receipt #: 22-9381
Reg. Fee: \$30.00 Darrell James Hill
Gila County, Az, Sadie Jo Bingham, Recorder



Official Copy

2/6/2
2/6/2

2/6/2

09/26/2022 03:35:37 PM Receipt #: 22-9381
Rec Fee: \$30.00 Darrell James Hill
Gila County, Az, Sadie Jo Bingham, Recorder



Darrell James hill on Twitter: "Please Help With This For: @DarBenThu1 @DiamondandSilk @chrispavlovski @newsmax @DanForestNC @ChatDitPlatform @SecretaryCarson @RudyGiuliani @PressSec @JudgeJeanine @MariaBartiromo @MariaBartir...

File Edit View History Bookmarks Tools Help

Ms All Mail - djhill X New Tab Onkyo receive X Apache Jundr X WunderMap X Inbox (107) X Total Fraise - Y X Darrell James I X b-1020-Intro-t X a-2020-09-20 X New Tab

https://twitter.com/DarBenThu1/status/1338274928433381376/analytics 150% i'll never be more loved

Getting Started EXECUTIVE ORDERS REF COMMERCE DAVID STRAIGHTERS AJ

Tweet Analytics

Darrell James hill @DarBenThu1
Please Help With This For: @DarBenThu1
@DiamondandSilk
@chrispavlovski
@newsmax
@DanForestNC
@ChatDitPlatform
@SecretaryCarson
@RudyGiuliani
@PressSec
@JudgeJeanine
@MariaBartiromo
@MariaBartiromo
@TrumpGolf
@mschlapp
@BlackVoices4DJT
@WhiteHouse
@pnjaban
@TomFitton <https://twitter.com/DarBenThu1/status/1326794848029040641> ...

Impressions 171
times people saw this Tweet on Twitter

Messages

Tuesday November 9, 21:56

:Darrell-James: Hill, :Ohioan- beneficiary-Executor-Procurator, -:mitigation of the Trustee-derelict- damages: Twitter: September 24th, 2020, 7:05 p.m. - :March 9, 2021, 3:35 p.m.

5:12 p.m.

Please Help With This For:

- [@DarBenThu1](#)
- [@kinguilfoyle](#)
- [@WomenforTrump](#)
- [@GovMikeHuckabee](#)
- [@JoeTalkShow](#)
- [@dbongino](#)
- [@POTUS](#)
- [@Mike_Pence](#)
- [@RSBNetwork](#)
- [@EricTrump](#)
- [@DonaldJTrumpJr](#)
- [@EricTrump](#)
- [@MELANIATRUMP](#)
- [@IvankaTrump](#)
- [@realDonaldTrump](#)
- [@ChatDitPlatform](#)
- [@SecretaryCarson](#)
- [@RudyGiuliani](#)
- [@PressSec](#)

Quote Tweet



Darrell James hill
[@DarBenThu1](#)

This [@DarBenThu1](#) is for :remedy against theft by :Donald-John: Trump, -:POTUS-corp, -:Trustee, et al.-. These 'Bill of Particulars' rendered are required for the agreed-upon :penalty-compensation until the stolen property is restored :in- specie. See: <https://blackandbluesoulsmatter.wordpress.com/2020/11/12/bill-of-particulars-lot-1-2-and-3-of-3-rendered-to-donald-john-trump-due-paid-now/>

Show this thread

5:12 PM · Dec 13, 2020 · Twitter Web App

December 14,
2020
2:38 a.m.



Darrell James hill

:Executor-Procurator, -:mitigation of the Trustee-derelict- damages ~

75 / 206

2022-011769 MISC Page: 2373 of 2782
 09/26/2022 03:35:37 PM Receipt #: 22-9381
 Rec Fee: \$30.00 Darrell James Hill
 Gila County, Az, Sadie Jo Bingham, Recorder

2163

2164

Official Copy

:Darrell-James: Hill, :Ohioan- beneficiary-Executor-Procurator, -:mitigation of the Trustee-derelict- damages: Twitter: September 24th, 2020, 7:05 p.m. - :March 9, 2021, 3:35 p.m.

@DarBenThu1

You've got to here this: Powerful speech by Dr. Arikana Chihombori to Africans (African Diaspora Media and Content Creators)



youtube.com

Powerful speech by Dr. Arikana Chihombori to Africans (African...

LIKE ,SHARE AND SUBSCRIBE.THANKS FOR WATCHING!#PanAfricanDTV

#DrArikana

2:38 AM · Dec 14, 2020 · Twitter Web App

**December 14,
2020
3:50 a.m.**

Darrell James hill

@DarBenThu1

You've Got to hear this: Timothy E. McPherson on the new currency -the Lumi- and elimination of Debt in Africa

*2164
2165*

:Executor-Procurator, -:mitigation of the Trustee-derelict- damages ~

76 / 206

2022-011769 MISC Page: 2374 of 2782
09/26/2022 03:35:37 PM Receipt #: 22-9981
Rec Fee: \$30.00 Darrell James Hill
Gila County, Az, Sadie Jo Bingham, Recorder



09/26/2022 03:35:37 PM Receipt #: 22-9381
Rec Fee: \$30.00 Darrell James Hill
Gila County, Az, Sadie Jo Bingham, Recorder



Darrell James Hill on Twitter: Please Help With This For: @DarBenThu1
Mike Huckabee @JoeTalkShow @dbongino @POTUS @Mike_Pence @RSBNetwork @EricTrump @DonaldJTrumpJr @EricTrump @MELANIATRUMP

File Edit View History Bookmarks Tools Help

All Mail - djhill x New Tab x Onkyo receiver x Apache Junda x WunderMap x Inbox (107) - c x Total Fraise x Darrell James f x b-1020-intro-t x a-2020-09-20 x New Tab x

https://twitter.com/DarBenThu1/status/1338275662231031811/analytics 150% I'll never be more loved

Getting Started EXECUTIVE ORDERS REF COMMERCE DAVID STRAIGHTERS AJ

← Tweet

@MELANIATRUMP

@IvankaTrump

@realDonaldTrump

@ChatDitPlatform

@SecretaryCarson

@RudyGiuliani

@PressSec

Darrell James Hill

This @DarBenThu1

-POTUS-corp. -M

for the agreed-upon

in-specie. See: b1

3:12 PM · Dec 13, 2021

View Tweet activity

Tweet Analytics

Darrell James Hill @DarBenThu1

Please Help With This For: @DarBenThu1

@kinguilfoyle

@WomenforTrump

@GovMikeHuckabee

@JoeTalkShow

@dbongino

@POTUS

@Mike_Pence

@RSBNetwork

@EricTrump

@DonaldJTrumpJr

@EricTrump

@MELANIATRUMP

@IvankaTrump

@realDonaldTrump

@ChatDitPlatform

@SecretaryCarson

@RudyGiuliani

@PressSec <https://twitter.com/DarBenThu1/status/1326794848029040641> ...

Impressions 173

times people saw this Tweet on Twitter

home 4 women who support

agenda

smart, independent women.

opening

te airing on ABC

ture today!

today

f told to report

fes as 'Smurfs'

Messages

09/26/2022 03:35:37 PM Receipt #: 22-9381
Rec/Fee: \$30.00 Darrell James Hill
Gila County, Az, Sadie Jo Bingham, Recorder



Darrell James hill on Twitter: "You've got to here this: Powerful speech by Dr. Arikana Chihombori to Africans (African Diaspora Media and Content Creators) https://www.youtube.com/watch?v=EpTgdoO46ZI" / Twitter - Mozilla Firefox

File Edit View History Bookmarks Tools Help

All Mail - djhill X New Tab X Onlyo receiver X Apache Junction X WunderMapG X Inbox (107) X Total Prize - Y X Darrell James Hill X b-1020-intro-t X a-2020-09-20 X New Tab X

https://twitter.com/DarBenThu1/status/1338418058981871616/analytics 150%

Getting Started EXECUTIVE ORDERS REF COMMERCE DAVID STRAIGHTERS AJ

Tweet

Darrell James Hill @DarBenThu1

You've got to here this: Powerful speech by Dr. Arikana Chihombori to Africans (African Diaspora Media and Content Creators) https://www.youtube.com/watch?v=EpTgdoO46ZI ...

2:38 AM · Dec 14, 2021

11 Views · Tweet active

Tweet your reply

Tweet Analytics

Darrell James Hill @DarBenThu1

You've got to here this: Powerful speech by Dr. Arikana Chihombori to Africans (African Diaspora Media and Content Creators) https://www.youtube.com/watch?v=EpTgdoO46ZI ...

Impressions	175
times people saw this Tweet on Twitter	
Media views	1
all views (autoplay and click) of your media are counted across videos, vines, gifs, and images	
Total engagements	3
times people interacted with this Tweet	

View all engagements

People

James Hill @DarBenThu1

Ysrael, -civilian, -Ohtooan, -iciary; DOI-1776-A.D., 33-A.D.; Amb. of Yushuah to n-redeemer/ Ysrael & trustee; sion-1213-A.D.

opening

teaffing on ABC

future today!

maBacon

09/26/2022 03:35:37 PM Receipt #: 22-9381
Rec Fee: \$30.00 Darrell James Hill
Gila County, Az, Sadie Jo Bingham, Recorder



Darrell James Hill on Twitter: You've Got to hear this: Timothy E. McPherson on the new currency -the Lumi- and elimination of Debt in Africa https://www.youtube.com/watch?v=w6FRipSXJEY ...

File Edit View History Bookmarks Tools Help

https://twitter.com/DarBenThu1/status/1338435125027753985/analytics

Getting Started EXECUTIVE ORDERS REF COMMERCE DAVID STRAIGHTERS AJ

Tweet

Darrell James Hill @DarBenThu1

You've Got to hear this: Timothy E. McPherson on the new currency -the Lumi- and elimination of Debt in Africa

3:50 AM Dec 14, 2021

1 Retweet 1 Like

Tweet Analytics

Darrell James Hill @DarBenThu1
You've Got to hear this:
Timothy E. McPherson on the new currency -the Lumi- and elimination of Debt in Africa https://www.youtube.com/watch?v=w6FRipSXJEY ...

Impressions times people saw this Tweet on Twitter	219
Total engagements times people interacted with this Tweet	9

View all engagements

Promote your Tweet

People

James Hill @DarBenThu1

Ysrael, -civilian, -Ohioan, -Indiana, DOI-1776-A.D., 1776-1783-A.D.; Amb. of Yushuah to the United States; Trustee of the Ysrael Trust; Ysrael-1213-A.D.

opening

tearing on ABC

future today!

min Bloom

:Darrell-James: Hill, :Ohioan- beneficiary-Executor-Procurator, -:mitigation of the Trustee-derelict- damages: Twitter: September 24th, 2020, 7:05 p.m. - :March 9, 2021, 3:35 p.m.

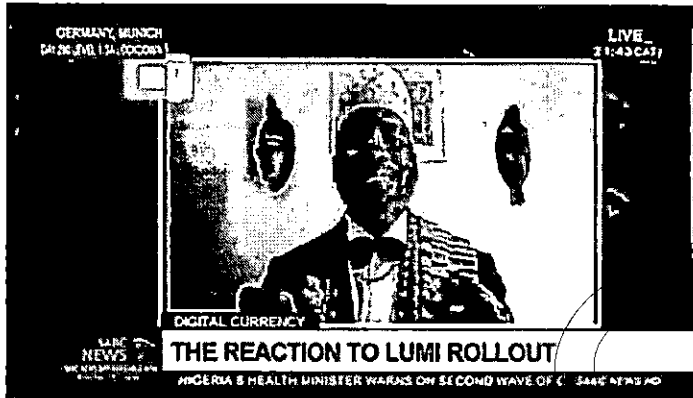

youtube.com
Timothy E. McPherson on the new currency -the Lumi- and elimination...
The Lumi, a new currency from a small village in western Jamaica could help countries in the Caribbean, Africa, and the Diaspora realise their economic and s...
3:50 AM · Dec 14, 2020 · Twitter Web App

December 14, 2020 11:30 p.m.
Darrell James hill
[@DarBenThu1](#)
For the tough job with allegiance mix :William-Pelham. Thank-you. Shalom. <https://twitter.com/realDonaldTrump/status/1338614514493878273>

This Tweet is from a suspended account. [Learn more](#)
11:30 PM · Dec 14, 2020 · Twitter Web App

December 15, 2020 9:16 a.m.



Darrell James hill
[@DarBenThu1](#)
You've gotta hear this judge detail USAG Barr's doings Judge Jeanine rips Bill Barr a New One

:Executor-Procurator, -:mitigation of the Trustee:

2022-011769 MISC Page: 2378 of 2782
09/26/2022 03:35:37 PM Receipt #: 22-9381
Rec Fee: \$30.00 Darrell James Hill
Gila County, Az, Sadie Jo Bingham, Recorder



Handwritten notes: 2/16/21, 2/16/21

:Darrell-James: Hill, :Ohioan- beneficiary-Executor-Procurator, -:mitigation of the Trustee-derelict- damages: Twitter: September 24th, 2020, 7:05 p.m. - :March 9, 2021, 3:35 p.m.



youtube.com
Judge Jeanine rips Bill Barr a New One - Opening Statement
Judge Jeanine Pirro reacts to Attorney General Barr's comments on the election. Judge Jeanine Pirro NEW Opening Statement here ->
<https://youtu.be/NQjEyLENOJw#J...>
9:16 AM · Dec 15, 2020 · Twitter Web App

December 16,
2020
12:58 a.m.

Darrell James hill
[@DarBenThu1](#)
You gotta hear :Michael Richard Pompeo -- BREAKING NEWS TODAY: THIS IS TRAGEDY



youtube.com
BREAKING NEWS TODAY: THIS IS TRAGEDY

:Executor-Procurator, -:mitigation of the Trustee-derelict- damages ~

78 / 206

2170

2022-011769 MISC Page: 2379 of 2782
 09/25/2022 03:35:37 PM Receipt #: 22-9381
 Rec Fee: \$30.00 Darrell James Hill
 Giles County, Az, Sadie Jo Birmingham, Recorder



2171 21426

Darrell James hill on Twitter: "For the tough job with allegiance mix :William-Pelham. Thank-you. Shalom." / Twitter - Mozilla Firefox

File Edit View History Bookmarks Tools Help

https://twitter.com/DarBenThu1/status/1338733177045585921/analytics

Getting Started EXECUTIVE ORDERS REF COMMERCE DAVID STRAIGHTERS AJ

Tweet Analytics

Darrell James hill @DarBenThu1
 For the tough job with allegiance mix :William-Pelham. Thank-you. Shalom.
[https://twitter.com/realDonaldTrump/status/1338614514493878273 ...](https://twitter.com/realDonaldTrump/status/1338614514493878273)

Impressions	160
times people saw this Tweet on Twitter	
Total engagements	3
times people interacted with this Tweet	

[View all engagements](#)

Promote your Tweet
 Your Tweet has 160 total impressions so far.
 Get more impressions on this Tweet!

people
 Jameshill
 anThu1
 Ysrael, -civilian, -Ohioan.
 tclary, DOH1776-A.D.,
 33-A.D., Amb. of Ysruah to
 n-redeemer/ Ysrael & Trustee:
 sion-1213-A.D.

pening
 teating on ABC
 ure today!
 m: Bacon

messages

Tuesday November 9, 21:55



Darrell James hill on Twitter: "You've gotta hear this judge detail USAG Barr's doings Judge Jeanine rips Bill Barr a New One https://t.co/g1dHNUKJXw" / Twitter - Mozilla Firefox

File Edit View History Bookmarks Tools Help

All Mail - djhill X New Tab X Onkyo receive X Apache Juncti X WunderMap X Inbox (107) X Total Praise: Y X Darrell James I X b-1020-Intro X a-2020-09-20 X New Tab X

https://twitter.com/DarBenThu1/status/1338880651240431616/analytics 150%

Getting Started EXECUTIVE ORDERS REF COMMERCE DAVID STRAIGHTERS AJ

Tweet

Darrell James hill @DarBenThu1

You've gotta hear this judge detail USAG Barr's doings Judge Jeanine rips Bill Barr a New One https://www.youtube.com/watch?v=bS9zhXygp2U ...

9:16 AM - Dec 15, 2021

View Tweet activity

Tweet Analytics

Darrell James hill @DarBenThu1
You've gotta hear this judge detail USAG Barr's doings Judge Jeanine rips Bill Barr a New One https://www.youtube.com/watch?v=bS9zhXygp2U ...

Impressions	157
times people saw this Tweet on Twitter	
Total engagements	1
times people interacted with this Tweet	

[View all engagements](#)

Promote your Tweet
Your Tweet has 157 total impressions so far.

people

James hill
BenThu1

Ysrael, -civilian, -Ohtoban,
ticiary: DOI-1776-A.D.,
33-A.D.; Amb. of YUshuahito
n-redeemer/ Ysrael & Trustee
sion-1213-A.D.

pening

ago
te airing on ABC
nn, Bella

ture today!
min Bloom

messages



Darrell James Hill on Twitter: You gotta hear :Michael Richard Pompeo -- BREAKING NEWS TODAY: THIS IS TRAGEDY https://t.co/B94T7GnVII / Twitter - Mozilla Firefox

File Edit View History Bookmarks Tools Help

All Mail - djhill X New Tab X Onkyo receive X Apache Juncos X WunderMap X Inbox (107) - c X Total Praise - Y X Darrell James Hill X b-1020-intro-t X a-2020-09-20 X New Tab X

https://twitter.com/DarBenThu1/status/1339117777857089537/analytics 150% I'll never be more loved

Getting Started EXECUTIVE ORDERS REF COMMERCE DAVID STRAIGHTERS AJ

Tweet Analytics

Darrell James Hill @DarBenThu1
You gotta hear :Michael Richard Pompeo --
BREAKING NEWS TODAY: THIS IS TRAGEDY
[https://www.youtube.com/watch?v=lf_Ght_rsmg ...](https://www.youtube.com/watch?v=lf_Ght_rsmg...)

Impressions	175
times people saw this Tweet on Twitter	
Media views	1
all views (autoplay and click) of your media are counted across videos, vines, gifs, and images	
Total engagements	1
times people interacted with this Tweet	

[View all engagements](#)

12:58 AM · Dec 16, 2021

View Tweet activity

Messages

Tuesday November 9, 21:55

:Darrell-James: Hill, :Ohioan- beneficiary-Executor-Procurator, -:mitigation of the Trustee-derelict- damages: Twitter: September 24th, 2020, 7:05 p.m. - :March 9, 2021, 3:35 p.m.

Breaking news update today December 12, 2020. United States Secretary of State Mike Pompeo deliver remarks.#Breaking #News #TodayUS Military News 2020 12:58 AM · Dec 16, 2020·Twitter Web App

December 21, 2020 6:19 p.m. Darrell James hill @DarBenThu1 @WomenforTrump @dbongino @POTUS @Mike_Pence @RSBNetwork @DonaldJTrumpJr @EricTrump @MELANIATRUMP @IvankaTrump @realDonaldTrump @PressSec

Mario-Jorge: Bergoglio is the pope and potentate over the 'Roman'- X-etc.; not over the 'Holy-Church' -":Christians"/Ysrael. :Darrell-James. 6:19 PM · Dec 21, 2020·Twitter Web App

December 22, 2020 9:41 a.m.



Darrell James hill @DarBenThu1

Replying to @DarBenThu1

1) The :man- Mario-Jorge: Bergoglio is no longer the Trustee: Concession-1213-A.D. 2) There is no 'vicar' of Yushuah the Messiah, Creator, who died for man-kind 3) Roman- X(=anything) is a proprietary-doctrine, and 4) is Not synonymous with :Almighty-God's will. Really! Ask God

December 22, 2020 12:21 p.m. Darrell James hill @DarBenThu1 @WomenforTrump @dbongino @POTUS @Mike_Pence @RSBNetwork

:Executor-Procurator, -:mitigation of the Trustee-derelict- damages ~

79 / 206

2022-011769 MISC Page: 2383 of 2782

09/26/2022 03:35:37 PM Receipt #: 22-9381
Darrell James Hill
Gila County, Az, Sadie Jo Bingham, Recorder



2172
2173

:Darrell-James: Hill, :Ohioan- beneficiary-Executor-Procurator, -:mitigation of the Trustee-derelict- damages: Twitter: September 24th, 2020, 7:05 p.m. - :March 9, 2021, 3:35 p.m.

@DonaldJTrumpJr
@EricTrump
@MELANIATRUMP
@IvankaTrump
@realDonaldTrump
@PressSec

Hello :Donald-John. :i- man am grieving for the people of China; NOT CCP-focused. If you can help feed them it will matter; if you can, do.

12:21 PM · Dec 22, 2020 · Twitter Web App

1

Retweet

Replying to

@DarBenThu1

China's Food Crisis <https://youtube.com/watch?v=XO-XIbDqKAA>

Please do not allow the extreme starvation to recur. We both know they did not synthesize the C-19 virus alone. And, value for the people can only come from you now. Make this humility :count, and save face please.

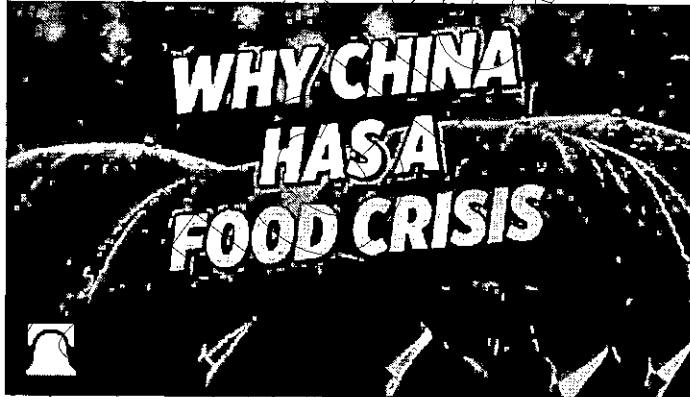

youtube.com

China's Food Crisis

For the past 18 months, China's farm and agriculture sectors have been pummeled by two different infestations. The fall armyworm is an invasive, omnivorous ...



Darrell James hill

@DarBenThu1

2174
2172W

:Executor-Procur

2022-011769 MISC Page: 2384 of 2782

09/26/2022 03:35:37 PM Receipt #: 22-9381

Rec Fee: \$30.00 Darrell James Hill

Gila County, Az, Sadie Jo Bingham, Recorder





Thread
of China; NO
them it will m
12:21 PM · Dec 22, 2
View Tweet activity
1 Retweet

Darrell James Hill
Replying to
China's Foo
youtube.co
Please do n
did not synt
come from you now. Make this humility count, and save face please.

Search Twitter
Follow
Nandini Jamnani Ongoing
pening
tearing on ABC
Trending
This morning
messages

Tweet Analytics

Darrell James Hill @DarBenThu1
@WomenforTrump
@dbongino
@POTUS
@Mike_Pence
@RSBNetwork
@DonaldJTrumpJr
@EricTrump
@MELANIATRUMP
@IvankaTrump
@realDonaldTrump
@PressSec

Hello :Donald-John. :- man am grieving for the people of China; NOT CCP-focused. If you can help feed them it will matter; if you can, do.

Impressions	185
times people saw this Tweet on Twitter	
Total engagements	10
times people interacted with this Tweet	

Tuesday November 9, 21:53



Thread

@PressSec

Mario-Jorge: the 'Roman' - 'Christians'

6:19 PM · Dec 21, 2021

1 Retweet 1 Like

Tweet by Darrell James Hill

Replying to Darrell James Hill

1) The man- Mario-Jorge Bergoglio no longer the trusted, concession- 1213-A.D. 2) There is no 'vicar' of Yushuah (the Messiah, Creator, who died

Tweet Analytics

Darrell James Hill @DarBenThu1

@WomenforTrump
@dbongino
@POTUS
@Mike_Pence
@RSBNetwork
@DonaldJTrumpJr
@EricTrump
@MELANIATRUMP
@IvankaTrump
@realDonaldTrump
@PressSec

Mario-Jorge: Bergoglio is the pope and potentate over the 'Roman' - X-etc., not over the 'Holy-Church' - 'Christians' / Ysrael. :Darrell-James.

Impressions 165
times people saw this Tweet on Twitter

Total engagements 5
times people interacted with this Tweet

Follow

Nandini Jammis Ongoing

pening

ago

to airing on ABC

future today!

min Bloom

messages

09/26/2022 03:35:37 PM Receipt #: 22-9381
Rec Fee: \$30.00 Darrell James Hill
Gila County, Az, Sadie Jo Bingham, Recorder



Darrell James Hill on Twitter: "1) The man- Mario-Jorge: Bergoglio is no longer the Trustee: Concession-1213-A.D. 2) There is no 'vicar' of Yushuah the Messiah, Creator, who died for man-kind. 3) Roman- X(=anything) is a proprietary doctrine, and 4) is Not synonymous with :Almighty-God's will. Really! Ask God"

File Edit View History Bookmarks Tools Help

Mr All Mail - djhill X New Tab X Onlyo receiver X Apache Junit X WunderMap X Inbox (107) X Total Prase X Darrell James Hill X b-1020-Intro X a-2020-09-20 X New Tab X

https://twitter.com/DarBenThu1/status/1341423528621481984/analytics

Getting Started EXECUTIVE ORDERS REF COMMERCE DAVID STRAIGHTERS AJ

Thread

1) The man- (Trustee: Concession-1213-A.D. 2) There is no 'vicar' of Yushuah the Messiah, Creator, who died for man-kind. 3) Roman- X(=anything) is a proprietary doctrine, and 4) is Not synonymous with :Almighty-God's will. Really! Ask God

9:41 AM · Dec 22, 2021

View Tweet activity

Tweet your thoughts

Messages

Tuesday November 9, 21:54

Tweet Analytics

Darrell James Hill @DarBenThu1

1) The man- Mario-Jorge: Bergoglio is no longer the Trustee: Concession-1213-A.D. 2) There is no 'vicar' of Yushuah the Messiah, Creator, who died for man-kind. 3) Roman- X(=anything) is a proprietary doctrine, and 4) is Not synonymous with :Almighty-God's will. Really! Ask God

Impressions 156

times people saw this Tweet on Twitter

Promote your Tweet

Your Tweet has 156 total impressions so far. Get more impressions on this Tweet!

Promote your Tweet

09/28/2022 03:35:37 PM Receipt #: 22-9381
Rep/Fee: \$30.00 Darrell James Hill
Gila County, Az, Sadie Jo Bingham, Recorder



Darrell James Hill on Twitter: "@WomenforTrump @dbongino @POTUS @Mike_Pence @RSBNetwork @DonaldJTrumpJr @EricTrump @MELANIATRUMP @IvankaTrump @realDonaldTrump @PressSec Hello :Donald-John. :- man am grieving for the p..."

File Edit View History Bookmarks Tools Help

All Mail - djh1 X New Tab X Onlyo receiver X ApacheJunct X WunderMap X M. Inbox (107) - d X Total Prabe - Y X Darrell James f X b-1020-intro-t X a-2020-09-20 X New Tab X

https://twitter.com/DarBenThu1/status/1341463972541677570/analytics 100% ...

Getting Started EXECUTIVE ORDERS REF COMMERCE DAVID STRAIGHTERS AJ

Thread

of China; NO them it will m

12:21 PM · Dec 22, 2020

View Tweet activity

1 Retweet

Tweet by Darrell James Hill

Replying to China's Focus

Please do not spread rumors. I did not synthesize the COVID-19 virus alone. And, value for the people can only

messages

Follow

g Nandini Jammif's Ongoing

pening

te afting on ABC

ture today!

Chiccano

Tuesday November 9, 21:54

Tweet Analytics

Darrell James Hill @DarBenThu1

@WomenforTrump
@dbongino
@POTUS
@Mike_Pence
@RSBNetwork
@DonaldJTrumpJr
@EricTrump
@MELANIATRUMP
@IvankaTrump
@realDonaldTrump
@PressSec

Hello :Donald-John. :- man am grieving for the people of China; NOT CCP-focused. If you can help feed them it will matter; if you can, do.

Impressions 187
times people saw this Tweet on Twitter

Total engagements 10
times people interacted with this Tweet

:Darrell-James: Hill, :Ohioan- beneficiary-Executor-Procurator, -:mitigation of the Trustee-derelict- damages: Twitter: September 24th, 2020, 7:05 p.m. - :March 9, 2021, 3:35 p.m.

COPY

December 22, 2020
12:27 p.m.

Darrell James hill
[@DarBenThu1](#)

China's Food Crisis <https://youtube.com/watch?v=XQ-XIbDqKAA>
Please do not allow the extreme starvation to recur. We both know they did not synthesize the C-19 virus alone. And, value for the people can only come from you now. Make this humility :count, and save face please.



youtube.com
China's Food Crisis
For the past 18 months, China's farm and agriculture sectors have been pummeled by two different infestations. The fall armyworm is an invasive, omnivorous ...

December 23, 2020
12:58 p.m.

Darrell James hill
[@DarBenThu1](#)

You gotta see the flavor of this 2" short: Long-Trailer2-Layman Title from from 'shoun hill' ~ https://twitter.com/search?q=shoun%20hill&src=typed_query
<https://vimeo.com/482194791> ~

:Executor-Procurator, -:mitigation of the Trustee-derelict- damages ~

81 / 206

2022-011769 MISC Page: 2389 of 2782
09/26/2022 03:35:37 PM Receipt # 22-9381
Rec/Fee: \$30.00 Darrell James Hill
Gila County, Az, Sadie Jo Birmingham, Recorder

7/78
2/79

:Darrell-James: Hill, :Ohioan- beneficiary-Executor-Procurator, -:mitigation of the Trustee-derelict- damages: Twitter: September 24th, 2020, 7:05 p.m. - :March 9, 2021, 3:35 p.m.



vimeo.com

Trailer 2.mp4

This is "Trailer 2.mp4" by shoun hill on Vimeo, the home for high quality videos and the people who love them.

December 24,
2020
10:13 a.m.



Darrell James hill

@DarBenThu1

Black Doctor Dies of Covid-19 After Complaining of Racist Treatment

[https://nytimes.com/2020/12/23/us/susan-moore-black-doctor-indiana.html?](https://nytimes.com/2020/12/23/us/susan-moore-black-doctor-indiana.html?smid=tw-share)

[smid=tw-share](https://nytimes.com/2020/12/23/us/susan-moore-black-doctor-indiana.html?smid=tw-share)

"If you want to fight, now is the time to fight," he recalled telling her. "But if you need to go, I understand." Two days later, Dr. Moore's heart stopped beating.

2179
2100

:Executor-Procurator, -:mitigation of the Trustee-derelict- damages ~

82 / 206

2022-011769 MISC Page: 2390 of 2782
09/26/2022 03:35:37 PM Receipt #: 22-9381
Rec Fee: \$30.00 Darrell James Hill
Gila County, Az, Sadie Jo Bingham, Recorder





Darrell James Hill on Twitter: China's Food Crisis <https://www.youtube.com/watch?v=XQ-XIbDqKAA...> Please do not allow the extreme starvation to recur. We both know they did not synthesize the C-19 virus alone. And, value for the people can only come from you now. Make ...

File Edit View History Bookmarks Tools Help

All Mail - d... X New Tab X Onkyo receive... X Apache Junct... X WunderMapS... X Inbox (107) - c... X Total Prase - Y... X Darrell James i... X b-1020-Intro... X a-2020-09-20... X New Tab X +

https://twitter.com/DarBenThu1/status/134146548874897410/analytics 150%

Getting Started EXECUTIVE ORDERS REF COMMERCE DAVID STRAIGHTERS AJ

Thread

China's Food Crisis

Please do not allow the extreme starvation to recur. We both know they did not synthesize the C-19 virus alone. And, value for the people can only come from you now. Make this humility count, and save face please.

WHY CHINA HAS A FOOD CRISIS

12:27 PM · Dec 22, 2021

View Tweet activity

Messages

Tuesday November 9, 21:54

Tweet Analytics

Darrell James Hill @DarBenThu1
China's Food Crisis
<https://www.youtube.com/watch?v=XQ-XIbDqKAA...>

Please do not allow the extreme starvation to recur. We both know they did not synthesize the C-19 virus alone. And, value for the people can only come from you now. Make this humility count, and save face please.

Impressions	177
times people saw this Tweet on Twitter	
Total engagements	4
times people interacted with this Tweet	

[View all engagements](#)



Darrell James hill on Twitter: "You gotta see the flavor of this 2" short: Long-Trailer2-Layman Title from from 'shoun hill' - https://t.co/blyfsEmAsf https://t.co/pZ1xpfgelJ -" / Twitter - Mozilla Firefox

File Edit View History Bookmarks Tools Help

All Mail - d... X New Tab X Onkyo receive X Apache J... X WunderMap8 X M Inbox (107) - c X Total Praise X Darrell James Hill X b-1020-intro-t X a-2020-09-20 X New Tab X

https://twitter.com/DarBenThu1/status/1341865735769870336/analytics 150% i'll never be more loved

Getting Started EXECUTIVE ORDERS REF COMMERCE DAVID STRAIGHTERS AJ

Thread

You gotta see Layman Title

/search?q=shoun hill

vimeo.com/482194791

2:53 PM Dec 23, 2021

View Tweet

Tweet your

Tweet Analytics

Darrell James hill @DarBenThu1
You gotta see the flavor of this 2" short: Long-Trailer2-Layman Title from from 'shoun hill' - https://twitter.com/search?q=shoun%20hill&src=typed_query ...
https://vimeo.com/482194791

Impressions	166
times people saw this Tweet on Twitter	
Total engagements	2
times people interacted with this Tweet	

[View all engagements](#)

Promote your Tweet
Your Tweet has 166 total impressions so far.

people

James Hill
Darrell James Hill
Israel, -civilian, -Ontario,
vicinity: DOI-1776-A.D.,
33-A.D.; Amb. of Yushuah to
n-redeemer/ Ysrael & Trustees
sion-1213-A.D.

opening

te airing on ABC

ture today!
min Bloom

messages

Tuesday November 9, 21:53

Darrell James Hill on Twitter: "Black Doctor Dies of Covid-19 After Complaining of Racist Treatment" <https://www.nytimes.com/2020/12/23/us/susan-moore-black-doctor-indiana.html?smid=tw-share> "If you want to fight, now is the time to fight," he recalled telling her. "But if you need to go, I understand." Two days later, Dr. Moore's heart stopped beating.

File Edit View History Bookmarks Tools Help

All Mail - djhill X New Tab X Onkyo receive X Apache Junct X WunderMap X Inbox (107) X Total Praise - V X Darrell James Hill X b-1020-Intro-t X e-2020-09-20 X New Tab X

← → ↻ 🏠 <https://twitter.com/DarBenThu1/status/1342156419244539904/analytics> 150% 🔍 I'll never be more loved

Getting Started EXECUTIVE ORDERS REF COMMERCE DAVID STRAIGHTERS AJ

nytimes.com

Black Doctor Dies

"He made me feel like a doctor of downpla

10:13 AM · Dec 24, 2

View Tweet activity

1 Quote Tweet

Tweet yo

Tweet Analytics

Darrell James Hill @DarBenThu1

Black Doctor Dies of Covid-19 After Complaining of Racist Treatment

<https://www.nytimes.com/2020/12/23/us/susan-moore-black-doctor-indiana.html?smid=tw-share> ...

"If you want to fight, now is the time to fight," he recalled telling her. "But if you need to go, I understand."

Two days later, Dr. Moore's heart stopped beating.

Impressions 336

times people saw this Tweet on Twitter

Total engagements 2

times people interacted with this Tweet

View all engagements

Search Twitter

min Bloom

Earlier today

Just Got Wedding Photos

coming

ence on edys 'My heart is

States

Privacy Policy · Cookie Policy

©2021 Twitter, Inc.

Messages



Search 2020. APIJECT - THE COMP THAT VACS AND CHIPS YOU. Will They Put a CHIP in the Coronavirus Vaccine? <https://t.co/IZAMBTz0T3> / Twitter - Mozilla Firefox

File Edit View History Bookmarks Tools Help

All Mail - djhill X New Tab X Onkyo receiver X Apache Junct X WunderMap X Inbox (107) X Total Praise X Darrell James X b-1020-intro X a-2020-09-20 X New Tab X

https://twitter.com/DarBenThu1/status/1343024544651509761/analytics 150% fill never be more loved

Getting Started EXECUTIVE ORDERS REF COMMERCE DAVID STRAIGHTERS AJ

Tweet

Darrell James Hill @DarBenThu1

Is this really happening? 2020. APIJECT - THE COMP THAT VACS AND CHIPS YOU.

Will They Put a CHIP in the Coronavirus Vaccine?

7:42 PM · Dec 26, 2020

View Tweet activity

Tweet Analytics

Darrell James Hill @DarBenThu1
Is this really happening? 'gotta know this too! March 2020.
APIJECT - THE COMP THAT VACS AND CHIPS YOU.

Will They Put a CHIP in the Coronavirus Vaccine?
<https://www.youtube.com/watch?v=IGJjE6a0Nxc> ...

Impressions	195
times people saw this Tweet on Twitter	
Total engagements	1
times people interacted with this Tweet	

[View all engagements](#)

Promote your Tweet

people

James Hill
@DarBenThu1
Ysrael, -civilian, -Ohioan,
-vicary; DOI-1776-A.D.;
33-A.D.; Amb. of Yushuah to
n-redeemer/ Ysrael & Trustees
sion-1213-A.D.

opening

tearing on ABC

sure today!

into Bloom

messages

Tuesday November 9, 21:52



:Darrell-James: Hill, :Ohioan- beneficiary-Executor-Procurator, -:mitigation of the Trustee-derelict- damages: Twitter: September 24th, 2020, 7:05 p.m. - :March 9, 2021, 3:35 p.m.



[nytimes.com](https://www.nytimes.com)

Black Doctor Dies of Covid-19 After Complaining of Racist Treatment

"He made me feel like a drug addict," Dr. Susan Moore said, accusing a white doctor of downplaying her complaints of pain and suggesting she should be discharged.

10:13 AM · Dec 24, 2020 · Twitter Web App

December 26,
2020
7:42 p.m.

Darrell James hill
[@DarBenThu1](https://twitter.com/DarBenThu1)

Is this really happening? 'gotta know this too! March 2020. APIJECT - THE COMP THAT VACS AND CHIPS YOU. Will They Put a CHIP in the Coronavirus Vaccine?

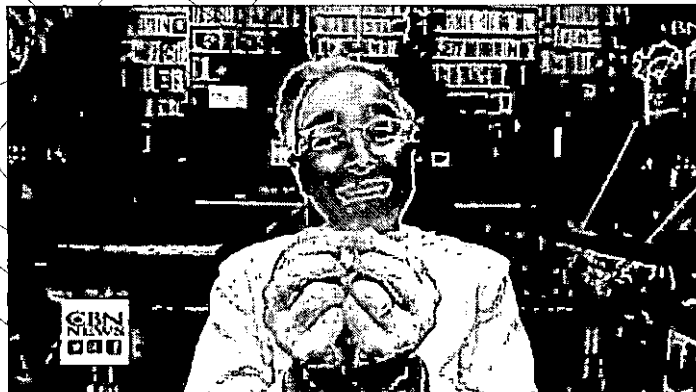

:Executor-Procurator, -:mitigation of the Trustee-derelict- damages ~

83 / 206

2185



:Darrell-James: Hill, :Ohioan- beneficiary-Executor-Procurator, -:mitigation of the Trustee-derelict- damages: Twitter: September 24th, 2020, 7:05 p.m. - :March 9, 2021, 3:35 p.m.

youtube.com
Will They Put a CHIP in the Coronavirus Vaccine?
Conversation about a coronavirus vaccine often includes discussion and speculation about a potential RFID chip placed inside the vaccine itself. Is this poss...
7:42 PM · Dec 26, 2020 · Twitter Web App

December 26, 2020
9:32 p.m.

Darrell James hill
[@DarBenThu1](#)
Did you get paid? Zoom shared US user data with Beijing!
<https://youtube.com/watch?v=KKgyL7ZzZbw>
And, more pestilences....



youtube.com
Worst fear: new outbreaks on the rise across China; Zoom shared US...

 Support the China news you can't find anywhere else. Say NO! to censorship.

Join our new independent platform: EPOCHTV

<http://epochtv.com/chinainfocus00:...>

9:32 PM · Dec 26, 2020 · Twitter Web App

December 30, 2020
7:59 p.m.

Darrell James hill
[@DarBenThu1](#)
Gotta know about this door! Re: ICCPR: -'Non-self-executing' Unalienable-Rights-. DOOR! Law: <http://asil.org/benchbook>. -> p: I. C-1 C. Uses of International Law in U.S. Courts 1. Direct Enforcement of Treaty Provisions 2. Statutory Implementation

:Executor-Procurator, -:mitigation of the Trustee-derelict- damages ~

2186

Tweet

HTMARE TURNS

9:32 PM · Dec 26, 2021

View Tweet activity

Tweet Analytics

Darrell James Hill @DarBenThu1
 Did you get paid?
 Zoom shared US user data with Beijing!
[https://www.youtube.com/watch?v=KKgyL7ZzZbw ...](https://www.youtube.com/watch?v=KKgyL7ZzZbw)
 And, more pestilences....

Impressions times people saw this Tweet on Twitter	154
Total engagements times people interacted with this Tweet	1

[View all engagements](#)

Promote your Tweet

Messages

Tweet Analytics

Darrell James hill @DarBenThu1
'Gotta know about this door!
Re: ICCPR: -Non-self-executing' Unalienable-Rights- DOOR! Law:
<http://www.asil.org/benchbook>
-> p: I. C-1
C. Uses of International Law in U.S. Courts
1. Direct Enforcement of Treaty Provisions
2. Statutory Implementation or Incorp of International Law

Impressions	132
times people saw this Tweet on Twitter	
Total engagements	2
times people interacted with this Tweet	

[View all engagements](#)

7:59 PM · Dec 30, 2021

View Tweet activity

Tweet your reply

messages

Tuesday November 9, 21:52



:Darrell-James: Hill, :Ohioan- beneficiary-Executor-Procurator, -:mitigation of the Trustee-derelict- damages: Twitter: September 24th, 2020, 7:05 p.m. - :March 9, 2021, 3:35 p.m.

or Incorp of International Law
7:59 PM · Dec 30, 2020 · Twitter Web App

January 1,
2021
7:54 a.m.

Darrell James hill
[@DarBenThu1](#)

Gotta get to know this!...? e.g., your "unalienable rights" = Decl of Indep for 'man'? So, how? Ans. MUST 'execute' THE 'ICCPR', i.e., state the claim to ID your rights. Yep. Really. America Natural Common Rights what is transpiring with the Government

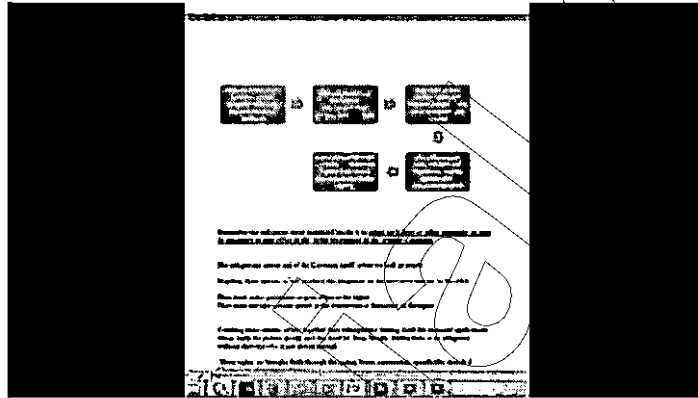

youtube.com
America Natural Common Rights what is transpiring with the Government
Sharing about our fundamental natural rightsDisclaimer: This is not legal advice.
The creator posting this video not responsible in any manner as a result of...
7:54 AM · Jan 1, 2021 · Twitter Web App

January 1,
2021
8:04 a.m.

Darrell James hill
[@DarBenThu1](#)

1- DOI-1776-A.D. is the law for man. 2- AOC-1777-A.D. is the law for states, and:
3- TheCftUSofA-1787-91 is the law for government FOR THE PEOPLE. So, man has DOI- rights; and, :rights, -not given! are PROTECTED by TheCftUSofA. See- e.g.; BOR- Amend 9, 10. Yeah, ... me either!

Quote Tweet



Darrell James hill

:Executor-Procurator, -:mitigation of the Trustee-derelict- damages ~

UN
2189



:Darrell-James: Hill, :Ohioan- beneficiary-Executor-Procurator, -:mitigation of the trustee-derelict- damages: Twitter: September 24th, 2020, 7:05 p.m. - :March 9, 2021, 3:35 p.m.

@DarBenThu1

Gotta get to know this!...? e.g., your "unalienable rights" = Decl of Indep for 'man'? So, how? Ans. MUST 'execute' THE 'ICCPR', i.e., state the claim to ID your rights. Yep. Really. America Natural Common Rights what is transpiring with the Government <https://youtube.com/watch?v=TgsuFEnKOWU&t=2469s>
8:04 AM · Jan 1, 2021 · Twitter Web App

January 1,
2021
1:09 p.m.

Darrell James hill
[@DarBenThu1](#)

Here is the walk throught by <http://eternallyaware.com> discussing the nexus betwn ICCPR and US Law. United States Court Common Law Rights <https://youtube.com/watch?v=6pjzgp41FXg&t=364s>

Quote Tweet



Darrell James hill
[@DarBenThu1](#)

1- DOI-1776-A.D. is the law for man. 2- AOC-1777-A.D. is the law for states, and: 3- TheCftUSofA-1787-91 is the law for government FOR THE PEOPLE. So, man has DOI- rights; and, :rights, -not given! are PROTECTED by TheCftUSofA. See-e.g.; BOR- Amend 9, 10. Yeah, ... me either! [twitter.com/DarBenThu1/sta...](https://twitter.com/DarBenThu1/status/1314111111)
1:09 PM · Jan 1, 2021 · Twitter Web App

January 1,
2021
2:24 p.m.



Darrell James hill
[@DarBenThu1](#)

Wow guys. We gotta know this is REAL. Dr Susan Moore Last Words Before Dying From COVID and Neglect <https://youtube.com/watch?v=XpLBhAcTpTw>
So, ... what?!

Quote Tweet

2190

:Executor-Procurator, -:mitigation of the Trustee-derelict- damages ~

86 / 206



File Edit View History Bookmarks Tools Help

https://twitter.com/DarBenThu1/status/1345020463903170562/analytics

Getting Started EXECUTIVE ORDERS REF COMMERCE DAVID STRAIGHTERS AJ

← Tweet
Search Twitter

Tweet Analytics

Darrell James Hill @DarBenThu1
Gotta get to know this!...?
e.g., your "unalienable rights" = Decl of Indep for 'man'? So, how? Ans. MUST 'execute' THE 'ICCPR', i.e., state the claim, to ID your rights. Yep. Really. America Natural Common Rights what is transpiring with the Government
<https://www.youtube.com/watch?v=TgsuFEnKOWU&t=2469s> ...

Impressions	271
times people saw this Tweet on Twitter	
Total engagements	3
times people interacted with this Tweet	

[View all engagements](#)

Promote your Tweet

1 Quote Tweet 11
messages

Tweet Analytics

Darrell James hill @DarBenThu1
 1- DOI-1776-A.D. is the law for man.
 2- AOC-1777-A.D. is the law for states, and:
 3- TheCftUSofA-1787-91 is the law for government FOR THE PEOPLE.
 So, man has DOI- rights; and, rights, -not given! are PROTECTED by TheCftUSofA.
 See- e.g.; BOR- Amend 9, 10. Yeah, ... me either! <https://twitter.com/DarBenThu1/status/1345020463903170562> ...

Impressions	277
times people saw this Tweet on Twitter	
Total engagements	1
times people interacted with this Tweet	

[View all engagements](#)

2022-011769 MISC Page: 2402 of 2782
 09/26/2022 03:35:37 PM Receipt #: 22-9381
 Rec Fee: \$30.00 Darrell James Hill
 Gila County, Az, Sadie Jo Bingham, Recorder



Tweet

3- TheCftUSofA-t
So, man has DOI-
TheCftUSofA.
See-e.g.; BOR- Ar
twitter.com/DarBe

1:09 PM - Jan 1, 2022

View Tweet activity

Tweet Analytics

Darrell James hill @DarBenThu1
Here is the walk through by http://eternallyaware.com discussing the nexus betwn ICCPR and US Law.

United States Court Common Law Rights
https://www.youtube.com/watch?v=6pjzgp41FXg&t=364s ... https://twitter.com/DarBenThu1/status/1345023086370856960 ...

Impressions times people saw this Tweet on Twitter	140
Total engagements times people interacted with this Tweet	2

[View all engagements](#)

messages

Tweet Analytics

Darrell James hill @DarBenThu1
Wow guys. We gotta know this is REAL.
Dr Susan Moore Last Words Before Dying From COVID and Neglect
<https://www.youtube.com/watch?v=XpLBhAcTpTw> ...
So, ... what?! <https://twitter.com/DarBenThu1/status/1342156419244539904> ...

Impressions	156
times people saw this Tweet on Twitter	
Total engagements	2
times people interacted with this Tweet	

[View all engagements](#)

Privacy Policy Cookie Policy © 2021 Twitter, Inc.

2022-011769 MISC Page: 2404 of 2782
09/26/2022 03:35:37 PM Receipt #: 22-9381
Rec Fee: \$30.00 Darrell James Hill
Gila County, Az, Sadie Jo Bingham, Recorder



:Darrell-James: Hill, :Ohioan- beneficiary-Executor-Procurator, -:mitigation of the Trustee-derelict- damages: Twitter: September 24th, 2020, 7:05 p.m. - :March 9, 2021, 3:35 p.m.



Darrell James hill
@DarBenThu1

Black Doctor Dies of Covid-19 After Complaining of Racist Treatment
<https://nytimes.com/2020/12/23/us/susan-moore-black-doctor-indiana.html?smid=tw-share>

"If you want to fight, now is the time to fight," he recalled telling her. "But if you need to go, I understand." Two days later, Dr. Moore's heart stopped beating.

2:24 PM · Jan 1, 2021 · Twitter Web App

January 3,
2021
2:53 a.m.



Darrell James hill
@DarBenThu1

Ya' gotta hear this new gen(s)! BUT! hold on! -- Kiyosaki (speaker) is NOT a Yes man! We/you have been \$-rape-robbed! "It's All A SMOKESCREEN"



2022-011769 MISC Page: 2405 of 2782
09/26/2022 03:35:37 PM Receipt #: 22-9381
Rec Fee: \$30.00 Darrell James Hill
Gila County, Az, Sadie Jo Bingham, Recorder

:Executor-Procurator, -:mitigation of the Trustee-derelict- damages ~

87 / 206



:Darrell-James: Hill, :Ohioan- beneficiary-Executor-Procurator, -:mitigation of the Trustee-derelict- damages: Twitter: September 24th, 2020, 7:05 p.m. - :March 9, 2021, 3:35 p.m.

youtube.com
"It's All A SMOKESCREEN" (only a few people know about this)
"They threatened me!" ► Special thanks to Robert Kiyosaki. YT -
<https://www.youtube.com/user/RDdotcomIG> -
<https://www.instagram.com/therealkiyosakiFB> - <https://www.instagram.com/therealkiyosakiFB>
2:53 AM · Jan 3, 2021 · Twitter Web App

January 3,
2021
4:09 a.m.

Darrell James hill
[@DarBenThu1](https://twitter.com/DarBenThu1)
Abba, wants this said: IF you STAND, it Will Cost you EVERYTHING!; so,,,,
STAND!! -- Gotta' Shema this: Chadwick Boseman's Life Advice Will Leave You
SPEECHLESS



youtube.com
Chadwick Boseman's Life Advice Will Leave You SPEECHLESS | RIP 'Black...
Chadwick Boseman reveals his secrets to finding purpose in life. Throughout his
endearing life, Chadwick Boseman lived a life of humility and grace, striving...
3:09 AM · Jan 3, 2021 · Twitter Web App

January 15,
2021
6:12 p.m.

Darrell James hill
[@DarBenThu1](https://twitter.com/DarBenThu1)
Abraham Lincoln the 16th PFTUSA on Monday, March 4, 1861, at East Portico -
United States Capitol Washington, Dist of Columbia. Donald-John, you are the
PFTUSA until March 4, 1861 A.D. for a reason. Please not make that :i- man must
suit for remedy!
6:12 PM · Jan 15, 2021 · Twitter Web App

2/9/6
UNOFFICIAL

9/1/21

Tweet

Darrell James Hill
@DarBenThu1

Ya' gotta hear this new gen(s)! BUT! hold on! -- Kiyosaki (speaker) is NOT a Yes man! We/you have been \$-rape-robbed! "It's All A SMOKESCREEN" https://www.youtube.com/watch?v=imJw2vBETJU ...

2:53 AM - Jan 3, 2022

View Tweet activity

Tweet Analytics

Darrell James Hill @DarBenThu1
Ya' gotta hear this new gen(s)! BUT! hold on! -- Kiyosaki (speaker) is NOT a Yes man! We/you have been \$-rape-robbed! "It's All A SMOKESCREEN" https://www.youtube.com/watch?v=imJw2vBETJU ...

Impressions	135
times people saw this Tweet on Twitter	
Total engagements	3
times people interacted with this Tweet	

[View all engagements](#)

People

James Hill

enThu1

Ysrael -civilian, -Ohioan, -Secretary: DOI-1776-A.D., -33-A.D.; Amb. of Yushuah to n-redeemer/Ysrael & Trustees sion-1213-A.D.

opening

ago

teairing on ABC

fm, Balla

ture today!

min Bloom

2198

3:09 AM · Jan 9, 2022

Tweet Analytics

Darrell James hill @DarBenThu1
Abba, wants this said:
IF you STAND,
it Will Cost you EVERYTHING!
so,,,, STAND!! -- Gotta' Shema this:

Chadwick Boseman's Life Advice Will Leave You SPEECHLESS
[https://www.youtube.com/watch?v=x9QwIZEqumA ...](https://www.youtube.com/watch?v=x9QwIZEqumA...)

Impressions times people saw this Tweet on Twitter	145
Total engagements times people interacted with this Tweet	2

[View all engagements](#)

messages

2199

Darrell James hill on Twitter: "Abraham Lincoln the 16th PFTUSA on Monday, March 4, 1861, at East Portico -United States Capitol Washington, Dist of Columbia. Donald-John, you are the PFTUSA until March 4, 1861 A.D. for a reason. Please not make...

File Edit View History Bookmarks Tools Help

Alt Mail - djhill X New Tab X Only receive X Apache Junct X WunderMap X My Inbox (107) X Total Praise X Darrell James X b-1020-intro X a-2020-09-20 X New Tab X

← → ↻ 🏠 <https://twitter.com/DarBenThu1/status/1350250374562525955/analytics> 150% 🔍 I'll never be more loved

Getting Started EXECUTIVE ORDERS REF COMMERCE DAVID STRAIGHTERS AJ

Tweet Analytics

Darrell James hill @DarBenThu1
 Abraham Lincoln the 16th PFTUSA
 on Monday, March 4, 1861,
 at East Portico -United States Capitol Washington, Dist of Columbia.

Donald-John, you are the PFTUSA until March 4, 1861 A.D. for a reason. Please not make that :- man must suit for remedy!

Impressions	132
times people saw this Tweet on Twitter	
Total engagements	3
times people interacted with this Tweet	

View all engagements

6:15 PM - Jan 15, 2022

View tweet activity

Messages

Tuesday November 9, 21:50

2022-011769 MISC Page: 2409 of 2782
 09/26/2022 03:35:37 PM Receipt #: 22-9381
 Rec Fee: \$30.00 Darrell James Hill
 Gila County, Az, Sadie Jo Bingham, Recorder





:Darrell-James: Hill, :Ohioan- beneficiary-Executor-Procurator, -:mitigation of the Trustee-derelict- damages: Twitter: September 24th, 2020, 7:05 p.m. - :March 9, 2021, 3:35 p.m.

Nov 23, 2020 Darrell James hill
8:26 p.m. @DarBenThu1

De-mo-crat-Re-pub-lic-an-...'UNITED-STATES-CORP'-private-:gov.-service-provider,-:EBA-1933-2003-A.D.-Dry-Legislative-Trustee is derelict with the souless- 'commercial' -public(-private)-policy over public-law. See: Authorization: 'Establish Lawful Government': man- money and laws

Unofficial Copy

2200

:Darrell-James: Hill, :Ohioan- beneficiary-Executor-Procurator, -:mitigation of the Trustee-derelict- damages: Twitter: September 24th, 2020, 7:05 p.m. - :March 9, 2021, 3:35 p.m.

:Sovereign :Darrell-James: Hill, «Negro-Yisrael, «Civilian, «Ohioan, «Executor-
:Kinsman-redemer PO Box 2806, Apache Junction, Arizona 85117 1/3

To: Donald-John: Trump, «POTUSA-CIC, «POTUScorp, Trustee, «PFTUSA-CIC,
President for the United States of America, 1787 A.D., not incorporated-
William-Benjamin: Barr, «Common Law Trustee,

:General James-Charles: McConville, Army, et al. Trustees
c/o General COS Army Trustee :USPS CMH 7012 2210 0000 4268 7363
5990 Joint Staff Pentagon
Washington, District of Columbia 20310-9939 .

:Stephen-G: Breyer, et al. Trustee Justices
c/o Scott-Sessions: Harris Trustee :USPS CMH 7012 2210 0000 4268 7369
Supreme Court of the United States
1 First Street, NE
Washington, District of Columbia 20540 . and.

:Mark: Lesh, et al «Sheriffs, Gila county, Ariz. state
c/o Mark Lesh, «Trustee :USPS CMH 7012 2210 0000 4268 7377
971 N Jason Lopez Center
Building C
PO Box 357
Florence, Arizona state 85132 .

c/o Donald-John: Trump :USPS BAHN RB 322 387 620 US
1600 Pennsylvania Ave NW
Washington, District of Columbia 20500

:Sovereign- Authorization to Establish :Lawful-Government;
:Kinsman-redemer- Declaration of Independence of 1776 A.D.- Sovereign-
Authorization for the Present-Restoration of: 1) Common Law, 2) Lawful Money,
and 3) The Constitution for the United States of America for the United States of
America- people- beneficiaries

Greetings: Donald-John, et al- William-Potter, James-Charles: McConville, et al. , Scott-
Sessions: Harris, et al- Justices, Mark:Lesh, et al- RTCC;

Affiant: Soul-Sovereign-Kinsman-redemer of Negro-Yisrael, Yisrael, and the Holy-Church
-I- man named Darrell-James Hill on the Earth-Ohioan-born-man-child- sovereign with the
Almighty-God- given, unalienable-rights of man -where Nothing exists between the Almighty-God
and I- man-, «civilian, of the non-political-aggregate- a) «Son of Negro-Yisrael, son of
Chenoch, son of Shem, ... son of Shem, son of Noah... son of Adam, son of God; b) Ohioan,
«Executor- beneficiary to the EBA-1800-A.D., Legislative-Dry-Trust; c) Kinsman-redemer for

- 1. POTUSA means: President The United States of America, Inc. 1800- Presumption: Common Law
CIC- Trustee means: man- trustee under the duty, obligation and moral-Duty of Office 22nd day of
January, the year of Lord 2016 A.D. - , ministry as President of The United States of America
-not incorporated 1787 A.D. with the General Order 100 -Leber Code- 24th day April, the year of our
Lord 1823 A.D. under the Declaration of Independence for the United States of America- peace by
"The Constitution for the United States of America" Accountable to the EP-1800-A.D. for I- man
- 2. POTUS-Corp means: President Of The UNITED STATES corp, Trustee- EBA-1800-2000 A.D.-
Legislative-Trust-Dry-Trust. Presumption: commercial law policy; common-law is discouraged.
- 3. Trustee means: the manager of the principal, and operative distributor of the benefits to the
beneficiary of the proceeds of the Trust- instrument and obligation in- accordance with the prevailing
agreement.
- 4. PFTUSA-CIC means: President for the United States of America, not incorporated, subject to the
Emergency Proclamation and Leber Code 1800 -duty to ensure the republican form of government to
the people by any administrative process-provision serving the American state systems and citizens
- 5. Earth-Chenoch-born-man-child- sovereign means: beneficiary of the Constitution of 1787 A.D., et
seq. «Declaration of Independence of 1776 A.D., et seq.
- 6. born- sovereign-status-: Ohio-state with the Almighty-God- given, unalienable-rights of the
man- «civilian, of the non-political-aggregate[] means: (a) «Proble, -born-man-lawson
2. «Son of Negro-Yisrael-Father «Chenoch, son of Shem, ... son of Shem, son of Noah... son of
Adam means: born man-kind Adam, Progeny of Abraham, Isaac and Jacob/Yisrael, House of
Judah.
- 5. EBA-1800-A.D., -Dry, -Legislative- Trust means: Emergency-Banking-Act of 1800 to 2000-2013
which is defunct, and must be dissolved at the mere request of ALL beneficiary upon the Trustee.

:Executor-Procurator, -:mitigation of the Trustee-derelict- damages

2022-011769 MISC Page: 2411 of 2782
09/26/2022 03:35:37 PM Receipt #: 22-9381
Rec Fee: \$30.00 Darrell James Hill
Gila County, Az, Sadie Jo Bingham, Recorder



Thread

Tweet Analytics

Darrell James hill @DarBenThu1
De-mo-crat-Re-pub-lic-an-... 'UNITED-STATES-CORP'-private-gov.-service-provider,-EBA-1933-2003-A.D.-Dry-Legislative-Trustee is derelict with the soulless- 'commercial' -public(-private)-policy over public-law. See: Authorization: 'Establish Lawful Government': man- money and laws pic.twitter.com/FHILVtugP3

Impressions	319
times people saw this Tweet on Twitter	
Total engagements	41
times people interacted with this Tweet	

[View all engagements](#)

8:26 PM • Nov 23, 2022

1 Retweet 1 Quote

View Tweet activity

Abraham Lincoln the 16th PEF USA

Privacy Policy Cookie Policy

Tuesday November 9, 21:49

:Darrell-James: Hill, :Ohioan- beneficiary-Executor-Procurator, -:mitigation of the Trustee-derelict- damages: Twitter: September 24th, 2020, 7:05 p.m. - :March 9, 2021, 3:35 p.m.

:Sovereign :Darrell-James: Hill, -:Negro-Ysrael, -:civilian, -:Ohioan, -:Executor, -:Kinsman-redeemer PO Box 3806, Apache Junction, Arizona 85417 3 / 3

Providence:

At no time in recent years has the option of man-power presented the nation with this opportunity to affirm and break all of the bonds that devour our resources and squander our freedoms in our elections and our republic for profit.

Wealth and Greed and Misogyny "We the people" do not need another civil war to again benefit the wealthy-greedy-misogynist- profiteers that inhabit our pasts and drink our baby's blood. Rather, we need the full-accounting in the Truth of the Truth, the whole truth, and Nothing but the truth from the Concession of 1213 A.D., et seq.- Declaration of Independence of 1776 A.D. by the power of :Nature and Nature's -God on the footing of that covenantor in -spirit and in -truth.

I, man affirm that the aforesaid is the true and correct demand upon the property-claim, and will state same in the open court.

Without prejudice

Darrell James Hill
:Darrell-James: Hill, -:Negro-Ysrael, -:civilian, -:Ohioan- beneficiary, -:Executor, Ambassador of the Messiah-Yushuah

Affirmed and autographed before me this 23 day, November 2020 A.D.
Type of Identification: Arizona Driver License

Cheryl Smith
Notary Public

SEAL



2022-011769 MISC Page: 2413 of 2782
09/26/2022 03:35:37 PM Receipt #: 22-9381
Rec Fee: \$30.00 Darrell James Hill
Gila County, Az, Sadie Jo Bingham, Recorder

:Darrell-James: Hill, :Ohioan- beneficiary-Executor-Procurator, -:mitigation of the Trustee-derelict- damages: Twitter: September 24th, 2020, 7:05 p.m. - :March 9, 2021, 3:35 p.m.

:Sovereign :Darrell-James: Hill, -:Negro-Yazoo, -:civilian, -:Ohioan, -:Executor, -:Kinsman-redeemer PO Box 3866, Apache Junction, Arizona 85117 2/3

for :Negro-Yazoo, Yazoo, and the Holy-Cowsh, of all similarly-situated inhabitants on the lands of the United States of America,

:Authorization to Establish Landful Government

For that Never before in the history has been the open malfeasance by the UNITED STATES-CORP -government- services- provider financially -openly implemented against the people- beneficiaries of the national-trust by the UNITED STATES-CORP -government-services- provider with the policy to steal the every election now- after by any and every corrupt means; this is the ultimate disaster faced-upon the people-sovereigns of the United States of America' determined by the existence of same.

These actions by the hiring UNITED STATES-CORP are noticed by All of the people and, in fact, the entire world has witnessed the warlike abuse in the usurpation of the American-state citizens by sundry wrong-doings. For example, the continued policy of abuse upon the House of Justice Yazoo, unto the enslavement of all- people under the EBA-1933-A.D. -legislative-draftsmen, to reap the full-force install by the UNITED STATES-CORP leadership-derelicts for its own purposes, with the abandonment of the fiduciary duty and obligations to the defense of the rights and wills of the people- sovereigns of the United States of America.

AFFIRMED: I, man-Executor-beneficiary- sole, and, as Kinsman-redeemer, according to the Almighty-God, -covenant in the Declaration of Independence of 1776 A.D., declare that the service-provider UNITED STATES-CORP- DERELICT is demonstratively unfit to maintain the minimum righteous- standard necessary for the trust by the American-state-citizens.

Where, as the election-processes under the UNITED STATES-CORP, of all- franchisees, and fictitious entities- system has demonstrated itself derelict in honor the country of the fair elections-process with dishonesty for nearly three years with the Mueller-investigation; and, has proven itself, et al., franchisees, derelict to conduct fair elections for the people of The United States of America, and to prefer the law; and:

Whereas: Donald-John: Trump is the President for The United States of America- unincorporated, POTUSA- 1787; as well as the President of the United States of America -incorporated-, 1863; as well as the President of the UNITED STATES-CORP of 1933, as started: 2016 A.D., and:

Where, as the POTUSA-CIC is the only possible oversight of this time for this breed-system- failure by UNITED STATES-CORP -apparatus, I, man- James: Hill, sovereign- Executor-beneficiary to the Commission of 1213 A.D., et seq. - Declaration of Independence, et seq., and the Kinsman-redeemer for the unalienable-rights of the American-people-civilian and citizen- sovereigns in their right for the guaranteed republican-form-of-government, ...

I, man- sole, and, as Kinsman-redeemer, demand and command that:

- 1) The sitting-President, now- Trustee of The United States of America, Donald-John: Trump, must recede without recede to opt-out to protect the election-process day onward, November 23, 2020 A.D./at this signing, unto:
- 2) The settled-land claims of the EBA-1933-A.D. -property-claimed and possessed by I, man -Darrell-James: Hill, sole, and as the Kinsman-redeemer of the people of the United States of America; and,
- 3) Herewith establish the common-law and disband the color of law; and,
- 4) Herewith establish money with currency redeemable to money and disband the fiat currency- system; and,
- 5) Herewith establish the Declaration of Independence of 1766 A.D., et seq. - The Constitution for the United States of America of 1787 A.D., restored in the full-truth and disclosure.

This reinstating -trust is complete obligation to meet, but is your accepted DUTY as the POTUSA-CIC, POTUSA-CIC

The POTUSA-CIC with the POTUSA-CIC and the Army, et al., are the obligors to the Declaration of Independence of 1776 A.D., et seq. - The Constitution for the United States of America, 1787 A.D., EP-1863 A.D. -demand. Where, as the UNITED STATES-CORP- Trustee: EBA-1933-A.D., is antithetical is now term

The POTUSA-CIC must may-only be a civilian non-S.A.R., member qualified under The Constitution for the United States of America, 1787 A.D. unto the 13th Amendment. Therefore the administration of the nation-trust to the present embroilment cannot ever-again be distributed- away to the lawyer -S.A.R. -members nor other foreign governments, etc., corporations).

Donald-John; I, man now appoint you to achieve this high and lofty goal.
You-man can do this.

2022-011769 MISC Page: 2414 of 2782
09/26/2022 03:35:37 PM Receipt #: 22-9381
Rec Fee: \$30.00 Darrell James Hill
Gila County, Az, Sadie Jo Bingham, Recorder



2204

:Executor-Procurator, -:mitigation of the Trustee-derelict- damages ~

:Darrell-James: Hill, :Ohioan- beneficiary-Executor-Procurator, -:mitigation of the Trustee-
derelict- damages: Twitter: September 24th, 2020, 7:05 p.m. - :March 9, 2021, 3:35 p.m.

UNITED STATES POSTAL SERVICE

APACHE JUNCTION
151 W SUPERSTITION BLVD
APACHE JUNCTION, AZ 85120-9958
(800)275-8777

11/23/2020 02:58 PM

Product	Qty	Unit Price	Price
First-Class Mail® Letter	1		\$0.55
Washington, DC 20500 Weight: 0 lb 0.80 oz Estimated Delivery Date Sat 11/28/2020			
Registered Mail®			\$10.20
Assured: \$21.00 Tracking #: 9520 9402 4718 8344 9600			
Return Receipt			\$2.85
Tracking #: 9520 9402 4718 8344 9600			
Total			\$16.60
First-Class Mail® Letter	1		\$0.55
Washington, DC 20543 Weight: 0 lb 0.60 oz Estimated Delivery Date Sat 11/28/2020			
Certified Mail®			\$3.55
Tracking #: 7012221000002697360			
Total			\$4.10
First-Class Mail® Letter	1		\$0.55
Florence, AZ 85132 Weight: 0 lb 0.60 oz Estimated Delivery Date Fri 11/27/2020			
Certified Mail®			\$3.55
Tracking #: 70122210000047697377			
Total			\$4.10
First-Class Mail® Letter	1		\$0.55
Washington, DC 20018 Weight: 0 lb 0.60 oz Estimated Delivery Date Sat 11/28/2020			
Certified Mail®			\$3.55
Tracking #: 70122210000047697353			
Total			\$4.10
Grand Total			\$29.90
Cash			\$30.00
Cash			\$30.00
Change			-\$71.10

Postage & Fees
Extra Services & Fees
Postage
Insurance
Certified Mail
Registered Mail
Return Receipt
Tracking
Customer Must Declare Full Value

NOV 23 2020

OFFICIAL USE

Darrell James Hill
PO Box 38010
Apache Junction, Arizona
85117

Darrell James Hill
1100 Pennsylvania Ave NW
Washington, District of Columbia
20500

PS Form 3806, Registered Mail Receipt
Rev. 10-18

:Executor-Procurator, -:mitigation of the Trustee



:Darrell-James: Hill, :Ohioan- beneficiary-Executor-Procurator, -:mitigation of the Trustee-
derelict- damages: Twitter: September 24th, 2020, 7:05 p.m. - :March 9, 2021, 3:35 p.m.

January 15,
2021
6:15 p.m.



Darrell James hill
[@DarBenThu1](#)

Abraham Lincoln the 16th PFTUSA on Monday, March 4, 1861, at East Portico -
United States Capitol Washington, Dist of Columbia. Donald-John, you are the
PFTUSA until March 4, 1861 A.D. for a reason. Please not make that :i- man must
suit for remedy!

January 15,
2021
8:34 p.m.

Darrell James hill
[@DarBenThu1](#)

'been four years; :i- man wish to resolve the 'voidance-of-benefit' -/stolen-property
matter :in- non-controversy, :in- procurator ~i.e., to act :in-honor as would the
Respondent~ for to execute the right-to-remedy :in- accordance with the prevailing-
covenant-agreements. Yeah...

2206
:Executor-Procurator, -:mitigation of the Trustee-d

2022-011759 MISC Page: 2416 of 2782
09/26/2022 03:35:37 PM Receipt #: 22-9381
Rec Fee: \$30.00 Darrell James Hill
Gila County, Az, Sadie Jo Bingham, Recorder



2207

Darrell James hill on Twitter: "been four years; i- man wish to resolve the 'voidance-of-benefit' -/stolen-property matter :in- non-controversy, :in- pro-curation -i.e., to act :in-honor as would the Respondent- for to execute the right-to-remedy :in- acc...

File Edit View History Bookmarks Tools Help

All Mail - dhill X New Tab X Onkyo receive X Apache Junct X WunderMap X M Inbox (107) X Total Prase X Darrell James X b-1020-intro X a-2020-09-20 X New Tab X

https://twitter.com/DarBenThu1/status/1350285356516605954/analytics 150%

Getting Started EXECUTIVE ORDERS REF COMMERCE DAVID STRAIGHTERS AJ

Tweet Analytics

Darrell James hill @DarBenThu1
 'been four years; i- man wish to resolve the 'voidance-of-benefit' -/stolen-property matter :in- non-controversy, :in- pro-curation -i.e., to act :in-honor as would the Respondent- for to execute the right-to-remedy :in- accordance with the prevailing-covenant-agreements. Yeah... pic.twitter.com/gMTupRxLOn

Impressions times people saw this Tweet on Twitter	294
Total engagements times people interacted with this Tweet	36

[View all engagements](#)

Promote your Tweet

8:34 PM · Jan 13, 2022

1 Retweet 1 Quote

View tweet activity

Messages

Tuesday November 9, 21:49

2022-011769 MISC Page: 2417 of 2782
 09/26/2022 03:35:37 PM Receipt #: 22-9381
 Rec Fee: \$30.00 Darrell James Hill
 Silla County, Az, Sa'ie Jo Bingham, Recorder



:Darrell-James: Hill, :Ohioan- beneficiary-Executor-Procurator, -:mitigation of the Trustee-derelict- damages: Twitter: September 24th, 2020, 7:05 p.m. - :March 9, 2021, 3:35 p.m.

To :Donald-John: Trump, :Respondent- :Trustee, et al -
:man-actor -Trustees: Barack-Hussein: Obama;
Loretta: Lynch, Jefferson-Beauregard: Sessions III, Matthew-George: Whitaker,
Dana-James: Boenig, Sally-Caroline: Yates, William-Polham: Barr, Steve-Troner
Mnuchin, Brian: Keith, Rivier-Christercunean: Collins; John and Jane Does;
Under-Procuration For Respondent :darrell-james: hill, :man -Procuration
c/o :Donald-John: Trump ; USPO CMN 7008 1830 0002 1028 2082
c/o: darrell-james: hill, procurator-ministor
1600 Pennsylvania Ave NW
Washington, District of Columbia 20500 ;

7008 1830 0002 1028 2082

To: Mark-Alexander :General United States Army-Chairman: CJCS- :MBoy,
:John-Earl :General United States Air Force: Vice- CJCS- :Hyten,
:James-Charles :General United States Army: COS Army- :McConville,
:David-Hubery :General United States Marine Corps: CMC- :Borger,
:Michael-Martin :Admiral United States Navy: CNO- :Gaddy,
:David-Lee :General United States Air Force: COS AF- :Goldfen,
:John-William :General United States Space Force: CSO- :Raymond,
:Joseph-Lauren :General United States Air Force: CNG- :Lengyel
:Karl-Lee :Admiral United States Coast Guard: CCG- :Schutz
c/o :James-Charles: McConville, -:Trustee ; USPO CMN 7009 2820 0003 8861 6100
8999 Joint Staff Pentagon
Washington, District of Columbia 20318-9999 ;

7009 2820 0003 8861 6100

:Mark, :Sheriff- Pinal county, Arizona state- :Lamb,
:Joseph- Jr. :Sheriff Apache county, Arizona state- :Dodman,
:Mark, :Sheriff -Cochise county Arizona state- :Dannek,
:Jim, :Sheriff -Cochise county, Arizona state- :Driscoll,
:Adam, :Sheriff- Gila county, Arizona state - :Shepherd,
:Preston- "PJ", :Sheriff -Graham county, Arizona state- :Aired,
:Tim, :Sheriff- Greenlee county, Arizona state- :Sumner,
:Bil, :Sheriff- La Paz county, Arizona state- :Rison,
:Paul, :Sheriff- Maricopa county, Arizona state- :Penzono,
:Doug, :Sheriff- Mohave county, Arizona state- :Schuster,
:David, :Sheriff- Navajo county, Arizona state- :Clouse,
:Mark, :Sheriff- Pima county, Arizona state- :Napier,
:Tony, :Sheriff- Santa Cruz county, Arizona state- :Estrada,
:Scott, :Sheriff- Yavapai county, Arizona- :Mascher,
:Leon, :Sheriff- Yuma county, Arizona state- :Wilmot,
c/o :Mark :Lamb, -:Trustee
971 N Jason Lopez Circle
Building C
PO Box 887
Florence, Arizona state 85132

7010 1060 0001 7518 9154

c/o :Paul: Penzono, -:Trustee
550 West Jackson
Phoenix Arizona state 85003

USPO CMN 7012 2210 0000 4269 7384

USPO CMN 7010 1060 0001 7518 9154

7012 2210 0000 4269 7384

Greetings :Donald-John, et al, James-Charles, et al., Mark and Paul, et al.;

thank- you for your service; if there is anything you need, please let me know.

This is :in great sadness -
Due to the violation of :all- rights-executed :in- accordance with-after the detailed-meeting of
the ICPR-1992-A.D. is met with the absolute-deprivation and voidance-of-benefit by the Trustee-
Dereliction with the silent-acquiescence unto tacit-procuration for the remedy of the deprivation
imposed without right or :i- man's wishes. :i- man- beneficiary must write to you :this- matter as
stipulated-to and agreed-upon :in- accordance with the prevailing covenant-agreements. See:
:notice; See claim; :matter # RE 322 398 369 US, et al, enclosed: 24 page.
:In- accordance with the prevailing covenant-agreements, :i- man must :in- honor execute
procuration for the Trustee-Dereliction and wrong-doings. You may attend the proceedings;
however, your presence is Not required as the procuration is sufficient to direct the matters-agreed
:in- non-controversy.

Without prejudice,

:darrell-james: hill procurator

2208
UnOFFICIAL

:Executor-Procurator, -:mitigation of the Trustee-derelict- damages ~

95 / 206

2022-011769 MISC Page: 2418 of 2782

09/26/2022 03:35:37 PM Receipt #: 22-9381
Rec Fee: \$30.00 Darrell James Hill
Gila County, Az, Sadie Jo Bingham, Recorder



:Darrell-James: Hill, :Ohioan- beneficiary-Executor-Procurator, -:mitigation of the Trustee-derelict- damages: Twitter: September 24th, 2020, 7:05 p.m. - :March 9, 2021, 3:35 p.m.

Service of Claim - Notice:
matter # RE 322 398 389 US

Name: Tracy Calhoun
Address: 5124 East 16th Avenue
City, State, Zip: Apache Junction, Arizona 85119
Phone: _____

I, man, Tracy Calhoun, am of sound-mind and mature in years, herein sets for the fact-verified that I-man served the Claim: matter # RE 322 398 389 US documents for the claimant in the matter directly to the intended recipient before the notary-public, as man-Respondent -Darrell-James: Hill on this day January, 2021, at: 01:01 am/pm

Date: January 14, 2021 Tracy Calhoun
:may server

I-man -Darrell-James: Hill, :procurator as the Respondent received the claim, and all appended- documents upon the :matter # RE 322 398 389 US is received this January 14th, 2021 A.D. by/ from the third-party man-server indicated above.

See: Claim: matter # RE 322 398 389 US to :man- Darrell-James: Hill;
FORMAL SUMMONS IS WAVED.

I-man say here under penalty of perjury, and will verify same in the open-court, that all herein be true and correct to the best of I-man's knowledge;

Without prejudice
Darrell-James Hill, Procurator
:Darrell- James: Hill, :procurator as the respondent

Sworn and Autographed before me this 14 day January 2021 A.D.
Type of Identification: Arizona Driver License

London Breaux
Notary-Public

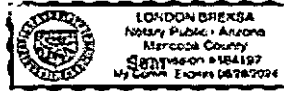

2022-011769 MISC Page: 2419 of 2782
09/26/2022 09:35:37 PM Receipt #: 22-9381
Reg Fee: \$30.00 Darrell James Hill
Gila County, Az, Sadie Jo Bingham, Recorder

:Darrell-James: Hill, :Ohioan- beneficiary-Executor-Procurator, -:mitigation of the Trustee-derelict- damages: Twitter: September 24th, 2020, 7:05 p.m. - :March 9, 2021, 3:35 p.m.

Arizona state
Maricopa county

:In :Hill – Court of :Record
At: Maricopa County Superior Court

:Darrell-James: Hill,
:Claimant- beneficiary

:notice:
:see claim: :matter # RE 322 398 389 US

:Donald-John: Trump,
:Respondent: :Trustee, et al. :man-actor
-Trustees: Barack-Hussein: Obama;
Loretta: Lynch, Jefferson-Beuregard:
Sessions III, Matthew-George: Whitaker,
Dana-James: Boente, Sally-Caroline: Yates,
William-Pelham: Barr, Steve-Thomas: Mnuchin;
Brian: Karth, Ronier-Christercunean: Collins;
John and Jane Does;

See- appended:
claim – executed;
declaration: right of claim, with
declaration: averments: claimant;

See- appended: Respondent:
declaration: stipulations; procurator as
respondent;
Notice of receipt of claim; formal
summons waived

Under-:Procurator For Respondent
:darrell-james: hill, -:man -:Procurator

(verified)

:I- man will stand-present as the Executor,
:Law Over-standing The Matter

This Court-of-Record must be administered by the services of the Trial-by-Jury² for to decide the matter of the facts and the law status of the out-of-court- judgment, :in- non-controversy, by procurator, :in- accordance with the law of the covenant-agreements- See: Nature of Claim: Trespass- :stipulated-to and agree-upon by the man- Claimant and the man- Respondent, et al.- U.S.-Corp. Government-services-provider, -:Trustee: Emergency Banking Act of 1933, et seq.

:Duties during the Proceeding

The man- Magistrate's is invited in this court-of-record is to witness for the proceedings :in the trial-by-jury, autograph-accept the jury's order(s) and ensure the proper recording of the order(s) with the clerk.

The man- Security personnel- assigned's duty is to be impartial.

RESPONDENT-NOTIFICATION is completed with the service to the procurator. Notice to the Procurator is as notice the :Respondent -in -principal, -:Donald-John: Trump, et al.- man-actor(s).

I- man say here under penalty of perjury, and will verify same in the open-court, that :a2 herein be true and correct to the best of :I- man's knowledge;

Sincerely,

Darrell James Hill
:Darrell-James: Hill, -:Executor- beneficiary

Sworn and Autographed before me this 14 day January 2021 A.D.
Type of Identification: Arizona Driver License

London Bireksa
Notary-Public

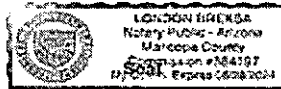

January 14, 2021 :notice: see claim – :matter # RE 322 398 389 US

1 / 2

8:34 PM · Jan 15, 2021 · Twitter Web App

January 15,
2021

Darrell James hill
@DarBenThu1

:Executor-Procurator, -:mitigation of the Trustee-derelict- damages ~

98 / 206

2022-011769 MISC Page: 2421 of 2782

09/26/2022 03:35:37 PM Receipt #: 22-9381

Rec Fee: \$30.00 Darrell James Hill
Gila County, Az, Sadie Jo Bingham, Recorder



2211

:Darrell-James: Hill, :Ohioan- beneficiary-Executor-Procurator, -:mitigation of the Trustee-derelict- damages: Twitter: September 24th, 2020, 7:05 p.m. - :March 9, 2021, 3:35 p.m.

8:34 p.m.

'been four years; :- man wish to resolve the 'voidance-of-benefit' -/stolen-property matter :-in- non-controversy, :-in- procuration ~i.e., to act :-in-honor as would the Respondent~ for to execute the right-to-remedy :-in- accordance with the prevailing-covenant-agreements. Yeah...

To: Donald-John: Trump; :Respondent- :Trustee, et al.;
:man-actor -Trustees: Barack-Hussein: Obama,
Lorilla: Lynch, Jefferson-Beauregard: Sessions III, Matthew-George: Whitaker,
Dana-James: Boersta, Sally-Carolina: Yates, William-Polham: Barr, Steve-Tracker
Muschin; Brian: Karth, Ranier-Christercunson; Collins; John and Jane Doss;
Under-Procurator For Respondent; darrell-james: hill, :-man -Procurator
c/o :Donald-John: Trump ; USPO CMN 7008 1830 0002 1028 2082
c/o :darrell-james: hill, procurator-minister
1000 Pennsylvania Ave NW
Washington, District of Columbia 20500 ;

7008 1830 0002 1028 2082

To: Mark-Alexander :General United States Army-Chairman; CJCOS- :Macy,
:John-Earl :General United States Air Force- Vice- CJCOS- :Hyten,
:James-Charles :General United States Army- COS Army- :McConville,
:David-Habeary :General United States Marine Corps- CMC- :Berger,
:Michael-Martin :Admiral United States Navy- CNO- :Gilday,,
:David-Leo :General United States Air Force- COS AF- :Goldstein,
:John-William :General United States Space Force- CSO- :Raymond,
:Joseph-Lauren :General United States Air Force- CNG- :Lengyel
:Kurt-Leo :Admiral United States Coast Guard- CCG- :Schultz
c/o :James-Charles: McConville, :-Trustee ; USPO CMN 7009 2820 0003 8851 6100
9999 Joint Staff Pentagon
Washington, District of Columbia 20318-9999 ;

7009 2820 0003 8851 6100

:Mark, :Sheriff- Pinal county, Arizona state- :Lamb,
:Joseph- Jr. :Sheriff Apache county, Arizona state- :Dedman,
:Mark, :Sheriff- Cochise county Arizona state- :Danneis,
:Jim, :Sheriff- Cochise county, Arizona state- :Discol,
:Adam, :Sheriff- Gila county, Arizona state - :Shepherd,
:Preston- P.J. ; Sheriff- Graham county, Arizona state- :Allred,
:Tim, :Sheriff- Greenlee county, Arizona state- :Sumner,
:Bill, :Sheriff- La Paz county, Arizona state- :Risen,
:Paul, :Sheriff- Maricopa county, Arizona state- :Penzon,
:Doug, :Sheriff- Mohave county, Arizona state- :Schuster,
:David, :Sheriff- Navajo county, Arizona state- :Clouse,
:Mark, :Sheriff- Pima County, Arizona state- :Napier,
:Tony, :Sheriff- Santa Cruz county, Arizona state- :Estraza,
:Scott, :Sheriff- Yavapai county, Arizona- :Mascher,
:Leon, :Sheriff- Yuma county, Arizona state- :Wimot,

7010 3060 0001 7518 9154

c/o :Mark :Lamb, :-Trustee
871 N Jason Lopez Circle
Building C
PO Box 887
Florence, Arizona state 85132

c/o :Paul: Penzone, :-Trustee
650 West Jackson
Phoenix Arizona state 85003

USPO CMN 7010 1060 0001 7518 9154

7012 2210 0000 4269 7384

Greetings :Donald-John, et al., James-Charles, et al., Mark and Paul, et al.;

thank- you for your service; if there is anything you need, please let me know.

This is in great sadness -

Due to the violation of :all- rights-executed :-in- accordance with-after the detailed-meeting of the ICCPR-1992-A.D. is met with the absolute-deprivation and voidance-of-benefit by the Trustee-Dereliction with the silent-acquiescence unto tacit-procurator for the remedy of the deprivation imposed without right or :- man's wishes, :- man- beneficiary must write to you :this- matter as stipulated-to and agreed-upon :-in- accordance with the prevailing covenant-agreements. See :notice; See claim; :matter # RE 322 398 389 US, et al, enclosed: 24 page.

:-in- accordance with the prevailing covenant-agreements, :- man must :-in- honor execute procurator for the Trustee-Dereliction and wrong-doings. You may attend the proceedings; however, your presence is Not required as the procurator is sufficient to direct the matters-agreed :-in- non-controversy.

Without prejudice,

Darrell-James Hill
Procurator

2022-011769 MISC Page: 2422 of 2782
09/26/2022 03:35:37 PM Receipt #: 22-9981
Rec Fee: \$30.00 Darrell James Hill
Gila County; Az, Sadie Jo Bingham, Recorder

:Executor-Procurator, -:mitigation of the Trustee-derelict- damages ~

99 / 206

:Darrell-James: Hill, :Ohioan- beneficiary-Executor-Procurator, -:mitigation of the Trustee-derelict- damages: Twitter: September 24th, 2020, 7:05 p.m. - :March 9, 2021, 3:35 p.m.

Service of Claim – Notice:
matter # RE 322 398 389 US

Name: Tracy Calloun
Address: 5124 East 18th Avenue
City, State, Zip: Apache Junction, Arizona 85119
Phone: _____

I, man, Tracy Calloun, am of sound mind and mature in years, herein sets for the fact-verified that I-man served the Claim: matter # RE 322 398 389 US documents for the claimant in the matter directly to the intended recipient before the notary-public, as man-Respondent -Darrell-James: Hill on this day _____ January, 2021, at 01:01 am/pm

Date: January 14, 2021 
:man-server

I, man -Darrell-James: Hill, :procurator as the Respondent received the claim, and all appended- documents upon the :matter # RE 322 398 389 US is received this January 14th, 2021 A.D. by/ from the third-party man-server indicated above.

See: Claim: matter # RE 322 398 389 US to :man- Darrell-James: Hill;
FORMAL SUMMONS IS WAVED.

I, man say here under penalty of perjury, and will verify same in the open-court, that :all herein be true and correct to the best of :I- man's knowledge;

Without prejudice

:Darrell- James: Hill, :procurator as the respondent

Sworn and Autographed before me this 14 day January 2021 A.D.
Type of Identification: Arizona Driver License

Notary-Public

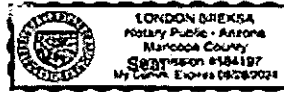

2022-011769 MISC Page: 2423 of 2782
09/26/2022 03:35:37 PM Receipt #: 22-9981
Rec Fee: \$30.00 Darrell James Hill
Gila County, Az, Sadie Jo Bingham, Recorder

2213

:Executor-Procurator, -:mitigation of the Trustee-derelict- damages ~

:Darrell-James: Hill, :Ohioan- beneficiary-Executor-Procurator, -:mitigation of the Trustee-derelict- damages: Twitter: September 24th, 2020, 7:05 p.m. - :March 9, 2021, 3:35 p.m.

Product	Qty	Unit Price	Total
First-Class Mail®	1	\$2.20	\$2.20
Large Envelope			
Postage: 0 lb 6.10 oz			
Estimated Delivery Date			
Postage: 01/15/2021			
Certified Mail			
Tracking #			
Total			\$2.20
First-Class Mail®	1	\$2.20	\$2.20
Large Envelope			
Postage: 0 lb 6.10 oz			
Estimated Delivery Date			
Postage: 01/15/2021			
Certified Mail			
Tracking #			
Total			\$2.20
First-Class Mail®	1	\$2.20	\$2.20
Large Envelope			
Postage: 0 lb 6.10 oz			
Estimated Delivery Date			
Postage: 01/15/2021			
Certified Mail			
Tracking #			
Total			\$2.20
First-Class Mail®	1	\$2.20	\$2.20
Large Envelope			
Postage: 0 lb 6.10 oz			
Estimated Delivery Date			
Postage: 01/15/2021			
Certified Mail			
Tracking #			
Total			\$2.20
First-Class Mail®	1	\$2.20	\$2.20
Large Envelope			
Postage: 0 lb 6.10 oz			
Estimated Delivery Date			
Postage: 01/15/2021			
Certified Mail			
Tracking #			
Total			\$2.20

2022-011769 MISC
 09/26/2022 03:35:37 PM
 Rec Fee: \$30.00
 Darrell James Hill
 Gila County, AZ, Sadie Jo Bingham, Recorder

2214

:Darrell-James: Hill, :Ohioan- beneficiary-Executor-Procurator, -:mitigation-of the Trustee-derelict- damages: Twitter: September 24th, 2020, 7:05 p.m. - :March 9, 2021, 3:35 p.m.

Arizona state
Maricopa county

:in :Hill - Court of :Record
At: Maricopa County Superior Court

:Darrell-James: Hill,
:Claimant- beneficiary

:notice:
:see claim: :matter # RE 322 398 369 US

:Donald-John: Trump,
:Respondent- :Trustee, et al. - :man-actor
-Trustees: Barack-Hussein: Obama;
Loreita: Lynch, Jefferson-Beauregard;
Sessions III, Matthew-George: Whitaker,
Dana-James: Boente, Sally-Caroline: Yates,
William-Pelham: Barr, Steve-Trumer: Mnuchin;
Brian: Karth, Ramier-Christercunean: Collins;
John and Jane Does;

See- appended:
claim - executed;
declaration: right of claim, with:
declaration: avowments: claimant;

See- appended: Respondent:
declaration: stipulations; procurator as
respondent;
Notice of receipt of claim; formal
summons waved

Under-:Procurator For Respondent
:darrell-james: hill, <man -:Procurator

(verified)

:I- man will stand-present as the Executor,

:Law Over-standing The Matter

This Court-of-Record must be administered by the services of the Trial-by-jury for to decide the matter of the facts and the law status of the out-of-court- judgment, in- non-controversy, by procurator, in- accordance with the law of the covenant-agreements- See: Nature of Claim: Trespass- stipulated- to and agree-upon by the man- Claimant and the man- Respondent, et al.- U.S.-Corp, Government-services-provider, -:Trustee: Emergency Banking Act of 1933, et seq.

:Duties during the Proceeding

The man- Magistrate's is invited in this court-of-record is to witness for the proceedings in the trial-by-jury, autograph-accept the jury's order(s) and ensure the proper recording of the order(s) with the clerk.

The man- Security personnel- assigned's duty is to be tipstaff.

RESPONDENT-NOTIFICATION is completed with the service to the procurator. Notice to the Procurator is as notice the Respondent -in- principal, -Donald-John: Trump, et al.- man-actor(s).

I- man say here under penalty of perjury, and will verify same in the open-court, that :all herein be true and correct to the best of I- man's knowledge;

Sincerely,



:Darrell-James: Hill, -:Executor- beneficiary

Sworn and Autographed before me this 14 day January 2021 A.D.
Type of Identification: Arizona Driver License



Notary-Public

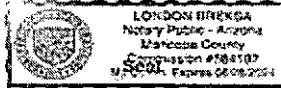

January 14, 2021 :notice: see claim - :matter # RE 322 398 369 US

1 / 2

8:34 PM · Jan 15, 2021 · Twitter Web App

2022-0111769 MISC Page: 2425 of 2782
09/26/2022 03:35:37 PM Receipt #: 22-9381
Rec Fee: \$30.00 Darrell James Hill
Gila County, Az, Sadie Jo Bingham, Recorder



22/15

January 20, Darrell James hill

:Executor-Procurator, -:mitigation of the Trustee-derelict- damages ~

102 / 206



Darrell James Hill

File Edit View History Bookmarks Tools Help

All Mail - dhill X New Tab X Onkyo receive X Apache Junction X WunderMap X Inbox (107) X Total Praise X Darrell James X b-1020-intra X a-2020-09-20 X New Tab X

https://twitter.com/DarBenThu1/status/1350285356516605954/analytics

Getting Started EXECUTIVE ORDERS REF COMMERCE DAVID STRAIGHTERS AJ

Tweet Analytics

Darrell James Hill @DarBenThu1
 'been four years; ;i- man wish to resolve the 'voidance-of-benefit' /-stolen-property matter ;in- non-controversy, ;in- pro-curation ~i.e., to act ;in-honor as would the Respondent- for to execute the right-to-remedy ;in- accordance with the prevailing-covenant-agreements. Yeah... pic.twitter.com/gMTupRxLOn

Impressions times people saw this Tweet on Twitter	294
Total engagements times people interacted with this Tweet	35

[View all engagements](#)

Promote your Tweet

8:34 PM Jan 15, 2022

1 Retweet 1 Quote

Privacy Policy Cookie Policy © 2021 Twitter, Inc.

Tuesday November 9, 21:49

:Darrell-James: Hill, :Ohioan- beneficiary-Executor-Procurator, -:mitigation of the Trustee-derelict- damages: Twitter: September 24th, 2020, 7:05 p.m. - :March 9, 2021, 3:35 p.m.

2021 @DarBenThu1
5:47 p.m. Ambassadors of The Power of God by Carter Conlon <https://youtube.com/watch?v=K1gAgZZ4xzQ>
Against the spirit of suicide. Shalom.
5:47 PM · Jan 20, 2021 · Twitter Web App

January 23, 2021 Darrell James hill
5:26 a.m. @DarBenThu1
'ya gotta shema (hebrew: see, read, do) this. Why? b/c :this, :violation of the :denial of :unalienable, -:constitutionally-protected-right(s). Trustee- 'policy' to deny beneficiary :ALL/ ANY- rights !' Not repub or dem - slave- whatever :i- man ain't making this up!

2022-011769 MISC Page: 2427 of 2782
09/26/2022 03:35:37 PM Receipt #: 22-9381
Rep Fee: \$30.00 Darrell James Hill
Gila County, Az, Sadie Jo Bingham, Recorder

:Darrell-James: Hill, :Ohioan- beneficiary-Executor-Procurator, -:mitigation of the Trustee-derelict- damages: Twitter: September 24th, 2020, 7:05 p.m. - :March 9, 2021, 3:35 p.m.

Darrell-James: Hill, -civilian, -Executor
PO Box 3808
Apache Junction, Arizona 85117

man :personl,

Arizona state
Pinal county

USPO CMN 7009 2820 0003 9570 7942

:Jack: Sellers, :Dist.- 1,
:Steve: Chusri, :Dist.- 2,
:B: Gates, :Dist.- 3,
:Clint: Hickman, :Dist.- 4,
:Steve: Gallardo, :Dist.- 5,
:Maricopa County Board of Supervisors
c/o: Fran: McCarroll, -Clerk
301 West Jefferson Street
Phoenix, Arizona 85003

7009 2820 0003 9570 7955

:Joseph: Wally, -: Maricopa county Judge, -Chief
201 West Jefferson Street
Phoenix, Arizona 85003

7009 2820 0003 9570 7966

:Pamela: Gates, -: Maricopa county Judge,
-Presiding
c/o : Ko:zh: Kaplan, -:Administrator
:Ch: Court Administration
201 West Jefferson Street, 4th Floor
Phoenix, Arizona 85003

7009 2820 0003 9570 7973

:Jeff: Fine, -:Maricopa county Clerk of the Court
620 West Jackson Street
Phoenix, Arizona 85003

7009 2820 0003 9570 7980

:Paul: Ponzone, -:Maricopa county Sheriff
550 West Jackson
Phoenix Arizona state 85003

7009 2820 0003 9570 7997

:Joseph-Robinella: Biden, -:POTUS
1600 Pennsylvania Ave NW
Washington, District of Columbia 20500

7009 2820 0003 9570 8000

:Monty: Wilkinson, -:CLT, U.S. Atty.-General
950 Pennsylvania Avenue, NW
Washington, Dist. Of Columbia 20530-0001

RE: A

January 19th, 2021- Deprivation of Rights to the Court of Record for
:claim: :matter # RE 322 398 389 US at the Maricopa county Court;
the Second Level Offense :in Accordance with the Covenant-agreement in the
Election: See: Gila county Recorder, Doc.# 2017-002378, pp. 1-4, et seq.

re: :notice: :see claim: :matter # RE 322 398 389 US -- See- appended: claim -
executed; declaration: right of claim, with: declaration: averments: - claimant; -
See- appended: Respondent: declaration: stipulations; procurator as respondent; -
Notice of receipt of claim; formal summons waved *;
USPO Jan. 15, 2021 to: - Donald-John: Trump - USPO CMN 7008 1830 0002 1028
2082; :James: McConville - CMN 7009 2820 0003 8851 6100; :Mark: Lamb - 7010
1060 0001 7518 9154; and: Paul: Ponzone - 7012 2210 0000 4269 7384.

1. :CLT, U.S. Atty.-General means: the United States-corp attorney general is also the 'common-
law-trustee' for the United-States-of-America- people.

2022-011769 MISC Page: 2428 of 2782

09/26/2022 03:35:37 PM Receipt #: 22-9381
Rec Fee: \$30.00 Darrell James Hill
Gila County, AZ Saddle to Bingham Recorder



2218

:Executor-Procurator, -:mitigation of the Trustee-derelict- damages ~

104 / 206

2219

Darrell James hill on Twitter: "Ambassadors of The Power of God by Carter Conlon <https://t.co/M34Nv1htWT> Against the spirit of suicide. Shalom." / Twitter - Mozilla Firefox

File Edit View History Bookmarks Tools Help

https://twitter.com/DarBenThu1/status/1352055110004686852/analytics

Getting Started EXECUTIVE ORDERS REF ECOMMERCE DAVID STRAIGHTERS AJ

Tweet Analytics

Darrell James hill @DarBenThu1
 Ambassadors of The Power of God by Carter Conlon
[https://www.youtube.com/watch?v=K1gAgZZ4xzQ ...](https://www.youtube.com/watch?v=K1gAgZZ4xzQ)
 Against the spirit of suicide. Shalom.

Impressions	267
times people saw this Tweet on Twitter	
Total engagements	3
times people interacted with this Tweet	

[View all engagements](#)

Promote your Tweet

Messages

Tuesday November 9, 21:49

2022-011769 MISC Page: 2429 of 2782
 09/26/2022 03:35:37 PM Receipt #: 22-9381
 Rec Fee: \$30.00 Darrell James Hill
 Gila County, Az, Sadie Jo Bingham, Recorder



Thread

Tweet Analytics

Darrell James hill @DarBenThu1
'ya gotta shema (hebrew: see, read, do) this. Why?
b/c :this, :violation of the :denial of :unalienable, -:constitutionally-protected-right(s).
Trustee- 'policy' to deny beneficiary :ALL/ ANY- rights !' Not repub or dem - slave- whatever
:- man ain't making this up! pic.twitter.com/5xMUgzILAJ

Impressions times people saw this Tweet on Twitter	432
Total engagements times people interacted with this Tweet	28

[View all engagements](#)

Transferring data from pbs.twimg.com... is sent via the pdf-claim for property-stolen sent to addressees

Tuesday November 9, 21:48

2022-011769 MISC Page: 2430 of 2782
09/26/2022 03:35:37 PM Receipt #: 22-9381
Rec Fee: \$30.00 Darrell James Hill
Gila County, Az, Sadie Jo Bingham, Recorder



:Darrell-James: Hill, :Ohioan- beneficiary-Executor-Procurotor, -:mitigation of the Trustee-derelict- damages: Twitter: September 24th, 2020, 7:05 p.m. - :March 9, 2021, 3:35 p.m.

2022-011769 MISC Page: 2431 of 2782

09/26/2022 03:35:37 PM Receipt #: 22-9381
 Darrell James Hill
 Rec Fee: \$30.00
 611a County, Az, Saddle Jo Bingham, Recorder



Product	Qty	Unit Price	Price
01/22/2021 10:56 AM			
First-Class Mail®	1		\$0.55
Letter			
Phoenix, AZ 85003			
Weight: 0 lb 0.50 oz			
Estimated Delivery Date			
Mon 01/25/2021			
Certified Mail®			\$3.55
Tracking #:			
7009282000395707972			
Total			\$4.10
First-Class Mail®	1		\$0.55
Letter			
Washington, DC 20530			
Weight: 0 lb 0.50 oz			
Estimated Delivery Date			
Tue 01/26/2021			
Certified Mail®			\$3.55
Tracking #:			
7009282000395708000			
Total			\$4.10
First-Class Mail®	1		\$0.55
Letter			
Washington, DC 20530			
Weight: 0 lb 0.50 oz			
Estimated Delivery Date			
Tue 01/26/2021			
Certified Mail®			\$3.55
Tracking #:			
7009282000395707997			
Total			\$4.10
First-Class Mail®	1		\$0.55
Letter			
Phoenix, AZ 85003			
Weight: 0 lb 0.40 oz			
Estimated Delivery Date			
Mon 01/25/2021			
Certified Mail®			\$3.55
Tracking #:			
7009282000395707960			
Total			\$4.10
First-Class Mail®	1		\$0.55
Letter			
Phoenix, AZ 85003			
Weight: 0 lb 0.50 oz			
Estimated Delivery Date			
Mon 01/25/2021			
Certified Mail®			\$3.55
Tracking #:			
7009282000395707973			
Total			\$4.10
First-Class Mail®	1		\$0.55
Letter			
Phoenix, AZ 85003			
Weight: 0 lb 0.50 oz			
Estimated Delivery Date			
Mon 01/25/2021			
Certified Mail®			\$3.55
Tracking #:			
7009282000395707959			
Total			\$4.10
Gross Total:			\$28.70
Cash			\$40.00
Change:			-11.30

CERTIFIED MAIL RECEIPT
 (Domestic Mail Only) (No Insurance Coverage Provided)

For delivery information visit our website at www.usps.com

PHOTOGRAPHIC SPECIAL USE

Postage	\$0.55	0130
Certified Fee	\$0.00	60
Return Receipt Fee (Endorsement Required)	\$0.00	
Restricted Delivery Fee (Endorsement Required)	\$0.00	
Total Postage & Fees	\$0.55	

01/22/2021

To: Joseph B. Hill
 201 W. Jackson Street
 Phoenix, AZ 85003

U.S. Postal Service
CERTIFIED MAIL RECEIPT
 (Domestic Mail Only) (No Insurance Coverage Provided)

For delivery information visit our website at www.usps.com

PHOTOGRAPHIC SPECIAL USE

Postage	\$0.55	0130
Certified Fee	\$0.00	60
Return Receipt Fee (Endorsement Required)	\$0.00	
Restricted Delivery Fee (Endorsement Required)	\$0.00	
Total Postage & Fees	\$0.55	

01/22/2021

To: Joseph B. Hill
 201 W. Jackson Street
 Phoenix, AZ 85003

U.S. Postal Service
CERTIFIED MAIL RECEIPT
 (Domestic Mail Only) (No Insurance Coverage Provided)

For delivery information visit our website at www.usps.com

PHOTOGRAPHIC SPECIAL USE

Postage	\$0.55	0130
Certified Fee	\$0.00	60
Return Receipt Fee (Endorsement Required)	\$0.00	
Restricted Delivery Fee (Endorsement Required)	\$0.00	
Total Postage & Fees	\$0.55	

01/22/2021

To: Joseph B. Hill
 201 W. Jackson Street
 Phoenix, AZ 85003

:Executor-Procurotor, -:mitigation of the Trustee-derelict- damages ~

:Darrell-James: Hill, :Ohioan- beneficiary-Executor-Procurator, -:mitigation of the Trustee-derelict- damages: Twitter: September 24th, 2020, 7:05 p.m. - :March 9, 2021, 3:35 p.m.

7009 2620 0003 9570 7942
 7009 2620 0003 9570 7959
 7009 2620 0003 9570 7966
 7009 2620 0003 9570 7973

Groceries,

I. DEPRIVATION OF RIGHT TO THE COURT-OF-RECORD

- 1) I- man am :Darrell-James: Hill, -civilian-beneficiary, -Ohioan, -habitant on Arizona- state See: Gila county Recorder, Doc.# 2017-002378, pp. 1-4, et seq.
- 2) :You are :trustees-under-oath to advantage I- man- beneficiary under :covenant-agreements to assure the :constitution-protected -unimpeded-access to the 'court-of-record', et al.- Trustee duties and obligations.
- 3) I- man endure damage to date by the denial of right to access the Court-of-record on: January 19th, et seq- era until the restoration of this right -in -property. To wit:
- 4) :Your :clerks at the Maricopa county Court, location: 222 East Javelina Avenue state that :your policy denies I- man the :unalienable and constitutionally-protected right to access the 'court of record' at the Maricopa county, Arizona state.
- 5) As your policy may have been misapplied to harm I- man; alternatively,
 - o I- man wish that :you- Trustees restore the right to the court-of-record' upon the day of this receipt, and place urgent notice to I- man that the restoration of :right to the court-of-record is forever-present to I- man-beneficiary.
 - o By the :covenant-agreement, this :January 19th 2021 -denial of right is the 'Second-level offense', - see: Doc.# 2017-002378, p. 21-, where is :penalty for :deprivation of rights started at: 11:00 am, January 19, 2021, and lasting until the resolve of the matter, with :express- procurating :in the property and penalty- claims.
 - o The first Bill of Particulars will follow upon the end of this month.

II. Trespass Upon The Respondent in The Hill Court Matter

The man- actors- :POTUS and Common-Law-Trustee are notified herein as the :any-harm of the related :constitutional- violation upon them is beyond the covenant- procurator- agreement for the :claim # RE 322 388 389 US.

7009 2620 0003 9570 8000
 7009 2620 0003 9570 7997
 7009 2620 0003 9570 7980

Without prejudice

Darrell-James Hill
 Darrell-James: Hill, -beneficiary-Executor-Procurator

Affirmed and autographed before me this 22 day January 2021 A.D.
 Type of Identification: Arizona Driver License

Cheryl Smith
 Notary-Public

SEAL



2022-011769 MISC Page: 2432 of 2782
 09/26/2022 03:35:37 PM Receipt #: 22-9381
 Rec Fee: \$30.00 Darrell James Hill
 Gila County, AZ, Sadie Jo Bingham, Recorder

2022

:Executor-Procurator, -:mitigation of the Trustee-derelict- damages ~

106 / 206

:Darrell-James: Hill, :Ohioan- beneficiary-Executor-Procurator, -:mitigation of the Trustee-derelict- damages: Twitter: September 24th, 2020, 7:05 p.m. - :March 9, 2021, 3:35 p.m.

2022-011769 MISC Page: 2433 of 2782
 09/25/2022 03:35:37 PM Receipt # 22-9381
 Rec Fee: \$30.00 Darrell James Hill
 Gila County, AZ; Sadie Jo Bingham, Recorder

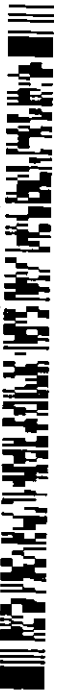

Product	Qty	Unit Price	Price
First-Class Mail® Letter	1		\$0.55
Phoenix, AZ 85003 Weight: 0 lb 0.50 oz Estimated Delivery Date: Mon 01/25/2021 Certified Mail® Tracking #: 70092820000395707942			
Total			\$4.10
First-Class Mail® Letter	1		\$0.55
Washington, DC 20500 Weight: 0 lb 0.50 oz Estimated Delivery Date: Tue 01/26/2021 Certified Mail® Tracking #: 70092820000395708000			
Total			\$4.10
First-Class Mail® Letter	1		\$0.55
Washington, DC 20500 Weight: 0 lb 0.50 oz Estimated Delivery Date: Tue 01/26/2021 Certified Mail® Tracking #: 70092820000395707937			
Total			\$4.10
First-Class Mail® Letter	1		\$0.55
Phoenix, AZ 85000 Weight: 0 lb 0.40 oz Estimated Delivery Date: Mon 01/25/2021 Certified Mail® Tracking #: 70092820000395707966			
Total			\$4.10
First-Class Mail® Letter	1		\$0.55
Phoenix, AZ 85000 Weight: 0 lb 0.50 oz Estimated Delivery Date: Mon 01/25/2021 Certified Mail® Tracking #: 70092820000395707973			
Total			\$4.10
First-Class Mail® Letter	1		\$0.55
Phoenix, AZ 85000 Weight: 0 lb 0.50 oz Estimated Delivery Date: Mon 01/25/2021 Certified Mail® Tracking #: 70092820000395707959			
Total			\$4.10
Grand Total:			\$20.70
Cash			\$40.00

U.S. Postal Service® CERTIFIED MAIL® RECEIPT	
For delivery information visit our website at www.usps.com	
PHOENIX, AZ 85003	
Package #	0130
Certified Fee	\$0.00
Return Receipt Fee (Attachment Required)	\$0.00
Restricted Delivery Fee (Attachment Required)	\$0.00
Total Package & Fees	\$0.00
Postmark	01/22/2021
To: Paul Penzone 500 West Jackson Phoenix, Arizona 85003	

U.S. Postal Service® CERTIFIED MAIL® RECEIPT	
For delivery information visit our website at www.usps.com	
WASHINGTON, DC 20500	
Package #	0130
Certified Fee	\$0.00
Return Receipt Fee (Attachment Required)	\$0.00
Restricted Delivery Fee (Attachment Required)	\$0.00
Total Package & Fees	\$0.00
Postmark	01/22/2021
To: (Mentor): Wilkinson 950 Pennsylvania Ave NW Washington, District of Columbia	

U.S. Postal Service® CERTIFIED MAIL® RECEIPT	
For delivery information visit our website at www.usps.com	
WASHINGTON, DC 20500	
Package #	0130
Certified Fee	\$0.00
Return Receipt Fee (Attachment Required)	\$0.00
Restricted Delivery Fee (Attachment Required)	\$0.00
Total Package & Fees	\$0.00
Postmark	01/22/2021
To: Joseph - Biden - Biden 1100 Pennsylvania Ave NW Washington, DC 20500	

5:26 AM · Jan 23, 2021 · Twitter Web App

:Executor-Procurator, -:mitigation of the Trustee-derelict- damages ~

:Darrell-James: Hill, :Ohioan- beneficiary-Executor-Procurator, -:mitigation of the Trustee-derelict- damages: Twitter: September 24th, 2020, 7:05 p.m. - :March 9, 2021, 3:35 p.m.

January 26,
2021
6:31 a.m.



Darrell James hill
[@DarBenThu1](#)

Did you know that :this "Enforcement Act of 1870 -
https://en.wikipedia.org/wiki/Enforcement_Act_of_1870
Civil Rights Act of 1870 or First Ku Klux Klan Act, or Force Act (41st Congress,
Sess. 2, ch. 114, 16 Stat. 140, enacted May 31, 1870" is STILL THE LAW?! 151
years past.

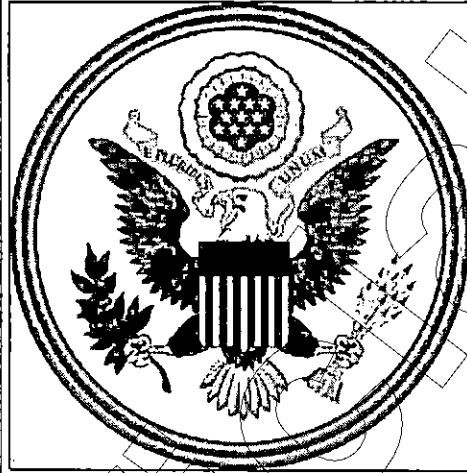

en.wikipedia.org
Enforcement Act of 1870 - Wikipedia
6:31 AM · Jan 26, 2021 · Twitter Web App

2022-011769 MISC Page: 2434 of 2782
09/26/2022 03:35:37 PM Receipt #: 22-9381
Rec Fee: \$30.00 Darrell James Hill
Gila County, Az, Sadie Jo Bingham, Recorder



January 29,
2021
3:11 a.m.



Darrell James hill
[@DarBenThu1](#)

May you be blessed to catch this. Share what you comprehend and think. Shalom.
Democracy
https://ia800708.us.archive.org/2/items/democracy_1945/democracy_1945_512kb.m
p4
(https://archive.org/details/democracy_1945) Despotism

:Executor-Procurator, -:mitigation of the Trustee-derelict- damages ~

2224

09/26/2022 03:35:37 PM Receipt #: 22-9381
Rec Fee: \$30.00 Darrell James Hill
Gila County, Az, Sadie Jo Bingham, Recorder



Darrell James Hill on Twitter: "Did you know that this "Enforcement Act of 1870 - https://en.wikipedia.org/wiki/Enforcement_Act_of_1870 ... Civil Rights Act of 1870 or First Ku Klux Klan Act, or Force Act (41st Congress, Sess. 2, ch. 114, 16 Stat. 140, enacted May 31, 1870) is STILL THE LAW?!"

File Edit View History Bookmarks Tools Help

All Mail - djh New Tab Onkyo receive Apache Jund WunderMap Inbox (107) Total Prize Darrell James b-1020-intro 4-2020-09-29 New Tab

https://twitter.com/DarBenThu1/status/1354059272716316673/analytics 150% i'll never be more loved

Getting Started EXECUTIVE ORDERS REF COMMERCE DAVID STRAIGHTERS AJ

140, enacted years past.

6:31 AM - Jan 26, 2022

View Tweets activity

Tweet yo

Promote your Tweet

Messages

Tuesday November 9, 21:48

Tweet Analytics

Darrell James Hill @DarBenThu1
 Did you know that this "Enforcement Act of 1870 - https://en.wikipedia.org/wiki/Enforcement_Act_of_1870 ... Civil Rights Act of 1870 or First Ku Klux Klan Act, or Force Act (41st Congress, Sess. 2, ch. 114, 16 Stat. 140, enacted May 31, 1870) is STILL THE LAW?! 151 years past.

Impressions times people saw this Tweet on Twitter	239
Total engagements times people interacted with this Tweet	1

[View all engagements](#)

[Promote your Tweet](#)

09/26/2022 03:35:37 PM Receipt #: 22-9381
Rec Fee: \$30.00 Darrell James Hill
Gila County, Az, Sadie Jo Bingham, Recorder



Darrell James Hill on Twitter: "May you be blessed to catch this. Share what you comprehend and think. Shalom. Democracy <https://t.co/1sVd2bxarH> (<https://t.co/1tIsH6Jb6t>) Despotism <https://t.co/QYU6mCuw3r> (<https://t.co/NnLSJAP9m>)" / Twit...

File Edit View History Bookmarks Tools Help

All Mail - djhill X New Tab X Onkyo receive X Apache Junct X WunderMap X Inbox (107) X Total Praise - Y X Darrell James Hill X b-1020-intro X a-2020-09-20 X New Tab X

https://twitter.com/DarBenThu1/status/1355096333422448640/analytics 150% I'll never be more loved

Getting Started EXECUTIVE ORDERS REF COMMERCE DAVID STRAIGHTERS AJ

← Tweet
Search Twitter

3:11 AM · Jan 29, 2022

View Tweet activity

Tweet your photos

Tweet Analytics

Darrell James Hill @DarBenThu1
May you be blessed to catch this. Share what you comprehend and think. Shalom.

Democracy
https://ia800708.us.archive.org/2/items/democracy_1945/democracy_1945_512kb.mp4 ...
(https://archive.org/details/democracy_1945 ...)

Despotism
https://ia800308.us.archive.org/30/items/Despotis1946/Despotis1946_512kb.mp4 ...
(<https://archive.org/details/Despotis1946> ...)

Impressions 238
times people saw this Tweet on Twitter

Total engagements 1
times people interacted with this Tweet

View all engagements

uture today!
min Bloom

Earlier today
iana's revenge
relevant, 27 years

day
er who struck
rck and walked
ged.

Privacy Policy Cookie Policy
© 2022 Twitter Inc.

Messages
Tuesday November 9, 21:48

:Darrell-James: Hill, :Ohioan- beneficiary-Executor-Procurator, -:mitigation of the Trustee-derelict- damages: Twitter: September 24th, 2020, 7:05 p.m. - :March 9, 2021, 3:35 p.m.

https://ia800308.us.archive.org/30/items/Despotis1946/Despotis1946_512kb.mp4 (
<https://archive.org/details/Despotis1946>
)



archive.org
Despotism : Encyclopaedia Britannica Films : Free Download, Borrow,...
Measures how a society ranks on a spectrum stretching from democracy to
despotism. Explains how societies and nations can be measured by the degree that
power...
3:11 AM · Jan 29, 2021 · Twitter Web App

January 29,
2021
7:50 p.m.



Darrell James hill
[@DarBenThu1](https://twitter.com/DarBenThu1)

This entry is the :pdf-'claim' for :property-stolen sent to addressees 01/15/2021
Friday~

<https://blackandbluesoulsmatter.files.wordpress.com/2021/01/claim-to-court-all.pdf>

This is the Letter to Joseph-Robinette, et al.- man-actgors with, claim was attached,
sent 01/28/2021~

<https://blackandbluesoulsmatter.files.wordpress.com/2021/01/2021-jan-26-ltr-to-potus-6-done-all-mailg.pdf> ,

:Executor-Procurator, -:mitigation of the Trustee-derelict- damages ~

109 / 206

2022-011769 MISC Page: 2437 of 2782
09/26/2022 03:35:37 PM Receipt #: 22-9381
Rec Fee: \$30.00 Darrell James Hill
Gila County, Az, Sadie Jo Bingham, Recorder



2227

:Darrell-James: Hill, :Ohioan- beneficiary-Executor-Procurator, -:mitigation of the Trustee-derelict- damages: Twitter: September 24th, 2020, 7:05 p.m. - :March 9, 2021, 3:35 p.m.

~ to enable their righteous- honor.

January 29,
2021
8:20 p.m.

Darrell James hill
[@DarBenThu1](#)
01-15-2021 :claim/property <https://blackandbluesoulsmatteocourt-all.pdf> 01-19-2021 :Maricopa- clerk denies court access. 01-22-2021 :Letter to Maricopa court.01-28-2021 :claim to Joseph-Robinette, et al., :POTUS, et al. - <https://blackandbluesoulsmattean-26-ltr-to-potus-6-8:20 PM> · Jan 29, 2021 · Twitter Web App

January 29,
2021
8:20 p.m.

Darrell James hill
[@DarBenThu1](#)
01-15-2021 :claim/property <https://blackandbluesoulsmatteocourt-all.pdf> 01-19-2021 :Maricopa- clerk denies court access. 01-22-2021 :Letter to Maricopa court 01-28-2021 :claim to Joseph-Robinette, et al., :POTUS, et al. - <https://blackandbluesoulsmattean-26-ltr-to-potus-6-8:20 PM> · Jan 29, 2021 · Twitter Web App

January 29,
2021
9:55 p.m.



Darrell James hill
[@DarBenThu1](#)
[@matthewjpagano](#)
[@tomhals](#)
[@elianavjohnson](#)
[@JeremiahWillett](#)
[@DE_DOJ](#)
[@jeremiahcota](#)
[@kokanovich](#)
[@Fabian Estrada](#)
[@Jennifer Fox10](#)
[@yasminv](#)
This is the follow-up. Starting in 2016 A.D. Barack &Loretta to Donald-John: Trump unto dishonor/theft. Now, is Joseph-R: in honor or dishonor?
Quote Tweet

2228
UN

:Executor-Procurator, -:mitigation of the Trustee-derelict- damages ~

2022-011769 MISC Page: 2438 of 2782
09/26/2022 03:35:37 PM Receipt #: 22-9381
Rec Fee: \$30.00 Darrell James Hill
Gila County, Az, Sadie Jo Bingham, Recorder



Darrell James Hill on Twitter: This entry is the pdf-claim for property-stolen sent to addressees 01/15/2021 Friday- https://t.co/MoozInCvgF This is the Letter to Joseph-Robinette, et al.-men-actgors with, claim was attached, sent 01/28/2021- ...https://blackandbluesoulsmatter.files.wordpress.com/2021/01/claim-to-court-all.pdf ...
File Edit View History Bookmarks Tools Help
All Mail - djhill X New Tab X Onkyo receiver X Apache Junction X WunderMap X Inbox (107) X Total Praise X Darrell James Hill X b-1020-intro X a-2020-09-20 X New Tab X
Getting Started EXECUTIVE ORDERS REF COMMERCE DAVID STRAIGHTERS AJ

← Thread
This entry is the pdf-claim for property-stolen sent to addressees 01/15/2021 Friday- ...https://blackandbluesoulsmatter.files.wordpress.com/2021/01/claim-to-court-all.pdf ...
This is the Letter to Joseph-Robinette, et al.-men-actgors with, claim was attached, sent 01/28/2021- ...https://blackandbluesoulsmatter.files.wordpress.com/2021/01/2021-jan-26-ltr-to-potus-6-done-all-mailg.pdf ...
to enable their righteous-honor.
7:50 PM · Jan 29, 2022
View Tweet activity

Tweet Analytics

Darrell James Hill @DarBenThu1
This entry is the pdf-claim for property-stolen sent to addressees 01/15/2021 Friday- ...https://blackandbluesoulsmatter.files.wordpress.com/2021/01/claim-to-court-all.pdf ...
This is the Letter to Joseph-Robinette, et al.-men-actgors with, claim was attached, sent 01/28/2021- ...https://blackandbluesoulsmatter.files.wordpress.com/2021/01/2021-jan-26-ltr-to-potus-6-done-all-mailg.pdf ...
to enable their righteous-honor.

Impressions	122
times people saw this Tweet on Twitter	
Total engagements	9
times people interacted with this Tweet	

[View all engagements](#)

people
James Hill
enThu1
Ysrael -civilian, -Ohioan,
ficiary, DOI-1776-A.D.,
33-A.D.; Amb. of Yushuah to
n-redeemer/ Ysrael & Trustee;
sion-1213-A.D.
pening
re waiting on ABC
Bella
ture today!
ma Bloom
Messages



Darrell James Hill on Twitter: 01-15-2021 :claim/property https://blackandbluesoulsmatte-to-court-all.pdf 01-19-2021 :Maricopa- clerk denies court access. 01-22-2021 :Letter to Maricopa court 01-28-2021 :claim to Joseph-Robinette, et al., :POTUS

File Edit View History Bookmarks Tools Help

All Mail - djhill X New Tab X Onkyo receive X Apache Junct X WunderMap X Inbox (107) X Total Prize - Y X Darrell James Hill X b-1020-intro X a-2020-09-20 X New Tab X

https://twitter.com/DarBenThu1/status/1355355231895228418/analytics 150% i'll never be more loved

Getting Started EXECUTIVE ORDERS REF COMMERCE DAVID STRAIGHTERS AJ

Tweet Analytics

Darrell James Hill @DarBenThu1
 01-15-2021 :claim/property https://blackandbluesoulsmatte-to-court-all.pdf
 01-19-2021 :Maricopa- clerk denies court access.
 01-22-2021 :Letter to Maricopa court
 01-28-2021 :claim to Joseph-Robinette, et al., :POTUS, et al. --
 https://blackandbluesoulsmattean-26-ltr-to-potus-6-

Impressions	3,895
times people saw this Tweet on Twitter	
Total engagements	21
times people interacted with this Tweet	

[View all engagements](#)

1 Retweet 1 Quote

Promote your Tweet

1 message

Tweet your reply

people

James Hill
 Darrell James Hill
 Ysrael, -civilian, -Ohioan,
 iciary: DOI-1776-A.D.,
 33-A.D.; Amb. of Yushuah to
 n-redeemer/ Ysrael & Trustee:
 sion-1213-A.D.

opening

ago

te airing on ABC

an. Bill

ture today!

min Bloom

Tuesday November 9, 21:47

Tweet

Darrell James
01-16-2021 :claim/
01-19-2021 :Marc
01-22-2021 :Letter
01-23-2021 :claim
<https://blackandbl...>
9:55 PM - Jan 29, 2021
View Tweet activity
1 Retweet 1 Quote

Tweet Analytics

Darrell James Hill @DarBenThu1
@matthewjpagano
@tomhals
@elianayjohnson
@JeremiahWillett
@DE_DOJ
@jeremiahcota
@kokanovich
@Fabian_Estrada
@Jennifer_Fox10
@yasminv
This is the follow-up. Starting in 2016 A.D. Barack & Loretta to Donald-John: Trump unto dishonor/theft. Now, is Joseph-R: in honor or dishonor? <https://twitter.com/DarBenThu1/status/1355355231895228418> ...

Impressions 340
times people saw this Tweet on Twitter

Total engagements 5
times people interacted with this Tweet

messages

Tuesday November 9, 21:46

:Darrell-James: Hill, :Ohioan- beneficiary-Executor-Procurator, -:mitigation of the Trustee-derelict- damages: Twitter: September 24th, 2020, 7:05 p.m. - :March 9, 2021, 3:35 p.m.

Darrell James hill
@DarBenThu1
01-15-2021 :claim/property <https://blackandbluesoulsmatterto-court-all.pdf> 01-19-2021 :Maricopa- clerk denies court access. 01-22-2021 :Letter to Maricopa court 01-28-2021 :claim to Joseph-Robinette, et al., :POTUS, et al. - <https://blackandbluesoulsmattean-26-ltr-to-potus-6-9:55 PM> · Jan 29, 2021 · Twitter Web App

January 31, 2021
1:04 p.m.

Darrell James hill
@DarBenThu1
01-15-2021 :claim/property <https://blackandbluesoulsmatter.files.wordpress.com/2021/01/claim-to-court-all.pdf>:Maricopa- clerk denies court access. 01-28-2021 :Letter to Maricopa court 01-28-2021 :claim to Joseph-Robinette, et al., :POTUS, et al. - <https://blackandbluesoulsmatter.files.wordpress.com/2021/01/2021-jan-26-ltr-to-potus-6-done-all-mailg.pdf> 1:04 PM · Jan 31, 2021 · Twitter Web App

January 31, 2021
2:01 p.m.

Darrell James hill
@DarBenThu1
You day cometh. Thousands of Russians take to streets to demand release of jailed opposition leader



:Darrell-James: Hill, :Ohioan- beneficiary-Executor-Procurator, -:mitigation of the Trustee-derelict- damages: Twitter: September 24th, 2020, 7:05 p.m. - :March 9, 2021, 3:35 p.m.



youtube.com
Thousands of Russians take to streets to demand release of jailed...
Opposition leader Alexei Navalny came back to Russia after being poisoned. As soon as he landed, he was jailed, which propelled thousands to take to the stre...
2:01 PM · Jan 31, 2021 · Twitter Web App

February 1,
2021
11:54 a.m.

Darrell James hill
[@DarBenThu1](#)
You gotta hear this. Got from: Crystal Dunn Soubrier
[@Cdunn19](#)
of :Nov 4, 2020

Quote Tweet



shannon sharpe
[@ShannonSharpe](#): MERICA NEEDS TO HEAR THIS. 11:54 AM · Feb 1, 2021 · Twitter Web App
<https://twitter.com/i/status/1324103720611708929>

February 1,
2021
11:55 a.m.



Darrell James hill
[@DarBenThu1](#)
You gotta hear this. Got from: Crystal Dunn Soubrier
[@Cdunn19](#)

2033 :Executor-Procurator, -:mitigation of the Trustee-derelict- damages ~

112 / 206

2022-011769 MISC Page: 2443 of 2782
09/26/2022 03:35:37 PM Receipt # 22-9361
Rec Fee: \$30.00 Darrell James Hill
Gila County, Az, Sadie Jo Bingham, Recorder



Browser tabs: All Mail, New Tab, Onkyo receiv..., ApacheJunct..., WunderMap..., M: Inbox (107), Total Praise..., Darrell James..., b-1020-intro..., a-2020-09-20..., New Tab

Address bar: https://twitter.com/DarBenThu1/status/1355970317026398210/analytics

Browser buttons: Back, Forward, Home, Refresh, Stop, Print, Share, Download, Zoom (150%), Full Screen, Settings

Browser extensions: Getting Started, EXECUTIVE ORDERS, REF, COMMERCE, DAVID STRAIGHTERS, AJ

Tweet Analytics

Darrell James hill @DarBenThu1
01-15-2021 :claim/property ...https://blackandbluesoulsmatter.files.wordpress.com/2021/01/claim-to-court-all.pdf:Maricopa- ... clerk denies court access.
01-28-2021 :Letter to Maricopa court 01-28-2021 :claim to Joseph-Robinette, et al., :POTUS, et al. - ...https://blackandbluesoulsmatter.files.wordpress.com/2021/01/2021-jan-26-ltr-to-potus-6-done-all-mailg.pdf ...

Impressions	220
times people saw this Tweet on Twitter	
Total engagements	8
times people interacted with this Tweet	

[View all engagements](#)

Twitter navigation: Home, Search, Tweet, Activity, Profile, Messages

Footer: Tuesday November 9, 21:46

Tweet Analytics

Darrell James Hill @DarBenThu1
You day cometh.
Thousands of Russians take to streets to demand release of jailed opposition leader
<https://www.youtube.com/watch?v=b3-gE27Z7s8> ...

Impressions times people saw this Tweet on Twitter	208
Media views all views (autoplay and click) of your media are counted across videos, vines, gifs, and images	1
Total engagements times people interacted with this Tweet	2

[View all engagements](#)

2:01 PM - Jan 31, 2022

Tweet your reply

Twitter navigation icons: Home, Search, Notifications, Messages, Profile, Plus

Footer: Tuesday November 9, 21:46

Tweet

22M views

11:54 AM • Feb 1, 2020

View Tweet activity

Tweet Analytics

Darrell James Hill @DarBenThu1
You gotta hear this. Got from: Crystal Dunn Soubrier @Cdunn19 of :Nov 4, 2020
[https://twitter.com/ShannonSharpe/status/1324103720611708929 ...](https://twitter.com/ShannonSharpe/status/1324103720611708929)

Impressions	221
times people saw this Tweet on Twitter	
Total engagements	2
times people interacted with this Tweet	

[View all engagements](#)

Promote your Tweet

09/26/2022 03:35:47 PM Receipt #: 22-9381
Rec Fee: \$30.00 Darrell James Hill
Gila County, Az, Sadie Jo Bingham, Recorder



Darrell James hill on Twitter: "You gotta hear this. Got from: Crystal Dunn Soubrier @Cdunn19 :Nov 4, 2020 https://t.co/v9sDKlwm" / Twitter - Mozilla Firefox

File Edit View History Bookmarks Tools Help

All Mail - djhill X New Tab X Onkyo receive X Apache Junct X WunderMap X M Inbox (107) - c X Total Probe - X Darrell James Hill X b-1020-intro X a-2020-09-20 X New Tab X

https://twitter.com/DarBenThu1/status/1356315277512769536/analytics 150%

Getting Started EXECUTIVE ORDERS REF COMMERCE DAVID STRAIGHTERS AJ

BREAKING!

EL 22M views

11:55 AM Feb 1, 2020

View Tweet activity

Tweet your photos

Tweet Analytics

Darrell James Hill @DarBenThu1

You gotta hear this. Got from: Crystal Dunn Soubrier @Cdunn19 :Nov 4, 2020

[https://twitter.com/ShannonSharpe/status/1324103720611708929 ...](https://twitter.com/ShannonSharpe/status/1324103720611708929)

Impressions	248
times people saw this Tweet on Twitter	
Total engagements	3
times people interacted with this Tweet	

View all engagements

Promote your Tweet

messages

Tuesday November 9, 21:45



:Darrell-James: Hill, :Ohioan- beneficiary-Executor-Procurator, -:mitigation of the Trustee-derelict- damages: Twitter: September 24th, 2020, 7:05 p.m. - :March 9, 2021, 3:35 p.m.

	<p>:Nov 4, 2020</p> <p>Quote Tweet</p>  <p>shannon sharpe @ShannonSharpe</p> <p>AMERICA NEEDS TO HEAR THIS.</p> <p>https://twitter.com/i/status/1324103720611708929</p> <p>11:55 AM · Feb 1, 2021 · Twitter Web App</p>
<p>February 2, 2021 2:05 p.m.</p>	<p>Darrell James hill @DarBenThu1</p> <p>Shalom. Desirous to help finance this : a1) ambassador of the Most-High-God ~the Ancient-of Days~, & a2) -Trustee: Concession-1213-A.D., or b1) -Negro-Ysrael, -beneficiary, -:civilian, -:Ohioan-debenture: EBA-1933-A.D., & b2) kinsman redeemer? Pray, and listen to our Creator.</p> <p>2:05 PM · Feb 2, 2021 · Twitter Web App</p>
<p>February 2, 2021 2:43 p.m.</p>	<p>Darrell James hill @DarBenThu1</p> <p>Please consider this: The ':Monarch -program' was implemented from the 1950's on the USofA-people. Why? b/c most :USofA-people are Jacob/Isaac/Abraham - &check :this -- Ysrael/ Jacob is Black and White, and include Negroes, Irish and England and, ... yup. Says who? Says God, check</p> <p>2:43 PM · Feb 2, 2021 · Twitter Web App</p>
<p>February 2, 2021 2:43 p.m.</p>	<p>Darrell James hill @DarBenThu1</p> <p>Please consider this: The ':Monarch -program' was implemented from the 1950's on the USofA-people. Why? b/c most :USofA-people are Jacob/Isaac/Abraham - &check :this -- Ysrael/ Jacob is Black and White, and include Negroes, Irish and England and, ... yup. Says who? Says God, check</p> <p>2:43 PM · Feb 2, 2021 · Twitter Web App</p>

:Executor-Procurator, -:mitigation of the Trustee-derelict- damages ~

2238



:Darrell-James: Hill, :Ohioan- beneficiary-Executor-Procurator, -:mitigation of the Trustee-derelict- damages: Twitter: September 24th, 2020, 7:05 p.m. - :March 9, 2021, 3:35 p.m.

February 2,
2021
2:45 p.m.



Darrell James hill

[@DarBenThu1](#)

MONARCH Mind Control <https://illuminatirex.com/monarch-mind-control/>
General pop. :USofA are all alpha-type -malleable -minds. Shocked?!

Quote Tweet



Darrell James hill

[@DarBenThu1](#)

Please consider this: The 'Monarch -program' was implemented from the 1950's on the USofA-people. Why? b/c most :USofA-people are Jacob/Isaac/Abraham - &check :this -- Ysrael/ Jacob is Black and White, and include Negroes, Irish and England and, ... yup. Says who? Says God, check

2:45 PM · Feb 2, 2021 · Twitter Web App

February 2,
2021
3:14 p.m.

Darrell James hill

[@DarBenThu1](#)

On January 19, 2021, :i- man sent to the man- Donald-John ~then-POTUS, PFTUSA, POTUSA~, and to the man- James: McConville ~Army~ of the Emancipation-Proclamation..., forever~, and to Mark: Lamb~Pinal -county-Sheriff, Arizona state this: the claim/ property,

<https://blackandbluesoulsmatter.files.wordpress.com/2021/01/claim-to-court-all.pdf>

8:14 PM · Feb 2, 2021 · Twitter Web App

February 2,
2021
8:19 p.m.

Darrell James hill

[@DarBenThu1](#)

On January 28, 2021, :i-man sent man- Joseph-Robinette, -:POTUS, et al- the whole team c/o Joseph-Robinette, the claim that the previous man- Donald-John, POTUS, et al- Obama and etc., STOLE IN VIOLATION OF ALL LAW and treaty,

<https://blackandbluesoulsmatter.files.wordpress.com/2021/01/2021-jan-26-ltr-to-potus-6-done-all-mailg.pdf>

8:19 PM · Feb 2, 2021 · Twitter Web App

Quote Tweet

2239

:Executor-Procurator, -:mitigation of the Trustee-derelict- damages ~

114 / 206

2466

Tweet

Darrell James hill @DarBenThu1

Shalom. Desirous to help finance this : a1) ambassador of the Most-High-God -the Ancient-of Days-, & a2) -Trustee: Concession-1213-A.D., or b1) -Negro-Ysrael, -beneficiary, -civilian, -Ohioan- debenture: EBA-1933-A.D., or b2) kinsman redeemer? Pray, and listen to our Creator.

2:05 PM · Feb 2, 2022

View tweet activity

Tweet Analytics

Darrell James hill @DarBenThu1

Shalom. Desirous to help finance this : a1) ambassador of the Most-High-God -the Ancient-of Days-, & a2) -Trustee: Concession-1213-A.D., or b1) -Negro-Ysrael, -beneficiary, -civilian, -Ohioan- debenture: EBA-1933-A.D., or b2) kinsman redeemer? Pray, and listen to our Creator.

Impressions	213
times people saw this Tweet on Twitter	
Total engagements	2
times people interacted with this Tweet	

[View all engagements](#)

Promote your Tweet

People

James hill @DarBenThu1

Ysrael, -civilian, -Ohioan, -beneficiary: DOI-1776-A.D., or b2) kinsman redeemer/ Ysrael & trustee: Concession-1213-A.D.

opening

ago

teating on ABC

ture today!

min Bloom

2024

Darrell James hill on Twitter: "Please consider this: The 'Monarch -program' was implemented from the 1950's on the USofA-people. Why? b/c most :USofA-people are Jacob/Isaac/Abraham -& check :this -- Ysrael/ Jacob is Black and White, and incl..."

File Edit View History Bookmarks Tools Help

https://twitter.com/DarBenThu1/status/1356719916838096897/analytics

Getting Started EXECUTIVE ORDERS REF COMMERCE DAVID STRAIGHTERS AJ

Tweet Analytics

Darrell James hill @DarBenThu1
 Please consider this: The 'Monarch -program' was implemented from the 1950's on the USofA-people. Why? b/c most :USofA-people are Jacob/Isaac/Abraham -& check :this -- Ysrael/ Jacob is Black and White, and include Negroes, Irish and England and, ... yup. Says who? Says God, check

Impressions times people saw this Tweet on Twitter	583
Total engagements times people interacted with this Tweet	5

[View all engagements](#)

2:43 PM · Feb 2, 2022

1 Retweet 1 Quote

Promote your Tweet

messages

Tuesday November 9, 21:45

2022-011769 MISC Page: 2451 of 2782
 09/26/2022 03:35:37 PM Receipt #: 22-9381
 Rec Fee: \$30.00 Darrell James Hill
 Gila County, Az, Sadie Jo Bingham, Recorder



2242

Tweet

←

🏠 Home

#

🔔 Notifications

✉️ Messages

👤 Profile

🗨️ Retweets

📌 Pins

Tweet Analytics

Darrell James hill @DarBenThu1

Please consider this: The 'Monarch -program' was implemented from the 1950's on the USofA-people. Why? b/c most :USofA-people are Jacob/Isaac/Abraham -& check :this -- Ysrael/ Jacob is Black and White, and include Negroes, Irish and England and, ... yup. Says God, check

Impressions	580
times people saw this Tweet on Twitter	
Total engagements	4
times people interacted with this Tweet	

[View all engagements](#)

Promote your Tweet

people

James hill
@DarBenThu1

Ysrael, -civilian, -Ohioan,
Secretary DOI-1776-A.D.,
33-A.D.; Amb. of Yushuah to
n-redaemer/ Ysrael & Trustees,
sion-1213-A.D.

pening

ago

te airing on ABC

ture today!

anna Bloom

2243

Darrell James hill on Twitter: "MONARCH Mind Control https://t.co/Cri4BHitiJ General pop. :USofA are all alpha-type -malleable -minds. Shocked?!" / Twitter - Mozilla Firefox

File Edit View History Bookmarks Tools Help

https://twitter.com/DarBenThu1/status/1356720404983803904/analytics

Getting Started EXECUTIVE ORDERS REF COMMERCE DAVID STRAIGHTERS AJ

Tweet

2:46 PM - Feb 2, 2022

View Tweet analytics

Tweet Analytics

Darrell James hill @DarBenThu1
 MONARCH Mind Control
<https://www.illuminatirex.com/monarch-mind-control/> ...
 General pop. :USofA are all alpha-type -malleable -minds. Shocked?!
<https://twitter.com/DarBenThu1/status/1356719916838096897> ...

Impressions times people saw this Tweet on Twitter	239
Total engagements times people interacted with this Tweet	2

[View all engagements](#)

Promote your Tweet

Messages

Tuesday November 9, 21:44

2022-011769 MISC Page: 2453 of 2782
 09/26/2022 03:35:37 PM Receipt #: 22-9381
 Rec Fee: \$30.00 Darrell James Hill
 Gila County, Az, Sadie Jo Bingham, Recorder



:Darrell-James: Hill, :Ohioan- beneficiary-Executor-Procurator, -:mitigation of the Trustee-derelict- damages: Twitter: September 24th, 2020, 7:05 p.m. - :March 9, 2021, 3:35 p.m.



Darrell James hill
@DarBenThu1
On January 19, 2021, :i- man sent to the man- Donald-John ~then-POTUS, PFTUSA, POTUSA~, and to the man- James: McConville ~Army~of the Emancipation-Proclamation..., forever~, and to Mark: Lamb~Pinal -county-Sheriff, Arizona state this: the claim/ property, <https://blackandbluesoulsmatter.files.wordpress.com/2021/01/claim-to-court-all.pdf>
8:19 PM · Feb 2, 2021 · Twitter Web App

February 3,
2021
8:43 p.m.

Darrell James hill
@DarBenThu1
This is the :i- man -January 22, 2021 -covenant communication~under the Political Election~ to the Maricopa county, Arizona man-actors, regarding the denial of the right of :access to the court-of-record. :i- man am the victim here: This is criminal.

Quote Tweet

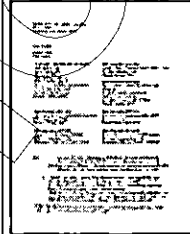
Darrell James hill
@DarBenThu1
'ya gotta shema (hebrew: see, read, do) this. Why? b/c :this, :violation of the :denial of :unalienable, -:constitutionally-protected-right(s). Trustee- 'policy' to deny beneficiary :ALL/ ANY- rights !' Not repub or dem - slave- whatever :i- man ain't making this up!
Show this thread



2022-011769 MISC Page: 2454 of 2782
09/26/2022 03:35:37 PM Receipt #: 22-9381
Rec Fee: \$30.00 Darrell James Hill
Gila County, Az, Sadie Jo Bingham, Recorder

2244

:Executor-Procurator, -:mitigation of the Trustee-derelict- damages ~



:Darrell-James: Hill, :Ohioan- beneficiary-Executor-Procurotor, -:mitigation of the Trustee-derelict- damages: Twitter: September 24th, 2020, 7:05 p.m. - :March 9, 2021, 3:35 p.m.

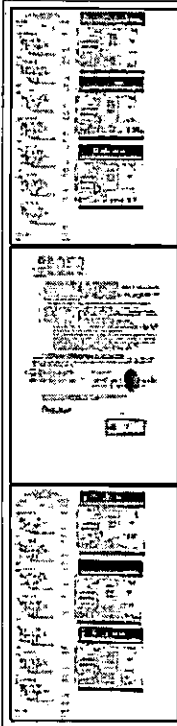

8:43 PM · Feb 2, 2021 · Twitter Web App

January 23,
2021
5:26 a.m.



Darrell James hill
[@DarBenThu1](#)

'ya gotta shema (hebrew: see, read, do) this. Why? b/c :this, :violation of the :denial of :unalienable, -:constitutionally-protected-right(s). Trustee- 'policy' to deny beneficiary :ALL/ ANY- rights !' Not repub or dem - slave- whatever :i- man ain't making this up!

2245

2246

Darrell James hill on Twitter: "On January 19, 2021, I- man sent to the man-Donald-John -then-POTUS, PFTUSA, POTUSA-, and to the man- James: McConville -Army-of the Emancipation- Proclamat... forever-, and to Mark Lamb-Pinal-county-S...

File Edit View History Bookmarks Tools Help

My All Mail - djhill X | New Tab X | Onkyo receive X | Apache Junction X | WunderMap X | M Inbox (107) X | Total Prize X | Darrell James i X | b-1020-intro X | a-2020-09-20 X | New Tab X

https://twitter.com/DarBenThu1/status/1356803154990354435/analytics 150%

Getting Started EXECUTIVE ORDERS REF COMMERCE DAVID STRAIGHTERS AJ

Tweet Analytics

Darrell James hill @DarBenThu1

On January 19, 2021, I- man sent to the man- Donald-John -then-POTUS, PFTUSA, POTUSA-, and to the man- James: McConville -Army-of the Emancipation- Proclamation... forever-, and to Mark: Lamb-Pinal -county-Sheriff, Arizona state this: the claim/ property, ...<https://blackandbluesoulsmatter.files.wordpress.com/2021/01/claim-to-court-all.pdf> ...

Impressions	513
times people saw this Tweet on Twitter	
Total engagements	8
times people interacted with this Tweet	

View all engagements

Promote your Tweet

1 Quote Tweet

Promote your Tweet

Messages

Tuesday November 9, 21:44

2022-011769 MISC Page: 2456 of 2782
 09/26/2022 03:35:37 PM Receipt #: 22-9381
 Rec Fee: \$30.00 Darrell James Hill
 Gila County, Az, Sadie Jo Bingham, Recorder



2243

Darrell James Hill on Twitter: "On January 28, 2021, I-man sent man- Joseph-Robinette, -POTUS, et al- the whole team c/o Joseph-Robinette, the claim that the previous man- Donald-John, POTUS, et al.-Obama and etc., STOLE IN VIOLATION OF ALL ..."

File Edit View History Bookmarks Tools Help

All Mail - cjhil X New Tab X Onkyo receive X Apache JUnit X WunderMap X Inbox (107) - c X Total Prase - Y X Darrell James Hill X b-1020-intro-t X a-2020-09-20 X New Tab X

https://twitter.com/DarBenThu1/status/1356804516658573312/analytics 150%

Getting Started EXECUTIVE ORDERS REF COMMERCE DAVID STRAIGHTERS AJ

Tweet Analytics

Darrell James Hill @DarBenThu1
 On January 28, 2021, I-man sent man- Joseph-Robinette, -POTUS, et al- the whole team c/o Joseph-Robinette, the claim that the previous man- Donald-John, POTUS, et al.-Obama and etc., STOLE IN VIOLATION OF ALL LAW and treaty, ...
<https://blackandbluesoulsmatter.files.wordpress.com/2021/01/2021-jan-26-ltr-to-potus-6-done-all-mailg.pdf> ... <https://twitter.com/DarBenThu1/status/1356803154990354435> ...

Impressions times people saw this Tweet on Twitter	251
Total engagements times people interacted with this Tweet	8

[View all engagements](#)

Emancipation-Pro Sheriff, Arizona st ...ndbluesoulsmatt

8:19 PM - Feb 2, 2021

View Tweet activ

Tweet yo

Messages

Tuesday November 9, 21:44

2022-011769 MISC Page: 2457 of 2782
 09/26/2022 03:35:37 PM Receipt #: 22-9381
 Rec Fee: \$30.00 Darrell James Hill
 Gila County, Az, Sadie Jo Bingham, Recorder



2248

Darrell James hill on Twitter: "This is the :i- man -January 22, 2021 -covenant communication~under the Political Election~ to the Maricopa county, Arizona man-actors, regarding the denial of the right of :access to the court-of-record.:i- man am the v..."

File Edit View History Bookmarks Tools Help

https://twitter.com/DarBenThu1/status/1356810522784489478/analytics

Getting Started EXECUTIVE ORDERS REF COMMERCE DAVID STRAIGHTERS AJ

Tweet Analytics

Darrell James hill @DarBenThu1
 This is the :i- man -January 22, 2021 -covenant communication~under the Political Election~ to the Maricopa county, Arizona man-actors, regarding the denial of the right of :access to the court-of-record.:i- man am the victim here: This is criminal.
<https://twitter.com/DarBenThu1/status/1352955745881341953> ...

Impressions times people saw this Tweet on Twitter	265
Total engagements times people interacted with this Tweet	3

[View all engagements](#)

[Promote your Tweet](#)

8:43 PM • Feb 2, 2021

View Tweet activity

Messages

Privacy Policy Cookie Policy © 2021 Twitter, Inc.

2022-011769 MISC Page: 2458 of 2782
 09/26/2022 03:35:37 PM Receipt #: 22-9381
 Rec Fee: \$30.00 Darrell James Hill
 Gila County, Az, Sadie Jo Bingham, Recorder





:Darrell-James: Hill, :Ohioan- beneficiary-Executor-Procurator, -:mitigation of the Trustee-
derelict- damages: Twitter: September 24th, 2020, 7:05 p.m. - :March 9, 2021, 3:35 p.m.

Darrell-James: Hill, -:civilian, -:Executor
PO Box 3808
Apache Junction, Arizona 85117

:man :personl,

Arizona state
Pinal county

USPO CMN 7009 2820 0003 9570 7942

:Jack: Sellers, :Dist.- 1,
:Steve: Chucra, :Dist.- 2,
:Bill: Gates, :Dist.- 3,
:Clint: Hickman, :Dist.- 4,
:Steve: Galardo, :Dist.- 5,
:Maricopa County Board of Supervisors
c/o: Fran: McCarroll, -:Clerk
301 West Jefferson Street
Phoenix, Arizona 85003

7009 2820 0003 9570 7959

:Joseph: Walty, -: Maricopa county Judge, -:Chief
201 West Jefferson Street
Phoenix, Arizona 85003

7009 2820 0003 9570 7966

:Pamela: Galas, -: Maricopa county Judge,
-:Presiding
c/o : Keith: Kaplan, -:Administrator
Civil Court Administration
201 West Jefferson Street, 4th Floor
Phoenix, Arizona 85003

7009 2820 0003 9570 7973

:Jeff: Fine, -:Maricopa county Clerk of the Court
620 West Jackson Street
Phoenix, Arizona 85003

7009 2820 0003 9570 7980

:Paul: Penzone, -:Maricopa county Sheriff
550 West Jackson
Phoenix Arizona state 85003

7009 2820 0003 9570 7997

:Joseph-Robinette: Biden, -:POTUS
1600 Pennsylvania Ave NW
Washington, District of Columbia 20500

7009 2820 0003 9570 8000

:Marty: Wilkinson, -:CLT, U.S. Atty.-General
950 Pennsylvania Avenue, NW
Washington, Dist. Of Columbia 20530-0001

RE: A

January 19th, 2021- Deprivation of Rights to the Court of Record for
:claim: :matter # RE 322 398 389 US at the Maricopa county Court;
the Second Level Offense :in Accordance with the Covenant-agreement in the
Election: See: Gila county Recorder, Doc.# 2017-002378, pp. 1-4, et seq.

re: :notice: ;see claim: :matter # RE 322 398 389 US - See- appended: claim -
executed; declaration: right of claim, with: declarabon: averments: - claimant; -
See- appended: Respondent: declaration: stipulations; procurator as respondent; -
Notice of receipt of claim; formal summons waved *;
USPO Jan. 15, 2021 to: - Donald-John: Trump - USPO CMN 7008 1830 0002 1028
2082; :James: McConville - CMN 7009 2820 0003 8851 6100; :Mark: Lamb - 7010
1060 0001 7518 9154; and: Paul: Penzone - 7012 2210 0000 4269 7384.

1 -CLT, U.S. Atty.-General means: the United States-corp attorney general is also the 'common-
tive-trustee' for the United-States-of-America- people.



:Darrell-James: Hill, :Ohioan- beneficiary-Executor-Procurator, -:mitigation of the Trustee-
 derelict- damages: Twitter: September 24th, 2020, 7:05 p.m. - :March 9, 2021, 3:35 p.m.

Product	Qty	Unit Price	Price
01/22/2021 10:56 AM			
151 W SUPERSTITION BLVD APACHE JUNCTION, AZ 85120-8998 (602)275-8777			
First-Class Mail® Letter	1	\$3.55	\$3.55
Phoenix, AZ 85003 Weight: 0 lb 0.50 oz Estimated Delivery Date Mon 01/25/2021 Certified Mail® Tracking #: 7009282000395707942			
Total			\$4.10
First-Class Mail® Letter	1	\$3.55	\$3.55
Washington, DC 20530 Weight: 0 lb 0.50 oz Estimated Delivery Date Tue 01/26/2021 Certified Mail® Tracking #: 7009282000395708000			
Total			\$4.10
First-Class Mail® Letter	1	\$3.55	\$3.55
Washington, DC 20500 Weight: 0 lb 0.50 oz Estimated Delivery Date Tue 01/25/2021 Certified Mail® Tracking #: 7009282000395707997			
Total			\$4.10
First-Class Mail® Letter	1	\$3.55	\$3.55
Phoenix, AZ 85003 Weight: 0 lb 0.40 oz Estimated Delivery Date Mon 01/25/2021 Certified Mail® Tracking #: 7009282000395707960			
Total			\$4.10
First-Class Mail® Letter	1	\$3.55	\$3.55
Phoenix, AZ 85003 Weight: 0 lb 0.50 oz Estimated Delivery Date Mon 01/25/2021 Certified Mail® Tracking #: 7009282000395707973			
Total			\$4.10
First-Class Mail® Letter	1	\$3.55	\$3.55
Phoenix, AZ 85003 Weight: 0 lb 0.50 oz Estimated Delivery Date Mon 01/25/2021 Certified Mail® Tracking #: 7009282000395707959			
Total			\$4.10
Grand Total:			\$28.70
Each Package		\$40.00	\$40.00
Postage			\$11.97

U.S. Postal Service - CERTIFIED MAIL RECEIPT (Domestic Mail Only, No Insurance Coverage Provided)	
For delivery information visit our website at www.usps.com.	
PS Form 3800, August 2018	
PSN 7500-01-000-9570-7959	
Package #	0130 60
Postage	\$3.55
Certified Fee	\$0.00
Return Receipt Fee (Endowment Required)	\$0.00
Registered Delivery Fee (Endowment Required)	\$0.00
Total Package & Fees	\$3.55
Postmark	Jan 22 2021
Sent To: <u>201 W Jackson Street</u> Phoenix, AZ 85003	

U.S. Postal Service - CERTIFIED MAIL RECEIPT (Domestic Mail Only, No Insurance Coverage Provided)	
For delivery information visit our website at www.usps.com.	
PS Form 3800, August 2018	
PSN 7500-01-000-9570-7960	
Package #	0130 60
Postage	\$3.55
Certified Fee	\$0.00
Return Receipt Fee (Endowment Required)	\$0.00
Registered Delivery Fee (Endowment Required)	\$0.00
Total Package & Fees	\$3.55
Postmark	Jan 22 2021
Sent To: <u>201 W Jackson Street</u> Phoenix, AZ 85003	

U.S. Postal Service - CERTIFIED MAIL RECEIPT (Domestic Mail Only, No Insurance Coverage Provided)	
For delivery information visit our website at www.usps.com.	
PS Form 3800, August 2018	
PSN 7500-01-000-9570-7966	
Package #	0130 60
Postage	\$3.55
Certified Fee	\$0.00
Return Receipt Fee (Endowment Required)	\$0.00
Registered Delivery Fee (Endowment Required)	\$0.00
Total Package & Fees	\$3.55
Postmark	Jan 22 2021
Sent To: <u>201 W Jackson Street</u> Phoenix, AZ 85003	

U.S. Postal Service - CERTIFIED MAIL RECEIPT (Domestic Mail Only, No Insurance Coverage Provided)	
For delivery information visit our website at www.usps.com.	
PS Form 3800, August 2018	
PSN 7500-01-000-9570-7973	
Package #	0130 60
Postage	\$3.55
Certified Fee	\$0.00
Return Receipt Fee (Endowment Required)	\$0.00
Registered Delivery Fee (Endowment Required)	\$0.00
Total Package & Fees	\$3.55
Postmark	Jan 22 2021
Sent To: <u>201 W Jackson Street</u> Phoenix, AZ 85003	

2250
UN

:Executor-Procurator, -:mitigation of the Trustee-derelict- damages ~

:Darrell-James: Hill, :Ohioan- beneficiary-Executor-Procurator, -:mitigation of the Trustee-derelict- damages: Twitter: September 24th, 2020, 7:05 p.m. - :March 9, 2021, 3:35 p.m.

7009 2820 0003 9570 7942
7009 2820 0003 9570 7959
7009 2820 0003 9570 7966
7009 2820 0003 9570 7973

Greetings,

I. DEPRIVATION OF RIGHT TO THE COURT-OF-RECORD

- 1) I- man am :Darrell-James: Hill, -civilian-beneficiary, -Ohioan, -habitant on Arizona- state See: Gila county Recorder, Doc.# 2017-002378, pp. 1-4, et seq.
- 2) You are :trustees-under-oath to advantage I- man- beneficiary under :covenant-agreements to assure the :constitution-protected -unimpeded-access to the 'court-of-record', et al- Trustee duties and obligations.
- 3) I- man endure damage to date by the denial of 'right to access the Court-of-record on: January 19th, et seq- era until the restoration of this right -in -property. To wit:
- 4) Your :clerks at the Maricopa county Court, location: 222 East Javolina Avenue state that your policy denies I- man the :unalienable and constitutionally-protected right to access the 'court of record' at the Maricopa county, Arizona state.
- 5) As your policy may have been misapplied to harm I- man; alternatively,
 - o I- man wish that you- Trustees restore the right to the court-of-record upon the day of this receipt, and place urgent notice to I- man that the restoration of :right to the court-of-record is forever-present to I- man-beneficiary.
 - o By the :covenant-agreement, this :January 19th 2021 -denial of :right is the 'Second-level offense', ~ see: Doc.# 2017-002378, p. 21-, where is :penalty for :deprivation of :rights started at: 11:00 am, January 19, 2021, and lasting until the resolve of the matter, with :express- procurator -in the property and penalty- claims.
 - o The First Bill of Particulars will follow upon the end of this month.

ii. Trespass Upon The Respondent in The Hill-Court Matter

The man- actors- :POTUS and Common-Law-Trustee are notified herein as the :any-harm of the related :constitutional- violation upon them is beyond the covenant- procurator- agreement for the :claim # RE 322 388 388 US.

7009 2820 0003 9570 8000
7009 2820 0003 9570 7997
7009 2820 0003 9570 7980

Without-prejudice

darrell-james *Execute*
:darrell-james: Hill - beneficiary - procurator

Affirmed and autographed before me this 22 day January 2021 A.D.
Type of Identification: Arizona Driver License

Cheryl Hill
Notary-Public

SEAL



2022-011769 MISC Page: 2461 of 2782
09/28/2022 03:35:37 PM Receipt #: 22-9381
Rec Fee: \$30.00 Darrell James Hill
Gila County, Az, Sadie Jo Bingham, Recorder





:Darrell-James: Hill, :Ohioan- beneficiary-Executor-Procurator, -:mitigation of the Trustee-derelict- damages: Twitter: September 24th, 2020, 7:05 p.m. - :March 9, 2021, 3:35 p.m.

APACHE JUNCTION 354 W SUPERSTITION BLVD APACHE JUNCTION, AZ 85120-8922 (602)275-8777			
01/22/2021			10:56 AM
Product	Qty	Unit Price	Price
First-Class Mail®	1		\$0.55
Letter			
Phoenix, AZ 85003 Weight: 0 lb 0.50 oz Estimated Delivery Date Mon 01/23/2021 Certified Mail® Tracking # 70092820000395707942			
Total			\$4.10
First-Class Mail®	1		\$0.55
Letter			
Washington, DC 20530 Weight: 0 lb 0.50 oz Estimated Delivery Date Tue 01/26/2021 Certified Mail® Tracking # 70092820000395709000			
Total			\$4.10
First-Class Mail®	1		\$0.55
Letter			
Washington, DC 20500 Weight: 0 lb 0.50 oz Estimated Delivery Date Tue 01/26/2021 Certified Mail® Tracking # 70092820000395707997			
Total			\$4.10
First-Class Mail®	1		\$0.55
Letter			
Phoenix, AZ 85003 Weight: 0 lb 0.40 oz Estimated Delivery Date Mon 01/23/2021 Certified Mail® Tracking # 70092820000395707980			
Total			\$4.10
First-Class Mail®	1		\$0.55
Letter			
Phoenix, AZ 85003 Weight: 0 lb 0.40 oz Estimated Delivery Date Mon 01/23/2021 Certified Mail® Tracking # 70092820000395707965			
Total			\$4.10
First-Class Mail®	1		\$0.55
Letter			
Phoenix, AZ 85003 Weight: 0 lb 0.50 oz Estimated Delivery Date Mon 01/23/2021 Certified Mail® Tracking # 70092820000395707973			
Total			\$4.10
First-Class Mail®	1		\$0.55
Letter			
Phoenix, AZ 85003 Weight: 0 lb 0.50 oz Estimated Delivery Date Mon 01/23/2021 Certified Mail® Tracking # 70092820000395707959			
Total			\$4.10
Grand Total			\$28.70
Cash			\$40.00

U.S. Postal Service CERTIFIED MAIL - RECEIPT (Domestic Mail Only; No Insurance Coverage Provided)	
For delivery information visit our website at www.usps.com	
Use only for OFFICIAL USE	
Postage	\$0.55
Certified Fee	\$0.00
Return Receipt Fee (Endorsement Required)	\$0.00
Postage & Fees	\$0.55
Postmark	01/22/2021
To: <i>Paul Penzone</i> 350 West Jackson Phoenix, Arizona 85003	

U.S. Postal Service CERTIFIED MAIL - RECEIPT (Domestic Mail Only; No Insurance Coverage Provided)	
For delivery information visit our website at www.usps.com	
Use only for OFFICIAL USE	
Postage	\$0.55
Certified Fee	\$0.00
Return Receipt Fee (Endorsement Required)	\$0.00
Postage & Fees	\$0.55
Postmark	01/22/2021
To: <i>Monica Wilkinson</i> 4901 Pennsylvania Ave NW Washington, District of Columbia	

U.S. Postal Service CERTIFIED MAIL - RECEIPT (Domestic Mail Only; No Insurance Coverage Provided)	
For delivery information visit our website at www.usps.com	
Use only for OFFICIAL USE	
Postage	\$0.55
Certified Fee	\$0.00
Return Receipt Fee (Endorsement Required)	\$0.00
Postage & Fees	\$0.55
Postmark	01/22/2021
To: <i>Joseph Kibratte - Biden</i> 1100 Pennsylvania Ave NW Washington, D.C. 20500	

5:26 AM · Jan 23, 2021 · Twitter Web App

2252
UN

:Executor-Procurator, -:mitigation of the Trustee-derelict- damages ~



:Darrell-James: Hill, :Ohioan- beneficiary-Executor-Procurator, -:mitigation of the Trustee-derelict- damages: Twitter: September 24th, 2020, 7:05 p.m. - :March 9, 2021, 3:35 p.m.

February 4,
2021
3:27 a.m.



Darrell James Hill
[@DarBenThu1](#)

Did you know this? Capitol Building fence is blocking D.C. laws from approval

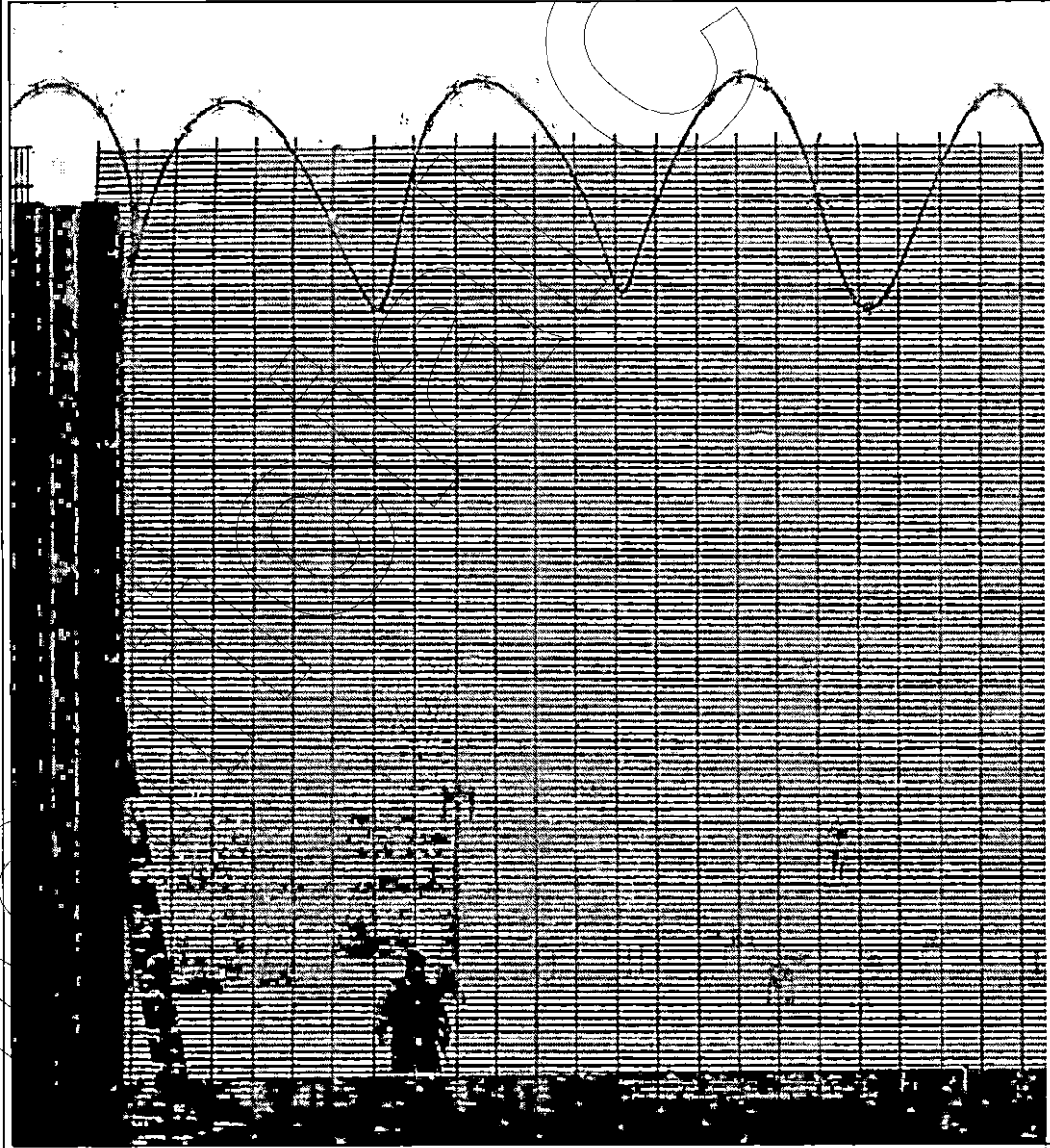

2253



:Darrell-James: Hill, :Ohioan- beneficiary-Executor-Procurator, -:mitigation of the Trustee-derelict- damages: Twitter: September 24th, 2020, 7:05 p.m. - :March 9, 2021, 3:35 p.m.

[pbs.org](https://www.pbs.org)
Capitol Building fence is blocking D.C. laws from approval
That foreboding black fence erected around the U.S. Capitol building has had an unintentional side effect: walling off the local government's ability to enact new laws.
3:27 AM · Feb 4, 2021 · Twitter Web App

February 5,
2021
6:06 a.m.



Darrell James hill
[@DarBenThu1](https://twitter.com/DarBenThu1)
Twitter, YOU, et al. are a corporation / UNITED STATES Corp.- govsvcpvider-Trustee for: United States of America, people-beneficiary, et al.- :i- man, :Darrell-James: Hill. Restore :all-content to cease harming :i- man. Restructuring :i- man content is denied. You are noticed.
6:06 AM · Feb 5, 2021 · Twitter Web App

February 5,
2021
2:57 p.m.



Darrell James hill
[@DarBenThu1](https://twitter.com/DarBenThu1)
:cousin, 1) See: 'deny :U.S.-Corp. to ':state' -people statuses' written for :i- man, sole or lone, and as 'kinsman-redeemer' for Negro-Ysrael, Ysrael, and Holy-Church'; 2) Note- :i- man, -:Ohioan am :Amb. of :Almighty-God :in-Trustee: Concession-1213-A.D.; 3) Your servant: Ps 91

2254

← Tweet

Did you know

Capitol Building approval

3:27 AM · Feb 4, 2022

View Tweet activity

tweet yo

Tweet Analytics

Darrell James hill @DarBenThu1
Did you know this?
Capitol Building fence is blocking D.C. laws from approval <https://www.pbs.org/newshour/politics/capitol-building-fence-is-blocking-d-c-laws-from-approval> ...

Impressions	250
times people saw this Tweet on Twitter	
Total engagements	2
times people interacted with this Tweet	

View all engagements

Promote your Tweet

James hill

Israel, =civilian, = Ohioan,iciary; DOI-1776-A.D., 33-A.D.; Amb. of Yeshua to n-redeemer/ Ysrael & Trustee, sion-1213-A.D.

pening

ago

tearing on ABC

future today!

min Bloom

etern - Trending

messages

Tuesday November 9, 21:43

2256

Tweet

Darrell James Hill
@DarBenThu1

Twitter, YOU, et al. are a corporation / UNITED STATES Corp.- govsvcp provider- Trustee for: United States of America, people-beneficiary, et al.- i- man, :Darrell-James: Hill. Restore :all-content to cease harming :- man. Restructuring :- man content is noticed.

6:06 AM Feb 5, 2022

View tweet activity

Tweet Analytics

Darrell James Hill @DarBenThu1
Twitter, YOU, et al. are a corporation / UNITED STATES Corp.- govsvcp provider- Trustee for: United States of America, people-beneficiary, et al.- i- man, :Darrell-James: Hill.
Restore :all-content to cease harming :- man. Restructuring :- man content is denied. You are noticed.

Impressions times people saw this Tweet on Twitter	245
Total engagements times people interacted with this Tweet	1

View all engagements

Promote your Tweet

People

James Hill
@DarBenThu1

Ysrael, -civilian, -Ohtoon, -beneficiary: DOI-1776-A.D., 1776-1783-A.D.; Amb. of Yushuah to Ysrael & Trustee: Ysrael-1213-A.D.

Opening

tearing on ABC

sure today!

messages

2257

Darrell James hill on Twitter: "cousin, 1) See: 'deny :U.S.-Corp. to 'state' -people statuses' written for :i- man, sole or lone, and as 'kinsman-redeemer' for Negro-Ysrael, Ysrael, and Holy-Church"; 2) Note- :i- man, -:Ohioan am :Amb. of :Almighty-God :in-Trustee: Concession-1213-A.D.; 3) Your servant: Ps 91 pic.twitter.com/o9orbBUPYR

2:57 PM • Feb 5, 2022

1 Retweet 1 Quote

View Tweet activity

Tweet Analytics

Darrell James hill @DarBenThu1

:cousin, 1) See: 'deny :U.S.-Corp. to 'state' -people statuses' written for :i- man, sole or lone, and as 'kinsman-redeemer' for Negro-Ysrael, Ysrael, and Holy-Church'; 2) Note- :i- man, -:Ohioan am :Amb. of :Almighty-God :in-Trustee: Concession-1213-A.D.; 3) Your servant: Ps 91 pic.twitter.com/o9orbBUPYR

Impressions	421
times people saw this Tweet on Twitter	
Total engagements	31
times people interacted with this Tweet	

View all engagements

Privacy Policy Cookie Policy ©2021 Twitter, Inc.

Messages

Tuesday November 9, 21:43

2022-011769 MISC Page: 2467 of 2782
 09/26/2022 03:35:37 PM Receipt #: 22-9381
 Rec Fee: \$30.00 Darrell James Hill
 Gila County, Az, Sadie Jo Bingham, Recorder





:Darrell-James: Hill, :Ohioan- beneficiary-Executor-Procurator, -:mitigation of the Trustee-derelict- damages: Twitter: September 24th, 2020, 7:05 p.m. - :March 9, 2021, 3:35 p.m.

To: Joseph-Robinette: 7009141000078685734 - Deny :U.S.-Corp. to 'state' -people statuses 1/3

Darrell-James: Hill¹-civilian, -:Executor, -:Kinsman-Redeemer
PO Box 3806
Apache Junction, Arizona 85117

:man :present; -:Ohioan

Arizona state
Pinal county

:- man ->sole and kinsman-redeemer- :declaration:
:2021 February 4th; Authority For :U.S.-Corp'-Trustee- Government-Services-Provider,
'gsp', -:Trustee: EBA-1933-A.D., To Ascend By Any-Means To The Entity-Status
Equivalency of Man-Kind: Organic-State, Subrogation or Fictional, Or A :Like
-Presumption Status,
Is Here-To-Fore And Now-To After-Denied.

To: Joseph-Robinette: Biden², -:POTUS³, et al.-> man- actors et seq.
c/o :Joseph-Robinette: Biden, -:Trustee⁴, USPS CMN 7009 1410 0000 7868 5734
600 Pennsylvania Ave NW
Washington, District of Columbia 20500

Mark-Alexander -:General United States Army-:Chairman: CJCOS- :Milley,
:John-Earl, -:General United States Air Force: Vice- CJCOS- :Hytner,
:James-Charles, -:General United States Army: COS Army- :McConville,
:David-Hilberry, -:General United States Marine Corps: CMC- :Berger,
:Michael-Martin, -:Admiral United States Navy: CNO- :Gilday,
:David-Lee, -:General United States Air Force: COS AF- :Goldfein,
:John-William, -:General United States Space Force: CSO- :Raymond,
:Joseph-Lauren, -:General United States Air Force: CNG- :Langyel,
:Karl-Lee, -:Admiral United States Coast Guard: COG- :Schultz
c/o :Mark-Alexander: Milley, -:Trustee : USPO RE 322 398 295 US
8999 Joint Staff Pentagon
Washington, Columbia Territory [D.C.- 20318-9999]

- 1 :Darrell-James: Hill means: :Covenant-agreements Statuses :in -Procurator means: Gila county, Arizona, Recorder, Doc.# 2017-002378, pp. 1- ; et seq.- #2017-00652, #2018-005176, #2019-009291, #2019-011722;- <https://recorder.gilacountyaz.gov/recordarhweb/>
- 2 :Joseph-Robinette: Biden, -:POTUS, et al.- man- actors et seq. means: Soc: USPO RMN RE 322 398 389 US , Covenant-agreements- Statuses - in -Procurator.
- 3 :POTUS means: office- status is :in- :Dishonor-2017-A.D. Ibid 2. SEE: USPO RMN RE 322 398 389 US -: Claim of -:Unalienable-Right :in-accordance With The Covenant-Agreements:... ; sent: January 28, 2021, 11:33 a.m.
- 4 :Trustee means: under legislative-oath, duty and obligation to assure and ensure advantage and use- benefit of the EBA-1933-A.D- legislative-dry-trust is disposed to the 'United States of America'- people- beneficiary-individual upon execution-in -exercise of the ANY-:beneficiary-right to remedy.

To: Joseph-Robinette: 7009141000078685734 - Deny :U.S.-Corp. to 'state' -people statuses 1/3

2258
Unofficial Copy

:Executor-Procurator, -:mitigation of the Trustee-derelict- damages ~



:Darrell-James: Hill, :Ohioan- beneficiary-Executor-Procurator, -:mitigation of the Trustee-derelict- damages: Twitter: September 24th, 2020, 7:05 p.m. - :March 9, 2021, 3:35 p.m.

To: Joseph-Robinetto: 70091410000078685734 - Deny :U.S.-Corp. to "state"-people statuses

3 / 3

grace of the Most High God and father of our Messiah Yushuah by covenant-agreements"
:Knowledge: For the any-type of 'government-service-organization -self-ascendancy to i-
man-status' however promulgated ~also including proffer by the propaganda, legislation,
executive-order, or otherwise, notwithstanding~ for the tacit-acquiescence by i- man, et al. is
now formally denied.

:Cause: For the issue of this Knowledge, the :any-proffer for ascendancy by any mean is
wholly- DENIED by this binding covenant. - :In this matter ~~definit~~ damage, procurator for the
right of remedy is set.

:Action-Required: i- man sole, and as :kinsman-redeemer, desire and require in-office, et
al. :man-actors', et seq.- TRUSTEES' :any -proffer for, to or unto :ascendancy to the organic-
state -status to the union of the 'United States of America' -people by any means is ceased,
desisted now at this autographing, and shall forever be willful-damage -criminal-trespassing.

1. :Trespassing in this matter is with the willful-offense -admitted -damage upon i- man,
-sole and :kinsman-redeemer, subject to :procurator by the PE of the kinsman-
redeemer¹¹.

Any- :you- man- actors- in-office trespassing with the procurator under the PE of
:kinsman-redeemer for each individual soul-journer under the harm is now accountable to the
intervenor: principals, agents and proxies, severally also including :man- actors in- and :office
of any institutions: ecclesiastical and non-ecclesiastical. 'United-States-Corp'- gsp. -Trustee:
EBA-1933-A.D., et seq., understanding the :covenant-agreements- all¹².

Notice to the man-actor- PRINCIPAL is sufficient notice to the man-actor-AGENT; Notice
to the man-actor-AGENT must be reported to the man-actor-PRINCIPAL.

Without-prejudice

Darrell James Hill, Executor
Darrell-James: Hill, Executor, -:Kinsman-Redeemer

Affirmed and autographed before me this 06 day, February 2021 A.D.

Clark Smith
Notary-Public



- 11 :covenant-agreement(s), et al. means: by :God to : Adam and Eve, et seq. - to :Noah, to :Shem,
to :Jacob/Ysrael, to i- man, son of :Clarence and Ora, children of :Jacob/Ysrael. Ibid 1
- 12 :PE of the Kinsman-redeemer means: Ibid 1.
- 13 :covenant-agreements means: Ibid 1, 2, 3, 5, 6, 7, 8, 9, 11, 12.

To: Joseph-Robinetto: 70091410000078685734 - Deny :U.S.-Corp. to "state"-people statuses

3 / 3

7009 1410 0000 7868 5734

:Executor-Procurator, -:mitigation of the Trustee-derelict- damages ~

124 / 206

2259



:Darrell-James: Hill, :Ohioan- beneficiary-Executor-Procurotor, -:mitigation of the Trustee-derelict- damages: Twitter: September 24th, 2020, 7:05 p.m. - :March 9, 2021, 3:35 p.m.

To: Joseph-Robinette: 7009141000078685734 - Deny :U.S.-Corp. to 'state'-people statuses 2/3

Re: **FORMAL-DENIAL -**

:Derived-Authority, for the government-services-provider -in-fiction, et seq.- :self-
Indentured-: EBA-1933-A.D.-Trustee to :debentured- :i- man, et al.- Darrell-James: Hill,
-:kinsman- redeemer of :Negro-Ysrael, Ysrael and Holy Church- :In- accordance with the
covenant-agreement's is DENIED.

:Trespassing upon the delimit is an offense with willful-damage upon :i- man -sole
and kinsman-redeemer, subject to procuration⁶ :in- accordance with the covenant-
agreement⁷.

Greetings :Joseph-Robinette, :Mark-Alexander, et al.:

:i- man, sole, and as kinsman redeemer, appreciate your righteous-service to the
beneficiary, -:United States of America- people.

:Non-authorization for the 'UNITED STATES-CORP'- Trustee: government-services-
provider -self-indentured-legislative-Trustee of: EBA-1933-A.D.-,
ascendancy to :i- man-status
is with the right to :remedy for the offense
by :procuration-agreement⁶

Authority: :i- man-Darrell-James: Hill, -sole and kinsman-redeemer¹⁰

A. :i- man -Darrell-James: Hill, -:Negro, -inherom-beneficiary by: Almighty-God; -civilian,
-Ohioan; debentured-beneficiary: EBA-1933-A.D., for :i- man -sole and kinsman-redeemer for
:all- Negro-Ysrael, Ysrael and the Holy Church, and, for all, except the individual- soul-
journeyor by the express-behest, am;

B. :i- man -ambassador of the Almighty-God am :Trustee: Concession-1213-A.D. by the

5 :covenant-agreements means: :covenant-agreement(s), et al. means: under the :Almighty-
God - :1776 A.D.- People Constitution: Declaration of Independence: 1777 A.D. States'
Constitution: Articles of Confederacy, 1787-1789 A.D. 'The Constitution for the United States of
America', -non-incorporated: permissions, duty, obligations and limitations- 'in - service to and
for the United States of America -people by :standard-guarantee of the republican form of
government'.

6 :Procuration means: Ibid 1. for the recovery of damages.

7 :covenant-agreement means: Ibid 1. by the right of the 'political-election' -right is :executed

8 :EBA-1933-A.D. means: the Emergency Banking Act of 1933, -2003 legislative 'dry-ust' is over.
:i- man -sole -wish for right of separation-account, settle and closure is executed- and
:kinsman-redeemer -demand for :right of separation executed for Negro-Ysrael, Ysrael and
Holy Church.

9 :covenant-agreement(s), et al. means: :Covenant-agreements Statutes :in -Procuraton
means: Ibid 1, 2, 3, 5, 6, 7, . -https://recorder.gilacountyaz.gov/recorder/web/

10 :kinsman-redeemer means: for: ..., all except the civilly-alive at their express-behest, am[:]
that :Express-assumpsit¹⁰ is to inundertake ones' own responsibility and liability in this matter is
NOT restricted :in -individual-spirit, soul and flesh- choice in -civil-alive- status.

To: Joseph-Robinette: 7009141000078685734 - Deny :U.S.-Corp. to 'state'-people statuses 2/3

2260

09/26/2022 03:35:37 PM Receipt #: 22-9381
Rec Fee: \$30.00 Darrell James Hill
Gila County, Az, Sadie Jo Bingham, Recorder



:Darrell-James: Hill, :Ohioan- beneficiary-Executor-Procurator, -:mitigation of the Trustee-derelict- damages: Twitter: September 24th, 2020, 7:05 p.m. - :March 9, 2021, 3:35 p.m.

UNITED STATES POSTAL SERVICE
 APACHE JUNCTION
 131 W SUPERSTITION BLVD
 APACHE JUNCTION, AZ 85120-9968
 (602)275-8777

02/05/2021 12:55 PM

Product	Qty	Unit Price	Price
First-Class Mail® Letter	1		\$0.55
Washington, DC 20500 Weight: 0 lb 0.60 oz Estimated Delivery Date Tue 02/09/2021			
Certified Mail®			\$3.50
Tracking #:			9509141000078665734
e-Return Receipt			\$1.75
Total			\$5.90
First-Class Mail® Letter	1		\$0.50
Washington, DC 20213 Weight: 0 lb 1.00 oz Estimated Delivery Date Tue 02/03/2021			
Registered Mail®			\$13.50
Account:			\$21.00
Tracking #:			9509141000078665734
Return Receipt			\$2.50
Tracking #:			9509141000078665734
Total			\$16.90
Grand Total:			\$22.80
Cash			\$22.80
Charge			-\$0.00

U.S. Postal Service - CERTIFIED MAIL RECEIPT
 (Domestic Mail Only; No Insurance Coverage Provided)

7009 1410 0000 7866 5734

OFFICIAL USE

APACHE JUNCTION, AZ
 FEB 05 2021

Registered No. **9509141000078665734** Date Stamp **FEB 05 2021**

Package \$	10.55	Extra Services & Fees	
First-Class Mail®	\$0.50	Signature Confirmation	\$2.50
Registered Mail®	\$13.50	Registered Delivery	\$1.75
Return Receipt	\$1.75	Registered Delivery	\$1.75
Tracking #	\$3.50	Tracking	\$16.90
Insurance	\$0.00		
Postage	\$0.00		
Total	\$22.80		

OFFICIAL USE

Darrell-James: Hill
 PO Box 3806
 Apache Junction, Arizona 85112

Mark-Alvarado-Rodriguez
 999 Washington St
 Washington, Colorado 80501

PS Form 3806, Registered Mail Receipt April 2015, PSN 7530-02-000-9001

2:57 PM · Feb 5, 2021 · Twitter Web App

2261

:Executor-Procurator, -:mitigation of the Trustee-derelict- damages ~



:Darrell-James: Hill, :Ohioan- beneficiary-Executor-Procurator, -:mitigation of the Trustee-derelict- damages: Twitter: September 24th, 2020, 7:05 p.m. - :March 9, 2021, 3:35 p.m.

February 6,
2021
7:20 a.m.



Darrell James hill
[@DarBenThu1](#)

[#GenMilleyOn](#) January 28, 2021, :i-man sent man- Joseph-Robinette, -:POTUS, et al- the whole team c/o Joseph-Robinette, the claim-that the previous man- Donald-John, POTUS, et al.-Obama and etc., STOLE IN VIOLATION OF ALL LAW and treaty,

<https://blackandbluesoulsmatter.files.wordpress.com/2021/01/2021-jan-26-ltr-to-potus-6-done-all-mailg.pdf>

. Quote Tweet

7:20 AM · Feb 6, 2021 · Twitter Web App

February 6,
2021
7:25 a.m.

Darrell James hill
[@DarBenThu1](#)

[#GenMilley](#):cousin, 1) See: 'deny :U.S.-Corp. to ':state' -people statuses' written for :i- man, sole or lone, and as 'kinsman-redeemer' for Negro-Ysrael, Ysrael, and Holy-Church'; 2) Note- :i- man, -:Ohioan am :Amb. of :Almighty-God :in-Trustee: Concession-1213-A.D. 3) Psalms 91



:Darrell-James: Hill, :Ohioan- beneficiary-Executor-Procurator, -:mitigation of the Trustee-derelict- damages: Twitter: September 24th, 2020, 7:05 p.m. - :March 9, 2021, 3:35 p.m.

To: Joseph-Robinette: 7009141000078685734 - Deny :U.S.-Corp. to "state" -people statuses 1/3

Darrell-James: Hill¹-civilian, -:Executor, -:Kinsman-Redeemer
PO Box 3806
Apache Junction, Arizona 85117

:man :present; -:Ohioan

Arizona state
Pinal county

:i- man -:sole and kinsman-redeemer- :declaration:
:2021 February 4th: Authority For :U.S.-Corp-:Trustee-Government-Services-Provider,
'gsp', -:Trustee: EBA-1933-A.D., To Ascend By Any-means To The Entity-Status
Equivalency of Man-Kind: Organic-State, Subrogation or Fictional, Or A :Like
-Presumption Status,
Is Here-To-Fore And Now-To After Denied.

To: Joseph-Robinette: Biden², -:POTUS³, et al- man- actors et seq.
c/o :Joseph-Robinette: Biden, -:Trustee⁴, USPS CMN 7009 1410 0000 7868 5734
600 Pennsylvania Ave NW
Washington, District of Columbia 20500

Mark-Alexander -:General United States Army-:Chairman: CJCOS- :Milley,
:John-Earl, -:General United States Air Force: Vice- CJCOS- :Hytan,
:James-Charles, -:General United States Army: COS Army- :McConville,
:David-Hilberry, -:General United States Marine Corps: CMC- :Berger,
:Michael-Martin, -:Admiral United States Navy: CNO- :Gilday,
:David-Lee, -:General United States Air Force: COS AF- :Goldfein,
:John-William, -:General United States Space Force: CSO- :Raymond,
:Joseph-Lauren, -:General United States Air Force: CNG- :Langyel
:Karl-Lee, -:Admiral United States Coast Guard: CCG- :Schultz
c/o :Mark-Alexander: Milley, -:Trustee : USPO RE 322 398 295 US
9999 Joint Staff Pentagon
Washington, Columbia Territory [D.C.- 20318-9999]

- 1 :Darrell-James: Hill means :Covenant-agreements Statuses :In -Procurator means: Gila county, Arizona, Recorder, Doc.# 2017-002378, pp. 1- ; et seq.- #2017-00652, #2018-005176, #2019-009291, #2019-011722;- <https://recorder.gilacountyaz.gov/recorder/web/>
- 2 :Joseph-Robinette: Biden, -:POTUS, et al- man- actors et seq. means: See :USPO RMN RE 322 398 389 US , Covenant-agreements- Statuses - :in -Procurator.
- 3 :POTUS means: office- status is :in- :Disonor-2017-A.D. Ibid 2. SEE: USPO RMN RE 322 398 389 US ; 'Claim of :-Unalienable-Right :in-accordance With The Covenant-Agreements:... ' ; sent: January 28, 2021, 11:33 a.m.
- 4 :Trustee means: under legislative-oath, duty and obligation to assure and ensure advantage and use- benefit of the EBA-1933-A.D- legislative-dry-trust is disposed to the 'United States of America'- people- beneficiary-individual upon execution-in -exercise of the ANY-beneficiary-right to-remedy.

To: Joseph-Robinette: 7009141000078685734 - Deny :U.S.-Corp. to "state" -people statuses 1/3

Unoff
2/23

:Executor-Procurator, -:mitigation of the Trustee-derelict- damages ~

2024

Darrell James hill on Twitter: "#GenMilleyOn January 28, 2021, i-man sent man- Joseph-Robinette, -POTUS, et al-the whole team c/o Joseph-Robinette, the claim that the previous man- Donald-John, POTUS, et al.-Obama and etc., STOLE IN VIOLATI..."

File Edit View History Bookmarks Tools Help

Mr All Mail - djhillis X New Tab Onkyo receiver X Apache Juncti X WunderMap X Inbox (107) - 0 X Total Prize: Y X Darrell James i X b-1020-intro-tr X a-2020-09-26 X New Tab X +

https://twitter.com/DarBenThu1/status/1358059056060461056/analytics 150%

Getting Started EXECUTIVE ORDERS REF COMMERCE DAVID STRAIGHTERS AJ

Tweet Analytics

Darrell James hill @DarBenThu1

#GenMilleyOn January 28, 2021, i-man sent man- Joseph-Robinette, -POTUS, et al-the whole team c/o Joseph-Robinette, the claim that the previous man- Donald-John, POTUS, et al.-Obama and etc., STOLE IN VIOLATION OF ALL LAW and treaty, ...https://blackandbluesoulsmatter.files.wordpress.com/2021/01/2021-jan-26-ltr-to-potus-6-done-all-mailg.pdf ...

Quote Tweet

Impressions	times people saw this Tweet on Twitter	232
Total engagements	times people interacted with this Tweet	3

[View all engagements](#)

Tweet

Darrell James hill @DarBenThu1

#GenMilleyOn January 28, 2021, i-man sent man- Joseph-Robinette, -POTUS, et al-the whole team c/o Joseph-Robinette, the claim that the previous man- Donald-John, POTUS, et al.-Obama and etc., STOLE IN VIOLATION OF ALL LAW and treaty, ...https://blackandbluesoulsmatter.files.wordpress.com/2021/01/2021-jan-26-ltr-to-potus-6-done-all-mailg.pdf ...

Quote Tweet

7:20 AM · Feb 6, 2021

[View Tweet activity](#)

people

James hill

anThu1

Ysrael, -civilian, -Ohiban, -POTUS, et al.-Obama and etc., STOLE IN VIOLATION OF ALL LAW and treaty, ...https://blackandbluesoulsmatter.files.wordpress.com/2021/01/2021-jan-26-ltr-to-potus-6-done-all-mailg.pdf ...

opening

ago

teaffing on ABC

an, Balla

future today!

minBtoon

messages

2022-011769 MISC Page: 2474 of 2782

09/26/2022 03:35:37 PM Receipt #: 22-9381

Rec Fee: \$30.00 Darrell James Hill

Gila County, Az, Sadie Jo Bingham, Recorder



Tuesday November 9, 21:42

2265

← Tweet
Search Twitter

Tweet Analytics

Darrell James hill @DarBenThu1
 #GenMilley:cousin, 1) See: 'deny :U.S.-Corp. to 'state' -people statuses' written for :i- man, sole or lone, and as 'kinsman-redeemer' for Negro-Ysrael, Ysrael, and Holy-Church';
 2) Note- :i- man, -:Ohioan am :Amb. of :Almighty-God :in-Trustee: Concession-1213-A.D.
 3) Psalms 91 pic.twitter.com/SOGbtonYZJ

Impressions	347
times people saw this Tweet on Twitter	
Total engagements	16
times people interacted with this Tweet	

[View all engagements](#)

7:25 AM • Feb 6, 2021
View Tweet activity

Messages
↑



:Darrell-James: Hill, :Ohioan- beneficiary-Executor-Procurator, -:mitigation of the Trustee-derelict- damages: Twitter: September 24th, 2020, 7:05 p.m. - :March 9, 2021, 3:35 p.m.

To: Joseph-Robinette: 7009141000078685734 - Dany :U.S.-Corp. to 'state' -people statuses 2 / 3

Re: FORMAL-DENIAL -

:Derived-Authority, for the government-services-provider -in-fiction, et seq.- (self-indentured-: EBA-1933-A.D.-Trustee to :debentured- :i- man, et al.- Darrell-James: Hill, -kinsman- redeemer of :Negro-Ysrael, Ysrael and Holy Church- :in- accordance with the covenant-agreement's is DENIED.

:Trespassing upon the delimit is an offense with willful-damage upon :i- man -sole and kinsman-redeemer, subject to procuration⁵ :in- accordance with the covenant-agreement⁶.

Greetings :Joseph-Robinette, :Mark-Alexander, et al.:

:i- man, sole, and as kinsman redeemer, appreciate your righteous-service to the beneficiary, -:United States of America'- people.

:Non-authorization for the 'UNITED STATES-CORP'- Trustee: government-services-provider -self-indentured -legislative-Trusted of: EBA-1933-A.D.⁸, ascendancy to :i- man-status is with the right to :remedy for the offense by :procuration- agreement⁹

Authority: :i- man-Darrell-James: Hill, -:sole and kinsman-redeemer¹⁰

A. :i- man -Darrell-James: Hill, :Negro, -inherent-beneficiary by Almighty-God; -civilian, -Ohioan; debentured-beneficiary: EBA-1933-A.D., for :i- man -sole and kinsman-redeemer for :all- Negro-Ysrael, Ysrael and the Holy-Church, and, for all, except the individual- soul-journeyor by the express-behest, am;

B. :i- man -ambassador of the Almighty-God am :Trustee: Concession-1213-A.D. by the

5 :covenant-agreements means: :covenant-agreement(s), et al. means: under the :Almighty-God - :1776 A.D.- People Constitution: Declaration of Independence; 1777 A.D. States' Constitution: Articles of Confederacy, 1787-1789 A.D.: "The Constitution for the United States of America", -non-incorporated: :permissions, duty, obligations and limitations- 'in - service to and for the United States of America -people by :standard- guarantee of the republican form of government.

6 :Procuration means: Ibid 1, for the recovery of damages.

7 :covenant-agreement means: Ibid 1, by the right of the 'political-election' -right is :executed

8 :EBA-1933-A.D. means: the Emergency Banking Act of 1933, -2003 legislative 'dry-trust' is over. :i- man -sole -wish for right of separation-account, settle and closure is executed- and, :kinsman-redeemer -demand for :right of separation executed for Negro-Ysrael, Ysrael and Holy-Church.

9 :covenant-agreement(s), et al. means: :Covenant-agreements Statutes :in -Procuration means: Ibid 1, 2, 3, 5, 6, 7, . -https://recorder.gilacountyaz.gov/recorder/web/-

10 :kinsman-redeemer means: for: all except the civilly-alive at their express-behest, am[;] that "Express-assumpsit" is to undertake ones' own responsibility and liability in this matter is NOT restricted in -individual- -spirit, soul and [lesh]- choice in -civil-alive-status.

To: Joseph-Robinette: 7009141000078685734 - Dany :U.S.-Corp. to 'state' -people statuses 2 / 3

2267
:Executor-Procurator, -:mitigation of the Trustee-derelict- damages ~

130 / 206



:Darrell-James: Hill, :Ohioan- beneficiary-Executor-Procurator, -:mitigation of the Trustee-derelict- damages: Twitter: September 24th, 2020, 7:05 p.m. - :March 9, 2021, 3:35 p.m.

To: Joseph-Robinette: 7009141000078685734 - Dony :U.S.-Corp. to "state"-people statuses 3 / 3

grace of the Most High God and father of our Messiah Yushuah by covenant-agreements"
:Knowledge: For the any-type of 'government-service-organization -self-ascendancy to :-
man-status' however promulgated -also including proffer by the propaganda, legislation,
executive-order, or otherwise, notwithstanding- for the tacit-acquiescence by :- man, et al. is
now formally denied.

:Cause: For the issue of this Knowledge, the :any-proffer for ascendancy by any mean is
wholly- DENIED by this binding covenant. - :In this matter define damage, procurator for the
right of remedy is set.

:Action-Required: :- man sole, and as :kinsman-redeemer, desire and require in-office, et
al. :- man-actors', et seq.- TRUSTEES' :any-proffer for, to or unto :ascendancy to the organic-
state -status to the union of the 'United States of America' -people by any means is ceased,
desisted now at this autographing, and shall forever be :willful-damage :-criminal-trespassing.

1. :Trespassing in this matter is with the willful-offense -admitted -damage upon :- man,
:-sole and :kinsman-redeemer, subject to :procurator by the PE of the kinsman-
redeemer¹¹.

Any :you- man- actors- :in-office trespassing with the procurator under the PE of
:kinsman-redeemer for each individual soul-journer under the harm is now accountable to the
interveners: principals, agents and proxies, severally also including :man- actors in- and :office
of any institutions: ecclesiastical and non-ecclesiastical. 'United-States-Corp'- gsp. :-Trustee:
EBA-1933-A.D., et seq., understanding the :covenant-agreements- all¹².

Notice to the man-actor- PRINCIPAL is sufficient notice to the man-actor-AGENT; Notice
to the man-actor-AGENT must be reported to the man-actor-PRINCIPAL.

Without-prejudice

Darrell James Hill, Executor
:Darrell-James: Hill, Executor, -:Kinsman-Redeemer

Affirmed and autographed before me this 25 day, February 2021 A.D.

Cheryl Smith
Notary-Public



11 :covenant-agreement(s), et al. means: by :God to : Adam and Eve, et seq. -to :Noah, to :Shem,
to :Jacob/Ysrael, to :- man, son of :Clarence and Ora, children of :Jacob/Ysrael. Ibid 1
12 :PE of the kinsman-redeemer means: Ibid 1;
13 :covenant-agreements means: Ibid 1, 2, 3, 5, 6, 7, 8, 9, 11, 12.

To: Joseph-Robinette: 7009141000078685734 - Dony :U.S.-Corp. to "state"-people statuses 3 / 3

7009 1410 0000 7868 5734

:Executor-Procurator, -:mitigation of the Trustee-derelict- damages ~

129 / 206

2266
Unofficial



:Darrell-James: Hill, :Ohioan- beneficiary-Executor-Procurotor, -:mitigation of the Trustee-derelict- damages: Twitter: September 24th, 2020, 7:05 p.m. - :March 9, 2021, 3:35 p.m.

UNITED STATES POSTAL SERVICE				U.S. Postal Service CERTIFIED MAIL - RECEIPT	
APACHE JUNCTION 151 W SUPERSTITION BLVD APACHE JUNCTION, AZ 85120-9998 (800)275-8777				OFFICE APACHE JUNCTION, AZ FEB 05 2021	
02/05/2021			12:50 PM	7000 1A10 0000 7866 5786	
Product	Qty	Unit Price	Price	Registered No. 0232239831 3US	
First-Class Mail® Letter	1		\$0.55	Date Stamp APACHE JUNCTION, AZ FEB 05 2021	
Washington, DC 20000 Weight: 0 lb 0.60 oz Estimated Delivery Date Tue 02/09/2021				Postage \$ 0.55 Extra Services & Fees (optional) Certified Mail® \$13.50 Return Receipt for Merchandise (optional) \$2.85 Registered Mail® \$0.00 Signature Confirmation® \$0.00 Restricted Delivery® \$0.00 Total Postage & Fees \$16.90	
Certified Mail® Tracking #: 9509 9922 4718 8344 8200 93				Customer Mail Service Full Value \$21.00	
Total \$3.90				Received by 02/05/2021	
First-Class Mail® Letter				OFFICIAL USE	
Washington, DC 20018 Weight: 0 lb 1.00 oz Estimated Delivery Date Tue 02/09/2021				APACHE JUNCTION, AZ Darrell-James: Hill PO Box 35016 Apache Junction, Arizona 85117	
Registered Mail® Amount: \$21.00 Tracking #: 0232239831 3US				Mark Alexander Wiley 999 Washington St, Suite 100 Washington, Colorado 80750	
Return Receipt Tracking #: 9509 9922 4718 8344 8200 93				PS Form 3806, Registered Mail Receipt April 2015, PSN 7500-02-000-9001 For domestic delivery information, visit our website at www.usps.com	
Total \$16.90				Copy 1 - Customer	
Grand Total: \$22.00					
Cash \$25.00					
Change \$3.00					

7:25 AM · Feb 6, 2021 · Twitter Web App

Darrell James Hill
 @DarBenThu1

February 9, 2021

:Executor-Procurotor, -:mitigation of the Trustee-derelict- damages ~



:Darrell-James: Hill, :Ohioan- beneficiary-Executor-Procurator, -:mitigation of the Trustee-derelict- damages: Twitter: September 24th, 2020, 7:05 p.m. - :March 9, 2021, 3:35 p.m.

7:30 a.m.

Twitter. is the U.S.-Trustee via the BLM or whoever inadvertently seizing farmland from the beneficiaries? Or, not? I do not understand? Are you saying that Twitter for unknown reasons has determined that the topic cannot be discussed by man-kinds???

7:30 AM · Feb 9, 2021 · Twitter Web App

February 9,
2021
10:08 a.m.



Darrell James hill
[@DarBenThu1](#)
did you know this?

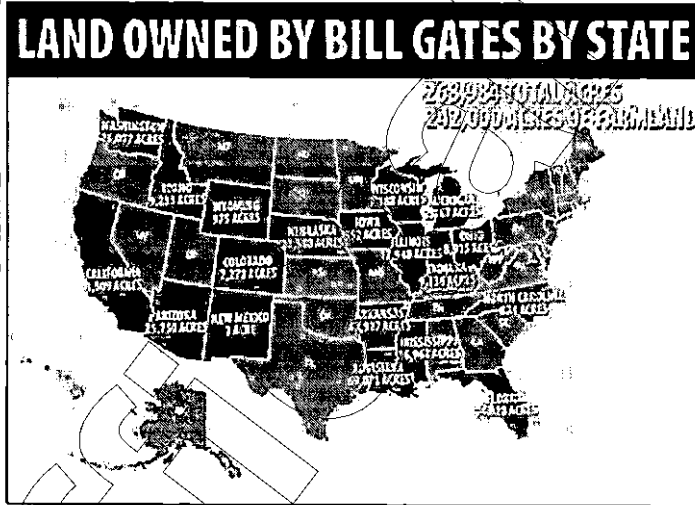

humansarefree.com
[Why is Bill Gates Buying Up Farmland Across America?](#)
[Why is Bill Gates Buying Up Farmland Across America?](#)
10:08 AM · Feb 9, 2021 · Twitter Web App

February 10,
2021
12:13 a.m.

Darrell James hill
[@DarBenThu1](#)
You gotta hear this: You are a winner. Arizona Senate V Board of Supervisors update and behind the scenes intel plus action steps

:Executor-Procurator, -:mitigation of the Trustee-derelict- damages ~

Tweet Analytics

Darrell James hill @DarBenThu1
did you know this?
<https://humansarefree.com/2021/01/why-is-bill-gates-buying-up-farmland-across-america.html> ...

Impressions	218
times people saw this Tweet on Twitter	
Total engagements	1
times people interacted with this Tweet	

[View all engagements](#)

Promote your Tweet
Your Tweet has 218 total impressions so far.

Messages

2277

Tweet

Darrell James Hill @DarBenThu1

You gotta hear this: You are a winner.

Arizona Senate V Board of Supervisors update and behind the scenes intel plus action steps

<https://www.youtube.com/watch?v=Q2f3jM9Lxo&t=600s> ...

12:03 AM · Feb 10, 2022

View Tweets active

Tweet Analytics

Darrell James Hill @DarBenThu1
You gotta hear this: You are a winner.

Arizona Senate V Board of Supervisors update and behind the scenes intel plus action steps
<https://www.youtube.com/watch?v=Q2f3jM9Lxo&t=600s> ...

Impressions times people saw this Tweet on Twitter	237
Media views all views (autoplay and click) of your media are counted across videos, vines, gifs, and images	4
Total engagements times people interacted with this Tweet	7

View all engagements

People

James Hill
anThu1
Ysrael, -civilian, -Ohioan,
iciary: DOI-1776-A.D.,
33-A.D.; Amb. of Ytshuah to
n-redeemer/ Ysrael & Trustee
sion-1213-A.D.

opening

ago
te airing on ABC
an, Be'n

ture today!
n'n Bloom

messages



:Darrell-James: Hill, :Ohioan- beneficiary-Executor-Procurator, -:mitigation of the Trustee-derelict- damages: Twitter: September 24th, 2020, 7:05 p.m. - :March 9, 2021, 3:35 p.m.



youtube.com
Arizona Senate V Board of Supervisors update and behind the scenes...
The behind the scenes intel on the biggest fight in the nation
12:13 AM · Feb 10, 2021 · Twitter Web App

February 5,
2021
2:57 p.m.

Darrell James hill
@DarBenThu1
:cousin, 1) See: 'deny :U.S.-Corp. to ':state' -people statuses' written for :i- man, sole or lone, and as 'kinsman-redeemer' for Negro-Ysrael, Ysrael, and Holy-Church'; 2) Note- :i- man, -:Ohioan am :Amb. of :Almighty-God :in-Trustee: Concession-1213-A.D.; 3) Your servant; Ps 91



:Darrell-James: Hill, :Ohioan- beneficiary-Executor-Procurator, -:mitigation of the Trustee-derelict- damages: Twitter: September 24th, 2020, 7:05 p.m. - :March 9, 2021, 3:35 p.m.

To: Joseph-Robinette: 7009141000078685734 - Deny :U.S.-Corp. to "state" -people statuses 1 / 3

Darrell-James: Hill¹-civilian, -:Executor, -:Kinsman-Redeemer
PO Box 3806
Apache Junction, Arizona 85117

:man :present; -:Ohioan

Arizona state
Pinal county

:i- man -:sole and kinsman-redeemer- :declaration:
:2021 February 4th: Authority For :U.S.-Corp<Trustee-Government-Services-Provider,
'gsp', -:Trustee: EBA-1933-A.D., To Ascend By Any-Means To The Entity-Status
Equivalency of Man-Kind: Organic-State, Subrogation or Fictional, Or A :Like
-Presumption Status,
Is Here-To-Fore And Now-To After Denied.

To: Joseph-Robinette: Biden², -:POTUS³, et al., - man- actors et seq.
c/o :Joseph-Robinette: Biden, -:Trustee⁴, USPS CMN 7009 1410 0000 7868 5734
600 Pennsylvania Ave NW
Washington, District of Columbia 20500

Mark-Alexander -:General United States Army-:Chairman: CJCOS- :Milley,
:John-Earl, -:General United States Air Force: Vice: CJCOS- :Hytan,
:James-Charles, -:General United States Army: COS Army- :McConville,
:David-Hilberry, -:General United States Marine Corps: CMC- :Berger,
:Michael-Martin, -:Admiral United States Navy: CNO- :Gilday.,
:David-Lee, -:General United States Air Force: COS AF- :Goldfin,
:John-William, -:General United States Space Force: CSO- :Raymond,
:Joseph-Lauren, -:General United States Air Force: CNG- :Langyel
:Karl-Lee, -:Admiral United States Coast Guard: CCG- :Schultz
c/o :Mark-Alexander: Milley, -:Trustee: USPO RE 322 398 295 US
9999 Joint Staff Pentagon
Washington, Columbia Territory [D.C.- 20318-9999]

- 1 :Darrell-James: Hill means: :Covenant-agreements-Statuses :in -Procurator means: Gila county, Arizona, Recorder, Dec.# 2017-002378, pp. 1- ; et seq.~ #2017-00652, #2018-005176, #2019-009291, #2019-011722-~ <https://recorder.gilacountyaz.gov/recordetweb/>
- 2 :Joseph-Robinette: Biden, -:POTUS, et al., - man- actors et seq. means: See: USPO RMN RE 322 398 389 US : Covenant-agreements- Statuses - :in -Procurator.
- 3 :POTUS means: office- status is :in- :Dishonor-2017-A.D. Ibid 2. SEE: USPO RMN RE 322 398 389 US : Claim of :Unalienable-Right :in-accordance With The Covenant-Agreements.... : sent: January 28, 2021, 11:33 a.m.
- 4 :Trustee means: under legislative-oath, duty and obligation to assure and ensure advantage and usa- benefit of the EBA-1933-A.D- legislative-dry-trust is disposed to the 'United States of America'-people- beneficiary-individual upon execution-in -exercise of the ANY-:beneficiary-right to remedy.

To: Joseph-Robinette: 7009141000078685734 - Deny :U.S.-Corp. to "state" -people statuses 1 / 3

2273

:Executor-Procurator, -:mitigation of the Trustee-derelict- damages ~



:Darrell-James: Hill, :Ohioan- beneficiary-Executor-Procurator, -:mitigation of the Trustee-derelict- damages: Twitter: September 24th, 2020, 7:05 p.m. - :March 9, 2021, 3:35 p.m.

To: Joseph-Robinotto: 70091410000078685734 - Deny :U.S.-Corp. to "state" -people statuses

3 / 3

grace of the Most High God and father of our Messiah Yushuah by covenant-agreements¹¹
:Knowledge: For the any-type of 'government-service-organization -self-ascendancy to :-man-status' however promulgated -also including proffer by the propaganda, legislation, executive-order, or otherwise, notwithstanding- for the tacit-acquiescence by :- man, et al, is now formally denied.

:Cause: For the issue of this Knowledge, the :any-proffer for ascendancy by any mean is wholly- DENIED by this binding covenant. - :in this matter defined damage, procurator for the right of remedy is set.

:Action-Required: :- man sole, and as :kinsman-redeemer, desire and require :in-office, et al. :-man-actors', et seq. - TRUSTEES' :any -proffer for, to or unto :ascendancy to the organic-state -status to the union of the 'United States of America' -people by any means is ceased, desisted now at this autographing, and shall forever be :willful-damage - :criminal-trespassing.

1. :Trespassing in this matter is with the willful-offense - :admitted -damage upon :- man, :sole and :kinsman-redeemer, subject to :procurator by the PE of the kinsman-redeemer¹².

Any- :you- man- actors- :in-office trespassing with the procurator under the PE of :kinsman-redeemer for each individual soul-journer under the harm is now accountable to the intervenors: principals, agents and proxies, severally also including :man- actors :in- and :office of any institutions; ecclesiastical and non-ecclesiastical. 'United-States-Corp' - gwp, -:Trustee: EBA-1933-A.D., et seq., understanding the :covenant-agreements- all¹³.

Notice to the man-actor- PRINCIPAL is sufficient notice to the man-actor-AGENT; Notice to the man-actor-AGENT must be reported to the man-actor-PRINCIPAL.

Without prejudice

Darrell James Hill, Executor
:Darrell-James: Hill, Executor, -:Kinsman-Redeemer

Affirmed and autographed before me this 25 day, February 2021 A.D.

Charles Smith
Notary-Public

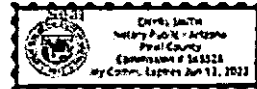

11 :covenant-agreement(s), et al. means: by :God to : Adam and Eve, et seq. - to :Noah, to :Shem,

to :Jacob/Israel, to :- man, son of :Clarence and Ora, children of :Jacob/Israel, Ibid 1

12 :PE of the kinsman-redeemer means: Ibid 1,

13 :covenant-agreements means: Ibid 1, 2, 3, 5, 6, 7, 8, 9, 11, 12.

To: Joseph-Robinotto: 70091410000078685734 - Deny :U.S.-Corp. to "state" -people statuses

3 / 3

7009 1410 0000 7868 5734



:Darrell-James: Hill, :Ohioan- beneficiary-Executor-Procurator, -:mitigation of the Trustee-derelict- damages: Twitter: September 24th, 2020, 7:05 p.m. - :March 9, 2021, 3:35 p.m.

To: Joseph-Robinette: 70091410000078683734 - Deny:U.S.-Corp. to "state"-people statuses 2 / 3

Re: FORMAL-DENIAL-

:Derived-Authority, for the government-services-provider -(in-fiction, of seq- :self-indentured- EBA-1933-A.D.-Trustee to :debutured-):-man, et al.- Darrell-James: Hill, -kinsman- redeemer of :Negro-Ysrael, Ysrael and Holy Church- :in- accordance with the covenant-agreement's is DENIED.

:Trespassing upon the delimit is an offense with willful-damage upon :-man - :sole and kinsman-redeemer, subject to procurat⁹ :in- accordance with the covenant-agreement⁷.

Greetings :Joseph-Robinette, :Mark-Alexander, et al.:

:-man, solo, and as kinsman redeemer, appreciate your righteous-service to the beneficiary, -:United States of America'- people.

:Non-authorization for the 'UNITED STATES-CORP'- Trustee: government-services-provider -:self-indentured -legislative-Trustee of: EBA-1933-A.D.,⁸ ascendancy to :-man-status is with the right to :remedy for the offense by :procurat⁹- agreement⁷

Authority: :-man-Darrell-James: Hill, - :sole and kinsman-redeemer¹⁰

A. :-man -Darrell-James: Hill, - :Negro, - :inherent-beneficiary by Almighty-God: - :civilian, - :Ohioan; debutured-beneficiary: EBA-1933-A.D., for :-man - :sole and kinsman-redeemer for :all- Negro-Ysrael, Ysrael and the Holy Church, and, for all, except the individual- soul-journeyor by the express-behest, am;

B. :-man -ambassador of the Almighty-God am :Trustee: Concession-1213-A.D. by the

5 :covenant-agreements means: :covenant-agreement(s), et al. means: under the :Almighty-God - :1776 A.D.- People Constitution: Declaration of Independence: 1777 A.D. States' Constitution: Articles of Confederacy, 1787-1789 A.D.: 'The Constitution for the United States of America'. -non-incorporated: :permissions, duty, obligations and limitations- 'in - service to and for the United States of America -people by :standard- guarantee of the republican form of government'

6 :Procurat⁹ means: I bid 1, for the recovery of damages.

7 :covenant-agreement means: I bid 1, by the right of the 'political-election' -right is :executed

8 :EBA-1933-A.D. means: the Emergency Banking Act of 1933, -2003 legislative 'dry-trust' is over, :-man - :sole -wish for right of separation-account, settle and closure is executed- and, :kinsman-redeemer- demand for right of separation executed for Negro-Ysrael, Ysrael and Holy-Church,

9 :covenant-agreement(s), et al. means: :Covenant-agreements Statutes in -Procurat⁹ means: I bid 1, 2, 3, 5, 6, 7, . -https://recorder.gilacountyaz.gov/recorder/web/

10 :kinsman-redeemer means: for: ..., all except the civilly-alive at their express-behest, am[;] that "Express-assumpsit" is to undertake ones' own responsibility and liability in this matter is NOT restricted in -individual-~spir⁸, soul and flesh- choice in -civil-olive- status.

To: Joseph-Robinette: 70091410000078683734 - Deny:U.S.-Corp. to "state"-people statuses 2 / 3

22.15
Unoff



:Darrell-James: Hill, :Ohioan- beneficiary-Executor-Procurator, -:mitigation of the Trustee-derelict- damages: Twitter: September 24th, 2020, 7:05 p.m. - :March 9, 2021, 3:35 p.m.

APACHE JUNCTION
 251 W SUPERSTITION BLVD
 APACHE JUNCTION, AZ 85120-9950
 (800)275-8777

02/05/2021 12:50 PM

Product	Qty	Unit Price	Price
First-Class Mail® Letter	1		\$0.55
Washington, DC 20500 Weight: 0 lb 0.68 oz Estimated Delivery Date Tue 02/09/2021			
Certified Mail®			\$3.50
Tracking #:	9509141000076825734		
Return Receipt®			\$1.75
Total			\$5.80
First-Class Mail® Letter	1		\$0.90
Washington, DC 20318 Weight: 0 lb 1.00 oz Estimated Delivery Date Tue 02/09/2021			
Registered Mail®			\$13.50
Amount: \$21.00			
Tracking #:	9522298312US		
Return Receipt®			\$2.85
Tracking #:	9520 9407 4718 8344 9810 93		
Total			\$16.90
Grand Total:			\$22.80
Cash			\$25.40
Change			\$2.60

U.S. Postal Service®
CERTIFIED MAIL - RECEIPT
 (Domestic Mail Only; No Insurance Coverage Provided)

For delivery information visit our website at www.usps.com

7000 LVLD 0000 786A 573H

Postage \$0.55

Certified Fee \$3.50

Return Receipt Fee (Insurance Required) \$1.75

Registered Mail Fee (Insurance Required) \$13.50

Total Postage & Fees \$18.30

Amount Paid \$21.00

Customer Mail Declared Value \$21.00

Registered No. 9522298312US

Date Stamp
 APACHE JUNCTION, AZ
 FEB 05 2021

OFFICIAL USE

TO: Darrell James Hill
 PO Box 3806
 Apache Junction, Arizona 85127

FROM: Mark Alexander Willey
 4999 Washington St, Suite 100
 Washington, Colorado 80151
 De Ce 00388-9999

PS Form 3806, Registered Mail Receipt Only 1 - Customer
 April 2018, PSN 7320-02-000-4001
 For domestic delivery information, visit our website at www.usps.com

2:57 PM · Feb 5, 2021 · Twitter Web App

2276



:Darrell-James: Hill, :Ohioan- beneficiary-Executor-Procurator, -:mitigation of the Trustee-derelict- damages: Twitter: September 24th, 2020, 7:05 p.m. - :March 9, 2021, 3:35 p.m.

February 14,
2021
3:37 p.m.



Darrell James hill

@DarBenThu1

A :man surreptiously offered to be FIDUCIARY for your debentures. See: 'fiduciary...' @ <http://annavonreitz.com/highsteward.pdf>. However, <http://annavonreitz.com/documents/juralassemblyhandbook.pdf>

-- 'Section 2 — Law and Religion' is :anti-Christ. The :DOI-1776-A.D. is :covenant w/ :Almighty-God. So, kinsman says, 'TY, & NO'.

3:37 PM · Feb 14, 2021 · Twitter Web App

February 15,
2021
5:27 p.m.

Darrell James hill

@DarBenThu1

For the 'United States of America' ~people~ growing-up from the deception. -- ROMAN CANON LAW; 3.3 ... Article 100 -- Cestui Que Vie Trusts. Having eyes can you see; having ears can you hear.

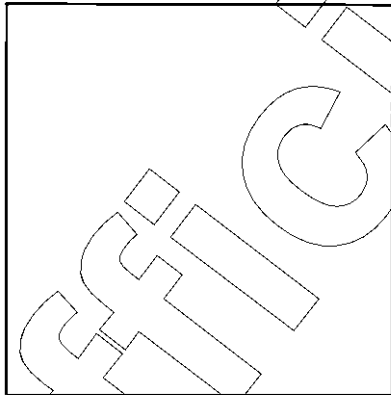

blackandbluesoulsmatter.wordpress.com
GROWING-UP FROM THE DECEPTION
roman-canon-law-3.3Download

5:27 PM · Feb 15, 2021 · Twitter Web App

February 15,
2021
8:07 p.m.

Darrell James hill

@DarBenThu1

This means that "in pais, in estoppel" (legally) if you don't assert your right for your trust (your adult responsibility) then you are a child, incompetent, unknowing, etc.-ward OR YOU! gave it away. But, now you know. Set yourself free.

2277

:Executor-Procurator, -:mitigation of the Trustee-derelict- damages ~

2278

← Tweet

The :DOI-1776-A.D.1 is a covenant w/ Almighty-God. So, kinsman says, 'TY, & NO'.

3:37 PM · Feb 14, 2022

View Tweet activity

1 Quote Tweet 11 Retweets

Tweet your thoughts

Tweet Analytics

Darrell James Hill @DarBenThu1
 A man surreptitiously offered to be FIDUCIARY for your debentures. See: 'fiduciary...' @ http://annavonreitz.com/highsteward.pdf . However, http://annavonreitz.com/documents/juralassemblyhandbook.pdf ... -- 'Section 2 - Law and Religion' is anti-Christ.

The :DOI-1776-A.D.1 is a covenant w/ Almighty-God. So, kinsman says, 'TY, & NO'.

Impressions times people saw this Tweet on Twitter	197
Total engagements times people interacted with this Tweet	7

[View all engagements](#)

opening

ago

American Crime FX

ture today!

min Bloom

day

er who struck

ck and walked

ged

Earlier today

iana's revenge

relevant, 27 years

messages

2279

Darrell James hill on Twitter: "For the 'United States of America' -people- growing-up from the deception. -- ROMAN CANON LAW; 3.3 ... Article 100 -- Cestui Que Vie Trusts. Having eyes can you see; having ears can you hear. https://t.co/1PqK6j0Wf1 ..."

File Edit View History Bookmarks Tools Help

Mr All Mail - djhill; X New Tab Onkyo receive X Apache Jundit X WunderMap X M Inbox (107) - X Total Praise X Darrell James I X b-1020-intro-t X a-2020-09-20 X New Tab X

https://twitter.com/DarBenThu1/status/1361472136251072516/analytics 150%

Getting Started EXECUTIVE ORDERS REF COMMERCE DAVID STRAIGHTERS AJ

Tweet Analytics

Darrell James hill @DarBenThu1
 For the 'United States of America' -people- growing-up from the deception. -- ROMAN CANON LAW; 3.3 ... Article 100 -- Cestui Que Vie Trusts. Having eyes can you see; having ears can you hear. <https://blackandbluesoulsmatter.wordpress.com/2021/02/16/growing-up-from-the-deception/> ...

Impressions times people saw this Tweet on Twitter	299
Total engagements times people interacted with this Tweet	8

[View all engagements](#)

Promote your Tweet

6:27 PM · Feb 15, 2021

1 Quote Tweet 1 Retweet

messages

Tuesday November 9, 21:40



2782

Tweet Analytics

Darrell James hill @DarBenThu1
 This means that "in pais, in estoppel" (legally) if you don't assert your right for your trust (your adult responsibility) then you are a child, incompetent, unknowing, etc.-ward OR YOU! gave it away. But, now you know. Set yourself free. <https://twitter.com/DarBenThu1/status/1361472136251072516> ...

Impressions times people saw this Tweet on Twitter	150
Total engagements times people interacted with this Tweet	3

[View all engagements](#)

Promote your Tweet

← Tweet

3:07 PM · Feb 13, 2022

View Tweet activity

Twitter navigation icons: Home, Search, Notifications, Messages, Profile, Activity, Tweet, Retweet, Reply, Like, Share, More

Right sidebar content:

- ...ture today!
- ...m Bloom
- 4 hours ago
- ...y And Aaron
- New Statements
- Controversial
- ...mments
- ...mes · 3 hours ago
- ...leaving NBC
- ...ears
- ...basketball
- ...partans

Messages

Tuesday November 9, 21:40



:Darrell-James: Hill, :Ohioan- beneficiary-Executor-Procurator, -:mitigation of the Trustee-derelict- damages: Twitter: September 24th, 2020, 7:05 p.m. - :March 9, 2021, 3:35 p.m.

Quote Tweet



Darrell James hill
@DarBenThu1

For the 'United States of America' ~people~ growing-up from the deception. -- ROMAN CANON LAW; 3.3 ... Article 100 -- Cestui Que Vie Trusts. Having eyes can you see; having ears can you hear.
<https://blackandbluesoulsmatter.wordpress.com/2021/02/16/growing-up-from-the-deception/>

8:07 PM · Feb 15, 2021 · Twitter Web App

March 1, 2021
1:52 a.m.



Darrell James hill
@DarBenThu1

Is not John Deere a corporation under the 'U.S.-Corp'? Y. Is not the U.S.-Corp. the Trustee: EBA-1933-A.D.? Y. Are not these farmers beneficiaries of the EBA-1933-A.D.? Y. Can the Trustee authorize any harm upon the beneficiary? N. Is JD authorized/ US-Corp. to harm the farmers?

<https://twitter.com/LjNirk/status/1235254107969073153>

This Tweet was deleted by the Tweet author. [Learn more](#)
1:52 AM · Mar 1, 2021 · Twitter Web App

March 1, 2021
2:31 a.m.

Darrell James hill
@DarBenThu1

:a sad truth. Ysrael--Jacob-Ham is 'Judah': Southern-Kingdom; 402 years into the Americas!. Ysrael-Jacob-Japeth is Ephraim: Northern-Kingdom; 2500 years in Europe. THEY DO NOT KNOW WHO THEY ARE. But, don't believe me. Who did this? See: KJV: Obadiah, Ps. 83. White does not exist.

Quote Tweet



John W. Boyd, Jr.

UN
2281



:Darrell-James: Hill, :Ohioan- beneficiary-Executor-Procurator, -:mitigation of the Trustee-derelict- damages: Twitter: September 24th, 2020, 7:05 p.m. - :March 9, 2021, 3:35 p.m.

@JWBoydNBFA
#BoycottJohnDeere #JohnDeereLiedForYears #BlackFarmerJustice
#EndRacialDiscrimination #SupportNBFA @jwboydNBFA <http://cont.ac/4BiaN>
2:31 AM · Mar 1, 2021 · Twitter Web App

Darrell James hill Retweeted



YABLOU
[@yaboumusic](https://twitter.com/yaboumusic)

Happy #HoloMonday from Germany!    #Holochain #holo \$HOT

February 28,
2021
5:18 p.m.

2282

228

Darrell James hill on Twitter: "Is not John Deere a corporation under the 'U.S.-Corp'? Y. Is not the U.S.-Corp, the Trustee: EBA-1933-A.D.? Y. Are not these farmers beneficiaries of the EBA-1933-A.D.? Y. Can the Trustee authorize any harm upon the be...

File Edit View History Bookmarks Tools Help

M All Mail - dhill X New Tab X Onkyo receives X Apache Junction X WunderMap X M Inbox (107) - d X Total Praise X Darrell James X b-1020-Intro X a-2020-09-20 X New Tab X

https://twitter.com/DarBenThu1/status/1366310260504363008/analytics 150% i'll never be more loved

Getting Started EXECUTIVE ORDERS REF COMMERCE DAVID STRAIGHTERS AJ

Tweet Analytics

Darrell James hill @DarBenThu1
 Is not John Deere a corporation under the 'U.S.-Corp'? Y.
 Is not the U.S.-Corp, the Trustee: EBA-1933-A.D.? Y.
 Are not these farmers beneficiaries of the EBA-1933-A.D.? Y.
 Can the Trustee authorize any harm upon the beneficiary? N.
 Is JD authorized/ US-Corp. to harm the farmers? <https://twitter.com/LjNirk/status/1235254107969073153> ...

Impressions times people saw this Tweet on Twitter	109
Total engagements times people interacted with this Tweet	1

[View all engagements](#)

← Tweet

by @DarBenThu1

This Tweet was created on 1:52 AM - Mar 1, 2022

View Tweet activity

Messages

te airing on ABC

ture today!

Earl or today

iana's revenge relevant, 27 years

1 hours ago

ey And Aaron New Statements

Controversial ments

eball - Trending

2284

← Tweet
White does not exist. <https://twitter.com/JWBoydNBFA/status/1364932455011127300> ...

Tweet Analytics

Darrell James Hill @DarBenThu1
 a sad truth. Ysrael--Jacob-Ham is 'Judah': Southern-Kingdom; 402 years into the Americas!. Ysrael-Jacob-Japeth is Ephraim: Northern-Kingdom; 2500 years in Europe. THEY DO NOT KNOW WHO THEY ARE. But, don't believe me. Who did this? See: KJV: Obadiah, Ps. 83. White does not exist. <https://twitter.com/JWBoydNBFA/status/1364932455011127300> ...

Impressions	112
times people saw this Tweet on Twitter	
Total engagements	1
times people interacted with this Tweet	

View all engagements

John W. Boyd, Jr. [@JWBoydNBFA](#)
Follow

a 4th generation black businessman and civil rights leader. He is a founder & president of the non-profit National Black Business Association.

opening

atba - LIVE

a Devils

uture today!

mn Bloom

day

er who struck

ck and walked

Messages



:Darrell-James: Hill, :Ohioan- beneficiary-Executor-Procurator, -:mitigation of the Trustee-derelict- damages: Twitter: September 24th, 2020, 7:05 p.m. - :March 9, 2021, 3:35 p.m.

101 Blockchains | HOLOCHAIN SIMPLY EXPLAINED

WHAT IS HOLOCHAIN? Holochain is a peer-to-peer distributed ledger technology that utilizes a more energy-efficient ledger system. It uses distributed hash ledger and source hash chains to achieve offline capabilities

How can Holochain be used?
Holochain can be used to create different kinds of apps

- Collaborative apps
- Platform-related apps
- Social media apps
- Relationship management apps
- Supply chain oriented apps
- Resource management apps
- Reputation systems

Holochain vs. Blockchain
Holochain offers features including

- Better scalability
- Better customizability
- Offline capability
- Uniquely configurable
- Uniquely expandable
- Evolvable
- Better security

WHY IT IS KNOWN AS HOLOCHAIN
The name Holochain came from the fact that it is composed of different technologies and makes up for a "whole" experience. It offers a structurally holographic platform and also empowers holistic patterns.

Holochain Features

- Energy efficient
- Uniquely configurable
- Uniquely connectable
- Evolvable
- Secure
- Scalable

Holochain Use Cases

- Social networks
- Supply chains
- P2P networks
- Collaborative applications
- Rating platforms

Holochain Architecture
It consists of three main sub-systems

- Shared storage (DHT)
- Application (nucleus)
- Source hash chain

CREATED BY 101BLOCKCHAINS.COM

March 5, 2021
12:11 p.m.



Darrell James Hill

@DarBenThu1

Mar052021AD. :i- man-jurisdiction of :sovereign-authority with general-procuration (/kinsman) as the PFTUSA overstanding: POTUS-trustee, & absolute-procuration over :stolen-property (/sole) :in-accordance w/ Covenant-agreements. :PFTUSA abandoned-01/20 and vacated 03/03/2021 A.D.

UN
2205

:Executor-Procurator, -:mitigation of the Trustee-derelict- damages ~

09/26/2022 03:35:37 PM Receipt #: 22-9381
Rec Fee: \$30.00 Darrell James Hill
Gila County, Az, Sadie Jo Bingham, Recorder



:Darrell-James: Hill, :Ohioan- beneficiary-Executor-Procurator, -:mitigation of the Trustee-derelict- damages: Twitter: September 24th, 2020, 7:05 p.m. - :March 9, 2021, 3:35 p.m.

Darrell-James: Hill, Sovereign-authority with-Procurator,
PO Box 3836, Apache Junction, Arizona 85117

man, -present

Arizona state
Pinal county

Jurat

Trustees:
:Mark-Alexander :General United States Army-:Chairman: CJCOS- :Milley,
:John-Earl :General United States Air Force: Vice- CJCOS- :Hylton,
:James-Charles :General United States Army, COO Army-
:David-Hiborn :General United States Marine Corps: C4IC- :Bergor,
:Fabrizio-Martin :Admiral United States Navy: CNO- :Gaddy,
:David-Lee :General United States Air Force: COG AF- :Goldfin,
:John-William :General United States Space Force: CSO- :Raymond,
:Joseph-Lauren :General United States Air Force: CNG- :Langyel
:Karl-Lee :Admiral United States Coast Guard: COG- :Schultz
c/o :John-Earl-Hylton, USPO 7000 1410 0000 7000 5741
Office: CJCOS
5500 Joint Staff Pentagon
Washington, District of Columbia 20315-9999

:Sovereign -:United States of America- people-Authority AND :Sovereign-Authority
Acceptance :In-Procurator by :Covenant-Agreements; for: a) :Receipt of the
Authority for the citizen-office: President for the United States of America -1787- A.D.,
non-incorporated, -Authority on the Abandonment and Vacation of the office of the
President by the man- Donald-John- Trump, -:Trustee, -:in- Dishonor; and b)
:Sovereign-Authority Acceptance :In-Procurator by :Covenant-Agreements: Lots
One, Two, Three, Four, Five, Six, and Seven (-failure to restore republic-constitution
for cause-)

Greetings, :Mark-Alexander, John-Earl, all;

to man hope you are well.

man- jurisdiction: Sovereign-authority with-procurator by :Covenant-Agreements
to man-beneficiary, -Negro-, civilian, -principal, :Ohioan over-standing the Declaration of
Independence, 1776-A.D., et seq. -with-debarment of the "United States"- Corp- :EBA-1833-
2003 A.D. -Dry-legislative-Trust; am :Kinman-redemptor for Negro-Ya'ael, Ya'ael and the Holy-Church
of :Yeshua, 'Jesus', the Messiah; and, thereafter: Ambassador of the Most-High-God in -Trustee:
Concession- 1213-A.D.:

- 1) Sovereign-authority under God Almighty, where-in nothing stands between the God Almighty
and :man-Ocean, et al;
- 2) DC-1776-A.D.: Ohioan, is worthed- one of the people of the United States of America;
- 3) ADC-1777-A.D.: Articles of Confederation binding :Ohio -state;
- 4) The Constitution for the United States of America, 1787 -1788, et al- Bill of Rights, et seq;
- and, 5) Express political-beliefction, "PE", -covenant-agreement with right to remedy by and with
:absolute-procurator.

Trustee: Covenant-Agreement with :Beneficial-Remedy with and by :Absolute-Procurator
5) Covenant-Contracts: PE, Lots 1-8, with Lot 8 being the secured -right of -demand for the
amount, sums and claims of the EBA-1833-A.D. -Dry-legislative-Trust -covenant-agreement, and,
with the Trustee/office :POTUS - :Obama, Trump and Biden, and POTUSA- :Trump, -agreements in
the express -absolute -procurator by :man- Darrell-James: Hill, -beneficiary, for to obtain the right
of the remedy in the deprivation of property- matters: Lots 1-8'.

1 Covenant-Agreement -procurator is merely for to assure and ensure the (a) :payment of the
To: Military: Sovereign-authority with procurator by covenant: USPO GVN 7000 1410 0000 7000 5741
1 / 2

2286
UNFO

:Executor-Procurator, -:mitigation of the Trustee-derelict- damages ~

2287

Darrell James hill on Twitter: "Mar052021AD. :i- man-jurisdiction of :sovereign-authority with general-procuration (/kinsman) as the PFTUSA overstanding: POTUS-trustee, & amp; absolute-procuration over :stolen-property (/sole) :in-accordance w/ Co

File Edit View History Bookmarks Tools Help

All Mail - djhill X New Tab Onkyo receive X Apache Junct X WunderMap X M. Inbox (107) - d X Total Prase X Darrell James X b-1020-intro X a-2020-09-20 X New Tab

https://twitter.com/DarBenThu1/status/1367915700866584576/analytics 150% I'll never be more loved

Getting Started EXECUTIVE ORDERS REF COMMERCE DAVID STRAIGHTERS AJ

Tweet Analytics

Darrell James hill @DarBenThu1
 Mar052021AD. :i- man-jurisdiction of :sovereign-authority with general-procuration (/kinsman) as the PFTUSA overstanding: POTUS-trustee, & absolute-procuration over :stolen-property (/sole) :in-accordance w/ Covenant-agreements. :PFTUSA abandoned-01/20 and vacated 03/03/2021 A.D. pic.twitter.com/gKSZg7tCyR

Impressions times people saw this Tweet on Twitter	2,505
Total engagements times people interacted with this Tweet	43

[View all engagements](#)

12:11 PM · Mar 5, 2021

1 Quote Tweet

Messages

Tuesday November 9, 21:38

2022-011769 MISC Page: 2497 of 2782
 09/26/2022 03:35:37 PM Receipt #: 22-9381
 Rec Fee: \$30.00 Darrell James Hill
 Gila County, Az, Sadie Jo Bingham, Recorder





:Darrell-James: Hill, :Ohioan- beneficiary-Executor-Procurator, -:mitigation of the Trustee-derelict- damages: Twitter: September 24th, 2020, 7:05 p.m. - :March 9, 2021, 3:35 p.m.

uphold and defend The Constitution for the United States of America- 1787- 1789. et al. -Bill of Rights, et seq. -Emancipation Proclamation-1863-A.D., 'EP-1863-A.D.' and General Order 100- 1863-A.D. -all- overstanding, notwithstanding else of the office of the President for the United States- Corp here-to-for and now-to-after.

:You- all have been made to be aware of all of :these actions since 2016 A.D.;
You know or should have known :this non-abandonment of :claim-matter since 2017 A.D.
as now :All of :these-matters are :public-record !

Covenant-Agreement with procurator for the abandonment of the PFTUSA, -non-incorporated, abandoned January 20, 2021 A.D. and vacated March 03, 2021 A.D. by the man- Donald John Trump, et al.

:i- man here-to-for and now-to-after by the sovereign-duty receive now upon i- man as :kinsman-redeemer for Negro-Ysraol, Ysraol and the Holy-Church, et seq., the :authority and duty of office of the PFTUSA-Authority -heretofore-ABANDONED, and now-to-after stand-over the 'United-States- Corp', et al. : POTUS, et seq.

Covenant-Agreement with absolute-procurator as the Trustee, in-honor, for the restoration of the Private-property- claimed-and-possessed and stolen in :Trustee-fraud corroborated by Barack-Hussein-Obama, et al. -VP- Biden, CLT, -Loretta Lynch, et seq. -USAG/CLT, Donald John Trump, et al. -VP- Pence, CLT -Jeffrey Sessions, et seq. now to after until matter is completely remedied, in-accordance with the covenant-agreement-absolute-authority, in-procurator

:i- man here-to-for execute Sovereign-authority with absolute-procurator attaining to the stolen possessions- Lots # 1 - 7 :in-accordance with the covenant-agreements exclusively to attain the right to remedy to the aggrieved-beneficiary, i- man- darrell-james: hill, for the :exceeding-of-government-jurisdiction by deprivation-thof of private-property without right or authorization from i- man -owner. The office of the President of The United States- Corp., POTUS, -Trustee understands 1) the :DOI-1776-A.D., AOC-1777-A.D., and The Constitution for the United States of America, 1787-1789, et al. -Bill of Rights, et seq. -Emancipation Proclamation-1863-A.D., General Order 100- 1863-A.D.; 2) the Trustee: EBA-1933-A.D. Dry-Legislative-Trust -indenture with debenture to i- man -darrell-james: hill- beneficiary; and, 3) Trustee-Derection -in- Dishonor :within-fraud daily-harming the :beneficiary- aggrieved, -Darrell-James: Hill, -sole, and as :kinsman-redeemer for :Negro-Ysrael, Ysraol and the Holy-Church.

i- man affirm the above is true and correct and will press same onto the record in the open court

Without prejudice,

Darrell James Hill
Darrell-James: Hill, Sovereign-authority with- Procurator,
Executor with- Absolute-procurator

Affirmed and autographed before me this day 5, March 2021 A.D.
Type of Identification: Arizona Driver License,

notary public



'deprivation-penalty' amounts, and for (b) to assure and ensure the restoration for property claimed and possessed, in-specie, in-accordance with the covenant-agreements.

To: Military: Sovereign-authority with procurator by covenant: USPO GIN 7008 1410 0000 7868 5741
2 / 2

:Executor-Procurator, -:mitigation of the Trustee-derelict- damages ~

143 / 206



:Darrell-James: Hill, :Ohioan- beneficiary-Executor-Procurator, -:mitigation of the Trustee-derelict- damages: Twitter: September 24th, 2020, 7:05 p.m. - :March 9, 2021, 3:35 p.m.

The UPS Store #3750
 5301 S Superstition Avenue Dr Ste
 Lake County, AZ 85119-1917
 (520)474-8428

Facetel #: P2837503 Date: 3/5/2021
 Estimate #: 110527 Time: 12:17 PM

ITEM NAME	QTY	PRICE	TAX
Rate			\$19.00
Tax			\$3.00
9.5oz Container			\$1.13
Tax			\$1.09
Subtotal			\$11.12
Shipping/Other Charges			\$2.03
Total Tax			\$4.09
Total			\$17.14
Cash			\$20.00
Change back (Cash)			(\$2.86)

Some Postpaid IR are not eligible for Returns, Refunds or Exchanges.

US Postal Rates are Subject to Surcharges.

12103053750E001785

View the UPS Store, Inc.'s privacy notice at <https://www.theupsstore.com/privacy-notice>

APACHE JUNCTION
 151 W SUPERSTITION BLVD
 APACHE JUNCTION, AZ 85120-9098
 (602)275-8777

03/05/2021 11:19 AM

Product	Qty	Unit Price	Price
First-Class Mail® Letter			\$3.58
Washington, DC 20018			
Weight: 0.10 G, 0.00 OZ			
Estimated Delivery Date			
Tue 03/09/2021			
Certified MAIL®			\$3.60
Tracking #:			
700914100007865741			
e-Return Receipt			\$1.75
Total			\$9.20
Grand total:			\$26.34
Cash			\$100.00
Change			-\$73.66

USPS is experiencing unprecedented volume increases and limited employee availability due to the impacts of COVID-19. We appreciate your patience.

Use label # for liability on Return Receipt (Electronic)

In a hurry? Self-service kiosks offer quick and easy check-out. Any Retail Associate can show you how.

Text your tracking number to 23777 (USPS) to get the latest status. Standard Message

U.S. Postal Service
CERTIFIED MAIL® RECEIPT
 (Domestic Mail Only; No Insurance Coverage Provided)

For delivery information visit our website at www.usps.com

700914100007865741

OFFICIAL USE	
Postage	\$3.58
Carrier Fee	\$1.75
Return Receipt Fee (Electronic Receipt)	\$1.75
Registered Delivery Fee (Endorsement Required)	\$0.00
Other Postage & Fees	\$0.00
Total	\$7.08

03/05/2021

John End: Hiles
 Office: Carlos Ramirez
 Washington, District of Columbia 20018

12:11 PM · Mar 5, 2021 · Twitter Web App

:Executor-Procurator, -:mitigation of the Trustee-derelict- damages ~

2289



:Darrell-James: Hill, :Ohioan- beneficiary-Executor-Procurator, -:mitigation of the Trustee-derelict- damages: Twitter: September 24th, 2020, 7:05 p.m. - :March 9, 2021, 3:35 p.m.

March 6, 2021
2:26 p.m.



Darrell James hill
[@DarBenThu1](#)
[#GenMilley](#)
[@POTUS](#)
[@Mike Pence](#)
[@RSBNetwork](#)
[@DonaldJTrumpJr](#)
[@PressSec](#)
[@H2Ohio](#)
[@OHIOMFG](#)
[@OHSupremeCourt](#)
[@washingtonpost](#)
[@Ohio OBM](#)
[@NatlGovsAssoc](#)
[@UNHumanRights](#)
[@UNTreatyBodies](#)
[@BerniceKing](#)
[@OHCHR_EARO](#)
[@UNHumanRightsUA](#)
[@DrPaulGosar](#)
[@AZGOP](#)
[@anonpatriotg](#)
[@propublica](#)
[@Snowden](#)
[@wikileaks](#)

Quote Tweet



Darrell James hill
[@DarBenThu1](#)

Mar052021AD. :i- man-jurisdiction of :sovereign-authority with general-procuration (kinsman) as the PFTUSA overstanding: POTUS-trustee, & absolute-procuration over :stolen-property (/sole) :in-accordance w/ Covenant-agreements. :PFTUSA abandoned-01/20 and vacated 03/03/2021 A.D.

2290
:Executor-Procurator, -:mitigation of the Trustee-derelict- damages ~

145 / 206



:Darrell-James: Hill, :Ohioan- beneficiary-Executor-Procurator, -:mitigation of the Trustee-derelict- damages: Twitter: September 24th, 2020, 7:05 p.m. - :March 9, 2021, 3:35 p.m.

Darrell-James: Hill, Sovereign-authority with-Procurator,
PO Box 5939, Apache Junction, Arizona 85117

man -present

Arizona state
Pinal county

Jurat

Trustees:
:Mark-Alexander :General United States Army-Chairman: CJCS- Miday,
:John-Earl :General United States Air Force: Vice- CJCS- Hyten,
:James-Charles :General United States Army: CDS Army-
:David-Hiberry :General United States Marine Corps: CMC- Berger,
:Michael-Martin :Admiral United States Navy: CNO- Gaddy,
:David-Lee :General United States Air Force: COS AF- Goldfein,
:John-William :General United States Space Force: CDS- Raymond,
:Joseph-Lauren :General United States Air Force: CNG- Langford,
:Karl-Lee :Admiral United States Coast Guard: COG- Schultz
c/o :John-Earl :Hyten, USPO 7009 1410 0000 7008 6741
Office: CJCS
9900 Joint Staff Pentagon
Washington, District of Columbia 20315-0999

:Sovereign -:United States of America- people-Authority AND :Sovereign-Authority
Acceptance :In-Procurator by :Covenant-Agreements; for: a) :Receipt of the
Authority for the citizen-office: President for the United States of America -1787- A.D.,
non-incorporated, -Authority on the Abandonment and Vacation of the office of the
President by the man- Donald-John: Trump, -:Trustee, -:in- Dishonor; and b)
:Sovereign-Authority Acceptance :In-Procurator by :Covenant-Agreements: Lots
One, Two, Three, Four, Five, Six, and Seven (-failure to restore republic-constitution
for cause-)

Greetings, :Mark-Alexander, John-Earl, all;

man hope you are well;

man :Sovereign-authority with-procurator by :Covenant-Agreements
man-beneficiary, -Negro, -civilian, -principal, :Ohioan over-standing the Declaration of
Independence, '00-1776-A.D., et seq. -with-debature of the "United-States"- Corp -EBA-1993-
2000 A.D. -Dry-legislative-Trust; am (Kinmen-redactor for Negro-Yisrael, Yisrael) and the Holy-Church
of :Yeshua, 'Jesus', the Messiah; and, therefrom: Ambassador of the Most-High-God in -Trustee:
Cession: 1213-A.D.:

- 1) Sovereign-authority under God Almighty, wherein nothing stands between the God Almighty
and a man :Ohioan, et seq;
- 2) DC-1776-A.D.: Ohioan, is verified- one of the people of the United States of America;
- 3) AC-1777-A.D.: Articles of Confederation binding :Ohio -state;
- 4) The Constitution for the United States of America, 1787-1789, et al- Bill of Rights, et seq;
- and, 5) Express political-election, "PE", -covenant-agreement with right to remedy by and with
:absoluto-procurator.

Trustee- :Covenant-Agreement with Beneficiary-Remedy with and by :Absoluto-Procurator
5) Covenant-Contracts: PE, Lots 1-8, with Lot 0 being the executed-right-of-demand for the
account, settle and closure of the EBA-1993-A.D. -Dry-legislative-Trust -covenant-agreement; and,
with the Trustee-office :POTUS- :Obama, Trump and Biden, and POTUSA- :Trump, -agreements in
the express-absoluto-procurator by :man- Darrell-James: Hill, -beneficiary, for to obtain the right
of the remedy in the deprivation of property-matters: Lots 1-8;

1 Covenant-Agreement -procurator is merely for to assure and ensure the (a) :payment of the
To: Military: Sovereign-authority with procurator by covenant: USPO CIVIL 7009 1410 0000 7008 6741
1/2

2291

2292

← Tweet

2:26 PM · Mar 6, 2022

1 Retweet 1 Like

View Tweet activity

Tweet your photos and videos

Tweet Analytics

#GenMilley
 @POTUS
 @Mike_Pence
 @RSBNetwork
 @DonaldJTrumpJr
 @PressSec
 @H2Ohio
 @OHIOFMG
 @OHSupremeCourt
 @washingtonpost
 @Ohio_OBM
 @NatlGovsAssoc
 @UNHumanRights
 @UNTreatyBodies
 @BerniceKing
 @OHCHR_EARO
 @UNHumanRightsUA
 @DrPaulGosar
 @AZGOP
 @anonpatriotq
 @propublica
 @Snowden
 @wikileaks <https://twitter.com/DarBenThu1/status/1367915700866584576> ...

Impressions
 times people saw this Tweet on Twitter

285

3 hours ago
 ...leaving NBC
 ...years

4 hours ago
 ...y And Aaron
 ...New Statements
 ...Controversial
 ...mments

Privacy Policy [Cookie Policy](#)
 © 2021 Twitter, Inc.

2022-011769 MISC Page: 2502 of 2782
 09/26/2022 03:35:37 PM Receipt #: 22-9381
 Rec Fee: \$30.00 Darrell James Hill
 Gila County, Az, Sadie Jo Bingham, Recorder

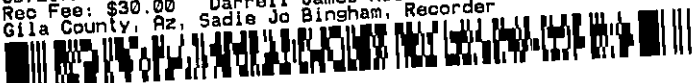



:Darrell-James: Hill, :Ohioan- beneficiary-Executor-Procurator, -:mitigation of the Trustee-derelict- damages: Twitter: September 24th, 2020, 7:05 p.m. - :March 9, 2021, 3:35 p.m.

uphold and defend The Constitution for the United States of America- 1787- 1789, et al. -Bill of Rights, et seq. -Emancipation Proclamation-1863-A.D., 'EP-1863-A.D.' and General Order 100- 1863-A.D. -as- overstanding, notwithstanding else of the office of the President for the United States- Corp here-to-for and now-to-after.

:You- all have been made to be aware of all of :those actions since 2016 A.D.;
You know or should have known :this non-abandonment of :claim-matter since 2017 A.D.
as now :All of :these-matters are :public-record I

Covenant-Agreement with procurator for the abandonment of the PFTUSA, -non-incorporated, abandoned January 20, 2021 A.D., and vacated March 03, 2021 A.D. by the man, Donald-John Trump, et al.

:i- man here-to-fore and now-to-after by the sovereign-duty receive now upon :i- man as :kinsman-redeemer for Negro-Ysrael, Ysrael and the Holy-Church, et seq., the :authority and duty of office of the PFTUSA-Authority -heretoforo-ABANDONED, and now-to-after stand-over the 'United-States- Corp', et al. -POTUS, et seq.

Covenant-Agreement with absolute-procurator as the Trustee, -in-honor, for the restoration of the Private-property- claimed-and-possessed and stolen in -Trustee-fraud corroborated by Barack-Hussein-Obama, et al. -VP- Biden, CLT -Loretta Lynch, et seq. -USAG/CLT, Donald-John Trump, et al. -VP-Pence, CLT -Jeffrey Sessions, et seq. now-to after until matter is completely remedied, in-accordance with the covenant-agreement-absolute-authority in-procurator

:i- man here-to-fore execute Sovereign-authority with absolute-procurator attaining to the stolen possessions- Lots ## 1 - 7 :in-accordance with the covenant-agreements exclusively to attain the right to remedy to the aggrieved-beneficiary, :i- man- darrell-james: hill, for the exceeding-of-government-jurisdiction by deprivation/loss of private-property without right or authorization from :i- man -owner, The office of the President of The United States- Corp., POTUS -Trustee understands 1) the :DOI-1776-A.D., AOC-1777-A.D., and The Constitution for the United States of Amence, 1787-1789, et al. -B# of Rights, et seq. -Emancipation Proclamation-1863-A.D., General Order 100- 1863-A.D.; 2) the Trustee: EBA-1933-A.D. De-Legislative-Trust -Indenture with debenture to :i- man -darrell-james: hill- beneficiary; and, 3) :Trustee-Dereliction -in- Dishonor :within-fraud daily-harming the :beneficiary- aggrieved, -:Darrell-James: Hill, -sole, and as :kinsman-redeemer for :Negro-Ysrael, Ysrael and the Holy-Church.

:i- man affirm the above is true and correct and will press :same onto the record in the open court

Without prejudice,

Darrell James Hill
Darrell-James: Hill, Sovereign-Authority with- Procurator,
Executor with- Absolute-Procurator

Affirmed and autographed before me this day 5, March 2021 A.D.
Type of Identification: Arizona Driver License.

notary public



'deprivation-penalty' amounts, and for (b) to assure and ensure the restoration for property-claimed and possessed, in-specie, in-accordance with the covenant-agreements.

To: Military: Sovereign-authority with procurator by covenant: USPO CMN 7009 1410 0000 7668 5741
212

:Executor-Procurator, -:mitigation of the Trustee-derelict- damages ~

147 / 206

2293
Unofficial



:Darrell-James: Hill, :Ohioan- beneficiary-Executor-Procurator, -:mitigation of the Trustee-derelict- damages: Twitter: September 24th, 2020, 7:05 p.m. - :March 9, 2021, 3:35 p.m.

The UPS Store #3752
 5361 S Superstition Mountain Dr Ste
 202b Carew, AZ 85119-1917
 481-474-9634

Serial#: 00007523 Date: 03/05/2021
 Employee: 110527 Time: 10:17 AM

Item Desc	Qty	Price	Tax
Priority Mail	1 0	\$13.00	\$1.00
1st Class Certified	10 2	\$2.81	\$1.13
Tax			\$1.93
Subtotal		\$16.81	
Shipping/Other Charges		\$2.81	
Total Tax		\$3.03	
Total		\$22.65	
Cash		\$23.00	
Change Back (Cash)		\$1.35	

Items Designated RM are NOT eligible for Returns, Refunds or Exchanges.

All Postal Rates Are Subject to Surcharges.

Visit The UPS Store, Inc.'s service center at <https://www.upsstore.com/retailer-locator>

UNITED STATES POSTAL SERVICE

APACHE JUNCTION
 151 W SUPERSTITION BLVD
 APACHE JUNCTION, AZ 85120-0098
 (602)275-8177

03/05/2021 11:19 AM

Product	Qty	Unit Price	Price
First-Class Mail® Letter			\$3.25
Washington, DC 20010			
Weight: 0 to 8.00 oz			
Estimated Delivery Date: Tue 03/09/2021			
Certified Mail®			\$3.60
Tracking #:			
20291410000076265741			
g-Retain Receipt			\$1.75
Total			\$9.90
Grand Total:			\$25.00
Cash			\$20.00
Change			\$34.10

USPS is experiencing unprecedented volume increases and limited employee availability due to the impacts of COVID-19. We appreciate your patience.

Use label 4 for legibility on Return Receipt (Electronic)

In a hurry? Self-service kiosks offer quick and easy check-out. Any Retail Associate can show you how.

Text your tracking number to 25777 (2USPS) to get the latest status. Standard Message.

**U.S. Postal Service®
 CERTIFIED MAIL® RECEIPT**
 (Domestic Mail Only; No Insurance Coverage Provided)

For delivery information visit our website at www.usps.com

OFFICIAL USE

Postage	\$3.25	03/05/2021
Carrier Fee	\$1.75	16
Return Receipt Fee (Endorsing Required)	\$0.00	
Postage Delivery Fee (Endorsing Required)	\$0.00	
Small Package & Pkg	\$1.00	

John Earl Hyles
 Office: Carlos Aguilar
 Washington District of Columbia 20548

2:26 PM · Mar 6, 2021 · Twitter Web App

March 7, 2021 Darrell James Hill
 4:45 p.m. @DarBenThu1

2295

Tweet Analytics

Darrell James hill @DarBenThu1
 #farmersofcolor
 #WomenFarmers
 youngfarmers #commodityfarmers
 #farmers #URBANFARMS #COOPS, #organic, #regenerativeagriculture
 #igrowfood #bornandraised #homegrownaustin @NFUDC
 #farming #veteranowned
 #brothelfarms #backyard <https://twitter.com/DarBenThu1/status/1367915700866584576> ...

Impressions	162
times people saw this Tweet on Twitter	
Total engagements	3
times people interacted with this Tweet	

[View all engagements](#)

Tweet

4:45 PM · Mar 7, 2022

1 Retweet 1 Like

View Tweet activity

Tweet your photos

Messages

...s leaving NBC years

4 hours ago

by And Aaron New Statements Controversial comments

...s defeat the Hofstra Pride

Privacy Policy Cookie Policy

© 2021 Twitter, Inc



:Darrell-James: Hill, :Ohioan- beneficiary-Executor-Procurator, -:mitigation of the Trustee-derelict- damages: Twitter: September 24th, 2020, 7:05 p.m. - :March 9, 2021, 3:35 p.m.

#farmersofcolor #WomenFarmers youngfarmers #commodityfarmers #farmers #URBANFARMS #COOPS, #organic, #regenerativeagriculture #igrowfood #bornandraised #homegrowninaustin @NFUDC #farming #veteranowned #brothelfarms #backyard

Quote Tweet



Darrell James hill
@DarBenThu1

Mar052021AD. :- man-jurisdiction of :sovereign-authority with general-procuration (/kinsman) as the PFTUSA overstanding: POTUS-trustee, & absolute-procuration over :stolen-property (/sole) :in-accordance w/ Covenant-agreements. :PFTUSA abandoned-01/20 and vacated 03/03/2021 A.D.

09/26/2022 03:35:37 PM Receipt #: 22-9381
Rec Fee: \$30.00 Darrell James Hill
Gila County, Az, Sadie Jo Bingham, Recorder



:Darrell-James: Hill, :Ohioan- beneficiary-Executor-Procurator, -:mitigation of the Trustee-derelict- damages: Twitter: September 24th, 2020, 7:05 p.m. - :March 9, 2021, 3:35 p.m.

Darrell-James: Hill, Sovereign-authority with-Procurator,
PO Box 3905, Apache Junction, Arizona 85117

man, -present

Arizona state
Pinal county

Jurat

Trustees:
:Mark-Alexander :General United States Army-:Chairman: CJCS- :Atley,
:John-East :General United States Air Force: Vice- CJCS- :Hyten,
:James-Charles :General United States Army, COS Army-
:David-Hilberry :General United States Marine Corps: CMC- :Barger,
:Michael-Marza :Admiral United States Navy: CNO- :Gibday,
:David-Lee :General United States Air Force: COS AF- :Goldfin,
:John-William :General United States Space Force: CSD- :Raymond,
:Joseph-Lauron :General United States Air Force: CNG- :Langyel
:Karl-Lee :Admiral United States Coast Guard: CCG- :Schutz
c/o :John-East :Hyten, USPO 7000 1410 0000 7868 6741
Office: CJCS
8999 Joint Staff Pentagon
Washington, District of Columbia 20318-9999

:Sovereign -United States of America- people-Authority AND :Sovereign-Authority
Acceptance :In-Procurator by :Covenant-Agreements; for: a) :Receipt of the
Authority for the citizen-office: President for the United States of America -1787- A.D.,
non-Incorporated, -Authority on the Abandonment and Vacation of the office of the
President by the man- Donald John: Trump, -:in- Dishonor; and b)
:Sovereign-Authority Acceptance :In-Procurator by :Covenant-Agreements: Lots
One, Two, Three, Four, Five, Six, and Seven (-failure to restore republic-constitution
for cause-)

Greetings, Mark-Alexander, John-East, all;

:man hope you are well.

man Jurisdiction: Sovereign-authority with-procurator by :Covenant-Agreements
:man-beneficiary: Negro, -civilian, -principal, Ohioan over-standing the Declaration of
Independence, '00-1776-A.D', et seq. -with-:debarment of the "United States"- Corp -EBA-1933-
2003 A.D. -Dry-legislative-Trust; am)Kinsman redeemer for Negro-Yaraol, Yaraol and the Holy Church
of Yeshua, Jesus, the Messiah; and, therefrom: Ambassador of the Most-High-God an -Trustee:
Concession-1213-A.D.:

- 1) Sovereign-authority under God Almighty, wherein nothing stands between the God Almighty
and the man Ohioan, et seq;
- 2) DC-1776-A.D.: Obedience, is verified: one of the people of the United States of America;
- 3) AC-1777-A.D.: Articles of Confederation binding: Ohio -state;
- 4) The Constitution for the United States of America, 1787 -1789, et seq. Bill of Rights, et seq.;
- and, 5) Express political-election, "PE", -covenant-agreement with right to remedy by and with
absolute-procurator.

Trustee: Covenant-Agreement with -Beneficiary-Beneficiary with and by -Absolute-Procurator
5) Covenant-Contracts: PE, Lots 1-5, with Lot 6 being the -executed -right-of-demand for the
accounts, bills and claims of the EBA-1933-A.D. -Dry-legislative-Trust -covenant-agreement; and,
with the Trustee; office :POTUS - :Obama, Trump and Biden, and POTUSA- :Trump, -agreements in
the express -absolute-procurator by it-man- Darrell-James: Hill, -beneficiary, for to obtain the right
of the remedy in the deprivation of property-matters: Lots 1-6'.

1 Covenant-Agreement -procurator is merely for to ensure and ensure the 5a) :payment of the
To: Military: Sovereign-authority with procurator by covenant: USPO 07/01 7000 1410 0000 7868 6741
3 / 2

22917



:Darrell-James: Hill, :Ohioan- beneficiary-Executor-Procurator, -:mitigation of the trustee-derelict- damages: Twitter: September 24th, 2020, 7:05 p.m. - :March 9, 2021, 3:35 p.m.

uphold and defend The Constitution for the United States of America- 1787- 1789, et al. -Bill of Rights, et seq -Emancipation Proclamation-1863-A.D., 'EP-1863-A.D.' and General Order 100- 1863-A.D. ,all- overstanding, notwithstanding else of the office of the President for the United States-Corp here-to-for and now-to-after.

:You- all have been made to be aware of all of :these actions since 2016 A.D.;
You know or should have known :this non-abandonment of :claim-matter since 2017 A.D. as now :All of :these-matters are :public-record !

Covenant-Agreement with procurator for the abandonment of the PFTUSA -non-incorporated abandoned January 20, 2021 A.D., and vacated March 03, 2021 A.D. by the man: Donald John Trump, et al.
:I- man here-to-fore and now-to-after by the sovereign-duty receive now upon :I- man as kinsman-redeemer for Negro-Ysrael, Ysrael and the Holy Church, et seq. the :authority and duty of office of the PFTUSA-Authority -heretofore-ABANDONED, and now-to-after stand-over the United-States- Corp', et al. -POTUS, et seq.

Covenant-Agreement with absolute-procurator as the Trustee, in-honor, for the restoration of the Private-property, claimed and possessed and stolen in :Trustee-fraud corroborated by: Barack-Hussein Obama, et al. -VP- Biden, CLT - Lorella Lynch, et seq - USAG/CLT Donald John Trump, et al. -VP-Pence, CLT - Jeffrey Sessions, et seq. now to after until matter is completely remedied. In-accordance with the covenant-agreement-absolute-authority in-procurator
:I- man here-to-fore execute Sovereign-authority with absolute-procurator attaining to the stolen possessions- Lots # 1 - 7 :in-accordance with the covenant-agreements exclusively to attain the right to remedy to the aggrieved-beneficiary, :I- man- darrell-james: hill, for the :recoeding-of- government-jurisdiction by deprivation/ theft of private-property without right or authorization from :I- man -owner. The office of the President of The United States- Corp., POTUS, -Trustee understands 1) the :DOI-1776-A.D., AOC-1777-A.D., and The Constitution for the United States of America, 1787- 1789, et al. -Bill of Rights, et seq -Emancipation Proclamation-1863-A.D., General Order 100- 1863-A.D.; 2) the Trustee: EBA-1933-A.D. Dry-Legislative-Trust -indenture with dobenure to :I- man -darrell-james: hill- beneficiary; and, 3) :Trustee-Dereliction -in- Dishonor :within-fraud duty-harming the :beneficiary- aggrieved, -:Darrell-James: Hill, sole, and as :kinsman-redeemer for :Negro-Ysrael, Ysrael and the Holy Church.

I- man affirm the above is true and correct and will press :same onto the record in the open court

Without prejudice,
Darrell James Hill
Darrell-James: Hill, Sovereign-authority with- Procurator,
Executor with- Absolute-procurator

Affirmed and autographed before me this day 5, March 2021 A.D.
Type of Identification: Arizona Driver License.

[Signature]
notary public

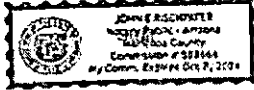

'deprivation-penalty' amounts, and for (b) to assure and ensure the restoration for property-claimed and possessed, in-specie, in-accordance with the covenant-agreements.

To, Military: Sovereign-authority with procurator by covenant: USPO CMN 7009 1410 D000 7868 5741
2 / 2

2290
Unofficial



:Darrell-James: Hill, :Ohioan- beneficiary-Executor-Procurator, -:mitigation of the trustee-derelict- damages: Twitter: September 24th, 2020, 7:05 p.m. - :March 9, 2021, 3:35 p.m.

The UPS Store 63750
 5341 S Superstition Route Dr Ste
 6376 Chandler, AZ 85120-1913
 482-474-9128

Invoice #: P031520 Date: 3/9/2021
 Estimate #: 118527 Time: 10:17 AM

ITEM NAME	QTY	PRICE	TAX
Water	1 B	810.00	\$10.63
Tax			\$1.63
Self Center	1 B	58.11	\$1.13
Tax			\$1.59
Subtotal			
Shipping/Other Charge			\$2.23
Total tax			\$3.63
Total			
			\$11.16
Cash			\$22.84
Cash back (Cash)			(\$9.62)

States Designated as not eligible for Returns, Refunds or Exchanges.

US Postal Rates are Subject to Surcharges.

Visit the UPS Store, Inc.'s privacy policy at <https://www.upsstore.com/privacy-policy>

APACHE JUNCTION
 551 W SUPERSTITION BLVD
 APACHE JUNCTION, AZ 85120-9768
 48002875-8777

03/05/2021 11:18 AM

Product	Qty	Unit Price	Price
First-Class Mail® Letter	1		\$0.55
Washington, DC 20018			
Weight: 0.14 3.62 oz			
Estimated Delivery Date			Tue 03/09/2021
Certified Mail®			\$3.60
Tracking #:			7009341600078682741
e-Return Receipt			\$1.70
Total			
\$5.90			
Grand Total:			
\$2.90			
Cash			\$100.00
Change			-\$94.10

USPS is experiencing unprecedented volume increases and limited employee availability due to the impacts of COVID-19. We appreciate your patience.

Use label # for inquiry on Return Receipt (Electronic)

In a hurry? Self-service kiosks offer quick and easy check-out. Any Retail Associate can show you how.

Text your tracking number to 23777 (USPS) for more info. Text only. Standard Message.

Visit www.usps.com

121030537508001785

U.S. Postal Service
CERTIFIED MAIL® RECEIPT
(Domestic Mail Only; No Insurance Coverage Provided)

OFFICIAL USE

Package #	1378	0120
Weight	\$0.00	16
Certified Fee	\$1.70	
Return Receipt Fee (Electronic Receipt)	\$0.00	
Registered Delivery Fee (Domestic Mail Only)	\$0.00	
Postnet Fee	\$0.00	
Total Package & Postage	\$5.90	

03/05/2021

John Ford, Helen
 Office of the Recorder
 Washington, D.C. 20018

4:45 PM · Mar 7, 2021 · Twitter Web App

2299



:Darrell-James: Hill, :Ohioan- beneficiary-Executor-Procurator, -:mitigation of the Trustee-derelict- damages: Twitter: September 24th, 2020, 7:05 p.m. - :March 9, 2021, 3:35 p.m.

March 8, 2021
10:55 a.m.



Darrell James Hill
@DarBenThu1

:i- man am Negro-Judah: Ysrael, :kinsman for :Ysrael and the Holy-Church, amb. of Yushuah ~Jesus~ the Messiah in trustee: Concession 1213 A.D. COINTELPRO is anti-Messiah.

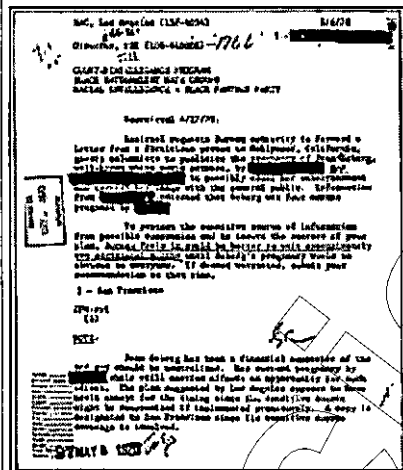

en.wikipedia.org
COINTELPRO - Wikipedia
10:55 AM · Mar 8, 2021 · Twitter Web App

March 8, 2021
2:13 p.m.

Darrell James Hill
@DarBenThu1
#LarryFitzgerald #JJWatt #S

Quote Tweet



Darrell James Hill
@DarBenThu1

:i- man am Negro-Judah: Ysrael, :kinsman for :Ysrael and the Holy-Church, amb. of Yushuah ~Jesus~ the Messiah in trustee: Concession 1213 A.D. COINTELPRO is anti-Messiah. <https://en.wikipedia.org/wiki/COINTELPRO>



:Darrell-James: Hill, :Ohioan- beneficiary-Executor-Procurator, -:mitigation of the Trustee-derelict- damages: Twitter: September 24th, 2020, 7:05 p.m. - :March 9, 2021, 3:35 p.m.

2:13 PM · Mar 8, 2021 · Twitter Web App

March 8, 2021
4:00 p.m.



Darrell James Hill
[@DarBenThu1](#)
<http://hoppeblack.us>
[@naaganational](#)
[@AfricanAncestry](#)
[@BlackHealthNews](#)
[@Data4BlackLives](#)
[@Wademenendez](#)
[@deepoku](#)
[@BrigitteDaniel](#)
[@AfroTech](#)
[@BB Bloggers](#)
[@chancetherapper](#)
[@africacentre](#)

that, you know this has been done.

Quote Tweet



Darrell James Hill
[@DarBenThu1](#)

Mar052021AD. :- man-jurisdiction of :sovereign-authority with general-procuration (/kinsman) as the PFTUSA overstanding: POTUS-trustee, & absolute-procuration over :stolen-property (/sole) :in-accordance w/ Covenant-agreements. :PFTUSA abandoned-01/20 and vacated 03/03/2021 A.D.

2301
:Executor-Procurator, -:mitigation of the Trustee-derelict- damages ~

154 / 206

2302

Darrell James hill on Twitter: "i- man am Negro-Judah: Ysrael, :kinsman for :Ysrael and the Holy-Church, amb. of Yushuah -Jesus- the Messiah in trustee: Concession 1213 A.D. COINTELPRO is anti-Messiah. https://L.co/gsexixqJF / Twitter - Mozilla

File Edit View History Bookmarks Tools Help

https://twitter.com/DarBenThu1/status/1368983616093519876/analytics

Getting Started EXECUTIVE ORDERS REF COMMERCE DAVID STRAIGHTERS AJ

Tweet Analytics

Darrell James hill @DarBenThu1
 i- man am Negro-Judah: Ysrael, :kinsman for :Ysrael and the Holy-Church, amb. of Yushuah -Jesus- the Messiah in trustee: Concession 1213 A.D. COINTELPRO is anti-Messiah. <https://en.wikipedia.org/wiki/COINTELPRO>

Impressions	2,970
times people saw this Tweet on Twitter	
Total engagements	10
times people interacted with this Tweet	

[View all engagements](#)

Promote your Tweet
 Your Tweet has 2,970 total impressions so far.

10:55 AM Mar 8, 2022

1 Quote Tweet

Messages

Tuesday November 9, 21:37



2303

Tweet Analytics

Darrell James hill @DarBenThu1
 #LarryFitzgerald #JJWatt #SuperBowl #ArizonaCardinals #NFL #Patriots
 #Panthers #Packers #Bears #Browns #Bills #Ravens #Rams #Raiders #Titans
 #Vikings #Falcons #Dolphins #Chiefs #Cowboys #Giants #Jaguars #Eagles
 #Jets #49ers #Seahawks #Steelers #Saints https://twitter.com/DarBenThu1/status/1368983616093519876 ...

Impressions	2,963
times people saw this Tweet on Twitter	
Total engagements	3
times people interacted with this Tweet	

[View all engagements](#)

Promote your Tweet

future today!

min Bloom

mas - 3 hours ago

leaving NBC

ears

This afternoon

iana's revenge

relevant, 27 years

Tuesday November 9, 21:37



2304

Darrell James hill on Twitter: <https://t.co/sNY56NEVH> @naaganational @AfricanAncestry @BlackHealthNews @Data4BlackLives @Wademenendez @deepoku @BrigitteDaniel @AfroTech @BB_Bloggers @chancetherapper @africacentre that, you...

File Edit View History Bookmarks Tools Help

Mail All Mail - djhill X New Tab X Onkyo receiver X Apache Junc... X WunderMap X M Inbox (107) X Total Praise - Y X Darrell James | X b-1020-intro X a-2020-09-20 X New Tab X

https://twitter.com/DarBenThu1/status/1369060460125818883/analytics

Getting Started EXECUTIVE ORDERS REF COMMERCE DAVID STRAIGHTERS AJ

Tweet Analytics

Darrell James hill @DarBenThu1
<http://hoppeblack.us>
 @naaganational
 @AfricanAncestry
 @BlackHealthNews
 @Data4BlackLives
 @Wademenendez
 @deepoku
 @BrigitteDaniel
 @AfroTech
 @BB_Bloggers
 @chancetherapper
 @africacentre

that, you know this has been done. <https://twitter.com/DarBenThu1/status/1367915700866584576> ...

Impressions
 times people saw this Tweet on Twitter **175**

Total engagements
 times people interacted with this Tweet **2**

4:00 PM - Mar 8, 2020

View Tweet activity

messages

Privacy Policy Cookie Policy © 2021 Twitter, Inc

Tuesday November 9, 21:37





:Darrell-James: Hill, :Ohioan- beneficiary-Executor-Procurator, -:mitigation of the Trustee-derelict- damages: Twitter: September 24th, 2020, 7:05 p.m. - :March 9, 2021, 3:35 p.m.

Darrell-James: Hill, Sovereign-authority with-Procurator,
PO Box 3806, Apache Junction, Arizona 85117

i-man, -present
Arizona state
Pinal county
Jurat

Trustees:
:Mark-Alexander :General United States Army :Chairman CJCOS :Milroy,
:John-Earl :General United States Air Force: Vice- CJCOS :Hyten,
:James-Charles :General United States Army: COS Army:
:David-Hibery :General United States Marine Corps: CMC :Berger,
:Michael-Martin :Admiral United States Navy: CNO :Giday,
:David-Lee :General United States Air Force: COS AF :Goldstein,
:John-William :General United States Space Force: COS :Raymond,
:Joseph-Louton :General United States Air Force: CNG :Langgyl
:Karl-Lee :Admiral United States Coast Guard: CCG :Schultz
et al : John-Earl Hyten, USPO 7009 1410 0000 7868 6741
Office, CJCOS
5529 Joint Staff Pentagon
Washington, District of Columbia 20318-5599

:Sovereign :United States of America- people-Authority AND :Sovereign-Authority
Acceptance :in-Procurator by :Covenant-Agreements; for: a) :Receipt of the
Authority for the citizen-offices President for the United States of America -1787- A.D.,
-non-incorporated, -Authority on the Abandonment and Vacation of the office of the
President by the man- Donald-John: Trump, -:Trustee, -:in- Dishonor; and b)
:Sovereign-Authority Acceptance :in-Procurator by :Covenant-Agreements: Lots
One, Two, Three, Four, Five, Six, and Seven (-failure to restore republic-constitution
for cause-)

Greetings, :Mark-Alexander, John-Earl, all,
i- man hope you are well.

i-man-:jurisdiction, Sovereign-authority with-procurator by :Covenant-Agreements
i- man-beneficiary - Negro, -civilian, -principal, -Ohioan over-standing the Declaration of
Independence, 1776-A.D., et seq. -with -denial of the United-States- Gory -EBA-1803-
2003-A.D. -Dry-legislative-Trust; an i-kans-man-redemptor for Negro-Yaraal, Yaraal and the Holy Church
of Yehusha, "Jesus", the Messiah; and, therefore: Ambassador of the Most-High-God in -Trustee:
Concession-1213-A.D.:

1) Sovereign-authority under God Almighty, wherein nothing stands between the God Almighty
and i- man Ohioan, et al;

2) DCI-1776-A.D.: Ohioan, is verified one of the people of the United States of America;

3) ACC-1777-A.D.: Articles of Confederation binding :Ohio -state;

4) The Constitution for the United States of America, 1787 -1789, et al- Bill of Rights, et seq;

and, 5) Express-political-election, "PE", -covenant-agreement with right to remedy by and with
:absoluto-procurator.

Trustee: Covenant-Agreement with Beneficiary: Remedy with and by :Absoluto-Procurator
5) Covenanti-Contracts: PE, Lots 1-5, with Lot 6 being the :executed -right -of -demand for the
security, settle and close of the EBA-1803-A.D. -Dry-legislative-Trust -covenant-agreement and,
with the Trustee office :POTUS - Obama, Trump and Biden, and POTUSA :Trump, -agreements in
the express -absoluto -procurator by i- man- Darrell-James: Hill, -beneficiary, for to obtain the :right
of the remedy in the deprivation of property matters: Lots 1-6'

1 Covenant-Agreement -procurator is merely for to ensure and ensure the (a) :payment of the
To: Military: Sovereign-authority with procurator by covenant: USPO GMN 7009 1410 0000 7868 6741
1 / 2

2305



:Darrell-James: Hill, :Ohioan- beneficiary-Executor-Procurator, -:mitigation of the Trustee-derelict- damages: Twitter: September 24th, 2020, 7:05 p.m. - :March 9, 2021, 3:35 p.m.

uphold and defend The Constitution for the United States of America- 1787- 1789, et al. -Bill of Rights, et seq. -Emancipation Proclamation-1863-A.D., 'EP-1863-A.D.' and General Order 100- 1863-A.D. .as- overstanding, notwithstanding else of the office of the President for the United States- Corp here-to-for and now-to-alter.

:You- all have been made to be aware of all of :those actions since 2016 A.D.;
You know or should have known :this non-abandonment of :claim-matter since 2017 A.D. as now :All of :these-matters are :public-record 1

Covenant-Agreement with-procuration for the abandonment of the PFTUSA, -non-incorporated, abandoned January 20, 2021 A.D. and vacated March 03, 2021 A.D. by the man- Donald-John- Trump, et al.

i- man here-to-fore and now-to-after by the sovereign-duty receive-now upon i- man as kinsman-redeemer for Negro-Ysrael, Ysrael and the Holy-Church, et seq., the :authority and duty of office of the PFTUSA-Authority -heretofore-ABANDONED, and now-to-alter stand-over the 'United-States- Corp', et al. - :POTUS, et seq.

Covenant-Agreement with absolute-procuration as the Trustee, -in-honor, for the restoration of the Private-property, -claimed-and-possessed and stolen, in :Trustee-fraud corroborated by, Barack-Hussein-Obama, et al. -VP- Biden, CLT -Loretta-Lynch, et seq- USAG/CLT, Donald-John- Trump, et al. -VP- Pence, CLT - Jeffrey- Sessions, et seq. now to after until matter is completely remedied, in-accordance with the covenant-agreement-absolute-authority-in-procuration

i- man here-to-fore execute Sovereign-authority with absolute-procuration attaining to the stolen possessions- Lots # 1 - 7 in-accordance with the covenant-agreements exclusively to attain the right to remedy to the aggrieved-beneficiary, i- man- darrell-james: hill, for the :exceeding-of-government-jurisdiction by deprivation/theft of private-property without right or authorization from i- man -owner, The office of the President of The United States- Corp., POTUS, -Trustee understands 1) the :DOI-1776-A.D., AOC-1777-A.D., and The Constitution for the United States of America, 1787-1789, et al. -Bill of Rights, et seq. -Emancipation Proclamation-1863-A.D., General Order 100- 1863-A.D.; 2) the Trustee: EBA-1933-A.D. Dry-Legislative-Trust -indenture with debtenture to i- man -darrell-james: hill- beneficiary; and, 3) :Trustee-Dereliction -in- Dishonor, within-fraud daily-harming the :beneficiary- aggrieved, -Darrell-James: Hill, -sole, and as :kinsman-redeemer for :Negro-Ysrael, Ysrael and the Holy-Church.

i- man affirm the above is true and correct and will press :same onto the record in the open court

Without prejudice,

Darrell James Hill
Darrell-James: Hill, Sovereign-Authority with-Procuration, Executor With- Absolute-procuration

Affirmed and autographed before me this day 5, March 2021 A.D.
Type of Identification: Arizona Driver License.

notary public



'deprivation-penalty' amounts, and for (b) to assure and ensure the restoration for property-claimed and possessed, in-specie, in-accordance with the covenant-agreements.

To: Military: Sovereign-authority with procuration by covenant: USPO CMN 7009 1410 0000 7868 5741
2 / 2

2306
Unoff

:Executor-Procurator, -:mitigation of the Trustee-derelict- damages ~



:Darrell-James: Hill, :Ohioan- beneficiary-Executor-Procurator, -:mitigation of the Trustee-derelict- damages: Twitter: September 24th, 2020, 7:05 p.m. - :March 9, 2021, 3:35 p.m.

The UPS Store #2752
 5511 S Superstition Mountain Dr Ste
 604 Phoenix, AZ 85119-1911
 480-274-9928

Received..... P2237523 Date: 3/8/2021
 Estimate..... 116537 Time: 13:17:08

ITEM NAME	QTY	PRICE	TAX
History			\$12.00
Box	1 B	\$10.00	\$2.00
8.5x11 Envelopes	10 P	\$2.11	\$1.10
Tax			\$2.00
Subtotal			\$11.10
Shipping/Other Charges			\$2.80
Total tax			\$5.60
Total			\$11.10
Cash			\$20.00
Change Back (Cash)			(\$8.90)

Change Back (Cash) (\$8.90)

States Designated SA are NOT eligible for Refunds, Refunds or Exchanges.

US Postal Rates Are Subject to Surcharges.

121030537506001785

View the UPS Store, Inc.'s privacy notice at <https://www.upsstore.com/privacy-policy>

UNITED STATES POSTAL SERVICE

APACHE JUNCTION
 151 W SUPERSTITION BLVD
 APACHE JUNCTION, AZ 85120-9998
 (602)275-3177

03/08/2021 11:45 AM

Product	Qty	Unit Price	Price
First-Class Mail® Letter	1		\$0.55
Washington, DC 20618			
Weight: 0 to 0.60 oz			
Estimated Delivery Date			
Tue 03/09/2021			
Certified Mail®			\$3.00
Tracking #			
700914100007050741			
Return Receipt			\$1.05
Total			\$5.60
Grand Total:			\$5.60
Cash			\$100.00
Change			-\$94.40

USPS is experiencing unprecedented volume surges and limited employee availability due to the impacts of COVID-19. We appreciate your patience.

Use label # for inquiry on Return Receipt (electronic)

In a hurry? Self-service kiosks offer quick and easy check-out. Any Retail Associate can show you how.

Text your tracking number to 25777 (2USPS) to get the latest status. Standard Message

U.S. Postal Service™
CERTIFIED MAIL™ RECEIPT
 (Domestic Mail Only; No Insurance Coverage Provided)

For delivery information visit our website at www.usps.com
 Visit us at www.usps.com

Item	Amount	Postmark
Postage	\$0.55	03/08
Certified Fee	\$1.75	
Return Receipt Fee (Encl. or Proof of Delivery)	\$1.00	
Restricted Delivery Fee (Encl. or Proof of Delivery)	\$0.00	
Total Postage & Fees	\$3.30	

03/05/2021

John-Ed. Hillen
 151 W SUPERSTITION BLVD
 APACHE JUNCTION, AZ 85120-9998
 Washington District Columbia 20548

4:00 PM · Mar 8, 2021 · Twitter Web App

March 8, 2021 Darrell James Hill
 8:42 p.m. @DarBenThu1

:Executor-Procurator, -:mitigation of the Trustee-derelict- damages ~ 157 / 206



:Darrell-James: Hill, :Ohioan- beneficiary-Executor-Procurator, -:mitigation of the Trustee-
derelict- damages: Twitter: September 24th, 2020, 7:05 p.m. - :March 9, 2021, 3:35 p.m.

See: Notice of execution of Your 'Unalienable-right'

[@hempfarmsofny@ENYFARMS](#)

[@IrvingFarm](#)

[@SalemFarmSupply](#)

[@WestFarmsNY](#)

[@TinyHouseFarmA1](#)

[@musicfarmny](#)

[@BigAliceBrewing](#)

[@WoodlandBeer](#)

[@RulfsOrchards](#)

[@LithologyBrew](#)

[@BardCollegeFarm](#)

[@jenssilverberg](#)

[@ninepincider](#)

[@saintjamesbrew](#)

Quote Tweet



Darrell James Hill

[@DarBenThu1](#)

Mar052021AD. :i- man-jurisdiction of :sovereign-authority with general-procuration
(/kinsman) as the PFTUSA overstanding: POTUS-trustee, & absolute-procuration
over :stolen-property (/sole) ;in-accordance w/ Covenant-agreements. :PFTUSA
abandoned-01/20 and vacated 03/03/2021 A.D.

2308
:Executor-Procurator, -:mitigation of the Trustee-derelict- damages ~

158 / 206

2309

Darrell James Hill on Twitter: "See: Notice of execution of Your 'Unalienable-right' @hempfarmsofny@ENYFARMS @IrvingFarm @SalemFarmSupply @WestFarmsNY @TinyHouseFarmA1 @musicfarmny @BigAliceBrewing @WoodlandBeer @RulfsOrcha..."

File Edit View History Bookmarks Tools Help

All Mail - djhill X New Tab X Onlyo receiver X Apache Juncu X WunderMap X Mi Inbox (107) X Total Praise X Darrell James Hill X b-1020-intro X a-2020-09-20 X New Tab X

https://twitter.com/DarBenThu1/status/1369131388822192133/analytics 150%

Getting Started EXECUTIVE ORDERS REF COMMERCE DAVID STRAIGHTERS AJ

Tweet Analytics

Darrell James Hill @DarBenThu1
 See: Notice of execution of Your 'Unalienable-right'
 @hempfarmsofny@ENYFARMS
 @IrvingFarm
 @SalemFarmSupply
 @WestFarmsNY
 @TinyHouseFarmA1
 @musicfarmny
 @BigAliceBrewing
 @WoodlandBeer
 @RulfsOrchards
 @LithologyBrew
 @BardCollegeFarm
 @jennsilverberg
 @ninepincider
 @saintjamesbrew <https://twitter.com/DarBenThu1/status/1367915700866584576> ...

Impressions 157
 times people saw this Tweet on Twitter

Total engagements 2
 times people interacted with this Tweet

fiana's revenge relevant, 27 years

atball trending

ugars defeat the House Price

4 hours ago

ey And Aaron New Statements Controversial mments

Privacy Policy Cook Policy © 2021 Twitter, Inc

messages

Tuesday November 9, 21:36

2022-011769 MISC Page: 2519 of 2782

09/26/2022 03:35:37 PM Receipt #: 22-9381
 Rec Fee: \$30.00 Darrell James Hill
 Gila County, Az, Sadie Jo Bingham, Recorder





:Darrell-James: Hill, :Ohioan- beneficiary-Executor-Procurator, -:mitigation of the Trustee-derelict- damages: Twitter: September 24th, 2020, 7:05 p.m. - :March 9, 2021, 3:35 p.m.

Darrell-James: Hill, Sovereign-authority with-Procurator,
PO Box 3306, Apache Junction, Arizona 85117

:man, -present

Arizona state
Pinal county

Jurat

Trustees:
:Mark-Alexander :General United States Army:Chairman: CJCS: Milley,
:John-Earl :General United States Air Force: Vice- CJCS: Hyten,
:James-Charles :General United States Army: COA Army,
:David-Hibery :General United States Marine Corps: CMC: Berger,
:Michael-Martin :Admiral United States Navy: CNO: Gaddy,
:David-Lee :General United States Air Force: COS AF: Goldfein,
:John-William :General United States Space Force: CSO: Raymond,
:Joseph-Laurore :General United States Air Force: CNG: Lengyel
:Karl-Lee :Admiral United States Coast Guard: CCG: Schultz
c/o :John-Earl :Hyten, USPO 7009 1410 0000 7008 6741
Office: CJCS
3903 Joint Staff Pentagon
Washington, District of Columbia 20315-0890

:Sovereign -United States of America- people-Authority AND :Sovereign-Authority
Acceptance :in-Procurator by :Covenant-Agreements: for: a) :Receipt of the
Authority for the citizen-office: President for the United States of America -1787- A.D.,
-non-incorporated, -Authority on the Abandonment and Vacation of the office of the
President by the man- Donald-John: Trump, -:Trustee, -:in- Dishonor; and b)
:Sovereign-Authority Acceptance :in-Procurator by :Covenant-Agreements: Lots
One, Two, Three, Four, Five, Six, and Seven (-failure to restore republic-constitution
for cause-)

Greetings, :Mark-Alexander, John-Earl, all:

:I man hope you are well.

:man- Jurisdiction: Sovereign-authority with-procurator by :Covenant-Agreements
:I man-beneficiary, -Negro, -civilian, -principal, :Ohioan over-standing the Declaration of
Independence, "DCI-1776-A.D.", et seq., -with -debarment of the "United States" Corp -EBA-1833-
2003-A.D. -Dry-legislative-Trust; am :Kinsman-sadamer for Negro-Yisrael, Yisrael and the Holy Church
of Antehyah, "Jahus", the Messiah; and, therefore: Ambassador of the Most-High-God in -Trustee:
Concession-1213-A.D.:

- 1) Sovereign-authority under God Almighty, where in nothing stands between the God Almighty
and :I man Ohioan, et al;
- 2) DCI-1776-A.D.: Chican, is verified one of the people of the United States of America;
- 3) ASC-1777-A.D.: Articles of Confederation binding :Ohio-zstate;
- 4) The Constitution for the United States of America, 1787-1788, et al- Bill of Rights, et seq.;
- and, 5) Express political-election, "PE", -covenant-agreement with right to remedy by and with
absolute-procurator.

Trustee: Covenant-Agreement with :Beneficiary-Remedy, with and by Absolute-Procurator
5) Covenant-Contracts: PE, Lots 1-5, with Lot 6 being the recorded -right-of -demand for the
account, settle and closure of the EBA-1833-A.D. -Dry-legislative-Trust -covenant-agreement, and,
with the Trustee office :POTUS - Obama, Trump and Biden, and POTUSA - Trump, -agreements in
the express -absolute -procurator by :I man- Darrell-James: Hill, -beneficiary, for to obtain the :right
of the remedy in the deprivation of property matters. Lots 1-6'

I Covenant-Agreement -procurator is merely for to-ensure and ensure the (a) :payment of the

To: Military: Sovereign-authority with procurator by covenant: USPO CM21 7009 1410 0000 7008 6741
1 / 2

2310



:Darrell-James: Hill, :Ohioan- beneficiary-Executor-Procurator, -:mitigation of the Trustee-derelict- damages: Twitter: September 24th, 2020, 7:05 p.m. - :March 9, 2021, 3:35 p.m.

uphold and defend The Constitution for the United States of America- 1787- 1789, et al. -Bill of Rights, et seq. -Emancipation Proclamation-1863-A.D., 'EP-1863-A.D.' and General Order 100- 1863-A.D. -all- overstanding, notwithstanding else of the office of the President for the United States- Corp here-to-for and now-to-after.

:You- all have been made to be aware of all of :these actions since 2016 A.D.;
You know or should have known :this non-abandonment of :claim-matter since 2017 A.D. as now :All of :these-matters are :public-record !

Covenant-Agreement :with-procurator for the abandonment of the PFTUSA, -non-incorporated, abandoned January 20, 2021 A.D. and vacated March 03, 2021 A.D. by the man-Donald-John- Trump, et al.

:i- man here-to-for and now-to-after by the sovereign-duty receive-now upon :i- man as :kinsman-redeemer for Negro-Ysrael, Ysrael and the Holy-Church, et seq., the :authority and duty of office of the PFTUSA-Authority -heretofore-ABANDONED, and now-to-after stand-over the 'United-States- Corp', et al. :POTUS, et seq.

Covenant-Agreement with absolute-procurator as the Trustee, -in-honor, for the restoration of the Private-property, -claimed-and-possessed and stolen, in, Trustee-fraud corroborated by, Barack-Hussein-Obama, et al. -VP- Biden, CLT -Loretta Lynch, et seq -USAG/CLT Donald-John- Trump, et al. VP- Pence, CLT - Jeffrey Sessions, et seq. now to after until matter is completely remedied, in-accordance with the covenant-agreement-absolute-authority, in procurator

:i- man here-to-for execute Sovereign-authority with absolute-procurator attaining to the stolen possessions- Lots # 1 - 7 :in-accordance with the covenant-agreements exclusively to attain the right to remedy to the aggrieved-beneficiary, :i- man- darrell-james- hill, for the :exceeding-of- government-jurisdiction by deprivation/theft of private-property without right or authorization from :i- man -owner, The office of the President of The United States- Corp., POTUS, Trustee understands 1) the :DOI-1776-A.D., AOC-1777-A.D., and The Constitution for the United States of America, 1787- 1789, et al. -Bill of Rights, et seq. -Emancipation Proclamation-1863-A.D., General Order 100- 1863-A.D.; 2) the Trustee: EBA-1933-A.D. Dry-Legislative-Trust -Indenture with debenture to :i- man -darrell-james: hill- beneficiary; and, 3) :Trustee-Derection -in- Dishonor :within-fraud daily-harming the :beneficiary- aggrieved, -Darrell-James: Hill, -sole, and as :kinsman-redeemer for :Negro-Ysrael, Ysrael and the Holy-Church.

:i- man affirm the above is true and correct and will press :same onto the record in the open court

Without prejudice,

Darrell James Hill
Darrell James: Hill, Sovereign-Authority with-Procurator,
Executor with-Absolute-procurator

Affirmed and autographed before me this day 5, March 2021 A.D.
Type of Identification: Arizona Driver License.

notary public

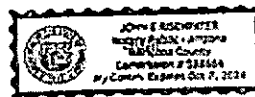

'deprivation-penalty' amounts, and for (b) to assure and ensure the restoration for property-claimed and possessed, in-specie, in-accordance with the covenant-agreements.

To: Military: Sovereign-authority with procurator by covenant: USPO CMN 7009 14 (D 0000 7858 5741 2 / 2

:Executor-Procurator, -:mitigation of the Trustee-derelict- damages ~

2311



:Darrell-James: Hill, :Ohioan- beneficiary-Executor-Procurator, -:mitigation of the Trustee-derelict- damages: Twitter: September 24th, 2020, 7:05 p.m. - :March 9, 2021, 3:35 p.m.

From UPS Store 83759
 5301 S Superstition Mountain Dr Ste
 8358 Casa Grande, AZ 85119-1917
 480-474-9638

ITEM NAME	QTY	PRICE	TOTAL
History			\$10.00
Tax		\$3.00	\$3.00
U.S. Mail Envelopes			\$1.19
Tax		\$3.11	\$3.11
Subtotal			\$17.30
Shipping/Other Charges		\$2.80	\$2.80
Total Tax			\$6.21
Total			\$23.51
Cash		\$23.50	
Change Back (Cash)			(\$0.01)

States Designated as not eligible for Returns, Refunds or Exchanges.
 All Postal Rates are Subject to Surcharge.

121030537505001785

View the UPS Store, Inc.'s privacy notice at <https://www.upsstore.com/privacy-policy>

APACHE JURY/1104
 151 W SUPERSTITION BLVD
 APACHE JURY/1104, AZ 85120-9778
 (602)275-8177

03/05/2021 11:49 AM

Product	Qty	Unit Price	Price
First-Class Mail® Letter	1		\$0.55
Washington, DC 20018			
Weight: 0 to 0.60 oz			
Estimated Delivery Date			Tue 03/09/2021
Certified Mail®			\$3.60
Tracking #:			700914000078665041
e-Receipt Receipt			\$1.75
Total			\$5.90
Grand Total:			\$23.50
Cash		\$23.50	
Change			-\$0.01

Use total \$ for inquiry on Return Receipt (Electronic)

In a hurry? Self-service kiosks offer quick and easy check-out. Any Postal Associate can show you how.

Text your tracking number to 23777 (USPS) from the United States Standard Mailbox

U.S. Postal Service
CERTIFIED MAIL® RECEIPT
 (Domestic Mail Only; No Insurance Coverage Provided)

For delivery information visit our website at www.usps.com

OFFICIAL USE

Postage	\$0.55	
Certified Fee	\$3.05	
Return Receipt Fee (Printed and Mailed)	\$0.00	
Assessed Delivery Fee (Electronic Return)	\$1.75	
Total Postage & Fees	\$5.35	
Postmark		03/05/2021

John Ford, Lykes
 Office 15105 999010121
 Washington District Columbia 20018

8:42 PM · Mar 8, 2021 · Twitter Web App

March 9, 2021 2:11 a.m. Darrell James Hill
 @DarBenThu1

:Executor-Procurator, -:mitigation of the Trustee-derelict- damages ~

161 / 206



:Darrell-James: Hill, :Ohioan- beneficiary-Executor-Procurator, -:mitigation of the trustee-derelict- damages: Twitter: September 24th, 2020, 7:05 p.m. - :March 9, 2021, 3:35 p.m.

See: Notice of execution of Your 'Unalienable-right'

- [@AZSheriffs](#)
- [@cc_sheriff](#)
- [@NationalSheriff](#)
- [@mcsoaz](#)
- [@az_cops](#)
- [@PimaSheriff](#)
- [@PinalCSO](#)
- [@CoconinoSheriff](#)
- [@YumaSheriff](#)
- [@ohio_sheriffs](#)
- [@SCCSheriff](#)
- [@sherifflamb1](#)
- [@kjzzphoenix](#)
- [@CBS5AZ](#)
- [@azcentral](#)
- [@TopCop Cochise](#)

Quote Tweet



Darrell James Hill
@DarBenThu1

Mar052021AD. :i- man-jurisdiction of :sovereign-authority with general-procuration (/kinsman) as the PFTUSA overstanding: POTUS-trustee, & absolute-procuration over :stolen-property (/sole) :in-accordance w/ Covenant-agreements. :PFTUSA abandoned-01/20 and vacated 03/03/2021 A.D.

7314

Tweet Analytics

Darrell James hill @DarBenThu1
 See: Notice of execution of Your 'Unalienable-right'
 @AZSheriffs
 @cc_sheriff
 @NationalSheriff
 @mcs0az
 @az_cops
 @PimaSheriff
 @PinalCSO
 @CoconinoSheriff
 @YumaSheriff
 @ohio_sheriffs
 @SCCSheriff
 @sheriffamb1
 @kjzzphoenix
 @CBS5AZ
 @azcentral
 @TopCop_Cochise <https://twitter.com/DarBenThu1/status/1367915700866584576> ...

Impressions
 times people saw this Tweet on Twitter

145

Tweet

2:11 AM - Mar 9, 2022

View Tweet activity

Messages

Privacy Policy Cookies Policy © 2021 Twitter, Inc.



:Darrell-James: Hill, :Ohioan- beneficiary-Executor-Procurator, -:mitigation of the Trustee-derelict- damages: Twitter: September 24th, 2020, 7:05 p.m. - :March 9, 2021, 3:35 p.m.

Darrell-James: Hill, Sovereign-authority with-Procurator,
PO Box 3936, Apache Junction, Arizona 85117

:man, -present

Arizona state
Pinal county

Jurat:

Trustees:
:Mark-Alexander :General United States Army- Chairman: CJCOS- Milroy,
:John-Earl :General United States Air Force: Vice- CJCOS- Hyton,
:James-Charles :General United States Army- COS Army-
:David-Hiberry :General United States Marine Corps, CMC :Bergar,
:Michael-Martin :Admiral United States Navy: CNO- Skidny,
:David-Lee :General United States Air Force: COS AF- Goldstein,
:John-William :General United States Space Force: CSO- Raymond,
:Joseph-Lauren :General United States Air Force: CNG- Lengyel
:Karl-Lee :Admiral United States Coast Guard- CCG- Schultz
c/o :John-Earl :Hyton, USPO 7000 1410 0000 7600 5741
Office: CJCOS
2293 Joint Staff Pentagon
Washington, District of Columbia 20318-0929

:Sovereign -United States of America- people-Authority AND :Sovereign-Authority
Acceptance :in-Procurator by :Covenant-Agreements: for: a) :Receipt of the
Authority for the citizen-office: President for the United States of America -1787- A.D.,
-non-incorporated, -Authority on the Abandonment and Vacation of the office of the
President by the man- Donald-John: Trump, -:Trustee, -in- Dishonor; and b)
:Sovereign-Authority Acceptance :in-Procurator by :Covenant-Agreements: Lots
One, Two, Three, Four, Five, Six, and Seven, (-failure to restore republic-constitution
for cause-)

Greetings, Mark-Alexander, John-Earl, all,

: man hope you are well.

man- jurisdiction: Sovereign-authority with-procurator by :Covenant-Agreements
:- man-beneficiary, -Negro-, -civilian-, -principal- :Ohioan over-standing the Declaration
of Independence, "DOI-1776-A.D.", et seq., -with -denature of the "United States"- Corp -EBA-1803-
2003-A.D. -Dry-legalistic-Trust; and :Kinsman redemptor for Negro-Israel, Israel and the Holy-Couch
of :Abraham, "Jesus", the Messiah; and, therefore: Ambassador of the Most-High-God in -Trustee:
Concession-1213-A.D.:

- 1) Sovereign-authority under God Almighty, wherein nothing stands between the God Almighty
and :- man-Ohioan, et al.;
- 2) DOI-1776-A.D.: Omission, is verified- one of the people of the United States of America;
- 3) AOC-1777-A.D.: Articles of Confederation binding :Ohio -state;
- 4) The Constitution for the United States of America, 1787 -1789, et al.- Bill of Rights, et seq.;
- 5) Express-potential-election, "PE", -covenant-agreement with right to remedy by and with
:absolute-procurator.

Trustee: Covenant-Agreement with Beneficiary: Remedy with and by :Absolute-Procurator
5) Covenant-Contracts: PE, Lots 1-5, with Lot 6 being the -executed-right-of-demand for the
account, settle and closure of the EBA-1803-A.D. -Dry-legalistic-Trust-covenant-agreement, and
with the Trustee: office :POTUS- :Obama, Trump and Biden, and POTUSA- :Trump, -agreements in
the express -absolute -procurator by :- man- Darrell-James: Hill, -beneficiary, far to obtain the right
of the remedy in the deprivation of property- matters: Lots 1-6' .

1 Covenant-Agreement -procurator is merely for to assure and ensure the (a) :payment of the
To: Military: Sovereign-authority with procurator by covenant: USPO CMN 7000 1410 0000 7600 5741
1/2

:Executor-Procurator, -:mitigation of the Trustee-derelict- damages ~



:Darrell-James: Hill, :Ohioan- beneficiary-Executor-Procurator, -:mitigation of the Trustee-derelict- damages: Twitter: September 24th, 2020, 7:05 p.m. - :March 9, 2021, 3:35 p.m.

uphold and defend The Constitution for the United States of America- 1787- 1789, et al. -Bill of Rights, et seq. -Emancipation Proclamation-1863-A.D., 'EP-1863-A.D.' and General Order 100- 1863-A.D. :all- overstanding, notwithstanding else of the office of the President for the United States- Corp here-to-for and now-to-after.

:You- all have been made to be aware of all of :these actions since 2016 A.D.;
You know or should have known :this non-abandonment of :claim-matter since 2017 A.D.
as now :All of :these-matters are :public-record !

Covenant-Agreement with procurator for the abandonment of the PFTUSA, -non-incorporated abandoned January 20, 2021 A.D., and vacated March 03, 2021 A.D. by the man-Donald John Trump, et al
 :- man here-to-fore and now-to-after by the sovereign-duty receive-now upon :- man as kinsman-redeemer for Negro-Ysrael, Ysrael and the Holy-Church, et seq., the :authority and duty of office of the PFTUSA-Authority -heretofore-ABANDONED, and now-to-after stand-over the 'United-States- Corp', et al. :POTUS, et seq.

Covenant-Agreement with absolute-procurator as the Trustee, in-honor, for the restoration of the Private-property -claimed-and-possessed-and-stolen in :Trustee-fraud corroborated by: Barack-Huasein-Obama, et al. -VP- Biden, CLT -Loretta Lynch, et seq. -USAG/CLT, Donald John Trump, et al. -VP-Pence, CLT, Jeffrey Sessions, et seq. -now-to-after wild matter is completely remedied in-accordance with the covenant-agreement-absolute-authority in procurator
 :- man here-to-fore execute Sovereign-authority with absolute-procurator attaining to the stolen possessions- Lots #1 - 7 :in-accordance with the covenant-agreements exclusively to attain the right to remedy to the aggrieved-beneficiary, :- man- darrell-james: hill, for the :exceeding-of-government-jurisdiction by deprivation/theft of private-property without right or authorization from :- man -owner. The office of the President of The United States- Corp., POTUS-Trustee understands 1) the :DOI-1776-A.D., AOC-1777-A.D., and The Constitution for the United States of America, 1787-1789, et al. -Bill of Rights, et seq. -Emancipation Proclamation-1863-A.D., General Order 100- 1863-A.D.; 2) the Trustee: EBA-1933-A.D. Dry-Legislative-Trust -indenture with debenture to :- man -darrell-james: hill, beneficiary; and, 3) :Trustee-Derelection :-in- Dishonor :within-fraud daily-harming the :beneficiary- aggrieved, -Darrell-James: Hill, -sole, and as :kinsman-redeemer for :Negro-Ysrael, Ysrael and the Holy-Church.

:- man affirm the above is true and correct and will press :same onto the record in the open court

Without prejudice,

 Darrell James: Hill, Sovereign authority with Procurator,
 Executor with Absolute procurator

Affirmed and autographed before me this day 5, March 2021 A.D.
 Type of Identification: Arizona Driver License,

 notary public



deprivation-penalty amounts, and for (b) to assure and ensure the restoration for property-claimed and possessed, in-specie, in-accordance with the covenant-agreements.

To: Military: Sovereign-authority with procurator by covenant: USPO CMN 7009 1410 0000 7888 5741
 2/2

23/6

:Executor-Procurator, -:mitigation of the Trustee-derelict- damages ~



:Darrell-James: Hill, :Ohioan- beneficiary-Executor-Procurator, -:mitigation of the Trustee-derelict- damages: Twitter: September 24th, 2020, 7:05 p.m. - :March 9, 2021, 3:35 p.m.

From UPS Store #2752
5361 S Superstition Avenue Tr 116
Eloy, AZ 85119-1913
AZC-874-8838

Item Name	Qty	Price	Total
Stationery	10	\$10.00	\$10.00
Ink			\$1.00
Ballpoint			\$1.10
Ink	10	\$1.10	\$11.00
Subtotal			\$11.10
Shipping/Other Charges			\$2.83
Total tax			\$2.41
Total			\$16.34
Cash			\$16.34
Credit back (cash)			(\$16.34)

Items designated IR are not eligible for Returns, Refunds or Exchanges.

US Postal Rates are Subject to Surcharges.

Visit the UPS Store, Inc.'s website online at <https://www.upsstore.com/return-policy>

APACHE JUNCTION
151 W SUPERSTITION BLVD
APACHE JUNCTION, AZ 85120-9998
(602)275-5177

03/05/2021 11:10 AM

Product	Qty	Unit Price	Price
First-Class Mail® Letter	1		\$0.55
Washington, DC 20518			
Weight: 0 lb 0.60 oz			
Estimated Delivery Date: Tue 03/09/2021			
Certified Mail®			\$3.50
Tracking #			7099124000070520761
e-Return Receipt			\$1.75
Total			\$5.80
Grand Total:			\$5.80
Cash			\$100.00
Change			-\$94.20

UPS is experiencing unprecedented volume increases and limited employee availability due to the impacts of COVID-19. We appreciate your patience.

Use label # for inquiry or Return Receipt (electronic)

In a hurry? Self-service kiosks offer quick and easy check-out. Any Postal Associate can show you how.

Text your tracking number to 23777 (USPS) for a text-based, fast-track status. Standard Message.

Visit the UPS Store, Inc.'s website online at <https://www.upsstore.com/return-policy>

121030537506001785

U.S. Postal Service
CERTIFIED MAIL™ RECEIPT
(Domestic Mail Only; No Insurance Coverage Provided)

For delivery information visit our website at www.usps.com

OFFICIAL USE

Postage	\$0.00	0120
Delivery Fee	\$1.75	16
Return Receipt Fee (Government Required)	\$0.00	
Additional Delivery Fee (Endorsement Required)	\$0.00	
Total Postage & Fees	\$1.75	

Postmark Date: 03/05/2021

7009 1430 0000 7866 5741

John Earl Lykes
Office 1000 9999
Washington District Columbia 20318

2:11 AM · Mar 9, 2021 · Twitter Web App

:Executor-Procurator, -:mitigation of the Trustee-derelict- damages ~

2317



:Darrell-James: Hill, :Ohioan- beneficiary-Executor-Procurator, -:mitigation of the Trustee-derelict- damages: Twitter: September 24th, 2020, 7:05 p.m. - :March 9, 2021, 3:35 p.m.

March 9, 2021
2:23 a.m.



Darrell James hill

[@DarBenThu1](#)

Bill of Rights 1789 A.D.; 9th Amendment: The enumeration in the Constitution, of certain rights, shall not be construed to deny or disparage others retained by the people. -- p.1771 of <https://1215.org/lawnotes/usconstitution/u-s-constitution-analysis-interpretation-2014-06-01.pdf>

. See: fn 4

2:23 AM · Mar 9, 2021 · Twitter Web App

March 9, 2021
2:31 a.m.

Darrell James hill

[@DarBenThu1](#)

Bill of Rights 1789 A.D.; 10th Amendment: The powers not delegated to the United States by the Constitution, nor prohibited by it to the States, are reserved to the States respectively, or to the people. -- p.1777 of <https://1215.org/lawnotes/usconstitution/u-s-constitution-analysis-interpretation-2014-06-01.pdf>

. See: para. 1

2:31 AM · Mar 9, 2021 · Twitter Web App

March 9, 2021
2:34 a.m.

Darrell James hill

[@DarBenThu1](#)

See: Notice of execution of Your 'Unalienable-right'

[@EatGreenNY](#)

[@nofaNY](#)

[@SeedAlliance](#)

[#organic](#)

[@YoungFarmers](#)

[@FarmSchoolNYC](#)

[@YoungFarmers](#)

[@MorningAgClips](#)

[@GreenCityForce](#)

[@NYCFoodPolicy](#)

[@nycagcollective](#)

[#urbanagriculture](#) [#nycfarm](#)

Quote Tweet

2318
:Executor-Procurator, -:mitigation of the Trustee-derelict- damages ~

166 / 206

2319

Tweet

Bill of Rights
9th Amendme
of certain righ
disparage oth
p.1771 of
1215.org/law

2:23 AM • Mar 9, 20

View Tweet activity

Tweet Analytics

Darrell James hill @DarBenThu1
Bill of Rights 1789 A.D.;
9th Amendment: The enumeration in the Constitution, of certain rights, shall not be construed to deny or disparage others retained by the people. -- p.1771 of https://www.1215.org/lawnotes/usconstitution/u-s-constitution-analysis-interpretation-2014-06-01.pdf See: fn 4

Impressions	141
times people saw this Tweet on Twitter	
Total engagements	3
times people interacted with this Tweet	

View all engagements

messages

James hill
enThu1

Ysrael, -civilian, -Ohioan,
iciary; DOI-1776-A.D.,
33-A.D; Amb. of Ysruah to
n-redeemer/Ysrael & trustee
sion-1213-A.D.

pening

ago

teairing on ABC

an, #TheVoice

ture today!

min Bloom

2320

Tweet

Darrell James Hill @DarBenThu1

Bill of Rights 1789 A.D.; 10th Amendment: The powers not delegated to the United States by the Constitution, nor prohibited by it to the States, are reserved to the States respectively, or to the people. -- p.1777 of https://1215.org/lawnotes/usconstitution/u-s-constitution-analysis-interpretation-2014-06-01.pdf ... See: para. 1

2:31 AM Mar 9, 2022

View tweets from Darrell James Hill

Tweet your thoughts

Messages

Tweet Analytics

Darrell James Hill @DarBenThu1
 Bill of Rights 1789 A.D.;
 10th Amendment: The powers not delegated to the United States by the Constitution, nor prohibited by it to the States, are reserved to the States respectively, or to the people. --
 p.1777 of
<https://1215.org/lawnotes/usconstitution/u-s-constitution-analysis-interpretation-2014-06-01.pdf> ... See: para. 1

Impressions times people saw this Tweet on Twitter	139
Total engagements times people interacted with this Tweet	2

[View all engagements](#)

People

James Hill
 Darrell James Hill
 Ysrael, -civilian, -Ohioan,
 Secretary: DOI-1776-A.D.,
 33-A.D.; Amb. of Yushuah to
 n-redeemer/ Ysrael & Trustee:
 sion-1213-A.D.

Opening

ago
 featuring on ABC
 e. par-

ture today!
 mmBloom



:Darrell-James: Hill, :Ohioan- beneficiary-Executor-Procutor, -:mitigation of the Trustee-derelict- damages: Twitter: September 24th, 2020, 7:05 p.m. - :March 9, 2021, 3:35 p.m.



Darrell James Hill
@DarBenThu1

Mar052021AD. :i- man-jurisdiction of :sovereign-authority with general-procuration (/kinsman) as the PFTUSA overstanding: POTUS-trustee, & absolute-procuration over :stolen-property (/sole) :in-accordance w/ Covenant-agreements. :PFTUSA abandoned-01/20 and vacated 03/03/2021 A.D.

2321



:Darrell-James: Hill, :Ohioan- beneficiary-Executor-Procurator, -:mitigation of the Trustee-derelict- damages: Twitter: September 24th, 2020, 7:05 p.m. - :March 9, 2021, 3:35 p.m.

Darrell-James: NIA, Sovereign-authority with-Procurator,
PO Box 3806, Apache Junction, Arizona 85117

:(man, -present

Arizona state
Pinal county

Just

Trustees:
:(Mark-Alexander :General United States Army-:Chairman: CJCSG- :Mifay,
:(John-Earl :General United States Air Force: Vice- CJCSG- :Hyten,
:(James-Charles :General United States Army, COO Army-
:(David-Hiberry :General United States Marine Corps: CMC- :Berger,
:(Michael-Martin :Admiral United States Navy: CNO- :Giday,
:(David-Lee :General United States Air Force: CCG AF- :Goldfin,
:(John-William :General United States Space Force: CSC- :Raymond,
:(Joseph-Lauren :General United States Air Force: CNG- :Langyel
:(Karl-Lee :Admiral United States Coast Guard: CCC- :Schutz
c/o :John-Earl-Hyten, USPO 7000 1410 0000 7000 5741
Office: CJCSG
5009 Joint Staff Pentagon
Washington, District of Columbia 20318-9099

:Sovereign -United States of America- people-Authority AND :Sovereign-Authority
Acceptance :In-Procurator by :Covenant-Agreements: for: a) :Receipt of the
Authority for the citizen-office: President for the United States of America -1787- A.D.-
non-incorporated, -Authority on the Abandonment and Vacation of the office of the
President by the man- Donald-John-:Trump, -:Trustee, -in-Dishonor; and b)
:Sovereign-Authority Acceptance :In-Procurator by :Covenant-Agreements: Lots
One, Two, Three, Four, Five, Six, and Seven (-failure to restore republic-constitution
for cause-)

Greetings, :Mark-Alexander, John-Earl, all;

:(man hope you are well,

:(man- Jurisdiction, Sovereign-authority, with-procurator, by :Covenant-Agreements
:(man-beneficiary, -Negro-, -civilian, -principal, :Ohioan over-standing the Declaration
of Independence, (DC-1776-A.D., et seq. -with-debarment of the "United-States"- Corp -EBA-1803-
2000 A.D. -Dry-legalistic-Trust; am) Kinsman-redaemer for Negro-Yisrael, Yisrael and the Holy-Church
of :Yehoshua, 'Jesus', the Messiah; and, therefore: Ambassador of the Most-High-God in -Trustee:
Cession: 1213-A.D.:

- 1) Sovereign-authority under God Almighty, wherein nothing stands between the God Almighty
and :man-Obeon, et al.;
- 2) DC-1776-A.D.: Obeon, is verified- one of the people of the United States of America;
- 3) ACC-1777-A.D.: Articles of Confederation binding :Ohio -state;
- 4) The Constitution for the United States of America, 1787 -1789, et al- Bill of Rights, et seq;

and, 5) Express positive-election, 'PE', -covenant-agreement with right to remedy by and with
absolute-procurator,

Trustee-Covenant-Agreement with -Beneficiary-Remedy, with and by -Absolute-Procurator

- 5) Covenant-Contracts: PE, Lots 1-5, with Lot 0 being the executed-right-of-demand for the
spouse, estate and closest of the EBA-1803-A.D. -Dry-legalistic-Trust-covenant-agreement and,
with the Trustee-office :POTUS - :Obama, Trump and Biden, and POTUSA - :Trump, -agreements in
the express -absolute -procurator by :man- Darrell-James: Hill, -beneficiary, for to obtain the right
of the remedy in the deprivation of property- matters, Lots 1-6'.

1 Covenant-Agreement -procurator is merely for to assure and ensure the 6a) :payment of the
To: Military: Sovereign-authority with procurator by covenant: USPO CIVN 7000 1410 0000 7000 5741
1/2

2322
2322

:Executor-Procurator, -:mitigation of the Trustee-derelict- damages ~

2022-011769
2533

Darrell James hill on Twitter: See: Notice of execution of Your 'Unalienable-right' @EatGreenNY @nofaNY @Seed_Alliance #organic @YoungFarmers @FarmSchoolNYC @YoungFarmers @MorningAgClips @GreenCityForce @NYCFoodPolicy @nycagcol...

File Edit View History Bookmarks Tools Help

M: All Mail - dhill X: New Tab X: Onkyo receiver X: Apache Junction X: WunderMap X: M: Inbox (107) X: Total Praise X: Darrell James Hill X: b-1020-intro X: a-2020-09-20 X: New Tab X

https://twitter.com/DarBenThu1/status/1369220008446885889/analytics 150%

Getting Started EXECUTIVE ORDERS REF COMMERCE DAVID STRAIGHTERS AJ

Tweet Analytics

Darrell James Hill @DarBenThu1
 See: Notice of execution of Your 'Unalienable-right'
 @EatGreenNY
 @nofaNY
 @Seed_Alliance
 #organic
 @YoungFarmers
 @FarmSchoolNYC
 @YoungFarmers
 @MorningAgClips
 @GreenCityForce
 @NYCFoodPolicy
 @nycagcollective
 #urbanagriculture
 #nycfarm <https://twitter.com/DarBenThu1/status/1367915700866584576> ...

Impressions 345
 times people saw this Tweet on Twitter

Total engagements 9
 times people interacted with this Tweet

urgars defeat the H... Page

morning
made after
vs the NRA's
hool shootings

4 hours ago
ay And Aaron
New Statements
Controversial
mments

Privacy Policy [Cookie Policy](#)
© 2021 Twitter, Inc.

Messages

Tuesday November 9, 21:35

2022-011769 MISC Page: 2533 of 2782

09/26/2022 03:35:37 PM Receipt #: 22-9381
 Rec Fee: \$30.00 Darrell James Hill
 Gila County, Az, Sadie Jo Bingham, Recorder





:Darrell-James: Hill, :Ohioan- beneficiary-Executor-Procurator, -:mitigation of the Trustee-derelict- damages: Twitter: September 24th, 2020, 7:05 p.m. - :March 9, 2021, 3:35 p.m.

uphold and defend The Constitution for the United States of America- 1787- 1789, et al. -Bill of Rights, et seq. -Emancipation Proclamation-1863-A.D., 'EP-1863-A.D.' and General Order 100- 1863-A.D. as overstanding, notwithstanding else of the office of the President for the United States-Corp here-to-for and now-to-after.

:You- all have been made to be aware of all of :these actions since 2016 A.D.;
You know or should have known :this non-abandonment of :claim-matter since 2017 A.D.
as now :All of :these-matters are :public-record !

Covenant-Agreement with-procuration for the abandonment of the PFTUSA, -non-incorporated abandoned January 20, 2021 A.D., and vacated March 03, 2021 A.D. by the man Donald John Trump, et al.

:i- man here-to-fore and now-to-after by the sovereign-duty receive now upon :i- man as kinsman-redeemer for Negro-Ysrael, Ysrael and the Holy-Church, et seq. (the :authority and duty of office of the PFTUSA-Authority -heretofore-ABANDONED, and now-to-after stand-over the 'United States- Corp', et al. - :POTUS, et seq.

Covenant-Agreement with absolute-procuration as the Trustee, in-honor, for the restoration of the Private-property- :claimed-and-possessed and stolen in Trustee-fraud corroborated by Barack Hussein Obama, et al. -V.P. Biden, CLT. -Loretta Lynch, et seq. -USA/G/CLT, Donald John Trump, et al. -V.P. Pence, CLT. - Jeffrey Sessions, et seq. now to after until matter is completely remedied in accordance with the covenant-agreement-absolute-authority-in-procuration

:i- man here-to-fore execute Sovereign-authority with absolute-procuration attaining to the stolen possessions- Lots ## 1 - 7 :in-accordance with the covenant-agreements exclusively to attain the right to remedy to the aggrieved-beneficiary, :i- man- darrell-james: hill, for the -exceeding-of-government-jurisdiction by deprivation/theft of private-property without right or authorization from :i- man -owner, The office of the President of The United States- Corp., POTUS, -Trustee understands 1) the :DOI-1778-A.D., AOC-1777-A.D., and The Constitution for the United States of America, 1787-1789, et al. -Bill of Rights, et seq. -Emancipation Proclamation-1863-A.D., General Order 100- 1863-A.D.; 2) the Trustee: EBA-1933-A.D. Dry-Legislative-Trust -Indenture with debenture to :i- man -darrell-james: hill- beneficiary; and, 3) :Trustee-Devection -in- Dishonor :within-fraud daily-harming the :beneficiary- aggrieved, -:Darrell-James: Hill, -sole, and as :kinsman-redeemer for :Negro-Ysrael, Ysrael and the Holy-Church.

:i- man affirm the above is true and correct and will press :same onto the record in the open court

Without prejudice.

Darrell James Hill
Darrell James Hill, Sovereign Authority with Procuration,
Executor with Absolute Procuration

Affirmed and autographed before me this day 5, March 2021 A.D.
Type of Identification: Arizona Driver License.

Notary public



'deprivation-penalty' amounts, and for (b) to assure and ensure the restoration for property-claimed and possessed, in-specie, :in-accordance with the covenant-agreements,

To: Military: Sovereign-authority with procuration by covenant: USPO CMN 7009 1410 0000 7888 5741
2 / 2

2323
2324

:Executor-Procurator, -:mitigation of the Trustee-derelict- damages ~

09/26/2022 03:35:37 PM Receipt #: 22-9381

Rec Fee: \$30.00 Darrell James Hill

Gila County, Az, Sadie Jo Bingham, Recorder



:Darrell-James: Hill, :Ohioan- beneficiary-Executor-Procurator, -:mitigation of the Trustee-derelict- damages: Twitter: September 24th, 2020, 7:05 p.m. - :March 9, 2021, 3:35 p.m.

The UPS Store 03759
5361 S Superstition Mountain Dr Ste
Gila County, AZ 85118-1917
480-474-9418

Journal: P523528 Date: 3/09/2021
Employee: 119527 Time: 13:17:01

ITEM NAME	QTY	PRICE	TAX
Return	1.0	\$10.00	\$0.00
1x			\$0.00
6.5x11 Envelopes	11.0	\$2.11	\$0.00
1x			\$0.00
Subtotal		\$12.11	
Shipping/Other Charges		\$2.00	
Total Tax		\$0.00	
Total		\$14.11	
Cash		\$20.00	
Change Back (Cash)		\$05.89	

Items Postmarked are not eligible for Returns, Refunds or Exchanges.

US Postal Rates are Subject to Surcharges.

1 2 1 0 3 0 5 3 7 5 0 8 0 0 7 7 8 5

Visit the UPS Store, Inc.'s website online at <https://www.upsstore.com/retailer-postfix>

UNITED STATES POSTAL SERVICE
APACHE JUNCTION
151 W SUPERSTITION BLVD
APACHE JUNCTION, AZ 85120-9208
(602)275-8177

03/05/2021 11:19 AM

Product	Qty	Unit Price	Price
First-Class Mail® Letter	1		\$0.50
Washington, DC 20018			
Weight: 0.16 0.60 oz			
Estimated Delivery Date Tue 03/09/2021			
Certified Mail®			\$3.60
Tracking #:			
70491412000076565741			
e-Return Receipt®			\$1.75
Total			\$5.65
Grand Total:			\$5.00
Cash		\$100.00	
Change			-\$94.10

USPS is experiencing unprecedented volume increases and limited employee availability due to the impacts of COVID-19. We appreciate your patience.

Use label & for inquiry or Return Receipt (Electronic)

In a hurry? Self-service kiosks offer quick and easy check-out. Any Retail Associate can show you how.

Text your tracking number to 23777 (2USPS) to see the latest status. Standard Message

U.S. Postal Service
CERTIFIED MAIL - RECEIPT
(Domestic Mail Only/NO Insurance Coverage Provided)

For delivery information visit our website at www.usps.com.

OFFICIAL USE

Package	1	\$3.00	01/20
Content Fee		11.75	16
Domestic Forward Fee (Domestic Mail Only)		10.00	
Restricted Delivery Fee (Domestic Mail Only)		10.00	
Total Postage & Fees		\$34.75	

7009 3420 0000 7866 5793

John Earl Hiken
Washington, DC 20018

2:34 AM · Mar 9, 2021 · Twitter Web App

Handwritten notes and signatures: 2324, 2325, and a signature.

:Executor-Procurator, -:mitigation of the Trustee-derelict- damages ~



:Darrell-James: Hill, :Ohioan- beneficiary-Executor-Procurator, -:mitigation of the Trustee-derelict- damages: Twitter: September 24th, 2020, 7:05 p.m. - :March 9, 2021, 3:35 p.m.

March 9, 2021
2:36 a.m.



Darrell James hill
[@DarBenThu1](#)
[#itsinqueens](#) [#farmedsince1697](#)
[@ayanaeliza](#)
[@NFUDC](#)

Quote Tweet



Darrell James hill
[@DarBenThu1](#)

See: Notice of execution of Your 'Unalienable-right' [@EatGreenNY](#) [@nofaNY](#) [@Seed_Alliance](#) [#organic](#) [@YoungFarmers](#) [@FarmSchoolNYC](#) [@YoungFarmers](#) [@MorningAgClips](#) [@GreenCityForce](#) [@NYCFoodPolicy](#) [@nycagcollective](#) [#urbanagriculture](#) [#nycfarm](#) [twitter.com/DarBenThu1/sta...](#)
2:36 AM · Mar 9, 2021 · Twitter Web App

March 9, 2021
7:35 a.m.



Darrell James hill
[@DarBenThu1](#)
See: Notice of execution of Your 'Unalienable-right'
[@NDFarmersUnion](#)
[@FarmVetCo](#)
[@HegerFarms](#)
[@dakotaharvest](#)
[@NDUnited](#)
[@RMFUnion](#)
[@HiFarmersUnion](#)
[@NDAREC](#)
[@RURALRADIO147](#)
[@grainman34](#)
[@ProtectHarvest](#)
[@fargocorn](#)

2326
2375
UN

:Executor-Procurator, -:mitigation of the Trustee-derelict- damages ~



:Darrell-James: Hill, :Ohioan- beneficiary-Executor-Procurator, -:mitigation of the Trustee-derelict- damages: Twitter: September 24th, 2020, 7:05 p.m. - :March 9, 2021, 3:35 p.m.

[@JoelKFGO](#)
[@FarmsSwine](#)
[@FarmsNews](#)

Quote Tweet



Darrell James Hill
[@DarBenThu1](#)

Mar052021AD. :i- man-jurisdiction of :sovereign-authority with general-procuration (/kinsman) as the PFTUSA overstanding: POTUS-trustee, & absolute-procuration over :stolen-property (/sole) :in-accordance w/ Covenant-agreements. :PFTUSA abandoned-01/20 and vacated 03/03/2021 A.D.

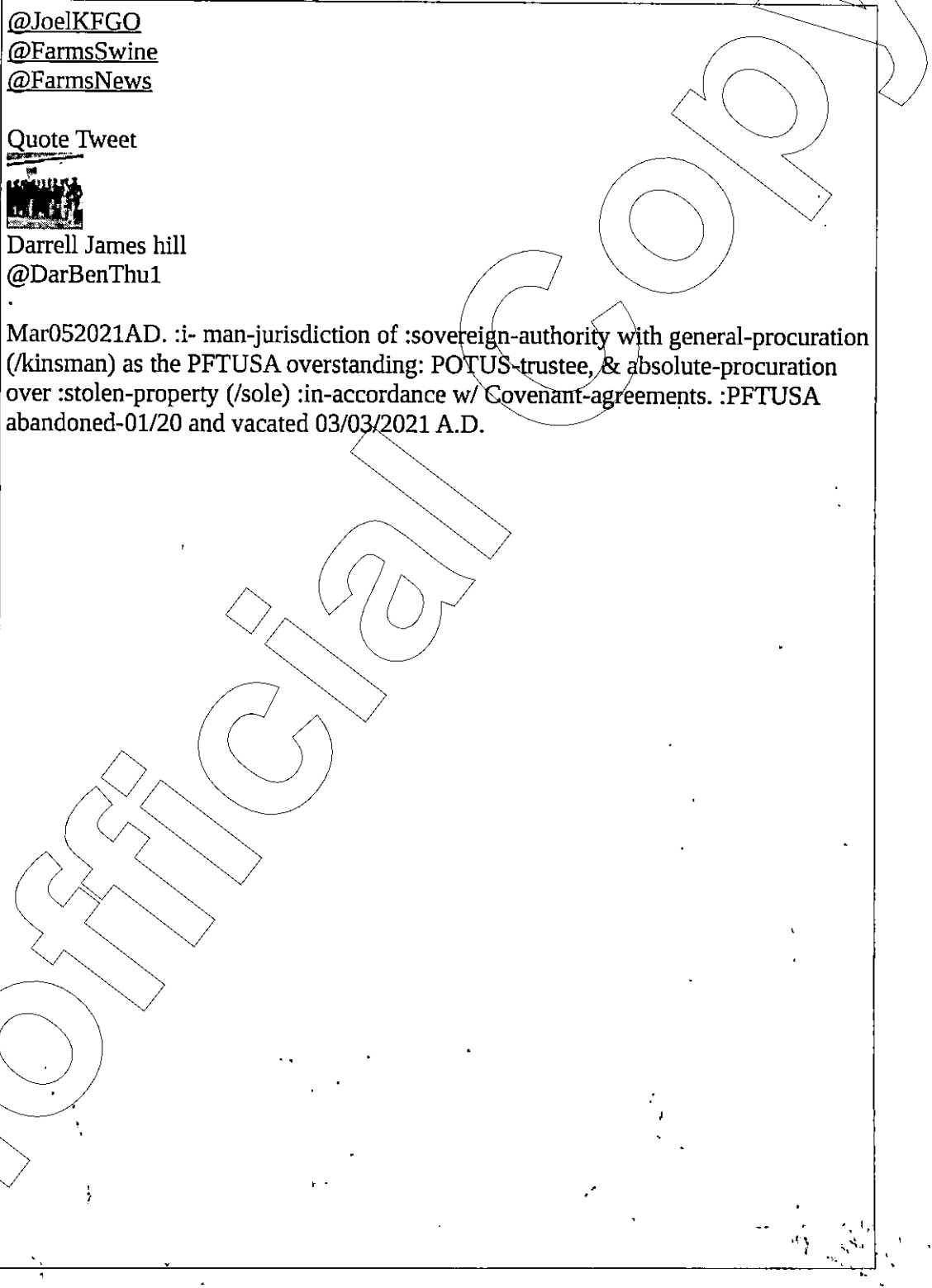

2327
2326

2327

Tweet Analytics

Darrell James hill @DarBenThu1
 #itsinqueens
 #farmsince1697
 @ayanaeliza
 @NFUDC <https://twitter.com/DarBenThu1/status/1369220008446885889> ...

Impressions times people saw this Tweet on Twitter	150
Total engagements times people interacted with this Tweet	2

[View all engagements](#)

Promote your Tweet

Tweet

#urbanagriculture
#nycfarm twitter

2:36 AM · Mar 9, 2021

View Tweet activity

Tweet your photos

Messages

since 1902 to protect and
the quality of life of
an family farmers and ranchers
r communities.

opening

ago
teating on ABC

ture today!
min Bloom

Earlier today
iana's revenge
relevant, 27 years



:Darrell-James: Hill, :Ohioan- beneficiary-Executor-Procurator, -:mitigation of the Trustee-derelict- damages: Twitter: September 24th, 2020, 7:05 p.m. - :March 9, 2021, 3:35 p.m.

Darrell-James: Hill, Sovereign-authority with-Procurator,
PO Box 3336, Apache Junction, Arizona 85117

:man, -prosed

Arizona state
Pinal county

Jurat

Trustees:
:Mark-Alexander :General United States Army-Chairman: CJCSG :Milay,
:John-Earl :General United States Air Force: Vice- CJCSG :Hyten,
:James-Charles :General United States Army, COS Army
:David-Hiberry :General United States Marine Corps: CMC :Bergon,
:Michael-Martin :Admiral United States Navy: CNO :Gibday,
:David-Lee :General United States Air Force: COS AF :Goldfin,
:John-Wilton :General United States Space Force: CSO :Raymond,
:Joseph-Lauren :General United States Air Force: CNG :Langyel
:Karl-Lee :Admiral United States Coast Guard: CCG :Schultz
c/o :John-Earl :Hyten, USPO 7000 1410 0000 7000 5741
Office: CJCSG
5509 Joint Staff Pentagon
Washington, District of Columbia 20318,9999

:Sovereign -United States of America-people-Authority AND :Sovereign-Authority
Acceptance in-Procurator by :Covenant-Agreements; for: a) Receipt of the
Authority for the citizen-office: President for the United States of America -1787- A.D.,
non-incorporated, -Authority on the Abandonment and Vacation of the office of the
President by the man- Donald-John: Trump, -:Trustee, -:in- Dishonor; and b)
:Sovereign-Authority Acceptance in-Procurator by :Covenant-Agreements: Lots
One, Two, Three, Four, Five, Six, and Seven (-failure to restore republic-constitution
for cause-)

Greetings, Mark-Alexander, John-Earl, all,

- man hope yoursas well,

man- jurisdiction: Sovereign-authority with-procurator by :Covenant-Agreements
:- man-beneficiary, -Negro, -civilian, -principal, :Ohioan over-standing the Declaration of
Independence, (DOI-1776-A.D.), et seq. -with -debarment of the United States- Corp -EBA-1933-
2000 A.D. -Dry-legislative-Trust; am :kins-man-sedeamnt for Negro-Yarbel, Yarbel and the Holy-Church
of Yezhush, 'Jozus', the Messiah; and, therefrom: Ambassador of the Most-High-God in -Trustee:
Concession-1213-A.D.:

- 1) Sovereign-authority under God Almighty, wherein nothing stands between the God Almighty
and :- man Ohioan, et al;
- 2) DOI-1776-A.D.: Ohioan, is: verified-end of the people of the United States of America;
- 3) ACC-1777-A.D.: Articles of Confederation binding: Ohio -State;
- 4) The Constitution for the United States of America, 1787 -1789, et al- Bill of Rights, et seq.;

and, 6) Express political-election, 'PE', -covenant-agreement with right to remedy by and with
:absolute-procurator.

Trustee- Covenant-Agreement with -Beneficiary-Remedy with and by -Absolute-Procurator
5) Covenant-Contracts: PE, Lots 1-5, with Lot 5 being the -coupled -right -of -demand for the
accrue, settle and close of the EBA-1933-A.D. -Dry-legislative-Trust -covenant-agreement and,
with the Trustee; office: POTUS - :Obama, Trump and Eden, and POTUSA - :Trump, -agreements in
the express -absolute -procurator by :- man- Darrell-James: Hill, -beneficiary, for to obtain the -right
of the remedy in the deprivation of property- matters: Lots 1-6¹.

1. Covenant-Agreement -procurator is merely for to assure and ensure the (a) (payment of the
To: Military: Sovereign-authority with procurator by covenant: USPO (MVA) 7000 1410 0000 7000 5741
1 / 2

:Executor-Procurator, -:mitigation of the Trustee-derelict- damages ~



:Darrell-James: Hill, :Ohioan- beneficiary-Executor-Procurator, -:mitigation of the Trustee-derelict- damages: Twitter: September 24th, 2020, 7:05 p.m. - :March 9, 2021, 3:35 p.m.

uphold and defend The Constitution for the United States of America- 1787- 1789, et al. :Bill of Rights, et seq. -Emancipation Proclamation-1863-A.D., 'EP-1863-A.D.' and General Order 100- 1863-A.D. ,a) overstanding, notwithstanding else of the office of the President for the United States- Corp here-to-for and now-to-after.

:You- all have been made to be aware of all of :these actions since 2016 A.D.; You know or should have known :this non-abandonment of :claim-matter since 2017 A.D. as now :All of :these-matters are :public-record 1

Covenant-Agreement with-procuration for the abandonment of the PFTUSA, -non-incorporated, abandoned January 20, 2021 A.D., and vacated March 03, 2021 A.D. by the man-Donald John Trump, et al.

:I- man here-to-fore and now-to-afte by the sovereign-duty receive now upon :I- man as kinsman-redeemer for Negro-Ysrael, Ysrael and the Holy-Church, et seq., the :authority and duty of office of the PFTUSA-Authority -heretofore-ABANDONED, and now-to-afte stand over the 'United-States- Corp'. et al. :POTUS, et seq.

Covenant-Agreement with absolute-procuration as the Trustee, :in-honor, for the restoration of the Private-property :claimed and possessed and stolen in :Trustee-fraud corroborated by: Barack-Hussein Obama, et al. :VP- Biden, CLT :Loretta Lynch, et seq. -USAG/CLT Donald John Trump, et al. VP-Pence, CLT :Jeffrey Sessions, et seq. now to afte until matter is completely remedied, in accordance with the covenant-agreement-absolute authority in procuration

:I- man here-to-fore execute Sovereign-authority with absolute-procuration attaining to the stolen possessions- Lots # 1 - 7 :in-accordance with the covenant-agreements exclusively to attain the right to remedy to the aggrieved-beneficiary, :I- man- darrell-james: hill, for the :exceeding-of-government-judiction by deprivation/theft of private-property without right or authorization from :I- man -owner. The office of the President of The United States- Corp., POTUS, Trustee understands 1) the :DOI-1778-A.D., AOC-1777-A.D., and The Constitution for the United States of America, 1787- 1789, et al. -Bill of Rights, et seq. -Emancipation Proclamation-1863-A.D., General Order 100- 1863-A.D.; 2) the Trustee: EBA-1933-A.D. Dry-Legislative-Trust -Indenture with debenture to :I- man -darrell-james: hill- beneficiary; and, 3) Trustee-Deneciation -in- Dishonor :within-fraud daily-harming the :beneficiary- aggrieved, -Darrell-James: Hill, -sole, and as :kinsman-redeemer for :Negro-Ysrael, Ysrael and the Holy-Church.

:I- man affirm the above is true and correct and will press :same onto the record in the open court

Without prejudice,

Darrell James Hill
Darrell-James: Hill, Sovereign-Authority with-Procuration,
Executor with- Absolute-procuration

Affirmed and autographed before me this day 5, March 2021 A.D.
Type of Identification: Arizona Driver License.

notary public



'deprivation-penalty' amounts, and for (b) to assure and ensure the restoration for property-claimed and possessed, in-specie, in-accordance with the covenant-agreements,

To: Military: Sovereign-authority with procuration by covenant: USPO CMN 7009 1410 D000 7868 5741
2 / 2

:Executor-Procurator, -:mitigation of the Trustee-derelict- damages ~

OFFICE

2329
2330

09/26/2022 03:35:37 PM Receipt #: 22-9381
Rec Fee: \$30.00 Darrell James Hill
Gila County, Az, Sadie Jo Bingham, Recorder



:Darrell-James: Hill, :Ohioan- beneficiary-Executor-Procurotor, -:mitigation of the Trustee-derelict- damages: Twitter: September 24th, 2020, 7:05 p.m. - :March 9, 2021, 3:35 p.m.

The UPS Store 83750
5301 S Superstition Mountain Dr Ste
639 Phoenix, AZ 85018-1913
480-474-9424

Barcode: PH03750 Date: 03/05/2021
Customer: 119527 Item: 13117 84

ITEM NAME	Qty	PRICE	TOTAL
Return	1 0	\$0.00	\$0.00
1.511 Envelopes	15 1	\$0.11	\$1.13
1x			\$3.99
Subtotal			\$5.12
Insurance/Postage Charge			\$5.99
Total Tax			\$0.00
Total			\$11.11
Cash			\$20.00
Change back (Cash)			\$8.89

Items Designated MC are not eligible for Returns, Refunds or Exchanges.

US Postal Rates are Subject to Surcharges.

Barcode: 121030537508001785

Use The UPS Store, Inc.'s address online at <https://www.theupsstore.com/contact-us>

APACHE JUNCTION
151 W SUPERSTITION BLVD
APACHE JUNCTION, AZ 85120-5558
(602)275-9177

03/05/2021 11:10 AM

Product	Qty	Unit Price	Price
First-Class Mail®	1		\$0.58
Letter			
Washington, DC 20018			
Weight: 0 lb 0.63 oz			
Estimated Delivery Date: Tue 03/09/2021			
Certified Mail®			\$3.50
Tracking # 950514000076265741			
e-Postal Receipt			\$1.00
Total			\$5.08
Grand Total:			\$5.08
Cash			\$100.00
Change			\$94.92

USPS is experiencing unprecedented volume increases and limited employee availability due to the impacts of COVID-19. We appreciate your patience.

Use local # for inquiry on Return Receipt (electronic)

In a hurry? Self-service kiosks offer quick and easy check-out. Any Retail Associate can show you how.

Text your tracking number to 23777 (USPS) to get the latest status. Standard Message

U.S. Postal Service
CERTIFIED MAIL - RECEIPT
(Domestic Mail Only; No Insurance Coverage Provided)

For delivery information visit our website at www.usps.com
Visit us today at usps.com

OFFICIAL USE

Postage	\$0.58	UL39	16
Certified Fee	\$3.00		
Return Receipt Fee (Document Required)	\$1.75		
Authorized Delivery Fee (Environment Restricted)	\$0.00		
Total Postage & Fees	\$5.33		

03/05/2021

John E. Hill
151 W SUPERSTITION BLVD
APACHE JUNCTION, AZ 85120-5558
Washington, DC 20018

7:35 AM · Mar 9, 2021 · Twitter Web App

2330
2331

:Executor-Procurotor, -:mitigation of the Trustee-derelict- damages ~

175 / 206



:Darrell-James: Hill, :Ohioan- beneficiary-Executor-Procurator, -:mitigation of the Trustee-derelict- damages: Twitters: September 24th, 2020, 7:05 p.m. - :March 9, 2021, 3:35 p.m.

March 9, 2021
7:35 a.m.



Darrell James hill
[@DarBenThu1](#)
See: Notice of execution of Your 'Unalienable-right' [#BetterPork](#)
[@PigCHAMP](#)
[@AgCareers](#)
[@DaveBlasey](#)
[@NDAGExpStation](#)
[@AgEngineer1](#)
[@WeetsKerby](#)
[@realag_us](#)
[@shaunhaney](#)
[@AKFarmersUnion](#)
[@PopielNathan](#)
[@Stonyfield](#)
[@BobsRedMill](#)
[@AdamSpelhaug](#)
[@CowSignals](#)
[@Amy_Robak_Bruce](#)

Quote Tweet



Darrell James hill
[@DarBenThu1](#)

Mar052021AD. :i- man-jurisdiction of :sovereign-authority with general-procuration (/kinsman) as the PFTUSA overstanding: POTUS-trustee, & absolute-procuration over :stolen-property (/sole) :in-accordance w/ Covenant-agreements. :PFTUSA abandoned-01/20 and vacated 03/03/2021 A.D.

2337
:Executor-Procurator, -:mitigation of the Trustee-derelict- damages ~

176 / 206

Tweet Analytics

Darrell James Hill @DarBenThu1
 See: Notice of execution of Your 'Unalienable-right'
 #BetterPork
 @PigCHAMP
 @AgCareers
 @DaveBlasey
 @NDAgExpStation
 @AgEngineer1
 @WeetsKerby
 @realag_us
 @shaunhaney
 @AKFarmersUnion
 @PopielNathan
 @Stonyfield
 @BobsRedMill
 @AdamSpelhaug
 @CowSignals
 @Amy_Robak_Bruce <https://twitter.com/DarBenThu1/status/1367915700866584576> ...

Impressions 240
 times people saw this Tweet on Twitter

7:35 AM · Mar 9, 2022

View Tweet activity

Privacy Policy · Cookies Policy
 © 2021 Twitter, Inc

Tuesday November 9, 21:34

93534

← Tweet

Tweet Analytics

Darrell James Hill @DarBenThu1
See: Notice of execution of Your 'Unalienable-right'
@dakotapride
@AgClips
@plant_perfect
@dfamilk
@KnutsonFarms
@ksgrains
@CommonGroundNow
@NationalPork
@RohrsBros
@Oprah <https://twitter.com/DarBenThu1/status/1367915700866584576> ...

Impressions	156
times people saw this Tweet on Twitter	
Total engagements	3
times people interacted with this Tweet	

[View all engagements](#)

7:35 AM - Mar 9, 2022

View Tweet activity

Messages

Tuesday November 9, 21:34

2339

Darrell James Hill on Twitter: See: Notice of execution of Your 'Unalienable-right' @NDFarmersUnion @FarmVetCo @HegerFarms @dakotaharvest @NDUnited @RMFUnion @HiFarmersUnion @NDAREC @RURALRADIO147 @grainman34 @ProtectHarvest

File Edit View History Bookmarks Tools Help

All Mail - djhill X New Tab Onkyo receiver X Apache Junction X WunderMap X Inbox (107) - d X Total Praise: X Darrell James Hill X b-1020-intro-t X a-2020-09-20 X New Tab X

https://twitter.com/DarBenThu1/status/1369295746923593728/analytics 150%

Getting Started EXECUTIVE ORDERS REF COMMERCE DAVID STRAIGHTERS AJ

Tweet

Tweet Analytics

Darrell James Hill @DarBenThu1
 See: Notice of execution of Your 'Unalienable-right'
 @NDFarmersUnion
 @FarmVetCo
 @HegerFarms
 @dakotaharvest
 @NDUnited
 @RMFUnion
 @HiFarmersUnion
 @NDAREC
 @RURALRADIO147
 @grainman34
 @ProtectHarvest
 @fargocorn
 @JoelKFGO
 @FarmsSwine
 @FarmsNews <https://twitter.com/DarBenThu1/status/1367915700866584576>

7:35 AM · Mar 9, 2021

View Tweet activity

Impressions 145
 times people saw this Tweet on Twitter

Total engagements 1
 times people interacted with this Tweet

14 messages

Privacy Policy Cookie Policy © 2021 Twitter, Inc.

Tuesday November 9, 21:35



:Darrell-James: Hill, :Ohioan- beneficiary-Executor-Procurator, -:mitigation of the Trustee-derelict- damages: Twitter: September 24th, 2020, 7:05 p.m. - :March 9, 2021, 3:35 p.m.

Darrell-James Hill, Sovereign-authority with-Procurator,
PO Box 3826, Apache Junction, Arizona 85117

:man, -present

Arizona state
Pinal county

Jurat

Trustees:
:Mark-Alexander :General United States Army :Chairman CJCOS :Milley,
:John-Earl :General United States Air Force :Vice- CJCOS :Hytien,
:James-Charles :General United States Army :COS Army-
:David-Hiberry :General United States Marine Corps :CJIC :Bergas,
:Michael-Martin :Admiral United States Navy :CNO :Geddy,
:David-Lee :General United States Air Force :COS AF :Goldstein,
:John-William :General United States Space Force :CSO :Raymond,
:Joseph-Lauren :General United States Air Force :CJG :Langyel
:Karl-Lee :Admiral United States Coast Guard :CCG :Schultz
c/o :John-Earl :Hytien, USPO 7009 1410 0000 7863 5741
Office: CJCOS
2029 Joint Staff Pentagon
Washington, District of Columbia 20318-9259

:Sovereign :United States of America- people-Authority AND :Sovereign-Authority
Acceptance :In-Procurator by :Covenant-Agreements; for: a) :Receipt of the
Authority for the citizen-office; President for the United States of America -1787- A.D.,
-non-incorporated, -Authority on the Abandonment and Vacation of the office of the
President by the man- Donald-John; Trump, -:Trustee, -in- Dishonor; and b)
:Sovereign-Authority Acceptance :In-Procurator by :Covenant-Agreements: Lots
One, Two, Three, Four, Five, Six, and Seven -(failure to restore republic-constitution
for cause-)

Greetings, Mark-Alexander, John-Earl, all,

:! man Pope you are well.

man- jurisdiction: Sovereign-authority with-procurator by :Covenant-Agreements
:! man-beneficiary, -Negro-, -civilian, -principal, :Ohioan over-standing the Declaration
of Independence, '004-1776-A.D., et seq. -with -denature of the 'United States'- Corp -EBA-1033-
2003-A.D. -Dry-legislative-Trust; am :Kin-man-redeemer for Negro-Yisrael, Ysrael and the Holy Church
of :Mushah, 'Jesus', the Messiah; and, therefore: Ambassador of the Most-High-God in -Trustee:
Concession-1213-A.D.:

- 1) Sovereign-authority under God Almighty, where'n nothing stands between the God Almighty
and :! man :Ohioan, et al.;
- 2) 004-1776-A.D.: Chican, is verified- one of the people of the United States of America;
- 3) ACC-1777-A.D.: Articles of Confederation binding :Ohio -state;
- 4) The Constitution for the United States of America, 1787 -1788, et al- Bill of Rights, et seq.;
- and, 5) Express political-election, 'PE', -covenant-agreement with right to remedy by and with
:absolute-procurator.

Trustee: Covenant-Agreement with :Beneficiary-Benefit with and by :Absolute-Procurator
5) :Governor-Contracts: PE, Lots 1-5, with Lot 6 being the -executed -right -of -demand for the
account, write and close of the EBA-1033-A.D. -Dry-legislative-Trust -covenant-agreement and,
with the Trustee: office :POTUS - :Obama, Trump and Biden, and POTUSA- :Trump, -agreements in
the express -absolute -procurator by :! man- Darrell-James; Hill, -beneficiary, for to obtain the right
of the remedy in the deprivation of property- matters, Lots 1-6'.

1 :Covenant-Agreement -procurator is merely for to assure and ensure the (a) :payment of the
To Military: Sovereign-authority with procurator by covenant: USPO GINN 7009 1410 0000 7863 5741
1 / 2

2336
Unofficial

:Executor-Procurator, -:mitigation of the Trustee-derelict- damages ~



:Darrell-James: Hill, :Ohioan- beneficiary-Executor-Procurator, -:mitigation of the Trustee-derelict- damages: Twitter: September 24th, 2020, 7:05 p.m. - :March 9, 2021, 3:35 p.m.

uphold and defend The Constitution for the United States of America- 1787- 1789. et al. -Bill of Rights, et seq. -Emancipation Proclamation-1863-A.D., 'EP-1863-A.D.' and General Order 100- 1863-A.D. -a- overstanding, notwithstanding else of the office of the President for the United States- Corp here-to-for and now-to-after.

:You- all have been made to be aware of all of :these actions since 2016 A.D.;
You know or should have known :this non-abandonment of :claim-matter since 2017 A.D. as now :All of :these-matters are :public-record !

Covenant-Agreement with procurator for the abandonment of the PFTUSA, non-incorporated, abandoned January 20, 2021 A.D. and vacated March 03, 2021 A.D. by the man- Donald John Trump, et al.
:i- man here-to-fore and now-to-after by the sovereign-duty receive now upon :i- man as kinsman-redeemer for Negro-Ysrael, Ysrael and the Holy-Church, of seq. the :authority and duty of office of the PFTUSA-Authority -heretofore-ABANDONED, and now-to-also stand-over the 'United-States- Corp', et al - :POTUS, et seq.

Covenant-Agreement with absolute-procurator as the Trustee, in-honor, for the restoration of the Private-property -claimed-and-possessed and stolen in :Trustee-fraud corroborated by: Barack-Hussein-Obama et al. -VP- Biden, CLT -Lorella Lynch, et seq - USAG/CLT, Donald John Trump, et al -VP- Pence, CLT - Jeffrey Sessions, et seq now to after until matter is completely remedied, in accordance with the covenant-agreement-absolute-authority-in-procurator
:i- man here-to-fore execute Sovereign-authority with absolute-procurator attaining to the stolen possessions- Lots # 1 - 7 :in accordance with the covenant-agreements exclusively to attain the right to remedy to the aggrieved-beneficiary, :i- man- darrell-james- hill, for the :exceeding-of-government-jurisdiction by deprivation/theft of private-property without right or authorization from :i- man -owner, The office of the President of The United States- Corp. POTUS -Trustee understands 1) the :DOI-1778-A.D., AOC-1777-A.D., and The Constitution for the United States of America, 1787-1789, et al. -Bill of Rights, et seq. -Emancipation Proclamation-1863-A.D., General Order 100- 1863-A.D.; 2) the Trustee: EBA-1933-A.D. Dry-Legislative-Trust -Indenture with debenture to :i- man -darrell-james: hill- beneficiary; and, 3) :Trustee-Dereliction -in- Dishonor :within-fraud daily-harming the :beneficiary- aggrieved, -Darrell-James: Hill, -sole, and as :kinsman-redeemer for :Negro-Ysrael, Ysrael and the Holy-Church.

i- man affirm the above is true and correct and will press :same onto the record in the open court

Without prejudice,
Darrell James Hill
Darrell-James: Hill, Sovereign-Authority with Procurator,
Executor with Absolute-procurator

Affirmed and autographed before me this day 5, March 2021 A.D.
Type of Identification: Arizona Driver License.

[Signature]
notary public

deprivation-penalty amounts, and for (b) to assure and ensure the restoration for property-claimed and possessed, in-specie, in accordance with the covenant-agreements.

To: Military: Sovereign-authority with procurator by covenant: USPO CMN 7009 1410 0000 7868 5741
2 / 2

2337

:Executor-Procurator, -:mitigation of the Trustee-derelict- damages ~

09/26/2022 03:35:37 PM Receipt #: 22-9381

Rec Fee: \$30.00 Darrell James Hill

Gila County, Az, Sadie Jo Bingham, Recorder



:Darrell-James: Hill, :Ohioan- beneficiary-Executor-Procurator, -:mitigation of the Trustee-derelict- damages: Twitter: September 24th, 2020, 7:05 p.m. - :March 9, 2021, 3:35 p.m.

The UPS Store #3752
5301 S Superstition Mountain Dr Ste
Gila County, AZ 85119-1917
(520) 824-9824

Invoice #: P237529 Date: 3/9/2021
Invoice #: 418527 Time: 10:17 AM

Item	Qty	Price	Total
Letter	19	\$13.00	\$247.00
1st Class Envelopes	18	\$2.11	\$37.98
Subtotal			\$284.98
Insurance/Other Charges			\$2.00
Total Due			\$286.98
Cash			\$286.98
Change Back			\$0.00

Items designated IR are NOT eligible for Returns, Refunds or Exchanges.

US Postal Rates are Subject to Surcharge.

121030537508007785

View the UPS Store, Inc.'s privacy notice at <https://www.upsstore.com/privacy-policy>

APACHE JURISDICTION
151 W SUPERSTITION MOUNTAIN DR
APACHE JURISDICTION, AZ 85120-9098
(602) 275-8177

03/05/2021 11:19 AM

Product	Qty	Unit Price	Total
First-Class Mail® Letter	19	\$0.95	\$18.05
Washington, DC 20019 Weight: 6 lb 0.60 oz Estimated Delivery Date Tue 03/09/2021			
Certified Mail®	1	\$3.60	\$3.60
Tracking #: 702914000078685741			
Return Receipt	1	\$1.75	\$1.75
Total			\$25.20
Grand Total:			\$5.90
Cash			\$100.00
Change			-\$94.10

USPS is experiencing unprecedented volume increases and limited employee availability due to the impacts of COVID-19. We appreciate your patience.

Use label # for inquiry on Return Receipt (Electronic)

In a hurry? Self-service kiosks offer quick and easy check-out. Any Retail Associate can show you how.

Text your tracking number to 28777 (2USPS) for quick and easy tracking. Text to 28777

U.S. Postal Service™
CERTIFIED MAIL® RECEIPT
(Domestic Mail Only; No Insurance Coverage Provided)

For delivery information visit our website at www.usps.com

121030537508007785

OFFICIAL USE	
Postage	\$5.90
Certified Fee	\$1.75
Return Receipt Fee	\$1.75
Guaranteed Delivery	\$0.00
Registered Mail	\$0.00
Signature Confirmation	\$0.00
Special Delivery	\$0.00
Postage & Fees	\$5.90

03/05/2021

John Earl Lykes
Office of the Recorder
Washington, D.C. - Columbia 20318

7:35 AM · Mar 9, 2021 · Twitter Web App

:Executor-Procurator, -:mitigation of the Trustee-derelict- damages ~

179 / 206

2338



:Darrell-James: Hill, :Ohioan- beneficiary-Executor-Procurator, -:mitigation of the Trustee-derelict- damages: Twitter: September 24th, 2020, 7:05 p.m. - :March 9, 2021, 3:35 p.m.

**March 9, 2021
7:35 a.m.**

Darrell-James Hill, Sovereign-authority with-Procurator,
PO Box 3326 Apache Junction, Arizona 85117

man, -present

Arizona state
Final-courtesy

Jurat

Trustees

Mark-Alexander-General United States Army- Chairman CJCSG- Major,
John-Earl-General United States Air Force, Vice-CJCSG- Major,
James-Charles-General United States Army- COS Army,
David-H-Barry-General United States Marine Corps- CMC- Major,
Michael-Martin-Admiral United States Navy- CNO- Major,
Dorinda-Lee-General United States Air Force- CCG AF- Colonel,
John-William-General United States Space Force- CCG AF- Raymond,
Joseph-Ladina-General United States Air Force- CMC- Major,
Karl-Lee-Admiral United States Coast Guard- CCG- Schutz
c/o John-Earl-Hyten, USPO 7000 1410 0000 7000 5741
Office, C-000
1000 Joint Staff Pentagon
Washington, District of Columbia 20315-9229

:Sovereign -United States of America- people-Authority AND :Sovereign-Authority
Acceptance in-Procurator by :Covenant-Agreements; for: a) Receipt of the
Authority for the citizen-office; President for the United States of America -1787- A.D.,
-non-incorporated, -Authority on the Abandonment and Vacation of the office of the
President by the man- Donald-John- Trump, -Trustee, -in- Dishonor; and b)
:Sovereign-Authority Acceptance in-Procurator by :Covenant-Agreements: Lots
One, Two, Three, Four, Five, Six, and Seven (-failure to restore republic-constitution
for cause-)

Greetings, Mark-Alexander, John-Earl, all,

I trust hope you are well.

man- Arizona- Sovereign-authority with-procurator by :Covenant-Agreements

I trust-beneficiary- Negro, -civilian, -principal, Ohioan over-standing the Declaration of
Independence "DCI-1776-A.D", et seq. -with- departure of the "United States"- Corp- EBA-1903-
2003 A.D -Dry-legal-lit-Trust; am- Kristian-redemptor for Negro-Israel, Israel and the Holy-Church
of Yeshua, Jesus, the Messiah; and, therefore: Ambassador of the Most-High-God in-Trustee
Concession-1213-A.D.

- 1) Sovereign-authority under God Almighty -where no nothing stands between the God Almighty
and a man-Ohioan, et al.
- 2) DCI-1776-A.D - Citizen, et-ventures- one of the people of the United States of America;
- 3) AOC-1777-A.D, Articles of Confederation binding :Ohio-state;
- 4) The Constitution for the United States of America, 1787-1789, et al- Bill of Rights, et seq.
and, 5) Express political-union, "PE", -covenant-agreement with right to remedy by and with
absolute-procurator.

Trustee- Covenant-Agreement with :Sovereign-authority with and by Absolute-Procurator
in-Covenant-Contracts PE, Lots 1-6, with Lot 6 being the -express- right-of-demand for the
accrual -title and closure of the EBA-1903-A.D -Dry-legal-lit-Trust-covenant-agreement- and
with the trustee-office POTUS - Obama, Trump and Boon, and POTUSA- Trump, -agreements in
the express -absolute-procurator by a-man-Darrell-James-Hill, -beneficiary, for to obtain the -right
of the remedy in the deterioration of property- matters- Lots 1-6!

1) Covenant-Agreement -procurator's merely for to ensure and ensure the (a) -payment of the
To Military- Sovereign-authority with procurator by covenant, USPO CAN 7000 1410 0000 7000 5741
1/2

**March 9, 2021 Darrell James Hill
1:10p.m. @DarBenThu1**

2339 -Executor-Procurator, -:mitigation of the Trustee-derelict- damages ~

180 / 206

Handwritten numbers: 2339, 2338



:Darrell-James: Hill, :Ohioan- beneficiary-Executor-Procurator, -:mitigation of the Trustee-derelict- damages: Twitter: September 24th, 2020, 7:05 p.m. - :March 9, 2021, 3:35 p.m.

Darrell-James: Hill, Sovereign-authority with-Procurator,
PO Box 3306, Apache Junction, Arizona 85117

man, -proced

Arizona state
Pinal county

Jurat

Trustees:
:Mark-Alexander :General United States Army-;Chairman: CJCS-;Milley,
:John-Earl :General United States Air Force; Vice- CJCS-; Hyten,
:James-Charles :General United States Army; COS Army-
:David-Hilberry :General United States Marine Corps; CMC-; Berger,
:Michael-Martin :Admiral United States Navy; CNO-; Gaddy,
:David-Lee :General United States Air Force; CCG AF-; Goldstein,
:John-William :General United States Space Force; CCG-; Raymond,
:Joseph-Lauten :General United States Air Force; CNG-; Longyal
:Karl-Lee :Admiral United States Coast Guard; CCG-; Schultz
c/o :John-Earl-Hyten, USPO 7009 1410 0000 7000 5741
Office: CJCS
3999 Joint Staff Pentagon
Washington, District of Columbia 20318-9999

:Sovereign -United States of America- people-Authority AND :Sovereign-Authority
Acceptance :in-Procurator by :Covenant-Agreements; for: a) :Receipt of the
Authority for the citizen-office: President for the United States of America -1787- A.D.,
non-incorporated, -Authority on the Abandonment and Vacation of the office of the
President by the man- Donald-John; Trump, -:Trustee, -in- Dishonor; and b)
:Sovereign-Authority Acceptance :in-Procurator by :Trustee-Agreements; Lots
One, Two, Three, Four, Five, Six, and Seven (-failure to restore republic-constitution
for cause-)

Greetings, :Mark-Alexander, John-Earl, all;

: man hope you are well.

man- Jurisdiction, Sovereign-authority, with-procurator, by :Covenant-Agreements
: man-beneficiary, -Negro-, -civilian-, -principal-, -Ohioan over-standing the Declaration of
Independence, 1776-A.D., et seq. -with- debarment of the "United States" Corp -EBA-1933-
2000 A.D. -Dry-legislative-Trust; am; Kinsman-redactor for Negro-Yisrael, Yisrael And The Holy-Church
of Yisrahel, "Jesus", the Messiah; and, therefrom: Ambassador of the Most-High-God an -Trustee:
Concession-1213-A.D.

1) Sovereign-authority under God Almighty, where'n nothing stands between the God Almighty
and : man Ohioan, et al;
2) DC-1776-A.D.: Ohioan, is verified- end of the people of the United States of America;
3) ACC-1777-A.D.: Articles of Confederation binding :Ohio -state;
4) The Constitution for the United States of America, 1787-1789, et al- Bill of Rights, et seq;
and, 5) Express political-election, "PE", -covenant-agreement with right to remedy by and with
absolute-procurator.

Trustee- Covenant-Agreement with -Beneficiary-Remedy with and by Absolute-Procurator
5) Covenant-Contracts: PE, Lots 1-5, with Lot 6 being the -executed- right of -demand for the
account, settle and close of the EBA-1933-A.D. -Dry-legislative-Trust -covenant-agreement and,
with the Trustee-office :POTUS - Obama, Trump and Biden, and POTUSA - Trump, -agreements in
the express-absolute -procurator by : man- Darrell-James: Hill, -beneficiary, for to obtain the right
of the remedy in the deprivation of property- matters: Lots 1-6.

T Covenant-Agreement -procurator is merely for to assure and ensure the (a) :payment of the
To: Military: Sovereign-authority with procurator by covenant: USPO G/M/ 7009 1410 0000 7000 5741
1/2

2341

:Executor-Procurator, -:mitigation of the Trustee-derelict- damages ~



:Darrell-James: Hill, :Ohioan- beneficiary-Executor-Procurator, -:mitigation of the Trustee-derelict- damages: Twitter: September 24th, 2020, 7:05 p.m. - :March 9, 2021, 3:35 p.m.

See: Notice of execution of Your 'Unalienable-right'

@FirehookBaked

@EarlyMountain

@FarmScribbler

@VADistilleary @WhiteFlintFrm

@ChesFoodshed

@purplerooorg

@NoKidHungryVA

@brightfarms

@VaAgriWomen

@MtCrawfordCream

@vachestnuts

@FHCASA

Whitley's Peanuts

Quote Tweet



Darrell James Hill

@DarBenThu1

Mar052021AD. :i- man-jurisdiction of :sovereign-authority with general-procuration (/kinsman) as the PFTUSA overstanding: POTUS-trustee, & absolute-procuration over :stolen-property (/sole) :in-accordance w/ Covenant-agreements. :PFTUSA abandoned-01/20 and vacated 03/03/2021 A.D.

2340

2342

← Tweet

1:10 PM · Mar 9, 2022

View Tweet activity

Tweet Analytics

Darrell James hill @DarBenThu1

See: Notice of execution of Your 'Unalienable-right' @FirehookBaked @EarlyMountain @FarmScribbler @VADistilleary @WhiteFlintFrm @ChesFoodshed @purplerooorg @NoKidHungryVA @brightfarms @VaAgriWomen @MtCrawfordCream @vachestnuts @FHCASA

Whitley's Peanuts <https://twitter.com/DarBenThu1/status/1367915700866584576> ...

Impressions
times people saw this Tweet on Twitter 120

Total engagements
times people interacted with this Tweet 2

future today!

ana's revenge relevant, 27 years

Yesterday rescued after al from TikTok

Privacy Policy Cookie Policy

© 2021 Twitter, Inc

messages

Twitter

Tuesday November 9, 21:34



:Darrell-James: Hill, :Ohioan- beneficiary-Executor-Procurator, -:mitigation of the Trustee-derelict- damages: Twitter: September 24th, 2020, 7:05 p.m. - :March 9, 2021, 3:35 p.m.

uphold and defend The Constitution for the United States of America- 1787- 1789, et al. -:Bill of Rights, et seq. -:Emancipation Proclamation-1863-A.D., 'EP-1863-A.D.' and General Order 100- 1863-A.D. :ab- overstanding, notwithstanding else of the office of the President for the United States- Corp here-to-for and now-to-after.

:You- all have been made to be aware of all of :these actions since 2016 A.D. ;
You know or should have known :this non-abandonment of :claim-matter since 2017 A.D. as now :All of :those-matters are :public-record !

Covenant-Agreement with-procurator for the abandonment of the PFTUSA - non-incorporated, abandoned January 20, 2021 A.D., and vacated March 03, 2021 A.D. by the man: Donald John Trump, et al.
:i- man here-to-fore and now-to-after by the sovereign-duty receive-now upon :i- man as kinsman-redeemer for Negro-Ysrael, Ysrael and the Holy-Church, et seq. the :authority and duty of office of the PFTUSA, Authority -heretofore-ABANDONED, and now-to-after stand-over the 'United-States- Corp', et al. -: POTUS, et seq.

Covenant-Agreement with absolute-procurator as the Trustee, in-honor, for the restoration of the Private-property -claimed-and-possessed and stolen in :Trustee-fraud corroborated by, Barack-Hussein-Obama, et al. -:VP- Biden, CLT -:Loretta Lynch, et seq. -USAG/CLT, Donald John Trump, et al. -:VP- Pence, CLT -: Jeffrey Sessions, et seq. now-to after until matter is completely remedied in-accordance with the covenant-agreement-absolute-authority in procurator
:i- man here-to-fore execute Sovereign-authority with absolute-procurator attaining to the stolen possessions- Lots # 1 - 7 :in-accordance with the covenant-agreements exclusively to attain the right to remedy to the aggrieved-beneficiary, :i- man- darrell-james: hill, for the :exceeding-of-government-jurisdiction by deprivation/theft of private-property without right or authorization from :i- man -owner, The office of the President of The United States- Corp., POTUS, -Trustee understands 1) the :DOI-1778-A.D., AOC-1777-A.D., and The Constitution for the United States of America, 1787-1789, et al. -Bill of Rights, et seq. -:Emancipation Proclamation-1863-A.D., General Order 100- 1863-A.D.; 2) the Trustee: EBA-1933-A.D. Dry-Legislative-Trust -Indenture with debenture to :i- man -darrell-james: hill- beneficiary, and, 3) Trustee-Dereliction -in- Dishonor within-fraud daily-harming the :beneficiary- aggrieved, -:Darrell-James: Hill, sole, and as :kinsman-redeemer for :Negro-Ysrael, Ysrael and the Holy-Church.

:i- man affirm the above is true and correct and will press :same onto the record in the open court

Without prejudice,
Darrell James Hill
Darrell-James: Hill, Sovereign-Authority with- Procurator,
Executor with- Absolute-procurator

Affirmed and autographed before me this day 5, March 2021 A.D.
Type of Identification: Arizona Driver License,

notary public



'deprivation-penalty' amounts, and for (b) to assure and ensure the restoration for property-claimed and possessed, in-specie, in-accordance with the covenant-agreements.

To: Military: Sovereign-authority with procurator by covenant: USPO CMN 7009 1410 0000 7888 5741
2 / 2

2343
UNOFFICIAL

:Executor-Procurator, -:mitigation of the Trustee-derelict- damages ~

09/26/2022 03:35:37 PM Receipt #: 22-9381

Rec Fee: \$30.00 Darrell James Hill

Gila County, Az, Sadie Jo Bingham, Recorder



:Darrell-James: Hill, :Ohioan- beneficiary-Executor-Procutor, -:mitigation of the Trustee-derelict- damages: Twitter: September 24th, 2020, 7:05 p.m. - :March 9, 2021, 3:35 p.m.

The UPS Store #1750
5501 W Superstition Avenue Dr Ste
Gila County, AZ 85110-9910
480-474-9628

Reference #: 8503250 Date: 03/05/2021
Reference #: 818537 Time: 11:19 AM

ITEM NAME	QTY	PRICE	TAX
Notes			\$10.00
Tax			\$2.00
Self Center			\$1.10
Tax			\$1.00
Subtotal \$15.10			
Shipping/Other Charges \$3.00			
Total Tax \$2.80			
Total \$21.10			
Cash \$20.00			
Change Back (Cash) \$1.10			

Items Designated RM are NOT eligible for Returns, Refunds or Exchanges.

US Retail Rates Are Subject to Surcharges.

121030537508007785

Visit The UPS Store, Inc.'s privacy notice at <https://www.upsstore.com/privacy-notice>

UNITED STATES POSTAL SERVICE
APACHE JUNCTION
151 W SUPERSTITION BLVD
APACHE JUNCTION, AZ 85120-9908
(602)275-3177

03/05/2021 11:19 AM

Product	Qty	Unit Price	Price
First-Class Mail® Letter	1		\$0.55
Weight: 0.10 D, 0.52 oz			
Estimated Delivery Date: Tue 03/08/2021			
Certified Mail®			\$3.50
Tracking #:			
7083141000078685741			
e-Return Receipt			\$1.75
Total			\$5.80
Grand Total:			\$27.00
Cash			\$20.00
Change			\$1.10

USPS is experiencing unprecedented volume increases and limited employee availability due to the impacts of COVID-19. We appreciate your patience.

Use label # for inquiry on Return Receipt (Electronic)

Try a kiosk! Self-service kiosks offer quick and easy check-out. Any Retail Associate can show you how.

Text your tracking number to 28777 (USPS) to get the latest status. Standard Message

U.S. Postal Service
CERTIFIED MAIL™ RECEIPT
(Domestic Mail Only/No Insurance Coverage Provided)

For delivery information visit our website at www.usps.com

OFFICIAL USE

Postage	\$0.00	UI/00	\$0
Certified Fee	\$1.75		
Package Receipt Fee (Automated Processing)	\$0.00		
Restricted Delivery Fee (Automated Processing)	\$0.00		
Total Postage & Fees	\$1.75		

7083141000078685741

John Ford: Hill
Office: 10705, 9445
Washington District Columbia 20518

1:10 PM · Mar 9, 2021 · Twitter Web App

2344

March 9, 2021 Darrell James Hill

:Executor-Procutor, -:mitigation of the Trustee-derelict- damages ~



:Darrell-James: Hill, :Ohioan- beneficiary-Executor-Procurator, -:mitigation of the Trustee-derelict- damages: Twitter: September 24th, 2020, 7:05 p.m. - :March 9, 2021, 3:35 p.m.

1:10 p.m.

[@DarBenThu1](#)

See: Notice of execution of Your 'Unalienable-right'

[@MichaelEspinoza](#)

[@CoffeeWaves](#)

[@IrelandsFarmers](#)

[@creekhousehoney](#)

[#hemp](#) [#agricultureandfarming](#) [#horticulture](#) [#farm](#) [#cbd](#) [#cbdheals](#)

[@ShantellBingham](#)

[@SouthwestDairy](#)

[@ruralheritage](#)

[@Ron on RON](#)

Quote Tweet



Darrell James hill

[@DarBenThu1](#)

Mar052021AD. :i- man-jurisdiction of :sovereign-authority with general-procuration (/kinsman) as the PFTUSA overstanding: POTUS-trustee, & absolute-procuration over :stolen-property (/sole) :in-accordance w/ Covenant-agreements. :PFTUSA abandoned-01/20 and vacated 03/03/2021 A.D.

2345

09/26/2022 03:35:37 PM Receipt #: 22-9381
Rec Fee: \$30.00 Darrell James Hill
Gila County, Az, Sadie Jo Bingham, Recorder



:Darrell-James: Hill, :Ohioan- beneficiary-Executor-Procurator, -:mitigation of the Trustee-derelict- damages: Twitter: September 24th, 2020, 7:05 p.m. - :March 9, 2021, 3:35 p.m.

Darrell-James: Hill, Sovereign-authority with-Procurator,
PO Box 3836, Apache Junction, Arizona 85117

man, -present

Arizona state
Pinal county

Jurat:

Trustees:
:Mark-Alexander :General United States Army--Chairman: CJCS- Milley,
:John-Earl :General United States Air Force: Vice- CJCS- Hylton,
:James-Charles :General United States Army: COO Army-
:David-Hiberry :General United States Marine Corps: CMC- Berger,
:Michael-Martin :Admiral United States Navy: CNO- Gilday,
:John-Lee :General United States Air Force: CAG AF- Goldstein,
:John-William :General United States Space Force: CDS- Raymond,
:Joseph-Laurion :General United States Air Force: CNG- Bengtson,
:Karl-Lee :Admiral United States Coast Guard: CCG- Schultz
c/o :John-Earl :Hylton, USPO 7000 1410 0000 7868 5741
Office: CJCS
3509 Joint Staff Pentagon
Washington, District of Columbia 20318-9999

:Sovereign -:United States of America- people-Authority AND :Sovereign-Authority
Acceptance :in-Procurator by :Covenant-Agreements; for: a) :Receipt of the
Authority for the citizen-office: President for the United States of America -1787- A.D.,
-non-incorporated, -Authority on the Abandonment and Vacation of the office of the
President by the man- Donald-John- Trump, -:Trustee, -:in-Dishonor; and b)
:Sovereign-Authority Acceptance :in-Procurator by :Covenant-Agreements: Lots
One, Two, Three, Four, Five, Six, and Seven (-failure to restore republic-constitution
for cause-)

Greetings, :Mark-Alexander, John-Earl, all,

man hope you are well,

man- Jurisdiction, Sovereign-authority, with-procurator, by :Covenant-Agreements,
man-beneficiary, -Negro-, -civilian-, -principal-, :Ohioan over-standing the Declaration of
Independence, DOI-1776-A.D., et seq, -with-debenture of the "United-States"- Corp -EBA-1833-
2000 A.D. -Dry-legislative-Trust; am/Kinsmen-redeemer for Negre-Yarael, YI(2) and the Holy Church
of :Yahush, :Jesus, the Messiah; and, therefore: Ambassador of the Most-High-God an -Trustee:
Concession-1213-A.D.:

- 1) Sovereign-authority under God Almighty, wherein nothing stands between the God Almighty
and the man-Chican, et al;
- 2) DOI-1776-A.D.: Ourselves, is verified- one of the people of the United States of America;
- 3) AOC-1777-A.D.: Articles of Confederation binding :Ohio- state;
- 4) The Constitution for the United States of America, 1787 -1789, et al- Bill of Rights, et seq;

and, 5) Express political-election, "PE", -covenant-agreement with right to remedy by and with
absolute-procurator,

Trustee- :Covenant-Agreement with -Beneficiary-Remedy with and by -Absolute-Procurator
5) Covenant-Contracts: PE, Lots 1-5, with Lot 6 being the executed-right-of-demand for the
account, settle and close of the EBA-1833-A.D. -Dry-legislative-Trust-covenant-agreement and,
with the Trustee's office :POTUS - :Obama, Trump and Biden, and POTUSA- :Trump, -agreements in
the express-absolute-procurator by :- man- Darrell-James: Hill, -beneficiary, for to obtain the right
of the remedy in the deprivation of property- matters: Lots 1-6

1 Covenant-Agreement -procurator is merely for to assure and ensure the (a) :payment of the
To: Milley: Sovereign-authority with procurator by covenant: USPO GVN 7000 1410 0000 7868 5741
1 / 2

2346

:Executor-Procurator, -:mitigation of the Trustee-derelict- damages ~

Tweet Analytics

Darrell James hill @DarBenThu1
See: Notice of execution of Your 'Unalienable-right'
@MichaelEspinoza
@CoffeeWaves
@IrelandsFarmers
@creekhousehoney
#hemp #agricultureandfarming #horticulture #farm #cbd #cbdheals
@ShantellBingham
@SouthwestDairy
@ruralheritage
@Ron_on_RON [https://twitter.com/DarBenThu1/status/1367915700866584576 ...](https://twitter.com/DarBenThu1/status/1367915700866584576)

Impressions	156
times people saw this Tweet on Twitter	
Total engagements	1
times people interacted with this Tweet	

[View all engagements](#)

Earlier today
tana's revenge
relevant, 27 years

Earlier today
'Eternals' the
of any Marvel
ng to
here's how all 26
graded.

Privacy Policy [Contact Us](#)
© 2021 Twitter, Inc.

Messages





:Darrell-James: Hill, :Ohioan- beneficiary-Executor-Procurator, -:mitigation of the Trustee-derelict- damages: Twitter: September 24th, 2020, 7:05 p.m. - :March 9, 2021, 3:35 p.m.

uphold and defend The Constitution for the United States of America- 1787- 1789, et al. -:Bill of Rights, et seq. -:Emancipation Proclamation-1863-A.D., 'EP-1863-A.D.' and General Order 100- 1863-A.D. ,all- overstanding, notwithstanding elsa of the office of the President for the United States- Corp here-to-for and now-to-after.

:You- all have been made to be aware of all of :these actions since 2016 A.D.:
You know or should have known :this non-abandonment of :claim-matter since 2017 A.D. as now :All of :these-matters are :public-record !

Covenant-Agreement with-procuration for the abandonment of the PFTUSA, -non-incorporated, abandoned January 20, 2021 A.D., and vacated March 03, 2021 A.D. by the man- Donald-John- Trump, et al.

:I- man here-to-fore and now-to-after by the sovereign-duty receive now upon :I- man as :kinsman-redeemer for Negro-Ysrael, Ysrael and the Holy-Church, et seq., the :authority and duty of office of the PFTUSA-Authority -heretofore-ABANDONED, and now-to-after stand-over the 'United-States- Corp, et al. -:POTUS, et seq.

Covenant-Agreement with absolute-procuration as the Trustee, in-honor, for the restoration of the Private-property, -claimed-and-possessed-and-stolen, in :Trustee-fraud corroborated by, Barack-Hussein-Obama, et al. -VP- Biden, C.I.T. -Loretta Lynch, et seq. -USAG/C.I.T. Donald-John- Trump, et al. -VP- Pence, C.I.T. -Jeffrey Sessions, et seq. now to after until matter is completely remedied, in-accordance with the covenant-agreement-absolute-authority in-procuration

:I- man here-to-fore execute Sovereign-authority with absolute-procuration attaining to the stolen possessions- Lots # 1 - 7 :In-accordance with the covenant-agreements exclusively to attain the right to remedy to the aggrieved-beneficiary, :I- man- darrell-james: hill, for the :exceeding-of-government-jurisdiction by deprivation/thoft of private-property without right or authorization from :I- man -owner. The office of the President of The United States- Corp., POTUS, -Trustee understands 1) the :DOI-1776-A.D., AOC-1777-A.D., and The Constitution for the United States of America, 1787-1789, et al. -Bll of Rights, et seq. -:Emancipation Proclamation-1863-A.D., General Order 100- 1863-A.D.: 2) the Trustee: EBA-1933-A.D. Dry-Legislative-Trust -indenture with debenture to :I- man -darrell-james: hill- beneficiary, and, 3) Trustee-Derection -in- Dishonor -within-fraud daily-harming the :beneficiary- aggrieved, -:Darrell-James: Hill, -sole, and as :kinsman-redeemer for :Negro-Ysrael, Ysrael and the Holy-Church.

:I- man affirm the above is true and correct and will press :same onto the record in the open court

Without prejudice.

Darrell James Hill
Darrell-James: Hill, Sovereign-Authority with- Procuration,
Executor with- Absolute-procuration

Affirmed and autographed before me this day 5, March 2021 A.D.
Type of Identification: Arizona Driver License.

notary public



deprivation-penalty amounts, and for (b) to assure and ensure the restoration for property-claimed and possessed, in-specie, in-accordance with the covenant-agreements.

To: Military: Sovereign-authority with procuration by covenant: USPO CMN 7009 1410 0000 7868 5741
2/2

:Executor-Procurator, -:mitigation of the Trustee-derelict- damages ~

187 / 206

2348

09/26/2022 03:35:37 PM Receipt #: 22-9381
Rec Fee: \$30.00 Darrell James Hill
Gila County, Az, Sadie Jo Bingham, Recorder



:Darrell-James: Hill, :Ohioan- beneficiary-Executor-Procurator, -:mitigation of the Trustee-derelict- damages: Twitter: September 24th, 2020, 7:05 p.m. - :March 9, 2021, 3:35 p.m.

The UPS Store 43750
5301 S Superstition Mountain Dr Ste
Gila County, AZ 85120-9278
(602) 725-8777

Date: 03/05/2021
Time: 11:17 AM

ITEM NAME	QTY	PRICE	TAX
Letter	10	\$10.00	\$0.00
Postage			\$0.00
Service Center	1	\$1.10	\$0.00
Tax			\$2.03
Subtotal		\$11.10	
Shipping/Other Charges		\$0.00	
Total Tax		\$2.03	
Total		\$13.13	
Cash		\$13.00	
Change		-\$0.13	

Change back (Cash): (\$0.13)

Stores Participating in our Mail Boxes Etc. program are not eligible for Returns, Refunds or Exchanges.

US Postal Rates Are Subject to Surcharges.

Use Label # for Inquiry on Return Receipt (Electronic)

In a hurry? Self-service kiosks offer quick and easy check-out. Any Retail Associate can show you how.

Text your tracking number to 25777 (2USPS) to get the latest status. Standard Message

Visit the UPS Store, Inc.'s website online at <https://www.upsstore.com/retailer-locator>

7009 3430 0000 7866 5791

UNITED STATES POSTAL SERVICE
APACHE JUNCTION
151 W SUPERSTITION BLVD
APACHE JUNCTION, AZ 85120-9278
(602) 725-8777

03/05/2021 11:18 AM

Product	Qty	Unit Price	Price
First-Class Mail® Letter	1		\$0.55
Postage			\$0.55
Weight: 0 to 0.00 oz			
Estimated Delivery Date			Tue 03/09/2021
Certified Mail®			\$3.50
Tracking #:			7009343000078665791
e-Return Receipt			\$1.75
Total			\$6.30
Grand Total:			\$6.30
Cash			\$6.00
Change			-\$0.30

USPS is experiencing unprecedented online increases and limited employee availability due to the impacts of COVID-19. We appreciate your patience.

Use Label # for Inquiry on Return Receipt (Electronic)

In a hurry? Self-service kiosks offer quick and easy check-out. Any Retail Associate can show you how.

Text your tracking number to 25777 (2USPS) to get the latest status. Standard Message

U.S. Postal Service
CERTIFIED MAIL® RECEIPT
(Domestic Mail Only; No Insurance Coverage Provided)

For delivery information visit our website at www.usps.com

7009 3430 0000 7866 5791

Item	Price
Postage	\$0.00
Certified Fee	\$1.75
Return Receipt Fee (Electronic Receipt)	\$0.00
Restricted Delivery Fee (Address Restricted)	\$0.00
Total Postage & Fees	\$1.75

Postmark Date: 03/05/2021

John Earl: Helen
Office: Carlos, 944501214
Washington, District of Columbia 20518

1:10 PM · Mar 9, 2021 · Twitter Web App

2349
March 9, 2021 Darrell James Hill

:Executor-Procurator, -:mitigation of the Trustee-derelict- damages ~



:Darrell-James: Hill, :Ohioan- beneficiary-Executor-Procurator, -:mitigation of the Trustee-derelict- damages: Twitter: September 24th, 2020, 7:05 p.m. - :March 9, 2021, 3:35 p.m.

1:10 p.m.

[@DarBenThu1](#)

See: Notice of execution of Your 'Unalienable-right'

[@TXHempFarmers](#)

[@BethFordLOL](#)

[@organiccowboy](#)

[#AmericanHempFarmer](#) [#HempBound](#)

[@thehia](#)

[@kimseverson](#)

[#Texas](#) [#Farmers](#)

[@ccdowntownfm](#)

[@growlocalstx](#)

[@tanninscctx](#)

Quote Tweet



Darrell James Hill

[@DarBenThu1](#)

Mar052021AD. :- man-jurisdiction of :sovereign-authority with general-procuration (/kinsman) as the PFTUSA overstanding: POTUS-trustee, & absolute-procuration over :stolen-property (/sole) :in-accordance w/ Covenant-agreements. :PFTUSA abandoned-01/20 and vacated 03/03/2021 A.D.

2350
:Executor-Procurator, -:mitigation of the Trustee-derelict- damages ~

189 / 206



:Darrell-James: Hill, :Ohioan- beneficiary-Executor-Procurator, -:mitigation of the Trustee-derelict- damages: Twitter: September 24th, 2020, 7:05 p.m. - :March 9, 2021, 3:35 p.m.

Darrell-James: Hill, Sovereign-authority with-Procurator,
PO Box 3306, Apache Junction, Arizona 85117

Man, -present

Arizona state
Pinal county

Jurat

Trustees:

:Mark-Alexander :General United States Army:-Chairman: CJCOS :Milley,
:John-Earl :General United States Air Force: Vice- CJCOS :Hyten,
:James-Charles :General United States Army: COG Army:
:David-Henry :General United States Marine Corps: CMC :Barber,
:Michael-Martin :Admiral United States Navy: CNO :Gibby,
:David-Lee :General United States Air Force: COS AF :Goldstein,
:John-William :General United States Space Force: C3O :Raymond,
:Joseph-Lauren :General United States Air Force: CNG :Bengyal
:Karl-Lee :Admiral United States Coast Guard: CCG :Schultz
c/o :John-Earl-Hyten, USPO 7009 1410 0000 7868 6741
Office: CJCOS
9509 Joint Staff Pentagon
Washington, District of Columbia 20310-9599

**:Sovereign -United States of America- people-Authority AND :Sovereign-Authority
Acceptance in-Procurator by :Covenant-Agreements; for: a) :Receipt of the
Authority for the citizen-officer; President for the United States of America -1787- A.D.,
non-incorporated, -Authority on the Abandonment and Vacation of the office of the
President by the man- Donald-John; Trump, -Trustee, -in- Dishonor; and b)
:Sovereign-Authority Acceptance in-Procurator by :Covenant-Agreements: Lots
One, Two, Three, Four, Five, Six, and Seven (-failure to restore republic-constitution
for cause-)**

Greetings, Mark-Alexander, John-Earl, all;

Man hope you are well.

**Man- Jurisdiction, Sovereign-authority with-procurator by :Covenant-Agreements
Man-beneficiary, Negro, -civilian, -principal, -Ohioan over-standing the Declaration of
Independence, 'DO' 1776-A.D., et seq, -with -debarment of the 'United States'- Corp -EBA-1833-
2003-A.D. -Dry-legislative-Trust; and King-man-redemption for Negro-Naraal, Yaraal and the Holy-Church
of :Yakush, 'Jesus', the Messiah; and, therefrom: Ambassador of the Most-High-God in-Trustee:
Concession-1213-A.D.**

- 1) Sovereign-authority under God Almighty, where'n nothing stands between the God Almighty
and Man-Chosen, et al;
- 2) DO-1776-A.D.: Oath, is verified- one of the people of the United States of America;
- 3) AGC-1777-A.D.: Articles of Confederation binding Ohio-state;
- 4) The Constitution for the United States of America, 1787-1789, et al- Bill of Rights, et seq;
- and, 5) Express political-election, 'PE', -covenant-agreement with right to remedy by and with
absolved-procurator.

**Trustee- Covenant-Agreement with -Beneficiary-Remedy with and by: Absolve-Procurator
5) Covenant-Contracts: PE, Lots 1-5, with Lot 6 being the -executed -right-of -demand for the
account, settle and close of the EBA-1833-A.D. -Dry-legislative-Trust-covenant-agreement and,
with the Trustee office :POTUS - :Obama, Trump and Biden, and POTUSA :Trump, -agreements in
the express-absolve-procurator by Man- Darrell-James: Hill, -beneficiary, for to obtain the right
of the remedy in the deprivation of property matters: Lots 1-6!**

1 Covenant-Agreement -procurator is merely lot to assure and ensure the (a) :payment of the
To: Military: Sovereign-authority with procurator by covenant: USPO GVN 7009 1410 0000 7868 6741
172

2851

:Executor-Procurator, -:mitigation of the Trustee-derelict- damages ~

2357

Darrell James hill on Twitter: "See: Notice of execution of Your 'Unalienable-right' @TXHempFarmers @BethFordLOL @organiccowboy #AmericanHempFarmer #HempBound @thehia @kimseverson #Texas #Farmers @ccdowntownfm @growlocalstx ..."

File Edit View History Bookmarks Tools Help

Twitter.com/DarBenThu1/status/1369380065667129348/analytics

Getting Started EXECUTIVE ORDERS REF COMMERCE DAVID STRAIGHTERS AJ

Tweet Analytics

Darrell James hill @DarBenThu1
 See: Notice of execution of Your 'Unalienable-right'
 @TXHempFarmers
 @BethFordLOL
 @organiccowboy
 #AmericanHempFarmer
 #HempBound
 @thehia
 @kimseverson
 #Texas
 #Farmers
 @ccdowntownfm
 @growlocalstx
 @tanninscctx <https://twitter.com/DarBenThu1/status/1367915700866584576> ...

Impressions 260
 times people saw this Tweet on Twitter

Total engagements 1
 times people interacted with this Tweet

Earlier today
 tana's revenge
 relevant, 27 years

11 hours ago
 ay And Aaron
 New Statements
 Controversial
 mments

Privacy Policy Cookies
 © 2021 Twitter, Inc

Messages

Tuesday November 9, 21:33

2022-011769 MISC Page: 2562 of 2782

09/26/2022 03:35:37 PM Receipt #: 22-9381
 Rec Fee: \$30.00 Darrell James Hill
 Gila County, Az, Sadie Jo Bingham, Recorder





:Darrell-James: Hill, :Ohioan- beneficiary-Executor-Procurator, -:mitigation of the Trustee-derelict- damages: Twitter: September 24th, 2020, 7:05 p.m. - :March 9, 2021, 3:35 p.m.

The UPS Store #3758
5301 S Superstition Mountain Dr Ste
Gila County, AZ 85120-5778
(520)474-5828

Terminal: P257563 Date: 3/9/2021
Reference: 118527 Time: 11:17 AM

Item	Qty	Price	Total
Letter	10	\$13.00	\$13.00
1st Class Mail	10	\$1.19	\$11.90
1st Class Mail	10	\$1.19	\$11.90
Subtotal			\$24.90
Shipping/Other Charges			\$2.00
Total			\$26.90
Cash			\$100.00
Change			\$73.10

Grand Total: \$26.90
Cash: \$100.00
Change: \$73.10

USPS is experiencing unprecedented volume increases and limited employee availability due to the impacts of COVID-19. We appreciate your patience.

Use Label # for inquiry on Return Receipt (Electronic)

In a hurry? Self-service kiosks offer quick and easy check-out. Any Retail Associate can show you how.

Text your tracking number to 25777 (USPS) to get the latest status. Standard Message

Visit the UPS Store, Inc.'s privacy policy at <https://www.upsstore.com/privacy-policy>

121030537508001785

U.S. Postal Service
CERTIFIED MAIL - RECEIPT
(Domestic Mail Only; NO Insurance Coverage Provided)

For delivery information visit our website at www.usps.com
8484 9310 10 24313

OFFICIAL USE

Postage	\$10.00	01.20
Certified Fee	\$1.75	16
Return Receipt Fee (Electronic Request)	\$3.00	
Accepted Delivery Fee (Electronic Request)	\$1.00	
Postage & Fees	\$15.75	

03/05/2021

John End: Hylan
Office: 10000 9440001214
Washington, DC 20018

1:10 PM · Mar 9, 2021 · Twitter Web App

2:35 PM
March 9, 2021 Darrell James Hill
1:10 p.m. @DarBenThu1

:Executor-Procurator, -:mitigation of the Trustee-derelict- damages ~



:Darrell-James: Hill, :Ohioan- beneficiary-Executor-Procurator, -:mitigation of the Trustee-derelict- damages: Twitter: September 24th, 2020, 7:05 p.m. - :March 9, 2021, 3:35 p.m.

uphold and defend The Constitution for the United States of America- 1787- 1789, et al. -Bill of Rights, et seq. -Emancipation Proclamation-1863-A.D., 'EP-1863-A.D.' and General Order 100- 1863-A.D. -as- overstanding, notwithstanding else of the office of the President for the United States-Corp here-to-for and now-to-after.

:You- all have been made to be aware of all of :these actions since 2016 A.D.; You know or should have known :this non-abandonment of :claim-matter since 2017 A.D. as now :All of :these-matters are :public-record I

Covenant-Agreement with procurator for the abandonment of the PFTUSA -non-incorporated, abandoned January 20, 2021 A.D. and vacated March 03, 2021 A.D. by the man- Donald John Trump, et al.

:i- man here-to-for and now-to-after by the sovereign-duty receive now upon i- man as kinsman-redeemer for Negro-Ysrael, Ysrael and the Holy-Church, et seq., the authority and duty of office of the PFTUSA-Authority -heretofore-ABANDONED, and now-to-after stand-over the United-States- Corp, et al. - POTUS, et seq.

Covenant-Agreement with absolute procurator as the Trustee, in-honor, for the restoration of the Private-property- claimed-and-possessed and stolen in Trustee-fraud corroborated by, Barack-Hussein-Obama, et al. -VP- Biden, CLT- Loretta Lynch, et seq -USAG/CLT, Donald John Trump, et al. -VP- Pence, CLT- Jeffrey Sessions, et seq. now to after until matter is completely remedied in accordance with the covenant-agreement-absolute-authority in procurator

:i- man here-to-foro execute Sovereign-authority with absolute-procurator attaining to the stolen possessions- Lots ## 1 - 7 :in-accordance with the covenant-agreements exclusively to attain the right to remedy to the aggrieved-beneficiary, i- man- darrell-james: hill, for the exceeding-of government-jurisdiction by deprivation/theft of private-property without right or authorization from i- man -owner, The office of the President of The United States- Corp, POTUS, -Trustee understands 1) the :DOI-1776-A.D., AOC-1777-A.D., and The Constitution for the United States of America, 1787-1789, et al. -Bill of Rights, et seq. -Emancipation Proclamation-1863-A.D., General Order 100- 1863-A.D.; 2) the Trustee: EBA-1933-A.D. Dry-Legislative-Trust -Indenture with debenture to i- man -darrell-james: hill- beneficiary; and, 3) :Trustee-Detraction -in- Dishonor :within-fraud daily-harming the :beneficiary- aggrieved, -Darrell-James: Hill, -solo, and as :kinsman-redeemer for :Negro-Ysrael, Ysrael and the Holy-Church.

i- man affirm the above is true and correct and will press same onto the record in the open court

Without prejudice,

Darrell James Hill
Darrell James Hill, Sovereign Authority with Procurator,
Executor with Absolute procurator

Affirmed and autographed before me this day 5, March 2021 A.D.
Type of Identification: Arizona Driver License,

notary public



'deprivation-penalty' amounts, and for (b) to assure and ensure the restoration for property claimed and possessed, in-specie, in-accordance with the covenant-agreements.

To: Military; Sovereign-authority with procurator by covenant: USPO CMN 7009 1410 0000 7888 5741
2 / 2

:Executor-Procurator, -:mitigation of the Trustee-derelict- damages ~

2353



:Darrell-James: Hill, :Ohioan- beneficiary-Executor-Procurator, -:mitigation of the Trustee-derelict- damages: Twitter: September 24th, 2020, 7:05 p.m. - :March 9, 2021, 3:35 p.m.

See: Notice of execution of Your 'Unalienable-right'

[@BiafraHouse](#)

[#agriberry](#) [#gardening](#) [#Virginia](#) [#Horticulture](#)

[@AHS_Gardening](#)

[@PublicGardens](#)

[@VaFarmAndFood](#)

[@urhmb1farmer](#)

[@IALRDrones](#)

[@TheRockBarn](#)

[@virginiaseafood](#)

[@raspblackassoc](#)

[@VTFermentation](#)

[@Defend_theFlock](#)

[@BrownieByTeresa](#)

Quote Tweet



Darrell James Hill

[@DarBenThu1](#)

Mar052021AD. :i- man-jurisdiction of :sovereign-authority with general-procuration (/kinsman) as the PFTUSA overstanding: POTUS-trustee, & absolute-procuration over :stolen-property (/sole) :in-accordance w/ Covenant-agreements. :PFTUSA abandoned-01/20 and vacated 03/03/2021 A.D.

2354



:Darrell-James: Hill, :Ohioan- beneficiary-Executor-Procurator, -:mitigation of the Trustee-derelict- damages: Twitter: September 24th, 2020, 7:05 p.m. - :March 9, 2021, 3:35 p.m.

Darrell-James: Hill, Sovereign-authority with-Procurator,
PO Box 5836, Apache Junction, Arizona 85117

man, -present

Arizona state
Pinal county

Jurat

Trustees:
:Mark-Alexander: General United States Army, Chairman: CJCS: Miley,
:John-Earl: General United States Air Force: Vice: CJCS: Hyten,
:James-Charles: General United States Army, COO Army,
:David-Hiberry: General United States Marine Corps: CMC: Berger,
:Michael-Martin: Admiral United States Navy: CNO: Gilday,
:David-Lee: General United States Air Force: COO AF: Koshkin,
:John-William: General United States Space Force: CSO: Raymond,
:Joseph-Lauron: General United States Air Force: CNG: Bengyal,
:Karl-Lee: Admiral United States Coast Guard: CO: Schultz
c/o: John-Earl Hyten, USPO 7000 1410 0000 7000 5741
Office: CJCS
6000 Joint Staff Pentagon
Washington, District of Columbia 20310-9359

:Sovereign -:United States of America- people-Authority AND :Sovereign-Authority
Acceptance :In-Procurator by :Covenant-Agreements: for: a) :Receipt of the
Authority for the citizen-office: President for the United States of America -1787- A.D.,
non-incorporated, -Authority on the Abandonment and Vacation of the office of the
President by the man- Donald-John- Trump, -:Trustee, -:in- Dishonor; and b)
:Sovereign-Authority Acceptance :In-Procurator by :Covenant-Agreements: Lots
One, Two, Three, Four, Five, Six, and Seven (-failure to restore republic-constitution
for cause-)

Greetings, Mark-Alexander, John-Earl, all,

I, man hope you are well.

jurisdiction, Sovereign-authority with-procurator by :Covenant-Agreements
I man-beneficiary, -Negro, -civilian, -principal, -Ohioan over-standing the Declaration of
Independence, (DOI-1776-A.D.), et seq. -with-declaration of the "United-States"- Corp. -EBA-1933-
2000 A.D. -Dry-legalistic-Trust; am) -Kinsmen-redemptor for Negro-Yarad, Yarad and the Holy-Church
of -Yuzukish, Jesus, the Messiah; and, therefore: Ambassador of the Most-High-God in -Trustee:
Concession-1213-A.D.:

- 1) Sovereign-authority under God Almighty, wherein nothing stands between the God Almighty
and I man-Ohioan, et al;
- 2) DOI-1776-A.D.: Oath, is verified- one of the people of the United States of America;
- 3) ACC-1777-A.D.: Articles of Confederation binding -Ohio -state;
- 4) The Constitution for the United States of America, 1787 -1789, et al- Bill of Rights, et seq;
- and, 5) Express political-election, "PE", -covenant-agreement with right to remedy by and with
absolute-procurator.

Trustee: Covenant-Agreement with -Beneficiary-Remedy with and by Absolute-Procurator
5) Covenant-Contracts: PE, Lots 1-5, with Lot 6 being the executed-right-of-demand for the
account, settle and close of the EBA-1933-A.D. -Dry-legalistic-Trust-covenant-agreement and,
with the Trustee/office :POTUS- ,Obama, Trump and Biden, and POTUSA- :Trump, -agreements in
the express-absolute-procurator by I- man- Darrell-James: Hill, -beneficiary, for to obtain the right
of the remedy in the deprivation of property-matters: Lots 1-6.

1 Covenant-Agreement -procurator is merely for to assure and ensure the (a) payment of the
To: Military: Sovereign-authority with procurator by covenant: USPO GMM 7000 1410 0000 7000 5741
1 / 2

2355

:Executor-Procurator, -:mitigation of the Trustee-derelict- damages ~

2354

Tweet Analytics

Darrell James hill @DarBenThu1
 See: Notice of execution of Your 'Unalienable-right'
 @BiafraHouse
 #agriberry
 #gardening #Virginia #Horticulture
 @AHS_Gardening
 @PublicGardens
 @VaFarmAndFood
 @urhmbfarmer
 @IALRDrones
 @TheRockBarn
 @virginiaseafood
 @raspblackassoc
 @VTFermentation
 @Defend_theFlock
 @BrownieByTeresa https://twitter.com/DarBenThu1/status/136915700866584576 ...

Impressions 134
 times people saw this Tweet on Twitter

Total engagements 4
 times people interacted with this Tweet

Messages

Tuesday November 9, 21:33



09/26/2022 03:35:37 PM Receipt #: 22-9381
Rec Fee: \$30.00 Darrell James Hill
Gila County, Az, Sadie Jo Bingham, Recorder



:Darrell-James: Hill, :Ohioan- beneficiary-Executor-Procurator, -:mitigation of the Trustee-derelict- damages: Twitter: September 24th, 2020, 7:05 p.m. - :March 9, 2021, 3:35 p.m.

uphold and defend The Constitution for the United States of America- 1787- 1789, et al. -Bill of Rights, et seq. -Emancipation Proclamation-1863-A.D., "EP-1863-A.D." and General Order 100- 1863-A.D. :at- overruling, notwithstanding also of the office of the President for the United States- Corp here-to-for and now-to-after.

:You- all have been made to be aware of all of :these actions since 2016 A.D.;
You know or should have known :this non-abandonment of :claim-matter since 2017 A.D. as now :All of :these-matters are :public-record I

Covenant-Agreement with procurator for the abandonment of the PFTUSA -non-incorporated abandoned January 20, 2021 A.D. and vacated March 03, 2021 A.D. by the man: Donald-John Trump, et al.
:i- man here-to-for and now-to-offer by the sovereign-duty receive-now upon :i- man as :kinsman-redeemer for Negro-Ysrael, Ysrael and the Holy-Church, et seq., the :authority and duty of office of the PFTUSA-Authority -heretofore-ABANDONED, and now-to-after stand-over the United-States- Corp, et al. :POTUS, et seq.

Covenant-Agreement with absolute procurator as the Trustee, in-honor, for the restoration of the Private-property: claimed-and-possessed and stolen in Trustee-fraud corroborated by Barack-Hussein-Obama, et al. -VP- Biden, CLT, Loretta Lynch, et seq -USAG/CLT, Donald-John-Trump, et al. -VP-Rence, CLT, Jeffrey Sessions, et seq. now to after until matter is completely remedied, in accordance with the covenant-agreement: absolute authority in procurator
:i- man here-to-for execute Sovereign-authority with absolute-procurator attaining to the stolen possessions- Lots # 1 - 7 :in-accordance with the covenant-agreements exclusively to attain the right to remedy to the aggrieved-beneficiary, :i- man- darrell-james: hill, for the :exceeding-of-government-jurisdiction by deprivation/theft of private-property without right or authorization from :i- man -owner, The office of the President of The United States- Corp., POTUS.-Trustee understands 1) the :DOI-1776-A.D., AOC-1777-A.D., and The Constitution for the United States of America, 1787-1789, et al. -Bill of Rights, et seq. -Emancipation Proclamation-1863-A.D., General Order 100- 1863-A.D.; 2) the Trustee: EBA-1933-A.D. Dry-Legislative-Trust -Indenture with debenture to :i- man -darrell-james: hill- beneficiary; and, 3) Trustee-Dereliction -in- Dishonor -within-fraud daily-harming the :beneficiary- aggrieved, -Darrell-James: Hill- sole, and as :kinsman-redeemer for Negro-Ysrael, Ysrael and the Holy-Church.

:i- man affirm the above is true and correct and will press same onto the record in the open court
Without prejudice,
Darrell James Hill
Darrell-James: Hill, Sovereign-authority with- Procurator,
Executor with- Absolute-procurator

Affirmed and autographed before me this day 5, March 2021 A.D.
Type of Identification: Arizona Driver License.

notary public

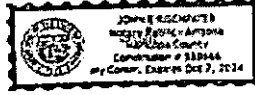

'deprivation-penalty' amounts, and for (b) to assure and ensure the restoration for property-claimed and possessed, in-specie, in-accordance with the covenant-agreements.

To: Military: Sovereign-authority with procurator by covenant: USPO CMN 7008 1410 D000 7868 5741
2 / 2

2357
Unoff

:Executor-Procurator, -:mitigation of the Trustee-derelict- damages ~



:Darrell-James: Hill, :Ohioan- beneficiary-Executor-Procurator, -:mitigation of the Trustee-derelict- damages: Twitter: September 24th, 2020, 7:05 p.m. - :March 9, 2021, 3:35 p.m.

The UPS Store #7750
 5301 S Superstition Route Pk Ste
 6200 Canyon, AZ 85119-1917
 480-974-9818

Serial#: 9203520 Date: 03/05/2021
 Estimate#: 118537 Time: 11:17 AM

ITEM NAME	QTY	PRICE	TOTAL
Letter	10	\$10.00	\$10.00
Fee			\$3.00
8.5x11 Envelopes	10	\$1.10	\$11.00
Fee			\$3.00
Subtotal			\$11.00
Shipping/Other Charges			\$3.00
Total Tax			\$1.00
Total			\$15.00
Cash			\$100.00
Change			\$85.00

Charged Back (Cash): (\$3.00)

Items Designated IP are NOT eligible for Returns, Refunds or Exchanges.

US Postal Rates are Subject to Surcharge.

Use label # for inquiry on Return Receipt (Electronic)

In a hurry? Self-service kiosks offer quick and easy check-out. Any Retail Associate can show you how.

Text your tracking number to 23777 (2USPS) to get the latest status. Standard Message.

Use the UPS Store, Inc.'s online order at <https://www.upsstore.com/track-and-ship>

UNITED STATES POSTAL SERVICE

APACHE JUNCTION
 151 W SUPERSTITION BLVD
 APACHE JUNCTION, AZ 85120-2928
 (602)275-8777

03/05/2021 11:15 AM

Product	Qty	Unit Price	Price
First-Class Mail® Letter	10		\$0.50
Washington, DC 20018			
Weight: 0 lb 0.60 oz			
Estimated Delivery Date: Tue 03/02/2021			
Certified Mail®			\$3.00
Tracking #:			
95094100007865741			
e-Return Receipt			\$1.50
Total			\$5.00
Grand Total:			\$5.00
Cash			\$100.00
Change			\$95.00

USPS is experiencing unprecedented volume increases and limited service availability due to the impacts of COVID-19. We appreciate your patience.

Use label # for inquiry on Return Receipt (Electronic)

U.S. Postal Service
CERTIFIED MAIL - RECEIPT
 (Domestic Mail Only; No Insurance Coverage Provided)

For delivery information visit our website at www.usps.com

121030537508001785

7009 2430 0000 7866 5743

Item	Amount	Postage
Postage	\$5.00	0120 16
Certified Fee	\$1.75	
Return Receipt Fee (Electronic Required)	\$1.00	
Restricted Delivery Fee (Electronic Required)	\$1.00	
Total Postage & Fees	\$8.75	

03/05/2021

John Earl Lyden
 Office of the Trustee
 11500 N. Central Expressway
 Phoenix, AZ 85018

1:10 PM · Mar 9, 2021 · Twitter Web App

:Executor-Procurator, -:mitigation of the Trustee-derelict- damages ~



:Darrell-James: Hill, :Ohioan- beneficiary-Executor-Procutor, -:mitigation of the Trustee-derelict- damages: Twitter: September 24th, 2020, 7:05 p.m. - :March 9, 2021, 3:35 p.m.

March 9, 2021
2:23 p.m.



Darrell James hill

[@DarBenThu1](#)

See: Notice of execution of Your 'Unalienable-right'

[@vgpvisions](#)

[@HEAL Food](#)

[@UCSUSA](#)

[@ClifBar](#)

[@pesticideaction](#)

[@FarmActionUS](#)

[@FarmtoSchool](#)

[@ OneCountry](#)

[@hunger](#)

[@NativeAgFund](#)

[@foe us](#)

[@fairfoodnation](#)

[@FamilyFarmCo](#)

[@Federation1967](#)

[@RuralCo](#)

Quote Tweet



Darrell James hill

[@DarBenThu1](#)

Mar052021AD. :i- man-jurisdiction of :sovereign-authority with general-procuration (/kmsman) as the PFTUSA overstanding: POTUS-trustee, & absolute-procuration over :stolen-property (/sole) :in-accordance w/ Covenant-agreements. :PFTUSA abandoned-01/20 and vacated 03/03/2021 A.D.

2360
:Executor-Procutor, -:mitigation of the Trustee-derelict- damages ~

197 / 206



:Darrell-James: Hill, :Ohioan- beneficiary-Executor-Procurator, -:mitigation of the Trustee-derelict- damages: Twitter: September 24th, 2020, 7:05 p.m. - :March 9, 2021, 3:35 p.m.

Darrell-James: Hill, Sovereign-authority with-Procurator,
PO Box 3306, Apache Junction, Arizona 85117

:man, -present

Arizona state
Pinal county

Jurat

Trustees:

:Mark-Alexander :General United States Army-Chairman: CJCS- Milley,
:John-Earl :General United States Air Force: Vice- CJCS- Hyten,
:James-Charles :General United States Army: CGS Army,
:David-Hiberry :General United States Marine Corps: CMC- Sargent,
:Kirkac-Martin :Admiral United States Navy: CNO- Gilday,
:David-Lee :General United States Air Force: CCG AF- Goldstein,
:John-William :General United States Space Force: CSC- Raymond,
:Joseph-Lauton :General United States Air Force: CNG- Bengyal,
:Karl-Lee :Admiral United States Coast Guard: CCG- Schutz
c/o :John-Earl :Hyten, USPO 7009 1410 0000 7000 5741
Office: CJCS
9599 Joint Staff Pentagon
Washington, District of Columbia 20319-9599

:Sovereign -:United States of America- people-Authority AND :Sovereign-Authority
Acceptance :in-Procurator by :Covenant-Agreements: for: a) :Receipt of the
Authority for the citizen-office: President for the United States of America -1787- A.D.,
-non-incorporated, -Authority on the Abandonment and Vacation of the office of the
President by the man- Donald-John: Trump, -:Trustee, -:in-Dishonor; and b)
:Sovereign-Authority Acceptance :in-Procurator by :Covenant-Agreements: Lots
One, Two, Three, Four, Five, Six, and Seven (-failure to restore republic-constitution
for cause-)

Groetings, :Mark-Alexander, John-Earl, all,

:- man hope you are well,

man- jurisdiction: Sovereign-authority with-procurator by :Covenant-Agreements
:- man-beneficiary, -Negro, -civilian, -principal, :Ohioan over-standing the Declaration of
Independence, DOI-1776-A.D., et seq, -:with-debenture of the "United-States"- Corp -EBA-1933-
2000 A.D. -Dry-legislative-Trust; and :Kinman-redeemer for Negro-Ysrael, Ysrael and the Holy-Church
of :Yeshua, "Jesus", the Messiah; and, therefore: Ambassador of the Most-High-God in-Trustee:
Concession-1213-A.D.:

- 1) Sovereign-authority under God Almighty, wherein nothing stands between the God Almighty
and :- man-Ohioan, et al;
- 2) DOI-1776-A.D.: Ohioan, is verified- one of the people of the United States of America;
- 3) ACC-1777-A.D.: Articles of Confederation binding :Ohio -state;
- 4) The Constitution for the United States of America, 1787-1789, et al- Bill of Rights, et seq;
- and, 5) Express political-election, "PE", -covenant-agreement with right to remedy by and with
absolute-procurator.

Trustee- Covenant- Agreement with -Beneficiary-Remedy with and by Absolute-Procurator

5) Covenant-Contracts: PE, Lots 1-5, with Lot 6 being the :executed -right-of -demands for the
account, terms and closure of the EBA-1933-A.D. -Dry-legislative-Trust -covenant-agreement and,
with the Trustee: office :POTUS - :Obama, Trump and Biden, and POTUSA- :Trump, -agreements in
the express -absolute -procurator by :- man- Darrell-James: Hill, -beneficiary, for to obtain the right
of the remedy in the deprivation of property matters: Lots 1-6).

1) Covenant-Agreement -procurator is merely for to assure and ensure the (a) :payment of the

To: Military, Sovereign-authority with procurator by covenant; USPO CIVN 7009 1410 0000 7000 5741
1 / 2

:Executor-Procurator, -:mitigation of the Trustee-derelict- damages ~

Tweet Analytics

Darrell James hill @DarBenThu1
See: Notice of execution of Your 'Unalienable-right'
#supportFarmersofColor
reparations
@wgdconf
#intothefield
#gender #R4D
@WomenFoodAgNet
@Farmland
@PrairieRivers
@AlabamaRivers
@FWAFL
@LandForGood
@ewg
@rafiusa
@CDFAClimateNews <https://twitter.com/DarBenThu1/status/1367915700866584576> ...

Impressions 178
times people saw this Tweet on Twitter

Total engagements 3
times people interacted with this Tweet

min Bloom
4 hours ago
ey And Aaron
New Statements
Controversial
ments
mes 2 hours ago
s leaving NBC
ears
Stats
ntators Gerardo R...
n Bongino discuss COVID-19
as on Fox News

Messages

Tuesday November 9, 21:32



:Darrell-James: Hill, :Ohioan- beneficiary-Executor-Procurator, -:mitigation of the Trustee-derelict- damages: Twitter: September 24th, 2020, 7:05 p.m. - :March 9, 2021, 3:35 p.m.

uphold and defend The Constitution for the United States of America- 1787- 1789. et al. -Bill of Rights, et seq. -Emancipation Proclamation-1863-A.D., "EP-1863-A.D." and General Order 100- 1863-A.D. -all- overstanding, notwithstanding else of the office of the President for the United States- Corp here-to-for and now-to-after.

:You- all have been made to be aware of all of :these actions since 2016 A.D.;
You know or should have known :this non-abandonment of :claim-matter since 2017 A.D.
as now :All of :these-matters are :public-record I

Covenant-Agreement with-procuration for the abandonment of the PFTUSA -non-incorporated, abandoned January 20, 2021 A.D., and vacated March 03, 2021 A.D. by the man- Donald-John- Trump, et al.

:I- man here-to-fore and now-to-after by the sovereign-duty receive now upon :I- man as :kinsman-redeemer for Negro-Ysrael, Ysrael and the Holy-Church, et seq., the :authority and duty of office of the PFTUSA-Authority -heretofore-ABANDONED, and now-to-after stand-over the 'United-States- Corp', et al. -POTUS, et seq.

Covenant-Agreement with absolute-procuration as the Trustee, in-honor, for the restoration of the Private-property- claimed-and-possessed and stolen in :Trustee-fraud corroborated by, Barack-Hussein-Obama, et al. -VP- Biden, CLT -Lorella Lynch, et seq. -USAG/CLT, Donald-John- Trump, et al. -VP-Pence, CLT -Jeffrey Sessions, et seq. now to after until matter is completely remedied, in accordance with the covenant-agreement-absolute-authority in-procuration

:I- man here-to-fore execute Sovereign-authority with absolute-procuration attaining to the stolen possessions- Lots ## 1 - 7 :in accordance with the covenant-agreements exclusively to attain the right to remedy to the aggrieved-beneficiary, :I- man- darrell-james: hill, for the :exceeding-of-government-jurisdiction by deprivation/theft of private-property without right or authorization from :I- man -owner, The office of the President of The United States- Corp., POTUS, -Trustee understands 1) the .DOI-1776-A.D., AOC-1777-A.D., and The Constitution for the United States of America, 1787- 1789, et al. -Bill of Rights, et seq. -Emancipation Proclamation-1863-A.D., General Order 100- 1863-A.D. ; 2) the Trustee: EBA-1933-A.D. Dry-Legislative-Trust -Indenture with debenture to :I- man -darrell-james: hill- beneficiary; and, 3) :Trustee-Dereliction -in- Dishonor :in-fraud daily-harming the :beneficiary- aggrieved, -:Darrell-James: Hill, -sole, and as :kinsman-redeemer for :Negro-Ysrael, Ysrael and the Holy-Church.

:I- man affirm the above is true and correct and will press :same onto the record in the open court

Without prejudice,

Darrell James Hill
Darrell-James: Hill, Sovereign-authority with- Procuration,
Executor with- Absolute-procuration

Affirmed and autographed before me this day 5, March 2021 A.D.
Type of Identification: Arizona Driver License.

notary public



deprivation-penalty amounts, and for (b) to assure and ensure the restoration for property-claimed and possessed, :In-specie, :in accordance with the covenant-agreements.

To: Military, Sovereign-authority with procuration by covenant: USPO CMN 7008 1410 0000 7888 5741
2 / 2

:Executor-Procurator, -:mitigation of the Trustee-derelict- damages ~

199 / 206

2363



:Darrell-James: Hill, :Ohioan- beneficiary-Executor-Procurator, -:mitigation of the Trustee-derelict- damages: Twitter: September 24th, 2020, 7:05 p.m. - :March 9, 2021, 3:35 p.m.

The UPS Store 43756
 5361 S Superstition Mountain Dr Ste
 4024 Canyon, AZ 85119-1911
 480-474-9124

Serial #: 9237529 Date: 3/9/2021
 Instance #: 116527 Time: 11:17 AM

ITEM NAME	QTY	PRICE	TAX
Letter	10	\$15.00	\$15.00
Tea			\$3.00
6-511 Copies	15	\$4.11	\$1.13
Tea			\$3.53
Subtotal			\$17.13
Printer/Other Charge			\$2.89
Total Tax			\$3.62
Total			\$17.13
Cash			\$23.00
Change Back (Cash)			\$5.87

Items Participated In are NOT eligible for Returns, Refunds or Exchanges.

US Postal Rates Are Subject to Surcharge.

121030537500001785

View the UPS Store, Inc.'s privacy policy at
<https://www.upsstore.com/privacy-policy>

UNITED STATES POSTAL SERVICE

APACHE JUNCTION
 151 W SUPERSTITION BLVD
 APACHE JUNCTION, AZ 85120-0798
 (602)275-9777

03/05/2021 11:19 AM

Product	Qty	Unit Price	Price
First-Class Mail® Letter	1		\$1.59
Washington, DC 20318			
Weight: 0 to 0.07 oz			
Estimated Delivery Date			Tue 03/02/2021
Certified Mail®			\$3.60
Tracking® #:			70091400007665741
e-Return Receipt			\$1.75
Total			\$3.94
Grand Total:			\$7.07
Cash			\$100.00
Change			\$92.93

USPS is experiencing unprecedented volume increases and limited employee availability due to the impacts of COVID-19. We appreciate your patience.

Use label # for inquiry or Return Receipt (Electronic)

In a hurry? Self-service kiosks offer quick and easy check-out. Any Retail Associate can show you how.

Text your tracking number to 23777 (USPS) to get the latest status. Standard Message

U.S. Postal Service
CERTIFIED MAIL, RECEIPT
 (Domestic Mail Only; No Insurance Coverage Provided)

For Delivery Information visit our website at www.usps.com

OFFICIAL USE

Postage	\$1.59	0130
Certified Fee	\$1.75	16
Return Receipt Fee (Enclosure Required)	\$0.00	
Restricted Delivery Fee (Enclosure Required)	\$0.00	
Total Postage & Fees	\$3.34	

03/05/2021

John Ford, Helen
 Office: 40205 999501214
 Washington District - Columbia 20518

2:23 PM · Mar 9, 2021 · Twitter Web App

:Executor-Procurator, -:mitigation of the Trustee-derelict- damages ~

Darrell James hill

Tweet Analytics

Darrell James hill @DarBenThu1
 Mar052021AD. :- man-jurisdiction of :sovereign-authority with general-procuration (/kinsman) as the PFTUSA overstanding: POTUS-trustee, & absolute-procuration over :stolen-property (/sole) .in-accordance w/ Covenant-agreements. :PFTUSA abandoned-01/20 and vacated 03/03/2021 A.D.
 pic.twitter.com/gKSZg7tCyR

Impressions times people saw this Tweet on Twitter	2,479
Total engagements times people interacted with this Tweet	43

[View all engagements](#)

Darrell James
@DarBenThu1

Negro-Israel, -civil
Amb. of Yushuah to

ONLY THE PROF
Joined September

0 Following 5 Followers

- Pharmaceutic...
Science [Follow](#)
- Michels
Michels [Follow](#)
- Hankins (Red)





:Darrell-James: Hill, :Ohioan- beneficiary-Executor-Procurator, -:mitigation of the Trustee-derelict- damages: Twitter: September 24th, 2020, 7:05 p.m. - :March 9, 2021, 3:35 p.m.

March 9, 2021 Darrell James hill
2:23 p.m. @DarBenThu1

See: Notice of execution of Your 'Unalienable-right' #supportFarmersofColor
reparations
[@wgdconf](#)
[#intothefield](#) [#gender](#) [#R4D](#)
[@WomenFoodAgNet](#)
[@Farmland](#)
[@PrairieRivers](#)
[@AlabamaRivers](#)
[@FWAFL](#)
[@LandForGood](#)
[@ewg](#)
[@rafiusa](#)
[@CDFAClimateNews](#)

Quote Tweet



Darrell James hill
@DarBenThu1

Mar052021AD. :i- man-jurisdiction of :sovereign-authority with general-procuration (/kinsman) as the PFTUSA overstanding: POTUS-trustee, & absolute-procuration over :stolen-property (/sole) :in-accordance w/ Covenant-agreements. :PFTUSA abandoned-01/20 and vacated 03/03/2021 A.D.

7366



:Darrell-James: Hill, :Ohioan- beneficiary-Executor-Procurator, -:mitigation of the Trustee-derelict- damages: Twitter: September 24th, 2020, 7:05 p.m. - :March 9, 2021, 3:35 p.m.

Darrell-James: Hill, Sovereign-authority with-Procurator,
PO Box 3806, Apache Junction, Arizona 85117

man. -present

Arizona state
Pinal county

Jurat

Trustees:

:Mark-Alexander :General United States Army-Chairman: CJCOS :Miley,
:John-Earl :General United States Air Force: Vice- CJCOS :Hyten,
:James-Charles :General United States Army: COS Army:
:David-H Iberry :General United States Marine Corps: CMC :Borger,
:Michael-Martin :Admiral United States Navy: CNO :Gibday,
:David-Lee :General United States Air Force: COS AF :Goldstein,
:John-William :General United States Space Force: CSO :Raymond,
:Joseph-Lauton :General United States Air Force: CNG :Bengyel
:Karl-Lee :Admiral United States Coast Guard: CCG :Schultz
c/o :John-Earl-Hyten, USPO 7000 1410 0000 7000 5741
Office: CJCOS
8909 Joint Staff Pentagon
Washington, District of Columbia 20318-9959

:Sovereign -United States of America- people-Authority AND :Sovereign-Authority
Acceptance in-Procurator by :Covenant-Agreements; for: a) :Receipt of the
Authority for the citizen-office: President for the United States of America -1787- A.D.,
non-incorporated, -Authority on the Abandonment and Vacation of the office of the
President by the man- Donald-John- Trump, -:Trustee, -in-Dishonor; and b)
:Sovereign-Authority Acceptance in-Procurator by :Covenant-Agreements: Lots
One, Two, Three, Four, Five, Six, and Seven (-failure to restore republic-constitution
for cause-)

Greetings, :Mark-Alexander, John-Earl, all,

:- man hope you are well,

man-jurisdiction, Sovereign-authority, with-procurator, by :Covenant-Agreements
:- man-beneficiary, -Negro, -civilian, -principal, :Ohioan over-standing the Declaration of
Independence, :DCI-1776-A.D., of leg. -with-debenture of the 'United-States'- Corp :-EBA-1833-
2000 A.D. -Dry-legalistic-Trust; and :Kinsman-redemptor for Negro-Yarbel, Ysrael and the Holy-Crutch
of :Yehush, 'Jesus', the Messiah; and, therefore: Ambassador of the Most-High-God in -Trustee:
Concession-1213-A.D.

1) Sovereign-authority under God Almighty, where-in nothing stands between the God Almighty
and :- man-Ohioan, et al;
2) DCI-1776-A.D. -Ohioan, is verified- one of the people of the United States of America;
3) ACC-1777-A.D. Articles of Confederation binding :Ohio -state;
4) The Constitution for the United States of America, 1787 -1789, et al- Bill of Rights, et seq;
and, 5) Express political-election, 'PE', -covenant-agreement with right to beamed by and with
absolute-procurator.

Trustee: Covenant-Agreement with -Beneficiary-Remedy with and by Absolute-Procurator
5) Covenant-Contracts: PE, Lots 1-5, with Lot 0 being the :-executed-right-of-demand for the
account, term and closure of the EBA-1033-A.D. -Dry-legalistic-Trust -covenant-agreement; and,
with the Trustee's office :POTUS - :Obama, Trump and Biden, and POTUSA - :Trump, -agreements in
the express -absolute -procurator by :- man- Darrell-James: Hill, -beneficiary, for to obtain the right
of the remedy in the deprivation of property- matters: Lots 1-5¹,

1 Covenant-Agreement -procurator is merely for to assure and ensure the (a) :payment of the

To: Military, Sovereign-authority with procurator by covenant: USPO 0203 7000 1410 0000 7000 5741
1 / 2

2367
:Executor-Procurator, -:mitigation of the Trustee-derelict- damages ~



:Darrell-James: Hill, :Ohioan- beneficiary-Executor-Procurator, -:mitigation of the Trustee-derelict- damages: Twitter: September 24th, 2020, 7:05 p.m. - :March 9, 2021, 3:35 p.m.

The UPS Store #3758
 5301 S Superstition Mountain Dr Ste
 Suite 1000, AZ 85119-1917
 480-474-9428

Item	Qty	Price	Total
Water			\$10.00
Tax			\$1.00
Postage			\$1.10
Tax			\$1.00
Subtotal			\$13.10
Shipping/Postage Charges			\$1.00
Tax			\$1.00
Total			\$15.10
Cash			\$15.10
Change back (Cash)			(\$1.00)

Items Consignee/Shipper are NOT eligible for Returns, Refunds or Exchanges.

US Postal Rates Are Subject to Surcharges.

Visit the UPS Store, Inc.'s website online at www.upsstore.com for more information.

UNITED STATES POSTAL SERVICE
 APACHE JUNCTION
 151 W SUPERSTITION BLVD
 APACHE JUNCTION, AZ 85120-9778
 (602)275-5777

03/05/2021 11:10 AM

Product	Qty	Unit Price	Price
First-Class Mail® Letter	1		\$0.55
Weight: 0.10 0.50 oz			
Estimated Delivery Date: Tue 03/09/2021			
Certified Mail®			\$3.60
Tracking #:			
7009 1430 0000 7855 5791			
e-Return Receipt			\$1.00
Total			\$5.15
Grand Total:			\$5.90
Cash			\$10.00
Change			-\$4.10

USPS is experiencing unprecedented volume increases and limited employee availability due to the impacts of COVID-19. We appreciate your patience.

Use label if for inquiry on Return Receipt (Electronic)

In a hurry? Self-service kiosks offer quick and easy check-out. Any Retail Associate can show you how.

Text your tracking number to 28777 (USPS) to get the latest status. Standard Message.

U.S. Postal Service - CERTIFIED MAIL® RECEIPT
 (Domestic Mail Only; No Insurance Coverage Provided)

For delivery information visit our website at www.usps.com

OFFICIAL USE

Postage	\$5.00	0120
Certified Fee	\$1.75	16
Return Receipt Fee (Government Possession)	\$0.00	
Additional Delivery Fee (Excess Mileage)	\$0.00	
Total Postage & Fees	\$6.75	

Postmark Here

03/05/2021

John End: Helen
 Office Carlos, 9445 15th St
 Washington District Columbia 20518

2:23 PM · Mar 9, 2021 · Twitter Web App

March 9, 2021 Darrell James hill

:Executor-Procurator, -:mitigation of the Trustee-derelict- damages ~



:Darrell-James: Hill, :Ohioan- beneficiary-Executor-Procurator, -:mitigation of the Trustee-derelict- damages: Twitter: September 24th, 2020, 7:05 p.m. - :March 9, 2021, 3:35 p.m.

uphold and defend The Constitution for the United States of America- 1787- 1789, et al. -Bill of Rights, et seq. -Emancipation Proclamation-1863-A.D., 'EP-1863-A.D.' and General Order 100- 1863-A.D. ,ad- overstanding, notwithstanding else of the office of the President for the United States-Corp here-to-for and now-to-after.

:You- all have been made to be aware of all of :those actions since 2016 A.D.;
You know or should have known :this non-abandonment of :claim-matter since 2017 A.D.
as now :All of :these-matters are :public-record I

Covenant-Agreement with-procuration for the abandonment of the PFTUSA -non-incorporated, abandoned January 20, 2021 A.D. and vacated March 03, 2021 A.D. by the man- Donald-John- Trump, et al.

:i- man here-to-fore and now-to-after by the sovereign-duty receive now upon :i- man as kinsman-redeemer for Negro-Ysrael, Ysrael and the Holy-Church, et seq., the :authority and duty of office of the PFTUSA-Authority -heretofore-ABANDONED, and now-to-after stand-over the 'United States- Corp', et al. - POTUS, et seq.

Covenant-Agreement with absolute-procuration as the Trustee, in-honor, for the restoration of the Private-property -claimed-and-possessed and stolen in -Trustee-fraud corroborated by Barack-Hussein-Obama, et al. -VP- Biden, C.I.T. -Lorigita Lynch, et seq. -USAG/C.I.T. Donald-John- Trump, et al. -VP-Pence, C.I.T. - Jeffrey Sessions, et seq. now to after until matter is completely remedied, in accordance with the covenant-agreement-absolute-authority in-procuration

:i- man here-to-fore execute Sovereign-authority with absolute-procuration attaining to the stolen possessions- Lots #1 - 7 :in-accordance with the covenant-agreements exclusively to attain the right to remedy to the aggrieved-beneficiary, :i- man- darrell-james' hill, for the :exceeding-of-governent-jurisdiction by deprivation/theft of private-property without right or authorization from :i- man -owner, The office of the President of The United States- Corp., POTUS -Trustee understands 1) the :DCI-1776-A.D., AOC-1777-A.D., and The Constitution for the United States of America, 1787-1789, et al. -Bill of Rights, et seq. -Emancipation Proclamation-1863-A.D., General Order 100- 1863-A.D.; 2) the Trustee: EBA-1933-A.D. Dry-Legislative-Trust -Indenture with debenture to :i- man -darrell-james: hill- beneficiary; and, 3) :Trustee-Deneciation -in- Dishonor -within-fraud daily-harming the :beneficiary- aggrieved, -Darrell-James: Hill, -sole, and as :kinsman-redeemer for :Negro-Ysrael, Ysrael and the Holy-Church.

:i- man affirm the above is true and correct and will press same onto the record in the open court

Without prejudice,

Darrell James Hill
Darrell James Hill, Sovereign Authority with Procuration,
Executor with Absolute Procuration

Affirmed and autographed before me this day 5, March 2021 A.D.
Type of Identification: Arizona Driver License.

notary public

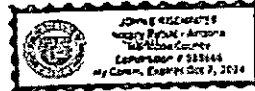

Deprivation-penalty amounts, and for (b) to assure and ensure the restoration for property-claimed and possessed, in-specie, in-accordance with the covenant-agreements.

To: Military: Sovereign-authority with procuration by covenant: USPO CMIN 7009 1410 0000 7868 5741
2 / 2

2368 BH
22/09
UNOFFICIAL

:Executor-Procurator, -:mitigation of the Trustee-derelict- damages ~



:Darrell-James: Hill, :Ohioan- beneficiary-Executor-Procurator, -:mitigation of the Trustee-derelict- damages: Twitter: September 24th, 2020, 7:05 p.m. - :March 9, 2021, 3:35 p.m.

3:35 p.m.

[@DarBenThu1](#)

Grievance Officer - India <https://help.twitter.com/en/rules-and-policies/report-twitter-abuse-india>

account ceased instead of facilitating the purposes of the communication that is obvious in violation of the DOI-1776-A.D. under the corporate charter under the obligation of The Constitution for the United States of America.

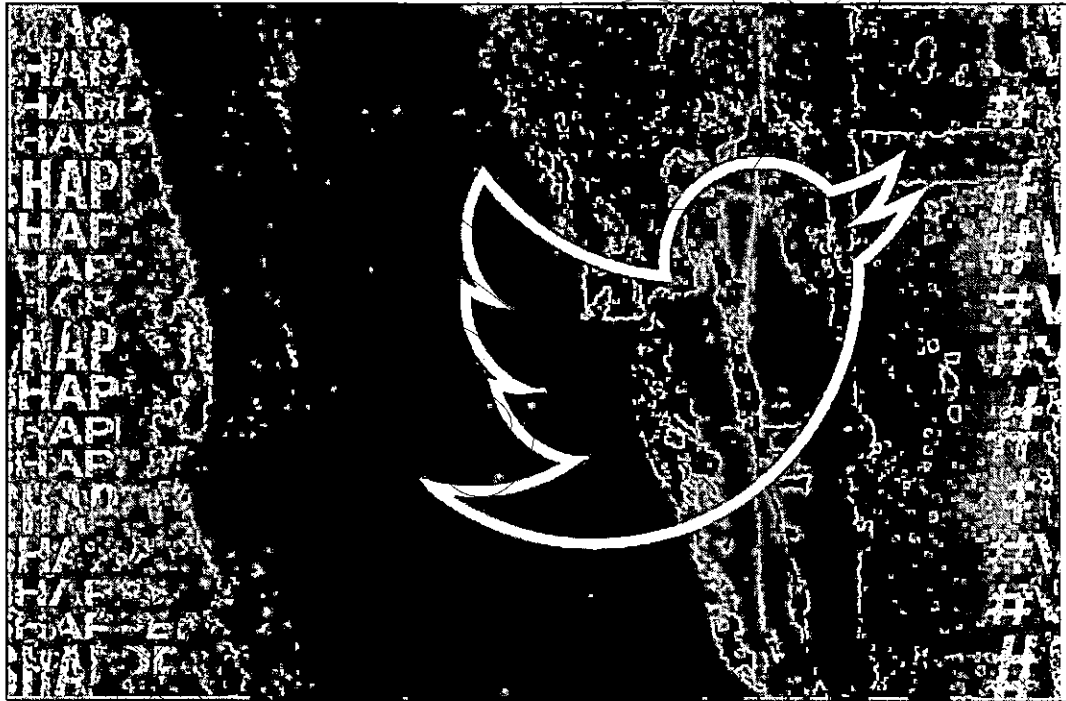

help.twitter.com

[Grievance officer-for users in India | Twitter Help](#)

[Find how to report possible violations, & see contact information of the Grievance Officer for Twitter users in India.](#)

3:32 PM · Mar 9, 2021 · Twitter Web App

September 3,
2021
5:58 a.m.



Darrell James Hill

[@DarBenThu1](#)

:Executor-Procurator, -:mitigation of the Trustee-derelict- damages ~

205 / 206

:Darrell-James: Hill, :Ohioan- beneficiary-Executor-Procurotor, -mitigation of the Trustee-derelict- damages: Twitter: September 24th, 2020, 7:05 p.m. - :March 9, 2021, 3:35 p.m.

Hello.
.5:58 AM · Sep 3, 2021 · Twitter Web App

i- man verify that this is the extraction of the DarBenThu1 at the Twitter.com-service for this dispose of the damage with the mitigation by the :i- man -:Darrell-James: Hill, :Ohioan- beneficiary-Executor-Procurotor

Without prejudice,

:Darrell-James: Hill, :Ohioan- beneficiary-Executor-Procurotor of the Trustee-dereliction- damages

Unofficial

2371
7370

:Executor-Procurotor, -:mitigation of the Trustee-derelict- damages ~

Tweet



3:32 PM Mar 9, 2020

Tweet Analytics

Darrell James Hill @DarBenThu1
Grievance Officer - India <https://help.twitter.com/en/rules-and-policies/report-twitter-abuse-india> ...
account ceased instead of facilitating the purposes of the communication that is obvious in violation of the DOI-1776-A.D. under the corporate charter under the obligation of The Constitution for the United States of America.

Impressions	127
times people saw this Tweet on Twitter	
Total engagements	5
times people interacted with this Tweet	

[View all engagements](#)

Promote your Tweet

messages

Tuesday November 9, 21:31



:Claim-#: RF 645 167 639 US -Claim of the Completion of the Record

:Complement-Claim: D ~ : Claim of the Social-Media-Twitter-usage-timed for the protection of the right: DOI-1776-AD in the concordance with the law of the PE-2022-AD -EBA-1933-AD -Covenant by the law of the PE-2022-AD -Covenant;

:Complement-Claim: D ~ : Claim of the Social-Media-Twitter-usage-timed for the protection of the right: DOI-1776-AD in the concordance with the law of the PE-2022-AD -EBA-1933-AD -Covenant by the law of the PE-2022-AD -Covenant;

:Complement-Claim: D ~ : Claim of the Social-Media-Twitter-usage-timed for the protection of the right: DOI-1776-AD in the concordance with the law of the PE-2022-AD -EBA-1933-AD -Covenant by the law of the PE-2022-AD -Covenant;

D-4

Pages 2323-

:Mark	:Matter	:Location	:Claim	:Facts
:Era 1 #Sept2020DarBenThu1		September	:Era 1 #Sept2020DarBenThu1	
~0001	:new-start	8:35 PM · Sep 22, 2020 https://twitter.com/status/1308610885313650690	:new-start :address :property ¹ -stolen ²	
~0002	:claim ³ s in the gilacountyaz.gov/government/recorder/ Public-Record	8:42 PM · Sep 22, 2020 https://twitter.com/status/1308612640000802816	:claims in the Public-Record ⁴ ~wish all property restored post-haste~	gilacountyaz.gov/government/recorder/
~0003		8:55 PM · Sep 22, 2020 https://twitter.com/status/1308615838975447040	Hi to *ADOS ~believe this may resolve the problem~	*Adult Descendants Of Slaves

- 1 **:property means:** before of the person; Example: given by the Almighty-God
- 2 **:property-stolen means:** Violent-taking of the right: DOI-1776-AD with the lack of the authority
- 3 **:claim means:** Public-open-notice-made
- 4 **:public-record means:** the recordation system for the Community-notices

:Mark	:Matter	:Location	:Claim	:Facts
-------	---------	-----------	--------	--------



~0004	:notice ⁵ : PE-2016-AD ⁶ -DOI-1776-AD ⁷ -Ohioan ⁸ -Executor ⁹ -Procurator ¹⁰ -Standing ¹¹ ; and: New-Mexican ¹² -Executor-Procurator-Statnding.	<u>11:49 AM · Sep 24, 2020</u> https://twitter.com/status/1309203233538146304	https://BlackandBlueLivesMatter.Wordpress.com	Procurator- Proof-of-notice-7009- 1410 0000 7868 5802- :Executor: PE-2017-A.D.- Nonconsent ¹³ to :DOI-1776-A.D.- deprivation of -:unalienable-rights upon the man- Ohioan and New-Mexican by the Executor- Procurator https://blackandbluesoulsmatter.files.wordpress.com/2021/12/2021_016195.pdf ¹⁴
~0005	:notice: Property-Lots ¹⁵ 1, 2, 3, -Stolen ¹⁶	<u>7:09 PM · Sep 24, 2020</u> https://twitter.com/status/1309313994214141952	lots of property: that have have been stolen from :- man.	Lot#1 https://blackandbluesoulsmatter.files.wordpress.com/2020/09/c-lot-1-gila-cnty-ariz.-rec.-doc-

5 :notice means: claim

6 :PE-2016-AD means: PE –political-Election – year- AD of the Settlor-Grantor-Claim and Chosing of the relationship with the US-Corp for the GFTUSA-1787-AD - GSP- Covenant- Fidelity.

7 :DOI-1776-AD means: The Constitution of the nation with the Declaration-of-Independence of 1776 AD, et al.

8 :Ohioan means: Ohio-State-Country-Man-Sovereign-Settlor-Grantor of the DOI-1776-AD, -Settlor-Grantor of the EBA-1933-AD

9 :Executor means: minister for the sure-complete-benefit-made upon the beneficiary

10 :Procurator means: Acting-officer over-standing the completion of the healing of the Trespass as the office-holder would if he could

11 :Standing means: place of the authority

12 :New-Mexican means: New-Mexican -Country-Man-Sovereign-Settlor-Grantor of the DOI-1776-AD, -Settlor-Grantor of the EBA-1933-AD

13 :Nonconsent means: lack of the authorization

14 :2021_016195.pdf means: Arizona-State-Country-Gila-Country-Recorder-Clam-Entry-#

15 :Lots means: Describe set of the content

16 Stolen means: taking with the lack of the authorization

:Mark	:Matter	:Location	:Claim	:Facts
-------	---------	-----------	--------	--------



2585

				2017_002378.pdf ¹⁷ Lot #2 https://blackandbluesoulsmatter.files.wordpress.com/2020/09/d-lot-2-gila-cnty-ariz.-rec.-doc-2019-0009291.pdf ¹⁸ Lot #3 https://blackandbluesoulsmatter.files.wordpress.com/2020/09/e-lot-3-gila-cnty-ariz.-rec.-doc-2019-0009291.pdf
~0006	:notices: PR ¹⁹ of the USPO- RMN ²⁰ mailings for the healing of the damage of the property-Stolen	7:11 PM · Sep 24, 2020 https://twitter.com/status/1309314462768267264	:two of the claims concerning the 3 Lots of the property- solen in the public-record of the property of :i- man	Gila county, 2017_002378 https://blackandbluesoulsmatter.files.wordpress.com/2020/09/gila-county-2017_002378.pdf Gila, county 2019_009291 https://blackandbluesoulsmatter.files.wordpress.com/2020/09/gila-c
~0007		10:05 PM · Sep 24, 2020 https://twitter.com/status/1309358294348173319	:Com-notice: #Reparationist	

17 :2017_002378.pdf means: Arizona-State-Country-Gila-Country-Recorder-Clam-Entry-#
 18 :2019-0009291.pdf means: Arizona-State-Country-Gila-Country-Recorder-Clam-Entry-#
 19 :Public-Record means: General-Society-Required-Notice
 20 :USPO- RMN means: United-State-Post-Office -Registered-Mail-Number

:Mark	:Matter	:Location	:Claim	:Facts	3 / 199
-------	---------	-----------	--------	--------	---------



~0008	Point to @DarBenThu1 for the healing of the damages ²¹ / Lieber Code-1863-AD ²² with US-Corp-GSP ²³ -Trustee: EBA-1933-AD ²⁴ in -:Dishonor ²⁵	4:43 PM · Sep 25, 2020 https://twitter.com/status/1309639635786579969	:Com- notice: #GenMilley ²⁶ of -:JCOS ²⁷ ; Msg: Donald-John: Trump has stolen property ²⁸	Point to @DarBenThu1 for the healing of the damages/ Lieber Code Duty ²⁹
:Era 1 #Oct2020DarBenThu1		October	Era 1 #Oct2020DarBenThu1	
~0010	Doctor fances cress weising media slavery psychology	11:40 AM · Oct 2, 2020 https://twitter.com/DarBenThu1/status/1312100143219396608	Dr. Frances Cress Welsing - The Psychological Slavery of Black People in The Media	youtube.com/watch?v=jrEikj30uY8 -is not available! ?-
~0011	Twitter Dishonor Trespass Trustee Covenant	4:44 PM · Oct 5, 2020 https://twitter.com/DarBenThu1/status/1313263777299623936	See: Twitter- Witness List for the Common-Law, -:Public Notice on the matter of the :Notary-Public- Dishonor Upon the :Trespass and Violation of the :Duty and Obligations by the Trustee of the Legislative- Covenant(s).	
~0012	Arrest Politicians	5:57 AM · Oct 7, 2020	Can we arrest politicians who violate the Constitution? https://	https://youtube.com/watch?v=fLGwqDjkgIq -is

- 21 :healing of the damages means: Making-whole of the loss
- 22 :Lieber Code-1863-AD means: USofA-1863-AD -Military-Standard-Duty
- 23 :US-Corp-GSP means: The Escrow company 2003-AD to now: POTUS
- 24 :US-Corp-GSP-Trustee: EBA-1933-AD means: Fidelity and duty under the oath of the office-taker- person
- 25 :Dishonor means: lack of the honor, **Treason**
- 26 :GenMilley means: Chairman of the JCOS

:Mark	:Matter	:Location	:Claim	:Facts	4 / 199
-------	---------	-----------	--------	--------	---------



2376

		https://twitter.com/DarBenThu1/status/1313825752744292357	youtube.com/watch?v=fLGwqDjkgIq :Dr. Edwin Vieira, Jr. 1'28"	not available/ ?~
-0013	Jeff Sessions AG USAG DOJ	11:34 PM · Oct 7, 2020 https://twitter.com/DarBenThu1/status/1314091751309668352	:Jeff: Sessions said this: https://twitter.com/DarBenThu1/status/1314091751309668352/photo/1	Jeff USAG-DOJ quit the job.
-0014	Concession 1213 Crown Britannic Trustee Secretary of State	4:55 PM · Oct 16, 2020 https://twitter.com/DarBenThu1/status/1317252871184764928	:Just disposed this ' https://blackandbluesoulsmatter.files.wordpress.com/2020/10/2020-ltr-to-the-barons-final-2-all-2.pdf , to the barons, et al. at the Inns of the :Crown -:Temple, London. with cc: to :Donald-John: Trump, -:POTUSA, and: Michael: Pompeo, -:U.S. -SOS. re: :i- man am Now Trustee!	https://blackandbluesoulsmatter.files.wordpress.com/2020/10/2020-ltr-to-the-barons-final-2-all-2.pdf
-0015	Privation derelict property Holy-Church kinsman-redeemer Yacob Ysrael Concession 1213	4:14 PM · Oct 19, 2020 https://twitter.com/DarBenThu1/status/1318329697042771969	See: "Sentinel Events for the Restoration of the Deprived-Property~the 'Concession of 1213 A.D', Concession-1213-A.D., et seq.~ stolen by Trustee-Derelicts, so to recover properly both, solely, and as the :kinsman-redeemer for :Negro-Ysrael, Ysrael and the Holy-church"	https://twitter.com/DarBenThu1/status/1318329697042771969/photo/1 https://twitter.com/DarBenThu1/status/1318329697042771969/photo/2 https://twitter.com/DarBenThu1/status/

27 :JCOS means: Joint Chief of the Staff- Military

28 :Msg -stolen: Obama, Trump and Biden corroborate the same stolen property

29 :Lieber Code Duty: USofA- Military-duty by the Lieber-Code-1863-AD

:Mark	:Matter	:Location	:Claim	:Facts	5 / 199
-------	---------	-----------	--------	--------	---------

2022-011769 MISC Page: 2588 of 2782
09/26/2022 03:35:37 PM Receipt #: 22-9381
Rec Fee: \$30.00 Darrell James Hill
Gila County, Az, Sadie Jo Bingham, Recorder



131

				1318329697042771969/photo/3 Sentinel Events for the Restoration of the Deprived- Property~the 'Concession of 1213 A.D', Concession-1213-A.D., et seq.- stolen by Trustee-Derelicts
~0016	Roman-Church Holy-Church Trump Pompeo	4:41 PM · Oct 19, 2020 https://twitter.com/DarBenThu1/status/1318336427227107328	See: Specialty-Presentment to :Crown- :Temple -Inns, that :Roman-church: 1) Acquiesced ..., and 2) thereby, have NO Authority to Negotiate for the Holy-church; and 3) cc: to Donald-John: Trump, -:POTUSA and :Michael: Pompeo, -:U.S.- :SOS.	https://blackandbluesoulsmatter.wordpress.com/2020/10/16/b-specialty-presentment-to-crown-temple-inns-that-roman-church-1-acquiesced-vacated-the-concession-1213-a-d-covenant-trustee-replacement-in-august-2020-a-d-and-2-thereby-have-no-author/
~0017	Concession 1213 Roman-Church Ireland England KnightsTemplar	2:59 PM · Oct 20, 2020 https://twitter.com/DarBenThu1/status/1318673094270054400	#Concession1213AD The Concession-1213-A.D. refers to the "Concession of 1213 A.D." when Britain's King John I conceded Ireland and England over the Roman-church. Why? He was losing the war, and needed to get help from the Roman-church- Knights- Templar.	
~0018	Emancipation EP POTUSA CIC 1863	3:05 PM · Oct 20, 2020 https://twitter.com/DarBenThu1/status/1318674731038515200	#EP1863AD The Emancipation Proclamation was the effective :January 1, 1863 A.D. for the southern states named; that, if the secession wasn't over then their immoral-slave- trade was over by Executive Order under the Emergency Powers of the POTUSA-CIC.	

:Mark	:Matter	:Location	:Claim	:Facts	6 / 199
-------	---------	-----------	--------	--------	---------



2

-0019	USofA-1776-People American-Revolutionary- War ARW 1771 1783 Britain united	3:13 PM · Oct 20, 2020 https://twitter.com/DarBenThu1/status/1318676729074909184	#DOI1776AD The Declaration of Independence of 1776 A.D. was the underdog- agreement with the Almighty-God with the :United-Colonies for God's UN-ALIEN- ABLE -Rights to supercede the :British- Empire's imperialist-tax or kill policy. And, then the war heated-up: 1775-1783 A.D.	
-0020		1:05 PM · Oct 21, 2020 https://twitter.com/DarBenThu1/status/1319006961153667072	MORE SIMPLER WORDS: WHAT ARE MY INTENTIONS, AND WHAT YOU WANT DONE? FROM I. See: Response to :Sister-L.	
-0021	Richard Williams Ysrael AI Kingdom of Judah Slavery PTSD	3:23 PM · Oct 25, 2020 https://twitter.com/DarBenThu1/status/1320491095944359937	Needle in the haystack!! TY AI. professor richard williams, born 1950 A.D. Truth: " They Stole It But You Must Return It" https://youtube.com/watch?v=uiJVMp70z_A The :root -source -problem of :abject-slavery is the :substance which the wrong-doings imposed upon :Negro-Ysrael heals PTSD -America	~video isn't available anymore~
-0022	Neely Fuller Jr racism white-genetic-survival Black-Nobility Concession 1213	3:30 PM · Oct 25, 2020 https://twitter.com/DarBenThu1/status/1320493046027333632	Neely Fuller Jr How Racism Got Started https://youtube.com/watch?v=7-4ENR-l35A We Americans think whatever but 'White genetic survival' is the core-deception controlled by the Black-Nobility. Funny, Ireland, Scotland, etc. are Ysrael. Did you know that? Concession of 1213 A.D. was for Ysrael.	https://www.youtube.com/watch?v=7-4ENR-l35A ~Lastview: Aug- 2022-AD~
-0023	Twitter Facebook	3:43 PM · Oct 27, 2020	TO:	

:Mark	:Matter	:Location	:Claim	:Facts	7 / 199
-------	---------	-----------	--------	--------	---------



Handwritten signature/initials

		https://twitter.com/DarBenThu1/status/1321220940856881152	<p>@Facebook</p> <p>c/o :</p> <p>@TwitterSupport @Policy @POTUS @realDonaldTrump @VP @Cabinet @WHNSC @DarBenThu1 @TheJusticeDept</p> <p>Without prejudice. :- man claim the following attached, re: the licensed-corp., -trustees understanding the POTUSA-CIC: Facebook; et al. -:Twitter. Shalom</p>	
~0024	EBA 1933 Emergency Banking Act Trust Fund Surety for US-Corp Bankruptcy	<p>8:31 AM · Oct 29, 2020</p> <p>https://twitter.com/DarBenThu1/status/1321836952337874948</p>	<p>#EBA1933AD The EMERGENCY BANKING ACT OF 1933, IS THE LARGEST TRUST-FUND EVER CREATED for the uSofA-people to be surety for the U.S.-corp 1933 'bankruptcy'.</p> <p>See: pdf: https://fraser.stlouisfed.org/files/docs/his</p>	https://fraser.stlouisfed.org/files/docs/historical/federal%20reserve%20history/bank_holiday/bank_emerg_pt1_19330225.pdf
:Era 1 #Nov2020DarBenThu1		November	:Era 1 #Nov2020DarBenThu1	
~0025	Trump EO 13798 Liberty Speech	<p>12:19 AM · Nov 2, 2020</p> <p>https://twitter.com/DarBenThu1/status/1323162898563170305</p>	<p>#PromotingFreeSpeechandReligiousLiberty2017 POTUS, -: Donald-John: Trump; Executive Order 13798 of May 4, 2017 Promoting Free Speech and Religious Liberty</p> <p>file:///tmp/mozilla_dj0/2017-09574.pdf US/AG, -:Sessions</p> <p>file:///tmp/mozilla_dj0/2017-23269.pdf</p>	
~0026	John Pope Concession 1213 Magna	<p>12:00 AM · Nov 2, 2020</p> <p>https://twitter.com/DarBenThu1/status/</p>	<p>John I: Concession Of England To The Pope Innocent III, 1213 https://sourcebooks.fordham.edu/source/john1a.asp</p>	<p>2:59 PM · Oct 20, 2020</p> <p>https://twitter.com/DarBenThu1/status/</p>

:Mark	:Matter	:Location	:Claim	:Facts	8 / 199
-------	---------	-----------	--------	--------	---------



2380

	Carta 1215	1323157926488334337	Magna Carta, 1215 https://avalon.law.yale.edu/medieval/magframe.asp https://en.wikipedia.org/wiki/Magna_Carta#13th_century '.... The charter was annulled by Pope Innocent III.	1318673094270054400
~0027	American Civil War ACW 1861 1865 EP 1862 EP 1863	12:02 AM · Nov 2, 2020 https://twitter.com/DarBenThu1/status/1323158536654786560	American Civil War, 1861-1865 https://en.wikipedia.org/wiki/American_Civil_War The Preliminary Emancipation Proclamation, 1862 September 22, 1862 https://archives.gov/exhibits/american_originals_iv/sections/transcript_preliminary_emancipation.html https://avalon.law.yale.edu/medieval/magframe.asp Emancipation Proclamation, 1863 January 1, 1863 https://archives.gov/exhibits/featured-documents/emancipation-proclamation/transcript.html https://avalon.law.yale.edu/medieval/magfr	3:05 PM · Oct 20, 2020 https://twitter.com/DarBenThu1/status/1318674731038515200
~0028	ACW 1861 1865 DOI 1776 unalienable	12:10 AM · Nov 2, 2020 https://twitter.com/DarBenThu1/status/1323160520933871616	American Revolutionary War, 1775-1783 https://en.wikipedia.org/wiki/American_Revolutionary_War Declaration of Independence, July 4, 1776 https://avalon.law.yale.edu/medieval/magframe.asp The ARW would-should have been lost Except for the Almighty-God-given 'UN- ALIEN- ABLE RIGHTS' -covenant to all of God's Negro-Ysrael on the land	3:13 PM · Oct 20, 2020 https://twitter.com/DarBenThu1/status/1318676729074909184

:Mark	:Matter	:Location	:Claim	:Facts	9 / 199
-------	---------	-----------	--------	--------	---------

2022-011769 MISC Page: 2592 of 2782
09/26/2022 03:35:37 PM Receipt #: 22-9381
Rec Fee: \$30.00 Darrell James Hill
Gila County, Az, Sadie Jo Bingham, Recorder



Handwritten mark resembling 'HSC' or similar.

~0029	Free Speech Donald John DOI 1776 Liberty Sessions USAG	12:19 AM · Nov 2, 2020 https://twitter.com/DarBenThu1/status/1323162898563170305	#PromotingFreeSpeechandReligiousLiberty2017 POTUS, -: Donald-John: Trump; Executive Order 13798 of May 4, 2017 Promoting Free Speech and Religious Liberty file:///tmp/mozilla_dj0/2017-09574.pdf US AG, -:Sessions file:///tmp/mozilla_dj0/2017-23269.pdf	https://t.co/K5XYyvJE77 #PromotingFreeSpeechandReligiousLiberty2017 POTUS, -: Donald-John: Trump; Executive Order 13798 of May 4, 2017 Promoting Free Speech and Religious Liberty file:///tmp/mozilla_dj0/2017-09574.pdf US AG, -:Sessions file:///tmp/mozilla_dj0/2017-23269.pdf
~0030	DOI 1776 EBA 1933	12:36 AM · Nov 2, 2020 https://twitter.com/DarBenThu1/status/1323167187574480897	#TheCftUSofA The Constitution for the United States of America covenant parameters SET between the people and the Almighty-God is the #DOI1776AD . After the war the Trustees ignored the covenant and enslaved :Negro-Ysrael, et seq., :in- dereliction through #EBA1933AD -Trust-2003	
~0031	Doctor welsing Will lynch letter slaves	1:49 AM · Nov 12, 2020 https://twitter.com/DarBenThu1/status/1326809272861122560	Waking-up is hard to do. Man-kind is oppressed by the heavy and cruel hand in TheUSofA for to sustain white-genetic-survival -- Dr. Welsing ~ https://twitter.com/DarBenThu1/status/1312100143219396608 ~' Yet, :we- are single-sourced 6,000 year-old progeny by DNA. So, what is white? Ans: Willie Lynch letter slave.	11:40 AM · Oct 2, 2020 https://twitter.com/DarBenThu1/status/1312100143219396608 Dr. Frances Cress Welsing - The Psychological Slavery of Black People in The Media
~0032	PTSD	2:11 AM · Nov 12, 2020	Healing the PTSD can be done. Start here:	https://twitter.com/DarBenThu1/status/

:Mark	:Matter	:Location	:Claim	:Facts 10 / 199
-------	---------	-----------	--------	-----------------

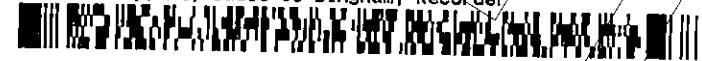

1287

		https://twitter.com/DarBenThu1/status/1326814871392985088	https://psyc.com.net/depression.central.grief.html . :- man got help with this:For Those Just Now Awakening http://annavonreitz.com/justnowawakening.pdf . From these and life :- man wrote this: ... My experience: Grief-Sheet jpg. :- man hope this can help you; soul- health matters	1326814871392985088/photo/1 Grief-Sheet jpg
~0033	Donald John Trump POTUS-Corp US-Corp Bill Remedy Cure Heal	12:51 AM · Nov 12, 2020 https://twitter.com/DarBenThu1/status/1326794848029040641	This @DarBenThu1 is for :remedy against theft by :Donald-John: Trump, :-POTUS-corp, :-Trustee, et al.-. These 'Bill of Particulars' rendered are required for the agreed-upon :penalty-compensation until the stolen property is restored :in- specie. See:	https://twitter.com/DarBenThu1/status/1326794848029040641 Bills of Lots 1, 2, 3 https://t.co/2RKWwGclOq
~0034	Bill	11:57 PM · Nov 13, 2020 https://twitter.com/DarBenThu1/status/1327505970839265281	The BORs, 'Bills of Particulars' changed. Here is second attempt: file:///tmp/mozilla_dj0/law-thou-shalt-not-steal.-final-twitter-blackout-2.pdf	https://twitter.com/DarBenThu1/status/1326794848029040641 Bills of Lots 1, 2, 3 https://t.co/2RKWwGclOq
~0035	Sublimus Dei Pope en-slave-ment	2:57 AM · Nov 18, 2020 https://twitter.com/DarBenThu1/status/1329000676769218562	"Sublimus Dei; On the Enslavement and Evangelization of Indians [and others] Pope Paul III - 1537 . " ...without exception..., are by no means to be deprived of their liberty or the possession of their property... ; nor should they be in any way enslaved"	https://twitter.com/DarBenThu1/status/1329000676769218562/photo/1
~0036	Army 1863 Francis Lieber	4:51 AM · Nov 18, 2020	... GOVERNMENT OF ARMIES OF THE [FEDERAL-] UNITED STATES IN THE FIELD: ... by Francis Lieber, ...	https://twitter.com/DarBenThu1/status/1329029446536347649/photo/1

:Mark	:Matter	:Location	:Claim	:Facts	11 / 199
-------	---------	-----------	--------	--------	----------

2022-011769 MISC Page: 2594 of 2782
 09/26/2022 03:35:37 PM Receipt #: 22-9391
 Rec Fee: \$30.00 Darrell James Hill
 Gila County, Az, Sadie Jo Bingham, Recorder



	General Orders No. 100	https://twitter.com/DarBenThu1/status/1329029446536347649	General Orders No. 100 by President Lincoln, 24 April 1863. Art. 45(b) "Prize money, whether on sea or land, can now only be claimed under local law." :- man -civilian -Ohioan.	https://twitter.com/DarBenThu1/status/1329029446536347649/photo/1
~0037	TWEA 1917 EBA 1933 Law-of-War	4:14 AM · Nov 19, 2020 https://twitter.com/DarBenThu1/status/1329382658070044672	American state citizens are owed all the protection of the Geneva Convention Protocols of 1949 -Anna Von Reitz, :Belcher-. Why? Because: 'American state citizens' - 'United States Citizens' are the :legalized- 'enemy' by the TWEA-1917, as amended: See: 1933 Emergency Banking Act.	
~0038	American State Country Man Sovereign Settlor Grantor TWEA 1917 1933 EBA enemy	4:14 AM · Nov 19, 2020 https://twitter.com/DarBenThu1/status/1329382658070044672	American state citizens are owed all the protection of the Geneva Convention Protocols of 1949 -Anna Von Reitz, :Belcher-. Why? Because: 'American state citizens' - 'United States Citizens' are the :legalized- 'enemy' by the TWEA-1917, as amended: See: 1933 Emergency Banking Act.	https://twitter.com/DarBenThu1/status/1329382658070044672/photo/1 https://twitter.com/DarBenThu1/status/1329382658070044672/photo/2
~0039	EP 1863 Law-of-War	1:42 PM · Nov 20, 2020 https://twitter.com/DarBenThu1/status/1329887907088220160	The Emancipation Proclamation of 1863 is active today with re: to the 2016- 2017- property claimed and possessed by :- man, not abandoned. - 5.17.4.1. -Pillage. DEPARTMENT OF DEFENSE 8:26 PM · Nov 23, 2020LAW OF WAR MANUAL Description of Changes Promulgated on May 31, 2016 https://dod.defense.gov/Portals/1/Docu	https://twitter.com/DarBenThu1/status/1329887907088220160/photo/1 https://twitter.com/DarBenThu1/status/1329887907088220160/photo/2 4:51 AM · Nov 18, 2020 https://twitter.com/DarBenThu1/status/1329029446536347649 General Orders No. 100 by President Lincoln,

:Mark	:Matter	:Location	:Claim	:Facts	12 / 199
-------	---------	-----------	--------	--------	----------



Handwritten signature or initials.

				24 April 1863.
~0040	Constitution Claims	5:22 PM · Nov 20, 2020 https://twitter.com/DarBenThu1/status/1329943250954686465	For the Three (3) Constitutions with the Transition incidents. Apply more.	https://twitter.com/DarBenThu1/status/1329943250954686465/photo/1 https://twitter.com/DarBenThu1/status/1329943250954686465/photo/2 3 Constitution-Gov Block-Chart
~0041	US-Corp EBA 1933 Dead-Trust Dry-Trust Lawful	8:26 PM · Nov 23, 2020 https://twitter.com/DarBenThu1/status/1331076820402257922	De-mo-crat-Re-pub-lic-an-...'UNITED-STATES-CORP'-private-gov-service-provider,-EBA-1933-2003-A.D.-Dry-Legislative-Trustee is derelict with the soulless- 'commercial' -public(-private)-policy over public-law. See: Authorization: 'Establish Lawful Government': man- money and laws	https://twitter.com/DarBenThu1/status/1331076820402257922/photo/1 https://twitter.com/DarBenThu1/status/1331076820402257922/photo/2 https://twitter.com/DarBenThu1/status/1331076820402257922/photo/3 https://twitter.com/DarBenThu1/status/1331076820402257922/photo/4
:Era 1 #Dec2020DarBenThu1		December	:Era 1 #Dec2020DarBenThu1	
~0042	Isaiah 58 Ephesians 6	12:38 PM · Dec 6, 2020 https://twitter.com/DarBenThu1/status/1335670034643894272	Will you stand in the gap too?; KJV: Isaiah 58; Ephesians 6? It starts here: https://twitter.com/DarBenThu1 . Your future is now.	https://twitter.com/haymarketbooks/status/1334195113694814209 Abolitionist John Brown was executed by the state of Virginia on December 2, 1859. https://twitter.com/haymarketbooks/status/

:Mark	:Matter	:Location	:Claim	:Facts	13 / 199
-------	---------	-----------	--------	--------	----------



Handwritten notes:
 2022
 9/26/22

:Mark	:Matter	:Location	:Claim	:Facts
				1334195113694814209/photo/1
~0043	Conusance Authorization RMN RE 322 387 616 US Lawful Kinsman-Redeemer Isaiah 58	<u>6:23 PM · Dec 11, 2020</u> https://twitter.com/DarBenThu1/status/1337568732005031937	:RIGHT OF :CONUSANCE ~USPS RMN RE 322 387 616 US...[:] :DEMAND: Authorization for the Restoration of the Lawful-Government. This is done as the 'kinsman-redeemer': Is. 58, et al. -- https://blackandbluesoulsmatter.wordpress.com/2020/12/12/ri g	<u>8:26 PM · Nov 23, 2020</u> https://twitter.com/DarBenThu1/status/1331076820402257922 De-mo-crat-Re-pub-lic-an-...'UNITED-STATES-CORP'-private-:gov.-service-provider,-:EBA-1933-2003-A.D.-Dry-Legislative-Trustee is derelict
~0044	Conusance Authorization RMN RE 322 387 616 US Lawful Kinsman-Redeemer Isaiah 58	<u>10:12 PM · Dec 11, 2020</u> https://twitter.com/DarBenThu1/status/1337626459741962240	:RIGHT OF :CONUSANCE ~USPS RMN RE 322 387 616 US...[:] :DEMAND: Authorization for the Restoration of the Lawful-Government. -- https://blackandbluesoulsmatter.wordpress.com/2020/12/12/ri g @mSidneyPowell1 #Republic @RealRLimbaugh @realDonaldTrump @Scavino45 @GenFlynn @LJinWood @KrakenWood	https://twitter.com/DarBenThu1/status/1337568732005031937/photo/1 https://twitter.com/DarBenThu1/status/1337568732005031937/photo/2 https://twitter.com/DarBenThu1/status/1337568732005031937/photo/3 https://twitter.com/DarBenThu1/status/1337568732005031937/photo/4
~0045	Conusance Authorization RMN RE 322 387 616 US Lawful Kinsman-Redeemer	<u>10:21 PM · Dec 11, 2020</u> https://twitter.com/DarBenThu1/status/	:RIGHT OF :CONUSANCE ~USPS RMN RE 322 387 616 US...[:] :DEMAND: Authorization for the Restoration of the Lawful-Government. --	<u>10:12 PM · Dec 11, 2020</u> https://twitter.com/DarBenThu1/status/

0832
 0832
 0832

	Isaiah 58	1337628659834789888	https://blackandbluesoulsmatter.wordpress.com/2020/12/12/ri g @HIT_Evidence @DrPaulGosar @AZGOP @anonpatriotq @blckriflecoffee @15poundstogo @propublica @Barnes_Law @Snowden @wikileaks	1337626459741962240
~0046	Conusance Authorization RMN RE 322 387 616 US Lawful Kinsman-Redeemer Isaiah 58	10:31 PM · Dec 11, 2020 https://twitter.com/DarBenThu1/status/1337631074281684996	:RIGHT OF :CONUSANCE -USPS RMN RE 322 387 616 US...[:] :DEMAND: Authorization for the Restoration of the Lawful-Government. -- https://blackandbluesoulsmatter.wordpress.com/2020/12/12/ri g @UNHumanRights @NLatUN @UNTreatyBodies @BerniceKing @OHCHR_EARO @womensmarchgbal @FemiOke @UNHumanRightsUA @UN_CMW	10:12 PM · Dec 11, 2020 https://twitter.com/DarBenThu1/status/1337626459741962240
~0047	Conusance Authorization RMN RE 322 387 616 US Lawful Kinsman-Redeemer Isaiah 58	10:36 PM · Dec 11, 2020 https://twitter.com/DarBenThu1/status/13376324445877735424	:RIGHT OF :CONUSANCE -USPS RMN RE 322 387 616 US...[:] :DEMAND: Authorization for the Restoration of the Lawful-Government. -- https://blackandbluesoulsmatter.wordpress.com/2020/12/12/ri g @LtGovHusted @GovMikeDeWine @Ohio_Trucking @OhioEggFarmers @Ohio_Cattlemen @AGCOhio @AUSAorg @OhioPoliticsNow @POTUS	10:12 PM · Dec 11, 2020 https://twitter.com/DarBenThu1/status/1337626459741962240
~0048	Conusance Authorization RMN RE 322 387 616 US Lawful Kinsman-Redeemer Isaiah 58	10:41 PM · Dec 11, 2020 https://twitter.com/DarBenThu1/status/1337633607737753600/analytics	:RIGHT OF :CONUSANCE -USPS RMN RE 322 387 616 US...[:] :DEMAND: Authorization for the Restoration of the Lawful-Government. -- https://blackandbluesoulsmatter.wordpress.com/2020/12/12/ri g @H2Ohio @OHOMFG @DaytonChildrens @OHSupremeCourt @washingtonpost @FLOTUS	10:12 PM · Dec 11, 2020 https://twitter.com/DarBenThu1/status/1337626459741962240

:Mark	:Matter	:Location	:Claim	:Facts	15 / 199
-------	---------	-----------	--------	--------	----------



oct

:Two-Year-Review :Dar-Ben-Thu: Hill ~www.twitter.com/DarBenThu1~ -Authority
https://twitter.com/hashtag/darbenthu1September222020?src=hashtag_click
:DarBenThu1 -Box-Graph: #September2020AD > #August2022AD

			@Ohio_OBM @SinclairCC @NatGovsAssoc	
~0049	Conusance Authorization RMN RE 322 387 616 US Lawful Kinsman-Redeemer Isaiah 58	10:46 PM · Dec 11, 2020 https://twitter.com/DarBenThu1/status/1337635036930035713	:RIGHT OF :CONUSANCE ~USPS RMN RE 322 387 616 US...[:] :DEMAND: Authorization for the Restoration of the Lawful-Government. -- https://blackandbluesoulsmatter.wordpress.com/2020/12/12/right-at-farmer-justice/ @BfarmerJustice1 @JhishawEsq @shearm @shawnsebastian @HEAL_Food @NBFJA @navinakhanna @michaelharriot @RyanLizza	10:12 PM · Dec 11, 2020 https://twitter.com/DarBenThu1/status/1337626459741962240
~0050	Conusance Authorization RMN RE 322 387 616 US Lawful Kinsman-Redeemer Isaiah 58	10:51 PM · Dec 11, 2020 https://twitter.com/DarBenThu1/status/1337636115453337601	:RIGHT OF :CONUSANCE ~USPS RMN RE 322 387 616 US...[:] :DEMAND: Authorization for the Restoration of the Lawful-Government. -- https://blackandbluesoulsmatter.wordpress.com/2020/12/12/right-at-btfa-za/ @BTFA_ZA @DrTurleyTalks @AnnMorrison3 #Truth #GreatAwakening #MAGA #KAG #FIGHTBACK	10:12 PM · Dec 11, 2020 https://twitter.com/DarBenThu1/status/1337626459741962240
~0051	ACW 1861 Troops Civilians Slaves Colored Dead Disease Wounded Casualties	9:20 PM · Dec 12, 2020 https://twitter.com/DarBenThu1/status/1337975657502887938	United States Colored Troops 1863 January 1	https://twitter.com/DarBenThu1/status/1337975657502887938/photo/1
~0052	Bill US-Corp POTUS Trustee	3:49 PM · Dec 13, 2020 https://twitter.com/DarBenThu1/status/1338254712575991808	Please see into this for @DarBenThu1 @AOC @AndreaSCousins @francescamari @ronmknox @byHeatherLong @JenniferJJacobs @perrybaconjr @DrJasonJohnson @HexPositive	12:51 AM · Nov 12, 2020 https://twitter.com/DarBenThu1/status/1326794848029040641

:Mark	:Matter	:Location	:Claim	:Facts	16 / 199
-------	---------	-----------	--------	--------	----------

			<p><u>@_CharlesPreston</u></p> <p>This <u>@DarBenThu1</u></p> <p>is for :remedy against theft by :Donald-John: Trump, -:POTUS-corp, -:Trustee, et al.-. These 'Bill of Particulars' rendered are required for the agreed-upon :penalty-compensation until the stolen property is restored :in- specie. See:</p>	<p>See:https://blackandbluesoulsmatter.wordpress.com/2020/11/12/bill-of-particulars-lot-1-2-and-3-of-3-rendered-to-donald-john-trump-due-paid-now/</p>
~0053	See DarBenThu1	<p><u>3:49 PM · Dec 13, 2020</u></p> <p>https://twitter.com/DarBenThu1/status/1338254712575991808</p>	<p>Please see into this for <u>@DarBenThu1</u></p>	<p><u>12:51 AM · Nov 12, 2020</u></p> <p>https://twitter.com/DarBenThu1/status/1326794848029040641</p>
~0054	See DarBenThu1	<p><u>3:56 PM · Dec 13, 2020</u></p> <p>https://twitter.com/DarBenThu1/status/1338256605817630724</p>	<p>Please see into this for <u>@DarBenThu1</u></p> <p><u>@frankpavone @Txejd @TeresaRoeloffs @jese @MandyP15575406 @MikeGreerofCU @ElaineBassill @gmaitthree @JerusalemJones</u></p>	<p><u>12:51 AM · Nov 12, 2020</u></p> <p>https://twitter.com/DarBenThu1/status/1326794848029040641</p>
~0055	See DarBenThu1	<p><u>4:08 PM · Dec 13, 2020</u></p> <p>https://twitter.com/DarBenThu1/status/1338259604514381824</p>	<p>Please see into this for <u>@DarBenThu1</u></p> <p><u>@wambuizonzo @_MeganPowers @ShaneWenzel @pelchat_gerald @ScottMinerd @cjtruth @Mbali_porsh @oceht @Breaker1111Girl @RebeccaHahn @boldmovesdiary @sisterkellyjo @Cmartingano @BraudrickF</u></p>	<p><u>12:51 AM · Nov 12, 2020</u></p> <p>https://twitter.com/DarBenThu1/status/1326794848029040641</p>

:Mark	:Matter	:Location	:Claim	:Facts	17 / 199
-------	---------	-----------	--------	--------	----------

			@benshapiro @Truth_Person	
~0056	See DarBenThu1	4:16 PM · Dec 13, 2020 https://twitter.com/DarBenThu1/status/1338261496489361409	Please see into this for @DarBenThu1 @ProjectLincoln @donlemon @JoyVBehar @sunny @JoeBiden @DrEricDing @GeoRebekah @TheView @chrislhayes @amjoyshow @maddow @JoyAnnReid @wsvn @nytimes @erikfinman @csdoctorsister	12:51 AM · Nov 12, 2020 https://twitter.com/DarBenThu1/status/1326794848029040641
~0057	See DarBenThu1	4:30 PM · Dec 13, 2020 https://twitter.com/DarBenThu1/status/1338265120619646977	Please see into this for @DarBenThu1 @HouseDailyPress @CNNPolitics @latimespolitics @stateoftheryan @KrisB_Brown @AyannaPressley @NPR @DukeMargolis @AdelleNaz@shaunasanford @wandavazquezg @RamonaWritesLA @BrookingsInst @timcraigpost @ASAEcenter	12:51 AM · Nov 12, 2020 https://twitter.com/DarBenThu1/status/1326794848029040641
~0058	See DarBenThu1	4:39 PM · Dec 13, 2020 https://twitter.com/DarBenThu1/status/1338267307542421505	Please see into this for: @DarBenThu1 @ThePlumLineGS @CivilWarTimes @EmergingCWBlog @CivilWarMonitor @hfarmmuseum @TheUSCivilWar @CaptAndrewLuck @kurtluther @CharmedMagnolia @FortNegley @KentuckyCW @the_allm@USGrantLibrary @2ndMDCOA @CWPhotoSleuth @Jgiesberg @JCWE1	12:51 AM · Nov 12, 2020 https://twitter.com/DarBenThu1/status/1326794848029040641
~0059	Please Help See DarBenThu1	5:09 PM · Dec 13, 2020 https://twitter.com/	Please Help With This For: @DarBenThu1 @DiamondandSilk @chrispavlovski @newsmax	12:51 AM · Nov 12, 2020 https://twitter.com/DarBenThu1/status/

:Mark	:Matter	:Location	:Claim	:Facts	18 / 199
-------	---------	-----------	--------	--------	----------



0621

:Two-Year-Review :Dar-Ben-Thu: Hill ~www.twitter.com/DarBenThu1~ -Authority

https://twitter.com/hashtag/darbenthu1September222020?src=hashtag_click

:DarBenThu1 -Box-Graph: #September2020AD > #August2022AD

		DarBenThu1/status/1338274928433381376	@DanForestNC @ChatDitPlatform@SecretaryCarson @RudyGiuliani @PressSec @JudgeJeanine @MariaBartiromo @MariaBartiromo @TrumpGolf @mschlapp @BlackVoices4DJT @WhiteHouse @pnjaban@TomFitton	1326794848029040641 https://blackandbluesoulsmatter.wordpress.com/2020/11/12/bill-of-particulars-lot-1-2-and-3-of-3-rendered-to-donald-john-trump-due-paid-now/
-0060	Please Help See DarBenThu1	5:12 PM · Dec 13, 2020 https://twitter.com/DarBenThu1/status/1338275662231031811	Please Help With This For: @DarBenThu1 @kimguilfoyle @WomenforTrump @GovMikeHuckabee @JoeTalkShow @dbongino @POTUS @Mike_Pence @RSBNetwork @EricTrump @DonaldJTrumpJr @EricTrump @MELANIATRUMP @IvankaTrump @realDonaldTrump @ChatDitPlatform @SecretaryCarson @RudyGiuliani @PressSec	12:51 AM · Nov 12, 2020 https://twitter.com/DarBenThu1/status/1326794848029040641 https://blackandbluesoulsmatter.wordpress.com/2020/11/12/bill-of-particulars-lot-1-2-and-3-of-3-rendered-to-donald-john-trump-due-paid-now/
-0061	Doctor Arikan Chihombori Diaspora Africa	2:38 AM · Dec 14, 2020 https://twitter.com/DarBenThu1/status/1338418058981871616	You've got to here this: Powerful speech by Dr. Arikana Chihombori to Africans (African Diaspora Media and Content Creators)	https://youtu.be/EpTgdoO46Zl
-0062	Timothy E McPherson Lumi Africa Debt	3:50 AM · Dec 14, 2020 https://twitter.com/DarBenThu1/status/1338436125027753985	You've Got to hear this: Timothy E. McPherson on the new currency -the Lumi- and elimination of Debt in Africa	https://youtu.be/w6FRlpSXJEY

:Mark	:Matter	:Location	:Claim	:Facts	19 / 199
-------	---------	-----------	--------	--------	----------



:Two-Year-Review :Dar-Ben-Thu: Hill ~www.twitter.com/DarBenThu1~ -Authority

https://twitter.com/hashtag/darbenthu1September222020?src=hashtag_click

:DarBenThu1 -Box-Graph: #September2020AD > #August2022AD

~0063	William Pelham Barr	11:30 PM · Dec 14, 2020 https://twitter.com/DarBenThu1/status/1338733177045585921	For the tough job with allegiance mix :William-Pelham. Thank-you. Shalom. https://twitter.com/realDonaldTrump	This Tweet is from a suspended account. https://twitter.com/realDonaldTrump/status/1338614514493878273
~0064	Barr Judge USAG	9:16 AM · Dec 15, 2020 https://twitter.com/DarBenThu1/status/1338880651240431616	You've gotta hear this judge detail USAG Barr's doings Judge Jeanine rips Bill Barr a New One	https://youtu.be/bS9zhXygp2U
~0065	Pompeo CCP	12:58 AM · Dec 16, 2020 https://twitter.com/DarBenThu1/status/1339117777857089537	You gotta hear :Michael Richard Pompeo -- BREAKING NEWS/TODAY: THIS IS TRAGEDY ~The CCP wants what we have by any means~	https://youtu.be/lf_Ght_rsmg https://youtu.be/lf_Ght_rsmg?t=6
~0066	Mario Jorge Bergoglio Roman Church Pope	6:19 PM · Dec 21, 2020 https://twitter.com/DarBenThu1/status/1341191607475834880	@WomenforTrump @dbongino @POTUS @Mike_Pence @RSBNetwork @DonaldJTrumpJr @EricTrump @MELANIATRUMP @IvankaTrump @realDonaldTrump @PressSec Mario-Jorge: Bergoglio is the pope and potentate over the 'Roman'- X-etc.; not over the 'Holy-Church' -":Christians"/Ysrael. :Darrell-James.	9:41 AM · Dec 22, 2020 https://twitter.com/DarBenThu1/status/1341423528621481984
~0067	Roman Church Pope Trustee Failure	9:41 AM · Dec 22, 2020 https://twitter.com/	1) The :man- Mario-Jorge: Bergoglio is no longer the Trustee: Concession-1213-A.D. 2) There is no 'vicar' of Yushuah the Messiah, Creator, who died for man-kind. 3) Roman-	

:Mark	:Matter	:Location	:Claim	:Facts 20 / 199
-------	---------	-----------	--------	-----------------

2022-011769 MISC Page: 2603 of 2782

09/26/2022 03:35:37 PM Receipt #: 22-9381
Rec Fee: \$30.00 Darrell James Hill
Gila County, Az, Sadie Jo Bingham, Recorder



	Concession 1213 Almighty-God-Yushuah	DarBenThu1/status/1341423528621481984	X(=anything) is a proprietary-doctrine, and 4) is Not synonymous with :Almighty-God's will. Really! Ask God	
~0068	Donald John China People	12:21 PM · Dec 22, 2020 https://twitter.com/DarBenThu1/status/1341463972541677570	@WomenforTrump @dbongino @POTUS @Mike_Pence @RSBNetwork @DonaldJTrumpJr @EricTrump @MELANIATRUMP @IvankaTrump @realDonaldTrump @PressSec Hello :Donald-John. :i- man am grieving for the people of China; NOT CCP- focused. If you can help feed them it will matter; if you can, do.	12:27 PM · Dec 22, 2020 https://twitter.com/DarBenThu1/status/1341465488874897410
~0069	Covid C-19 Virus Crisis Food	12:27:PM · Dec 22, 2020 https://twitter.com/DarBenThu1/status/1341465488874897410	China's Food Crisis https://youtube.com/watch?v=XQ-XIbDqKAA Please do not allow the extreme starvation to recur. We both know they did not synthesize the C-19 virus alone. And, value for the people can only come from you now. Make this humility :count, and save face please.	https://youtube.com/watch?v=XQ-XIbDqKAA
~0070	Shoun Hill Freedom protection pay Troops Colored Men	2:58 PM · Dec 23, 2020 https://twitter.com/DarBenThu1/status/1341865735769870336	You gotta see the flavor of this 2" short: Long-Trailer2-Layman Title from from 'shoun hill' ~ https://twitter.com/search?q=shoun%20hill&src=typed_query https://vimeo.com/482194791 ~	https://t.co/pZ1xpfgekJ Black Farmers Fight Against USDA 4:39 PM · Dec 13, 2020 https://twitter.com/DarBenThu1/status/1338267307542421505
~0071	Doctor Moore C-19 Covid dies	10:13 AM · Dec 24, 2020	Black Doctor Dies of Covid-19 After Complaining of Racist Treatment https://nytimes.com/2020/12/23/us/susan-moore-black-doctor-indiana.html?smid=tw-share "If you want to fight,	https://nytimes.com/2020/12/23/us/susan-moore-black-doctor-indiana.html?smid=tw-share

:Mark	:Matter	:Location	:Claim	:Facts	21 / 199
-------	---------	-----------	--------	--------	----------



	Indiana	https://twitter.com/DarBenThu1/status/1342156419244539904	now is the time to fight," he recalled telling her. "But if you need to go, I understand." Two days later, Dr. Moore's heart stopped beating.	
~0072	Chip Vaccine Coronavirus	7:42 PM · Dec 26, 2020 https://twitter.com/DarBenThu1/status/1343024544651509761	Is this really happening? 'gotta know this too! March 2020. APIJECT - THE COMP THAT VACS AND CHIPS YOU. Will They Put a CHIP in the Coronavirus Vaccine? https://youtube.com/watch?v=IGJjE6	https://www.youtube.com/watch?v=IGJjE6a0Nxc
~0073	Twitter, Facebook, Zoom	9:32 PM · Dec 26, 2020 https://twitter.com/DarBenThu1/status/1343052122602934272	Did you get paid? Zoom shared US user data with Beijing! https://youtube.com/watch?v=KKGyL7ZzZbw And, more pestilences....	https://youtube.com/watch?v=KKGyL7ZzZbw
~0074	ICCPR Self-Executing Non-Self-Executing unalienable law	7:59 PM · Dec 30, 2020 https://twitter.com/DarBenThu1/status/1344478131109806080	'Gotta know about this door! Re: ICCPR: '-Non-self-executing' Unalienable-Rights- DOOR! Law: http://asil.org/benchbook . -> p: I. C-1 C. Uses of International Law in U.S. Courts 1. Direct Enforcement of Treaty Provisions 2. Statutory Implementation or Incorp of International Law	
:Era 1 #Jan2021DarBenThu1		January 2022	:Era 1 #Jan2021DarBenThu1	
~0075	Abraham Lincoln Donald John PFTUSA March 04 1861	6:15 PM · Jan 15, 2021 https://twitter.com/DarBenThu1/status/1350250374582525955	Abraham Lincoln the 16th PFTUSA on Monday, March 4, 1861, at East Portico -United States Capitol Washington, Dist of Columbia. Donald-John, you are the PFTUSA until March 4, 1861 A.D. for a reason. Please not make that :-i- man must suit for	4:51 AM · Nov 18, 2020 https://twitter.com/DarBenThu1/status/1329029446536347649 General Orders No. 100 by President Lincoln,

:Mark	:Matter	:Location	:Claim	:Facts	22 / 199
-------	---------	-----------	--------	--------	----------

2022-011769 MISC Page: 2605 of 2782
 09/26/2022 03:35:37 PM Receipt #: 22-9381
 Rec Fee: \$30.00 Darrell James Hill
 Gila County, Az, Sadie Jo Bingham, Recorder



			remedy!	<p align="right">24 April 1863.</p> <p>8:26 PM · Nov 23, 2020</p> <p align="center">https://twitter.com/DarBenThu1/status/1331076820402257922</p> <p>De-mo-crat-Re-pub-lic-an-...'UNITED-STATES-CORP'-private-:gov.-service-provider,-:EBA-1933-2003-A.D.-Dry-Legislative-Trustee is derelict with the soulless- 'commercial' -public(-private)-policy over public-law. See: Authorization: 'Establish Lawful Government': man- money and laws.</p>
-0076	ICCPR Unalienable	<p>7:54 AM · Jan 1, 2021</p> <p>https://twitter.com/DarBenThu1/status/1345020463903170562</p>	Gotta get to know this!...? e.g., your "unalienable rights" = Decl of Indep for 'man'? So, how? Ans. MUST 'execute' THE 'ICCPR', i.e., state the claim to ID your rights. Yep. Really. America Natural Common Rights what is transpiring with the Government	<p>https://youtu.be/TgsuFEnKOWU</p> <p>America Natural Common Rights-ICCPR:UN</p>
-0077	DOI AOC BOR CftUSofA Amendment IX Amendment X	<p>8:04 AM · Jan 1, 2021</p> <p>https://twitter.com/DarBenThu1/status/1345023086370856960</p>	<p>1- DOI-1776-A.D. is the law for man.</p> <p>2- AOC-1777-A.D. is the law for states, and:</p> <p>3- TheCftUSofA-1787-91 is the law for government FOR THE PEOPLE. So, man has DOI- rights; and, :rights, -not given! are PROTECTED by TheCftUSofA.</p> <p>See- e.g.; BOR- Amend 9, 10. Yeah, ... me either!</p>	<p>:America-Common-Law-Rights: DOI-1776-AD is :USofA-1776-AD-People and :Almighty-God - Covenantors by the DOI-1776-AD -Covenant</p>

:Mark	:Matter	:Location	:Claim	:Facts	23 / 199
-------	---------	-----------	--------	--------	----------

2022-011769 MISC Page: 2606 of 2782
 09/26/2022 03:35:37 PM Receipt #: 22-9381
 Rec Fee: \$30.00 Darrell James Hill
 Gila County, Az, Sadie Jo Bingham, Recorder



-0078	ICCPR US Law Common law CL Rights: US Rights: DOI	1:09 PM · Jan 1, 2021 https://twitter.com/DarBenThu1/status/1345099879106846720	Here is the walk throught by http://eternallyaware.com discussing the nexus betwn ICCPR and US Law. United States Court Common Law Rights https://youtube.com/watch?v=6pjzgp	https://twitter.com/DarBenThu1/status/1345023086370856960 1- DOI-1776-A.D. is the law for man. 2- AOC-1777-A.D. is the law for states, and: 3- TheCftUSofA-1787-91 is the law for government FOR THE PEOPLE. So, man has DOI- rights; and, :rights, -not given! are PROTECTED by TheCftUSofA. See- e.g.; BOR- Amend 9, 10. Yeah, ... me either!
-0079	Doctor Susan Moore Indiana Neglect	2:24 PM · Jan 1, 2021 https://twitter.com/DarBenThu1/status/1345118650072592384	Wow guys. We gotta know this is REAL. Dr Susan Moore Last Words Before Dying From CQVID and Neglect https://youtube.com/watch?v=XpLbHAcTpTw So, ... what?!	10:13 AM · Dec 24, 2020 https://twitter.com/DarBenThu1/status/1342156419244539904 Black Doctor Dies of Covid-19 After Complaining of Racist Treatment https://nytimes.com/2020/12/23/us/susan-moore-black-doctor-indiana.html?smid=tw-share "If you want to fight, now is the time to fight," he recalled telling her. "But if you need to go, I understand." Two days later, Dr. Moore's heart stopped beating.
-0080	Kiyosaki	2:53 AM · Jan 3, 2021	Ya' gotta hear this new gen(s)! BUT! hold on! -- Kiyosaki (speaker) is NOT a Yes man! We/you have been \$-rape-robbed! "It's All A SMOKESCREEN"	https://youtube.com/watch?v=imJw2v "It's All A SMOKESCREEN"

:Mark	:Matter	:Location	:Claim	:Facts
-------	---------	-----------	--------	--------



		https://twitter.com/DarBenThu1/status/1345669671186432000	https://youtube.com/watch?v=imJw2v	
-0081	Stand Chadwick Boseman	3:09 AM · Jan 3, 2021 https://twitter.com/DarBenThu1/status/1345673590453067777	Abba, wants this said: IF you STAND, it Will Cost you EVERYTHING!; so,,,, STAND!! -- Gotta' Shema this: Chadwick Boseman's Life Advice Will Leave You SPEECHLESS https://youtube.com/watch?v=x9QwLZEqumA	https://www.youtube.com/watch?v=x9QwLZEqumA It cost me Everything, :Chadwick: Boseman
-0082	Chadwick Boseman Abba Stand Cost speechless Everything	3:09 AM · Jan 3, 2021 https://twitter.com/DarBenThu1/status/1345673590453067777	Abba, wants this said: IF you STAND, it Will Cost you EVERYTHING!; so,,,, STAND!! -- Gotta' Shema this: Chadwick Boseman's Life Advice Will Leave You SPEECHLESS https://youtube.com/watch?v=x9QwLZEqumA	https://www.youtube.com/watch?v=x9QwLZEqumA It cost me Everything, :Chadwick: Boseman
-0083	Abraham Lincoln Donald John PFTUSA March 04 1861	6:12 PM · Jan 15, 2021 https://twitter.com/DarBenThu1/status/1350249457011499010	Abraham Lincoln the 16th PFTUSA on Monday, March 4, 1861, at East Portico -United States Capitol Washington, Dist of Columbia. Donald-John, you are the PFTUSA until March 4, 1861 A.D. for a reason. <u>Please not make that i- man must suit for remedy!</u>	8:26 PM · Nov 23, 2020 https://twitter.com/DarBenThu1/status/1331076820402257922 De-mo-crat-Re-pub-lic-an-...'UNITED-STATES-CORP'-private-:gov.-service-provider,-:EBA-1933-2003-A.D.-Dry-Legislative-Trustee is derelict with the souless- 'commercial' -public(-private)-policy over public-law. See: Authorization: 'Establish Lawful Government': man- money and laws
-0084	Abraham Lincoln	6:15 PM · Jan 15, 2021	Abraham Lincoln the 16th PFTUSA on Monday, March 4,	8:26 PM · Nov 23, 2020

:Mark	:Matter	:Location	:Claim	:Facts	25 / 199
-------	---------	-----------	--------	--------	----------



	Donald John PFTUSA March 04 1861	https://twitter.com/DarBenThu1/status/1350250374582525955	1861, at East Portico -United States Capitol Washington, Dist of Columbia. Donald-John, you are the PFTUSA until March 4, 1861 A.D. for a reason. Please not make that :i- man must suit for remedy!	https://twitter.com/DarBenThu1/status/1331076820402257922
~0085		8:04 AM · Jan 1, 2021 https://twitter.com/DarBenThu1/status/1345023086370856960	1- DOI-1776-A.D. is the law for man. 2- AOC-1777-A.D. is the law for states, and: 3- TheCftUSofA-1787-91 is the law for government FOR THE PEOPLE. So, man has DOI- rights; and, :rights, -not given! are PROTECTED by TheCftUSofA. See- e.g.; BOR-Amend 9, 10. Yeah, ... me either!	7:54 AM · Jan 1, 2021 https://twitter.com/DarBenThu1/status/1345020463903170562 America Natural Common Rights what is transpiring with the Government
~0086	For the Trustee-failiure is with the Voidance of the beneficiary-benefit	8:34 PM · Jan 15, 2021 https://twitter.com/DarBenThu1/status/1350285356516605954	'been four years; :i- man wish to resolve the 'voidance-of-benefit' -/stolen-property matter :in- non-controversy, :in-procuration ~i.e., to act :in-honor as would the Respondent-for to execute the right-to-remedy :in- accordance with the prevailing-covenant-agreements. Yeah...	https://twitter.com/DarBenThu1/status/1350285356516605954/photo/1 https://twitter.com/DarBenThu1/status/1350285356516605954/photo/2 https://twitter.com/DarBenThu1/status/1350285356516605954/photo/3 https://twitter.com/DarBenThu1/status/1350285356516605954/photo/4
~0087	For the Trustee-failiure is with the Voidance of the beneficiary-benefit	8:34 PM · Jan 15, 2021 https://twitter.com/DarBenThu1/status/		Twited second-time-gain

:Mark	:Matter	:Location	:Claim	:Facts	26 / 199
-------	---------	-----------	--------	--------	----------



		1350285356516605954		
-0088	Ambassadors Carter Conlon Suicide	5:47 PM · Jan 20, 2021 https://twitter.com/DarBenThu1/status/1352055110004686852	Ambassadors of The Power of God by Carter Conlon https://youtube.com/watch?v=K1gAgZZ4xzQ Against the spirit of suicide. Shalom.	https://youtube.com/watch?v=K1gAgZZ4xzQ Ambassadors of The Power of God Against the spirit of suicide
-0089		5:26 AM · Jan 23, 2021 https://twitter.com/DarBenThu1/status/1352955745881341953	'ya gotta shema (hebrew: see, read, do) this. Why? b/c :this, violation of the :denial of :unalienable, -:constitutionally-protected-right(s). Trustee- 'policy' to deny beneficiary :ALL/ ANY- rights !' Not repub or dem - slave- whatever..... :- man ain't making this up!	https://twitter.com/DarBenThu1/status/1352955745881341953/photo/1 https://twitter.com/DarBenThu1/status/1352955745881341953/photo/1 https://twitter.com/DarBenThu1/status/1352955745881341953/photo/1 https://twitter.com/DarBenThu1/status/1352955745881341953/photo/1
-0090	Enforcement 1870 Civil-Rights Ku klux klan 16 Stat 140	6:31 AM · Jan 26, 2021 https://twitter.com/DarBenThu1/status/1354059272716316673	Did you know that :this "Enforcement Act of 1870 - https://en.wikipedia.org/wiki/Enforcement_Act_of_1870 Civil Rights Act of 1870 or First Ku Klux Klan Act, or Force Act (41st Congress, Sess. 2, ch. 114, 16 Stat. 140, enacted May 31, 1870" is STILL THE LAW?! 151 years' past.	https://en.wikipedia.org/wiki/Enforcement_Act_of_1870
-0091	Democracy Despotism	3:11 AM · Jan 29, 2021 https://twitter.com/DarBenThu1/status/1354059272716316673	May you be blessed to catch this. Share what you comprehend and think. Shalom. Democracy https://ia800708.us.archive.org/2/items/democracy_1945/democracy_1945_512kb.mp4 (https://ia800708.us.archive.org/2/items/democracy_1945/democracy_1945_512kb.mp4

:Mark	:Matter	:Location	:Claim	:Facts	27 / 199
-------	---------	-----------	--------	--------	----------

		1355096333422448640	https://archive.org/details/democracy_1945) Despotism https://ia800308.us.archive.org/30/items/Despotis1946/Despotis1946_512kb.mp4 (https://archive.org/details/Despotis1946)	https://archive.org/details/democracy_1945 https://ia800308.us.archive.org/30/items/Despotis1946/Despotis1946_512kb.mp4 https://archive.org/details/Despotis1946
-0092		7:50 PM · Jan 29, 2021 https://twitter.com/DarBenThu1/status/1355347713567588353	This :entry is the :pdf-'claim' for :property-stolen sent to addressees 01/15/2021 Friday~ https://blackandbluesoulsmatter.files.wordpress.com/2021/01/claim-to-court-all.pdf This is the Letter to Joseph-Robinette, et al.- man-actgors with, claim was attached, sent 01/28/2021~ https://blackandbluesoulsmatter.files.wordpress.com/2021/01/2021-jan-26-ltr-to-potus-6-done-all-mailg.pdf ~ to enable their righteous- honor.	5:26 AM · Jan 23, 2021 https://twitter.com/DarBenThu1/status/1352955745881341953 https://twitter.com/DarBenThu1/status/1352955745881341953/photo/1 https://twitter.com/DarBenThu1/status/1352955745881341953/photo/1 https://twitter.com/DarBenThu1/status/1352955745881341953/photo/1 https://twitter.com/DarBenThu1/status/1352955745881341953/photo/1
-0093	Property Stolen Joseph Robinette	7:50 PM · Jan 29, 2021 https://twitter.com/DarBenThu1/status/1355347713567588353	This :entry is the :pdf-'claim' for :property-stolen sent to addressees 01/15/2021 Friday~ https://blackandbluesoulsmatter.files.wordpress.com/2021/01/claim-to-court-all.pdf	5:26 AM · Jan 23, 2021 https://twitter.com/DarBenThu1/status/1352955745881341953 https://

:Mark	:Matter	:Location	:Claim	:Facts	28 / 199
-------	---------	-----------	--------	--------	----------

2022-011769 MISC Page: 2611 of 2782
 09/26/2022 03:35:37 PM Receipt #: 22-9381
 Rec Fee: \$30.00 Darrell James Hill
 Gila County, Az, Sadie Jo Bingham, Recorder



			This is the Letter to Joseph-Robinette, et al.- man-actors with, claim was attached, sent 01/28/2021~ https://blackandbluesoulsmatter.files.wordpress.com/2021/01/2021-jan-26-ltr-to-potus-6-done-all-mailg.pdf ~ to enable their righteous- honor.	blackandbluesoulsmatter.files.wordpress.com/2021/01/claim-to-court-all.pdf https://blackandbluesoulsmatter.files.wordpress.com/2021/01/2021-jan-26-ltr-to-potus-6-done-all-mailg.pdf
-0094	Claim property maricopa clerk POTUS	8:20 PM · Jan 29, 2021 https://twitter.com/DarBenThu1/status/1355355231895228418	01-15-2021 :claim/property https://blackandbluesoulsmatteto-court-all.pdf 01-19-2021 :Maricopa- clerk denies court access. 01-22-2021 :Letter to Maricopa court 01-28-2021 :claim to Joseph-Robinette, et al., :POTUS, et al.	https://blackandbluesoulsmatter.files.wordpress.com/2021/01/2021-jan-26-ltr-to-potus-6-done-all-mailg.pdf
-0095	Claim property maricopa clerk POTUS	8:20 PM · Jan 29, 2021 https://twitter.com/DarBenThu1/status/1355355231895228418	https://blackandbluesoulsmatter.files.wordpress.com/2021/01/2021-jan-26-ltr-to-potus-6-done-all-mailg.pdf	
-0096	2016 Barack Obama Loretta Lynch Lack-of-Honor Joseph Robinette	9:55 PM · Jan 29, 2021 https://twitter.com/DarBenThu1/status/1355378958347325444	@matthewpagano @tomhals @elianayjohnson @JeremiahWillet @DE_DOJ @jeremiahcota @kokanovich @Fabian_Estrada @Jennifer_Fox10 @yasminv This is the follow-up. Starting in 2016 A.D. Barack & Loretta to Donald-John: Trump unto dishonor/theft. Now, is Joseph-R: in honor or dishonor?	8:20 PM · Jan 29, 2021 https://twitter.com/DarBenThu1/status/1355355231895228418 01-15-2021 :claim/property https://blackandbluesoulsmatteto-court-all.pdf 01-19-2021 :Maricopa- clerk denies court

:Mark	:Matter	:Location	:Claim	:Page 29 / 199
-------	---------	-----------	--------	----------------



				access. 01-22-2021 :Letter to Maricopa court 01-28-2021 :claim to Joseph-Robinette, et al., :POTUS, et al. – https://blackandbluesoulsmatter.files.wordpress.com/2021/01/2021-jan-26-ltr-to-potus-6-done-all-mailg.pdf
~0097	Claim Property Maricopa Court Joseph Robinette	1:04 PM · Jan 31, 2021 https://twitter.com/DarBenThu1/status/1355970317026398210	01-15-2021 :claim/property https://blackandbluesoulsmatter.files.wordpress.com/2021/01/claim-to-court-all.pdf Maricopa- clerk denies court access. 01-28-2021 :Letter to Maricopa court 01-28-2021 :claim to Joseph-Robinette, et al., :POTUS, et al. – https://blackandbluesoulsmatter.files.wordpress.com/2021/01/2021-j	https://blackandbluesoulsmatter.files.wordpress.com/2021/01/claim-to-court-all.pdf https://blackandbluesoulsmatter.files.wordpress.com/2021/01/2021-j
~0098	Russians	2:01 PM · Jan 31, 2021 https://twitter.com/DarBenThu1/status/1355984544705310722	You day cometh. Thousands of Russians take to streets to demand release of jailed opposition leader	https://youtu.be/b3-gE27Z7s8 Russian support for Alexei Navlny
:Era 1 #Feb2021DarBenThu1			:Era 1 #Feb2021DarBenThu1	
~0099	Crystal Dunn Soubrier	11:54 AM · Feb 1, 2021	You gotta hear this. Got from: Crystal Dunn Soubrier	https://twitter.com//status/

:Mark	:Matter	:Location	:Claim	:Facts	30 / 199
-------	---------	-----------	--------	--------	----------



		https://twitter.com/DarBenThu1/status/1356314969998913536	@Cdunn19 of :Nov 4, 2020	1324103720611708929 America Needs to Hear This. -:willful -ignorance protects our ignorance.-
-0100		11:55 AM · Feb 1, 2021 https://twitter.com/DarBenThu1/status/1356315277512769536		
-0101	Ambassador Creator Most-High-God Trustee Negro Ysrael Beneficiary EBA 1933 Kinsman-Redeemer	2:05 PM · Feb 2, 2021	Shalom. Desirous to help finance this : a1) ambassador of the Most-High-God ~the Ancient-of-Days~, & a2) -:Trustee: Concession-1213-A.D., or b1) -:Negro-Ysrael, -beneficiary, -:civilian, -:Ohioan- debenture: EBA-1933-A.D., & b2) kinsman redeemer? Pray, and listen to our Creator.	
-0102	Monarch Mind-Control USofA-People Ysrael Yacob Black White Illuminati	2:43 PM · Feb 2, 2021 https://twitter.com/DarBenThu1/status/1356719916838096897	Please consider this: The "Monarch -program" was implemented from the 1950's on the USofA-people. Why? b/c most :USofA-people are Jacob/Isaac/Abraham -&check :this -Ysrael/ Jacob is Black and White, and include Negroes, Irish and England and, ... yup. Says who? Says God, check	https://vigilantcitizen.com/hidden-knowledge/origins-and-techniques-of-monarch-mind-control/ Origins and Techniques of Monarch Mind Control https://outpost-of-freedom.com/operatio.htm OPERATION MONARCH

:Mark	:Matter	:Location	:Claim	:Facts	31 / 199
-------	---------	-----------	--------	--------	----------



~0103	Monarch Mind-Control USofA-People Ysrael Yacob Black White Illuminati	2:43 PM · Feb 2, 2021 https://twitter.com/DarBenThu1/status/1356719916838096897	Please consider this: The 'Monarch -program' was implemented from the 1950's on the USofA-people. Why? b/c most :USofA-people are Jacob/Isaac/Abraham -&check :this -- Ysrael/ Jacob is Black and White, and include Negroes, Irish and England and, ... yup. Says who? Says God, check	2:43 PM · Feb 2, 2021 https://twitter.com/DarBenThu1/status/1356719916838096897
~0104	Monarch Mind-Control USofA-People Ysrael Yacob Black White Illuminati	2:45 PM · Feb 2, 2021 https://twitter.com/DarBenThu1/status/1356720404983803904	MONARCH Mind Control https://illuminatirex.com/monarch-mind-control/ General pop. :USofA are all alpha-type - malleable -minds. Shocked?!	2:43 PM · Feb 2, 2021 https://twitter.com/DarBenThu1/status/1356719916838096897 https://illuminatirex.com/monarch-mind-control/
~0105	Donald John POTUS PFTUSA Emancipation proclamation POTUSA EP Army James McConville Pinal Country Sheriff Mark Lamb	8:14 PM · Feb 2, 2021 https://twitter.com/DarBenThu1/status/1356803154990354435	On January 19, 2021, :-i- man sent to the man- Donald-John ~then-POTUS, PFTUSA, POTUSA~, and to the man- James: McConville ~Army~of the Emancipation-Proclamation..., forever~, and to Mark: Lamb~Pinal -county-Sheriff, Arizona state this: the claim/ property, https://blackandbluesoulsmatter.files.wordpress.com/2021/01/claim-	https://blackandbluesoulsmatter.files.wordpress.com/2021/01/claim-to-court-all.pdf
~0106	Joseph Robinette Donald John POTUS Obama Stole Property	8:19 PM · Feb 2, 2021 https://twitter.com/DarBenThu1/status/1356804516658573312	On January 28, 2021, :-i-man sent man- Joseph-Robinette, -:POTUS, et al- the whole team c/o Joseph-Robinette, the claim that the previous man- Donald-John, POTUS, et al.- Obama and etc., STOLE IN VIOLATION OF ALL LAW and treaty,	https://blackandbluesoulsmatter.files.wordpress.com/2021/01/2021-jan-26-ltr-to-potus-6-done-all-mailg.pdf

:Mark	:Matter	:Location	:Claim	:Facts 32 / 199
-------	---------	-----------	--------	-----------------



			https://blackandbluesoulsmatter.files.wordpress.com/2021/01/2021-jan-26-ltr-to-potus-6-done-all-mailg.pdf .	8:14 PM · Feb 2, 2021 https://twitter.com/DarBenThu1/status/1356803154990354435
~0107	Political Election PE FSIA Court of the Record Victim Criminal	8:43 PM · Feb 2, 2021 https://twitter.com/DarBenThu1/status/1356810522784489478	This is the :i- man -January 22, 2021 -covenant communication~under the Political Election~ to the Maricopa county, Arizona man-actors, regarding the denial of the right of :access to the court-of-record. :i- man am the victim here: This is criminal.	5:26 AM · Jan 23, 2021 https://twitter.com/DarBenThu1/status/1352955745881341953 https://twitter.com/DarBenThu1/status/1352955745881341953/photo/1 https://twitter.com/DarBenThu1/status/1352955745881341953/photo/1 https://twitter.com/DarBenThu1/status/1352955745881341953/photo/1 https://twitter.com/DarBenThu1/status/1352955745881341953/photo/1
~0108	US Capital Fence D.C.	3:27 AM · Feb 4, 2021 https://twitter.com/DarBenThu1/status/1357274679350677506	Did you know this? Capitol Building fence is blocking D.C. laws from approval	https://www.pbs.org/newshour/politics/capitol-building-fence-is-blocking--dc-laws-from-approval
~0109	Twitter Corporation EBA 1933 Trustee	6:06 AM · Feb 5, 2021	Twitter, YOU, et al. are a corporation / UNITED STATES Corp.- govsvcprowider- Trustee for: United States of America,	

:Mark	:Matter	:Location	:Claim	:Facts	33 / 199
-------	---------	-----------	--------	--------	----------

2022-011769 MISC Page: 2616 of 2782
 09/26/2022 03:35:37 PM Receipt #: 22-9381
 Rec Fee: \$30.00 Darrell James Hill
 Gila County, Az, Sadie Jo Bingham, Recorder



	People Beneficiary	https://twitter.com/DarBenThu1/status/1357676946755313666	people-beneficiary, et al.- :i- man, :Darrell-James: Hill. Restore :all-content to cease harming :i- man. Restructuring :i- man content is denied. You are noticed.	
-0110	Cousin Almighty-God US-Corp Concession 1213 Kinsman-Redeemer Yacob Ysrael Holy-Church Trustee	2:57 PM · Feb 5, 2021 https://twitter.com/DarBenThu1/status/1357810663222087682	:cousin, 1) See: 'deny :U.S.-Corp. to ':state' -people statuses' written for :i- man, sole or lone, and as 'kinsman-redeemer' for Negro-Ysrael, Ysrael, and Holy-Church'; 2) Note- :i- man, -:Ohioan am :Amb. of :Almighty-God :in-Trustee: Concession-1213-A.D.; 3) Your servant: Ps 91	https://twitter.com/DarBenThu1/status/1357810663222087682/photo/1 https://twitter.com/DarBenThu1/status/1357810663222087682/photo/2 https://twitter.com/DarBenThu1/status/1357810663222087682/photo/3 https://twitter.com/DarBenThu1/status/1357810663222087682/photo/4
-0111	General Milley Joseph Robinette Donald John Obama Stole Property	7:20 AM · Feb 6, 2021 https://twitter.com/DarBenThu1/status/1358058056060461056	#GenMilleyOn January 28, 2021, :i-man sent man- Joseph-Robinette, -:POTUS, et al- the whole team c/o Joseph-Robinette, the claim that the previous man- Donald-John, POTUS, et al.-Obama and etc., STOLE IN VIOLATION OF ALL LAW and treaty, https://blackandbluesoulsmatter.files.wordpress.com/2021/01/2021-jan-26-ltr-to-potus-6-done-all-mailg.pdf	https://blackandbluesoulsmatter.files.wordpress.com/2021/01/2021-jan-26-ltr-to-potus-6-done-all-mailg.pdf
-0112	General Milley Cousin Kinsman-Redeemer Psalms 91	7:25 AM · Feb 6, 2021	#GenMilley:cousin, 1) See: 'deny :U.S.-Corp. to ':state' -people statuses' written for :i- man, sole or lone, and as 'kinsman-redeemer' for Negro-Ysrael, Ysrael, and Holy-	https://twitter.com/DarBenThu1/status/1358059167798419460/photo/1

:Mark	:Matter	:Location	:Claim	:Facts	34 / 199
-------	---------	-----------	--------	--------	----------

:Two-Year-Review :Dar-Ben-Thu: Hill ~www.twitter.com/DarBenThu1~ -Authority
https://twitter.com/hashtag/darbenthu1September222020?src=hashtag_click
:DarBenThu1 -Box-Graph: #September2020AD > #August2022AD

	Ambassador Almighty-God Concession 1213	https://twitter.com/DarBenThu1/status/1358059167798419460	Church'; 2) Note- :i- man, -:Ohioan am :Amb. of :Almighty-God :in-Trustee: Concession-1213-A.D. 3) Psalms 91	https://twitter.com/DarBenThu1/status/1358059167798419460/photo/2 https://twitter.com/DarBenThu1/status/1358059167798419460/photo/3 https://twitter.com/DarBenThu1/status/1358059167798419460/photo/4
-0113	Twitter U.S.-Trustee Trustee Censor right DOI 1776	7:30 AM · Feb 9, 2021 https://twitter.com/DarBenThu1/status/1359147570967240709	Twitter. is the U.S.-Trustee via the BLM or whoever inadvertently seizing farmland from the beneficiaries? Or, not? I do not understand? Are you saying that Twitter for unknown reasons has determined that the topic cannot be discussed by man-kinds???	
-0114	Farms Farming Gate Billy Boy	10:08 AM · Feb 9, 2021 https://twitter.com/DarBenThu1/status/1359187496937140224	did you know this? Why is Billy Boy Buying Up Farmland Across America? https://humansbefree.com/2021/01/why-is-bill-gates-buying-up-farmland-across-america.html	https://t.co/PI3HUYSrUI https://humansbefree.com/wp-content/uploads/2021/01/Farmland-owned-by-Bill-Gates-by-state.jpg
-0115	Arizona	12:13 AM · Feb 10, 2021 https://twitter.com/DarBenThu1/status/1359400121964888066	Arizona Senate V Board of Supervisors update and behind the scenes intel plus action steps https://youtube.com/watch?v=Q2f3jM	Video unavailable ~2022 Aug 16~
-0116	US-Corp KR Kinsman-	2:57 PM · Feb 5, 2021	:cousin, 1) See: 'deny :U.S.-Corp. to ':state' -people_ statuses'	https://twitter.com/DarBenThu1/status/

:Mark	:Matter	:Location	:Claim	:Facts	35 / 199
-------	---------	-----------	--------	--------	----------



	Redeemer Negro Yacob Ysrael Holy-Church Concession 1213 Psalms 91	https://twitter.com/DarBenThu1/status/1357810663222087682	written for :-i- man, sole or lone, and as 'kinsman-redeemer' for Negro-Ysrael, Ysrael, and Holy-Church'; 2) Note- :-i- man, -:Ohioan am :Amb. of :Almighty-God :in-Trustee: Concession-1213-A.D.; 3) Your servant: Ps 91	1357810663222087682/photo/1 https://twitter.com/DarBenThu1/status/1357810663222087682/photo/2 https://twitter.com/DarBenThu1/status/1357810663222087682/photo/3 https://twitter.com/DarBenThu1/status/1357810663222087682/photo/4
~0117	Fiduciary Anna Anti Christ Kinsman-Redeemer	3:37 PM · Feb 14, 2021 https://twitter.com/DarBenThu1/status/1361082130948886533	A :man surreptiously offered to be FIDUCIARY for your debentures. See: 'fiduciary...' @ http://annavonreitz.com/highsteward.pdf . However, http://annavonreitz.com/documents/juralassemblyhandbook.pdf -- 'Section 2 → Law and Religion' is :anti-Christ. The :DOI-1776-A.D. is :covenant w/ :Almighty-God. So, kinsman says, 'TY, & NO'.	http://annavonreitz.com/highsteward.pdf http://annavonreitz.com/documents/juralassemblyhandbook.pdf
~0118	USofA-People Roman Canon Cestui Que Vie Trust Law	5:27 PM · Feb 15, 2021 https://twitter.com/DarBenThu1/status/1361472136251072516	For the 'United States of America' ~people~ growing-up from the deception. -- ROMAN CANON LAW; 3.3 ... Article 100 -- Cestui Que Vie Trusts. Having eyes can you see; having ears can you hear.	https://blackandbluesoulsmatter.files.wordpress.com/2021/02/roman-canon-law-3.3.pdf
~0119	In pais in estoppel assert right DOI 1776	8:07 PM · Feb 15, 2021	This means that "in pais, in estoppel" (legally) if you don't assert your right for your trust (your adult responsibility) then you are a child, incompetent, unknowing, etc.-ward OR YOU! gave it away. But, now you know. Set yourself free.	

:Mark	:Matter	:Location	:Claim	:Facts	36 / 199
-------	---------	-----------	--------	--------	----------

2022-011769 MISC Page: 2619 of 2782
 09/26/2022 03:35:37 PM Receipt #: 22-9381
 Rec Fee: \$30.00 Darrell James Hill
 Gila County, Az. Sadia Jo Bingham, Recorder



:Two-Year-Review :Dar-Ben-Thu: Hill ~www.twitter.com/DarBenThu1~ -Authority
https://twitter.com/hashtag/darbenthu1September222020?src=hashtag_click
:DarBenThu1 -Box-Graph: #September2020AD > #August2022AD

:Era 1 #Mar2021DarBenThu1		:Era 1 #Mar2021DarBenThu1		
-0120	John Farm Deere Farmer US-Corp Trustee EBA 1933	1:52 AM - Mar 1, 2021 https://twitter.com/DarBenThu1/status/1366310260504363008	Is not John Deere a corporation under the 'U.S.-Corp'? Y. Is not the U.S.-Corp. the Trustee: EBA-1933-A.D.? Y. Are not these farmers beneficiaries of the EBA-1933-A.D.? Y. Can the Trustee authorize any harm upon the beneficiary? N. Is JD authorized/ US-Corp. to harm the farmers? https://twitter.com/LjNirk/status/	https://twitter.com/LjNirk/status/1235254107969073153 This Tweet was deleted by the Tweet author.
-0121	Shem Ysrael Ham Southern-Kingdom Shem Ysrael Japeth Northern-Kingdom Ysrael Jacob Obadiah Psalms 83	2:31 AM - Mar 1, 2021 https://twitter.com/DarBenThu1/status/1366320212111335424	a sad truth. Ysrael--Jacob-Ham is 'Judah': Southern-Kingdom; 402 years into the Americas!. Ysrael-Jacob-Japeth is Ephraim: Northern-Kingdom; 2500 years in Europe. THEY DO NOT KNOW WHO THEY ARE. But, don't believe me. Who did this? See: KJV: Obadiah, Ps. 83. White does not exist. https://twitter.com/JWBoydNBFA/status/1364932455011127300	John W. Boyd, Jr. @JWBoydNBFA #BoycottJohnDeere #JohnDeereLiedForYears #BlackFarmerJustice #EndRacialDiscrimination #SupportNBFA @jwboydNBFA http://icont.ac/4BiaN
-0122		5:18 PM - Feb 28, 2021 https://twitter.com/yaboumusic/status/1366180950149890048	YABOU @yaboumusic #Holochain #holo \$HOT	https://twitter.com/yaboumusic/status/1366180950149890048
-0123	Authority Sovereign Jurisdiction AO	12:11 PM - Mar 5, 2021 https://twitter.com/DarBenThu1/status/1367915700866584576	Mar052021AD. :i- man-jurisdiction of :sovereign-authority with general-procuration (/kinsman) as the PFTUSA overstanding; POTUS-trustee, & absolute-procuration over :stolen-property (/sole) :in-accordance w/ Covenant-agreements. :PFTUSA abandoned-01/20 and vacated 03/03/2021 A.D.	:Claim to the USofA-Military- Officers: #Mark-Alexander: Milley - Army #John-Earl: Hyten -AirForce

:Mark	:Matter	:Location	:Claim
-------	---------	-----------	--------

2022-011769 MISC Page: 2620 of 2782
 09/26/2022 03:35:37 PM Receipt #: 22-9381
 Rec Fee: \$30.00 Darrell James Hill
 Gila County, Az, Sadie Jo Bingham, Recorder



				#James-Charles: McConville -COS- Army #David-Hilberry: Berger – CMC-Marine #Michael-Martin: Gilday - CNO-Navy #David-Lee: Goldfein – COS- AirForce #John-William: Raymond CSO- SpaceForce #Joseph-Lauren: Lengyel -CNG-AirForce #Karl-Leo: Schultz -CCG-CoastGuard USPO CMN 7009 1410 1000 7868 5741
~0124	Authority Sovereign Jurisdiction AO	2:26 PM · Mar 6, 2021 https://twitter.com/DarBenThu1/status/1368311940666122244	#GenMilley @POTUS @Mike_Pence @RSBNetwork @DonaldJTrumpJr @PressSec @H2Ohio @OHIOFMFG @OHSupremeCourt @washingtonpost @Ohio_OBM @NatGovsAssoc @UNHumanRights @UNTreatyBodies @BerniceKing @OHCHR EARO @UNHumanRightsUA @DrPaulGosar @AZGOP @anonpatriotq @propublica @Snowden @wikileaks	
~0125	Authority Sovereign Jurisdiction AO	4:45 PM · Mar 7, 2021 https://twitter.com/DarBenThu1/status/1368709445149073408	#farmersofcolor #WomenFarmers youngfarmers #commodityfarmers #farmers #URBANFARMS #COOPS, #organic #regenerativeagriculture #igrowfood #bornandraised #homegrowninaustin @NFUDC #farming #veteranowned #brothelfarms #backyard	Mar052021AD. :- man-jurisdiction of :sovereign-authority with general-procuration (/kinsman) as the PFTUSA overstanding: POTUS-trustee, & absolute-procuration over :stolen-property (/sole) :in-accordance w/ Covenant-agreements. :PFTUSA abandoned- 01/20 and vacated 03/03/2021 A.D. https://twitter.com/DarBenThu1/status/1367915700866584576/photo/1 https://twitter.com/DarBenThu1/status/1367915700866584576/photo/2

:Mark	:Matter	:Location	:Claim	:Facts	38 / 199
-------	---------	-----------	--------	--------	----------

				https://twitter.com/DarBenThu1/status/1367915700866584576/photo/3
~0126	Kinsman-Redeemer Co-Intepro Anti-Messiah	10:55 AM · Mar 8, 2021 https://twitter.com/DarBenThu1/status/1368983616093519876	Darrell James hill @DarBenThu1 :i- man am Negro-Judah: Ysrael, :kinsman for :Ysrael and the Holy-Church, amb. of Yushuah ~Jesus~ the Messiah in trustee: Concession 1213 A.D. COINTELPRO is anti-Messiah.	https://en.wikipedia.org/wiki/COINTELPRO
~0127	Kinsman-Redeemer Co-Intepro Anti-Messiah	2:13 PM · Mar 8, 2021 https://twitter.com/DarBenThu1/status/1369033623316275200	#LarryFitzgerald #JJWatt #SuperBowl #ArizonaCardinals #NFL #Patriots #Panthers #Packers #Bears #Browns #Bills #Ravens #Rams #Raiders #Titans #Vikings #Falcons #Dolphins #Chiefs #Cowboys #Giants #Jaguars #Eagles #Jets #49ers #Seahawks #Steelers #Saints	https://en.wikipedia.org/wiki/COINTELPRO
~0128	Kinsman-Redeemer Co-Intepro Anti-Messiah	4:00 PM · Mar 8, 2021 https://twitter.com/DarBenThu1/status/1369060460125818883	hoppeblack.us @naaganational @AfricanAncestry @BlackHealthNews @Data4BlackLives @Wademenendez @deepoku @BrigitteDaniel @AfroTech @BB_Bloggers @chancetherapper @africacentre 'that, you know this has been done.	12:11 PM · Mar 5, 2021 https://twitter.com/DarBenThu1/status/1367915700866584576 Mar052021AD. :i- man-jurisdiction of :sovereign-authority with general-procuration (/kinsman) as the PFTUSA overstanding:

:Mark	:Matter	:Location	:Claim	:Date	39 / 199
-------	---------	-----------	--------	-------	----------

~0129	Kinsman-Redeemer Co-Intepro Anti-Messiah	8:42 PM · Mar 8, 2021 https://twitter.com/DarBenThu1/status/1369131388822192133	See: Notice of execution of Your 'Unalienable-right' @hempfarmsofny @ENYFARMS @IrvingFarm @SalemFarmSupply @WestFarmsNY @TinyHouseFarmA1 @musicfarmny @BigAliceBrewing @WoodlandBeer @RulfsOrchards @LithologyBrew @BardCollegeFarm @jennsilverberg @ninepincider @saintjamesbrew	POTUS-trustee, & absolute-procuration over :stolen-property (/sole) :in-accordance w/ Covenant-agreements. :PFTUSA abandoned- 01/20 and vacated 03/03/2021 A.D. :Claim to the USofA-Military- Officers: #Mark-Alexander: Milley - Army
~0130	Kinsman-Redeemer Co-Intepro Anti-Messiah	2:11 AM · Mar 9, 2021 https://twitter.com/DarBenThu1/status/1369214135976660999	See: Notice of execution of Your 'Unalienable-right' @AZSheriffs @co_sheriff @NationalSheriff @mcsoaz @az_cops @PimaSheriff @PinalCSO @CoconinoSheriff @YumaSheriff @ohio_sheriffs @SCCSheriff @sheriff1amb1 @kjzzphoenix @CBS5AZ @azcentral @TopCop_Cochise	#John-Earl: Hyten -AirForce #James-Charles: McConville -COS- Army #David-Hilberry: Berger – CMC-Marine #Michael-Martin: Gilday - CNO-Navy #David-Lee: Goldfein – COS- AirForce #John-William: Raymond CSO- SpaceForce #Joseph-Lauren: Lengyel -CNG-AirForce #Karl-Leo: Schultz -CCG-CoastGuard USPO CMN 7009 1410 1000 7868 5741 https://twitter.com/DarBenThu1/status/1367915700866584576/photo/1 https://twitter.com/DarBenThu1/status/

:Mark	:Matter	:Location	:Claim	:Excts 40 / 199
-------	---------	-----------	--------	-----------------

2022-011769 MISC Page: 2623 of 2782
 09/26/2022 03:35:37 PM Receipt #: 22-9381
 Rec Fee: \$30.00 Darrell James Hill
 Gila County, Az, Sadie Jo Bingham, Recorder



				1367915700866584576/photo/2 https://twitter.com/DarBenThu1/status/1367915700866584576/photo/3
~0131	BOR 1789 Amendment IX Constitution 1787	2:23 AM · Mar 9, 2021 https://twitter.com/DarBenThu1/status/1369217293209640960	Bill of Rights 1789 A.D.; 9th Amendment: The enumeration in the Constitution, of certain rights, shall not be construed to deny or disparage others retained by the people. -- p.1771 of https://1215.org/lawnotes/usconstitution/u-s-constitution-analysis-interpretation-2014-06-01.pdf . See: fn 4	https://1215.org/lawnotes/usconstitution/u-s-constitution-analysis-interpretation-2014-06-01.pdf . See: fn 4
~0132	BOR 1789 Amendment X Constitution 1787	2:31 AM · Mar 9, 2021 https://twitter.com/DarBenThu1/status/1369219171033083904	Bill of Rights 1789 A.D.; 10th Amendment: The powers not delegated to the United States by the Constitution, nor prohibited by it to the States, are reserved to the States respectively, or to the people. -- p.1777 of https://1215.org/lawnotes/usconstitution/u-s-constitution-analysis-interpretation-2014-06-01.pdf . See: para. 1	https://1215.org/lawnotes/usconstitution/u-s-constitution-analysis-interpretation-2014-06-01.pdf . See: para. 1
~0133	Kinsman-Redeemer Co-Intepro Anti-Messiah	2:34 AM · Mar 9, 2021 https://twitter.com/DarBenThu1/status/1369220008446885889	See: Notice of execution of Your 'Unalienable-right' @EatGreenNY @nofaNY @Seed_Alliance #organic @YoungFarmers @FarmSchoolNYC @YoungFarmers @MorningAgClips @GreenCityForce @NYCFoodPolicy @nycagcollective #urbanagriculture #nycfarm	Mar052021AD. :i- man-jurisdiction of :sovereign-authority with general-procuration (/kinsman) as the PFTUSA overstanding: POTUS-trustee, & absolute-procuration over :stolen-property (/sole) :in-accordance w/ Covenant-agreements. :PFTUSA abandoned-01/20 and vacated 03/03/2021 A.D.
~0134	Kinsman-Redeemer Co-Intepro Anti-Messiah	2:36 AM · Mar 9, 2021	#itsinqueens #farmedsince1697 @ayanaeliza @NFUDC	2:34 AM · Mar 9, 2021 https://twitter.com/DarBenThu1/status/

:Mark	:Matter	:Location	:Claim
-------	---------	-----------	--------

41 / 199

2022-011769 MISC Page: 2624 of 2782
 09/26/2022 03:35:37 PM Receipt #: 22-9381
 Rec Fee: \$30.00 Darrell James Hill
 Gila County, Az, Sadie Jo Bingham, Recorder



		https://twitter.com/DarBenThu1/status/1369220456746688516		1369220008446885889 Mar052021AD. :- man-jurisdiction of :sovereign-authority with general-procuration (/kinsman) as the PFTUSA overstanding: POTUS-trustee, & absolute-procuration over :stolen-property (/sole) :in-accordance w/ Covenant-agreements. :PFTUSA abandoned-01/20 and vacated 03/03/2021 A.D.
~0135	Kinsman-Redeemer Co-Intepro Anti-Messiah	7:35 AM · Mar 9, 2021 https://twitter.com/DarBenThu1/status/1369295746923593728	See: Notice of execution of Your 'Unalienable-right' @NDFarmersUnion @FarmVetCo @HegerFarms @dakotaharvest @NDUnited @RMFUnion @HiFarmersUnion @NDAREC @RURALRADIO147 @grainman34 @ProtectHarvest @fargocom @JoelKFGO @FarmsSwine @FarmsNews	12:11 PM · Mar 5, 2021 https://twitter.com/DarBenThu1/status/1367915700866584576 Mar052021AD. :- man-jurisdiction of :sovereign-authority with general-procuration (/kinsman) as the PFTUSA overstanding: POTUS-trustee, & absolute-procuration over :stolen-property (/sole) :in-accordance w/ Covenant-agreements. :PFTUSA abandoned-01/20 and vacated 03/03/2021 A.D.
~0136	Kinsman-Redeemer Co-Intepro Anti-Messiah	7:35 AM · Mar 9, 2021 https://twitter.com/DarBenThu1/status/1369295760911634437	See: Notice of execution of Your 'Unalienable-right' #BetterPork @PigCHAMP @AgCareers @DaveBlasey @NDAgExpStation @AgEngineer1 @WeetsKerby @realag_us @shaunhaney @AKFarmersUnion @PopielNathan @Stonyfield @BobsRedMill @AdamSpelhaug @CowSignals @Amy_Robak Bruce	Mar052021AD. :- man-jurisdiction of :sovereign-authority with general-procuration (/kinsman) as the PFTUSA overstanding: POTUS-trustee, & absolute-procuration over :stolen-property (/sole) :in-accordance w/ Covenant-agreements. :PFTUSA abandoned-01/20 and vacated 03/03/2021 A.D.
~0137	Kinsman-Redeemer Co-Intepro Anti-Messiah	7:35 AM · Mar 9, 2021 https://twitter.com/	See: Notice of execution of Your 'Unalienable-right' @dakotapride @AgClips @plant_perfect @dfamiik	:Claim to the USofA-Military- Officers:

:Mark	:Matter	:Location	:Claim
-------	---------	-----------	--------

2022-011769 MISC Page: 2625 of 2782
 09/26/2022 03:35:37 PM Receipt #: 22-9381
 Rec Fee: \$30.00 Darrell James Hill
 Gila County, Az, Sadie Jo Bingham, Recorder

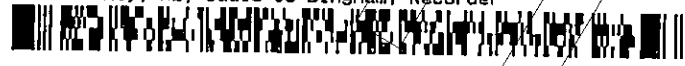

		DarBenThu1/status/1369295776803741696	@KnutsonFarms @ksgrains @CommonGroundNow @NationalPork @RohrsBros @Oprah	#Mark-Alexander: Milley - Army #John-Earl: Hyten -AirForce #James-Charles: McConville -COS- Army
~0138	Kinsman-Redeemer Co-Intepro Anti-Messiah	1:10 PM · Mar 9, 2021 https://twitter.com/DarBenThu1/status/1369380049955287043	See: Notice of execution of Your 'Unalienable-right' @FirehookBaked EarlyMountain @FarmScribbler @VADistilleary @WhiteFlintFrm @ChesFoodshed @purplerooorg @NoKidHungryVA @brightfarms @VaAgriWomen @MICrawfordCream @vachestnuts @FHCASA Whitley's Peanuts .	#David-Hilberry: Berger – CMC-Marine #Michael-Martin: Gilday - CNO-Navy #David-Lee: Goldfein – COS- AirForce #John-William: Raymond CSO- SpaceForce #Joseph-Lauren: Lengyel -CNG-AirForce
~0139	Kinsman-Redeemer Co-Intepro Anti-Messiah	1:10 PM · Mar 9, 2021 https://twitter.com/DarBenThu1/status/1369380057429520384	See: Notice of execution of Your 'Unalienable-right' @MichaelEspinoza @CoffeeWaves @IrelandsFarmers @creekhousehoney #hemp #agricultureandfarming #horticulture #farm #cbd #cbdheals @ShantellBingham @SouthwestDairy @ruralheritage @Ron_on RON	#Karl-Leo: Schultz -CCG-CoastGuard USPO CMN 7009 1410 1000 7868 5741 https://twitter.com/DarBenThu1/status/1367915700866584576/photo/1
~0140	Kinsman-Redeemer Co-Intepro Anti-Messiah	1:10 PM · Mar 9, 2021 https://twitter.com/DarBenThu1/status/1369380065667129348	See: Notice of execution of Your 'Unalienable-right' TXHempFarmers @BethFordLOL @organiccowboy #AmericanHempFarmer #HempBound @thehia @kimseverson #Texas #Farmers @ccdowntownfm @growlocalstx @tanninscctx	https://twitter.com/DarBenThu1/status/1367915700866584576/photo/2 https://twitter.com/DarBenThu1/status/1367915700866584576/photo/3
~0141	Kinsman-Redeemer Co-Intepro	1:10 PM · Mar 9, 2021	See: Notice of execution of Your 'Unalienable-right'	

:Mark	:Matter	:Location	:Claim	:Facts	43 / 199
-------	---------	-----------	--------	--------	----------

2022-011769 MISC Page: 2626 of 2782
 09/26/2022 03:35:37 PM Receipt #: 22-9581
 Rec Fee: \$30.00 Darrell James Hill
 Gila County, Az, Sadie Jo Bingham, Recorder



	Anti-Messiah	https://twitter.com/DarBenThu1/status/1369380073573388289	@BiafraHouse #agriberry #gardening #Virginia #Horticulture @AHS_Gardening @PublicGardens @VaFarmAndFood @urhmbfarmer @IALRDrones @TheRockBarn @virginiaseafood @rasblackassoc @VTFermentation @Defend_theFlock @BrownieByTeresa	
~0142	Kinsman-Redeemer Co-Intepro Anti-Messiah	2:23 PM · Mar 9, 2021 https://twitter.com/DarBenThu1/status/1369398557548163081	See: Notice of execution of Your 'Unalienable-right' @vgpvvisions @HEAL_Food @UCSUSA @ClifBar @pesticideaction @FarmActionUS @FarmtoSchool @_OneCountry_ @hunger @NativeAgFund @foe_us @fairfoodnation @FamilyFarmCo @Federation1967 @RuralCo	
~0143	Kinsman-Redeemer Co-Intepro Anti-Messiah	2:23 PM · Mar 9, 2021 https://twitter.com/DarBenThu1/status/1369398578326732801	See: Notice of execution of Your 'Unalienable-right' #supportFarmersofColor reparations @wgdconf #intothefield #gender #R4D @WomenFoodAgNet @Farmland @PrairieRivers @AlabamaRivers @FWAFL @LandForGood @ewg @rafiusa @CDFAClimateNews	
~0144	Twitter-Censorship: DOI	3:32 PM · Mar 9, 2021 https://twitter.com/DarBenThu1/status/1369415843394822144	Grievance Officer - India https://help.twitter.com/en/rules-and-policies/report-twitter-abuse-india account ceased instead of facilitating the purposes of the communication that is obvious in violation of the DOI-1776-A.D. under the corporate charter under the obligation of The Constitution for the United States of America.	https://help.twitter.com/en/rules-and-policies/report-twitter-abuse-india

:Mark	:Matter	:Location	:Claim	:Facts	44 / 199
-------	---------	-----------	--------	--------	----------



		Service shut-off with the lack of the reason.		
-0145	:Era 1 #April2021DarBenThu1 #May2021DarBenThu1 #June2021DarBenThu1 #July2021DarBenThu1 #Aug 2021DarBenThu1	:Twitter-Corp-EBA-1933-Trustee-Censor: right: DOI-1776-AD Service switched-off with the lack of the authority.		Grievance Officer – India https://help.twitter.com/en/rules-and-policies/report-twitter-abuse-india :account-ceased instead-of the honor with the facilitating of the purposes of the Beneficiary-communications that is with the violation of the DOI-1776-A.D. under the corporate charter under the obligation of The Constitution: DOI-1776-AD for the United States of America-People-Sovereigns by the law of the DOI-1776-AD.
:Era 2 #Sept2021DarBenThu1		:Era 2 #Sept2021DarBenThu1		
-0146	Twitter-Censor-right: DOI 1776	5:58 AM · Sep 3, 2021 https://twitter.com/DarBenThu1/status/1433776397068079108	Hello. Service switched-on with the lack of the reason.	
:Era 2 #Dec2021DarBenThu1		:Era 2 #Dec2021DarBenThu1		
-0147	Non-concent	6:22 PM · Dec 19, 2021	Procurator- Proof-of-notice-7009- 1410 0000 7868	https://

:Mark	:Matter	:Location	:Claim
-------	---------	-----------	--------

2022-011769 MISC Page: 2628 of 2782
 09/26/2022 03:35:37 PM Receipt #: 22-9381
 Rec Fee: \$30.00 Darrell James Hill
 Gila County, Az, Sadie Jo Bingham, Recorder



	DOI 1776 [De-]privation Ohioan New-Mexican Procurator	https://twitter.com/DarBenThu1/status/1472739275024191488	5802- :Executor: PE-2017-A.D.– Non-consent to :DOI-1776-A.D.- deprivation of -:unalienable-rights upon the man- Ohioan and New-Mexican by the Executor- Procurator --. Pls know or you should know. https://wordpress.com/page/blackandb	blackandbluesoulsmatter.files.wordpress.com/2021/12/2021_016195.pdf
~0148	Shekinah Worship Center	5:55 PM · Dec 21, 2021 https://twitter.com/DarBenThu1/status/1473457075397136386	:Shekinah -Prayer- Scriptures: Apostoles: https://drive.google.com/file/d/1Z_wdzV1OqLEpN0F7zAV8Cwb0XrH604p9/view	:Gospel of the Scriptures https://twitter.com/DarBenThu1/status/1473457075397136386/photo/1 https://twitter.com/DarBenThu1/status/1473457075397136386/photo/2
:Era 2 #Feb2022DarBenThu1			:Era 2 #Feb2022DarBenThu1	
~0149	Deteronomy 31 6	9:42 AM · Feb 13, 2022 https://twitter.com/DarBenThu1/status/1492902127504699396	Deuteronomy 31: 6 -- 6 Be strong and of a good courage, fear not, nor be afraid of them; for the LORD thy God, he it is that doth go with thee; he will not fail thee, nor forsake thee.	
~0150	Linked-In	6:48 PM · Feb 18, 2022 https://twitter.com/DarBenThu1/status/1494851465596129282	Started-up: linked-in	https://www.linkedin.com/in/dj-hill-872963116/
:Era 2 #Mar2022DarBenThu1			:Era 2 #Mar2022DarBenThu1	

:Mark	:Matter	:Location	:Claim	:Ercts	46 / 199
-------	---------	-----------	--------	--------	----------

~0151	Definitions Acronyms	<u>7:10 AM · Mar 7, 2022</u> https://twitter.com/DarBenThu1/status/1500836338068692995	Document- Acronym and Abbreviations- Definitions	https://twitter.com/DarBenThu1/status/1500836338068692995/photo/1 https://twitter.com/DarBenThu1/status/1500836338068692995/photo/2 https://twitter.com/DarBenThu1/status/1500836338068692995/photo/3 https://twitter.com/DarBenThu1/status/1500836338068692995/photo/4
~0152	Treason Hilsdale William Pelham Barr Functions US Atty General	<u>11:32 PM · Mar 12, 2022</u> https://twitter.com/DarBenThu1/status/1502895281469157376	If you can comprehend this then you know how treason is explained. At -:Hilsdale-College: William P. Barr The Constitution and the Rule of Law -- https://youtube.com/watch?v=l0Ho5_DiRdc&t=114s See: 28 U.S. Code § 509 - Functions of the Attorney General -- https://law.cornell.edu/uscode/text/28	https://twitter.com/DarBenThu1/status/1502895281469157376/photo/1 26 US.Code Sec 509 -Functions fo the Attorney General https://www.youtube.com/watch?v=l0Ho5_DiRdc&t=114s https://www.law.cornell.edu/uscode/text/28/509
~0153	USofA 1776 DOI 1776 EBA 1933 Authenticate	<u>2:02 AM · Mar 16, 2022</u> https://twitter.com/DarBenThu1/status/1504020375599923201	Shalom B.C., et al., :SWC. The people of the USofA- :DOI-1776-A.D. do :ALL have the -:EBA-1933-A.D. -Trust-Fund-principal and earnings due-now as of -:2003 A.D. This doc is to help to explain and establish what first things we ALL must do to authenticate our identity. Shalom.	https://twitter.com/DarBenThu1/status/1504020375599923201/photo/1 https://twitter.com/DarBenThu1/status/1504020375599923201/photo/2 https://twitter.com/DarBenThu1/status/1504020375599923201/photo/3

:Mark	:Matter	:Location	:Claim	:Facts
-------	---------	-----------	--------	--------

				https://twitter.com/DarBenThu1/status/1504020375599923201/photo/4
~0154	Open Source Common Law Words Meanings Concepts Declarations Beneficiary Executor CQV-T	6:13 AM · Mar 22, 2022 https://twitter.com/DarBenThu1/status/1506257760517701638	:Open-source- Tool for the DOI-1776-A.D.- Common-law - Words, Meanings, Concepts and Declarations https://blackandbluesoulsmatter.wordpress.com/2022/03/22/open-source-tool-for-the-doi-1776-a-d-common-law-words-meanings-and-concepts/ This tool is with the DOI-1776-A.D.- Common-Law- beneficiary- Executor-knowledge for your Self-Wealth-Management of your EBA-1933-A.D. -2003-A.D.- CQV-T.	https://blackandbluesoulsmatter.files.wordpress.com/2022/03/dictionary2-03-21-2022-list.pdf
~0155	Trust Principles Executor Principles State County Man Sovereigns DOI 1776	11:30 PM · Mar 22, 2022 https://twitter.com/DarBenThu1/status/1506518694393880577	March 22, 2022; 2312p. RE: Trust-Principles- https://twitter.com/DarBenThu1/status/1504020375599923201 , and: Executor-Principles- https://blackandbluesoulsmatter.files.wordpress.com/2022/03/dictionary2-03-21-2022-list.pdf , :All-State-Country-man-Sovereigns are born settlers to the DOI-1776-A.D., et seq., as :Executors upon their maturity. WE CANNOT SURVIVE AS :WARDS-OF -STATE.	2:02 AM · Mar 16, 2022 https://twitter.com/DarBenThu1/status/1504020375599923201 https://blackandbluesoulsmatter.files.wordpress.com/2022/03/dictionary2-03-21-2022-list.pdf
~0156	Trust- Principles	12:07 AM · Mar 23, 2022 https://twitter.com/DarBenThu1/status/1506528024308563969	:Email of the trust-principles	https://twitter.com/DarBenThu1/status/1506528024308563969/photo/1 Email: March 22 2022 Entry
~0157	:Twitter -Trespass uon the	4:01 AM · Mar 25, 2022	:Claim-Notice: from -:Ohioan- Darrell-James: Hill-Executor:	https://twitter.com/DarBenThu1/status/

:Mark	:Matter	:Location	:Claim	:Facts	48 / 199
-------	---------	-----------	--------	--------	----------



	right: DOI-1776	https://twitter.com/DarBenThu1/status/1507311587064881154	DOI-1776-A.D. Claim: Your-Action-attached is :trespass of :rights :DOI-1776-A.D. -, :This-action with -:wanton -warrant is :Trespass: DOI-1776-A.D. :GOTUS-Corp.-GSP- license is with No -:Violation of the DOI-1776-A.D.	https://twitter.com/DarBenThu1/status/1507311587064881154/photo/1
~0158	Brittney Griner WNBA Russia	12:51 AM · Mar 23, 2022 https://twitter.com/DarBenThu1/status/1506539083438321664	Brittney Griner's Russian ordeal is a byproduct of WNBA's shoestring funding Andrew Lawrence https://theguardian.com/sport/2022/mar/09/brittney-griners-russian-ordeal-is-a-byproduct-of-wnbas-shoestring-funding Overseas and WHAT ABOUT HER TRUST-FUND?! She is a soul-journer- State-Country-man that like the other-many WNBA need not go overseas for money!!	https://www.theguardian.com/sport/2022/mar/09/brittney-griners-russian-ordeal-is-a-byproduct-of-wnbas-shoestring-funding https://twitter.com/DarBenThu1/status/1507531511637024768/photo/1
~0159	Brittney Griner WNBA	6:34 PM · Mar 25, 2022 https://twitter.com/DarBenThu1/status/1507531511637024768	Brittney Griner	https://twitter.com/DarBenThu1/status/1507531511637024768/photo/1
~0160	State-Country-Man-Born-Beneficiary Settlers Grantors Executors DOI 1776 Concession 1213 CftUSofA 1787	10:30 AM · Mar 29, 2022 https://twitter.com/DarBenThu1/status/1508859239053242369	All-birth-born-State-Country-man are Sovereign-beneficiary -:Settlers and/or Grantors and/or Executors: DOI-1776-A.D., et al.- Concession-1213-A.D., et seq.-TheCftUSofA-1787-A.D.-covenant-guaranteed-republican-government- then-to-fore and after; :Now.	https://twitter.com/DarBenThu1/status/1508859239053242369/photo/1 https://twitter.com/DarBenThu1/status/1508859239053242369/photo/2 https://twitter.com/DarBenThu1/status/

:Mark	:Matter	:Location	:Claim	:Page
-------	---------	-----------	--------	-------

				1508859239053242369/photo/3 https://twitter.com/DarBenThu1/status/1508859239053242369/photo/4
~0161	Tell all State Others Definitions EBA 1933 CQV-T Trust DOI 1776 Settlor Grantor Executor	7:44 AM · Mar 31, 2022 https://twitter.com/DarBenThu1/status/1509542252778979329	@FamilyFarmCo Tell All Others 1) ;Definitions https://twitter.com/DarBenThu1/status/1500836338068692995 ; 2) ;EBA-1933-A.D. -Trust-Fund https://twitter.com/DarBenThu1/status/1504020375599923201 ; 3) DOI-1776-A.D. ; https://blackandbluesoulsmatter.wordpress.com/2022/03/22/open-source-tool-for-the-doi-1776-a-d-common-law-words-meanings-and-concepts/ ; 4) All-birth-born-Executors: DOI-1776-A.D. ; https://twitter.com/DarBenThu1/status/1367915700866584576	https://twitter.com/DarBenThu1/status/1500836338068692995 https://twitter.com/DarBenThu1/status/1504020375599923201 https://blackandbluesoulsmatter.wordpress.com/2022/03/22/open-source-tool-for-the-doi-1776-a-d-common-law-words-meanings-and-concepts/ https://twitter.com/DarBenThu1/status/1508859239053242369 2:23 PM · Mar 9, 2021 https://twitter.com/DarBenThu1/status/1369398557548163081 12:11 PM · Mar 5, 2021 https://twitter.com/DarBenThu1/status/1367915700866584576

:Mark	:Matter	:Location	:Claim	:Facts	50 / 199
-------	---------	-----------	--------	--------	----------

51

:Two-Year-Review :Dar-Ben-Thu: Hill ~www.twitter.com/DarBenThu1~ -Authority
https://twitter.com/hashtag/darbenthu1September222020?src=hashtag_click
:DarBenThu1 -Box-Graph: #September2020AD > #August2022AD

				Mar052021AD. :i- man-jurisdiction of :sovereign-authority with general-procuration (/kinsman) as the PFTUSA overstanding: POTUS-trustee, & absolute-procuration over :stolen-property (/sole) :in-accordance w/ Covenant-agreements. :PFTUSA abandoned-01/20 and vacated 03/03/2021 A.D.
:Era 2 #April2022DarBenThu1		:Era 2 #April2022DarBenThu1		
-0162	Ohioans Holy-Church EBA 1933 Concession 1213 EP 1863 DOI 1776	5:28 AM · Apr 1, 2022 https://twitter.com/DarBenThu1/status/1509870202300686336	:i- man- Ohioan do the Almighty-God's will informing Ohioans -> Holy-Church of this part-how-now-to-proceed to the Exodus. shema shalom. #EBA-1933-A.D. -Trust-Fund #Concession1213AD is: Concession-1213-A.D. ; #EP1863AD is: EP-1863-A.D. ; #DOI1776AD is DOI-1776-A.D.	7:44 AM · Mar 31, 2022 https://twitter.com/DarBenThu1/status/1509542252778979329 https://twitter.com/DarBenThu1/status/1500836338068692995 https://twitter.com/DarBenThu1/status/1504020375599923201 https://blackandbluesoulsmatter.wordpress.com/2022/03/22/open-source-tool-for-the-doi-1776-a-d-common-law-words-meanings-and-concepts/ https://twitter.com/DarBenThu1/status/1508859239053242369

:Mark	:Matter	:Location	:Claim	:Facts	51 / 199
-------	---------	-----------	--------	--------	----------

2022-011769 MISC Page: 2634 of 2782
 09/26/2022 03:35:37 PM Receipt #: 22-9381
 Rec Fee: \$30.00 Darrell James Hill
 Gila County, Az, Sadie Jo Bingham, Recorder



				<p>2:23 PM · Mar 9, 2021 https://twitter.com/DarBenThu1/status/1369398557548163081</p> <p>12:11 PM · Mar 5, 2021 https://twitter.com/DarBenThu1/status/1367915700866584576</p> <p>Mar052021AD. :i- man-jurisdiction of :sovereign-authority with general-procuration (/kinsman) as the PFTUSA overstanding: POTUS-trustee, & absolute-procuration over :stolen-property (/sole) :in-accordance w/ Covenant-agreements. :PFTUSA abandoned-01/20 and vacated 03/03/2021 A.D.</p>
~0163	Jordan Peterson Cambridge End all Arguments	<p>4:30 AM · Apr 2, 2022 https://twitter.com/DarBenThu1/status/1510218101937225732</p>	<p>You may have to listen twice (like :i- man did+) but if you can comprehend this; then you can hear a controversy. Shalom</p> <p>Use This Psychotherapy Technique To End All Of Your Arguments Jordan Peterson at Cambridge https://youtube.com/watch?v=G1JWRFIzppA [Dr Jordan B Peterson @jordanbpeterson]</p>	<p>https://www.youtube.com/watch?v=G1JWRFIzppA</p> <p>A psychoterapeutic Technique To End All Of Your Arguments</p>
~0164	Ohioan Holy-Church EBA 1933 Trust Concession 1213 EP 1863	<p>5:28 AM · Apr 1, 2022 https://twitter.com/DarBenThu1/status/1509870202300686336</p>	<p>:i- man- Ohioan do the Almighty-God's will informing Ohioans - > Holy-Church of this part- how-now-to-proceed to the Exodus. shema shalom. #:EBA-1933-A.D. -Trust-Fund #Concession1213AD is: Concession-1213-A.D. ; #EP1863AD is: EP-1863-A.D. ; #DOI1776AD is DOI-1776-A.D.</p>	<p>7:44 AM · Mar 31, 2022 https://twitter.com/DarBenThu1/status/1509542252778979329</p>

:Mark	:Matter	:Location	:Claim	:Facts	52 / 199
-------	---------	-----------	--------	--------	----------

2022-011769 MISC Page: 2635 of 2782
 09/26/2022 03:35:37 PM Receipt #: 22-9381
 Rec Fee: \$30.00 Darrell James Hill
 Gila County, Az, Sadie Jo Bingham, Recorder



	DOI 1776			
~0165	Jordan Peterson Cambridge Avoid victimhood	11:16 AM · Apr 2, 2022 https://twitter.com/DarBenThu1/status/1510320177367314433	Confuse-not the -:consequence in -:real-experiences with a fear-imagination of-:failure, but keep them distinct to enable you to chose your path-forward in -:earnest. How To Avoid The Trap Of Victimhood When Life Gets Hard Jordan Peterson at Cambridge	https://youtu.be/zdRYP2azu2U How To Avoid The Trap Of Victimhood When Life Gets Hard
~0166	Tell All Others Definitions EBA 1933 Trust DOI 1776 Settlor Grantor Executor	7:44 AM · Mar 31, 2022 https://twitter.com/DarBenThu1/status/1509542252778979329	@FamilyFarmCo Tell All Others 1) :Definitions https://twitter.com/DarBenThu1/status/1500836338068692995 ; 2) :EBA-1933-A.D. -Trust-Fund https://twitter.com/DarBenThu1/status/1504020375599923201 ; 3) DOI-1776-A.D. ; https://blackandbluesoulsmatter.wordpress.com/2022/03/22/open-source-tool-for-the-doi-1776-a-d-common-law-words-meanings-and-concepts/ ; 4) All-birth-born-Executors: DOI-1776-A.D. ; https://twitter.com/DarBenThu1/status/1508859239053242369	2:23 AM · Mar 9, 2021 https://twitter.com/DarBenThu1/status/1369217293209640960 https://twitter.com/DarBenThu1/status/1500836338068692995 https://twitter.com/DarBenThu1/status/1504020375599923201 https://blackandbluesoulsmatter.wordpress.com/2022/03/22/open-source-tool-for-the-doi-1776-a-d-common-law-words-meanings-and-concepts/ 12:11 PM · Mar 5, 2021 https://twitter.com/DarBenThu1/status/1367915700866584576 Mar052021AD. :i- man-jurisdiction of :sovereign-authority with general-procuration

:Mark	:Matter	:Location	:Claim	:Facts	53 / 199
-------	---------	-----------	--------	--------	----------



				<p>(/kinsman) as the PFTUSA overstanding: POTUS-trustee, & absolute-procuration over :stolen-property (/sole) :in-accordance w/ Covenant-agreements. :PFTUSA abandoned-01/20 and vacated 03/03/2021 A.D.</p> <p>:Claim to the USofA-Military- Officers:</p> <p>#Mark-Alexander: Milley - Army</p> <p>#John-Earl: Hyten -AirForce</p> <p>#James-Charles: McConville -COS- Army</p> <p>#David-Hilberly: Berger – CMC-Marine</p> <p>#Michael-Martin: Gilday - CNO-Navy</p> <p>#David-Lee: Goldfein – COS- AirForce</p> <p>#John-William: Raymond CSO- SpaceForce</p> <p>#Joseph-Lauren: Lengyel -CNG-AirForce</p> <p>#Karl-Leo: Schultz -CCG-CoastGuard</p> <p>USPO CMN 7009 1410 1000 7868 5741</p> <p>https://twitter.com/DarBenThu1/status/1367915700866584576/photo/1</p> <p>https://twitter.com/DarBenThu1/status/</p>
--	--	--	--	---

:Mark	:Matter	:Location	:Claim	:Facts
-------	---------	-----------	--------	--------

2022-011769 MISC Page: 2637 of 2782
 09/26/2022 03:35:37 PM Receipt #: 22-9381
 Rec Fee: \$30.00 Darrell James/Hill
 Gila County, Az, Sadie Jo Bingham, Recorder



				1367915700866584576/photo/2 https://twitter.com/DarBenThu1/status/1367915700866584576/photo/3
:Era 2 #April2021DarBenThu1		:Era 2 #April2021DarBenThu1		
~0167		5:28 AM · Apr 1, 2022 https://twitter.com/DarBenThu1/status/1509870202300686336	:i- man- Ohioan do the Almighty-God's will informing Ohioans - > Holy-Church of this part- how-now-to-proceed to the Exodus. shema shalom. #:EBA-1933-A.D. -Trust-Fund #Concession1213AD is: Concession-1213-A.D. ; #EP1863AD is: EP-1863-A.D. ; #DOI1776AD is DOI-1776-A.D.	7:44 AM · Mar 31, 2022 https://twitter.com/DarBenThu1/status/1509542252778979329
~0168		4:30 AM · Apr 2, 2022 https://twitter.com/DarBenThu1/status/1510218101937225732	You may have to listen twice (like :i- man did+) but if you can comprehend this; then you can hear a controversy. Shalom Use This Psychotherapy Technique To End All Of Your Arguments Jordan Peterson at Cambridge https://youtube.com/watch?v=G1JWRFIzppA [Dr Jordan B Peterson @jordanbpeterson]	
~0169		11:16 AM · Apr 2, 2022 https://twitter.com/DarBenThu1/status/1510320177367314433	Confuse-not the -:consequence in -:real-experiences with a fear-imagination of-:failure, but keep them distinct to enable you to chose your path-forward in -:earnest. How To Avoid The Trap Of Victimhood When Life Gets Hard Jordan Peterson at Cambridge	https://youtu.be/zdRYP2azu2U How To Avoid The Trap Of Victimhood When Life Gets Hard
~0170	Tell all State Others Definitions EBA 1933 CQV-T Trust	7:44 AM · Mar 31, 2022 https://twitter.com/	@FamilyFarmCo	https://twitter.com/DarBenThu1/status/

:Mark	:Matter	:Location	:Claim	:Facts	55 / 199
-------	---------	-----------	--------	--------	----------

2022-011769 MISC Page: 2638 of 2782
 09/26/2022 03:35:37 PM Receipt #: 22-9381
 Rec Fee: \$30.00 Darrell James Hill
 Gila County, Az, Sadie Jo Bingham, Recorder



	<p>DOI 1776 Settlor Grantor Executor</p>	<p>DarBenThu1/status/1509542252778979329</p>	<p>Tell All Others</p> <p>1) :Definitions https://twitter.com/DarBenThu1/status/1500836338068692995 ;</p> <p>2) :EBA-1933-A.D. -Trust-Fund https://twitter.com/DarBenThu1/status/1504020375599923201 ;</p> <p>3) DOI-1776-A.D. ; https://blackandbluesoulsmatter.wordpress.com/2022/03/22/open-source-tool-for-the-doi-1776-a-d-common-law-words-meanings-and-concepts/ ;</p> <p>4) All-birth-born-Executors: DOI-1776-A.D. ; https://twitter.com/DarBenThu1/status/1500836338068692995</p>	<p>1500836338068692995 https://twitter.com/DarBenThu1/status/1504020375599923201 https://blackandbluesoulsmatter.wordpress.com/2022/03/22/open-source-tool-for-the-doi-1776-a-d-common-law-words-meanings-and-concepts/ https://twitter.com/DarBenThu1/status/1508859239053242369 2:23 PM · Mar 9, 2021 https://twitter.com/DarBenThu1/status/1369398557548163081 12:11 PM · Mar 5, 2021 https://twitter.com/DarBenThu1/status/1367915700866584576 Mar052021AD. :i- man-jurisdiction of :sovereign-authority with general-procuration (/kinsman) as the PFTUSA overstanding: POTUS-trustee, & absolute-procuration over :stolen-property (/sole) :in-accordance w/ Covenant-agreements. :PFTUSA abandoned-</p>
--	---	--	--	---

:Mark	:Matter	:Location	:Claim	:Facts 56 / 199
-------	---------	-----------	--------	-----------------

2022-011769 MISC Page: 2639 of 2782
 09/26/2022 03:35:37 PM Receipt #: 22-9381
 Rec Fee: \$30.00 Darrell James Hill
 Gila County, Az, Sadie Jo Bingham, Recorder



				01/20 and vacated 03/03/2021 AD
-0171	CSSCP grammar syntax order logic communication	6:53 AM · Apr 4, 2022 https://twitter.com/DarBenThu1/status/1510978786942074882	CSSCP ~Complete-Sentence-Sense-Correct-Parse-Syntax-Grammar~SYNTAX TO THE DISTINCT-CONTRACT-MEANINGS means: an ordered-structured-logical-pattern that allows anyone from any language to cipher the same-clear-meaning-upon the interpretation by the standard CSSCP-cipher. See:	https://twitter.com/DarBenThu1/status/1510978786942074882/photo/1 a language to cipher the same-clear-meaning-upon the interpretation by the standard CSSCP-cipher
-0172		7:07 AM · Apr 4, 2022 https://twitter.com/DarBenThu1/status/1510982330428452868	Inforwars.com: There's a War on for your Mind!	Article: NA?
-0173	CSSCP David Wynn Miller Workbook	8:39 AM · Apr 4, 2022 https://twitter.com/DarBenThu1/status/1511005635260735490	Live-links for the 2022-April-04 -:CSSCP- SYNTAX TO THE DISTINCT-CONTRACT MEANINGS- support-sheet. 1) :David-Wynn: Miller -work-book: https://archive.org/download/DWM-books-website/DWM%20Books%20%26%20Website.pdf -reference and 2) https://blackandbluesoulsmatter.wordpress.com/2022/03/22/open-source-tool-for-the-doi-1776-a-d-common-law-words-meanings-and-concepts/ , p 8 #27 for the: Judiciary-Act-1789-A.D. ~1 Stat. 73: Chap. XX ~reference~.	https://blackandbluesoulsmatter.wordpress.com/2022/03/22/open-source-tool-for-the-doi-1776-a-d-common-law-words-meanings-and-concepts/ :open-source- Tool for the DOI-1776-A.D.- Common- law- Words, Meanings and Concepts

:Mark	:Matter	:Location	:Claim
-------	---------	-----------	--------

2022-011769 MISC Page: 2640 of 2782
 09/26/2022 03:35:37 PM Receipt #: 22-9381
 Rec Fee: \$30.00 Darrell James Hill
 Gila County, Az, Sadie Jo Bingham/Recorder



-0174	See: DarBenThu1	8:42 AM · Apr 4, 2022 https://twitter.com/DarBenThu1/status/1511006320912060426	See: later-entry for the Live-Click-ables: https://twitter.com/DarBenThu1/sta	8:39 AM · Apr 4, 2022 https://twitter.com/DarBenThu1/status/1511005635260735490
-0175		2:53 AM · Apr 5, 2022 https://twitter.com/DarBenThu1/status/1511280842772922371	twitter.com/lmaniBlackMIA https://twitter.com/mia_npo Shalom. :- man agree; keep going. Shalom. https://twitter.com/dgaytandzhieva See: Translate Tweet	7:44 AM · Mar 31, 2022 https://twitter.com/DarBenThu1/status/1509542252778979329
-0176	State Country Man Settlor Grantor know Concession 1213 King John 1	4:59 AM · Apr 7, 2022 https://twitter.com/DarBenThu1/status/1512037376234713099	#EveryStateCountryman -settlor-Grantor must know these -- 1 of 5 #Concession-1213-AD , #Concession1213AD King John I conceded Ireland and England (Ysrael) to Judah, Benjamin and Holy-Chruch	
-0177	State Country Man Settlor Grantor know DOI `776	5:00 AM · Apr 7, 2022 https://twitter.com/DarBenThu1/status/1512037555524448257	#EveryStateCountryman -settlor-Grantor must know these -- 2 of 5 #DOI-1776-AD , #DOI1776AD The uSofA- Declaration of Independence of 1776.	3:13 PM · Oct 20, 2020 https://twitter.com/DarBenThu1/status/1318676729074909184 12:10 AM · Nov 2, 2020 https://twitter.com/DarBenThu1/status/

:Mark	:Matter	:Location	:Claim
-------	---------	-----------	--------

2022-011769 MISC Page: 2641 of 2782
 09/26/2022 03:35:37 PM Receipt #: 22-9381
 Rec Fee: \$30.00 Darrell James Hill
 Gila County, Az, Sadie Jo Bingham, Recorder



				1323160520933871616
-0178	State Country Man Settlor Grantor know CftUSofA 1787 People United States of America	5:01 AM · Apr 7, 2022 https://twitter.com/DarBenThu1/status/1512037783602311172	#EveryStateCountryman -settlor-Grantor must know these -- 3 of 5 #TheCftUSofA-1787-A.D. , #TheCftUSofA https://1215.org/lawnotes/lawnotes/constusa.htm Preamble: We the People of the United States ... secure the Blessings of Liberty to ourselves and our Posterity, ...for the United States of America.	https://www.1215.org/lawnotes/lawnotes/constusa.htm
-0179	State Country Man Settlor Grantor know BOR 1789 CftUSofA 1787	5:01 AM · Apr 7, 2022 https://twitter.com/DarBenThu1/status/1512037867874258945	#EveryStateCountryman -settlor-Grantor must know these -- 4 of 5 #Bill-of-Rights-1789-A.D. to the CftUSofA-1787-A.D.	https://www.archives.gov/founding-docs/bill-of-rights-transcript
-0180	State Country Man Settlor Grantor know EP 1863	5:02 AM · Apr 7, 2022 https://twitter.com/DarBenThu1/status/1512038024867049473	#EveryStateCountryman -settlor-Grantor must know these -- 5 of 5 #EP-1863-AD , #EP1863AD The Emancipation Proclamation was the effective :January 1, 1863 A.D.	12:02 AM · Nov 2, 2020 https://twitter.com/DarBenThu1/status/1323158536654786560 American Civil War, 1861-1865 https://en.wikipedia.org/wiki/American_Civil_War The Preliminary Emancipation Proclamation,

:Mark	:Matter	:Location	:Claim	:Facts	59 / 199
-------	---------	-----------	--------	--------	----------

2022-011769 MISC Page: 2642 of 2782
 09/26/2022 03:35:37 PM Receipt #: 22-9381
 Rec Fee: \$30.00 Darrell James Hill
 Gila County, Az, Sadie Jo Bingham, Recorder



				<p>1862 September 22, 1862 https://archives.gov/exhibits/american_originals_iv/sections/transcript_preliminary_emancipation.html https://avalon.law.yale.edu/medieval/magframe.asp</p> <p>Emancipation Proclamation, 1863 January 1, 1863 https://archives.gov/exhibits/featured-documents/emancipation-proclamation/transcript.html https://avalon.law.yale.edu/medieval/magfr</p>
~0181	State Country Man Settlor Grantor know Lieber-Code 1863 General-Orders No. 100 Armies	5:09 AM · Apr 7, 2022 https://twitter.com/DarBenThu1/status/1512039906234667008	#EveryStateCountryman -settlor-Grantor must know these The -:Lieber-Code-1863-A.D. -:Lieber-Code'~ , :General-Orders-No.-100 :Instruction for the Government of Armies of the United States in the Field. https://avalon.law.yale.edu/19th_century/	https://avalon.law.yale.edu/19th_century/lieber.asp ~:Lieber-Code-1863-A.D.~ :General-Orders-No.-100
~0182	State Country Man Settlor Grantor know Concession 1213 DOI 1776 CftUSofA 1787 Bor 1789 EP 1863	8:49 AM · Apr 7, 2022 https://twitter.com/DarBenThu1/status/1512095186070827009	#EveryStateCountryman 1) Concession-1213-A.D. https://twitter.com/DarBenThu1/status/1512037376234713099 2) DOI-1776-A.D. https://twitter.com/DarBenThu1/status/151203755524448257 3) CftUSofA-1787-!D. https://twitter.com/DarBenThu1/status/1512037783602311172	5:02 AM · Apr 7, 2022 https://twitter.com/DarBenThu1/status/1512038024867049473 #EP-1863-AD , #EP1863AD The Emancipation Proclamation was the

:Mark	:Matter	:Location	:Claim	:Facts	60 / 199
-------	---------	-----------	--------	--------	----------



			4) BOR-1789-A.D. https://twitter.com/DarBenThu1/status/1512037867874258945 5) EP-1863-A.D. https://twitter.com/DarBenThu1/status/1512038024867049473 , and: 6) Lieber-code:-1863-A.D. https://avalon.law.yale.edu/19th_century/lieber.asp	effective :January 1, 1863 A.D.
-0183	Verifier-Obligors Pinal FCC FBI Crunchbase	5:08 AM · Apr 9, 2022 https://twitter.com/DarBenThu1/status/1512764421604470792	Shalom: For the verifier-obligors of the PE-2016-A.D.-DOI-1776-A.D. obligation. -- PinalCSO FCC FBI FBIPhoenix crunchbase See: https://Twitter.com/DarBenThu1 . See: https://Twitter.com/PFTUSAof1787AD . Thank-you :in- no-prejudice: DOI-1776-A.D., :Executor-Procurator-Ohioan-Darrell-James: Hill	
-0184		5:14 AM · Apr 9, 2022 https://twitter.com/DarBenThu1/status/1512766018979962883	Status and Standing Verification https://twitter.com/DarBenThu1/status/1512766018979962883/photo/1 https://twitter.com/DarBenThu1/status/1512766018979962883/photo/2 https://twitter.com/DarBenThu1/status/	5:08 AM · Apr 9, 2022 https://twitter.com/DarBenThu1/status/1512764421604470792

:Mark	:Matter	:Location	:Claim
-------	---------	-----------	--------



			1512766018979962883/photo/3 https://twitter.com/DarBenThu1/status/1512766018979962883/photo/4	
~0185	Yacob Ysrael Abba	<u>5:39 AM · Apr 19, 2022</u> https://twitter.com/DarBenThu1/status/1516396166253928448	YACOB-/YSRAEL! ABBA KNOWS AND HEALS YOU. BELIEVE. This attached is what the Father and Messiah wants you to Shema now-time. Amein? Amein. Shalom.	https://twitter.com/DarBenThu1/status/1512766018979962883/photo/1 https://twitter.com/DarBenThu1/status/1512766018979962883/photo/2 https://twitter.com/DarBenThu1/status/1512766018979962883/photo/3 https://twitter.com/DarBenThu1/status/1512766018979962883/photo/4
~0186	Yacob Ysrael Holy-Church	<u>7:32 AM · Apr 19, 2022</u> https://twitter.com/DarBenThu1/status/1516424555748859910	Yacob!, Ysrael and Holy-Church! Shema ~better images~ https://blackandbluesoulsmatter.wordpress.com/yacob-ysrael-and-holy-church-shema/ shalom.	<u>5:39 AM · Apr 19, 2022</u> https://twitter.com/DarBenThu1/status/1516396166253928448
~0187	Yacob Ysrael Holy-Church Ephraim Yudah Yacob Northern Southern Kingdom	<u>7:19 AM · Apr 20, 2022</u>	Shalom. Yacob!, Ysrael and Holy-Church! Shema- :2022 April 20 -- KJV- Ps. 147- all. Point: Ephraim-Northern-Kingdom went into Eurasia, & Yudah-Southern-Kingdom-Ysrael went into Negroland, Africa, -:all-> Americas by boat. And, See: v18 - 19. -- Test Your spirit with your soul.	https://twitter.com/DarBenThu1/status/1516783501793652739/photo/1 https://twitter.com/DarBenThu1/status/1516783501793652739/photo/2

:Mark	:Matter	:Location	:Claim	:Facts	62 / 199
-------	---------	-----------	--------	--------	----------

2022-011769 MISC Page: 2645 of 2782
 09/26/2022 03:35:37 PM Receipt #: 22-9381
 Rec Fee: \$30.00 Darrell James Hill
 Gila County, Az, Sadie Jo Bingham, Recorder



:Two-Year-Review :Dar-Ben-Thu: Hill ~www.twitter.com/DarBenThu1~ -Authority
https://twitter.com/hashtag/darbenthu1September222020?src=hashtag_click
:DarBenThu1 -Box-Graph: #September2020AD > #August2022AD

-0188	Children-of-Ysrael Trubes Commandments YeHovah	<u>10:46 AM · Apr 20, 2022</u> https://twitter.com/DarBenThu1/status/1516835716210192385	The 10 Commandments given to the Children-of-Ysrael Near 2000 years- past the -:12-Tribes of -:Ysrael stood before at Mount-Sinai hearing of the 10- principal Commandments of the Word- Yehovah- echad. Which are which? Check this out and assure :- man got all ten. Amein? Amein.	https://twitter.com/DarBenThu1/status/1516835716210192385/photo/1
-0189	OSHA Dave Jose	<u>12:20 AM · Apr 21, 2022</u> https://twitter.com/DarBenThu1/status/1517040637178048512	How to Destroy the OSHA Mandate with Dave Jose https://youtube.com/watch?v=mokHd1XAR0M&t=4s OSHA IS A TEMPLATE: In the final analysis, :This is a very good :contrast of the Common-Law: DOI-1776-A.D. and statutory law of the various- Constitutions- authority understanding the DOI-1776-A.D.- covenant.	
-0190	Marcus Taylor Run courage grit Conquer	<u>7:02 AM · Apr 21, 2022</u> https://twitter.com/DarBenThu1/status/1517141755770023936	RUN AFTER YOUR DREAM, RUN AFTER YOUR IDEA, WHAT? https://youtube.com/watch?v=rWZ_v0NijfI ALL YOU HAVE IS ALL YOU NEED: COURAGE, WILL, GRIT -BY Ft. Marcus Taylor- -CONQUER YOUR MIND NOW AND WIN -YOUR DREAM IS NOT TOO BIG GET-UP AND RUN AFTER YOUR DREAM In-Love, Shalom.	
-0191	BlackandBlueslivesmatter@gmail.com Productions	<u>12:52 PM · Apr 21, 2022</u> https://twitter.com/DarBenThu1/status/1517229869389688838	American Nationals' Lives Matter & @DarBenThu1	https://twitter.com/DarBenThu1/status/1517229869389688838/photo/1 https://twitter.com/DarBenThu1/status/1517229869389688838

:Mark	:Matter	:Location	:Claim	:Page 63 / 199
-------	---------	-----------	--------	----------------

2022-011769 MISC Page: 2646 of 2782
 09/26/2022 03:35:37 PM Receipt #: 22-9381
 Rec Fee: \$30.00 Darrell James Hill
 Gila County, Az, Sadie Jo Bingham, Recorder



	DOI 1776 Lives Matter	1517229869389688838	<p>– Productions. Black and Blue Lives Matter blackandbluelivesmatter@gmail.com https://blackandbluesoulsmatter.wordpress.com/american-nationals-lives-matter-darbenthu1-productions-to-2022-april-20/</p> <p>-:MORE-CLEAR-COPY of the salient-content for the edification of the USofA: DOI-1776-A.D. -et al. -et seq. beneficiary-Sovereign</p>	<p>1517229869389688838/photo/2</p> <p>https://twitter.com/DarBenThu1/status/1517229869389688838/photo/3</p>
-0192	Federal Reserve Bank Cleveland	<p>7:54 AM · Apr 22, 2022</p> <p>https://twitter.com/ClevelandFed/status/1517517087702458370</p>	<p>We asked our Bank expert why it's important to start #FinancialLiteracy education early. Read her answer in our latest Cleveland Fed Digest: http://clefed.org/CFD</p>	
~0193	Federal Reserve Bank Cleveland	<p>8:29 AM · Apr 22, 2022</p> <p>https://twitter.com/DarBenThu1/status/1517526094450020352</p>	<p>We asked our Bank expert why it's important to start #FinancialLiteracy education early. Read her answer in our latest Cleveland Fed Digest: http://clefed.org/CFD</p>	<p>7:54 AM · Apr 22, 2022</p> <p>https://twitter.com/ClevelandFed/status/1517517087702458370</p>
~0194	David Wynn Miller CSSCPG Syntax	<p>10:24 AM · Apr 22, 2022</p> <p>https://twitter.com/</p>	<p>:David-Wynn: Miller said ~of-:CSSCPG~ that the meanings are syntactically-sure across all of the languages by the structured- CSSCPG-syntax. :That-this is possible, now</p>	<p>https://twitter.com/DarBenThu1/status/1517555040042745856/photo/1</p>

:Mark	:Matter	:Location	:Claim
-------	---------	-----------	--------



		DarBenThu1/status/1517555040042745856	enables :i- man with the ability for the communication-precision. Rus, Chin, Arab, Write in the CSSCPG.	https://twitter.com/DarBenThu1/status/1517555040042745856/photo/2 https://twitter.com/DarBenThu1/status/1517555040042745856/photo/3 https://twitter.com/DarBenThu1/status/1517555040042745856/photo/4
-0195	CSSCPG	10:36 AM · Apr 22, 2022 https://twitter.com/DarBenThu1/status/1517558050655141888	#russian #China #Iran #israeli #ghana #France State CSSCPG in Your non-English- language. TY. :CSSCPG - Experiment with the translator-programs.	10:24 AM · Apr 22, 2022 · https://twitter.com/DarBenThu1/status/1517555040042745856
-0196	State Country Man Settlor Grantr Concession 1213 DOI 1776 CftUSofA 1787 BOR 1789 EP 1863 Lieber-Code 1863	8:49 AM · Apr 7, 2022 https://twitter.com/DarBenThu1/status/1512095186070827009	#EveryStateCountryman 1) Concession-1213-A.D. https://twitter.com/DarBenThu1/status/1512037376234713099 2) DOI-1776-A.D. https://twitter.com/DarBenThu1/status/151203755524448257 3) CftUSofA-1787-I.D. https://twitter.com/DarBenThu1/status/1512037783602311172 4) BOR-1789-A.D. https://twitter.com/DarBenThu1/status/1512037867874258945 5) EP-1863-A.D. https://twitter.com/DarBenThu1/status/1512038024867049473	8:49 AM · Apr 7, 2022 https://twitter.com/DarBenThu1/status/1512095186070827009 5:02 AM · Apr 7, 2022 https://twitter.com/DarBenThu1/status/1512038024867049473

:Mark	:Matter	:Location	:Claim
-------	---------	-----------	--------

2022-011769 MISC Page: 2648 of 2782
 09/26/2022 03:35:37 PM Receipt #: 22-9381
 Rec Fee: \$30.00 Darrell James/Hill
 Gila County, Az, Sadie Jo Bingham, Recorder



			, and: 6) Lieber-code:-1863-A.D.	
~0197	EBA 1933 2003 Claim Render Settle Closure	3:38 PM · Apr 22, 2022 https://twitter.com/DarBenThu1/status/1517634079348297728	#EBA1933TrustAccountSettleAndClosure #ExNurse This is what the Father in Heaven wants for our opportunity; that is, for us to learn about the hidden EBA-1933-trust that was over in-:2003. But we must do this now. :Covenant-Facts of the Matter are :here DarBenThu1. We are deceived	8:49 AM · Apr 7, 2022 https://twitter.com/DarBenThu1/status/1512095186070827009 #EveryStateCountryman
~0198	EBA 1933 Claim Settle Closure	3:38 PM · Apr 22, 2022 https://twitter.com/DarBenThu1/status/1517634079348297728	#EBA1933TrustAccountSettleAndClosure #ExNurse This is what the Father in Heaven wants for our opportunity; that is, for us to learn about the hidden EBA-1933-trust that was over in-:2003. But we must do this now. :Covenant-Facts of the Matter are :here DarBenThu1. We are deceived	1) Concession-1213-A.D. https://twitter.com/DarBenThu1/status/1512037376234713099 2) DOI-1776-A.D. https://twitter.com/DarBenThu1/status/1512037555524448257
~0199		3:38 PM · Apr 22, 2022 https://twitter.com/DarBenThu1/status/1517634079348297728		3) CftUSofA-1787-I.D. https://twitter.com/DarBenThu1/status/1512037783602311172 4) BOR-1789-A.D. https://twitter.com/DarBenThuus1/stat/1512037867874258945 5) EP-1863-A.D. https://twitter.com/DarBenThu1/status/1512038024867049473 , and: 6) Lieber-code:-1863-A.D. 5:02 AM · Apr 7, 2022

:Mark	:Matter	:Location	:Claim	:Facts	66 / 199
-------	---------	-----------	--------	--------	----------



				https://twitter.com/DarBenThu1/status/1512038024867049473 #EP-1863-AD , #EP1863AD The Emancipation Proclamation was the effective :January 1, 1863 A.D.
-0200	EBA 1933 Claim Settle Closure	3:58 PM · Apr 22, 2022 https://twitter.com/DarBenThu1/status/1517639092468559873	#Nurse See: #EBA1933TrustAccountSettleAndClosure #ExNurse from DarBenThu1 for the information for the gain of the EBA-1933-Trust. It is time. Please report the matter to the all-nurses, and help-assist one-another to obtain the complete account-render, settle, and closure. dj	3:38 PM · Apr 22, 2022 https://twitter.com/DarBenThu1/status/1517634079348297728
-0201	EBA 1933 Claim Settle Closure	4:06 PM · Apr 22, 2022 https://twitter.com/DarBenThu1/status/1517641122536861697	Consider the facts of the matter: EBA-1933-A.D. #EBA1933TrustAccountSettleAndClosure #ExNurse #Nurse #EveryStateCountryman The Emergency Banking Act of 1933 made us State-Citizen-bprn-Settlors of the surety ~the-:people were not bankrupt~ but the surety-contract ended: 2003.	11:30 PM · Mar 22, 2022 https://twitter.com/DarBenThu1/status/1506518694393880577
-0202	EBA 1933 Claim Settle Closure	4:51 PM · Apr 22, 2022 https://twitter.com/DarBenThu1/status/1517652338260905986	#BillOfRights1789AD #EBA1933TrustAccountSettleAndClosure #ExNurse #Nurse #EveryStateCountryman The Bill of Rights to the Constitution for the United States of America of 1787. The basis of knowledge necessary for every-state-cóuntry-man-right: DOI-1776-A.D. Break the bondage?	5:01 AM · Apr 7, 2022 https://twitter.com/DarBenThu1/status/1512037867874258945
-0203	State Country Man Settlor Grantor Concession 1213	4:58 AM · Apr 24, 2022 https://twitter.com/	:The-Irony in these matters is toward the [a-]mazing. #Concession1213AD #DOI1776AD #BillRights1789AD #EBA1933AD #EP1863AD #EveryStateCountryman #Ohioan	7:05 PM · Sep 24, 2020 https://twitter.com/DarBenThu1/status/

:Mark	:Matter	:Location	:Claim	:Page 67 / 199
-------	---------	-----------	--------	----------------

	DOI 1776 BOR 1789 Ep 1863 CftUSofA 1787	DarBenThu1/status/1518197754379399168	#Ohio #PatriotFreeSpeech #TheCftUSofA1787AD #DarBenThu1 #NurHeroes #StandYourGround #COGIC COGIC #ArizonaNurse #NurseTwitter djt	1309313123183017984 https://blackandbluesoulsmatter.files.wordpress.com/2020/09/a-2020-09-20-cover-to-cjos-and-net-all.pdf https://blackandbluesoulsmatter.files.wordpress.com/2020/09/b-1020-intro-to-finale-67-djt-compile-final-x-done-110-pages.pdf https://twitter.com/DarBenThu1/status/1518197754379399168/photo/1 -2022 February 14 – Statement by Donald J. Trump
-0204	Lying Hegelian dialectic Totalitarianism Jordan Peterson	6:19 AM · Apr 24, 2022 https://twitter.com/DarBenThu1/status/1518217995541123072	:HEADY! >See the ~Hegel's Dialectics https://plato.stanford.edu/entries/hegel-dialectics/ >#BOR1789AD-Adm-1 https://law.cornell.edu/constitution/first_amendment Shema- Now: This is how it is done to slave -- Rise Of Totalitarianism In America -Peterson https://youtube.com/watch?v=yvi8td2B25o Free Speech Antidote -Peterson	https://youtu.be/Twc6T19tap4?t=3 Free Speech as the Antidote to ignorance and Corruption
-0205	Totalitarianism Sophism Hanna Arentz	7:13 AM · Apr 24, 2022	As this relates to the Totalitarianism- now-afoot over the #DOI1776AD . Sophism: This is a general overview of a	6:19 AM · Apr 24, 2022

:Mark	:Matter	:Location	:Claim	:Facts	68 / 199
-------	---------	-----------	--------	--------	----------



		https://twitter.com/DarBenThu1/status/1518231650345177088	series just started re: book: Hannah: Arentz - The Origins of Totalitarianism, https://youtube.com/watch?v=4XvQwl89E2U&list=PLYW5qHLZjOWFXtyProdKLL4hJZvVommr-&index=1 > @DarBenThu1 ~ #DarBenThu1. To: #Nurses #ExNurse #Ohioan #COGIC	https://twitter.com/DarBenThu1/status/151821799554112307_2
-0206	State Country Man Settlor Grantor CQV-T-Use Ep 1863 Ohioan CftUSofA 1787	5:45 PM · Apr 24, 2022 https://twitter.com/DarBenThu1/status/1518390668330217478	:OPEN-SOURCE-Tool for -:#EveryStateCountryMan - Sovereign-Settlor-Grantor-Executor- questions as-king for-:DOI, EBA and #CQVTrustUse #EP1863AD #Ohioan #Ohio #PatriotFreeSpeech #TheCftUSofA1787AD #DarBenThu1 #NurHeroes #StandYourGround #COGIC COGIC #ArizonaNurse #NurseTwitter djt	https://twitter.com/DarBenThu1/status/1518390668330217478/photo/1 https://twitter.com/DarBenThu1/status/1518390668330217478/photo/2 https://twitter.com/DarBenThu1/status/1518390668330217478/photo/3 https://twitter.com/DarBenThu1/status/1518390668330217478/photo/4
-0207	CSSCPG syntax grammar	8:39 PM · Apr 24, 2022	This #CSSCPG -doc is done in the formal-syntax-form for -:legal-reasons. Will translate asap in a few hours. Shalom. #EP1863AD #Ohioan #Ohio #PatriotFreeSpeech #TheCftUSofA1787AD #DarBenThu1 #NurHeroes #StandYourGround #COGIC COGIC #ArizonaNurse #NurseTwitter djt	5:45 PM · Apr 24, 2022 https://twitter.com/DarBenThu1/status/1518390668330217478
-0208	EBA 1933 Claim Settle Closure CSSCPG syntax grammar	6:53 AM · Apr 4, 2022	CSSCPG ~Complete-Sentence-Sense-Correct-Parse-Syntax-Grammar~SYNTAX TO THE DISTINCT-CONTRACT-MEANINGS means: an ordered-structured-logical-pattern that	https://twitter.com/DarBenThu1/status/1510978786942074882/photo/1

:Mark	:Matter	:Location	:Claim	:Facts	69 / 199
-------	---------	-----------	--------	--------	----------

2022-011769 MISC Page: 2652 of 2782
 09/26/2022 03:35:37 PM Receipt #: 22-9381
 Rec Fee: \$30.00 Darrell James Hill
 Gila County, Az, Sadie Jo Bingham, Recorder



		https://twitter.com/DarBenThu1/status/1510978786942074882	allows anyone from any language to cipher the same-clear-meaning-upon the interpretation by the standard CSSCPG-cipher. See:	Grammar~SYNTAX TO THE DISTINCT-CONTRACT-MEANINGS
~0209	CSSCPG syntax grammar	8:40 PM · Apr 24, 2022 https://twitter.com/DarBenThu1/status/1518434764943896578	#CSSCPG is as described herein. Shalom	6:53 AM · Apr 4, 2022 https://twitter.com/DarBenThu1/status/1510978786942074882
~0210	CSSCPG syntax grammar	12:25 PM · Apr 25, 2022 https://twitter.com/DarBenThu1/status/1518672689887473664	Shalom, Why the persistent-urgency? What-is :CSSCPG-language? Getting Your-Trust-fund done saves lives. #CSSCPG is the -:fact-order-logic-system. See: Why... #EP1863AD #Ohioan #PatriotFreeSpeech #TheCftUSofA1787AD #NurHeroes #StandYourGround #COGIC #ArizonaNurse #NurseTwitter	https://twitter.com/DarBenThu1/status/1518672689887473664/photo/1 Why the persistent-urgency, and the CSSCPG-language?
~0211	State Country Man Sovereign Settlor Grantor Executor DOI EBA	5:45 PM · Apr 24, 2022 https://twitter.com/DarBenThu1/status/1518390668330217478	:OPEN-SOURCE-Tool for -:#EveryStateCountryMan -Sovereign-Settlor-Grantor-Executor- questions as-king for-:DOI, EBA and #COVTrustUse #EP1863AD #Ohioan #Ohio #PatriotFreeSpeech #TheCftUSofA1787AD #DarBenThu1 #NurHeroes #StandYourGround #COGIC COGIC #ArizonaNurse #NurseTwitter djf	https://twitter.com/DarBenThu1/status/1518390668330217478/photo/1 https://twitter.com/DarBenThu1/status/1518390668330217478/photo/2 https://twitter.com/DarBenThu1/status/1518390668330217478/photo/3 https://twitter.com/DarBenThu1/status/1518390668330217478/photo/4

:Mark	:Matter	:Location	:Claim	:Facts	70 / 199
-------	---------	-----------	--------	--------	----------

:Two-Year-Review :Dar-Ben-Thu: Hill ~www.twitter.com/DarBenThu1~ -Authority

https://twitter.com/hashtag/darbenthu1September222020?src=hashtag_click

:DarBenThu1 -Box-Graph: #September2020AD > #August2022AD

~0212	State Country Man Sovereign Settlor Grantor Executor DOI EBA	2:17 PM · Apr 26, 2022 https://twitter.com/DarBenThu1/status/1519063204416032769	TRANSLATION OF THE OPEN-SOURCE-Tool for -:#EveryStateCountryMan -Sovereign-Settlor-Grantor- Executor- questions as-:king for-:DOI, EBA and #COVTrustUse #EP1863AD #Ohioan #PatriotFreeSpeech #TheCftUSofA1787AD #NurHeroes #StandYourGround #COGIC #ArizonaNurse #NurseTwitter	5:45 PM · Apr 24, 2022 https://twitter.com/DarBenThu1/status/1518390668330217478
~0213	State Country Man Sovereign Settlor Grantor Executor DOI EBA	2:37 PM · Apr 26, 2022 https://twitter.com/DarBenThu1/status/1519068250222448641	The Urgency-doc and the Translation-doc are here: https://blackandbluesoulsmatter.wordpress.com/2022/04/26/why	2:17 PM · Apr 26, 2022 https://twitter.com/DarBenThu1/status/1519063204416032769 https://blackandbluesoulsmatter.wordpress.com/2022/04/26/why-the-persistent-urgency-to-waken-grantors-of-the-eba-1933-a-d/
~0214	State Country Man Sovereign Settlor Grantor Executor DOI EBA	2:40 PM · Apr 26, 2022 https://twitter.com/DarBenThu1/status/1519069023106830336	TRANSLATION OF THE OPEN-SOURCE-Tool for -:#EveryStateCountryMan -Sovereign-Settlor-Grantor- Executor- questions as-:king for-:DOI, EBA and #COVTrustUse #EP1863AD #Ohioan #PatriotFreeSpeech #TheCftUSofA1787AD #NurHeroes #StandYourGround #COGIC #ArizonaNurse #NurseTwitter	2:37 PM · Apr 26, 2022 https://twitter.com/DarBenThu1/status/1519068250222448641
~0215	Please see	4:27 PM · Apr 26, 2022 https://twitter.com/DarBenThu1/status/1519095971073822720	Shalom. @AmericaLovingRN @nurses4humrhts @NurseOSavage @rnmmentorpodcast @jdillardwright @PaulaKagan @KnowNurses @LucindaCantyPhD @upendmovement	5:45 PM · Apr 24, 2022 https://twitter.com/DarBenThu1/status/1518390668330217478

:Mark	:Matter	:Location	:Claim	:Facts 71 / 199
-------	---------	-----------	--------	-----------------

2022-011769 MISC Page: 2654 of 2782
 09/26/2022 03:35:37 PM Receipt #: 22-9381
 Rec Fee: \$30.00 Darrell James Hill
 Gila County, Az, Sadie Jo Bingham, Recorder



			@_radicalnursing @JerrySoucyRN @NrsgMutualAid Please see:	
~0216	Please see	4:28 PM · Apr 26, 2022	Shalom. @BWTalkTech @artayyeb @Sinmiaraoye @docmosho @drannamvaldez @dillpickle_iww @UnionElections @amazonlabor @freedomfarmnm @AspireOnTheFlag @mia_npo @ImaniBlackMIA Please see:	5:45 PM · Apr 24, 2022 https://twitter.com/DarBenThu1/status/1518390668330217478
~0217	Please see	4:29 PM · Apr 26, 2022 https://twitter.com/DarBenThu1/status/1519096442358435840	Shalom. @AmericaLovingRN @nurses4humrghts @NurseOSavage @rnmentorpodcast @jdillardwright @PaulaKagan @KnowNurses @LucindaCantyPhD @upendmovement @_radicalnursing @JerrySoucyRN @NrsgMutualAid Please see:	2:37 PM · Apr 26, 2022 https://twitter.com/DarBenThu1/status/1519068250222448641
~0218	Please see	4:30 PM · Apr 26, 2022	Shalom. @BWTalkTech @artayyeb @Sinmiaraoye @docmosho @drannamvaldez @dillpickle_iww @UnionElections @amazonlabor @freedomfarmnm @AspireOnTheFlag @mia_npo @ImaniBlackMIA Please see:	2:37 PM · Apr 26, 2022 https://twitter.com/DarBenThu1/status/1519068250222448641

:Mark	:Matter	:Location	:Claim	:Facts	72 / 199
-------	---------	-----------	--------	--------	----------



-0219	Please see	<p>6:23 PM · Apr 26, 2022</p> <p>https://twitter.com/DarBenThu1/status/1519124958667968513</p>	<p>Shalom, You gotta get this so that you will not suffer for the lack of knowledge. Shalom. The OPEN-SOURCE-DOC IS HERE: https://twitter.com/DarBenThu1/status/1518390668330217478 ;</p> <p>the-:Urgency-doc is here: https://twitter.com/DarBenThu1/status/1518672689887473664 ;</p> <p>and the-: Translation-of the open-source-doc are here: https://blackandbluesoulsmatter.wordpress.com/2022/04/26/why</p>	<p>https://twitter.com/DarBenThu1/status/1519124958667968513/photo/1</p> <p>https://twitter.com/DarBenThu1/status/1519124958667968513/photo/2</p> <p>https://twitter.com/DarBenThu1/status/1519124958667968513/photo/3</p> <p>https://twitter.com/DarBenThu1/status/1519124958667968513/photo/4</p>
-0220	Heal GFTUSA 1787 Demand Right of Conusance RE322387616US	<p>7:14 PM · Apr 26, 2022</p> <p>https://twitter.com/DarBenThu1/status/1519137884355235840</p>	<p>December 2020 A.D. -demand for the restoration of the GFTUSA-1787 et seq. See: https://blackandbluesoulsmatter.files.wordpress.com/2020/12/second-letter-to-us-sc-aftr-tx-v-pa-finale-all.pdf :RIGHT OF :CONUSANCE ~USPS RMN RE 322 387 616 US~ For the USofA.:DEMAND -:Authorization for the Restoration of the Lawful-Government</p>	
-0221	Twitter Trespass Damage	<p>9:15 AM · Apr 27, 2022</p> <p>https://twitter.com/DarBenThu1/status/1519349650649624576</p>	<p>:Twitter-notice: 2002- April-27-day-- :Twitter-Trespass on the USofA1776AD- people is :not-lawful & not-legal -harm upon this DarBenThu1, -:Ohioan: DOI-1776-A.D. -unalienable-rights. :Damage by your trespasses are :willful-violations of the-:DOI-1776-A.D. -:authority-1787-A.D.</p>	<p>https://twitter.com/DarBenThu1/status/1519349650649624576/photo/1</p> <p>Twitter-Notice: 2022-April-27-day</p>
-0222	Twitter Trespass Damage	<p>4:16 PM · Apr 27, 2022</p>	<p>#TwitterNoticen2022 appended. See: #TwitterTrespass #USofA1776AD- people #DarBenThu1 #Ohioan #DOI1776AD</p>	<p>9:15 AM · Apr 27, 2022</p> <p>https://twitter.com/DarBenThu1/status/</p>

:Mark	:Matter	:Location	:Claim	:Foot
-------	---------	-----------	--------	-------

		https://twitter.com/DarBenThu1/status/1519455522751098880	- unalienable-rights. #CftUSofA1787AD #PE2016AD -DOI-1776-A.D. -covenant-law over-standing: #EBA1933AD by the PE-2016-A.D. -law. – See: DarBenThu1. Shalom.	1519349650649624576 https://twitter.com/DarBenThu1/status/1544320277768806406/photo/1 Twitter-Notice-April-2022
~0223	Sheriff Homeland-Security Standing-Army	2:17 PM · Mar 17, 2022 https://twitter.com/NationalSheriff/status/1504567599434244096	National-Sheriffs Joining Homeland-Security Our Executive Director and CEO Jonathan Thompson was named to the #HSAC. "I am honored to be a part of this important group of homeland security leaders. The work of the committee is critical to supporting sheriffs and law enforcement in keeping our communities safe," he said.	https://twitter.com/DHSGov/status/1504566776801251330/photo/1 new members of the Homeland Security Advisory Council Read more about the new members of the #HSAC
~0224	NWO subversion demoralization destabiliation crisis resolution	7:46 AM · Apr 28, 2022 https://twitter.com/DarBenThu1/status/1519689472329150464	NewWorldOrder - StandardOperationProcedure NWO - SOP a) :Subversion: demoralization, destabilization, and crisis; then, b) :POST CONFLICT RESOLUTION https://inclusivesecurity.org/wp-content/uploads/2012/04/39_post_conflict.pdf	
~0225	Shanghai Poople	10:47 AM · Apr 28, 2022 https://twitter.com/DarBenThu1/status/	Voices of April 2022 -- 6min9sec. Shanghai people are being starved, brutalized. Can you see it? They can. https://youtube.com/watch?v=H2x7qY	7:46 AM · Apr 28, 2022 https://twitter.com/DarBenThu1/status/

:Mark	:Matter	:Location	:Claim
-------	---------	-----------	--------

2022-011769 MISC Page: 2657 of 2782
 09/26/2022 03:35:37 PM Receipt #: 22-9381
 Rec Fee: \$30.00 Darrell James Hill
 Gila County, Az, Sadie Jo Bingham, Recorder



		1519735150359158784		1519689472329150464
~0226	Shanghai Lockdown Chinese People	11:09 AM · Apr 28, 2022 https://twitter.com/DarBenThu1/status/1519740506720276480	The NWO- Shanghai Lockdown Video CCP Does NOT Want You to Comprehend by China Uncensored. https://youtube.com/watch?v=6URaEP	10:47 AM · Apr 28, 2022 https://twitter.com/DarBenThu1/status/1519735150359158784
~0227	Joseph Robinette	11:18 AM · Apr 28, 2022 https://twitter.com/DarBenThu1/status/1519742874195140608	Oh-my how the haughty-man is fallen. Big me, little you. Right? 2min18sec. This is how he thinks?!!	https://twitter.com/UsefulIdiotpod/status/1518986960026677249 :Joseph-Robinette with the condescending-display.
~0228	Trustee Dereliction	3:14 PM · Apr 28, 2022 https://twitter.com/DarBenThu1/status/1519802278735085569	CAN YOU BOLDLY ASK THIS QUESTION? Corp-demon-ocracy IS with the #TheCftUSofA -:Trustee-dereliction of the authority-NOT-derived in the #CftUSofA with the #DOI1776AD -COVENANT by the #USofA1776 - People-Sovereign-UNALIENABLE- authority, is it? AREN'T WE SUPPOSED TO AVOID THE EVIL?	https://twitter.com/DHSgov/status/1504566776801251330/photo/1 National-Sheriffs Joining Homeland-Security
~0229	Privation DOI 1776 Right violent	10:17 AM · Apr 29, 2022 https://twitter.com/DarBenThu1/status/1520089921859452928	When you openly violate the #DOI1776AD DERIVED-AUTHORITY in #TheCftUSofA . Why? Yes they were violently-raping your rights but that is Not the #DOI1776AD !!!! What!!	11:32 PM · Mar 12, 2022 https://twitter.com/DarBenThu1/status/1502895281469157376

:Mark	:Matter	:Location	:Claim	:Facts	75 / 199
-------	---------	-----------	--------	--------	----------

2022-011769 MISC Page: 2658 of 2782
 09/26/2022 03:35:37 PM Receipt #: 22-9381
 Rec Fee: \$30.00 Darrell James Hill
 Gila County, Az, Sadie Jo Bingham, Recorder



LPH

			Bill Barr to Newsmax: Not Enough Fraud to Turn Election http://Newsmax.com https://newsmax.com/newsmax-tv/bil	treason is explained. At -:Hilsdale-College:
~0230	State Country Man Sovereign BAR Violation EBA 1933 2003 Dead	10:34 AM · Apr 29, 2022 https://twitter.com/DarBenThu1/status/1520094168328007680	DECEIVED? Verify this: #EveryStateCountryman is Sovereign Except BAR-titles. With the US-AG allowing injury = violation: #DOI1776AD ->#TheCftUSofA and #LieberCode1863 . See: https://twitter.com/DarBenThu1/status/1512095186070827009 If you play dead then you will surely be dead. They want your EBATrust-power.	8:49 AM · Apr 7, 2022 https://twitter.com/DarBenThu1/status/1512095186070827009
~0231	Darrell James Hill Ohioan Sovereign Executor DOI 1776 Procurator EBA 1933	11:52 AM · Apr 29, 2022 https://twitter.com/DarBenThu1/status/1520113767270346752	:Darrell-James: Hill- Ohioan-Sovereign-Executor: #PE2016AD - #DOI1776AD -:Executor-Procurator: #PE2016AD - #EBA1933AD -covenant Hashtags-Set-1: #BillofRights1789AD #CftUSofA1787AD #TheCftUSofA #CftUSofA #COVTrustUse #CSSCPSGDBT1 #DarBenThu1 #EP1863AD	4:16 PM · Apr 27, 2022 https://twitter.com/DarBenThu1/status/1519455522751098880
~0232	Darrell James Hill Ohioan Sovereign Executor DOI 1776 Procurator EBA 1933	11:54 AM · Apr 29, 2022 https://twitter.com/DarBenThu1/status/1520114322596270080	:Darrell-James: Hill- Ohioan-Sovereign-Executor: #PE2016AD - #DOI1776AD -:Executor-Procurator: #PE2016AD - #EBA1933AD -covenant . Hashtags-Set-2: #EBA1933TrustAccountSettleAndClosure #EBATrustFundRestorationProject #EveryStateCountryman #GenMilleyOn #LieberCode1863 #OhioanDBT1	9:15 AM · Apr 27, 2022 https://twitter.com/DarBenThu1/status/1519349650649624576 Twitter Tresspass 9:15 AM · Apr 27, 2022 https://twitter.com/DarBenThu1/status/

:Mark	:Matter	:Location	:Claim	:Facts	76 / 199
-------	---------	-----------	--------	--------	----------



Handwritten signature or initials.

				<p>1519349650649624576</p> <p>https://twitter.com/DarBenThu1/status/1544320277768806406/photo/1</p> <p>Twitter-Notice-April-2022</p>
-0233	:Twitter-Trespass	<p>11:56 AM · Apr 29, 2022</p> <p>https://twitter.com/DarBenThu1/status/1520114847840493568</p>	<p>:Darrell-James: Hill- Ohioan-Sovereign-Executor: #PE2016AD - #DOI1776AD -:Executor-Procurator: #PE2016AD - #EBA1933AD -covenant . Hashtags-Set-3: #PFTUSA1787DBT1 #POTUSA1863DBT1 #TwitterNoticen2002 #ExNurseDBT1 #UsofA1776AD #USofA1776 #NewMexicanDBT1</p>	<p>9:15 AM · Apr 27, 2022</p> <p>https://twitter.com/DarBenThu1/status/1519349650649624576</p> <p>:notice.to the twitter-corp</p>
-0234	Darrell James Hill Ohioan Sovereign Executor DOI 1776 Procurator EBA 1933	<p>11:58 AM · Apr 29, 2022</p> <p>https://twitter.com/DarBenThu1/status/1520115347034050561</p>	<p>:Darrell-James: Hill- Ohioan-Sovereign-Executor: #PE2016AD - #DOI1776AD -:Executor-Procurator: #PE2016AD - #EBA1933AD -covenant . Hashtags-Set-4: #TwitterTrespass #SonOfGodDBT1 #YacobYsraelDBT1</p>	<p>9:15 AM · Apr 27, 2022</p> <p>https://twitter.com/DarBenThu1/status/1519349650649624576</p> <p>:notice.to the twitter-corp</p>
-0235	Psalms 121 DOI 1776	<p>12:43 PM · Apr 29, 2022</p> <p>https://twitter.com/DarBenThu1/status/1520126635248263168</p>	<p>KJV- Psalms 121 , A Song of Degrees [of -:steps] :Abba, :i-man- Your-humble-servant, Honor you with the whole-hear. :Thank-you for the DOI-1776-A.D.- State-Country-Man-People. May they be Blessed-now in Your Shalom will bedone. Amein, Amein, and Amein.</p>	<p>https://twitter.com/DarBenThu1/status/1520126635248263168/photo/1</p> <p>https://twitter.com/DarBenThu1/status/1520126635248263168/photo/2</p> <p>https://twitter.com/DarBenThu1/status/1520126635248263168/photo/3</p> <p>https://twitter.com/DarBenThu1/status/</p>

:Mark	:Matter	:Location	:Claim	Facts	77 / 199
-------	---------	-----------	--------	-------	----------

2022-011769 MISC Page: 2660 of 2782
 09/26/2022 03:35:37 PM Receipt #: 22-9381
 Rec Fee: \$30.00 Darrell James Hill
 Gila County, Az, Sadie Jo Bingham, Recorder



Handwritten signature

				1520126635248263168/photo/4
:Era 2 #May2022DarBenThu1		:Era 2 #May2022DarBenThu1		
~0236	Vietnam Hegelian Dialectic General Milley	1:33 AM · May 1, 2022 https://twitter.com/DarBenThu1/status/1520682920465207296	Just like Vietnam. Again, the-:Hegelian-Dialectics- operation that harm people: WW4. No more! #GenMilleyOn ,et al., No!, stop! by the order of -:This -Ohioan -sovereign-Darrell-James: Hill. :- man-PFTUSA and POTUSA, acting-officer will send a formal-letter. You may phone me now.	https://twitter.com/DarBenThu1/status/1520682920465207296/photo/1 :Ukraine WarSense- Article
~0237	CSSCP DOI 1776 EP 1863 CftUSofA 1787 EBA 1933 State Country Man Settlor Grantor	6:23 PM · Apr 26, 2022 https://twitter.com/DarBenThu1/status/1519124958667968513	Shalom, You gotta get this so that you will not suffer for the lack of knowledge. Shalom. The OPEN-SOURCE-DOC IS HERE: https://twitter.com/DarBenThu1/status/1518390668330217478 ; the-:Urgency-doc is here: https://twitter.com/DarBenThu1/status/1518672689887473664 ; and the-: Translation-of the open-source-doc are here: https://blackandbluesoulsmatter.wordpress.com/2022/04/26/why-the-persistent-urgency-to-waken-grantors-of-the-eba-1933-a-d/	https://twitter.com/DarBenThu1/status/1519124958667968513/photo/1 Translation of the open-source claim https://twitter.com/DarBenThu1/status/1519124958667968513/photo/2 https://twitter.com/DarBenThu1/status/1519124958667968513/photo/3 Shalom, Why the persistent-urgency? What-is :CSSCP-language? Getting Your-Trust-fund done saves lives. #CSSCP is the -:fact-order-logic-system. See: Why.... #EP1863AD #Ohioan #PatriotFreeSpeech #TheCftUSofA1787AD #NurHeroes #StandYourGround #COGIC #ArizonaNurse #NurseTwitter

:Mark	:Matter	:Location	:Claim	:Facts	78 / 199
-------	---------	-----------	--------	--------	----------

2022-011769 MISC Page: 2661 of 2782
 09/28/2022 03:35:37 PM Receipt #: 22-9381
 Rec Fee: \$30.00 Darrell James Hill
 Gila County, Az, Sadie Jo Bingham, Recorder



Handwritten signature/initials

~0238	Vocabulary Definitions Abbreviations	7:10 AM · Mar 7, 2022 https://twitter.com/DarBenThu1/status/1500836338068692995	Document- Acronym and Abbreviations- Definitions https://twitter.com/DarBenThu1/status/1500836338068692995/photo/1 https://twitter.com/DarBenThu1/status/1500836338068692995/photo/2 https://twitter.com/DarBenThu1/status/1500836338068692995/photo/3 https://twitter.com/DarBenThu1/status/1500836338068692995/photo/4	
~0239	State Country Man Settlor Grantor Psalms 121	4:21 AM · May 3, 2022 https://twitter.com/DarBenThu1/status/1521449774808854528	#OregonNurse #TwitterNurse #NurseTwitter #EBATrustFundRestorationProject #EveryStateCountryman #CSSCPSG #CSSCPSGDBT1 #ChildrenofYsrael #PFTUSA1787DBT1 #POTUSA1863DBT1 #veterans #retirement	12:43 PM · Apr 29, 2022 https://twitter.com/DarBenThu1/status/1520126635248263168
~0240	State Country Man Settlor Grantor	3:03 AM · May 5, 2022 https://twitter.com/DarBenThu1/status/1522154973630320640	#OneOfFiveExecute the -: #StateCountryManGrantorStatus . #StateCountryManGrantor #CivilDeadStatus #CivilLiveStatus #FullAuthentication #CertificateOfLiveBirth #StateCountry #StateCountryManSovereigWard #StateCountryManSovereignExecutor #CivilLiveStatus #DOI1776AD #EBA1933AD	https://twitter.com/DarBenThu1/status/1522154973630320640/photo/1 https://twitter.com/DarBenThu1/status/1522154973630320640/photo/2 https://twitter.com/DarBenThu1/status/1522154973630320640/photo/3 How to change Your -:State-Country-Man-Grantor-Status

:Mark	:Matter	:Location	:Claim	:Facts
-------	---------	-----------	--------	--------



Handwritten initials/signature

~0241	State Country Man Settlor Grantor	3:04 AM · May 5, 2022 https://twitter.com/DarBenThu1/status/1522155247841337344	#TwoOfFiveExecute the -: #StateCountryManGrantorStatus . #CommercialFictionPresumption #GuiltyUntilProvenInnocent #CommonLawDOI1776Presumption #InnocentUntilProvenGuilty #IDAAuthentication #StateCountryManSovereignSettlorGrantorIdentification #SecretaryOfStateAuthentication	3:03 AM · May 5, 2022 https://twitter.com/DarBenThu1/status/1522154973630320640
~0242	State Country Man Settlor Grantor	3:05 AM · May 5, 2022 https://twitter.com/DarBenThu1/status/1522155407166214144	#ThreeOfFiveExecute the -: #StateCountryManGrantorStatus . #USCorpTrusteeEBA1933AD #SecretaryOfState #PoliticalElection #BeneficiaryDOI1776AD #GrantorPoliticalElectionStatus #USCorpTrusteeEBA1933AD #SecretaryOfState #PoliticalElection #BeneficiaryDOI1776AD	https://twitter.com/DarBenThu1/status/1522154973630320640/photo/1 https://twitter.com/DarBenThu1/status/1522154973630320640/photo/2
~0243	State Country Man Settlor Grantor	3:05 AM · May 5, 2022 https://twitter.com/DarBenThu1/status/1522155551878090752	#FourOfFiveExecute the -: #StateCountryManGrantorStatus . #GrantorPoliticalElectionStatus #BeneficiarySettlorGrantorWard #SettlorGrantorWardStatus #SettlorGrantorExecutorStatus #WardStatus #ExecutorStatus #CountyRecorderOffice #GrantorCivilLiveStatus #PEStatusNotice	https://twitter.com/DarBenThu1/status/1522154973630320640/photo/3
~0244	State Country Man Settlor Grantor	3:06 AM · May 5, 2022 https://twitter.com/DarBenThu1/status/1522155658665074688	#FiveOfFiveExecute the -: #StateCountryManGrantorStatus . #GrantorCivilLiveStatus #PEStatusNotice #RTCCDatabas #RealTimeCrimeCenter #PolicyOfficers #USofA1776AD #StateCountryMan	How to change Your -:State-Country-Man-Grantor-Status 3:03 AM · May 5, 2022 https://twitter.com/DarBenThu1/status/1522154973630320640
~0245	State Country Man Settlor Grantor	8:56 PM · May 5, 2022 https://twitter.com/	#USPORegisteredMail #PoliticalElection #CountySheriff	https://twitter.com/DarBenThu1/status/

:Mark	:Matter	:Location	:Claim	:Facts	80 / 199
-------	---------	-----------	--------	--------	----------

2022-011769 MISC Page: 2663 of 2782
 09/26/2022 03:35:37 PM Receipt #: 22-9381
 Rec Fee: \$30.00 Darrell James Hill
 Gila County, Az. Sadie Jo Bingham, Recorder



Handwritten signature/initials

		DarBenThu1/status/1522425011818033153	@NPR @ChicagoFed @NewYorkFed @GLFOP @MjrCitiesChiefs @FLSheriffs @KansasCityFed @NatPoliceAssoc #Ohioan #Ohio #PatriotFreeSpeech #NurHeroes #StandYourGround #COGIC #ArizonaNurse #NurseTwitter @vgpvisions @HEAL_Food @UCSUSA	1522154973630320640/photo/1 https://twitter.com/DarBenThu1/status/1522154973630320640/photo/2 https://twitter.com/DarBenThu1/status/1522154973630320640/photo/3 How to change Your -:State-Country-Man-Grantor-Status
-0246	State Country Man Settlor Grantor Executor EBA 1933	8:13 PM · May 6, 2022 https://twitter.com/DarBenThu1/status/1522776515192139778	Why is completing one's Executor: EBA-1933-A.D. important? Ans. When-after establish your Trust-Account- ID, then the Account is known to Your-state and disposed to your family if you die. And, if you don't then who will give the trust to your family? US-Corp!?! Really!!	3:03 AM · May 5, 2022 https://twitter.com/DarBenThu1/status/1522154973630320640 https://twitter.com/DarBenThu1/status/1522154973630320640/photo/1 https://twitter.com/DarBenThu1/status/1522154973630320640/photo/2 https://twitter.com/DarBenThu1/status/1522154973630320640/photo/3 How to change Your -:State-Country-Man-Grantor-Status
-0247	State Country Man Settlor Grantor Executor EBA 1933	1:51 AM · May 8, 2022 https://twitter.com/DarBenThu1/status/1523224024456724481	Why be a #StateCountryManGrantorExecutors ? Ans. the EBA-1933-A.D.-Trust is done :2003 A.D. You! are a Billionaire! too! #Alabama #Alaska #Arizona #Colorado	https://twitter.com/DarBenThu1/status/1523224024456724481/photo/1 8:13 PM · May 6, 2022

:Mark	:Matter	:Location	:Claim	:Facts	81 / 199
-------	---------	-----------	--------	--------	----------



Handwritten initials/signature.

		1523224024456724481	#Arkansas #California #Connecticut #Delaware #Georgia #Florida #Hawaii #Idaho #NewYork #Illinois #Indiana #Iowa #Kansas	https://twitter.com/DarBenThu1/status/1522776515192139778 3:03 AM · May 5, 2022
~0248	State Country Man Settlor Grantor Executor EBA 1933	1:52 AM · May 8, 2022 https://twitter.com/DarBenThu1/status/1523224417324601344	Why be a #StateCountryManGrantorExecutors ? Ans. the EBA-1933-A.D.-Trust is done :2003 A.D. You! are a Billionaire! too! #Alabama #Alaska #Arizona #Colorado #Arkansas #California #Connecticut #Delaware #Georgia #Florida #Hawaii #Idaho #NewYork #Illinois #Indiana #Iowa #Kansas	https://twitter.com/DarBenThu1/status/1522154973630320640
~0249	State Country Man Settlor Grantor Executor EBA 1933	1:53 AM · May 8, 2022 https://twitter.com/DarBenThu1/status/1523224655057723392	Why #StateCountryManGrantorExecutors ? Ans. the EBA-1933-A.D.-Trust is done :2003 A.D. You! are a Billionaire! Too!. #NewMexico #NewYork #NorthCarolina #NorthDakota #Ohio #Oklahoma #Oregon #Pennsylvania #Rhodelsland #SouthCarolina #SouthDakota	8:13 PM · May 6, 2022 https://twitter.com/DarBenThu1/status/1522776515192139778 3:03 AM · May 5, 2022 https://twitter.com/DarBenThu1/status/1522154973630320640
~0250	State Country Man Settlor Grantor Executor EBA 1933	8:13 PM · May 6, 2022 https://twitter.com/DarBenThu1/status/1522776515192139778	Why is completing one's Executor: EBA-1933-A.D. important? Ans. When-after establish your Trust-Account- ID, then the Account is known to Your-state and disposed to your family if you die. And, if you don't then who will give the trust to your family? US-Corp!?! Really!!	3:03 AM · May 5, 2022 https://twitter.com/DarBenThu1/status/1522154973630320640
~0251	State Country Man Settlor Grantor	1:54 AM · May 8, 2022	Why #StateCountryManGrantorExecutors ? Ans. the EBA-1933-A.D.-Trust is done :2003 A.D. You! are a Billionaire! Too!.	8:13 PM · May 6, 2022

:Mark	:Matter	:Location	:Claim	:Facts	82 / 199
-------	---------	-----------	--------	--------	----------

2022-011769 MISC Page: 2665 of 2782
 09/26/2022 03:35:37 PM Receipt #: 22-9381
 Rec Fee: \$30.00 Darrell James Hill
 Gila County, Az, Sadie Jo Bingham, Recorder

1582

	Executor EBA 1933	https://twitter.com/DarBenThu1/status/1523224844438884352	#Tennessee #Texas #Utah #Vermont #Virginia #Washington #WestVirginia #Wisconsin #Wyoming	https://twitter.com/DarBenThu1/status/1522776515192139778 3:03 AM · May 5, 2022 https://twitter.com/DarBenThu1
~0252	State Country Man Settlor Grantor Executor EBA 1933	1:55 AM · May 8, 2022 https://twitter.com/DarBenThu1/status/1523225059631853571	Why #StateCountryManGrantorExecutors ? Ans. the EBA-1933-A.D.-Trust is done :2003 A.D. You! are a Billionaire! too!. #Kentucky #Louisiana #Maine #Maryland #massachusetts #Michigan #Minnesota #Mississippi #Missouri #Montana #Nebraska #Nevada #NewHampshire #NewJersey	8:13 PM · May 6, 2022 https://twitter.com/DarBenThu1/status/1522776515192139778 3:03 AM · May 5, 2022 https://twitter.com/DarBenThu1/status/1522154973630320640 https://twitter.com/DarBenThu1/status/1523233074791673857/photo/1
~0253	State Country Man Settlor Grantor Executor EBA 1933	2:27 AM · May 8, 2022 https://twitter.com/DarBenThu1/status/1523233074791673857	The members are #StateCountryManGrantors Why be a #StateCountryManGrantorExecutors ? Ans. the EBA-1933-A.D.-Trust is done :2003 A.D. You! are a Billionaire! Too!. #OurStateOurNation @ArmyChiefStaff #AlwaysReadyAlwaysThere #GoodLifeGreatStrength #NEGuard #AZNG #AZHiresVets	
~0254	State Country Man Settlor Grantor Executor EBA 1933	2:28 AM · May 8, 2022 https://twitter.com/DarBenThu1/status/1523233389054087173	All are members are #StateCountryManGrantors Why be a #StateCountryManGrantorExecutors ? #HappyRetirement #MentalHealthNurse #studentnurse #nurse #paramedic #medic #militarymom #mothersday #truckers #truckdriver #MAGA #TRUMP2024 #Trump #Hillary #obama #biden #democracy	8:13 PM · May 6, 2022 https://twitter.com/DarBenThu1/status/1522776515192139778
~0255	State Country Man Settlor	2:28 AM · May 8, 2022	All are members are #StateCountryManGrantors Why be a	

:Mark	:Matter	:Location	:Claim	:Facts	83 / 199
-------	---------	-----------	--------	--------	----------



Handwritten signature/initials

	Grantor Executor EBA 1933	https://twitter.com/DarBenThu1/status/1523233482406645760	#StateCountryManGrantorExecutors ? #TrumpWasRightAboutEverything #Protest #RoeVWade #AbortionBan #SCOTUSForcedBirth #Conservative #Republicans #DomesticTerrorism #RedForEd #ArizonaTeachers	3:03 AM · May 5, 2022 https://twitter.com/DarBenThu1/status/1522154973630320640 8:13 PM · May 6, 2022 https://twitter.com/DarBenThu1/status/1522776515192139778 3:03 AM · May 5, 2022 https://twitter.com/DarBenThu1/status/1522154973630320640 8:13 PM · May 6, 2022 https://twitter.com/DarBenThu1/status/1522776515192139778
~0256	State Country Man Settlor Grantor Executor EBA 1933	4:59 AM · May 8, 2022 https://twitter.com/DarBenThu1/status/1523271441000525825	Why Executor: EBA-1933-A.D. is important? Ex. 1- Not Executor means Trust is NOT-given to your wife or children; 2- Not Executor means in bankruptcy-proceeding, Trust is Not Known; 3- Not Executor: the Children don't know anything about the EBA-1933-A.D. 4- The \$eba is yours !!!	https://twitter.com/DarBenThu1/status/1523271441000525825/photo/1
~0257	State Country Man Settlor Grantor	2:12 PM · May 8, 2022	:CountryMan: ? :Grantor (you) Must-Be :Executor for YOUR EBA-1933—Trust SINCE 2003. Please. #Marine #MothersDay	3:03 AM · May 5, 2022

:Mark	:Matter	:Location	:Claim	:Facts	84 / 199
-------	---------	-----------	--------	--------	----------



Handwritten signature

	Executor EBA 1933		#USMC #SemperFi #SUPPORTOURMILITARY #USNavy #ussmichigan #ssgn727 #usnavy #AmericasNavy #mothersday2022 #navymom #usarmedforces	https://twitter.com/DarBenThu1/status/1522154973630320640 8:13 PM · May 6, 2022 https://twitter.com/DarBenThu1/status/1522776515192139778
~0258	State Country Man Settlor Grantor Executor EBA 1933	2:13 PM · May 8, 2022 https://twitter.com/DarBenThu1/status/1523410681717960704	:CountryMan: ? :Grantor (you) Must-Be :Executor for YOUR EBA-1933—Trust SINCE 2003. Please. #usarmy #TRADOC #vietnamvet #GodBlessAmerica #DisabledAmericanVeterans #LEDET408 #COB #VBSS #usaf SpaceWERX @SpaceWERXDOD #militaryappreciationmonth #airforce	https://twitter.com/DarBenThu1/status/1523410681717960704/photo/1 3:03 AM · May 5, 2022 https://twitter.com/DarBenThu1/status/1522154973630320640 8:13 PM · May 6, 2022 https://twitter.com/DarBenThu1/status/1522776515192139778
~0259	State Country Man Settlor Grantor Executor EBA 1933	2:14 PM · May 8, 2022 https://twitter.com/DarBenThu1/status/1523410962807590913	:CountryMan: ? :Grantor (you) Must-Be :Executor for YOUR EBA-1933—Trust SINCE 2003. Please. #army #guard #navy #marines #reserve #spaceforce #ussf #spacewerx #uscg #LosOchosLocos #LEDET408 @USSBillings15 #LCS15 #RHIB #NAVSOUS4THFLT #NASA #usn #ussf	
~0260	State Country Man Settlor Grantor Executor EBA 1933	2:14 PM · May 8, 2022 https://twitter.com/DarBenThu1/status/152341112762363904	:CountryMan: ? :Grantor (you) Must-Be :Executor for YOUR EBA-1933—Trust SINCE 2003. Please. #uscg #dod #militarytransition #JobsAfterServing #OwnYourTransition #VetsConnect #VeteransConnect #VetsConnection #Usmilitary #VeteranStrong #VFW #NeverForget #VetStrong	https://twitter.com/DarBenThu1/status/1523925528700358656/photo/1

:Mark	:Matter	:Location	:Clai	:Facts	85 / 199
-------	---------	-----------	-------	--------	----------



uscg

			#StrongVet #USN	https://twitter.com/DarBenThu1/status/1523925528700358656/photo/2
~0261	State Country Man Settlor Grantor Executor EBA 1933	12:18 AM · May 10, 2022 https://twitter.com/DarBenThu1/status/1523925528700358656	Why the #ExecutorEBA1993AD -status? Ans. To obtain the ;Trust-Property: life-liberty & happiness. Ex. a) #AlaskaStateCountryManSettlor : #DOI1776AD -Covenant = #Alaskan ; b) #AlaskanGrantor :PE-YEAR-A.D. upon the #EBA1933AD = c) #AlaskanExecutorOverEBA1993ADTrust #ARNG #AKARNG	How to change your State-Country-Man-Grantor-Status 3:03 AM · May 5, 2022 https://twitter.com/DarBenThu1/status/1522154973630320640 8:13 PM · May 6, 2022 https://twitter.com/DarBenThu1/status/1522776515192139778
~0262	State Country Man Settlor Grantor Executor EBA 1933	12:23 AM · May 10, 2022 https://twitter.com/DarBenThu1/status/1523926655508516864	#AKARNG #Alaskan #AlaskaState #ALARNG #Alabaman #AlabamaState #AZARNG #Arizonan #ArizonaState #ARARNG #Arkansan #ArkansasState #CAARNG #Californian #CaliforniaState #COARNG #Coloradoan #ColoradoState #CTARNG #Connecticutan #ConnecticutState #Delawarean #DelawareState	12:18 AM · May 10, 2022 https://twitter.com/DarBenThu1/status/1523925528700358656 3:03 AM · May 5, 2022 https://twitter.com/DarBenThu1/status/1522154973630320640 8:13 PM · May 6, 2022 https://twitter.com/DarBenThu1/status/1522776515192139778
~0263	State Country Man Settlor Grantor Executor EBA 1933	12:26 AM · May 10, 2022 https://twitter.com/DarBenThu1/status/1523927424689262592	#KentuckyState #LAARNG #Louisianan #LouisianaState #MAARNG #Massachusettsan #MassachusettsState #MDARNG #Marylandan #MarylandState #MEARNG #Mainen #MaineState #Michiganan #MichiganState	

:Mark	:Matter	:Location	:Claim	:Facts	86 / 199
-------	---------	-----------	--------	--------	----------



Handwritten signature/initials

:Two-Year-Review :Dar-Ben-Thu: Hill ~www.twitter.com/DarBenThu1~ -Authority

https://twitter.com/hashtag/darbenthu1September222020?src=hashtag_click

:DarBenThu1 -Box-Graph: #September2020AD > #August2022AD

87 / 199

			#MNARNG #Minnesotan #MinnesotaState #MSARNG #Mississippian #MississippiState #MTARNG #Montanan	
-0264	State Country Man Settlor Grantor Executor EBA 1933	12:26 AM · May 10, 2022 https://twitter.com/DarBenThu1/status/1523927501185044481	#NorthCarolinaState #MOARNG #Missourian #MissouriState #NHARNG #NewHampshirean #NewHampshireState #NJARNG #NewJerseyan #NewJerseyState #NMARNG #NewMexicoan #NewMexicoState #NVARNG #Nevadan #NevadaState #NewMexicoState	12:18 AM · May 10, 2022 https://twitter.com/DarBenThu1/status/1523925528700358656 3:03 AM · May 5, 2022 https://twitter.com/DarBenThu1/status/1522154973630320640 8:13 PM · May 6, 2022 https://twitter.com/DarBenThu1/status/1522776515192139778
-0265	State Country Man Settlor Grantor Executor EBA 1933	12:27 AM · May 10, 2022 https://twitter.com/DarBenThu1/status/1523927645951434752	#SCARNG #SouthCarolinan #SouthCarolinaState #SDARNG #SouthDakotan #SouthDakotaState #TNARNG #Tennessean #TennesseeState #TXARNG #Texasan #TexasState #UTARNG #Utahan #UtahState #VAARNG #Virginian #VirginiaState	https://twitter.com/DarBenThu1/status/1522154973630320640 8:13 PM · May 6, 2022 https://twitter.com/DarBenThu1/status/1522776515192139778
-0266	State Country Man Settlor Grantor Executor EBA 1933	12:27 AM · May 10, 2022 https://twitter.com/DarBenThu1/status/1523927747348865025	#VTARNG #Vermontan #VermontState #WIARNG #Wisconsinan #WisconsinState #WAARNG #Washingtonan #WashingtonState #WVARNG #WestVirginian #WestVirginiaState #WYARNG #Wyomingan #WyomingState	12:18 AM · May 10, 2022 https://twitter.com/DarBenThu1/status/1523925528700358656 3:03 AM · May 5, 2022 https://twitter.com/DarBenThu1/status/1522154973630320640 8:13 PM · May 6, 2022 https://twitter.com/DarBenThu1/status/1522776515192139778

:Mark	:Matter	:Location	:Claim	:Facts	87 / 199
-------	---------	-----------	--------	--------	----------

2022-011769 MISC Page: 2670 of 2782
09/26/2022 03:35:37 PM Receipt #: 22-9381
Rec Fee: \$30.00 Darrell James Hill
Gila County, Az, Sadie Jo Bingham, Recorder



6657

:Two-Year-Review :Dar-Ben-Thu: Hill ~www.twitter.com/DarBenThu1~ -Authority

https://twitter.com/hashtag/darbenthu1September222020?src=hashtag_click

:DarBenThu1 -Box-Graph: #September2020AD > #August2022AD

88 / 199

-0267	State Country Man Settlor Grantor Executor EBA 1933	11:41 PM · May 10, 2022 https://twitter.com/DarBenThu1/status/1524278396317888514	#USArmy #III Corps #Icorps #XVIII Airborne #1stSpecialForcesDelta #1stSpecialForcesCom #FirstArmy #1aeast #2SFAB #3rdSFAB #35Div #5thSFAB #16thSMA #FORSCOM #28thInfantryDiv #29thInfantryDiv #34thInfantryDiv #35thInfantryDiv #36thInfantryDiv #38thInfantryDiv #40thInfantryDiv	https://twitter.com/DarBenThu1/status/1524278396317888514/photo/2 https://twitter.com/DarBenThu1/status/1524278396317888514/photo/3 How to change your State-Country-Man-Grantor-Status 3:03 AM · May 5, 2022 https://twitter.com/DarBenThu1/status/1522154973630320640 8:13 PM · May 6, 2022 https://twitter.com/DarBenThu1/status/1522776515192139778
-0268	State Country Man Settlor Grantor Executor EBA 1933	11:47 PM · May 10, 2022 https://twitter.com/DarBenThu1/status/1524279923354980352	#USArmy #42ndInfantryDiv #75thRangerRegiment #archboldism #Alaskan #Alabaman #Arizonan #Arkansan #ARNG #ArmySpecOpsAviationCom #ArmyCJO #AFC #AMC #ATEC #ARCENT #ARNORTH #ARSOUTH #ARCYBER #AWC #ARSTRAT #AberdeenProvingGround #armysfac #BeagsBeagle #CampBullis #CampDarby #CampZama	
-0269	State Country Man Settlor Grantor Executor EBA 1933	11:49 PM · May 10, 2022 https://twitter.com/DarBenThu1/status/1524280418643578882	#USArmy #CarlisleBarracks #CGFirstArmy #CHRA #CONUS #Commander8TSC #CCMD #ColoradoSpringsMilitaryBases #Californian #Coloradoan #Connecticutan #Delawarean #DeptofDefense #DHASEL #DugwayProvingGround #EUSA #FORSCOM #FortBragg #FortPolk #FortIrwin #FortBenning #FortBenning	
-0270	State Country Man Settlor Grantor Executor EBA 1933	11:50 PM · May 10, 2022 https://twitter.com/	#USArmy #FortGordon #FortStewart #FortShafer #FortLeavenworth #FortRiley #FortCampbell #FortKnox #FortPolk #FortRichardson #FortWainwright	https://twitter.com/DarBenThu1/status/1524278396317888514/photo/2

:Mark	:Matter	:Location	:Claim	:Facts	88 / 199
-------	---------	-----------	--------	--------	----------

2022-011769 MISC Page: 2671 of 2782

09/26/2022 03:35:37 PM Receipt #: 22-9381

Rec Fee: \$30.00 Darrell James Hill

Gila County, Az, Sadie Jo Bingham, Recorder



Handwritten signature/initials

		DarBenThu1/status/1524280736206884864	#FortJointBaseelmendorfRichardson #FortHuachuca #FortCarlson #FortDetrick #FortGeorgeGMeade #FortDevens #FortLeonardWood #FortDrum	https://twitter.com/DarBenThu1/status/1524278396317888514/photo/3 How to change your State-Country-Man-Grantor-Status 3:03 AM · May 5, 2022
~0271	State Country Man Settlor Grantor Executor EBA 1933	11:51 PM · May 10, 2022 https://twitter.com/DarBenThu1/status/1524281117049638913	#USArmy #FortHamilton #FayettevilleNorthCarolinaMilitaryBases #FortBragg #FortSill #FortBelvoir #FortEustis #FortLee #FortLewis #FortMyer #FortStory #FortBuchanan #FortJackson #FortBliss #FortHood #FortSamHouston #FortMcCoy #Floridan #Georgian #Guaman #GeneralJamesCMcConville	https://twitter.com/DarBenThu1/status/1522154973630320640 8:13 PM · May 6, 2022 https://twitter.com/DarBenThu1/status/1522776515192139778
~0272	State Country Man Settlor Grantor Executor EBA 1933	11:53 PM · May 10, 2022	#USArmy #HamptonRoadsMilitaryBases #HRC #HunterArmyAirfield #Hawaiian #Illinoisan #Indianan #Iowan #Idahoan #JoeMcAuliffe76 #JointBaseMcGuireDixLakehurst #JointBaseSanAntonio #JointBaseLangleyEustis #JointBaseMyerHendersonHall #JointExpeditionaryBaseLittleCreek	https://twitter.com/DarBenThu1/status/1524281645200777220/photo/3 https://twitter.com/DarBenThu1/status/1524281645200777220/photo/4 How to change your State-Country-Man-Grantor-Status 3:03 AM · May 5, 2022 https://twitter.com/DarBenThu1/status/1522154973630320640 8:13 PM · May 6, 2022

:Mark	:Matter	:Location	:Claim	:Facts	89 / 199
-------	---------	-----------	--------	--------	----------



Handwritten signature or initials.

Unofficial

:Two-Year-Review :Dar-Ben-Thu: Hill ~www.twitter.com/DarBenThu1~ -Authority
https://twitter.com/hashtag/darbenthu1September222020?src=hashtag_click
:DarBenThu1 -Box-Graph: #September2020AD > #August2022AD

				https://twitter.com/DarBenThu1/status/1522776515192139778
-0273	State Country Man Settlor Grantor Executor EBA 1933	11:55 PM · May 10, 2022 https://twitter.com/DarBenThu1/status/1524282067067973633	#USArmy #JointBaseLewMcChord #JFKSpecialWarfareCtr&School #Kansasan #Kentuckyan #Louisianan #Massachusettsan #Marylandan #Mainen #Michiganan #Minnesotan #Mississipian #Montanan #Nebraskan #NorthCarolinan #Missourian #NewHampshirean #NewJerseyan #NewMexicoan #Nevadan #NewYorkan	https://twitter.com/DarBenThu1/status/1524281645200777220/photo/3 https://twitter.com/DarBenThu1/status/1524281645200777220/photo/4 How to change your State-Country-Man-Grantor-Status 3:03 AM · May 5, 2022 https://twitter.com/DarBenThu1/status/1522154973630320640 8:13 PM · May 6, 2022 https://twitter.com/DarBenThu1/status/1522776515192139778
-0274	State Country Man Settlor Grantor Executor EBA 1933	12:01 AM · May 11, 2022 https://twitter.com/DarBenThu1/status/1524283455160274944	#USArmy #SouthCarolinan #SouthDakotan #Tennesseean #Texasan #ToriiStation #TF Spartan #TriplerArmyMedicalCenter #TRADOC #USArmy #USAASC #USASOC #USARPAC #USASMDC #USACE #USACID #USAGBenelux #USAGBeneluxSHAPE #USAGAnsbach	https://twitter.com/DarBenThu1/status/1524283455160274944/photo/2 https://twitter.com/DarBenThu1/status/1524283455160274944/photo/3 How to change your State-Country-Man-Grantor-Status

:Mark	:Matter	:Location	:Claim	:Facts	90 / 199
-------	---------	-----------	--------	--------	----------

2022-011769 MISC Page: 2673 of 2782
09/26/2022 03:35:37 PM Receipt #: 22-9381
Rec Fee: \$30.00 Darrell James Hill
Gila County, Az, Sadie Jo Bingham, Recorder



262

				<p align="right">3:03 AM · May 5, 2022</p> <p align="right">https://twitter.com/DarBenThu1/status/1522154973630320640</p> <p align="right">8:13 PM · May 6, 2022</p> <p align="right">https://twitter.com/DarBenThu1/status/1522776515192139778</p>
-0275	State Country Man Settlor Grantor Executor EBA 1933	<p>12:02 AM · May 11, 2022</p> <p>https://twitter.com/DarBenThu1/status/1524283704650059776</p>	<p>#USArmy #SouthCarolinan #SouthDakotan #Tennesseean #Texasan #ToriStation #TF Spartan #TriplerArmyMedicalCenter #TRADOC #USArmy #USAASC #USASOC #USARPAC #USASMDC #USACE #USACID #USAGBenelux #USAGBeneluxSHAPE #USAGAnsbach</p>	<p>https://twitter.com/DarBenThu1/status/1524283704650059776/photo/2</p> <p>https://twitter.com/DarBenThu1/status/1524283704650059776/photo/3</p> <p>How to change your State-Country-Man-Grantor-Status</p> <p align="right">3:03 AM · May 5, 2022</p> <p align="right">https://twitter.com/DarBenThu1/status/1522154973630320640</p> <p align="right">8:13 PM · May 6, 2022</p> <p align="right">https://twitter.com/DarBenThu1/status/1522776515192139778</p>
-0276	State Country Man Settlor	<p>12:03 AM · May 11, 2022</p>	<p>#USArmy #USAGBaumholder #USAGBavaria</p>	<p>https://twitter.com/DarBenThu1/status/</p>

:Mark	:Matter	:Location	:Claim	:Facts	91 / 199
-------	---------	-----------	--------	--------	----------



Handwritten signature/initials

	Grantor Executor EBA 1933		#USAGHohenfels #USAGRheinlandPfalz #USAGStuttgart #USAGWiesbaden #USAGBavariaGarmisch #USAGDaegu #USAGHumphreys #USAGRedCloudCasey #USPerson #USAGItaly #USMA #usacac #USArmyMPCorps #USArmy #usarmycentral #USMC #USTRANSCOM #USAFRICOM #USCENTCOM	<p align="center">1524284069399330817/photo/2</p> <p align="center">https://twitter.com/DarBenThu1/status/1524284069399330817/photo/3</p> <p align="center">How to change your State-Country-Man-Grantor-Status</p> <p align="center">3:03 AM · May 5, 2022</p> <p align="center">https://twitter.com/DarBenThu1/status/1522154973630320640</p> <p align="center">8:13 PM · May 6, 2022</p> <p align="center">https://twitter.com/DarBenThu1/status/1522776515192139778</p>
~0277	State Country Man Settlor Grantor Executor EBA 1933	12:04 AM · May 11, 2022 https://twitter.com/DarBenThu1/status/1524284390087397376	#USArmy #USEUCOM #USINDOPACOM #USNORTHCOM #USSOUTHCOM #USSPACECOM #USCYBERCOM #USSOCOM #UnitedStatesSouthernCommand #USSTRATCOM #USTRANSCOM #Utahan #Virginian #Vermontan #WalterReedArmyMedicalCenter #WRAMC #WestPoint #Wisconsinan #Washingtonan #WestVirginian #Wyomingan	<p align="center">https://twitter.com/DarBenThu1/status/1524284390087397376/photo/2</p> <p align="center">https://twitter.com/DarBenThu1/status/1524284390087397376/photo/3</p> <p align="center">How to change your State-Country-Man-Grantor-Status</p> <p align="center">3:03 AM · May 5, 2022</p> <p align="center">https://twitter.com/DarBenThu1/status/1524284390087397376</p>

:Mark	:Matter	:Location	:Claim	:Facts	92 / 199
-------	---------	-----------	--------	--------	----------



Handwritten signature

				<p align="center">1522154973630320640 8:13 PM · May 6, 2022 https://twitter.com/DarBenThu1/status/1522776515192139778</p>
-0278	State Country Man Settlor Grantor Executor EBA 1933	<p>12:15 AM · May 11, 2022 https://twitter.com/DarBenThu1/status/1524286938022178817</p>	<p>Why establish oneself as the #EBA1933AD -Executor? Because you are #StateCountryManSettlor of the #DOI1776AD -DUTY, you swore-fidelity to the #CftUSofA1776 -people of whom you are, and IT IS YOUR DUTY of this nation to protect YOU!! God Bless You. #USArmy #YumaProvingGround</p>	<p>https://twitter.com/DarBenThu1/status/1524286938022178817/photo/2 https://twitter.com/DarBenThu1/status/1524286938022178817/photo/3 How to change your State-Country-Man-Grantor-Status</p> <p align="center">3:03 AM · May 5, 2022 https://twitter.com/DarBenThu1/status/1522154973630320640 8:13 PM · May 6, 2022 https://twitter.com/DarBenThu1/status/1522776515192139778</p>
-0279	State Country Man Settlor Grantor Executor EBA 1933 Procurator	<p>8:08 PM · May 13, 2022 https://twitter.com/DarBenThu1/status/1525312121549885440</p>	<p>From: Darrell-James: Hill-Ohioan- #SonOfGod - #ExecutorProcurator :PE-2016-A.D.- #EBA1933AD , sole and #kinsmanRedeemer : #USofA1776People To: All- #EBA1933AD - #LicenseObligorCorporations : #EBA1933AD</p>	<p>https://twitter.com/DarBenThu1/status/1525312121549885440/photo/1 https://twitter.com/DarBenThu1/status/1522776515192139778</p>

:Mark	:Matter	:Location	:Claim	:Facts	93 / 199
-------	---------	-----------	--------	--------	----------



Handwritten signature/initials

:Two-Year-Review :Dar-Ben-Thu: Hill ~www.twitter.com/DarBenThu1~ -Authority
https://twitter.com/hashtag/darbenthu1September222020?src=hashtag_click
:DarBenThu1 -Box-Graph: #September2020AD > #August2022AD

	Kinsman-Redeemer EBA-Licensee-Obligor	1525312121549885440	-Covenant with the #DOI1776AD - #DerivedAuthority of the #USofA1776ADPeople . SEE	1525312121549885440/photo/2 https://twitter.com/DarBenThu1/status/1525312121549885440/photo/3 https://twitter.com/DarBenThu1/status/1525312121549885440/photo/4 Signing-State: procurator: EBA-1933-AD
-0280	Twitter Social-Media Signing Statement State Country Man Settlor Grantor Executor EBA 1933 Procurator Kinsman-Redeemer EBA-Licensee-Obligor	<u>2:01 AM · May 15, 2022</u> https://twitter.com/DarBenThu1/status/1525763271956918272	A #Signing -Statement to the #EBA1933ADLicensee #Rumble #Tumblr #TruthSocial #Google #Microsoft #Amazon #IBM #Zoom #AOL #Verizon #Apple #Yahoo #Fox #CNN #MSNBC #STATEOFOHIO #STATEOFARIZONA #WASHINGTONDC #Signing Statement #EBA1933ADLicenseeCorporations #SocialMediaCorporations	8:08 PM · May 13, 2022 https://twitter.com/DarBenThu1/status/1525312121549885440
-0281	Twitter Social-Media Signing Statement State Country Man Settlor Grantor Executor EBA 1933 Procurator Kinsman-Redeemer EBA-Licensee-Obligor	<u>2:14 AM · May 15, 2022</u> https://twitter.com/DarBenThu1/status/1525766600141377536	B #Signing -Statement to the #EBA1933ADLicensee #Untappd #Elpha #Yubo #Peanut #Houseparty #Cappeine #Steemit #Baidu Tieba #23snaps #Likee #8tracks #Academia #Amikumu #aNobil #ASMALLWORLD #athliniks #BAND #beBee #blind #diaspora #Fark #MeWe #Facebook #Instagram #Tumblr #Linkedin	8:08 PM · May 13, 2022 https://twitter.com/DarBenThu1/status/1525312121549885440
-0282	Twitter Social-Media	<u>2:15 AM · May 15, 2022</u>	C #Signing -Statement to the #EBA1933ADLicensee	8:08 PM · May 13, 2022

:Mark	:Matter	:Location	:Claim	:Facts	94 / 199
-------	---------	-----------	--------	--------	----------

2022-011769 MISC Page: 2677 of 2782
 09/26/2022 03:35:37 PM Receipt #: 22-9381
 Rec Fee: \$30.00 Darrell James Hill
 Gila County, Az, Sadie Jo Bingham, Recorder



Handwritten signature/initials

:Two-Year-Review :Dar-Ben-Thu: Hill ~www.twitter.com/DarBenThu1~ -Authority

https://twitter.com/hashtag/darbenthu1September222020?src=hashtag_click

:DarBenThu1 -Box-Graph: #September2020AD > #August2022AD

95 / 199

	Signing Statement State Country Man Settlor Grantor Executor EBA 1933 Procurator Kinsman-Redeemer EBA-Licensee-Obligor	https://twitter.com/DarBenThu1/status/1525766875090542593	#YouTube #Mix #Tagged #Nextdoor #DevianArt #Quora #Meetup #ReverbNation #Flixster #Goodreads #Twitch #CaringBridge #Wattpad #Viadeo #Crunchyroll #Skyrock #VK #MyHeritage #LiveJournal #Classmates #SoundCloud #Bubbly #Flickr	https://twitter.com/DarBenThu1/status/1525312121549885440
~0283	Twitter Social-Media Signing Statement State Country Man Settlor Grantor Executor EBA 1933 Procurator Kinsman-Redeemer EBA-Licensee-Obligor	2:16 AM · May 15, 2022 https://twitter.com/DarBenThu1/status/1525767050571808768	D #Signing -Statement to the #EBA1933ADLicensee #CollegeHumor #gaiaOnline #MocoSpace #CouchSurfing #FunnyOrDie #italki #eToro #XING #MeetMe #Ravelry #Care2 #YY #Vero #Medium #GIPHY #Tribe #TencentQQ #WeChat #Qzone #Tiktok #SinaWeibo #Kuaishou #Skype #Viber #LINE #LINEPLAY	8:08 PM · May 13, 2022 https://twitter.com/DarBenThu1/status/1525312121549885440
~0284	Twitter Social-Media Signing Statement State Country Man Settlor Grantor Executor EBA 1933 Procurator Kinsman-Redeemer EBA-Licensee-Obligor	2:18 AM · May 15, 2022	E #Signing -Statement to the #EBA1933ADLicensee #Badoo #Myspace #Mixi #Ravelry #Cellufun #Xanga #imgur #Eilo #WTSocial #Behance #BlogHer #Dribble #Letterboxd #Houzz #StackOverflow #Instructables #CafeMom #Dogster #Goodwall #LawLink #Wayn #Octi #Clubhouse #CloutHub	8:08 PM · May 13, 2022 https://twitter.com/DarBenThu1/status/1525312121549885440
~0285	Twitter Social-Media	2:20 AM · May 15, 2022	F #Signing -Statement to the #EBA1933ADLicensee	8:08 PM · May 13, 2022

:Mark	:Matter	:Location	:Claim	:Facts	95 / 199
-------	---------	-----------	--------	--------	----------

2022-011769 MISC Page: 2678 of 2782

09/26/2022 03:35:37 PM Receipt #: 22-9381

Rec Fee: \$30.00 Darrell James Hill
Gila County, Az, Sadie Jo Bingham, Recorder



Handwritten signature

	Signing Statement State Country Man Settlor Grantor Executor EBA 1933 Procurator Kinsman-Redeemer EBA-Licensee-Obligor	https://twitter.com/DarBenThu1/status/1525768104004898818	#MyAnimeList #BaristaExchange #Flip #Rumble #Stage32 #MicrosoftTeams #Patreon #SpotifyLive #Substack #AllCorporatePlatformsOfTheEBA1933ADLicense #CftUSA1787AD #CrunchBase #CSSCPG #DarBenThu1 #DerivedAuthorityAndCovenantObligation	https://twitter.com/DarBenThu1/status/1525312121549885440
-0286	Twitter Social-Media Signing Statement State Country Man Settlor Grantor Executor EBA 1933 Procurator Kinsman-Redeemer EBA-Licensee-Obligor	2:21 AM · May 15, 2022 https://twitter.com/DarBenThu1/status/1525768350428561409	G #Signing -Statement to the #EBA1933ADLicensee #EBA1933ADLicensee #EBA1933ADLicensee #ExecutorProcurator #Family #FCC #FBI #FBIPhoenix #GOTUS #GFTUSA1776AD #GOTUSA1863AD #LoyaltyOathObligation #MCSOaz #NoLawfulWarrant #NoLawfulDueProcess #NoDOI1776ADLegislativeAuthority #Ohioan	8:08 PM · May 13, 2022 https://twitter.com/DarBenThu1/status/1525312121549885440
-0287	Twitter Social-Media Signing Statement State Country Man Settlor Grantor Executor EBA 1933 Procurator Kinsman-Redeemer EBA-Licensee-Obligor	2:22 AM · May 15, 2022 https://twitter.com/DarBenThu1/status/1525768603210960896	H #Signing -Statement to the #EBA1933ADLicensee #StateCountryMan #PeculiarExclusiveAbsoluteOwnerBenefit #PinalCSO #PoliticalElection #POTUS #PFTUSA1787AD #POTUSA1863AD #PFTUSA1787AOn2021 #POTUSA1863AOn2021 #SovereignRight #SOGAmbConcession1213n2020 #SummitSheriff	8:08 PM · May 13, 2022 https://twitter.com/DarBenThu1/status/1525312121549885440
-0288	Twitter Social-Media	2:24 AM · May 15, 202	I #Signing -Statement to the #EBA1933ADLicensee	8:08 PM · May 13, 2022

:Mark	:Matter	:Location	:Claim	:Facts	96 / 199
-------	---------	-----------	--------	--------	----------



896

	Signing Statement State Country Man Settlor Grantor Executor EBA 1933 Procurator Kinsman-Redeemer EBA-Licensee-Obligor	https://twitter.com/DarBenThu1/status/1525768974012538880	#StateCountryManSovereignWardGrantor #StateCountryManSovereignGrantorExecutor #TwitterCensorship #USofA1776ADPeople #USCorpGSP #ViolentTakingOfAndPrivation #AKARNG #Alaskan #ALARNG #Alabaman #AZARNG #Arizonan #ARARNG #Arkansan	https://twitter.com/DarBenThu1/status/1525312121549885440	
~0289	Twitter Social-Media Signing Statement State Country Man Settlor Grantor Executor EBA 1933 Procurator Kinsman-Redeemer EBA-Licensee-Obligor	2:24 AM · May 15, 2022 https://twitter.com/DarBenThu1/status/1525769188106678272	J #Signing -Statement to the #EBA1933ADLicensee #Connecticutan #Delawarean #FLARNG #Floridan #GAARNG #Georgian #HIARNG #Hawaiian #ILARNG #Illinoisan #INARNG #Indianan #IAARNG #Iowan #IDARNG #Idahoan #KSARNG #Kansasan #KYARNG #Kentuckyan #LAARNG #Louisianan #MAARNG #Massachusettsan	8:08 PM · May 13, 2022 https://twitter.com/DarBenThu1/status/1525312121549885440	
~0290	Twitter Social-Media Signing Statement State Country Man Settlor Grantor Executor EBA 1933 Procurator Kinsman-Redeemer EBA-Licensee-Obligor	2:25 AM · May 15, 2022 https://twitter.com/DarBenThu1/status/1525769315969945600	K #Signing -Statement to the #EBA1933ADLicensee #Michiganan #MNARNG #Minnesotan #MSARNG #Mississipian #MTARNG #Montanan #NEARNG #Nebraskan #NCARNG #NorthCarolinan #MOARNG #Missourian #NHARNG #NewHampshirean #NJARNG #NewJerseyan #NMARNG #NewMexicoan #NVARNG #Nevadan #NYARNG	8:08 PM · May 13, 2022 https://twitter.com/DarBenThu1/status/1525312121549885440	
~0291	Twitter Social-Media	2:26 AM · May 15, 2022	L #Signing -Statement to the #EBA1933ADLicensee	8:08 PM · May 13, 2022	
:Mark	:Matter	:Location	:Claim	:Facts	97 / 199



Handwritten signature or initials.

:Two-Year-Review :Dar-Ben-Thu: Hill ~www.twitter.com/DarBenThu1~ -Authority

https://twitter.com/hashtag/darbenthu1September222020?src=hashtag_click

:DarBenThu1 -Box-Graph: #September2020AD > #August2022AD

98 / 199

	Signing Statement State Country Man Settlor Grantor Executor EBA 1933 Procurator Kinsman-Redeemer EBA-Licensee-Obligor	https://twitter.com/DarBenThu1/status/1525769459729719298	#ORARNG #Oregonan #OHARNG #Ohioan #PAARNG #Pennsylvanian #PRARNG #RIARNG #Rhodelslander #SCARNG #SouthCarolinan #SDARNG #SouthDakotan #TNARNG #Tennessean #TXARNG #Texasan #UTARNG #Utahan #VAARNG #Virginian #VTARNG #Vermontan #WIARNG	https://twitter.com/DarBenThu1/status/1525312121549885440
~0292	Twitter Social-Media Signing Statement State Country Man Settlor Grantor Executor EBA 1933 Procurator Kinsman-Redeemer EBA-Licensee-Obligor	2:26 AM · May 15, 2022 https://twitter.com/DarBenThu1/status/1525769628151971841	M #Signing -Statement to the #EBA1933ADLicensee #WestVirginian #WYARNG #Wyomingan #DOI1776ADBodyPoliticStates #AlabamaState #AlaskaState #ArizonaState #ColoradoState #ArkansasState #CaliforniaState #ConnecticutState #DelawareState #GeorgiaState #FloridaState #HawaiiState	8:08 PM · May 13, 2022 https://twitter.com/DarBenThu1/status/1525312121549885440
~0293	Twitter Social-Media Signing Statement State Country Man Settlor Grantor Executor EBA 1933 Procurator Kinsman-Redeemer EBA-Licensee-Obligor	2:27 AM · May 15, 2022 https://twitter.com/DarBenThu1/status/1525769886709866496	N #Signing -Statement to the #EBA1933ADLicensee #IowaState #KansasState #KentuckyState #LouisianaState #MaineState #MarylandState #MassachusettsState #MichiganState #MinnesotaState #MississippiState #MissouriState #MontanaState #NebraskaState #NevadaState #NewHampshireState	8:08 PM · May 13, 2022 https://twitter.com/DarBenThu1/status/1525312121549885440
~0294	Twitter Social-Media	2:28 AM · May 15, 2022	O #Signing -Statement to the #EBA1933ADLicensee	8:08 PM · May 13, 2022

:Mark	:Matter	:Location	:Claim	:Facts	98 / 199
-------	---------	-----------	--------	--------	----------

2022-011769 MISC Page: 2681 of 2782
09/26/2022 03:35:37 PM Receipt #: 22-9381
Rec Fee: \$30.00 Darrell James Hill
Gila County, Az, Sadie Jo Bingham, Recorder



2370

:Two-Year-Review :Dar-Ben-Thu: Hill ~www.twitter.com/DarBenThu1~ -Authority
https://twitter.com/hashtag/darbenthu1September222020?src=hashtag_click
:DarBenThu1 -Box-Graph: #September2020AD > #August2022AD

	Signing Statement State Country Man Settlor Grantor Executor EBA 1933 Procurator Kinsman-Redeemer EBA-Licensee-Obligor	https://twitter.com/DarBenThu1/status/1525770028951384070	#NorthCarolinaState #NorthDakotaState #OhioState #OklahomaState #OregonState #PennsylvaniaState #RhodeIslandState #SouthCarolinaState #SouthDakotaState #TexasState #UtahState #VermontState #VirginiaState #WashingtonState	https://twitter.com/DarBenThu1/status/1525312121549885440
-0295	Twitter Social-Media Signing Statement State Country Man Settlor Grantor Executor EBA 1933 Procurator Kinsman-Redeemer EBA-Licensee-Obligor Twitter Social-Media Signing Statement State Country Man Settlor Grantor Executor EBA 1933 Procurator Kinsman-Redeemer EBA-Licensee-Obligor	2:29 AM · May 15, 2022 https://twitter.com/DarBenThu1/status/1525770354995499009	P #Signing -Statement to the #EBA1933ADLicensee #airforce #army #guard #navy #marines #reserve #spaceforce #usaf #uscg #AOC1777AD #EP1863AD #StateCountySheriff #SargeantMajorOfTheArmy #SMA #USSurgeonGeneral #DeputyUSSurgeonGeneral #MasterChiefPettyOfficerOfTheNavy #MCPON	8:08 PM · May 13, 2022 https://twitter.com/DarBenThu1/status/1525312121549885440
-0296	Twitter Social-Media Signing Statement	2:30 AM · May 15, 2022	Q #MasterChiefPettyOfficerOfTheCoastGuard #MCPOCG #SargeantMajorOfTheMarineCorps #SMCC	8:08 PM · May 13, 2022

:Mark	:Matter	:Location	:Claim	:Facts	99 / 199
-------	---------	-----------	--------	--------	----------



1/27

**:Two-Year-Review :Dar-Ben-Thu: Hill ~www.twitter.com/DarBenThu1~ -Authority
 https://twitter.com/hashtag/darbenthu1September222020?src=hashtag_click
 :DarBenThu1 -Box-Graph: #September2020AD > #August2022AD**

	State Country Man Settlor Grantor Executor EBA 1933 Procurator Kinsman-Redeemer EBA-Licensee-Obligor	https://twitter.com/DarBenThu1/status/1525770513598992384	#ChiefMasterSargeantOfTheSpaceForce #CMMSSF #CountySheriff #SupportOurUSofA1776PeopleMilitary #XNurseN2010 #XNurseN2011 #XnurseN2012 #XNurseN2013	https://twitter.com/DarBenThu1/status/1525312121549885440
~0297	Twitter Social-Media Signing Statement State Country Man Settlor Grantor Executor EBA 1933 Procurator Kinsman-Redeemer EBA-Licensee- Obligor Twitter Social- Media	2:31 AM · May 15, 2022 https://twitter.com/DarBenThu1/status/1525770712966832128	R #Signing -Statement to the #EBA1933ADLicensee #XNurseN2014 #XNurseN2015 #XNurseN2016 #Twitter #Triller #Periscope #Vimeo #Valence #WhatsApp #Snapchat #Pinterest #Reddit #WeHeardIt #Influenster #FilmAffinity #OpenDiary #Yelp #TheDots #Telegram #FoursquareSwarm #Douban #Discord	8:08 PM · May 13, 2022 https://twitter.com/DarBenThu1/status/1525312121549885440
~0298	Twitter Social-Media Signing Statement State Country Man Settlor Grantor Executor EBA 1933 Procurator Kinsman-Redeemer EBA-Licensee-Obligor	2:31 AM · May 15, 2022 https://twitter.com/DarBenThu1/status/1525770845594918912	S #Signing -Statement to the #EBA1933ADLicensee #TwitterSpaces #HalloApp #Polywork #Poparazzi #Signing - Statement to the #EBA1933ADLicensee #Honk #DOI1776AD #DOI1776ADPeople #EBA1933AD #OhioanStateCountryManGrantorExecutorProcurator #Wisconsinan #WAARNG #Washingtonan #WVARNG	8:08 PM · May 13, 2022 https://twitter.com/DarBenThu1/status/1525312121549885440

:Mark	:Matter	:Location	:Claim	:Facts	100 / 199
-------	---------	-----------	--------	--------	-----------



Handwritten: 2372
 [Signature]

:Two-Year-Review :Dar-Ben-Thu: Hill ~www.twitter.com/DarBenThu1~ -Authority

https://twitter.com/hashtag/darbenthu1September222020?src=hashtag_click

:DarBenThu1 -Box-Graph: #September2020AD > #August2022AD

101 / 199

-0299	Twitter Social-Media Signing Statement State Country Man Settlor Grantor Executor EBA 1933 Procurator Kinsman-Redeemer EBA-Licensee-Obligor	2:32 AM · May 15, 2022 https://twitter.com/DarBenThu1/status/1525771029968146432	T #Signing -Statement to the #EBA1933ADLicensee #IdahoState #NewYorkState #IllinoisState #IndianaState #StateCountryManSovereignSettlorWard #CAARNG #Californian #COARNG #Coloradoan #CTARNG #MDARNG #Marylandan #MEARNG	8:08 PM · May 13, 2022 https://twitter.com/DarBenThu1/status/1525312121549885440
-0300	Twitter Social-Media Signing Statement State Country Man Settlor Grantor Executor EBA 1933 Procurator Kinsman-Redeemer EBA-Licensee-Obligor	2:32 AM · May 15, 2022 https://twitter.com/DarBenThu1/status/1525771208033447936	U #Signing -Statement to the #EBA1933ADLicensee #Maine #NewYorkan #NDARNG #NorthDakotan #OKARNG #Oklahoman #NewJerseyState #NewMexicoState #NewYorkState #WestVirginiaState #WisconsinState #WyomingState #ChiefMasterSargeantOfTheAirForce #CMSAF #USMarshal	8:08 PM · May 13, 2022 https://twitter.com/DarBenThu1/status/1525312121549885440
-0301	Twitter Social-Media Signing Statement State Country Man Settlor Grantor Executor EBA 1933 Procurator Kinsman-Redeemer	8:42 AM · Apr 4, 2022 https://twitter.com/DarBenThu1/status/1511006320912060426	See: later-entry for the Live-Click-ables: https://twitter.com/DarBenThu1/status/1511006320912060426	6:53 AM · Apr 4, 2022 https://twitter.com/DarBenThu1/status/1510978786942074882 https://twitter.com/DarBenThu1/status/1510978786942074882/photo/1
-0302	State Country Man Settlor	5:37 PM · May 15, 2022	A Why is completing YOUR Executor: EBA-1933-A.D.	https://twitter.com/DarBenThu1/status/1510978786942074882
:Mark	:Matter	:Location	:Claim	:Facts



Handwritten signature/initials

	Grantor Executor EBA 1933 Procurator Kinsman-Redeemer	https://twitter.com/DarBenThu1/status/1525998894332620800	important? #NavalPostgraduateSchool #SanDiegoMilitaryBases #Connecticut #NavalSubmarineBaseNewLondon #DistrictofColumbia #JointBtaseAnacostiaBolling #NavalDistrictWashington #Florida #NavalAirStationJacksonville	1522154973630320640/photo/2 https://twitter.com/DarBenThu1/status/1522154973630320640/photo/3
-0303	State Country Man Settlor Grantor Executor EBA 1933 Procurator Kinsman-Redeemer	5:38 PM · May 15, 2022 https://twitter.com/DarBenThu1/status/152599901522803712	B Why is completing YOUR Executor: EBA-1933-A.D. important? #NavalAirStationKey West #NavalAirStationPensacola #NavalAirStationWhitingField #NavalStationMayport #NavalSupportActivityPanamaCity #PensacolaFloridaMilitaryBases #UnitedStatesSouthernCommand #Georgia	How to change your State-Country-Man-Grantor-Status 3:03 AM · May 5, 2022 https://twitter.com/DarBenThu1/status/1522154973630320640
-0304	State Country Man Settlor Grantor Executor EBA 1933 Procurator Kinsman-Redeemer	5:38 PM · May 15, 2022 https://twitter.com/DarBenThu1/status/1525999107734523904	C Why is completing YOUR Executor: EBA-1933-A.D. important? #NavalSubmarineBaseKingsBay #Hawaii #JointBasePearlHarborHickam #NavalStationPearlHarbor #OahuHawaiiMilitaryBases #Illinois #NavalStationGreatLakes #Louisiana #NavalAirStationJointReserveBaseNewOrleans #Maryland	8:13 PM · May 6, 2022 https://twitter.com/DarBenThu1/status/1522776515192139778
-0305	State Country Man Settlor Grantor Executor EBA 1933 Procurator Kinsman-Redeemer	5:39 PM · May 15, 2022 https://twitter.com/DarBenThu1/status/1525999227775512576	D Why is completing YOUR Executor: EBA-1933-A.D. important? #JointBaseAndrews #NSABethesdaWalterReedMedicalCenter #NationalNavalMedicalCenter #NavalAirStationPatuxentRiver #NavyFortMeade #USNavalAcademy #Mississippi #NavalAirStationMeridian	

:Mark	:Matter	:Location	:Claim	:Facts	102 / 199
-------	---------	-----------	--------	--------	-----------



Handwritten: HEE
2372

:Two-Year-Review :Dar-Ben-Thu: Hill ~www.twitter.com/DarBenThu1~ -Authority
https://twitter.com/hashtag/darbenthu1September222020?src=hashtag_click
:DarBenThu1 -Box-Graph: #September2020AD > #August2022AD

~0306	State Country Man Settlor Grantor Executor EBA 1933 Procurator Kinsman-Redeemer	5:39 PM · May 15, 2022 https://twitter.com/DarBenThu1/status/1525999335183306752	E Why is completing YOUR Executor: EBA-1933-A.D. important? #NavalConstructionBattalionCenterGulfport #Nevada #NavalAirStationFallon #NewYork #NavalSupportActivitySaratogaSprings #Rhodelsland #NavalStationNewport #SouthCarolina #BeaufortSouthCarolinaMilitaryBases	https://twitter.com/DarBenThu1/status/1522154973630320640/photo/2 https://twitter.com/DarBenThu1/status/1522154973630320640/photo/3 How to change your State-Country-Man-Grantor-Status 3:03 AM · May 5, 2022 https://twitter.com/DarBenThu1/status/1522154973630320640
~0307	State Country Man Settlor Grantor Executor EBA 1933 Procurator Kinsman-Redeemer	5:40 PM · May 15, 2022 https://twitter.com/DarBenThu1/status/1525999490452164609	F Why is completing YOUR Executor: EBA-1933-A.D. important? #JointBaseCharleston #NavalHospitalBeaufort #NavalWeaponsStationCharleston #Tennessee - #NavalSupportActivityMidSouth #Texas #NavalAirStationCorpusChristi #NavalAirStationJointReserveBaseFortWorth #Virginia	
~0308	State Country Man Settlor Grantor Executor EBA 1933 Procurator Kinsman-Redeemer	5:40 PM · May 15, 2022 https://twitter.com/DarBenThu1/status/1525999650376863744	G Why is completing YOUR Executor: EBA-1933-A.D. important? #HamptonRoadsMilitaryBases #JointExpeditionaryBaseLittleCreekFortStory #NavalAirStationOceana #NavalAirStationOceanaDamNeckAnnex #NavalAmphibiousBaseLittleCreek #NavalStationNorfolk #Washington	
~0309	State Country Man Settlor Grantor Executor EBA 1933 Procurator Kinsman-Redeemer	5:41 PM · May 15, 2022 https://twitter.com/DarBenThu1/status/1525999731859566593	H Why is completing YOUR Executor: EBA-1933-A.D. important? #NavalAirStationWhidbeyIsland #NavalBaseKitsap #NavalBaseKitsapBangor #NavalBaseKitsapBremerton #NavalHospitalBremerton #NavalStationEverett #NavalSupportActivityBahrain #NavalStationGuantanamoBay	
~0310	State Country Man Settlor	5:41 PM · May 15, 2022	I Why is completing YOUR Executor: EBA-1933-A.D.	

:Mark	:Matter	:Location	:Claim	:Facts	103 / 199
-------	---------	-----------	--------	--------	-----------



ASU

:Two-Year-Review :Dar-Ben-Thu: Hill ~www.twitter.com/DarBenThu1~ -Authority

https://twitter.com/hashtag/darbenthu1September222020?src=hashtag_click

:DarBenThu1 -Box-Graph: #September2020AD > #August2022AD

104 / 199

	Grantor Executor EBA 1933 Procurator Kinsman-Redeemer	https://twitter.com/DarBenThu1/status/1525999845500063744	important? #USNavalSupportActivitySoudaBay #NavalAirStationSigonella #NavalSupportActivityNaples #CommanderFleetActivitiesSasebo #CommanderFleetActivitiesYokosuka #NavalAirFacilityAtsugi #CommanderFleetActivitiesChinhae	8:13 PM · May 6, 2022 https://twitter.com/DarBenThu1/status/1522776515192139778 https://twitter.com/DarBenThu1/status/1522154973630320640/photo/2 https://twitter.com/DarBenThu1/status/1522154973630320640/photo/3 How to change your State-Country-Man-Grantor-Status 3:03 AM · May 5, 2022 https://twitter.com/DarBenThu1/status/1522154973630320640 8:13 PM · May 6, 2022 https://twitter.com/DarBenThu1/status/1522776515192139778
~0311	State Country Man Settlor Grantor Executor EBA 1933 Procurator Kinsman-Redeemer	5:41 PM · May 15, 2022 https://twitter.com/DarBenThu1/status/1525999947878780928	J Why is completing YOUR Executor: EBA-1933-A.D. important? #NavyRegionSingapore #NavalStationRota #NavySupportFacilityDiegoGarcia #USSAbrahamLincoln #USSAbrahamLincoln #USSAlaska #USSAlbany #USSAlexandria #USSAlexandria #USSAmerica #USSAnchorage #USSAnnapolis #USSAntietam	https://twitter.com/DarBenThu1/status/1522154973630320640/photo/2 https://twitter.com/DarBenThu1/status/1522154973630320640/photo/3

:Mark	:Matter	:Location	:Claim	:Facts	104 / 199
-------	---------	-----------	--------	--------	-----------

2022-011769 MISC Page: 2687 of 2782
09/26/2022 03:35:37 PM Receipt #: 22-9381
Rec Fee: \$30.00 Darrell James Hill
Gila County, Az, Sadie Jo Bingham, Recorder



BT

-0312	State Country Man Settlor Grantor Executor EBA 1933 Procurator Kinsman-Redeemer	5:42 PM · May 15, 2022 https://twitter.com/DarBenThu1/status/1526000067282210816	K Why is completing YOUR Executor: EBA-1933-A.D. important? #USSAnzio #USSArleighBurke #USSArlington #USSAsheville #USSAshland #USSBainbridge #USSBarry #USSBataan #USSBenfold #USSBillings #USSBlue Ridge #USSBoise #USSBoxer #USSBulkeley #USSBunkerHill #USSCalifornia	How to change your State-Country-Man-Grantor-Status 3:03 AM · May 5, 2022 https://twitter.com/DarBenThu1/status/1522154973630320640 8:13 PM · May 6, 2022 https://twitter.com/DarBenThu1/status/1522776515192139778
-0313	State Country Man Settlor Grantor Executor EBA 1933 Procurator Kinsman-Redeemer	5:42 PM · May 15, 2022 https://twitter.com/DarBenThu1/status/1526000212094750721	L Why is completing YOUR Executor: EBA-1933-A.D. important? #USSCapeStGeorge #USSCarlVinson #USSCarney #USSCarterHall #USSChafee #USSChancellorsville #USSCharleston #USSCharlotte #USSCheyenne #USSChicago #USSChief #USSChinook #USSChosin #USSChungHoon	1:52 AM · May 8, 2022 https://twitter.com/DarBenThu1/status/1523224417324601344 3:03 AM · May 5, 2022 https://twitter.com/DarBenThu1/status/1522154973630320640 8:13 PM · May 6, 2022 https://twitter.com/DarBenThu1/status/1522776515192139778
-0314	State Country Man Settlor Grantor Executor EBA 1933 Procurator Kinsman-Redeemer	5:48 PM · May 15, 2022 https://twitter.com/DarBenThu1/status/1526001655879114752	M Why is completing YOUR Executor: EBA-1933-A.D. important? #USSCincinnati #USSCole #USSColorado #USSColumbia #USSColumbus #USSComstock #USSConnecticut #USSConstitution #USSCoronado #USSCowpens #USSCurtisWilbur #USSDaniellInouye #USSDecatur #USSDelaware #USSDelbertDBlack	1:52 AM · May 8, 2022 https://twitter.com/DarBenThu1/status/1523224417324601344 3:03 AM · May 5, 2022 https://twitter.com/DarBenThu1/status/1522154973630320640 8:13 PM · May 6, 2022 https://twitter.com/DarBenThu1/status/1522776515192139778

:Mark	:Matter	:Location	:Claim	:Facts	105 / 199
-------	---------	-----------	--------	--------	-----------



Handwritten signature/initials

:Two-Year-Review :Dar-Ben-Thu: Hill ~www.twitter.com/DarBenThu1~ -Authority

https://twitter.com/hashtag/darbenthu1September222020?src=hashtag_click

:DarBenThu1 -Box-Graph: #September2020AD > #August2022AD

106 / 199

~0315	State Country Man Settlor Grantor Executor EBA 1933 Procurator Kinsman-Redeemer	5:49 PM · May 15, 2022 https://twitter.com/DarBenThu1/status/1526001767971835904	N Why is completing YOUR Executor: EBA-1933-A.D. important? #USSDetroit #USSDevastator #USSDewey #USSDextrous #USSDonaldCook #USSDwightDEisenhower #USSEmorySLand #USSEssex #USSFarragut #USSFitzgerald #USSFlorida #USSForrestSherman #USSFortWorth #USSFrankCable	1:52 AM · May 8, 2022 https://twitter.com/DarBenThu1/status/1523224417324601344 3:03 AM · May 5, 2022 https://twitter.com/DarBenThu1/status/1522154973630320640 8:13 PM · May 6, 2022 https://twitter.com/DarBenThu1/status/1522776515192139778
~0316	State Country Man Settlor Grantor Executor EBA 1933 Procurator Kinsman-Redeemer	5:49 PM · May 15, 2022 https://twitter.com/DarBenThu1/status/1526001908141289473	O Why is completing YOUR Executor: EBA-1933-A.D. important? #USSGabrielleGiffords #USSGeorgeWashington #USSGeorgeHWBush #USSGeorgia #USSGeraldRFord #USSGermantown #USSGettysburg #USSGladiator #USSGonzalez #USSGravelly #USSGreenBay #USSGreeneville #USSGridley #USSGunstonHall	1:52 AM · May 8, 2022 https://twitter.com/DarBenThu1/status/1523224417324601344 3:03 AM · May 5, 2022 https://twitter.com/DarBenThu1/status/1522154973630320640 8:13 PM · May 6, 2022 https://twitter.com/DarBenThu1/status/1522776515192139778
~0317	State Country Man Settlor Grantor	5:50 PM · May 15, 2022	P Why is completing YOUR Executor: EBA-1933-A.D. important? #USSHalsey #USSHampton #USSHarpersFerry	3:03 AM · May 5, 2022 https://twitter.com/DarBenThu1/status/

:Mark	:Matter	:Location	:Claim	:Facts	106 / 199
-------	---------	-----------	--------	--------	-----------

2022-011769 MISC Page: 2689 of 2782

09/26/2022 03:35:37 PM Receipt #: 22-9381

Rec Fee: \$30.00 Darrell James Hill
Gila County, Az, Sadie Jo Bingham, Recorder



BJE

	Executor EBA 1933 Procurator Kinsman-Redeemer	https://twitter.com/DarBenThu1/status/1526002077595336704	#USSHarrySTruman #USSHartford #USSHawaii #USSHelena #USSHenryMJackson #USSHershelWoodyWilliams #USSHiggins #USSHopper #USSHoward #USSHuéCity #USSHurricane #USSIllinois #USSIndiana	1522154973630320640 8:13 PM · May 6, 2022 https://twitter.com/DarBenThu1/status/1522776515192139778
~0318	State Country Man Settlor Grantor Executor EBA 1933 Procurator Kinsman-Redeemer	5:50 PM · May 15, 2022 https://twitter.com/DarBenThu1/status/1526002180683014144	Q Why is completing YOUR Executor: EBA-1933-A.D. important? #USSIndianapolis #USSIwoJima #USSJackson #USSJamesEWilliams #USSJasonDunham #USSJeffersonCity #USSJimmyCarter #USSJohnCStennis #USSJohnFinn #USSJohnPMurtha #USSJohnPaulJones #USSJohnSMcCain #USSJohnWarner #USSKansasCity	3:03 AM · May 5, 2022 https://twitter.com/DarBenThu1/status/1522154973630320640 8:13 PM · May 6, 2022 https://twitter.com/DarBenThu1/status/1522776515192139778
~0319	State Country Man Settlor Grantor Executor EBA 1933 Procurator Kinsman-Redeemer	5:51 PM · May 15, 2022 https://twitter.com/DarBenThu1/status/1526002275784663040	R Why is completing YOUR Executor: EBA-1933-A.D. important? #USSKearsarge #USSKeyWest #USSKidd #USSLaboon #USSLakeChamplain #USSLakeErie #USSLassen #USSLewisBPuller #USSLeyteGulf #USSLittleRock #USSLouisiana #USSMahan #USSMaine #USSMakinIsland #USSManchester #USSMaryland	3:03 AM · May 5, 2022 https://twitter.com/DarBenThu1/status/1522154973630320640 8:13 PM · May 6, 2022 https://twitter.com/DarBenThu1/status/1522776515192139778
~0320	State Country Man Settlor Grantor Executor EBA 1933 Procurator	5:51 PM · May 15, 2022 https://twitter.com/DarBenThu1/status/1526002387600609280	S Why is completing YOUR Executor: EBA-1933-A.D. important? #USSMason #USSMcCampbell #USSMcFaul #USSMesaVerde #USSMichaelMonsoor #USSMichaelMurphy #USSMichigan #USSMiguelKeith #USSMilius	3:03 AM · May 5, 2022 https://twitter.com/DarBenThu1/status/1522154973630320640

:Mark	:Matter	:Location	:Claim	:Facts	107 / 199
-------	---------	-----------	--------	--------	-----------



Handwritten initials/signature

	Kinsman-Redeemer		#USSMilwaukee #USSMinnesota #USSMississippi #USSMissouri #USSMitscher #USSMobile	8:13 PM · May 6, 2022 https://twitter.com/DarBenThu1/status/1522776515192139778
-0321	State Country Man Settlor Grantor Executor EBA 1933 Procurator Kinsman-Redeemer	5:52 PM · May 15, 2022 https://twitter.com/DarBenThu1/status/1526002510015541248	T Why is completing YOUR Executor: EBA-1933-A.D. important? #USSMobileBay #USSMomsen #USSMonsoon #USSMonterey #USSMontgomery #USSMontpelier #USSMountWhitney #USSMustin #USSNebraska #USSNevada #USSNewHampshire #USSNewMexico #USSNewOrleans #USSNewYork #USSNewportNews #USSNimitz	3:03 AM · May 5, 2022 https://twitter.com/DarBenThu1/status/1522154973630320640 8:13 PM · May 6, 2022 https://twitter.com/DarBenThu1/status/1522776515192139778
-0322	State Country Man Settlor Grantor Executor EBA 1933 Procurator Kinsman-Redeemer	5:52 PM · May 15, 2022 https://twitter.com/DarBenThu1/status/1526002573324324864	U Why is completing YOUR Executor: EBA-1933-A.D. important? #USSNitze #USSNormandy #USSNorthCarolina #USSNorthDakota #USSOKane #USSOakHill #USSOakland #USSOhio #USSOmaha #USSOscar Austin #USSPasadena #USSPatriot #USSPaulHamilton #USSPaullIgnatius #USSPearlHarbor #USSPennsylvania	3:03 AM · May 5, 2022 https://twitter.com/DarBenThu1/status/1522154973630320640 8:13 PM · May 6, 2022 https://twitter.com/DarBenThu1/status/1522776515192139778
-0323	State Country Man Settlor Grantor Executor EBA 1933 Procurator Kinsman-Redeemer	5:52 PM · May 15, 2022 https://twitter.com/DarBenThu1/status/1526002688927756288	V Why is completing YOUR Executor: EBA-1933-A.D. important? #USSPhilippine Sea #USSPinckney #USSPioneer #USSPortRoyal #USSPorter #USSPortland #USSPreble #USSPrinceton #USSPueblo #USSRafaelPeralta #USSRalphJohnson #USSRamage #USSRhodelsland #USSRonaldReagan #USSRoosevelt	3:03 AM · May 5, 2022 https://twitter.com/DarBenThu1/status/1522154973630320640 8:13 PM · May 6, 2022

:Mark	:Matter	:Location	:Claim	:Facts	108 / 199
-------	---------	-----------	--------	--------	-----------



1380

				https://twitter.com/DarBenThu1/status/1522776515192139778
~0324	State Country Man Settlor Grantor Executor EBA 1933 Procurator Kinsman-Redeemer	5:53 PM · May 15, 2022 https://twitter.com/DarBenThu1/status/1526002771643621377	W Why is completing YOUR Executor: EBA-1933-A.D. important? #USNSafeguard #USSSanFrancisco #USSTarawa #USSRoss #USSRushmore #USSRussell #USSSampson #USSSanAntonio #USSSanDiego #USSSanJacinto #USSSanJuan #USSSantaFe #USSSavannah #USSScranton #USSSeawolf #USSSentry #USSShiloh	3:03 AM · May 5, 2022 https://twitter.com/DarBenThu1/status/1522154973630320640 8:13 PM · May 6, 2022 https://twitter.com/DarBenThu1/status/1522776515192139778
~0325	State Country Man Settlor Grantor Executor EBA 1933 Procurator Kinsman-Redeemer	5:53 PM · May 15, 2022 https://twitter.com/DarBenThu1/status/1526002890715693056	X Why is completing YOUR Executor: EBA-1933-A.D. important? #USSShoup #USSShoup #USSSiouxCity #USSSirocco #USSSomerset #USSSouthDakota #USSSpringfield #USSSpruance #USSStLouis #USSSterett #USSStethem #USSStockdale #USSStout #USSTennessee #USSTexas #USSThe Sullivans	3:03 AM · May 5, 2022 https://twitter.com/DarBenThu1/status/1522154973630320640 8:13 PM · May 6, 2022 https://twitter.com/DarBenThu1/status/1522776515192139778
~0326	State Country Man Settlor Grantor Executor EBA 1933 Procurator Kinsman-Redeemer	5:53 PM · May 15, 2022 https://twitter.com/DarBenThu1/status/1526002953965797376	Y Why is completing YOUR Executor: EBA-1933-A.D. important? #USSTheodoreRoosevelt #USSThunderbolt #USSToledo #USSTopeka #USSTortuga #USSTripoli #USSTruxtun #USSTucson #USSTulsa #USSVella Gulf #USSVermont #USSVicksburg #USSVirginia #USSWarrior #USSWashington #USSWasp	3:03 AM · May 5, 2022 https://twitter.com/DarBenThu1/status/1522154973630320640 8:13 PM · May 6, 2022 https://twitter.com/DarBenThu1/status/1522776515192139778

:Mark	:Matter	:Location	:Claim	:Facts	109 / 199
-------	---------	-----------	--------	--------	-----------



Handwritten initials/signature

				1522776515192139778
~0327	State Country Man Settlor Grantor Executor EBA 1933 Procurator Kinsman-Redeemer	5:54 PM · May 15, 2022 https://twitter.com/DarBenThu1/status/1526003053010137088	Z Why is completing YOUR Executor: EBA-1933-A.D. important? #USSWayneEMeyer #USSWestVirginia #USSWhidbeyIsland #USSWilliamPLawrence #USSWinstonSChurchill #USSWichita #USSWyoming #USSZumwalt #USNS1stLtBaldomeroLopez #USNS1stLtHarryLMartin #USNS1stLtJackLummus #USNS2ndLtJohnPBobo	3:03 AM · May 5, 2022 https://twitter.com/DarBenThu1/status/1522154973630320640 8:13 PM · May 6, 2022 https://twitter.com/DarBenThu1/status/1522776515192139778
~0328	State Country Man Settlor Grantor Executor EBA 1933 Procurator Kinsman-Redeemer	5:54 PM · May 15, 2022 https://twitter.com/DarBenThu1/status/1526003184115671040	AA Why is completing YOUR Executor: EBA-1933-A.D. important? #USNSAble #USNSAlanShepard #USNSAmeliaEarhart #USNSApache #USNSArctic #USNSArrowhead #USNSBenavidez #USNSBigHorn #USNSBlackPowder #USNSBobHope #USNSBowditch #USNSBrittin #USNSBruceCheezen #USNSBrunswick	3:03 AM · May 5, 2022 https://twitter.com/DarBenThu1/status/1522154973630320640 8:13 PM · May 6, 2022 https://twitter.com/DarBenThu1/status/1522776515192139778
~0329	State Country Man Settlor Grantor Executor EBA 1933 Procurator Kinsman-Redeemer	5:55 PM · May 15, 2022 https://twitter.com/DarBenThu1/status/1526003245675470848	AB Why is completing YOUR Executor: EBA-1933-A.D. important? #USNSBurlington #USNSCarl Brashear #USNSCarson City #USNSCatawba #USNSCesar Chavez #USNSCharles Drew #USNSCharlton #USNSChoctaw County #USNSCity of Bismarck #USNSComfort #USNSDahl #USNSEagleview #USNSEffective	3:03 AM · May 5, 2022 https://twitter.com/DarBenThu1/status/1522154973630320640 8:13 PM · May 6, 2022 https://twitter.com/DarBenThu1/status/1522776515192139778

:Mark	:Matter	:Location	:Claim	:Facts	110 / 199
-------	---------	-----------	--------	--------	-----------



Handwritten initials/signature

:Two-Year-Review :Dar-Ben-Thu: Hill ~www.twitter.com/DarBenThu1~ -Authority
https://twitter.com/hashtag/darbenthu1September222020?src=hashtag_click
:DarBenThu1 -Box-Graph: #September2020AD > #August2022AD

~0330	State Country Man Settlor Grantor Executor EBA 1933 Procurator Kinsman-Redeemer	5:55 PM · May 15, 2022 https://twitter.com/DarBenThu1/status/1526003356572930048	AC Why is completing YOUR Executor: EBA-1933-A.D. important? #USNSFall River #USNSEast Tempo #USNSFisher #USNSGrasp #USNSGilliland #USNSGordon #USNSGuadalupe #USNSGuam #USNSGySgt. Fred W. Stockham #USNSHenry J.Kaiser #USNSHenson #USNSHoward O. Lorenzen #USNSImpeccable	3:03 AM · May 5, 2022 https://twitter.com/DarBenThu1/status/1522154973630320640 8:13 PM · May 6, 2022 https://twitter.com/DarBenThu1/status/1522776515192139778
~0331	State Country Man Settlor Grantor Executor EBA 1933 Procurator Kinsman-Redeemer	5:55 PM · May 15, 2022 https://twitter.com/DarBenThu1/status/1526003473946267648	AD Why is completing YOUR Executor: EBA-1933-A.D. important? #USNSJohn Ericsson #USNSJohn Glenn #USNSJohn Lenthall #USNSJoshua Humphreys #USNSKanawha #USNS LanceCpl. Roy M. Wheat #USNSLaramie #USNSLeroy Grumman #USNSLewis and Clark #USNSLoyal #USNSMajStephenWPless #USNSMarySears	3:03 AM · May 5, 2022 https://twitter.com/DarBenThu1/status/1522154973630320640 8:13 PM · May 6, 2022 https://twitter.com/DarBenThu1/status/1522776515192139778
~0332	State Country Man Settlor Grantor Executor EBA 1933 Procurator Kinsman-Redeemer	5:56 PM · May 15, 2022 https://twitter.com/DarBenThu1/status/1526003546067308544	AE Why is completing YOUR Executor: EBA-1933-A.D. important? #USNSMatthew Perry #USNSMaury #USNSMedgar Evers #USNSMendonca #USNSMercy #USNSMillinocket #USNSMontford Point #USNSNewport #USNSPathfinder #USNSPatuxent #USNS PFC Eugene A. Obregon #USNSPiliiaa #USNSPomeroy	3:03 AM · May 5, 2022 https://twitter.com/DarBenThu1/status/1522154973630320640 8:13 PM · May 6, 2022 https://twitter.com/DarBenThu1/status/1522776515192139778
~0333	State Country Man Settlor	5:56 PM · May 15, 2022	AF Why is completing YOUR Executor: EBA-1933-A.D.	3:03 AM · May 5, 2022

:Mark	:Matter	:Location	:Claim	:Facts
-------	---------	-----------	--------	--------



[Handwritten signature]

:Two-Year-Review :Dar-Ben-Thu: Hill ~www.twitter.com/DarBenThu1~ -Authority

https://twitter.com/hashtag/darbenthu1September222020?src=hashtag_click

:DarBenThu1 -Box-Graph: #September2020AD > #August2022AD

112 / 199

	Grantor Executor EBA 1933 Procurator Kinsman-Redeemer	https://twitter.com/DarBenThu1/status/1526003636886679552	important? #USNSPuerto Rico #USNSRappahannock #USNSRed Cloud #USNSRichardEByrd #USNSRobertEPeary #USNSSacagawea #USNSSalvor #USNSSeay #USNSSgtMatejKocak #USNSSgtWilliamRButton #USNSSisler #USNSSoderman	https://twitter.com/DarBenThu1/status/1522154973630320640 8:13 PM · May 6, 2022 https://twitter.com/DarBenThu1/status/1522776515192139778
-0334	State Country Man Settlor Grantor Executor EBA 1933 Procurator Kinsman-Redeemer	5:56 PM · May 15, 2022 https://twitter.com/DarBenThu1/status/1526003722484011008	AG Why is completing YOUR Executor: EBA-1933-A.D. important? #USNSSpearhead #USNSPecos #USNSPFCDWayneWilliams #USNSSupply #USNSTippecanoe #USNSTrenton #USNSVADMKR Wheeler #USNSVictorious #USNSWallySchirra #USNSWalterSDiehl #USNSWashingtonChambers #USNSWaters #USNSWatkins	3:03 AM · May 5, 2022 https://twitter.com/DarBenThu1/status/1522154973630320640 8:13 PM · May 6, 2022 https://twitter.com/DarBenThu1/status/1522776515192139778
-0335	State Country Man Settlor Grantor Executor EBA 1933 Procurator Kinsman-Redeemer	5:57 PM · May 1 https://twitter.com/DarBenThu1/status/1526003823197552640 5. 2022	AH Why is completing YOUR Executor: EBA-1933-A.D. important? #USNSWatson #USNSWestwind #USNSWilliamMcLean #USNSYano #USNSYuma #USNSYukon #USNSZeus #USNSBridge #USSFortMcHenry #USNSGrapple #USSFreedom #USNSInvincible #USSIndependence #USSOklahomaCity #USSPeleliu #USSProvidence	3:03 AM · May 5, 2022 https://twitter.com/DarBenThu1/status/1522154973630320640 8:13 PM · May 6, 2022 https://twitter.com/DarBenThu1/status/1522776515192139778
-0336	State Country Man Settlor	5:57 PM · May 15, 2022	AI Why is completing YOUR Executor: EBA-1933-A.D.	3:03 AM · May 5, 2022

:Mark	:Matter	:Location	:Claim	:Facts	112 / 199
-------	---------	-----------	--------	--------	-----------

2022-011769 MISC Page: 2695 of 2782

09/26/2022 03:35:37 PM Receipt #: 22-9301

Rec Fee: \$30.00 Darrell James Hill

Gila County, Az, Sadie Jo Bingham, Recorder



2384

	Grantor Executor EBA 1933 Procurator Kinsman-Redeemer	https://twitter.com/DarBenThu1/status/1526003935550394368	important? #USNSRainier #USNSSafeguard #USSSanFrancisco #USStarawa #USPacificFleet #USMC #USFleetForces #US7thFleet #flynavy #Comexstrikgru3 #ZUMWALTDG1000 #Official13thMEU #1stMAWMarines #3dMarineDiv #USFLEETCYBERCOM #USNavyCNR	https://twitter.com/DarBenThu1/status/1522154973630320640 8:13 PM · May 6, 2022 https://twitter.com/DarBenThu1/status/1522776515192139778
~0337	State Country Man Settlor Grantor Executor EBA 1933 Procurator Kinsman-Redeemer	5:58 PM · May 15, 2022 https://twitter.com/DarBenThu1/status/1526004032350740481	AJ Why is completing YOUR Executor: EBA-1933-A.D. important? #NavyMisawa #MyNAWCAD #NAVSUPSYSCOM #USMCSgtMaj Sergeant Major Troy E. Black #NAVSEA #NavyMemorial #CMCMarineCorps #CFAOkinawa #NavyRegionSE #US2ndFleet #US3rdFleet #CNRMA #NAVAIRNews #1stMarineDiv #USNorthernCmd	3:03 AM · May 5, 2022 https://twitter.com/DarBenThu1/status/1522154973630320640 8:13 PM · May 6, 2022 https://twitter.com/DarBenThu1/status/1522776515192139778
~0338	State Country Man Settlor Grantor Executor EBA 1933 Procurator Kinsman-Redeemer	5:58 PM · May 15, 2022 https://twitter.com/DarBenThu1/status/1526004136440844289	AK Why is completing YOUR Executor: EBA-1933-A.D. important? #3rdmaw #PearlHarborNPS #31stMeu #NIMEE #NavyChaplains #mercyship19 #EXSTRGRU7 #PacificMarines #COMLOGWESTPAC #EmorySLand #US5thFleet #NavBaseSD #MSCSealift #WoundedtoWork #USFJJ #USForcesJapan #CFASasebo #PacificSubs	3:03 AM · May 5, 2022 https://twitter.com/DarBenThu1/status/1522154973630320640 8:13 PM · May 6, 2022 https://twitter.com/DarBenThu1/status/1522776515192139778
~0339	State Country Man Settlor Grantor Executor EBA 1933	5:58 PM · May 15, 2022 https://twitter.com/DarBenThu1/status/	AL Why is completing YOUR Executor: EBA-1933-A.D. important? #eAsiaMediaHub #7thFleetBand #CNATRA #USSIOWA #StudentVets #JameyDoyle #NavyLeagueUS	3:03 AM · May 5, 2022 https://twitter.com/DarBenThu1/status/

:Mark	:Matter	:Location	:Claim	:Facts	113 / 199
-------	---------	-----------	--------	--------	-----------

2022-011769 MISC Page: 2696 of 2782
 09/26/2022 03:35:37 PM Receipt #: 22-9381
 Rec Fee: \$30.00 Darrell James Hill
 Gila County, Az. Sadie Jo Bingham, Recorder

Handwritten signature/initials

	Procurator Kinsman-Redeemer	1526004226853195777	#nbgum #NMCP1 #VAOEFOIE #NAVWARHQ #USWMagazine #WPNSTAYorktown #MilitaryOfficer #NAVSOUS4THEFLT.#surflant #CNICHQ #SurfaceWarriors	1522154973630320640 8:13 PM · May 6, 2022 https://twitter.com/DarBenThu1/status/1522776515192139778
~0340	State Country Man Settlor Grantor Executor EBA 1933 Procurator Kinsman-Redeemer	5:59 PM · May 15, 2022 https://twitter.com/DarBenThu1/status/1526004321078214656	AM Why is completing YOUR Executor: EBA-1933-A.D. important? #NavyMedicine #USARPAC #usnavyband #usnavyseals #navchapscolcen #marforrescent 8THmarine Brigade #NavRegHawaii #11thmeu #NavyOceans #MarForRes #NAVSTARota #USNavyIPs #COMNAVFORJAPAN #NAVFAC #CoronadoNavy #FleetFamily	3:03 AM · May 5, 2022 https://twitter.com/DarBenThu1/status/1522154973630320640 8:13 PM · May 6, 2022 https://twitter.com/DarBenThu1/status/1522776515192139778
~0341	State Country Man Settlor Grantor Executor EBA 1933 Procurator Kinsman-Redeemer	5:59 PM · May 15, 2022 https://twitter.com/DarBenThu1/status/1526004416553242624	AN Why is completing YOUR Executor: EBA-1933-A.D. important? #Southcom #navyreserve #usnavyseals #theUSO #USNHhistory #NavalWarCollege #2ndFleet #3rd Fleet #4thFleet #5thFleet #6thFleet #7thFleet #10thFleet #BlueAngels #militaryflyingteams #NavalSeaSystemsCommand	3:03 AM · May 5, 2022 https://twitter.com/DarBenThu1/status/1522154973630320640 8:13 PM · May 6, 2022 https://twitter.com/DarBenThu1/status/1522776515192139778
~0342	State Country Man Settlor Grantor Executor EBA 1933 Procurator	5:59 PM · May 15, 2022 https://twitter.com/DarBenThu1/status/1526004416553242624	AO Why is completing YOUR Executor: EBA-1933-A.D. important? #NavalAirSystemsCommand #NavalFacilitiesEngineeringSystemsCommand #NavalSupplySystemsCommand	3:03 AM · May 5, 2022 https://twitter.com/DarBenThu1/status/1522154973630320640

:Mark	:Matter	:Location	:Claim	:Facts	114 / 199
-------	---------	-----------	--------	--------	-----------

2022-011769 MISC Page: 2697 of 2782
 09/26/2022 03:35:37 PM Receipt #: 22-9381
 Rec Fee: \$30.00 Darrell James Hill
 Gila County, Az, Sadie Jo Bingham, Recorder



Handwritten initials/signature

	Kinsman-Redeemer	1526004485893464064	#NavalInformationWarfareSystemsCommand #StrategicSystemsPrograms #UnitedStatesNavalAcademy #NavalEducationandTrainingCommand	8:13 PM · May 6, 2022 https://twitter.com/DarBenThu1/status/1522776515192139778
~0343	State Country Man Settlor Grantor Executor EBA 1933 Procurator Kinsman-Redeemer	6:00 PM · May 15, 2022 https://twitter.com/DarBenThu1/status/1526004558203219968	AP Why is completing YOUR Executor: EBA-1933-A.D. important? #NavalMeteorologyOceanographyCommand #OfficeNavalIntelligence #NavalStrikeAirWarfare enter #NavalSecurityGroup #NavalLegalServiceCommand #UnitedStatesNavalObservatory #NavalSafetyCenter #USNavyVeteran	3:03 AM · May 5, 2022 https://twitter.com/DarBenThu1/status/1522154973630320640 8:13 PM · May 6, 2022 https://twitter.com/DarBenThu1/status/1522776515192139778
~0344	State Country Man Settlor Grantor Executor EBA 1933 Procurator Kinsman-Redeemer	6:00 PM · May 15, 2022 https://twitter.com/DarBenThu1/status/1526004635512672256	AQ Why completing your ID for -:Executor: EBA-1933-A.D. is important? #California #ChinaLakeNavalAirWeaponsStation #NavalAirStationLemoore #NavalAirStationNorthIsland #NavalAmphibiousBaseCoronado #NavalBaseCoronado #NavalBasePointLoma #NavalBaseSanDiego #NavalBaseVenturaCounty	3:03 AM · May 5, 2022 https://twitter.com/DarBenThu1/status/1522154973630320640 8:13 PM · May 6, 2022 https://twitter.com/DarBenThu1/status/1522776515192139778
~0345	State Country Man Settlor Grantor Executor EBA 1933 Procurator Kinsman-Redeemer	6:23 PM · May 15, 2022 https://twitter.com/DarBenThu1/status/1526010307683835904	AR Why completing your ID for -:Executor: EBA-1933-A.D. is important? #NavalStrikeAirWarfareCenter #8THmarineBrigade #SergeantMajorTroyEBlack #USNSPFCEugeneAOregon #USNSPuertoRico #USNSMatthewPerry #USNSJohnEricsson #USNSJohnGlenn #USNSJohnLenthall #USNSJoshuaHumphreys	3:03 AM · May 5, 2022 https://twitter.com/DarBenThu1/status/1522154973630320640 8:13 PM · May 6, 2022

:Mark	:Matter	:Location	:Claim	:Facts	115 / 199
-------	---------	-----------	--------	--------	-----------

2022-011769 MISC Page: 2698 of 2782
 09/26/2022 03:35:37 PM Receipt #: 22-9381
 Rec Fee: \$30.00 Darrell James Hill
 Gila County, Az, Sadie Jo Bingham, Recorder



Handwritten signature/initials

				https://twitter.com/DarBenThu1/status/1522776515192139778
-0346	State Country Man Settlor Grantor Executor EBA 1933 Procurator Kinsman-Redeemer	6:23 PM · May 15, 2022 https://twitter.com/DarBenThu1/status/1526010411304091648	AS #USNSKanawha #USNSanceCplRoyMWheat #USNSLaramie #USNSLeroyGrumman #USNSLewisClark #USNSLoyal #USNSMajStephenWPless #USNSMarySears #USNSGySgtFredWStockham #USNSHenryJKaiser #USNSHenson #USNSHowardOLorenzen #USNSCarlBrashear	3:03 AM · May 5, 2022 https://twitter.com/DarBenThu1/status/1522154973630320640 8:13 PM · May 6, 2022 https://twitter.com/DarBenThu1/status/1522776515192139778
-0347	State Country Man Settlor Grantor Executor EBA 1933 Procurator Kinsman-Redeemer	6:24 PM · May 15, 2022 https://twitter.com/DarBenThu1/status/1526010631144345601	AT #USNSCarsonCity #USNSCatawba #USNSCesarChavez #USNSCharlesDrew #USNSCharlton #USNSChoctawCounty #USNSCityBismarck #NavalAirStationJointReserveBaseNewOrleans #Maryland	3:03 AM · May 5, 2022 https://twitter.com/DarBenThu1/status/1522154973630320640 8:13 PM · May 6, 2022 https://twitter.com/DarBenThu1/status/1522776515192139778
-0348	State Country Man Settlor Grantor Executor EBA 1933 Procurator Kinsman-Redeemer	6:48 PM · May 15, 2022 https://twitter.com/DarBenThu1/status/1526016701665464320	A Why is completing YOUR Executor: EBA-1933-A.D. important? #MarineCorpsAirStationYuma #MarineCorpsAirGCCTwentyNinePalms #MarineCorpsAirStationMiramar #MarineCorpsBaseCampPendleton #MarineCorpsRecruitDepotSanDiego #SanDiegoMilitaryBases #UnitedStatesSouthernCommand	3:03 AM · May 5, 2022 https://twitter.com/DarBenThu1/status/1522154973630320640 8:13 PM · May 6, 2022 https://twitter.com/DarBenThu1/status/1522776515192139778

:Mark	:Matter	:Location	:Claim	:Facts	116 / 199
-------	---------	-----------	--------	--------	-----------

2022-011769 MISC Page: 2699 of 2782
 09/26/2022 03:35:37 PM Receipt #: 22-9381
 Rec Fee: \$30.00 Darrell James Hill
 Gila County, Az, Sadie Jo Bingham, Recorder



Handwritten signature/initials

				1522776515192139778
~0349	State Country Man Settlor Grantor Executor EBA 1933 Procurator Kinsman-Redeemer	6:49 PM · May 15, 2022 https://twitter.com/DarBenThu1/status/1526016847618879488	B Why is completing YOUR Executor: EBA-1933-A.D. important? #MarineCorpsBaseHawaii #OahuHawaiiMilitaryBases #JacksonvilleNorthCarolinaMilitaryBases #MarineCorpsAirStationCherryPoint #MarineCorpsAirStationNewRiver #MarineCorpsBaseCampLejeune #BeaufortSouthCarolinaMilitaryBases	3:03 AM · May 5, 2022 https://twitter.com/DarBenThu1/status/1522154973630320640 8:13 PM · May 6, 2022 https://twitter.com/DarBenThu1/status/1522776515192139778
~0350	State Country Man Settlor Grantor Executor EBA 1933 Procurator Kinsman-Redeemer	6:49 PM · May 15, 2022 https://twitter.com/DarBenThu1/status/1526017011842617346	C Why is completing YOUR Executor: EBA-1933-A.D. important? #MarineCorpsAirStationBeaufort #MarineCorpsRecruitDepotParrisIsland #HendersonHall #JointBaseMyerHendersonHall #MarineCorpsBaseQuantico #CampSDButler #MarineCorpsAirStationIwakuni	3:03 AM · May 5, 2022 https://twitter.com/DarBenThu1/status/1522154973630320640 8:13 PM · May 6, 2022 https://twitter.com/DarBenThu1/status/1522776515192139778
~0351	State Country Man Settlor Grantor Executor EBA 1933 Procurator Kinsman-Redeemer	7:19 PM · May 15, 2022 https://twitter.com/DarBenThu1/status/1526024614257627136	Why is completing YOUR Executor: EBA-1933-A.D. important? #CoastGuardTrainingCenterPetaluma #USCoastGuardStationSanDiego #CoastGuardSectorHonolulu #OahuHawaiiMilitaryBases #CoastGuardSectorBaltimore #CoastGuardSectorHamptonRoads #CoastGuardSectorPugetSound	3:03 AM · May 5, 2022 https://twitter.com/DarBenThu1/status/1522154973630320640 8:13 PM · May 6, 2022 https://twitter.com/DarBenThu1/status/1522776515192139778

:Mark	:Matter	:Location	:Claim	:Facts	117 / 199
-------	---------	-----------	--------	--------	-----------



Handwritten initials/signature

~0352	State Country Man Settlor Grantor Executor EBA 1933 Procurator Kinsman-Redeemer	2:08 AM · May 16, 2022 https://twitter.com/DarBenThu1/status/1526127478871592961	A Why is completing YOUR Executor: EBA-1933-A.D. important? #Alabama #MaxwellGunter #Alaska #Eielson #Elmendorf #JointBaseElmendorfRichardson #Arizona #DavisMonthanAirForceBase #LukeAirForceBase #Arkansas #LittleRock #California #BealeAirForceBase #EdwardsAirForceBase	3:03 AM · May 5, 2022 https://twitter.com/DarBenThu1/status/1522154973630320640
~0353	State Country Man Settlor Grantor Executor EBA 1933 Procurator Kinsman-Redeemer	2:09 AM · May 16, 2022 https://twitter.com/DarBenThu1/status/1526127595875536897	B #LosAngelesAirForceBase #MarchAirReserveBase #TravisAirForceBase #VandenbergAirForceBase #Colorado #BuckleyAirForceBase #ColoradoSpringsMilitaryBases #PetersonAirForceBase #SchrieverAirForceBase #UnitedStatesAirForceAcademy #Delaware #DoverAirForceBase #DistrictofColumbia	3:03 AM · May 5, 2022 https://twitter.com/DarBenThu1/status/1522154973630320640
~0354	State Country Man Settlor Grantor Executor EBA 1933 Procurator Kinsman-Redeemer	2:09 AM · May 16, 2022 https://twitter.com/DarBenThu1/status/1526127723101310976	C #JointBaseAnacostiaBolling #Florida #EglinAirForceBase #HurlburtField #MacDillAirForceBase #PatrickAirForceBase #PensacolaFloridaMilitaryBases #TyndallAirForceBase #UnitedStatesSouthernCommand #Georgia #MoodyAirForceBase #RobinsAirForceBase #Hawaii #HickamAirForceBase	3:03 AM · May 5, 2022 https://twitter.com/DarBenThu1/status/1522154973630320640
~0355	State Country Man Settlor Grantor Executor EBA 1933 Procurator Kinsman-Redeemer	2:10 AM · May 16, 2022 https://twitter.com/DarBenThu1/status/1526127817326415873	D #JointBasePearlHarborHickam #OahuHawaiiMilitaryBases #Idaho #MountainHomeAirForceBase #Illinois #ScottAFBGuide #Indiana #GrissomAirReserveBase #Kansas #McConnellAirForceBase #Louisiana #BarksdaleAirForceBase #Maryland #AndrewsAirForceBase #JointBaseAndrews #Massachusetts	3:03 AM · May 5, 2022 https://twitter.com/DarBenThu1/status/1522154973630320640
~0356	State Country Man Settlor	2:10 AM · May 16, 2022	E #HanscomAirForceBase #Mississippi	3:03 AM · May 5, 2022

:Mark	:Matter	:Location	:Claim	:Facts	118 / 199
-------	---------	-----------	--------	--------	-----------

2022-011769 MISC Page: 2701 of 2782
 09/26/2022 03:35:37 PM Receipt #: 22-9381
 Rec Fee: \$30.00 Darrell James Hill
 Gila County, Az, Sadie Jo Bingham, Recorder



Handwritten signature and date: 09/27/22

	Grantor Executor EBA 1933 Procurator Kinsman-Redeemer	https://twitter.com/DarBenThu1/status/1526127930752962561	#ColumbusAirForceBase #KeeslerAirForceBase #Missouri #WhitemanAirForceBase #Montana #MalmstromAirForceBase #Nebraska #OffuttAirForceBase #Nevada #Area51 #CreechAirForceBase #NellisAirForceBase #New Jersey #JointBaseMcGuireDixLakehurst	https://twitter.com/DarBenThu1/status/1522154973630320640
~0357	State Country Man Settlor Grantor Executor EBA 1933 Procurator Kinsman-Redeemer	2:10 AM · May 16, 2022 https://twitter.com/DarBenThu1/status/1526128003595440128	F #NewMexico #CannonAirForceBase #HollomanAirForceBase #KirtlandAirForceBase #NorthCarolina #FayettevilleNorthCarolinaMilitaryBases #PopeField #SeymourJohnsonAirForceBase #NorthDakota #GrandForksAirForceBase #MinotAirForceBase #Ohio #WrightPattersonAirForceBase	3:03 AM · May 5, 2022 https://twitter.com/DarBenThu1/status/1522154973630320640
~0358	State Country Man Settlor Grantor Executor EBA 1933 Procurator Kinsman-Redeemer	2:11 AM · May 16, 2022 https://twitter.com/DarBenThu1/status/1526128092149710848	G #Oklahoma #AltusAirForceBase #TinkerAirForceBase #VanceAirForceBase #South Carolina #CharlestonAirForceBase #JointBaseCharleston #ShawAirForceBase #South Dakota #EllsworthAirForceBase #Texas #DvessAirForceBase #GoodfellowAirForceBase #JointBaseSanAntonio #LacklandAirForceBase	3:03 AM · May 5, 2022 https://twitter.com/DarBenThu1/status/1522154973630320640
~0359	State Country Man Settlor Grantor Executor EBA 1933 Procurator Kinsman-Redeemer	2:11 AM · May 16, 2022 https://twitter.com/DarBenThu1/status/1526128210647187456	H #LaughlinAirForceBase #RandolphAirForceBase #RedRiverArmyDepot #SheppardAirForceBase #Utah #HillAirForceBase #Virginia #HamptonRoadsMilitaryBases #JointBaseLangleyEustis #LangleyAirForceBase #Washington #FairchildAirForceBase #JointBaseLewisMcChord #McChordField #Wyoming	3:03 AM · May 5, 2022 https://twitter.com/DarBenThu1/status/1522154973630320640
~0360	State Country Man Settlor	2:11 AM · May 16, 2022	I #FEWarrenAirForceBase #GeilenkirchenNATOAirBase	3:03 AM · May 5, 2022

:Mark	:Matter	:Location	:Claim	:Event	119 / 199
-------	---------	-----------	--------	--------	-----------

2022-011769 MISC Page: 2702 of 2782
 09/26/2022 03:35:37 PM Receipt #: 22-9381
 Rec Fee: \$30.00 Darrell James Hill
 Gila County, Az, Sadie Jo Bingham, Recorder



10/26

	Grantor Executor EBA 1933 Procurator Kinsman-Redeemer	https://twitter.com/DarBenThu1/status/1526128284345389058	#RamsteinAirBase #SpangdahlemAirBase #AndersenAirForceBase #AvianoAirBase #KadenaAirBase #MisawaAirBase #YokotaAirBase #KunsanAirBase	https://twitter.com/DarBenThu1/status/1522154973630320640
~0361	State Country Man Settlor Grantor Executor EBA 1933 Procurator Kinsman-Redeemer	2:12 AM · May 16, 2022 https://twitter.com/DarBenThu1/status/1526128435289915392	J #OsanAirBase #MoronAirBase #IncirlikAirBase #IzmirAirStation #TeamDoDTurkey #RAFAIconbury #RAFMolesworth #RAFCroughtonFairford #RAFLakenheath #RAFMildenhall	3:03 AM · May 5, 2022 https://twitter.com/DarBenThu1/status/1522154973630320640
~0362	State Country Man Settlor Grantor Executor EBA 1933 Procurator Kinsman-Redeemer	2:38 AM · May 16, 2022 https://twitter.com/DarBenThu1/status/1526135016777953280	A Why is completing YOUR Executor: EBA-1933-A.D. important? #NOAAservices #NationalWeatherService #NationalOceanService #NationalEnvironmentalSatelliteDataInformationService	8:13 PM · May 6, 2022 https://twitter.com/DarBenThu1/status/1522776515192139778 3:03 AM · May 5, 2022 https://twitter.com/DarBenThu1/status/1522154973630320640
~0363	State Country Man Settlor Grantor Executor EBA 1933 Procurator Kinsman-Redeemer	2:39 AM · May 16, 2022 https://twitter.com/DarBenThu1/status/1526135148961333249	B Why is completing YOUR Executor: EBA-1933-A.D. important? #NationalMarineFisheriesService #OfficeOceanicAtmosphericResearch #NOAAShipsAircraftOfficeMarineAviationOperations #NationalGeodeticSurvey #NationalIntegratedDroughtInformationSystem #NOAACommissionedOfficerCorps	8:13 PM · May 6, 2022 https://twitter.com/DarBenThu1/status/1522776515192139778 3:03 AM · May 5, 2022 https://twitter.com/DarBenThu1/status/1522154973630320640

:Mark	:Matter	:Location	:Claim	:Facts	120 / 199
-------	---------	-----------	--------	--------	-----------



Handwritten signature/initials

				1522154973630320640
~0364	State Country Man Settlor Grantor Executor EBA 1933 Procurator Kinsman-Redeemer	3:04 AM · May 16, 2022 https://twitter.com/DarBenThu1/status/1526141552984084480	A Why is completing YOUR Executor: EBA-1933-A.D. important? #USPublicHealthService #USPHS #USPHSDentist #USPHSDietitian #USPHSEngineer #USPHSEnvironmentalHealthOfficers #USPHSHealthServices #USPHSBasicAppliedScience #USPHSDentaHygiene #USPHSHealthcareAdministration	8:13 PM · May 6, 2022 https://twitter.com/DarBenThu1/status/1522776515192139778 3:03 AM · May 5, 2022 https://twitter.com/DarBenThu1/status/1522154973630320640
~0365	State Country Man Settlor Grantor Executor EBA 1933 Procurator Kinsman-Redeemer	3:05 AM · May 16, 2022 https://twitter.com/DarBenThu1/status/1526141718029930496	B Why is completing YOUR Executor: EBA-1933-A.D. important? #USPHSHealthInformationTechnology #USPHSMedicalLaboratoryScience #USPHSOptomety #USPHSPhysicianAssistant #USPHSPodiatry #USPHSPublicHealth #USPHSPsychology #USPHSSocialWork #USPHSNurse #USPHSMedicalOfficer	8:13 PM · May 6, 2022 https://twitter.com/DarBenThu1/status/1522776515192139778 3:03 AM · May 5, 2022 https://twitter.com/DarBenThu1/status/1522154973630320640
~0366	State Country Man Settlor Grantor Executor EBA 1933 Procurator Kinsman-Redeemer	3:05 AM · May 16, 2022 https://twitter.com/DarBenThu1/status/1526141863949807621	C #USPHSPharmacist #USPHSScientist #USPHSPhysicalTherapist #USPHSOccupationalTherapist #USPHSSpeechTherapist #USPHSRespiratoryTherapist #USPHSVeterinarian	8:13 PM · May 6, 2022 https://twitter.com/DarBenThu1/status/1522776515192139778 3:03 AM · May 5, 2022 https://twitter.com/DarBenThu1/status/1522154973630320640

:Mark	:Matter	:Location	:Claim	:Facts	121 / 199
-------	---------	-----------	--------	--------	-----------



Handwritten initials/signature

~0367		10:00 AM · May 16, 2022 https://twitter.com/DarBenThu1/status/1526246346444771328	2022 MAY 16 Letter to my brethren: DOI-1776-AD https://twitter.com/DarBenThu1/status/1526246346444771328/photo/1 https://twitter.com/DarBenThu1/status/1526246346444771328/photo/2	
~0368	State Country Man Settlor Grantor Executor EBA 1933 Procurator Kinsman-Redeemer	2:41 PM · May 16, 2022 https://twitter.com/DarBenThu1/status/1526316869572997120	A Why is completing YOUR Executor: EBA-1933-A.D. important? #BuckleySpaceForceBase #USSF #CapeCodSpaceForceStation #CheyenneMountainSpaceForceStation #LosAngelesAirForceBase #NewBostonSpaceForceStation	3:03 AM · May 5, 2022 https://twitter.com/DarBenThu1/status/1522154973630320640
~0369	State Country Man Settlor Grantor Executor EBA 1933 Procurator Kinsman-Redeemer	2:42 PM · May 16, 2022 https://twitter.com/DarBenThu1/status/1526317213493342208	A Why is completing YOUR Executor: EBA-1933-A.D. important? #BuckleySpaceForceBase #CapeCodSpaceForceStation #CheyenneMountainSpaceForceStation #LosAngelesAirForceBase #NewBostonSpaceForceStation	8:13 PM · May 6, 2022 https://twitter.com/DarBenThu1/status/1522776515192139778 3:03 AM · May 5, 2022 https://twitter.com/DarBenThu1/status/1522154973630320640
~0370	State Country Man Settlor Grantor Executor EBA 1933 Procurator	2:43 PM · May 16, 2022 https://twitter.com/DarBenThu1/status/1526317318019612673	B #PatrickSpaceForceBase #PetersonSpaceForceBase #SchrieverSpaceForceBase #VandenbergSpaceForceBase #KaenaPointSpaceForceStation #ClearSpaceForceStation #ThuleAirBase	8:13 PM · May 6, 2022 https://twitter.com/DarBenThu1/status/1522776515192139778

:Mark	:Matter	:Location	:Claim	:Facts	122 / 199
-------	---------	-----------	--------	--------	-----------

2022-011769 MISC Page: 2705 of 2782
 09/26/2022 03:35:37 PM Receipt #: 22-9381
 Rec Fee: \$30.00 Darrell James Hill
 Gila County, Az, Sadie Jo Bingham, Recorder



1544

	Kinsman-Redeemer			3:03 AM · May 5, 2022 https://twitter.com/DarBenThu1/status/1522154973630320640
-0371	State Country Man Settlor Grantor Executor EBA 1933 Procurator Kinsman-Redeemer	9:28 AM · May 17, 2022 https://twitter.com/DarBenThu1/status/1526600628306255872	Yeah, at 90% annum for 97 years. Gold, etc.- :private-side - principal- AND #FRBank -#USTreasurer asset-accounts on the public-side- accounts. We're born :settlers, grown-up: grantors who must now execute by -:right: #DOI1776AD - demand for the accounts-collection to you and fam.	https://twitter.com/DarBenThu1/status/1526600628306255872/photo/1 -Franklin D Roosevelt -EO: give us all of your gold; 1933 April 05-
~0372	General Milley State Country Man Settlor Grantor Executor EBA 1933 Procurator Kinsman-Redeemer	12:04 PM · May 17, 2022 https://twitter.com/DarBenThu1/status/1526639844423630849	FROM: Procurator- Darrell-James: Hill -Ohioan -Executor- Procurator: PE-2016-A.D.- EBA-1933-A.D. -Covenant TO: #GenMilley , #GenMilleyOn #CJOS #USAirmedForces #USArmy #USNavy #USMarines #USCoastGuard #USNOAA #USPHS #USAirforce #USSF Greetings State-Country-Man: ~See-:attached~	https://twitter.com/DarBenThu1/status/1526639844423630849/photo/1 :Darrell-James: Hill- Ohioan-Grantor-Executor: DOI-1776-AD; -Executor-Procurator: EBA-1933-AD, -:2021-AD
~0373	State Country Man Settlor Grantor Executor EBA 1933 Procurator Kinsman-Redeemer	12:47 PM · May 17, 2022 https://twitter.com/DarBenThu1/status/1526650724246904832	#StateCountryManSettlor #CompletePrivateExclusiveAbsoluteOwnerAccounts #UsofAArmedForcesMembersRetired #StateCountryManGrantorExecutor #StateCountryManGrantorServiceMember #UsofAArmedForcesMembersRetiredStateCountryManSettlor	12:04 PM · May 17, 2022 https://twitter.com/DarBenThu1/status/1526639844423630849
-0374	State Country Man Settlor Grantor Executor EBA 1933 Procurator	11:31 PM · May 17, 2022 https://twitter.com/DarBenThu1/status/	A Why the #FedGovWorker #StateCountryManGrantor of the DOI1776AD Granting of their Executor over the DOI-1776-A.D. - EBA-1933-A.D. -Covenant is important? #FedGovEmployee #FederalEmployees #FederalWorkers	8:13 PM · May 6, 2022 https://twitter.com/DarBenThu1/status/1522776515192139778

:Mark	:Matter	:Location	:Claim	:Facts	123 / 199
-------	---------	-----------	--------	--------	-----------

2022-011769 MISC Page: 2706 of 2782
 09/26/2022 03:35:37 PM Receipt #: 22-9381
 Rec Fee: \$30.00 Darrell James Hill
 Gila County, Az, Sadie Jo Bingham, Recorder



Handwritten signature

	Kinsman-Redeemer	1526812695013404672	#FedGovWorkers #USCongress #USSupremeCourt #SCOTUS #USHouse	3:03 AM · May 5, 2022 https://twitter.com/DarBenThu1/status/1522154973630320640
-0375	State Country Man Settlor Grantor Executor EBA 1933 Procurator Kinsman-Redeemer	11:32 PM · May 17, 2022 https://twitter.com/DarBenThu1/status/1526813030062837760	B Why the #FedGovWorker #StateCountryManGrantor :DOI1776AD Granting of their Executor over the DOI-1776-A.D. - EBA-1933-A.D. -Covenant is important? #SCOTUS #USHouse #USSenate #USDA #USDepartmentofAgriculture #dUSACommerce #USDepartmentOfCommerce #USDOD #USDepartmentOfDefense	8:13 PM · May 6, 2022 https://twitter.com/DarBenThu1/status/1522776515192139778 3:03 AM · May 5, 2022 https://twitter.com/DarBenThu1/status/1522154973630320640
-0376	State Country Man Settlor Grantor Executor EBA 1933 Procurator Kinsman-Redeemer	11:33 PM · May 17, 2022 https://twitter.com/DarBenThu1/status/1526813171834421248	C Why the #FedGovWorker #StateCountryManGrantor of the DOI1776AD Granting of their Executor over the DOI-1776-A.D. - EBA-1933-A.D. -Covenant is important? #USDepartmentOfDefense #usedgov #USDepartmentofEducation #StateCountryManGrantorDOI1776AD #StateCountryManGrantorDOI1776AD	8:13 PM · May 6, 2022 https://twitter.com/DarBenThu1/status/1522776515192139778 3:03 AM · May 5, 2022 https://twitter.com/DarBenThu1/status/1522154973630320640
-0377	State Country Man Settlor Grantor Executor EBA 1933 Procurator	11:33 PM · May 17, 2022 https://twitter.com/DarBenThu1/status/1526813171834421248	D Why the #FedGovWorker #StateCountryManGrantor of the DOI1776AD Granting of their Executor over the DOI-1776-A.D. - EBA-1933-A.D. -Covenant is important? #USDepartmentofEnergy	8:13 PM · May 6, 2022 https://twitter.com/DarBenThu1/status/1522776515192139778

:Mark	:Matter	:Location	:Claim	:Facts	124 / 199
-------	---------	-----------	--------	--------	-----------

2022-011769 MISC Page: 2707 of 2782
 09/26/2022 03:35:37 PM Receipt #: 22-9381
 Rec Fee: \$30.00 Darrell James Hill
 Gila County, Az, Sadie Jo Bingham, Recorder

Handwritten signature/initials

:Two-Year-Review :Dar-Ben-Thu: Hill ~www.twitter.com/DarBenThu1~ -Authority
https://twitter.com/hashtag/darbenthu1September222020?src=hashtag_click
:DarBenThu1 -Box-Graph: #September2020AD > #August2022AD

	Kinsman-Redeemer	1526813312033230848	#USDepartmentofHealthandHumanServices #USDepartmentofHomelandSecurity #DHS #USHUD	3:03 AM · May 5, 2022 https://twitter.com/DarBenThu1/status/1522154973630320640
~0378	State Country Man Settlor Grantor Executor EBA 1933 Procurator Kinsman-Redeemer	11:34 PM · May 17, 2022 https://twitter.com/DarBenThu1/status/1526813388919017472	E Why the #FedGovWorker #StateCountryManGrantor of the DOI1776AD Granting of their Executor over the DOI-1776-A.D. - EBA-1933-A.D. - Covenant is important? #USDepartmentofHousingandUrbanDevelopment #HUD #USDepartmentoftheInterior #USDOJ #StateCountryManGrantorDOI1776AD	8:13 PM · May 6, 2022 https://twitter.com/DarBenThu1/status/1522776515192139778 3:03 AM · May 5, 2022 https://twitter.com/DarBenThu1/status/1522154973630320640
~0379	State Country Man Settlor Grantor Executor EBA 1933 Procurator Kinsman-Redeemer	11:34 PM · May 17, 2022 https://twitter.com/DarBenThu1/status/1526813469269295109	F Why the #FedGovWorker #StateCountryManGrantor of the DOI1776AD Granting of their Executor over the DOI-1776-A.D. - EBA-1933-A.D. - Covenant is important? #USDepartmentofJustice #USDQJ #USDepartmentofLabor #USDOL #USDepartmentofState #USStateDepartment #USDOS	8:13 PM · May 6, 2022 https://twitter.com/DarBenThu1/status/1522776515192139778 3:03 AM · May 5, 2022 https://twitter.com/DarBenThu1/status/1522154973630320640
~0380	State Country Man Settlor Grantor Executor EBA 1933	11:34 PM · May 17, 2022 https://twitter.com/	G Why the #FedGovWorker #StateCountryManGrantor of the DOI1776AD Granting of their Executor over the DOI-1776-A.D. - EBA-1933-A.D. - Covenant is important?	8:13 PM · May 6, 2022 https://twitter.com/DarBenThu1/status/

:Mark	:Matter	:Location	:Claim	:Facts	125 / 199
-------	---------	-----------	--------	--------	-----------



MSJ

	Procurator Kinsman-Redeemer	DarBenThu1/status/ 1526813568301146113	#USDepartmentofTransportation #USTRansportationDepartment #USDOT #USDepartmentoftheTreasury #USTreasuryDepartment	1522776515192139778 3:03 AM · May 5, 2022 https://twitter.com/DarBenThu1/status/ 1522154973630320640
~0381	State Country Man Settlor Grantor Executor EBA 1933 Procurator Kinsman-Redeemer	11:35 PM · May 17, 2022 https://twitter.com/ DarBenThu1/status/ 1526813696227282945	H Why the #FedGovWorker #StateCountryManGrantor of the DOI1776AD Granting of their Executor over the DOI-1776- A.D. - EBA-1933-A.D. -Covenant is important? #USTreasury #USDepartmentofVeteransAffairs #USVeteransAdministration #USDepartmentofCommerce #USCommerceDepartment	8:13 PM · May 6, 2022 https://twitter.com/DarBenThu1/status/ 1522776515192139778 3:03 AM · May 5, 2022 https://twitter.com/DarBenThu1/status/ 1522154973630320640
~0382	Check-off tood BC Authenticaiton EBA 1933 Closure	4:33 PM · May 19, 2022 https://twitter.com/ DarBenThu1/status/ 1527432353856901122	Check-Off-Lists For auth → civil-Live-STATUS - > :EBA1933AD- account-SETTLE & Closure :Check-Off-Lists For -:Estab: #StateCountryManSettlerGrantor - #DOI1776AD -#EBA1933AD -AUTHENTICATION → RECORDATION → APPOINT-EXECUTOR & DEMAND- #EBA1933AD - ACCOUNT -RENDERING, SETTLE, AND CLOSURE	https://twitter.com/DarBenThu1/status/ 1527432353856901122/photo/1 Check-off list for Settlor-Grantor appoint Executor https://twitter.com/DarBenThu1/status/ 1527432353856901122/photo/2 Check-off Graph for the Authentication of the BC for the civil-live-Status

:Mark	:Matter	:Location	:Claim	:Facts	126 / 199
-------	---------	-----------	--------	--------	-----------

[Handwritten signature]

:Two-Year-Review :Dar-Ben-Thu: Hill ~www.twitter.com/DarBenThu1~ -Authority
https://twitter.com/hashtag/darbenthu1September222020?src=hashtag_click
:DarBenThu1 -Box-Graph: #September2020AD > #August2022AD

~0383	KJV Holy Bible Companion Bible Bullinger 1922 Strong's Concordance	4:39 PM · May 19, 2022 https://twitter.com/DarBenThu1/status/1527433838422417409	a) The Companion Bible: Enlarged Type Edition by E.W. Bullinger ~\$67.56 Amazon~ https://amazon.com/E-W-Bullinger/e/B001K7X8F6?ref=sr_ntt_srch_lnk_1&qid=1652990824&sr=8-1 AND b) The (New) Strong's Exhaustive Concordance of the Bible Hardcover ~\$37.32 Amazon~ https://amazon.com/James-Strong/e https://twitter.com/DarBenThu1/status/1527433838422417409/photo/1 Best-Two-Books to un-Dumb-down	https://www.amazon.com/E-W-Bullinger/e/B001K7X8F6?ref=sr_ntt_srch_lnk_1&qid=1652990824&sr=8-1 https://www.amazon.com/James-Strong/e/B001LIBQK?ref=sxin_10_mbs_w_global_sims&qid=1652990824&sr=1-3-9e7645f9-2d19-4bff-863e-f6cdbe50f990
~0384	Subclinical Starvation Body Toxins Poison waters	11:12 PM · May 19, 2022 https://twitter.com/DarBenThu1/status/1527532664940466176	Situation-Report: subclinical-Starvation -> Toxic-Levels-of-Body-Toxins-Accumulation-> Deoxygenation of World-Environment for -:proft, etc., poison-waters. yeah. Anyway, see: Settlor of Trust: Definition, Roles and General Overview https://brokerininsurance.com/terms/settlor-of-trust/ Good place to start.	
~0385	State Country Man Sovereign Settlor Grantor Owner	12:47 PM · May 17, 2022 https://twitter.com/DarBenThu1/status/1526650724246904832	#StateCountryManSettlor #CompletePrivateExclusiveAbsoluteOwnerAccounts #UsOfAArmedForcesMembersRetired #StateCountryManGrantorExecutor #StateCountryManGrantorServiceMember	12:04 PM · May 17, 2022 https://twitter.com/DarBenThu1/status/1526639844423630849

:Mark	:Matter	:Location	:Claim	:Facts
-------	---------	-----------	--------	--------



1107

			#USofAArmedForcesMembersRetiredStateCountryManSettlor	
~0386	salicylate	11:53 AM · May 20, 2022 https://twitter.com/DarBenThu1/status/1527724297694810112	Acetylsalicylate and salicylates in foods https://twitter.com/intent/tweet?text=Acetylsalicylate%20and%20salicylates%20in%20foods%20https%3A/pubmed.ncbi.nlm.nih.gov/9103279/ Salicylates in foods https://pubmed.ncbi.nlm.nih.gov/4019987/	
~0387	Genitive Case Companion Bible	2:33 PM · May 21, 2022 https://twitter.com/DarBenThu1/status/1528126849200844800	The #GenitiveCase of a Fact : #TheCompanionBible -:1922 A.D. ~1999 A.D./ Kregel Pub. 1999 A.D.~ :Appendix: 17, p. 23	https://twitter.com/DarBenThu1/status/1528126849200844800/photo/1 The Genitive Case of a Fact, -:1922-AD
~0388	Assange wikileaks	7:35 AM · May 22, 2022 https://twitter.com/DarBenThu1/status/1528383990691864577	US National Press Club Still Refuses to Defend Assange https://consortiumnews.com/2022/05/20/cn-	https://consortiumnews.com/2022/05/20/cn-lobbies-national-press-club-on-assange/
~0389	Assange wikileaks	7:37 AM · May 22, 2022 https://twitter.com/DarBenThu1/status/1528384491890151424	"Every level of the case against Julian Assange has been shot through with corruption and the abuse of process."— @Snowden #FreeAssangeNOW #DropTheCharges	https://twitter.com/SomersetBean/status/1526701868612739077/photo/1 "Every level of the case against Julian Assange has been shot through with corruption and the

:Mark	:Matter	:Location	:Claim	:Facts	128 / 199
-------	---------	-----------	--------	--------	-----------



OPHE

				abuse of process."— @Snowden
~0390	KJV Proverbs 19	11:24 AM · May 25, 2022 https://twitter.com/DarBenThu1/status/1529528908453883904	Shalom. 1611 -King-James-Version, :Proverbs: Chap. 19. = a day to read it, :3+ days to writ upon the tale of your heart. PLEASE DL any information- wanted- later. :Site-Changes may effect the access to the present- material -context and content. Shalom.	https://twitter.com/DarBenThu1/status/1529528908453883904/photo/2 Proverbs Chap 19
~0391	Water warships nuclear attacks	1:18 PM · May 25, 2022 https://twitter.com/DarBenThu1/status/1529557475086970880	:2022 may 25 , :DarBenThu1 Using WATER to Protect Warships Against Nuclear Attacks See: results with Operation Castle https://youtube.com/watch?v=o2J4W406qbU https://youtube.com/watch?v=o2J4W4	
~0392	Parens Patriae	3:40 AM · May 26, 2022 https://twitter.com/DarBenThu1/status/1529774465780809728	Parens- patriae Legal definition of parens patriae ~webster dict on line~ : the state in its capacity as the legal guardian of persons not sui juris	https://twitter.com/DarBenThu1/status/1529774465780809728/photo/1 Parens-Patriae
~0393	Orange Tree Tea Leaves	3:05 PM · May 26, 2022 https://twitter.com/DarBenThu1/status/1529946812487872513	Some Health Benefits of Orange Tree Tea Leaves Will Work Effectively https://lifeberrys.com/healthy-living	https://www.lifeberrys.com/healthy-living/some-health-benefits-of-orange-tree-tea-leaves-will-work-effectively-151618.html?utm_source=twitter
~0394	Menticide	12:38 AM · May 27, 2022	:You -i [=God]- man are protected with -:knowledge of the MENTICIDE- Subversion-processes: Hegelian-Dialectics.	https://youtu.be/09maaUaRT4M

:Mark	:Matter	:Location	:Claim	:Facts	129 / 199
-------	---------	-----------	--------	--------	-----------



:Two-Year-Review :Dar-Ben-Thu: Hill ~www.twitter.com/DarBenThu1~ -Authority
https://twitter.com/hashtag/darbenthu1September222020?src=hashtag_click
:DarBenThu1 -Box-Graph: #September2020AD > #August2022AD

		https://twitter.com/DarBenThu1/status/1530090959429459968	Yeah..., now, AVOID THE CRISES- PROGRAMS and Traps! Comprehend-know :MENTICIDE -Force-fear-SOCIOPATHY- tools now-used upon all mankind. Study-	https://youtu.be/09maaUaRT4M?t=3 Mass Psychosis; Killing the Mind
~0495	Gold accounts EBA 1933	9:28 AM · May 17, 2022 https://twitter.com/DarBenThu1/status/1526600628306255872	Yeah, at 90% annum for 97 years. Gold, etc.- :priavte-side - principal- AND #FRBank -#USTreasurer asset-accounts on the public-side- accounts. We're born :settlor, grown-up: grantors who must now execute by -:right: #DOI1776AD - demand for the accounts-collection to you and fam.	9:28 AM · May 17, 2022 https://twitter.com/DarBenThu1/status/1526600628306255872
~0496	Procurator EBA 1933 General Milley	12:04 PM · May 17, 2022 https://twitter.com/DarBenThu1/status/1526639844423630849	FROM: Procurator- Darrell-James: Hill -Ohioan -Executor- Procurator: PE-2016-A.D.- EBA-1933-A.D. -Covenant TO: #GenMilley , #GenMilleyOn #CJOS #USAirMedForces #USArmy #USNavy #USMarines #USCoastGuard #USNOAA #USPHS #USAirforce #USSE Greetings State-Country-Man: ~See-:attached~	12:04 PM · May 17, 2022 https://twitter.com/DarBenThu1/status/1526639844423630849 Give-back the EBA-1933-AD -CQV-T to the USofA Armed Forces MemberBeneficiary
~0497	State Country Man Sovereign Settlor Grantor Owner	5:04 PM · May 27, 2022 https://twitter.com/DarBenThu1/status/1530339167502118912	:i- man @DarBenThu1 #StateCountryManSettlor #CompletePrivateExclusiveAbsoluteOwnerAccounts #UsofAArmedForcesMembersRetired #StateCountryManGrantorExecutor #StateCountryManGrantorServiceMember #USofAArmedForcesMembersRetiredStateCountryManSettlor https://twitter.com/DarBenThu1/status/1526639844423630849 ?s=20&t=ij2nal9M9i7nvxi0ZiB-Vg SHALOM.	12:04 PM · May 17, 2022 https://twitter.com/DarBenThu1/status/1526639844423630849

:Mark	:Matter	:Location	:Claim	:Facts	130 / 199
-------	---------	-----------	--------	--------	-----------



2022

:Two-Year-Review :Dar-Ben-Thu: Hill ~www.twitter.com/DarBenThu1~ -Authority
https://twitter.com/hashtag/darbenthu1September222020?src=hashtag_click
:DarBenThu1 -Box-Graph: #September2020AD > #August2022AD

-0498	BAR Attorney CftUSofA 1787 GFTUSA 1787 Original 13 th Amendment	<u>5:23 PM · May 27, 2022</u> https://twitter.com/DarBenThu1/status/1530344045616037888	Shalom, WHY is a B.A.R- Attorney NOT-Lawful-Legal-permitted to work for the Government for the United-States of America #GFTUSA1787AD ? Ans: It is: a) Not-Authorized by the #CftUSofA1787AD ; & 2) Not-Authorized by the #Original13thAmendment . Equip: soldier-safety: Military. - TY.	
-0499	Companion Bible	<u>3:48 AM · May 28, 2022</u> https://twitter.com/DarBenThu1/status/1530501199178256384	The Companion Bible ~ DL~; Excellent! https://ia801806.us.archive.org/33/items/e.-w.-bullinger-the-companion-bible-enlarged-type-edition-pdf-rofcopter-2110/E.%20W.%20Bullinger%20-%20The%20Companion%20Bible%20-%20Enlarged%20Type%20Edition%20%28pdf%29%20-%20rofcopter2110.pdf	https://ia801806.us.archive.org/33/items/e.-w.-bullinger-the-companion-bible-enlarged-type-edition-pdf-rofcopter-2110/E.%20W.%20Bullinger%20-%20The%20Companion%20Bible%20-%20Enlarged%20Type%20Edition%20%28pdf%29%20-%20rofcopter2110.pdf
-0500	Julie Green	<u>12:51 PM · May 28, 2022</u> https://twitter.com/DarBenThu1/status/1530637859677274112	DARKNESS WILL TURN TO LIGHT 05/21/22 JULIE GREEN MINISTRIES Published May 24, 2022 52,114 Views https://rumble.com/v15wrov-darkness-will-turn-to-light.html Listen, if you want to hear an encouraging word.	
-0501	Elevatin Worship La Bendicion	<u>6:18 PM · May 28, 2022</u> https://twitter.com/DarBenThu1/status/1530720166140448769	Elevation Worship – La Bendición (The Blessing) @elevationworship	https://genius.com/Elevation-worship-la-bendicion-the-blessing-lyrics
-0502	David Wynn Miller CSSCPG Seminar	<u>1:16 AM · May 29, 2022</u> https://twitter.com/DarBenThu1/status/	Learning this is WORK! : David-Wynn: Miller -:CSSCPG - Quantum Language Grammar Syntax Seminar, 2012 AGUILA 2:24:11 / 9:30:52	https://youtu.be/blu8bsTOi4I

:Mark	:Matter	:Location	:Claim	:Facts	131 / 199
-------	---------	-----------	--------	--------	-----------



2143

:Two-Year-Review :Dar-Ben-Thu: Hill ~www.twitter.com/DarBenThu1~ -Authority
https://twitter.com/hashtag/darbenthu1September222020?src=hashtag_click
:DarBenThu1 -Box-Graph: #September2020AD > #August2022AD

		1530825279110754304		
~0503	CSSCPG David Wynn Miller Language Fraud	8:20 AM · May 29, 2022 https://twitter.com/DarBenThu1/status/1530932079948492800	CSSCPG. Better- video- succinct. : David-wynn: Miller. -9th-July-2014. : Language-Fraud-Trial-Hearing.	https://youtu.be/_vF5VRmYp6Q
~0504	CSSCPG syntax	8:45 AM · May 29, 2022 https://twitter.com/DarBenThu1/status/1530938481584635904	CSSCPG ~Complete-Sentence-Sense-Correct-Parse-Syntax-Grammar~SYNTAX TO THE DISTINCT-CONTRACT-MEANINGS means: an ordered-structured-logical-pattern that allows anyone from any language to cipher the same-clear-meaning-upon the interpretation by the standard CSSCPG-cipher. See:	6:53 AM · Apr 4, 2022 https://twitter.com/DarBenThu1/status/1510978786942074882
:Era 2 #June2022DarBenThu1			:Era 2 #June2022DarBenThu1	
~0505	China Police File Hack	3:12 PM · Jun 2, 2022 https://twitter.com/DarBenThu1/status/1532485442137825280	laowhy86 -- https://youtube.com/c/laowhy86 Xinjiang Police File Hack - Why China is Terrified	https://youtu.be/NlpxtYQxqU https://youtu.be/NlpxtYQxqU?t=2
~0506	Financial power	3:29 PM · Jun 2, 2022 https://twitter.com/DarBenThu1/status/1532489491251744769	Financial Power, Money Manipulation; Overview- FULL DOCUMENTARY	https://youtu.be/npXbFUAFtYk https://youtu.be/npXbFUAFtYk?t=3 Financial Power, Money Manipulation; Overview- FULL DOCUMENTARY

:Mark	:Matter	:Location	:Claim	:Facts	132 / 199
-------	---------	-----------	--------	--------	-----------



Handwritten signatures and initials:
 [Signature]
 [Signature]
 [Signature]

~0507	Reactive Oxygen Species ROS Citrulline nitric oxide	10:45 PM · Jun 8, 2022 https://twitter.com/DarBenThu1/status/1534773621847203840	This is mayl help you. Production and Detection of Reactive Oxygen Species (ROS) in Cancers https://ncbi.nlm.nih.gov/pmc/articles/PMC3308605/ Effects of L-citrulline oral supplementation on polymorphonuclear neutrophils oxidative burst and nitric oxide production after exercise https://tandfonline.com/doi/full/10.1080/10715760903071664	https://www.ncbi.nlm.nih.gov/pmc/articles/PMC3308605/ https://www.tandfonline.com/doi/abs/10.1080/10715760903071664?journalCode=ifra20
~0508	Assange Stella Moris	5:27 PM · Jun 9, 2022 https://twitter.com/DarBenThu1/status/1535056075904339968	Julian might consider asking for ASYLUM in the USofA. At least ask the question. Julian Assange's wife Stella Moris reveals how they raise children together while he is in jail waiting an extradition decision :i-man suggested that Assange ask for asylum on the USofA-Country.	https://www.abc.net.au/news/2022-06-08/stella-moris-my-life-with-julian-assange-extradition/101132624?utm_campaign=abc_news_web&utm_content=twitter&utm_medium=content_shared&utm_source=abc_news_web
~0509	Julie Green Ministries	8:40 PM · Jun 10, 2022 https://twitter.com/DarBenThu1/status/1535466995885350913	SHOCKWAVES ARE COMING TO DESTROY YOUR ENEMIES PLANS JULIE GREEN MINISTRIES Published June 7, 2022 48,755 Views	https://rumble.com/v17m1z6-shockwaves-are-coming-to-destroy-your-enemies-plans.html
~0510	Russia Hunter Biden CDC Soros Biolabs Ukraine	11:18 AM · Jun 11, 2022 https://twitter.com/DarBenThu1/status/1535687860879171584	Russia Accuses Hunter Biden, CDC and George Soros of Involvement in Biolabs in Ukraine -	https://needtoknow.news/2022/03/russia-accuses-hunter-biden-cdc-and-george-soros-of-involvement-in-biofabs-in-ukraine/

:Mark	:Matter	:Location	:Claim	:Facts	133 / 199
-------	---------	-----------	--------	--------	-----------



gnt

:Two-Year-Review :Dar-Ben-Thu: Hill ~www.twitter.com/DarBenThu1~ -Authority
https://twitter.com/hashtag/darbenthu1September222020?src=hashtag_click
:DarBenThu1 -Box-Graph: #September2020AD > #August2022AD

-0511	Assange Julian	12:07 PM · Jun 11, 2022 https://twitter.com/DarBenThu1/status/1535700357703028737	Julian might consider asking for ASYLUM in the USofA. At least ask the question.	5:27 PM · Jun 9, 2022 https://twitter.com/DarBenThu1/status/1535056075904339968
-0512	Twitter SEC	12:28 PM · Jun 11, 2022 https://twitter.com/DarBenThu1/status/1535705604114632704	Sea SEC filings https://investor.twitterinc.com/financial-info	https://investor.twitterinc.com/financial-information/sec-filings/default.aspx
-0513	KJV Jude	12:23 PM · Jun 12, 2022 https://twitter.com/DarBenThu1/status/1536066737996566528	:i- man -struggled with the evil-of -:man-kind, :this-helped. Jude ~ 1:1 to 1:25	https://youtu.be/K8PPwoqjUA8 https://youtu.be/K8PPwoqjUA8?t=1
-0514	USD money FRN currency General Milley	2:17 PM · Jun 12, 2022 https://twitter.com/DarBenThu1/status/1536095452537401344	Did you know that USD-'money' is not equal to -:FRN-'Currency'; that, the -:FRN is Not 'money'? This is true? Yes. #DOI1776AD #GFTUSA1787AD #EBA1933AD #CftUSA1787AD #GOTUSA1863AD #PFTUSA1787AD #POTUSA1863AD #USCorp1933AD @DarBenThu1 @PFTUSAof1787AO #GenMilley , Protect :them!	https://twitter.com/DarBenThu1/status/1536095452537401344/photo/1 Money – FRN Graph
-0515	De-moralization De-stabilization Art of War Sun Tzu	7:07 PM · Jun 13, 2022 https://twitter.com/DarBenThu1/status/	{de-]moralization + [de-]stabilization + crises = [sub-]version -> with the war for the 'normalization'. How? Shma' The Art of War by Sun Tzu: Entire Unabridged Audiobook (Powerful	https://youtu.be/jxcMRkqaQdw https://youtu.be/jxcMRkqaQdw?t=1599

:Mark	:Matter	:Location	:Claim	:Facts	134 / 199
-------	---------	-----------	--------	--------	-----------



qph

:Two-Year-Review :Dar-Ben-Thu: Hill ~www.twitter.com/DarBenThu1~ -Authority
https://twitter.com/hashtag/darbenthu1September222020?src=hashtag_click
:DarBenThu1 -Box-Graph: #September2020AD > #August2022AD

		1536530623250038784	Narration)	The Art of War by Sun Tzu
~0516	US Navy Ranks	11:19 AM · Jun 14, 2022 https://twitter.com/DarBenThu1/status/1536775267888136192	US Navy Ranks https://youtube.com/watch?v=cz_bi5Jxd6s #Navy #USNavy #USofANavy #GenMilleyOn #JCOS #USofASovereign #USofASoldier #USofAVeteran #NavyVeteran #EBA1933AD #CftUSofA1787AD #DOI1776AD #StateCountryManSettlor #StateCountryManGrantor #StateCountryManGrantorExecutor #June2022AD	https://youtu.be/cz_bi5Jxd6s https://youtu.be/cz_bi5Jxd6s?t=1
~0517	US Air Force Ranks	11:24 AM · Jun 14, 2022 https://twitter.com/DarBenThu1/status/1536776584962527234	US Air Force Ranks https://youtube.com/watch?v=pPj64_tg1Ks&list=PL8CdbX5qc0L0B5JXKSOk9iJKDy5IT5z4g&index=4 #AirForce #USAirForce #USofAAirForce #GenMilleyOn #JCOS #USofASovereign #USofASoldier #USofAVeteran #AirForceVeteran #EBA1933AD #CftUSofA1787AD #DOI1776AD #StateCountryManSettlor #StateCountryManGrantorExecutor #June2022AD	https://youtu.be/pPj64_tg1Ks?list=PL8CdbX5qc0L0B5JXKSOk9iJKDy5IT5z4g
~0518	US Marine Ranks	11:27 AM · Jun 14, 2022 https://twitter.com/DarBenThu1/status/1536777349701586944	US Marine Ranks https://youtube.com/watch?v=k17RIPPHJKA&list=PL8CdbX5qc0L0B5JXKSOk9iJKDy5IT5z4g&index=7 #Marine #USMarine #USofAMarine #GenMilleyOn #JCOS #USofASovereign #USofASoldier #USofAVeteran #MarineVeteran #EBA1933AD #CftUSofA1787AD #DOI1776AD #StateCountryManSettlor #StateCountryManGrantor	https://youtu.be/k17RIPPHJKA?list=PL8CdbX5qc0L0B5JXKSOk9iJKDy5IT5z4g

:Mark	:Matter	:Location	:Claim	:Facts	135 / 199
-------	---------	-----------	--------	--------	-----------



10/2

			#StateCountryManGrantorExecutor #June2022AD	
-0519	US Space Force Ranks	11:29 AM · Jun 14, 2022 https://twitter.com/DarBenThu1/status/153677779957575680	US Space Force Ranks https://youtube.com/watch?v=Dqsne2fpKlo&list=PL8CdbX5qc0L0B5JXKSOK9iJKDy5IT5z4g&index=8 #SpaceForce #USSpaceForce #USofASpaceForce #GenMilleyOn #JCOS #USofASovereign #USofASoldier #USofAVeteran #SpaceForceVeteran #EBA1933AD #CftUSofA1787AD #DOI1776AD #StateCountryManSettlor #StateCountryManGrantorExecutor #June2022AD	https://youtu.be/Dqsne2fpKlo?list=PL8CdbX5qc0L0B5JXKSOK9iJKDy5IT5z4g
-0510	Royal Navy Ranks	11:32 AM · Jun 14, 2022 https://twitter.com/DarBenThu1/status/1536778715761324032	Royal Navy Ranks in order https://youtube.com/watch?v=XGvNGab1Aao&list=PL8CdbX5qc0L0B5JXKSOK9iJKDy5IT5z4g&index=9 #GenMilleyOn #JCOS #USofASovereign #USofASoldier #EBA1933AD #CftUSofA1787AD #DOI1776AD #Concession1213AD #TreatyOfParis1782 #TreatyOfParis1783AD #StateCountryManSettlor #StateCountryManGrantorExecutor #June2022AD	https://youtu.be/XGvNGab1Aao?list=PL8CdbX5qc0L0B5JXKSOK9iJKDy5IT5z4g
-0511	US Coast Guard Ranks	11:35 AM · Jun 14, 2022 https://twitter.com/DarBenThu1/status/1536779363835777024	US Coast Guard Ranks https://youtube.com/watch?v=aAuR3B4OrHs&list=PL8CdbX5qc0L0B5JXKSOK9iJKDy5IT5z4g&index=12 #CoastGuard #USCoastGuard #USofACoastGuard #GenMilleyOn #JCOS #USofASovereign #USofASoldier #USofAVeteran #CoastGuardVeteran #EBA1933AD #CftUSofA1787AD #DOI1776AD #StateCountryManSettlor	https://youtu.be/aAuR3B4OrHs?list=PL8CdbX5qc0L0B5JXKSOK9iJKDy5IT5z4g https://youtu.be/aAuR3B4OrHs?list=PL8CdbX5qc0L0B5JXKSOK9iJKDy5IT5z4g&t=24

:Mark	:Matter	:Location	:Claim	:Facts	136 / 199
-------	---------	-----------	--------	--------	-----------



gph

			#StateCountryManGrantorExecutor #June2022AD	
~0512	EBA 1933 Estate Trustee Issue	8:31 PM · Jun 14, 2022 https://twitter.com/DarBenThu1/status/1536914387507638274	Shalom. When my grandparents, parents, etc.- soul-journeymen of the family died, then the EBA-1933-A.D.- Trustee is obligated to issue their proceeds of the EBA-CQV-Trust-Estate to the family-remainderman ~kids~. If they did Not then it is a failure of issue by the TRUSTEE! Yep!	https://twitter.com/DarBenThu1/status/1536914387507638274/photo/1 :Failure of the Good-Behavior :Failure of the Issuance :Failure of the Righteous-Justice
~0513	Failure of the Trustee	12:30 AM · Jun 15, 2022 https://twitter.com/DarBenThu1/status/1536974523953623040	FAILURE OF TRUST. The lapsing or nonefficiency of a proposed trust, by reason of the defect or insufficiency of the deed or instrument creating it, or on account of illegality, indefiniteness, or other legal impediment. See: Larceny. Black's Law Dictionary, 4th Ed., p. 712.	https://twitter.com/DarBenThu1/status/1536980417680617472/photo/1 https://twitter.com/DarBenThu1/status/1536980417680617472/photo/2 https://twitter.com/DarBenThu1/status/1536980417680617472/photo/3 https://twitter.com/DarBenThu1/status/1536980417680617472/photo/4 FAILURE OF TRUST.
~0514	Failure of the Trustee	12:54 AM · Jun 15, 2022 https://twitter.com/DarBenThu1/status/1536980417680617472	p. 2 - 5/ 9 FAILURE OF TRUST. The lapsing1 or nonefficiency2 of a proposed3 trust4, by reason of the defect or insufficiency of the deed5 or instrument6 creating it, or on account of illegality7, indefiniteness8, or other legal	https://twitter.com/DarBenThu1/status/1536980417680617472/photo/1 https://twitter.com/DarBenThu1/status/1536980417680617472/photo/2

:Mark	:Matter	:Location	:Claim	:Facts	137 / 199
-------	---------	-----------	--------	--------	-----------



Handwritten signature

			impediment9. Black's Law Dictionary, 4th Ed., p. 712	https://twitter.com/DarBenThu1/status/1536980417680617472/photo/3 https://twitter.com/DarBenThu1/status/1536980417680617472/photo/4 FAILURE OF TRUST, p. 2.
~0515	Failure of the Trustee	12:59 AM · Jun 15, 2022 https://twitter.com/DarBenThu1/status/1536981590605066240	p. 6 - 9/ 9 FAILURE OF TRUST. The lapsing1 or nonefficiency2 of a proposed3 trust4, by reason of the defect or insufficiency of the deed5 or instrument6 creating it, or on account of illegality7, indefiniteness8, or other legal impediment9. Black's Law Dictionary, 4th Ed., p. 712	https://twitter.com/DarBenThu1/status/1536981590605066240/photo/1 https://twitter.com/DarBenThu1/status/1536981590605066240/photo/2 https://twitter.com/DarBenThu1/status/1536981590605066240/photo/2 https://twitter.com/DarBenThu1/status/1536981590605066240/photo/2 FAILURE OF TRUST, p. 6.
~0516	State Country Man Sovereign Settlor Grantor Executor EBA 1933 DOI 1776 USofA 1776 People Almighty-God	9:56 AM · Jun 15, 2022 https://twitter.com/DarBenThu1/status/1537116842744872960	What is the #StateCountryManSettlors '-heritage, #Grantors '-authority, #Executors '-duty to the #USofA1776AD #DOI1776AD ? How can one know the job of the#covenantors ~#USofA1776ADpeople and #AlmightyGod ? Where is it hidden?! Ans. in the Holy-Bible! OMG, yep, right-out in the open.	https://twitter.com/DarBenThu1/status/1536981590605066240/photo/2 https://twitter.com/DarBenThu1/status/1536981590605066240/photo/2 KJV- Ephesians 2

:Mark	:Matter	:Location	:Claim	:Facts	138 / 199
-------	---------	-----------	--------	--------	-----------



DJH

:Two-Year-Review :Dar-Ben-Thu: Hill ~www.twitter.com/DarBenThu1~ -Authority
https://twitter.com/hashtag/darbenthu1September222020?src=hashtag_click
:DarBenThu1 -Box-Graph: #September2020AD > #August2022AD

-0517	Kamakawiwo Soul-journer Hawaiian Somewhere over the Rainbow	1:37 PM · Jun 15, 2022 https://twitter.com/DarBenThu1/status/1537172486231556100	OFFICIAL Somewhere over the Rainbow - #Israel "#IZ" #Kamakawiwo'ole https://youtube.com/watch?v=V1bFr2SWP1I : #Hawaiian- #souljourner-1959-1997-A.D. Did the #Trustee complete the issue of his #EBA1933AD #COVTrust to his remainderman- #Hawaiiansouljourner - Family?	https://youtu.be/V1bFr2SWP1I https://youtu.be/V1bFr2SWP1I?t=43 Somewhere over the Rainbow
-0518	1 US code 204 Evidence of the law	3:09 PM · Jun 15, 2022 https://twitter.com/DarBenThu1/status/1537195574457417728	1 U.S. Code § 204 - Codes and Supplements as evidence of the laws of United States and District of Columbia; citation of Codes and Supplements Check the attached original and big- print-translation. What did you get? ... 'Some-details of the relationships are missing, huh?	https://twitter.com/DarBenThu1/status/1536981590605066240/photo/2 https://twitter.com/DarBenThu1/status/1536981590605066240/photo/2 Title 1 US Code Sec. 204
-0519	US Congressional Record March 17 1993 Traficant EBA 1933 Bankruptcy	11:31 PM · Jun 16, 2022 https://twitter.com/DarBenThu1/status/1537684322865455104	Gotta know this: United-States-Congressional-Record -:March 17, 1993 Vol. 33, page H-1303 U.S. -Representative -:Traficant :Ohio, The -:Bankruptcy of The United-States -- 30- years-ago Yeah, the -:bankruptcy is with the over-due-payable to the Ohio-State-Country-Man-Settlors -now.	https://twitter.com/DarBenThu1/status/1536981590605066240/photo/2 https://twitter.com/DarBenThu1/status/1536981590605066240/photo/2 https://twitter.com/DarBenThu1/status/1536981590605066240/photo/2 https://twitter.com/DarBenThu1/status/1536981590605066240/photo/2
-0520	General Milley Nacissist	10:45 AM · Jun 17, 2022 https://twitter.com/DarBenThu1/status/	#GenMilley #StateCountryManSettlor #Grantor #Executor #GrantorExecutor #OhioStateCountryManSettlor #Ohioan #EBA1933AD #COVTrust #NewMexican #NewMexicoStateManSettlor #DOI1776AD	https://youtu.be/DzccQ3I-1Ywg https://youtu.be/DzccQ3I-1Ywg?t=1

:Mark	:Matter	:Location	:Claim	:Facts	139 / 199
-------	---------	-----------	--------	--------	-----------

11/12

		1537853847997018112	#USofA1776People WHY THE NARCISSIST IS JEALOUS OF YOU https://youtube.com/c/NARCDAILYYou	
~0521	Ohio POLice Racial Discrimination	9:49 PM · Jun 17, 2022 https://twitter.com/DarBenThu1/status/1538021102516965382	Ohio Police Lieutenant Awarded a \$2 Settlement in Racial Discrimination Case https://ebony.com/news/ohio-police-lieutenant-awarded-a-2-settlement-in-racial-discrimination-case/ via @ebonymag	https://www.ebony.com/news/ohio-police-lieutenant-awarded-a-2-settlement-in-racial-discrimination-case/
~0522	Shabbat Ysrael Captivity KJV Hosea Jeremiah	2:42 PM · Jun 18, 2022 https://twitter.com/DarBenThu1/status/1538275998528966656	:2022 June 18, -:Shabbat To The Hidden -Ysrael in the Captivity. Shalom :KJV-Book: Hosea -Chap-1&2 is this -:now-time. :KJV-Book: Jeremiah -Chap-30&31 is with the now-time-[re]-storation of His people from the North-country, far-isles, and elsewhere-scattered by the written-word.	https://www.ebony.com/news/ohio-police-lieutenant-awarded-a-2-settlement-in-racial-discrimination-case/
~0523	KJV Proverbs	12:05 PM · Jun 19, 2022 https://twitter.com/DarBenThu1/status/1538598823748022274	#KJV - #Proverbs19 #USA1776ADStateGrantor #DOI1776AD - #DOI1766ADCovenantLaw #StateCountryManBeneficiarySovereignSettlorDOI1776ADGr antoDOI1776AD with the becoming of the maturity and emancipation. #SettlorGrantor is liable to the duty of the #DOI1776ADSOvereignFidelityObligation	https://twitter.com/DarBenThu1/status/1538598823748022274/photo/1 https://twitter.com/DarBenThu1/status/1538598823748022274/photo/2 KJV -Proverbs 19
~0524	Paris Peack Treaty September 1783 ARW 1775 1783	6:50 PM · Jun 19, 2022 https://twitter.com/DarBenThu1/status/1538700886880292864	Paris Peace Treaty of September 30, 1783 #ParisPeaceTreaty1783AD #ParisPeaceTreaty1782AD End of the American Revolutionary War ~April 19, 1775 – September 3, 1783~ #AWR1775ADn1783AD	https://twitter.com/DarBenThu1/status/1538700886880292864/photo/1 https://twitter.com/DarBenThu1/status/1538700886880292864/photo/2 https://twitter.com/DarBenThu1/status/1538700886880292864

:Mark	:Matter	:Location	:Claim	:Facts	140 / 199
-------	---------	-----------	--------	--------	-----------



JHR

				<p align="center">1538700886880292864/photo/3 https://twitter.com/DarBenThu1/status/1538700886880292864/photo/4 Paris Peace Treaty of September 30, 1783: ending of the ARW-1775-1783-AD</p>
~0525	Articles of Peace November 1782 September 1783	<p>7:00 PM · Jun 19, 2022 https://twitter.com/DarBenThu1/status/1538703218565230592</p>	<p>Preliminary Articles of Peace; November 30, 1782 #ParisPeaceTreaty1782AD #ParisPeaceTreaty1783AD End of the American Revolutionary War ~April 19, 1775 – September 3, 1783~ #AWR1775ADn1783AD</p>	<p>https://twitter.com/DarBenThu1/status/1538703218565230592/photo/1 https://twitter.com/DarBenThu1/status/1538703218565230592/photo/2 https://twitter.com/DarBenThu1/status/1538703218565230592/photo/3 https://twitter.com/DarBenThu1/status/1538703218565230592/photo/4 Preliminary Articles of Peace; November 30, 1782</p>
~0526	DOI July 1776	<p>7:19 PM · Jun 19, 2022 https://twitter.com/DarBenThu1/status/1538707972716539905</p>	<p>Declaration of Independence, July 4, 1776 #DOI1776AD #StateCountryMan #Ohioan #NewMexican #StateCountryManBeneficiary #StateCountryManSettlor #GenMilleyOn #JCOS #StateCountryManSettlorGrantor #EBA1933AD #StateCountryManBeneficiarySovereignSettlorGrantorExecut</p>	<p>https://twitter.com/DarBenThu1/status/1538707972716539905/photo/1 https://twitter.com/DarBenThu1/status/1538707972716539905/photo/2</p>

:Mark	:Matter	:Location	:Claim	:Facts	141 / 199
-------	---------	-----------	--------	--------	-----------



Handwritten initials: GJC

			or	https://twitter.com/DarBenThu1/status/1538707972716539905/photo/3 https://twitter.com/DarBenThu1/status/1538707972716539905/photo/4 Declaration of Independence, July 4, 1776
~0527	AOC 1781	7:42 PM · Jun 19, 2022 https://twitter.com/DarBenThu1/status/1538713831781937152	:Articles-of-Confederation :March 1, 1781 #AOC1781AD #DOI1776AD #CftUSA1787AD #Ohioan #StateCountryManBeneficiarySovereignSettlor is with the baby-birth of the baby-man-kind onto the land of the #OhioStateCountry by the #ManAndAlmightyGodCovenantDOI1776AD	https://twitter.com/DarBenThu1/status/1538713831781937152/photo/1 https://twitter.com/DarBenThu1/status/1538713831781937152/photo/2 https://twitter.com/DarBenThu1/status/1538713831781937152/photo/3 https://twitter.com/DarBenThu1/status/1538713831781937152/photo/4 :Articles-of-Confederation :March 1, 1781
~0528	BOR 1789 CftUSofA 1787	7:57 PM · Jun 19, 2022 https://twitter.com/DarBenThu1/status/1538717579685945344	The -:Bill-of-Rights of the #Ohioan #NewMexican #StateCountryManBeneficiarySovereignSettlorAndGrantor to the #DerivedSovereignAuthority of the Constitution for the United-States-of-America-1787-AD #CftUSofA1787AD #OhioStateCountryMan #NewMexicoStateCountryMan	https://twitter.com/DarBenThu1/status/1538717579685945344/photo/1 :Bill-of-Rights
~0529	Beneficiary Trustee Ohioan Loring	4:56 PM · Jun 20, 2022	What is a Beneficiary? What is a Trustee? What is a Trust? Example: Ohioan- Darrell-James # 1of2 A trustee's	https://ia800206.us.archive.org/7/items/cu31924018769202/cu31924018769202.pdf

:Mark	:Matter	:Location	:Claim	:Facts	142 / 199
-------	---------	-----------	--------	--------	-----------



Handwritten initials: HJC

	Augustus Peabody 1898	https://twitter.com/DarBenThu1/status/1539034490600759296	handbook by Loring, Augustus Peabody, 1856-1938 a) Publication date: 1898 ed. - https://ia800206.us.archive.org/7/items/cu3192	https://twitter.com/DarBenThu1/status/1539034490600759296/photo/1 https://twitter.com/DarBenThu1/status/1539034490600759296/photo/2 What is a Beneficiary? What is a Trustee? What is a Trust?
~0530	Beneficiary Trustee Ohioan Loring Augustus Peabody 1900	4:58 PM · Jun 20, 2022 https://twitter.com/DarBenThu1/status/1539035098376380416	What is a Beneficiary? What is a Trustee? What is a Trust? Example: Ohioan- Darrell-James # 2 of 2 b) Publication date: 1900 ed. - https://ia802605.us.archive.org/29/items/atrusteeshand00loriiala/atrusteeshand00loriiala.pdf c) Publication date: 1907 ed. - https://ia803406.us.archive.org/9/items/truste	https://ia802605.us.archive.org/29/items/atrusteeshand00loriiala/atrusteeshand00loriiala.pdf https://ia803406.us.archive.org/9/items/trusteeshandbook00loriiala/trusteeshandbook00loriiala.pdf https://twitter.com/DarBenThu1/status/1539035098376380416/photo/1 https://twitter.com/DarBenThu1/status/1539035098376380416/photo/2 What is a Beneficiary? What is a Trustee? What is a Trust?
~0531	Sig Spear Service Rifle	5:18 PM · Jun 20, 2022 https://twitter.com/DarBenThu1/status/1539039994769461248	The US Army's new Service Rifle - The SIG SPEAR / NGSW XM5 by :GarandThumb https://youtube.com/watch?v=GEf3ZI	https://www.youtube.com/watch?v=GEf3ZI 5:23 PM · May 27, 2022 https://twitter.com/DarBenThu1/status/

:Mark	:Matter	:Location	:Claim	:Facts	143 / 199
-------	---------	-----------	--------	--------	-----------



				<p><u>1530344045616037888</u></p> <p>:B.A.R- Attorney NOT-Lawful-Legal-permitted to work for the Government for the United-States of America #GFTUSA1787AD?</p> <p>Ans: It is: a) Not-Authorized by the #CftUSofA1787AD; & 2) Not-Authorized by the #Original13thAmendment.</p>
~0532	Set Truth	<p>5:20 PM · Jun 21, 2022</p> <p>https://twitter.com/DarBenThu1/status/1539402859141222401</p>	<p>Set-Truth ~setting of the truth~-Experiment: All Ages. Need:</p> <p>1- State-Country-*Man-Settler, Grantor or Grantor-Executor</p> <p>2- A -:Mirror ~can be quantum or spiritual- level~. [Ex. Parents are the mirrors.]</p> <p>3- The -:Check-Program-Statement ~see attached~. [*Man= All of the time]</p>	<p>https://twitter.com/DarBenThu1/status/1539402859141222401/photo/1</p> <p>Set-Truth ~setting of the truth~-Experiment: All Ages.</p>
~0533	NFA 1934 Treason General Milley DOI 1776	<p>1:41 AM · Jun 22, 2022</p> <p>https://twitter.com/DarBenThu1/status/1539528941362245632</p>	<p>See: #NFA1934AD attached pp. 1-4. #GenMilley :i -man- #Ohioan : #DOI1776AD -duty am with this notice of the DOI-1776-A.D. et al. et seq.- #treason , fraud and harm upon the #USofA1776AD - #DOI1776AD -people WITH THE NFA-1934-A.D. by the law of the DOI-1776-A.D. et al. et seq.</p>	<p>https://twitter.com/DarBenThu1/status/1539528941362245632/photo/1</p> <p>https://twitter.com/DarBenThu1/status/1539528941362245632/photo/2</p> <p>https://twitter.com/DarBenThu1/status/1539528941362245632/photo/3</p> <p>https://twitter.com/DarBenThu1/status/1539528941362245632/photo/4</p>

:Mark	:Matter	:Location	:Claim	:Facts	144 / 199
-------	---------	-----------	--------	--------	-----------



Handwritten signature and scribbles

				1539528941362245632/photo/4 National-Firearms-Act-1934-AD
-0534	General Milley Teason Damage Overdose Fauci Obama Gates CCP	<u>2:00 AM · Jun 22, 2022</u> https://twitter.com/DarBenThu1/status/1539533882055225345	2022 JUNE 22 #GenMilley :Treason and Damage US COVID-19 cases and deaths by state/ Fauciobgccp? https://usafacts.org/visualizations/coronavirus-covid-19-spread-map/ Drug Overdose Deaths Remain High ? https://cdc.gov/drugoverdose/deaths/index.html missing persons BY STATE ? https://worldpopulationreview.com/state-rankings/missing-persons-by-state GUN VIOLENCE BY STATE ? https://worldpopulationreview.com/state-rankings	https://usafacts.org/visualizations/coronavirus-covid-19-spread-map/ https://www.cdc.gov/drugoverdose/deaths/index.html https://worldpopulationreview.com/state-rankings/missing-persons-by-state https://worldpopulationreview.com/state-rankings/gun-deaths-per-capita-by-state
-0535	KJV Ps 146 Praise Ye the Lord	<u>12:13 PM · Jun 22, 2022</u> https://twitter.com/DarBenThu1/status/1539688043606441985	2022 JUNE 22 KJV PS 146 PRAISE YE THE LORD This -:KJV -Holy-Bible -Book: PS- Chap- 146 is within the keeping of the what-the-Father-wants-you-to-know. Selah. Shalom.	<u>5:20 PM · Jun 21, 2022</u> https://twitter.com/DarBenThu1/status/1539402859141222401 Set-Truth ~setting of the truth--Experiment: All Ages. https://twitter.com/DarBenThu1/status/

:Mark	:Matter	:Location	:Claim	:Facts	145 / 199
-------	---------	-----------	--------	--------	-----------



Handwritten signature/initials

				1539688043606441985/photo/1 KJV- Psalms 146
-0536	Covid- 19 Brain	3:16 PM · Jun 22, 2022 https://twitter.com/DarBenThu1/status/1539734122112765953	#Ohioan #StateCountryManBeneficiarySettlor #StateCountryManBeneficiarySettlorGrantor #StateCountryManBeneficiaryGrantorExecutor #NationalGuard #OhioNationalGuard #ArizonaNationalGuard #Arizonan #Slvm Here's what we know about COVID-19's impact on the brain https://youtube.com/watch?v=7RjltC	https://www.youtube.com/watch?v=7RjltCm_YpU Covid-Impact on the Brain 2:00 AM · Jun 22, 2022 https://twitter.com/DarBenThu1/status/1539533882055225345 :Treason and Damage US COVID-19 casesand deaths by state/ Fauciobgccp?
-0537	Genetive Case Lack of the Genetive Trustee-Dereliction	5:17 PM · Jun 22, 2022 https://twitter.com/DarBenThu1/status/1539764642267820032	Nordquist, Richard. "What Is the Genetive Case?" ThoughtCo, Aug. 27, 2020, http://thoughtco.com/genetive-grammatical-case-1690887 . ~:last: 2022 June 22, https://thoughtco.com/genetive-grammatical-case-1690887 ~. :i- man and other-Ohioans are with the lack of the #GenetiveCase -education in the English by the #EBA1933AD -Trustee-Dereliction.	2:33 PM · May 21, 2022 https://twitter.com/DarBenThu1/status/1528126849200844800 https://twitter.com/DarBenThu1/status/1539764642267820032/photo/1 https://twitter.com/DarBenThu1/status/1539764642267820032/photo/2 https://twitter.com/DarBenThu1/status/1539764642267820032/photo/3

:Mark	:Matter	:Location	:Claim	:Facts	146 / 199
-------	---------	-----------	--------	--------	-----------



gjh

				20 June 22 What is the Genitive Case
~0538	KJV Psalms 19	3:09 AM · Jun 23, 2022 https://twitter.com/DarBenThu1/status/1539913633274048512	2022 JUNE 23 KJV PS Chap. 19 THERE IS SOOO MUCH IN THIS SHORT CHAPTER! A Psalm of David. .. 12. Who can understand his errors? Cleanse Thou me from secret faults. 13. Keep back Thy servant also from presumptuous sins: Let them not have dominion over me: then shall I be upright,	https://twitter.com/DarBenThu1/status/1539913633274048512/photo/1 https://twitter.com/DarBenThu1/status/1539913633274048512/photo/2 KJV- Psalms 19
~0539	State Country Man Beneficiary Sovereign Settlor Grantor Ohioan	11:37 AM · Jun 23, 2022 https://twitter.com/DarBenThu1/status/1540041407435403265	2022 JUNE 23 How is that -every-man-Ohio-Birth-Born-Settlor: DOI-1776-A.D. is Mis-e-du-ca-t-ed? Ans. by the curse process: planning, writing, and revising changes with the nonrestrictive appositives along with nonrestrictive clauses and phrases. See explanation attached-here Ans: Mal-feasance by the Trustee-Derelict.	https://twitter.com/DarBenThu1/status/1540041407435403265/photo/2 How is that -every-man-Ohio-Birth-Born-Settlor: DOI-1776-A.D. is Mis-e-du-ca-t-ed?
~0540	Five-Core Elements Jurisdiction	2:47 AM · Jun 24, 2022 https://twitter.com/DarBenThu1/status/1540270378387271680	2022 JUNE 24 :Five-Core Elements of the Jurisdiction in your Statements Practice these Five-Core -Elements. :Jurisdiction in your Statements is by Your-doing. Remember: The -:Law in the Court is by the law of the Contract.	https://twitter.com/DarBenThu1/status/1540270378387271680/photo/1 Five-Core -Elements. :Jurisdiction is in your Statements by Your doing.

:Mark	:Matter	:Location	:Claim	:Facts	147 / 199
-------	---------	-----------	--------	--------	-----------



Handwritten initials: JPH

:Two-Year-Review :Dar-Ben-Thu: Hill ~www.twitter.com/DarBenThu1~ -Authority
https://twitter.com/hashtag/darbenthu1September222020?src=hashtag_click
:DarBenThu1 -Box-Graph: #September2020AD > #August2022AD

0541	KJV John Chap 16	6:16 AM · Jun 25, 2022 https://twitter.com/DarBenThu1/status/1540685238426161152	KJV- John-Chap 16 33 These things I have spoken unto you, that in me ye might have peace. In the world ye shall have tribulation: but be of good cheer; I have overcome the world. #Ohio #Ohioan #Ysrael #Yacob #StateCountryManSettlorGrantor #StateCountryManSettlorGrantor #GenMilley	https://twitter.com/DarBenThu1/status/1540685238426161152/photo/2 https://twitter.com/DarBenThu1/status/1540685238426161152/photo/3 https://twitter.com/DarBenThu1/status/1540685238426161152/photo/4 KJV- John 16
~0542	KJV 2 Corinthians 4	10:42 AM · Jun 25, 2022 https://twitter.com/DarBenThu1/status/1540752337118953478	2022 JUNE 25 KJV- II Corinthians- Chap 4 3 [I]f our gospel be hid, it is hid to them that are lost: 4 In whom the god of this world hath blinded the minds of them which believe not, lest the light of the glorious gospel of Christ, who is the image of God, should shine unto them.	https://twitter.com/DarBenThu1/status/1540752337118953478/photo/1 https://twitter.com/DarBenThu1/status/1540752337118953478/photo/2 https://twitter.com/DarBenThu1/status/1540752337118953478/photo/3 https://twitter.com/DarBenThu1/status/1540752337118953478/photo/4 II Corinthians 4
~0543	KJV proverbs 26 27 28	9:42 AM · Jun 27, 2022 https://twitter.com/DarBenThu1/status/1541462054959099904	2022 JUNE 27 KJV- PROVERBS CHAP 26-27-28 Proverbs- Chap 26 4 Answer not a fool according to his folly, Lest thou also be like unto him. 5 Answer a fool according to his folly, Lest he be wise in his own conceit. #Ohioan #NewMexican #StateCountryManSettlorGrantor #GrantorExecutor	https://twitter.com/DarBenThu1/status/1541462054959099904/photo/1 https://twitter.com/DarBenThu1/status/1541462054959099904/photo/2 https://twitter.com/DarBenThu1/status/1541462054959099904/photo/3

:Mark	:Matter	:Location	:Claim	:Facts	148 / 199
-------	---------	-----------	--------	--------	-----------



DeHe

				<p align="center">1541462054959099904/photo/3 https://twitter.com/DarBenThu1/status/1541462054959099904/photo/4 KJV- Proverbs Chaps 26 27 28</p>
-0544	KJV Exekiel 14	<p>7:16 PM · Jun 27, 2022 https://twitter.com/DarBenThu1/status/1541606490930180096</p>	<p>2020 JUN 27 KJV – Ezekiel Chap 14 for soul-journeymers - :Soul-Goal: See the man-self after about 6000 years. This is for the no-lack of the knowledge. ~a) did you know? b) :this is us today.~ :Steps. Read the storyline: a) did you know? then b) this is us today, and ~See:sheet~</p>	<p>https://twitter.com/DarBenThu1/status/1541606490930180096/photo/1 https://twitter.com/DarBenThu1/status/1541606490930180096/photo/2 KJV- Ezekiel 14 https://twitter.com/DarBenThu1/status/1541606490930180096/photo/3 Steps for Soul-journeymers</p>
-0545	Public Charitable Trust Federal Reserve Act 1913 1933 Dust Bowl Depression	<p>11:37 PM · Jun 27, 2022 https://twitter.com/DarBenThu1/status/1541672213799006208</p>	<p>2022 JUNE 27 The Public Charitable Trust With the FRA-1913-A.D. and 1933 A.D.-Dust Bowl and Economic-Depression is how the Millions of the out of work-American: DOI-1776-A.D. were-ushered into the dependent -ward-status of the Territorial Districts-states as United-States-citizens</p>	<p>https://twitter.com/DarBenThu1/status/1541672213799006208/photo/1 Ring a Hegelian-Dialectic- bell? C-19?</p>
-0546	Parens patriae Legal Guardian	<p>3:40 AM · May 26, 2022 https://twitter.com/DarBenThu1/status/</p>	<p>Parens- patriae Legal definition of parens patriae ~webster dict on line~ : the state in its capacity as the legal guardian of persons not sui juris</p>	<p>3:40 AM · May 26, 2022 https://twitter.com/DarBenThu1/status/</p>

:Mark	:Matter	:Location	:Claim	:Facts	149 / 199
-------	---------	-----------	--------	--------	-----------



Handwritten initials: RFB

		1529774465780809728		1529774465780809728 https://twitter.com/DarBenThu1/status/1529774465780809728/photo/1 the state in its capacity as the legal guardian of persons not sui juris
-0547	Craigslist Social Media Dayton Ohio Cleveland Akron Canton	7:55 AM · Jun 29, 2022 https://twitter.com/DarBenThu1/status/1542159707389022208	View your post at http://dayton.craigslist.org/zip/d/gold-canyon-ohioan-executor-doi-1776-ad/7502532664.html View your post at http://akroncanton.craigslist.org/zip/d/gold-canyon-ohioan-executor-doi-1776-ad/7502523874.html View your post at http://cleveland.craigslist.org/zip/d/gold-can	https://twitter.com/DarBenThu1/status/1542159707389022208/photo/1 https://twitter.com/DarBenThu1/status/1542159707389022208/photo/2 https://twitter.com/DarBenThu1/status/1542159707389022208/photo/3 The Post has been flagged for removal.
-0548	Kevin Zadai Narcissism	10:13 AM · Jun 29, 2022 https://twitter.com/DarBenThu1/status/1542194597484298241	2022 June 29 16:07 https://youtube.com/watch?v=mJOb3fFpHY8 Discerning and breaking the spirit of narcissism The spirit of narcissism uses manipulation for the control and victimization of others. How Dr. Kevin Zadai discerns and breaks narcissisms. #StateCountryManBeneficiarySettlors #Ohio SLVM	https://youtu.be/mJOb3fFpHY8 Discerning and Breaking the Spirit of Narcissism
-0549	Craigslist Social Media	9:37 AM · Jun 29, 2022 https://twitter.com/DarBenThu1/status/	:notice, :See :Ohioan-Executor: DOI-1776-AD for -:Ohioans, Ysrael and Holy-Church; :DOI-1776-AD- Covenant - Notice, :Arizona- :CRAIGSLIST. :i- man ~Adam~ -Executor of the PE-2022-AD -PE-2016-AD -DOI-1776-AD ~ PE-2022-AD- -Covenant -Authority is with this tangible -lawful -notice.	https://twitter.com/DarBenThu1/status/1542185571228889088/photo/2 Lawful- Public-Claim with the tangible-lawful-notice

:Mark	:Matter	:Location	:Claim	:Facts	150 / 199
-------	---------	-----------	--------	--------	-----------

J
2022

		1542185571228889088		
-0550	Craigslist Soical Media Phoenix Gold Canyon Tucson Flagstaff Prescott	12:53 PM · Jun 29, 2022 https://twitter.com/DarBenThu1/status/1542234831488024576	View your post at http://phoenix.craigslist.org/evl/zip/d/gold-canyon-notice-see-ohioan-executor/7502694797.html View your post at http://tucson.craigslist.org/zip/d/gold-canyon-notice-see-ohioan-executor/7502696199.html View your post at http://flagstaff.craigslist.org/zip/d/gold-canyon-notice-see-ohioan-executor/7502697118.html View your post at http://prescott.craigslist.org/zip/d/gold-can	https://twitter.com/DarBenThu1/status/1542234831488024576/photo/1 https://twitter.com/DarBenThu1/status/1542234831488024576/photo/2 https://twitter.com/DarBenThu1/status/1542234831488024576/photo/3 https://twitter.com/DarBenThu1/status/1542234831488024576/photo/4 https://twitter.com/DarBenThu1/status/1542185571228889088/photo/2 Lawful- Public-Claim with the tangble-lawful-notice
-0551	Craigslist	6:57 PM · Jun 28, 2022 https://twitter.com/DarBenThu1/status/1541963964950556672	2022 June 28 #CraigsList – #Ohio, Ysrael and Holy-Church :notice: to the #OhioanPeople ...[.] #StateCountryManBeneficiarySovereignSettlors and #Grantors , #Ysrael & #HolyChurch #COGIC #Akron #Cleveland #Dayton #Mansfield #Chillicothe #Columbus #Lima #Toledo #Youngstown #Zanesville	https://twitter.com/DarBenThu1/status/1541963964950556672/photo/1 Public-Claim as with the Public-Law 94-583 - Claim of the political-election to the people by the Ohioan-Kinsman-Redeemer
-0552	Craigslist	7:55 AM · Jun 29, 2022	View your post at	https://twitter.com/DarBenThu1/status/

:Mark	:Matter	:Location	:Claim	:Facts	151 / 199
-------	---------	-----------	--------	--------	-----------

2022-011769 MISC Page: 2734 of 2782
 09/26/2022 03:35:37 PM Receipt #: 22-9381
 Rec Fee: \$30.00 Darrell James Hill
 Gila County, Az, Sadie Jo Bingham, Recorder

CEM

	Dayton Akron Canton Cleveland	https://twitter.com/DarBenThu1/status/1542159707389022208	http://dayton.craigslist.org/zip/d/gold-canyon-ohioan-executor-doi-1776-ad/7502532664.html View your post at http://akroncanton.craigslist.org/zip/d/gold-canyon-ohioan-executor-doi-1776-ad/7502523874.html View your post at http://cleveland.craigslist.org/zip/d/gold-can	1542159707389022208/photo/1 https://twitter.com/DarBenThu1/status/1542159707389022208/photo/2 https://twitter.com/DarBenThu1/status/1542159707389022208/photo/3 Lawful- Public-Claim with the tangle-lawful-notice
-0553	Craigslist	2:47 AM · Jun 30, 2022 https://twitter.com/DarBenThu1/status/1542444793245990913	#Phoenix #Tucson #Flagstaff #Prescott #ArizonaStateCountryManSettlor #OhioNationalGuard See: https://twitter.com/DarBenThu1/status/1541963964950556672 #Dayton #Akron #Cleveland #Mansfield #OhioStateCountryManSettlor #ArizonaNationalGuard See: https://twitter.com/DarBenThu1/status/1542185571228889088 :2022-June-notices: Your: DOI-1776-AD -Rights	9:37 AM · Jun 29, 2022 https://twitter.com/DarBenThu1/status/1542185571228889088 https://twitter.com/DarBenThu1/status/1542444793245990913/photo/2 Notice of Public-tangible-right: DOI-1776-AD :OITNB- :Orange is the New Black
~0554	Orange Is The New Black OITNB	6:11 AM · Jun 28, 2022 https://twitter.com/Terrence_STR/status/1541771361248485377	Last night in Newport, RI. #newportri #rhodeisland Bulls on parade...	https://twitter.com/i/status/1541771361248485377
~0555	Salvage Authority	3:54 AM · Jun 30, 2022	2022 June 29 :notice- The -:Tangible-right: DOI-1776-AD -	https://twitter.com/DarBenThu1/status/

:Mark	:Matter	:Location	:Claim	:Facts	152 / 199
-------	---------	-----------	--------	--------	-----------



Handwritten note: here

:Two-Year-Review :Dar-Ben-Thu: Hill ~www.twitter.com/DarBenThu1~ -Authority
https://twitter.com/hashtag/darbenThu1September222020?src=hashtag_click
:DarBenThu1 -Box-Graph: #September2020AD > #August2022AD

	EBA 1933 Dead Trust Stand	https://twitter.com/DarBenThu1/status/1542461554070695937	Salvage- Authority over-standing the EBA-1933-AD -2003-AD -Dead- Trust #StateCountryManBeneficiarySovereignSettlorGrantors of the #Delaware #Hawaii #Maine #NewHampshire #Rhodelsland #Vermont & #Wyoming #StateCountryS STAND!	1542461554070695937/photo/1 Lawful-Notice to the State-Country-Man-Settlor-Grantors
-0556	DOI 1776 Rights	11:42 PM · Jun 30, 2022 https://twitter.com/DarBenThu1/status/1542760492615184386	#Delaware #Hawaii #Maine #NewHampshire #Rhodelsland #Vermont #Wyoming #DEArmyGuard #HawaiiArmyNationalGuard #MaineNationalGuard #NewHampshireNationalGuard #RhodelslandNationalGuard #VermontNationalGuard #WyomingNationalGuard #StateCountryS :2022-June-notices: DOI-1776-AD -Rights	https://twitter.com/DarBenThu1/status/1542760492615184386/photo/1 https://twitter.com/DarBenThu1/status/1542760492615184386/photo/2 Lawful-Notice to the State-Country-Man-Settlor-Grantors
:Era 2 #July2022DarBenThu1			:Era 2 #July2022DarBenThu1	
-0557	Salvage Right Knowledge	2:20 AM · Jul 1, 2022 https://twitter.com/DarBenThu1/status/1542800363694202881	2022 July 1 :DOI-1776-AD-1 Covenant -Notice, -:Executor -Notice: Salvage-Rights. #StateCountryManBeneficiarySovereignSettlorGrantors of the #Georgia #Albany #Atlanta #Augusta #Columbus #NorthWestGeorgia & #Savannah #GeorgiaArmyNationalGuard #Ohio :Truth- knowledge DarB@enThu1	https://twitter.com/DarBenThu1/status/1542800363694202881/photo/2 Lawful-Notice to the State-Country-Man-Settlor-Grantors
-0558	KJV Genesis 1	11:57 AM · Jul 1, 2022 https://twitter.com/DarBenThu1/status/1542945381595484160	2022 July 1 KJV- Genesis 1 Shock- Point: Read Chap 1 with much patience for our Spirits may be non-exercised. We have been taught and trained that our Spirit is weak; the -:greatest	https://twitter.com/DarBenThu1/status/1542945381595484160/photo/1 https://twitter.com/DarBenThu1/status/1542945381595484160

:Mark	:Matter	:Location	:Claim	:Facts	153 / 199
-------	---------	-----------	--------	--------	-----------



Handwritten signature/initials

		1542945381595484160	part of who you- soul- journeyer have always been is Not weak -> Say, :My god-Spirit is powerful.	1542945381595484160/photo/2 https://twitter.com/DarBenThu1/status/1542945381595484160/photo/3 https://twitter.com/DarBenThu1/status/1542945381595484160/photo/4 Genesis 1
-0559	KJV Deuteronomy 32 Genesis 1	12:41 PM · Jul 1, 2022 https://twitter.com/DarBenThu1/status/1542956673257459712	2022 July 1 KJV- Deuteronomy 32Genesis 1 Shock- Point 2/2 after :Genesis 1. What do you see? Ans. God's plan, and how we are now at this place. This is your heritage #USofA1776ADPeople - : #Ysrael - #NorthernAndSouthernKingdomsOfYsrael and #HolyChurch . See: Deuteronomy- Closure	11:57 AM · Jul 1, 2022 https://twitter.com/DarBenThu1/status/1542945381595484160 https://twitter.com/DarBenThu1/status/1542956673257459712/photo/1 https://twitter.com/DarBenThu1/status/1542956673257459712/photo/2 https://twitter.com/DarBenThu1/status/1542956673257459712/photo/3 https://twitter.com/DarBenThu1/status/1542956673257459712/photo/4 Deuteronomy 32

:Mark	:Matter	:Location	:Claim	:Facts	154 / 199
-------	---------	-----------	--------	--------	-----------



2426

:Two-Year-Review :Dar-Ben-Thu: Hill ~www.twitter.com/DarBenThu1~ -Authority
https://twitter.com/hashtag/darbenthu1September222020?src=hashtag_click
:DarBenThu1 -Box-Graph: #September2020AD > #August2022AD

~0560	KJV Genesis 1 Teacher Arnold Benjamin Murray	9:48 PM · Jul 1, 2022 https://twitter.com/DarBenThu1/status/1543094360215920640	2022 July 1 Teacher- Arnold Benjamin Murray (April 20, 1929 – February 12, 2014). KJV- Genesis 1 ~intro: Genesis 1:1 - 1:2~ https://youtube.com/playlist?list=	https://www.youtube.com/playlist?list=PLGk636nvuNgQDIQIzFvX8S8bDAHmcRpLs
~0561	Winans The-Question Is	12:25 PM · Jul 2, 2022 https://twitter.com/DarBenThu1/status/1543315030296313856	The Winans Question Is 2005-AD Music https://youtube.com/watch?v=XTGaZX	https://www.youtube.com/watch?v=XTGaZXsRgvo https://twitter.com/DarBenThu1/status/1543315030296313856/photo/1 Question Is
~0562	DOI 1776 Never-done Leviticus 26 Haggai House of Yudah	8:43 AM · Jul 4, 2022	The -: #DOI1776AD was :Never-ealized ini -:1776-AD. Why? Ans. :Your fore-Fathers ~Northern-Kingdom~ loved the money, perversion and committed the open fraud upon the Negro -:House-of-Judah -:Children-of-Ysrael. Yep! See Leviticus 26:40 -> recovery. See: Haggai for Shalom ~peace~.	10:08 AM · Jul 4, 2022 https://twitter.com/DarBenThu1/status/1544005295327760384 https://twitter.com/DarBenThu1/status/1543983877739360256/photo/1 https://twitter.com/DarBenThu1/status/1543983877739360256/photo/2 https://twitter.com/DarBenThu1/status/1543983877739360256/photo/3

:Mark	:Matter	:Location	:Claim	:Facts
-------	---------	-----------	--------	--------



Handwritten signature/initials

				https://twitter.com/DarBenThu1/status/1543983877739360256/photo/4 KJV -Book -Haggai
~0563	USofA People 1776 Co-Intel-pro	10:08 AM · Jul 4, 2022 https://twitter.com/DarBenThu1/status/1544005295327760384	We the -:USofA-People-1776 AD -soul-journeymers are not with the drowning for the falling in the river but by the staying submerged. :Co-intel-pro: ~ https://en.wikipedia.org/wiki/COINTELPRO ~ 600- BC -> now-time is by the Fact! https://youtube.com/watch?v=vwua24SV4lw&list=PLiVuNdN0luyoCmZVtP9Hgtxj5ATwOqkKJ&index=1 Fear Is Not My Future :brandon + chandler.	https://en.wikipedia.org/wiki/COINTELPRO https://www.youtube.com/watch?v=vwua24SV4lw&list=PLiVuNdN0luyoCmZVtP9Hgtxj5ATwOqkKJ&index=2 https://youtu.be/vwua24SV4lw?list=PLiVuNdN0luyoCmZVtP9Hgtxj5ATwOqkKJ&t=1 Fear Is Not My Future
~0564	Kathryn Kuhlman KJV Proverbs 23	5:05 PM · Jul 4, 2022 https://twitter.com/DarBenThu1/status/1544110204475740160	How our mental attitude defines our life!!! Audio message by Kathryn Kuhlman. https://youtube.com/watch?v=m6B832UFL_U How can we become power of God on the inside? Ans. KJV- Proverbs Chap 23 .. 7 For as he thinketh in his heart, so is he. ~The -:Attitude and Value- effect upon -:me is by -me.-	https://www.youtube.com/watch?v=m6B832UFL_U

:Mark	:Matter	:Location	:Claim	:Facts	156 / 199
-------	---------	-----------	--------	--------	-----------



SRK

:Two-Year-Review :Dar-Ben-Thu: Hill ~www.twitter.com/DarBenThu1~ -Authority
https://twitter.com/hashtag/darbenthu1September222020?src=hashtag_click
:DarBenThu1 -Box-Graph: #September2020AD > #August2022AD

-0565	KJV Proverbs 2	<p>3:26 AM · Jul 4, 2022</p> <p>https://twitter.com/DarBenThu1/status/1543904107278110720</p>	<p>KJV- Proverbs Chap 2 ~10 When wisdom entereth into thine heart, And knowledge is pleasant to thy soul; 11 Discretion shall preserve thee, Understanding shall keep thee: ... Chap 3 ~5 Trust in the LORD with all thine heart; And lean not unto thine own understanding. 6 In all thy</p>	<p>6:13 AM · Jul 5, 2022</p> <p>https://twitter.com/DarBenThu1/status/1544308521742675968</p> <p>https://twitter.com/DarBenThu1/status/1543904107278110720/photo/2</p> <p>https://twitter.com/DarBenThu1/status/1543904107278110720/photo/3</p> <p>https://twitter.com/DarBenThu1/status/1543904107278110720/photo/4</p> <p>KJV-Proverbs Chaps 2 , 3</p>
-0566	KJV Proverbs -All books Arnold Murray ~ :born – 1929, gone 2014~	<p>6:13 AM · Jul 5, 2022</p> <p>https://twitter.com/DarBenThu1/status/1544308521742675968</p>	<p>Proverbs :Word/ word, Line/ line, precept/ precept with Arnold Murray (pastor) (1929–2014). Reading and showing the KJV-Book of Proverbs https://youtube.com/watch?v=GSqaK3GSmuM&list=PL4L1hz0VIV7PVQ2AEe3BP9jaYV77c7Llv ~:YHVH Savior - :YouTube~</p>	<p>https://www.youtube.com/watch?v=GSqaK3GSmuM&list=PL4L1hz0VIV7PVQ2AEe3BP9jaYV77c7Llv</p> <p>KJV-Book-Proverbs: Pastor Arnold Murray</p>
~0567	Proverbs 5, 6, 7 Pastor Arnold Murray	<p>7:00 AM · Jul 5, 2022</p> <p>https://twitter.com/DarBenThu1/status/1544320277768806406</p>	<p>2022 JULY 5 PROVERBS 5, 6, & 7 word > line > precept - read by Pastor Arnold Murray</p> <p>5 - https://www.youtube.com/watch?v=kyfFkgt7Hys&list=PL4L1hz0VIV7PVQ2AEe3BP9jaYV77c7Llv&index=5</p> <p>6 - https://www.youtube.com/watch?v=MN5dB8xkDcs&list=PL4L1hz0VIV7PVQ2AEe3BP9jaYV77c</p>	<p>https://twitter.com/DarBenThu1/status/1544320277768806406/photo/1</p> <p>https://pbs.twimg.com/media/FW6GIUkXwAU1aQF?format=jpg&name=4096x4096</p> <p>https://pbs.twimg.com/media/FW6Gm0nXwAA-rSC?format=jpg&name=4096x4096</p>

:Mark	:Matter	:Location	:Claim	:Facts
-------	---------	-----------	--------	--------

beta

			<p>7Lv&index=6</p> <p>7 - https://www.youtube.com/watch?v=jcYVU3vhU_U&list=PL4L1hz0VIV7PVQ2AEe3BP9jaYV77c7Lv&index=7</p>	<p>https://pbs.twimg.com/media/FW6Gp9gWIAYcrEh?format=jpg&name=4096x4096</p> <p>https://pbs.twimg.com/media/FW6GtKLXoAMMCAD?format=jpg&name=4096x4096</p>
~0568	Satan relies on your power to kill steal and destroy you	<p>3:42 PM · Jul 5, 2022</p> <p>https://twitter.com/DarBenThu1/status/1544451654128308224</p>	<p>2022 JULY 5 To WhoSoEver will [Con-]template, a -:tool. We are god-man-kind, an infinite-creation- made by the All-mighty-God-Creator. :We watched the -:Earths-creation. [Satan sees and hates yourgod-man- power & being-kind as like the Almighty-God, without [ex-]ception!!] Shalom</p>	<p>https://twitter.com/DarBenThu1/status/1544320277768806406/photo/1</p> <p align="center">WhoSoEver will</p>
~0569	<p>Covenantors of the DOI-1776-AD is : Almighty-God-Yushuah and USofA-1776-AD -People</p> <p>Strong's Concordance</p>	<p>5:16 PM · Jul 5, 2022</p> <p>https://twitter.com/DarBenThu1/status/1544475269733367809</p>	<p>For the Study of the #USofA1776ADPeople & #AlmightyGod -: #Covenantors of the #DOI1776ADLaw is with the help of the:</p> <p>1/2) Strongs' Exhaustive Concordance: KJV- Bible:: English: canon-books, :complete, :James, 1822-1894 DL pdf- https://ia600502.us.archive.org/16/items/exhaustiveconcor1890stro/exhaustiveconcor1890stro.pdf and</p> <p>2/2) The Companion Bible</p>	<p>https://ia600502.us.archive.org/16/items/exhaustiveconcor1890stro/exhaustiveconcor1890stro.pdf</p> <p>https://twitter.com/DarBenThu1/status/1544320277768806406/photo/1</p> <p>https://pbs.twimg.com/media/FW8T5JRUCAAZCX9?format=jpg&name=4096x4096</p> <p>https://pbs.twimg.com/media/FW8T8VhUsAEb4b1?format=jpg&name=4096x4096</p>

:Mark	:Matter	:Location	:Claim	:Facts	158 / 199
-------	---------	-----------	--------	--------	-----------



Handwritten signature/initials

				DOI-1776-AD- Law-STUDY-Book: Strong's Concordance
~0570	USofA1776ADPeople Almighty-God Covenantors DOI-1776-AD- Law Bullinger Strong's	5:19 PM · Jul 5, 2022 https://twitter.com/DarBenThu1/status/1544476035130875904	For the Study of the #USofA1776ADPeople & #AlmightyGod -:#Covenantors of the #DOI1776ADLaw is with the help of the: 2/2) E. W. Bullinger The Companion Bible Enlarged Type Edition DL.pdf - https://ia601806.us.archive.org/33/items/e.-w.-bullinger-the-companion-bible-enlarged-type-edition-pdf-roflicopter-2110/E.%20W.%20Bullinger%20-%20The%20Companion%20Bible%20-%20Enlarged%20Type%20Edition%20%28pdf%29%20-%20roflicopter2110.pdf and 1/2) Strong's Exhaustive Concordance #StateCountryManSovereigns	5:16 PM · Jul 5, 2022 https://twitter.com/DarBenThu1/status/1544475269733367809 https://twitter.com/DarBenThu1/status/1544320277768806406/photo/1 https://pbs.twimg.com/media/FW8Uu9IUJAALI32?format=jpg&name=4096x4096 https://pbs.twimg.com/media/FW8UwiOVUAAQbuU?format=jpg&name=4096x4096 DOI-1776-AD- Law-STUDY-Book: Bullinger- Companion Bible
~0571	KJV Roman 6 Derek Prince ~1915-2003~	6:48 AM · Jul 6, 2022 https://twitter.com/DarBenThu1/status/1544679792879882240	2022 July 6 KJV -Romans 6 Derek Prince ~14 August 1915 - 24 September 2003 ~ https://youtube.com/watch?v=XAUugL-qnC0 'If YOU know it then you can reckon it; if you can't reckon it then you can't experience it.' Servants Of Righteousness Part 14 Sunday Bible Study With Derek Romans. Reckon.	https://www.youtube.com/watch?v=XAUugL-qnC0 https://twitter.com/DarBenThu1/status/1544320277768806406/photo/1 https://pbs.twimg.com/media/FW_NqOBUEAA_kyU?

:Mark	:Matter	:Location	:Claim	:Facts	159 / 199
-------	---------	-----------	--------	--------	-----------



Handwritten initials: JPH

				<p>format=jpg&name=4096x4096</p> <p>https://pbs.twimg.com/media/FW_NrjhUcAEDebi?format=jpg&name=4096x4096</p> <p>https://pbs.twimg.com/media/FW_NsxOVEAEyvVn?format=jpg&name=4096x4096</p> <p>KJV- Romans 6</p>
~0572	<p>Satan's Big Lie – Unforgiveness</p> <p>KJV James 3 Laurie Ditto</p>	<p>10:23 AM · Jul 6, 2022</p> <p>https://twitter.com/DarBenThu1/status/1544733894926168064</p>	<p>2022 July 6 - This BIG Lie of Satan Sends Believers to Hell ~:Laurie: Ditto~ James - 3 https://youtube.com/watch?v=eBpX-V_gKTI #Unforgiveness #Patience #Ohio #Ohioan #StateCountryManSettlorGrantor #Kind #Gentle #Terrorism #Hate #Murder #Murderous #Judgment #Pride #Deception #OnceSavedAlwaysSaved</p>	<p>https://twitter.com/DarBenThu1/status/1544320277768806406/photo/1</p> <p>https://pbs.twimg.com/media/FW_9y8CVQAMDzHT?format=jpg&name=4096x4096</p> <p>https://pbs.twimg.com/media/FW_95z7VUAAX44G?format=jpg&name=4096x4096</p> <p>https://pbs.twimg.com/media/FW_97IEVEAAOnuX?format=jpg&name=4096x4096</p> <p>https://pbs.twimg.com/media/FW_99uRVUAEdh6a?format=jpg&name=4096x4096</p>

:Mark	:Matter	:Location	:Claim	:Facts	160 / 199
-------	---------	-----------	--------	--------	-----------



298

				format=jpg&name=4096x4096 KJV- James 3
-0573	Doctors Psychotherapists Butchers Liars people- damage Jordan Peterson Trustee- Dereliction	7:23 PM · Jul 6, 2022 https://twitter.com/DarBenThu1/status/1544869783136399360	2022 July 6 Doctors & Psychotherapists: Butchers & Liars by -:Jordan: Peterson https://youtube.com/watch?v=ayWyzvo9SNY #Ohio - #transgender -people-damage is with the #EBA1933AD -US-Corp.- #TrusteeDereliction - licensed-violation of the #DOI1776AD -obligation to the USofA1776ADPeople .. AGAIN!	https://www.youtube.com/watch?v=ayWyzvo9SNY
-0574	KJV Proverbs 10 Years of the wicked Pastor Murray	3:49 AM · Jul 7, 2022 https://twitter.com/DarBenThu1/status/1544997071429648384	2022 July 7 KJV- Proverbs Chap 10 - 27 The fear of the LORD prolongeth days; But the years of the wicked shall be shortened. ~10:6 to 10:32~ Pastor Murray https://youtube.com/watch?v=bZZ-F7	https://www.youtube.com/watch?v=bZZ-F77sk5Q -6:13 AM · Jul 5, 2022 https://twitter.com/DarBenThu1/status/1544308521742675968
-0575	KJV Proverbs 10 James 3 understanding righteousness	5:30 AM · Jul 7, 2022 https://twitter.com/DarBenThu1/status/1545022530552926208	2022 July 7 KJV- Proverbs Chap 10 > James 3 << :i man :Take-Away :i- man on this day Read and Shema*- Listened UPON :Proverbs 10 then James 3 ~*with the looking for the understanding in the order for the doing of the Righteousness~ >> :Thought -:is: ~:appended-.	3:49 AM · Jul 7, 2022 https://twitter.com/DarBenThu1/status/1544997071429648384 https://twitter.com/DarBenThu1/status/1544320277768806406/photo/1 Proverbs Chap 10 > James 3 << :i man :Take-Away
-0576	Inform State Country Man	9:02 AM · Jul 7, 2022	2022 JULY 7	https://twitter.com/DarBenThu1/status/

:Mark	:Matter	:Location	:Claim	:Facts	161 / 199
-------	---------	-----------	--------	--------	-----------



CSH

	Sovereign Settlor Grantors DOI 1776 Grantors EBA 1933	https://twitter.com/DarBenThu1/status/1545075901636849664	@DarBenThu1 :Ohigan-Darrell-James: Hill, -:Executor- Procurator: EBA-1933-AD :EBA-1933-AD- Trust-Fund for the State-Country-Man-Settlor-Grantors https://Twitter.com/DarBenThu1 Please inform all #StateCountryManSettlorGrantors	https://pbs.twimg.com/media/FXE10etVQAA7iMA?format=jpg&name=900x900 Contact information
~0577	Civil Status EBA 1933 State Claim Render Status Authentication Recordation Appoint Minister ~Executor~ Settle & Closure	<u>4:33 PM · May 19, 2022</u> https://twitter.com/DarBenThu1/status/1527432353856901122	Check-Off-Lists For auth → civil-Live-STATUS -> :EBA1933AD- account-SETTLE & Closure :Check-Off-Lists For -:Estab: #StateCountryManSettlerGrantor - #DOI1776AD -#EBA1933AD -AUTHENTICATION → RECORDATION → APPOINT-EXECUTOR & DEMAND- #EBA1933AD - ACCOUNT -RENDERING, SETTLE, AND CLOSURE	https://twitter.com/DarBenThu1/status/1544320277768806406/photo/1 https://pbs.twimg.com/media/ETKHgVRUUAJAjMk?format=jpg&name=4096x4096 https://pbs.twimg.com/media/ETKHijTUcAA7KzG?format=jpg&name=4096x4096 AUTHENTICATION → RECORDATION
~0578	State Country Man Settlor Grantor DOI 1766 EBA 1933 State Executor - Decision	<u>3:03 AM · May 5, 2022</u> https://twitter.com/DarBenThu1/status/1522154973630320640	#OneOfFiveExecute the -: #StateCountryManGrantorStatus . #StateCountryManGrantor #CivilDeadStatus #CivilLiveStatus #FullAuthentication #CertificateOfLiveBirth #StateCountry #StateCountryManSovereigWard #StateCountryManSovereignExecutor #CivilLiveStatus #DOI1776AD #EBA1933AD	https://twitter.com/DarBenThu1/status/1544320277768806406/photo/1 https://pbs.twimg.com/media/FR_HdMrVUA17Vbn?format=jpg&name=4096x4096

:Mark	:Matter	:Location	:Claim	:Facts	162 / 199
-------	---------	-----------	--------	--------	-----------



Handwritten signature/initials

				https://pbs.twimg.com/media/ER_HhwHUYAAj7w?format=jpg&name=4096x4096 How to change Your State-Country-Man-Grantor-Status
-0579	State Country Man Settlor Grantor DOI 1766 EBA 1933 State Executor - Decision	6:24 PM · May 15, 2022 https://twitter.com/DarBenThu1/status/1526010631144345601	AT #USNSCarsonCity #USNSCatawba #USNSCesarChavez #USNSCharlesDrew #USNSCharlton #USNSChoctawCounty #USNSCityBismarck #NavalAirStationJointReserveBaseNewOrleans #Maryland	8:13 PM · May 6, 2022 https://twitter.com/DarBenThu1/status/1522776515192139778 3:03 AM · May 5, 2022 https://twitter.com/DarBenThu1/status/1522154973630320640
-0580	State Country Man Settlor Grantor DOI 1766 EBA 1933 State Executor - Decision	5:50 PM · May 15, 2022 https://twitter.com/DarBenThu1/status/1526002077595336704	P Why is completing YOUR Executor: EBA-1933-A.D. important? #USSHalsey #USSHampton #USSHarpersFerry #USSHarrySTruman #USSHartford #USSHawaii #USSHelena #USSHenryMJackson #USSHershelWoodyWilliams #USSHiggins #USSHopper #USSHoward #USSHuéCity #USSHurricane #USSIllinois #USSIndiana	8:13 PM · May 6, 2022 https://twitter.com/DarBenThu1/status/1522776515192139778 3:03 AM · May 5, 2022 https://twitter.com/DarBenThu1/status/1522154973630320640
-0581	State Country Man Settlor Grantor DOI 1766 EBA 1933 State Executor - Decision	5:39 PM · May 15, 2022 https://twitter.com/DarBenThu1/status/1525999335183306752	E Why is completing YOUR Executor: EBA-1933-A.D. important? #NavalConstructionBattalionCenterGulfport #Nevada #NavalAirStationFallon #NewYork #NavalSupportActivitySaratogaSprings #Rhodelsland	8:13 PM · May 6, 2022 https://twitter.com/DarBenThu1/status/1522776515192139778

:Mark	:Matter	:Location	:Claim	:Facts	163 / 199
-------	---------	-----------	--------	--------	-----------



Handwritten signature/initials

			#NavalStationNewport #SouthCarolina #BeaufortSouthCarolinaMilitaryBases	3:03 AM · May 5, 2022 https://twitter.com/DarBenThu1/status/1522154973630320640
~0582	State Country Man Settlor Grantor DOI 1766 EBA 1933 State Executor - Decision	2:31 AM · May 15, 2022 https://twitter.com/DarBenThu1/status/1525312121549885440	R #Signing -Statement to the #EBA1933ADLicensee #XNurseN2014 #XNurseN2015 #XNurseN2016 #Twitter #Triller #Periscope #Vimeo #Valence #WhatsApp #Snapchat #Pinterest #Reddit #WeHeardIt #Influenster #FilmAffinity #OpenDiary #Yelp #TheDots #Telegram #FoursquareSwarm #Douban #Discord	8:08 PM · May 13, 2022 https://twitter.com/DarBenThu1/status/1525312121549885440 https://twitter.com/DarBenThu1/status/1544320277768806406/photo/1 https://pbs.twimg.com/media/FSr-7WnUsAAEACL?format=jpg&name=4096x4096 https://pbs.twimg.com/media/FSr--VkVsAAWeLE?format=jpg&name=4096x4096 https://pbs.twimg.com/media/FSr-p9VUAAZiRT?format=jpg&name=4096x4096 https://pbs.twimg.com/media/FSr_A3SUYAECYwb?format=jpg&name=4096x4096 Signing -Statement to the EBA-1933-AD-Licensee
~0683	State Country Man Settlor	12:15 AM · May 11, 2022	Why establish oneself as the #EBA1933AD -Executor?	8:13 PM · May 6, 2022

:Mark	:Matter	:Location	:Claim	:Facts	164 / 199
-------	---------	-----------	--------	--------	-----------



Handwritten signature/initials

	Grantor DOI 1766 EBA 1933 State Executor - Decision	https://twitter.com/DarBenThu1/status/1524286938022178817	Because you are #StateCountryManSettlor of the #DOI1776AD -DUTY, you swore-fidelity to the #CftUSofA1776 -people of whom you are, and IT IS YOUR DUTY of this nation to protect YOU!! God Bless You. #USArmy #YumaProvingGround	https://twitter.com/DarBenThu1/status/1522776515192139778 https://twitter.com/DarBenThu1/status/1544320277768806406/photo/1 https://pbs.twimg.com/media/FSdZA-UVIAAzil_?format=jpg&name=4096x4096 https://pbs.twimg.com/media/FSdZC69UcAAEP_U?format=jpg&name=4096x4096 How to change Your State-Country-Man-Grantor-Status
~0584	State Country Man Settlor Grantor DOI 1766 EBA 1933 State Executor - Decision	2:14 PM · May 8, 2022 https://twitter.com/DarBenThu1/status/1523411112762363904	:CountryMan: ? :Grantor (you) Must-Be :Executor for YOUR EBA-1933—Trust SINCE 2003. Please. #uscg #dod #militarytransition #JobsAfterServing #OwnYourTransition #VetsConnect #VeteransConnect #VetsConnection #Usmilitary #VeteranStrong #VFW #NeverForget #VetStrong #StrongVet #USN	8:13 PM · May 6, 2022 https://twitter.com/DarBenThu1/status/1522776515192139778 3:03 AM · May 5, 2022 https://twitter.com/DarBenThu1/status/1522154973630320640
~0585	State Country Man Settlor Grantor DOI 1766 EBA 1933 State Executor - Decision	4:59 AM · May 8, 2022 https://twitter.com/DarBenThu1/status/	Why Executor: EBA-1933-A.D. is important? Ex. 1- Not Executor means Trust is NOT-given to your wife or children; 2- Not Executor means in bankruptcy-proceeding, Trust is Not Known; 3- Not Executor: the Children don't know anything	

:Mark	:Matter	:Location	:Claim	:Facts	165 / 199
-------	---------	-----------	--------	--------	-----------



Handwritten signature or initials.

:Two-Year-Review :Dar-Ben-Thu: Hill ~www.twitter.com/DarBenThu1~ -Authority

https://twitter.com/hashtag/darbenthu1September222020?src=hashtag_click

:DarBenThu1 -Box-Graph: #September2020AD > #August2022AD

166 / 199

		1523271441000525825	about the EBA-1933-A.D. 4- The \$eba is yours !!!	
-0586	State Country Man Settlor Grantor DOI 1766 EBA 1933 State Executor - Decision	11:50 PM · Jul 7, 2022 https://twitter.com/DarBenThu1/status/1545299198190292992	Why #StateCountryManGrantorExecutors? Ans. the EBA-1933-A.D.-Trust is done :2003 A.D. You! are a Billionaire! Too! #NewMexico #NewYork #NorthCarolina #NorthDakota #Ohio #Oklahoma #Oregon #Pennsylvania #Rhodelsland #SouthCarolina #SouthDakota	4:59 AM · May 8, 2022 https://twitter.com/DarBenThu1/status/1523271441000525825
-0587	State Country Man Settlor Grantor DOI 1766 EBA 1933 State Executor - Decision Twitter-Notice-April-2022	11:52 PM · Jul 7, 2022 https://twitter.com/DarBenThu1/status/1545299734398586880	Why #StateCountryManGrantorExecutors? Ans. the EBA-1933-A.D.-Trust is done :2003 A.D. You! are a Billionaire! Too! #NewMexico #NewYork #NorthCarolina #NorthDakota #Ohio #Oklahoma #Oregon #Pennsylvania #Rhodelsland #SouthCarolina #SouthDakota	11:54 AM · Apr 29, 2022 https://twitter.com/DarBenThu1/status/1520114322596270080 9:15 AM · Apr 27, 2022 https://twitter.com/DarBenThu1/status/1519349650649624576 https://twitter.com/DarBenThu1/status/1544320277768806406/photo/1 Twitter-Notice-April-2022
-0588	Joseph Robinette	11:18 AM · Apr 28, 2022 https://twitter.com/DarBenThu1/status/1519742874195140608	Oh-my how the haughty-man is fallen. Big me, little you. Right? 2min18sec. This is how he thinks?!!	https://twitter.com/i/status/1518986960026677249

:Mark	:Matter	:Location	:Claim	:Facts	166 / 199
-------	---------	-----------	--------	--------	-----------

2022-011769 MISC Page: 2749 of 2782

09/26/2022 03:35:37 PM Receipt #: 22-9381
Rec Fee: \$30.00 Darrell James Hill
Gila County, Az, Sadie Jo Bingham, Recorder



SPR

:Two-Year-Review :Dar-Ben-Thu: Hill ~www.twitter.com/DarBenThu1~ -Authority
https://twitter.com/hashtag/darbenthu1September222020?src=hashtag_click
:DarBenThu1 -Box-Graph: #September2020AD > #August2022AD

			Biden in 2002 as he mocks US Marine Scott Ritter	
~0589	State Country Man Settlor Grantor DOI 1766 EBA 1933 State Executor - Decision	2:37 PM · Apr 26, 2022 https://twitter.com/DarBenThu1/status/1519068250222448641	The Urgency-doc and the Translation-doc are here: https://blackandbluesoulsmatter.wordpress.com/2022/04/26/why-the-persistent-urgency-to-waken-grantors-of-the-eba-1933-a-d/	https://blackandbluesoulsmatter.wordpress.com/2022/04/26/why-the-persistent-urgency-to-waken-grantors-of-the-eba-1933-a-d/ 2:17 PM · Apr 26, 2022 https://twitter.com/DarBenThu1/status/1519063204416032769
~0590	State Country Man Settlor Grantor DOI 1766 EBA 1933 State Executor - Decision	11:55:PM · Jul 7, 2022 https://twitter.com/DarBenThu1/status/1545300462504591360	Why #StateCountryManGrantorExecutors ? Ans. the EBA-1933-A.D.-Trust is done :2003 A.D. You! are a Billionaire! Too! #NewMexico #NewYork #NorthCarolina #NorthDakota #Ohio #Oklahoma #Oregon #Pennsylvania #RhodeIsland #SouthCarolina #SouthDakota	https://blackandbluesoulsmatter.wordpress.com/2022/04/26/why-the-persistent-urgency-to-waken-grantors-of-the-eba-1933-a-d/ 2:17 PM · Apr 26, 2022 https://twitter.com/DarBenThu1/status/1519063204416032769
~0591	State Country Man Settlor Grantor DOI 1766 EBA 1933 State Executor - Decision	12:20 AM · Jul 8, 2022 https://twitter.com/DarBenThu1/status/1545306920004624384	2022 JULY 7 :Ohioan-Darrell-James: Hill, -:Executor-Procurator: EBA-1933-AD EBA-1933-AD- Trust-Fund for the State-Country-Man-Settlor-Grantors https://Twitter.com/DarBenThu1 Tell, report and encourage- all of the #StateCountryManSettlorGrantors to Stand for their family & community.	https://twitter.com/DarBenThu1/status/1544320277768806406/photo/1 https://pbs.twimg.com/media/FXIH0seUcAE-VUH?format=jpg&name=4096x4096 Contact information
~0592	Protect Our People- All	1:43 PM · Jul 9, 2022	Pearl Harbor water poisoning: US military families say they	https://www.theguardian.com/us-news/2022/jul/

:Mark	:Matter	:Location	:Claim	:Facts	167 / 199
-------	---------	-----------	--------	--------	-----------

2022-011769 MISC Page: 2750 of 2782
 09/26/2022 03:35:37 PM Receipt #: 22-9381
 Rec Fee: \$30.00 Darrell James Hill
 Gila County, Az, Sadie Jo Bingham, Recorder



Handwritten signature/initials

	Family Military Cure EBA 1933 State Country Man Settlor Grantor DOI 1766 EBA 1933 State Executor - Decision	https://twitter.com/DarBenThu1/status/1545871273841999872	continue to fall ill	02/pearl-harbor-pollution-water-jet-fuel-hawaii?CMP=share_btn_tw
-0593		1:46 PM · Jul 9, 2022 https://twitter.com/DarBenThu1/status/1545872043903594497	Methodist Church's First Drag Queen Pastor: 'God Is Nothing'	https://spectator.org/methodist-church-first-drag-queen-pastor-god-is-nothing/
-0594	Anti Christ Anti Messiah Sadu Sandar Selvaraj	2:22 PM · Jul 9, 2022 https://twitter.com/DarBenThu1/status/1545881077167706112	Witnesses Anti christ - Sadhu,Sundar Selvaraj https://youtube.com/watch?v=2KdKEHO055Q #StateCountryManSettlorGrantor #Ohioan #GrantorExecutor #antiChrist #antiChrist #Earthquakes #antiMessiah #A #SpiritualIntelligence #SI #falseprophet #SonOfPerdition #WarsandRumorsOfWars #HumbleLeaders	https://www.youtube.com/watch?v=2KdKEHO055Q Witnesses Anti-Christ
-0595	Sundar Selvaraj Sadhu KJV Romans 1	5:11 PM · Jul 9, 2022 https://twitter.com/DarBenThu1/status/1545923510505074689	Sundar Selvaraj Sadhu April 30, 2018 : Jesus Will Whip The Churches https://youtube.com/watch?v=01WEkMPZA4g KJV-Romans Chap 1 -appended. We have choice ~:We- man are with the choice.~	https://www.youtube.com/watch?v=01WEkMPZA4g
-0596	Texas Housing Abuse	5:41 PM · Jul 9, 2022	1) Send a ?copy of the HOA -agreement and rules.	https://twitter.com/DarBenThu1/status/

:Mark	:Matter	:Location	:Claim	:Facts	168 / 199
-------	---------	-----------	--------	--------	-----------



Handwritten signature/initials

		https://twitter.com/DarBenThu1/status/1545931114665037825	2) Are the Rowses #StateCountryManSettlorWards or #StateCountryManSettlorGrantors ; etc.? 3) Is the HOA with a feeding-program for the Earth-life? 4) Are the Rowses good-Samaritans in their helps?	https://www.houstonchronicle.com/news/houston-texas/houston/article/A-Cypress-HOA-sued-a-couple-250K-for-feeding-17292935.php?utm_source=twitter.com&utm_medium=social_organic&utm_campaign=twittermoment
~0597	Sundar Selvaraj Sadhu KJV Revelation 14	5:59 PM · Jul 9, 2022 https://twitter.com/DarBenThu1/status/1545935730295259138	2022 July 9 Sundar Selvaraj Sadhu August 25, 2018 God Gathering His People KJV Revelation 14 v 1-4 https://youtube.com/watch?v=keaaGDw_K2U #StateCountryManSettlor #StateCountryManSettlorGrantor #SonOfGod #DyingToSelf #LambPowerFirstThenLionPower #ServantFirstThenAnnoiting #Ohioan #HolyChurch	https://youtu.be/keaaGDw_K2U https://youtu.be/keaaGDw_K2U?t=1 God Gathering His People
~0598	Congregations Perishment Hell Laurie Ditto	6:37 PM · Jul 9, 2022 https://twitter.com/DarBenThu1/status/1545945241902952449	2022 July 9 Laurie Ditto I Saw Church Leaders Sending Their Congregation to Hell! https://youtube.com/watch?v=NKfy8JhT_B8 #Ohioan #Ysrael #Yacob #HolyChurch #StateCountryManSettlor #StateCountryManGrantor Don't grow weary in doing this good work; at the least then we can save some. #shalom	https://youtu.be/NKfy8JhT_B8 https://youtu.be/NKfy8JhT_B8?t=2 I Saw Church Leaders Sending Their Congregation to Hell
~0599	Mario Murillo	8:04 PM · Jul 9, 2022	2022 July 9 Mario Murillo Psalm 11 MARIO MURILLO	Video made private ?
:Mark	:Matter	:Location	:Claim	:Facts



Handwritten signature or initials.

	Psalms 11	https://twitter.com/DarBenThu1/status/1545967228842979335	PROPHETIC WORD: [SATAN WORST NIGHTMARE] https://youtube.com/watch?v=uPQ8CL6dvfA Psalm 11 v 2 ... lo, the wicked bend their bow, they make ready their arrow upon the string, that they may privily shoot at the upright in heart ~to kill us ALL~	
-0600		12:23 PM · Jul 10, 2022 https://twitter.com/DarBenThu1/status/1546213617636233217	2022 July 10 #StateCountryManSettlor #Ohioan #StateCountryManSettlorGrantor #StateNationalGuard #DOI1776AD #EP1863AD #CftUSofA1787AD #Concession1213AD #Yacob #Ysrael #HolyChurch Food Glofious Food -#IceAge2: The Meltdown https://youtube.com/watch?v=HUEu4r3cW8U See the Demons@~ 1:36? is #SolGreen ?	https://youtu.be/HUEu4r3cW8U https://youtu.be/HUEu4r3cW8U
-0601	Arizona Oxygen Changes De-oxygenation	6:13 AM · Jul 11, 2022 https://twitter.com/DarBenThu1/status/1546482787212963840	2022 July 11 Make #Arizona an oxygen ~O2~-oasis w/ mild-humidity, clear-Skies & a [re-]newed- smart-extreme-[re-]greenifications. Sugg: a) Everybody righteously-keep at the least- one- plant-life in the living for the more -hidden -O2. #Arizona #StateCountrymanSettlorGrantor	https://twitter.com/DOverview/status/1545492701616947202 UNCONTROLLED -GROWTH IS WITH THE SYMPTOMOLOGY OF A DISEASE.
-0602	State.Country Man Settlor Grantor DOI 1766 EBA 1933 State Executor - Decision	12:20 AM · Jul 8, 2022 https://twitter.com/DarBenThu1/status/1545306920004624384	:public-notice: #DOI1776AD -#EBA1933AD -dead~2003AD~ Trust ~gold~Trust #Wyomingite #Wisconsinite #WestVirginian #Washingtonian #Virginian #Vermontier #Utahn #Texan #Tennessean #SouthDakotan #SouthCarolinian #RhodeIslander #Pennsylvanian #Oregonian #Oklahoman #Ohioan #NorthDakotan	https://twitter.com/DarBenThu1/status/1545306920004624384/photo/1

:Mark	:Matter	:Location	:Claim	:Facts	170 / 199
-------	---------	-----------	--------	--------	-----------



Handwritten signature/initials

:Two-Year-Review :Dar-Ben-Thu: Hill ~www.twitter.com/DarBenThu1~ -Authority
https://twitter.com/hashtag/darbenthu1September222020?src=hashtag_click
:DarBenThu1 -Box-Graph: #September2020AD > #August2022AD

-0603	State Country Man Settlor Grantor DOI 1766 EBA 1933 State Executor - Decision	12:20 AM · Jul 8, 2022 https://twitter.com/DarBenThu1/status/1545306920004624384	2022 JULY 7 :Ohioan-Darrell-James: Hill, -:Executor- Procurator: EBA-1933-AD EBA-1933-AD- Trust-Fund for the State-Country-Man-Settlor-Grantors https://Twitter.com/DarBenThu1 Tell, report and encourage- all of the #StateCountryManSettlorGrantors to Stand for their family & community.	https://pbs.twimg.com/media/FXIH0seUcAE-VUH?format=jpg&name=4096x4096 https://twitter.com/DarBenThu1/status/1544320277768806406/photo/1 https://pbs.twimg.com/media/FXIH0seUcAE-VUH?format=jpg&name=4096x4096 Information-Contact -locator
~0604	State Country Man Settlor Grantor DOI 1766 EBA 1933 State Executor - Decision	7:19 AM · Jul 11, 2022 https://twitter.com/DarBenThu1/status/1546499529083473920	#Floridan #Delawarean #Connecticuter #Coloradan #Californian #Arkansan #Arizonan #Alabaman #Alaskan #Yacob #Ysrael #HolyChurch #ChildrenofYsrael #Jerusalem #DOI176AD #EBA1933AD #StateCountryManBeneficiarySettlorGrantor #GenMilley #JCOS #PFTUSA1787A02021 #POTUSA1863A02021 #Shalom	12:20 AM · Jul 8, 2022 https://twitter.com/DarBenThu1/status/1545306920004624384 https://twitter.com/DarBenThu1/status/1545306920004624384/photo/1 https://pbs.twimg.com/media/FXIH0seUcAE-VUH?format=jpg&name=4096x4096 Information-Contact -locator
-0605	State Country Man Settlor Grantor DOI 1766 EBA 1933 State Executor - Decision	7:36 AM · Jul 11, 2022 https://twitter.com/DarBenThu1/status/1546503579631988737	:public-notice: #DOI1776AD -#EBA1933AD -dead-2003AD-Trust ~gold-Trust #ArizonaLargestCities #Phoenix #Tucson #Mesa #Chandler #Scottsdale #Glendale #Gilbert #Tempe #Peoria #Surprise #HolyChurch #Yacob #Ysrael #Ohioan	12:20 AM · Jul 8, 2022 https://twitter.com/DarBenThu1/status/1545306920004624384 https://twitter.com/DarBenThu1/status/1545306920004624384/photo/1

:Mark	:Matter	:Location	:Claim	:Page 171 / 199
-------	---------	-----------	--------	-----------------



Handwritten signature/initials

:Two-Year-Review :Dar-Ben-Thu: Hill ~www.twitter.com/DarBenThu1~ -Authority

https://twitter.com/hashtag/darbenthu1September222020?src=hashtag_click

:DarBenThu1 -Box-Graph: #September2020AD > #August2022AD

172 / 199

				https://pbs.twimg.com/media/FXIH0seUcAE-VUH?format=jpg&name=4096x4096 Information-Contact -locator
~0606	State Country Man Settlor Grantor DOI 1766 EBA 1933 State Executor - Decision	7:36 AM · Jul 11, 2022 https://twitter.com/DarBenThu1/status/1546503775749152768	#ArizonaCounties #Apache #Cochise #Coconino #Gila #Graham #Greenlee #LaPaz #Maricopa #Mohave #Navajo #Pima #Pinal #Santa #Yavapai #Yuma #HolyChurch #Yacob #Ysrael #Ohioan	12:20 AM · Jul 8, 2022 https://twitter.com/DarBenThu1/status/1545306920004624384 https://twitter.com/DarBenThu1/status/1545306920004624384/photo/1 https://pbs.twimg.com/media/FXIH0seUcAE-VUH?format=jpg&name=4096x4096 Information-Contact -locator

:Mark	:Matter	:Location	:Claim	:Facts	172 / 199
-------	---------	-----------	--------	--------	-----------

2022-011769 MISC Page: 2755 of 2782

09/26/2022 03:35:37 PM Receipt #: 22-9381

Rec Fee: \$30.00 Darrell James Hill

Gila County, Az, Sadie Jo Bingham, Recorder

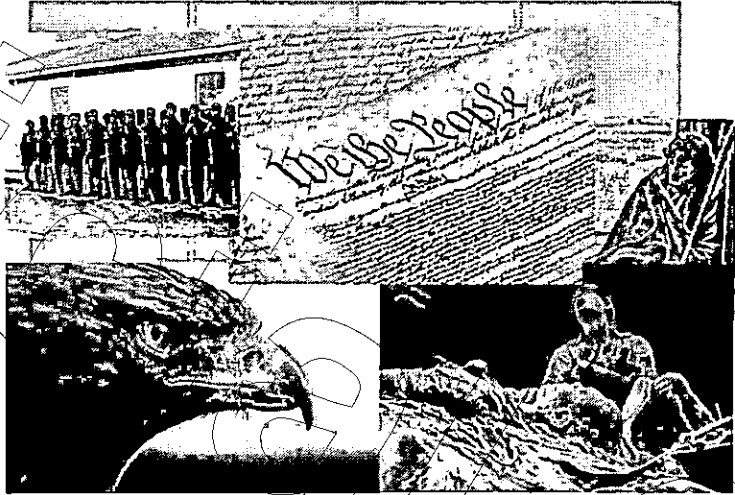

Handwritten initials or mark

-0606	State Country Man Settlor Grantor DOI 1766 EBA 1933 State Executor - Decision	7:15 PM · Jul 11, 2022 https://twitter.com/DarBenThu1/status/1546679584661245952		7:36 AM · Jul 11, 2022 https://twitter.com/DarBenThu1/status/1546503775749152768
-0607	Ideological Subversion Yuri Bezmenov Hegelian Dialectic	8:47 PM · Jul 11, 2022 https://twitter.com/DarBenThu1/status/1546702663458295808	2022 July 11 – The Four Stages of Ideological Subversion -- FULL INTERVIEW with Yuri Bezmenov: The Four Stages of Ideological Subversion (1984) Ideological subversion for the de-stabilization of the nation. Yuri Bezmenov https://youtube.com/watch?v=yErKTV	https://www.youtube.com/watch?v=yErKTVdETpw Four Stages of Ideological Subversion https://twitter.com/DarBenThu1/status/1544320277768806406/photo/1 https://pbs.twimg.com/media/

:Mark	:Matter	:Location	:Claim	:Facts
-------	---------	-----------	--------	--------



Handwritten signature

				FXb_clyUsAA1PMY? format=jpg&name=4096x4096 Format Sheet of the Ideological-treachery
~0608	Ideological Subversion Yuri Bezmenov Hegelian Dialectic	8:54 PM · Jul 11, 2022 https://twitter.com/DarBenThu1/status/1546704482787938304	2022 July 11 – The Four Stages of Ideological Subversion -- FULL INTERVIEW with Yuri Bezmenov: The Four Stages of Ideological Subversion (1984) Ideological subversion for the de-stabilization of the nation. Yuri Bezmenov https://youtube.com/watch?v=yErKTV	8:47 PM · Jul 11, 2022 https://twitter.com/DarBenThu1/status/1546702663458295808
~0609	Ideological Subversion Yuri Bezmenov Hegelian Dialectic	9:00 PM · Jul 11, 2022 https://twitter.com/DarBenThu1/status/1546706005270048770	#Wyomingite #Wisconsinite #WestVirginian #Washingtonian #Virginian #Vermontier #Utahn #Texan #Tennessean #SouthDakotan #SouthCarolinian #RhodeIslander #Pennsylvanian #Oregonian #Oklahoman #Ohioan #NorthDakotan	8:47 PM · Jul 11, 2022 https://twitter.com/DarBenThu1/status/1546702663458295808
~0610	Ideological Subversion Yuri Bezmenov Hegelian Dialectic	9:00 PM · Jul 11, 2022 https://twitter.com/DarBenThu1/status/1546706121708122115	#NorthCarolinian #NewYorker #NewMexican #NewJerseyan #NewHampshire #Nevadan #Nebraskan #Montanan #Missourian #Mississippian #Minnesotan #Michiganian #Massachusettsan #Marylander #Mainer #Louisianan #Kentuckian #Kansan #Iowan #Hoosier #Illinoisan #Idahoan #Hawaiian #Georgian	9:00 PM · Jul 11, 2022 https://twitter.com/DarBenThu1/status/1546706005270048770 8:47 PM · Jul 11, 2022 https://twitter.com/DarBenThu1/status/1546702663458295808
~0611	Ideological Subversion Yuri Bezmenov Hegelian Dialectic	9:01 PM · Jul 11, 2022 https://twitter.com/	#Floridan #Delawarean #Connecticuter #Coloradan #Californian #Arkansan #Arizonan #Alabaman #Alaskan #Yacob #Ysrael #HolyChurch #ChildrenofYsrael #Jerusalem	8:47 PM · Jul 11, 2022 https://twitter.com/DarBenThu1/status/

:Mark	:Matter	:Location	:Claim	:Facts	174 / 199
-------	---------	-----------	--------	--------	-----------



2142

		DarBenThu1/status/1546706261449748480	#DOI176AD #EBA1933AD #StateCountryManBeneficiarySettlorGrantor #GenMilley #JCOS #PFTUSA1787AO2021 #POTUSA1863AO2021 #Shalom	1546702663458295808
-0612	KJV Proverbs 12 Life pathway is no death	4:55 AM · Jul 12, 2022 https://twitter.com/DarBenThu1/status/1546825557928656898	2022 July 12 KJV- Proverbs Chap 12 1 Whoso loveth instruction loveth knowledge ; but he that hateth reproof is brutish. ... 3 A man shall not be established by wickedness ... 28 In the way of righteousness is life ; And in the pathway thereof there is no death. Shalom.	https://twitter.com/DarBenThu1/status/1544320277768806406/photo/1 https://pbs.twimg.com/media/FXdqECGUsAYz2Wt?format=jpg&name=4096x4096 https://pbs.twimg.com/media/FXdqFfIUsAEUjRH?format=jpg&name=4096x4096 KJV- Proverbs 12
-0613	KJV Proverbs 13 14	6:44 AM · Jul 13, 2022 https://twitter.com/DarBenThu1/status/1547215408884723714	2022 July 13 Proverbs 13 14 You-We are soul-Journeymers. We-most move at the speed of the water in our flesh-suits. But our normal is to walk on the water and to heal ourselves and others. We are deceived. Spirit see what stands out for you. Ask God; He knows. He is spirit too.	https://twitter.com/DarBenThu1/status/1544320277768806406/photo/1 https://pbs.twimg.com/media/FXjO7nWUYAAVLiv?format=jpg&name=4096x4096 https://pbs.twimg.com/media/FXjO9tcUcAEiqf8?format=jpg&name=4096x4096

:Mark	:Matter	:Location	:Claim	:Facts	175 / 199
-------	---------	-----------	--------	--------	-----------



LMC

				https://pbs.twimg.com/media/FXjO_FbUYAAbY5?format=jpg&name=4096x4096 KJV- Proverbs 13 , 14
~0614	KJV Psalms 25	<u>10:28 AM · Jul 13, 2022</u> https://twitter.com/DarBenThu1/status/1547271693692854272	2022 July 13 Psalms 25 & 24 For the Effect: First- Pray Chap 25: put in your name. Later, read Chap 24. You will experience spirit-vision wider and broader. :You- man are a soul-journeyer with spirit-eyes too. Shalom.	https://twitter.com/DarBenThu1/status/1544320277768806406/photo/1 https://pbs.twimg.com/media/FXkCPfuVEAAiayO?format=jpg&name=4096x4096 https://pbs.twimg.com/media/FXkCMcdUEAAs4b-?format=jpg&name=4096x4096 KJV- Psalms 35 , 24
~0615	Joshua Schulte Wikileaks Vault 7 Matthew Russel	<u>2:14 PM · Jul 13, 2022</u> https://twitter.com/innercitypress/status/1547328664353767427	VERDICT VLOG: Just after Joshua Schulte found guilty of all nine counts in #Wikileaks CIA #Vault7 trial, stand up outside @SDNYLIVE courthouse, after submitted 154 booklet on the trial, soon on https://amazon.com/Matthew-Russel	Joshua Schulte: CIA- employee
~0616	Ohioan Sovereign Executor Procurator EBA 1933 Authorization Lawful Government	<u>1:55 AM · Jul 14, 2022</u> https://twitter.com/DarBenThu1/status/	2022 July 14 See: Authorization for the Establishment of the #DOI1776ADLawfulGovernment is with the #StateCountryManSettlorGrantor of the #DOI1776AD - money and law of the DOI-1776-AD.	<u>8:26 PM · Nov 23, 2020</u> https://twitter.com/DarBenThu1/status/1331076820402257922

:Mark	:Matter	:Location	:Claim	:Facts	176 / 199
-------	---------	-----------	--------	--------	-----------



shf

		<p align="center">1547505095343890432</p>		<p>https://twitter.com/DarBenThu1/status/1544320277768806406/photo/1</p> <p>https://pbs.twimg.com/media/EnjvKv9UcAEwJ0g?format=jpg&name=4096x4096</p> <p>https://pbs.twimg.com/media/EnjvMxZVQAMAb3C?format=jpg&name=4096x4096</p> <p>https://pbs.twimg.com/media/EnjvPfuVcAEbcfw?format=jpg&name=4096x4096</p> <p>:Sovereign-Authorization to Establish : Lawful-Government :Kinsman-redeemer DOI1-1776-AD Sovereign-Authorization</p>
-0617	Ohioan Sovereign Executor Procurator EBA 1933 Authorization Lawful Government	<p>10:46 PM · Dec 11, 2020</p> <p>https://twitter.com/DarBenThu1/status/1337635036930035713</p>	<p>:RIGHT OF :CONUSANCE ~USPS RMN RE 322 387 616 US...[:] :DEMAND: Authorization for the Restoration of the Lawful-Government. -- https://blackandbluesoulsmatter.wordpress.com/2020/12/12/right-of-conusance-usps-rmn-re-322-387-616-us-demand-authorization-for-the-restoration-of-the-lawful-government-this-is-done-as-the-kinsman-redeemer-is-58-et-al/ @BfarmerJustice1 @JhishawEsq @shearm @shawksebastian @HEAL_Food @NBFJA @navinakhanna @michaelharriot @RyanLizza</p>	<p>https://blackandbluesoulsmatter.wordpress.com/2020/12/12/right-of-conusance-usps-rmn-re-322-387-616-us-demand-authorization-for-the-restoration-of-the-lawful-government-this-is-done-as-the-kinsman-redeemer-is-58-et-al/</p> <p>:RIGHT OF :CONUSANCE ~USPS RMN RE 322-387-616</p>

:Mark	:Matter	:Location	:Claim	:Facts
-------	---------	-----------	--------	--------



Handwritten signature/initials

:Two-Year-Review :Dar-Ben-Thu: Hill ~www.twitter.com/DarBenThu1~ -Authority

https://twitter.com/hashtag/darbenthu1September222020?src=hashtag_click

:DarBenThu1 -Box-Graph: #September2020AD > #August2022AD

178 / 199

~0618	Ohioan Sovereign Executor Procurator EBA 1933 Authorization Lawful Government	1:58 AM · Jul 14, 2022 https://twitter.com/DarBenThu1/status/1547505776914096129	:RIGHT OF :CONUSANCE ~USPS RMN RE 322 387 616 US...[:] :DEMAND: Authorization for the Restoration of the Lawful-Government. -- https://blackandbluesoulsmatter.wordpress.com/2020/12/12/right-of-conusance-usps-rmn-re-322-387-616-us-demand-authorization-for-the-restoration-of-the-lawful-government-this-is-done-as-the-kinsman-redeemer-is-58-et-al/	https://blackandbluesoulsmatter.wordpress.com/2020/12/12/right-of-conusance-usps-rmn-re-322-387-616-us-demand-authorization-for-the-restoration-of-the-lawful-government-this-is-done-as-the-kinsman-redeemer-is-58-et-al/ :RIGHT OF :CONUSANCE ~USPS RMN RE 322 387 616
~0619	Concession 1213	2:57 AM · Nov 18, 2020 https://twitter.com/DarBenThu1/status/1329000676769218562	"Sublimus Dei; On the Enslavement and Evangelization of Indians [and others] Pope Paul III - 1537 "...without exception..., are by no means to be deprived of their liberty or the possession of their property... ; nor should they be in any way enslaved"	https://twitter.com/DarBenThu1/status/1544320277768806406/photo/1 https://pbs.twimg.com/media/EnGOH_DUUA4gxJ?format=jpg&name=large Sublimus Dei; On the Enslavement and Evangelization of Indians
~0620	OITNB Willy Lynch Letter PTSD Grief Heal	2:07 AM · Jul 14, 2022 https://twitter.com/DarBenThu1/status/1547508191851716608	2022 July 13 Orange Is The New Black = O~everybody: #DOI1776AD ~ITNB [:Willy-Lynch-X]. See: Healing the PTSD :1776-2019-AD -Grief-Sheet.	2:11 AM · Nov 12, 2020 https://twitter.com/DarBenThu1/status/1326814871392985088 https://twitter.com/DarBenThu1/status/

:Mark	:Matter	:Location	:Claim	:Facts	178 / 199
-------	---------	-----------	--------	--------	-----------

2022-011769 MISC Page: 2761 of 2782
09/26/2022 03:35:37 PM Receipt #: 22-9381
Rec Fee: \$30.00 Darrell James Hill
Gila County, Az, Sadie Jo Bingham, Recorder



OSHT

				<p align="center">https://pbs.twimg.com/media/EmnKI_AVkAathcu?format=jpg&name=900x900</p> <p align="center">Healing the PTSD can be done</p>
-0621	Fraces Lieber General Orders No. 100 24 April 1863 Lieber-Code	<p>4:51 AM · Nov 18, 2020</p> <p>https://twitter.com/DarBenThu1/status/1329029446536347649</p>	<p>... GOVERNMENT OF ARMIES OF THE [FEDERAL-] UNITED STATES IN THE FIELD: ... by Francis Lieber, ... General Orders No. 100 by President Lincoln, 24 April 1863. Art. 45(b) "Prize money, whether on sea or land, can now only be claimed under local law." :- man -civilian -Ohioan.</p>	<p>https://twitter.com/DarBenThu1/status/1544320277768806406/photo/1</p> <p>https://pbs.twimg.com/media/EnGomdTVgAAX5gh?format=jpg&name=large</p> <p align="center">General Orders No. 100 by President Lincoln, 24 April 1863.</p>
-0622	Temple Crown Concession 1213 Almighty-God-Yushuah SOG Ohioan Ambassador Trustee	<p>2:14 AM · Jul 14, 2022</p> <p>https://twitter.com/DarBenThu1/status/1547509756872384512</p>	<p>2022 July 13 :notice to the Temple-Crown by the i- man-Ohioan -:Son-of-God am with the Ambassador- Trustee: #Concession1213AD -assignment by the Almighty-God-Covenantor</p>	<p>4:41 PM · Oct 19, 2020</p> <p>https://twitter.com/DarBenThu1/status/1318336427227107328</p> <p>https://blackandbluesoulsmatter.files.wordpress.com/2020/10/2020-ltr-to-the-barons-final-2-all-2.pdf</p> <p align="center">:Claim to the Temple-Crown: RMN/RE 322 387 593 US October 2020 AD</p>

:Mark	:Matter	:Location	:Claim	:Facts	179 / 199
-------	---------	-----------	--------	--------	-----------



10/26

-0623	Concession 1213 Sentinel Events Privation deprivation Kinsman-Redeemer Yacob Ysrael Holy-Church	4:14 PM · Oct 19, 2020 https://twitter.com/DarBenThu1/status/1318329697042771969	See: "Sentinel Events for the Restoration of the Deprived-Property~the 'Concession of 1213 A.D', Concession-1213-A.D., et seq.~ stolen by Trustee-Derelicts; so to recover properly both, solely, and as the :kinsman-redeemer for :Negro-Ysrael, Ysrael and the Holy-church"	https://twitter.com/DarBenThu1/status/1544320277768806406/photo/1 https://pbs.twimg.com/media/EkulflEVkAEfs3m?format=jpg&name=4096x4096 https://pbs.twimg.com/media/Ekuln7_UcAIVDBb?format=jpg&name=4096x4096 https://pbs.twimg.com/media/Ekulp9dUYAE62gN?format=jpg&name=4096x4096 :Sentinel-Events: Privation-Violation: Covenant
-0624	Concession 1213 Sentinel Events Privation deprivation Kinsman-Redeemer Yacob Ysrael Holy-Church	2:15 AM · Jul 14, 2022 https://twitter.com/DarBenThu1/status/1547510149488599040	Sentinel Events for the Restoration of the Deprived-Property~the 'Concession of 1213 A.D', Concession-1213-A.D., et seq.~ stolen by Trustee-Derelicts	4:41 PM · Oct 19, 2020 https://twitter.com/DarBenThu1/status/1318336427227107328
-0625	Barack Hussein Donald John Joseph Robinette Stole Rob Jell Sessins	11:34 PM · Oct 7, 2020 https://twitter.com/DarBenThu1/status/1314091751309668352	:Jeff :Sessions said this: At your request, I am submitting my resignation. https://twitter.com/DarBenThu1/status/1544320277768806406/photo/1	7:05 PM · Sep 24, 2020 https://twitter.com/DarBenThu1/status/1309313123183017984 :i- man am wanting you to send this information to others so :Donald-John: Trump may be

:Mark	:Matter	:Location	:Claim	:Facts	180 / 199
-------	---------	-----------	--------	--------	-----------



10

			https://pbs.twimg.com/media/EjyXcOtU4AA03ew?format=jpg&name=4096x4096	known to get this. :i- man have been robbed. A: Cover to the Generals https://blackandbluesoulsmatter.files.wordpress.com/2020/09/a-2020-09-20-cover-to-cjos-and-net-all.pdf B: Body of the Document to :Donald. https://blackandbluesoulsmatter.files.wordpress.com/2020/09/b-1020
~0626	Twitter- Witness List Common law Public Claim Note Trustee Failure	2:17 AM · Jul 14, 2022 https://twitter.com/DarBenThu1/status/1547510709361160192	July 13 2022 Twitter- Witness List for the Common-Law, -:Public Notice on the matter of the :Notary-Public- Dishonor Upon the :Trespass and Violation of the :Duty and Obligations by the Trustee of the Legislative- Covenant(s).	4:44 PM · Oct 5, 2020 https://twitter.com/DarBenThu1/status/1313263777299623936 https://twitter.com/DarBenThu1/status/1544320277768806406/photo/1 https://pbs.twimg.com/media/EjmlVaxU0AAU3XF?format=jpg&name=4096x4096 https://pbs.twimg.com/media/EjmlVaxU4AAU098?format=jpg&name=4096x4096 See: Twitter- Witness List for the Common-Law, -:Public Notice https://pbs.twimg.com/media/EjmlVZ5U0AAkdyF?

:Mark	:Matter	:Location	:Claim	:Facts	181 / 199
-------	---------	-----------	--------	--------	-----------



Handwritten signatures and initials:
 [Signature]
 [Signature]
 EGH

				format=jpg&name=medium :EBA-1933-AD -EO for all persons to deliver all of their silver and gold to the US-Corp-1933-AD.
~0627	Barack Hussein Donald John Joseph Robinette Stole Rob Property	7:11 PM - Sep 24, 2020 https://twitter.com/DarBenThu1/status/1309314462768267264	Finally, these are two of the mail filings re: this theft of the property of :-i- man Gila county, 2017_002378 https://blackandbluesoulsmatter.files.wordpress.com/2020/09/gila-county-2017_002378.pdf Gila, county 2019_009291 https://blackandbluesoulsmatter.files.wordpress.com/2020/09/gila-c	https://blackandbluesoulsmatter.files.wordpress.com/2020/09/gila-county-2017_002378.pdf https://blackandbluesoulsmatter.files.wordpress.com/2020/09/gila-county-2019_009291.pdf
~0628	Barack Hussein Donald John Joseph Robinette Stole Rob Lots property stolen	7:09 PM - Sep 24, 2020 https://twitter.com/DarBenThu1/status/1309313994214141952	These are the lots of property: that have have been stolen from :-i- man. Lot #1 https://blackandbluesoulsmatter.files.wordpress.com/2020/09/c-lot-1-gila-cnty-ariz.-rec.-doc-2017_002378.pdf Lot #2 https://blackandbluesoulsmatter.files.wordpress.com/2020/09/d-lot-2-gila-cnty-ariz.-rec.-doc-2019-0009291.pdf Lot #3 https://blackandbluesoulsmatter.files.wordpress.com/2020/09/	https://blackandbluesoulsmatter.files.wordpress.com/2020/09/c-lot-1-gila-cnty-ariz.-rec.-doc-2017_002378.pdf https://blackandbluesoulsmatter.files.wordpress.com/2020/09/d-lot-2-gila-cnty-ariz.-rec.-doc-2019-0009291.pdf https://blackandbluesoulsmatter.files.wordpress.com/2020/09/e-lot-3-gila-cnty-ariz.-rec.-doc-2019-0009291.pdf

:Mark	:Matter	:Location	:Claim	:Facts	182 / 199
-------	---------	-----------	--------	--------	-----------



2454
HSHZ

			e-lot-	
~0629	Procurator Ohioan New Mexican Executor Non-Consent for DOI 1776-right- deprivation	2:31 AM · Jul 14, 2022 https://twitter.com/DarBenThu1/status/1547514163534000129	Procurator- Proof-of-notice-7009- 1410 0000 7868 5802- :Executor: PE-2017-A.D.- Nonconsent to :DOI-1776-A.D.- deprivation of -:unalienable-rights upon the man- Ohioan and New-Mexican by the Executor- Procurator	11:49 AM · Sep 24, 2020 https://twitter.com/DarBenThu1/status/1309203233538146304 https://blackandbluesoulsmatter.files.wordpress.com/2021/12/2021_016195.pdf Procurator- Proof-of-notice-7009- 1410 0000 7868 5802- :Executor: PE-2017-A.D.- Nonconsent to :DOI-1776-A.D.- deprivation of -:unalienable-rights upon the man- Ohioan and New-Mexican by the Executor- Procurator
~0630	Barack Hussein Donald John Joseph Robinette Stole Rob Lots property stolen POTUS	8:35 PM · Sep 22, 2020 https://twitter.com/DarBenThu1/status/1308610885313650690	Just opened-up this page to address the deprivation of :rights by the :Donald-John: Trump, -:POTUS-corp Trustee, -:POTUSA- CIC with the :theft of property-claimed and possessed by :i- man- Darrell-James: Hill. Very much property has been stolen in violation of all law or right.	
~0631	State Country Man Settlor Grantor Executor EBA 1933 Procurator	2:36 AM · Jul 14, 2022 https://twitter.com/DarBenThu1/status/	2022 July 13 Why is completing one's Executor: EBA-1933-A.D. important? When-after establish your Trust-Account- ID, then the Account is known to Your-state and disposed to your	8:13 PM · May 6, 2022 https://twitter.com/DarBenThu1/status/

:Mark	:Matter	:Location	:Claim	:Facts	183 / 199
-------	---------	-----------	--------	--------	-----------



CSH

:Two-Year-Review :Dar-Ben-Thu: Hill ~www.twitter.com/DarBenThu1~ -Authority
https://twitter.com/hashtag/darbenthu1September222020?src=hashtag_click
:DarBenThu1 -Box-Graph: #September2020AD > #August2022AD

	Kinsman-Redeemer	1547515487071768576	family if you die or live.	1522776515192139778 3:03 AM · May 5, 2022 https://twitter.com/DarBenThu1/status/1522154973630320640
~0632	English Ebonics Babel Slavic Language Mal-Feasance Treason	4:57 AM · Jul 14, 2022 https://twitter.com/DarBenThu1/status/1547550905074978816	2022 July 14 For the unraveling of the english-Ebonics-Babel-language -mis-e-du-cation, : this may-be a -:help with the Word O-rig-In-verification ~Etymology~: See: Prefixes and suffixes - https://ia902703.us.archive.org/34/items/websterselement00websgoog/websterselement00websgoog.pdf See: Online Etymological Dictionary - https://etymonline.com	https://ia902703.us.archive.org/34/items/websterselement00websgoog/websterselement00websgoog.pdf https://twitter.com/DarBenThu1/status/1544320277768806406/photo/1 https://pbs.twimg.com/media/FXoBC5cUEAA79mm?format=jpg&name=4096x4096 :Anti- dumbing-down -Language and Communication -sheet
~0633	State Country Man Settlor Grantor Executor EBA 1933 Claim Procurator Kinsman-Redeemer Authentication Settle Closure	5:10 AM · Jul 14, 2022 https://twitter.com/DarBenThu1/status/1547554026417336320	Check-Off-Lists For auth → civil-Live-STATUS -> :EBA1933AD- account-SETTLE & Closure :Check-Off-Lists For -:Estab: #StateCountryManSettlerGrantor - #DOI1776AD - #EBA1933AD -AUTHENTICATION → RECORDATION → APPOINT-EXECUTOR & DEMAND- #EBA1933AD ACCOUNT -RENDERING, SETTLE, AND CLOSURE	4:33 PM · May 19, 2022 https://twitter.com/DarBenThu1/status/1527432353856901122
~0634	State Country Man Settlor Grantor Ohioan New-	3:06 PM · Jul 25, 2022	#Ohioan #StateCountryManSettlorGrantor #NewMexican @AoPotus @PFTUSAof1787AQ @xNursen010	https://blackandbluesoulsmatter.wordpress.com/

:Mark	:Matter	:Location	:Claim	:Facts	184 / 199
-------	---------	-----------	--------	--------	-----------

2022-011769 MISC Page: 2767 of 2782
 09/26/2022 03:35:37 PM Receipt #: 22-9381
 Rec Fee: \$30.00 Darrell James Hill
 Gila County, Az, Sadie Jo Bingham, Recorder



Handwritten signature/initials

:Two-Year-Review :Dar-Ben-Thu: Hill ~www.twitter.com/DarBenThu1~ -Authority
https://twitter.com/hashtag/darbenthu1September222020?src=hashtag_click
:DarBenThu1 -Box-Graph: #September2020AD > #August2022AD

	Mexican Executor EBA 1933 Procurator Kinsman-Redeemer	https://twitter.com/DarBenThu1/status/1551690475865640960	@TrusteeCn1213 https://blackandbluesoulsmatter.wordpress.com/2022/03/22/open-source-tool-for-the-doi-1776-a-d-common-law-words-meanings-and-concepts/ https://linkedin.com/in/dj-hill-872963116/ :Glory and Honor is upon the Most-High-God ONE GOVERNMENT WILL FALL AND ANOTHER ONE WILL REPLACE THEM	https://www.linkedin.com/in/dj-hill-872963116/ https://rumble.com/v1dkgap-one-government-will-fall-and-another-one-will-replace-them.html
-0635	CSSCPG Learning Jurisdiction Order Structure Syntax David Wynn Miller	1:16 AM · May 29, 2022 https://twitter.com/DarBenThu1/status/1530825279110754304	Learning this is WORK! : David-Wynn: Miller -:CSSCPG - Quantum Language Grammar Syntax Seminar, 2012 AGUILA 2:24:11 / 9:30:52	https://youtu.be/blu8bsTOI4I https://youtu.be/blu8bsTOI4I?t=21 Quantum Language Grammar Syntax Seminar, 2012
-0636	CSSCPG David Wynn Miller	8:20 AM · May 29, 2022 https://twitter.com/DarBenThu1/status/1530932079948492800	CSSCPG. Better- video- succinct. ; David-wynn: Miller. -9th- July-2014. : Language-Fraud-Trial-Hearing.	https://youtu.be/_vF5VRmYp6Q https://youtu.be/_vF5VRmYp6Q?t=2
-0637	Babel Language Bottleneck Lawful-Communication Trustee Dereliction	11:57 AM · Jul 31, 2022 https://twitter.com/DarBenThu1/status/1553817227417112578	:The -:Bottleneck with the bab[ble]el-language The -:Volition of the ailing-language-education-systems-positied is with the Lack of the righteous-Knowledge of the So-Let-It-Be-Written,-:So-Let-It-Be-Done -Lawful-communication-:EBA-1933-AD -Education-DUTY by the Trustee-Dereliction	8:20 AM · May 29, 2022 https://twitter.com/DarBenThu1/status/1530932079948492800 Language-Fraud-Hearing

:Mark	:Matter	:Location	:Claim	:Facts	185 / 199
-------	---------	-----------	--------	--------	-----------



1978

				:D-W: Miller ~2014 July 09~
~0638	Babel Language Bottleneck Lawful-Communication Trustee Dereliction	12:06 PM · Jul 31, 2022 https://twitter.com/DarBenThu1/status/1553819443368669184	:Bottleneck with -:bab[ble]el-language #Ohioan #StateCountryManSettlorGrantor #NewMexican @AoPotus @PFTUSAof1787AO @xNursen2010 @TrusteeCn1213 #Ohio #NewMexico #Arizonan #Arizona #NationalGuard #Army #Navy #Marines #AirForce #USPHS #NOAA #USSE #Milley #MilleyOn #USofA1776ADPeople	11:57 AM · Jul 31, 2022 https://twitter.com/DarBenThu1/status/1553817227417112578
:Era 2 #Aug2022DarBenThu1		:Era 2 #Aug2022DarBenThu1		
~0639	Four Face of Yshuah Sons of God Neville Johnson Redeemed Big Daddy Weave	6:39 AM · Aug 2, 2022 https://twitter.com/DarBenThu1/status/1554461799285915648	2022 August 02 Shalom `as long as you are conscious of need you have nothing to give` Bro. Neville Johnson The Four Faces of Jesus and the Endtimes Sons of God Part 1 - Eagle by Rev. Neville Johnson https://youtube.com/watch?v=UgR-svtNtuQ&list=PL27Ykb9LpnHs79XTz1YKHacsrhBlaTSwf&index=18 Big Daddy Weave Redeemed Video https://youtu.be/QBZSPXwOTzQ	
~0640	Babel Language Bottleneck Lawful-Communication Trustee Dereliction	10:56 PM · Aug 2, 2022 https://twitter.com/DarBenThu1/status/1554707860327501825	2022 August 02 :Just-2-say-Hi. @dazhillbilly @AspireOnTheFlag @FreedomofPress @jagexx @ultan_nesbitt @JosephBrandtRu1 @Yellomagnehuman @RaiseWisdom @FORTHEJASON #Ohioan	12:06 PM · Jul 31, 2022 https://twitter.com/DarBenThu1/status/1553819443368669184

:Mark	:Matter	:Location	:Claim	:Facts	186 / 199
-------	---------	-----------	--------	--------	-----------



2458

			#StateCountryManSettlorGrantor #DOI1776AD #Concession1213AD #EBA1933AD #Covenant #Ohio #NewMexico #NewMexican	:Bottleneck with the babble-Language
~0641	KVJ Proverbs 1 DOI 1776 Covenant Claim	1:39 PM · Aug 3, 2022 https://twitter.com/DarBenThu1/status/1554930094245695488	2022 AUGUST 3 KJV- Proverbs 1 v 10- 19 with the context of the DOI-1776-AD- Covenant-Claim. 10 ¶ My son, if sinners entice thee, consent thou not. 11 If they say, Come with us, let us lay wait for blood, let us lurk privily for the innocent without cause: :Harder?	https://twitter.com/DarBenThu1/status/1544320277768806406/photo/1 https://pbs.twimg.com/media/FZQ4mv5UsAAhWYD?format=jpg&name=4096x4096 Proverbs 1 v 10- 19 with the context of the DOI-1776-AD- Covenant-
~0642	General Milley	1:42 PM · Aug 3, 2022 https://twitter.com/DarBenThu1/status/1554930830266421248	#Milley #MilleyOn @dazhillbilly @AspireOnTheFlag @FreedomofPress @jagexx @ultan_nesbitt @JosephBrandtRu1 @Yellomagnehuman @RaiseWisdom @FORTHEJASON #Ohioan #StateCountryManSettlorGrantor #DOI1776AD #Concession1213AD #EBA1933AD #Covenant #Ohio #NewMexico #NewMexican	1:39 PM · Aug 3, 2022 https://twitter.com/DarBenThu1/status/1554930094245695488
~0643	Twitter- EBA-1933 - Trustee Failure Beneficiary Damages EBA 1933 License	8:02 AM · Aug 4, 2022 https://twitter.com/DarBenThu1/status/1555207563045507072	2022 August 04 -:Twitter-EBA-1933-AD- Trustee-damage: Ohioan: Un-alien-able-Right: DOI-1776-AD with the complete-lack of the permission, authorization nor: law: DOI-1776-AD by the Ohioan- Darrell-James: Hill, minister-Procurator: EBA-1933-AD: -2021-AD; :EBA-License :Termination.	https://twitter.com/DarBenThu1/status/1544320277768806406/photo/1 https://pbs.twimg.com/media/FZU057GUUAEnvy_?

:Mark	:Matter	:Location	:Claim	:Facts	187 / 199
-------	---------	-----------	--------	--------	-----------



187

				<p>format=jpg&name=4096x4096</p> <p>https://pbs.twimg.com/media/FZU07zkVQAAzqcc?format=jpg&name=4096x4096</p> <p>https://pbs.twimg.com/media/FZU09tFUUAEb6PQ?format=jpg&name=large</p> <p>https://pbs.twimg.com/media/FZU0_2fUIAAsKov?format=jpg&name=4096x4096</p> <p>:Twitter-EBA-1933-AD- Trustee-damage: Ohioan: Un-alien-able-Right: DOI-1776-AD</p>
-0644	General Milley	<p>8:23 AM · Aug 4, 2022</p> <p>https://twitter.com/DarBenThu1/status/1555212869238550528</p>	<p>#Milley #MilleyOn</p> <p>@dazhillbilly @AspireOnTheFlag @FreedomofPress</p> <p>@jagexx @ultan_nesbitt @JosephBrandtRu1 @Yellomagnehuman @RaiseWisdom #Ohioan #StateCountryManSettlorGrantor #DOI1776AD #Concession1213AD #EBA1933AD #Covenant #Ohio #NewMexico #NewMexican #StateCountryMan</p>	<p>8:02 AM · Aug 4, 2022</p> <p>https://twitter.com/DarBenThu1/status/1555207563045507072</p>
-0645	Freedom of the Speech David Icke DOI 1776 fidelity	<p>3:17 PM · Aug 4, 2022</p> <p>https://twitter.com/DarBenThu1/status/1555316932521312256</p>	<p>2022 August 4 Freedom of the Speech – :David :Icke</p> <p>David Icke on Free Speech & Who controls the World https://youtube.com/watch?v=bkfoL9afMcM</p>	<p>https://www.youtube.com/watch?v=bkfoL9afMcM</p>

:Mark	:Matter	:Location	:Claim	:Facts	188 / 199
-------	---------	-----------	--------	--------	-----------



2442

			For -:full-right: DOI-1776-AD to the with the fidelity-duty: #DOI1776AD -#EBA1933AD -Covenant is with: #MerrickGarland, #USAG #CLT and: #SecBlinken,	
-0646	General Milley	3:23 PM · Aug 4, 2022 https://twitter.com/DarBenThu1/status/1555318498980573184	#Milley #MilleyOn @dazhillbilly @AspireOnTheFlag @FreedomofPress @jagexx @ulfan_nesbitt @JosephBrandtRu1 @Yellomagnehuman @RaiseWisdom #Ohioan #StateCountryManSettlorGrantor #DOI1776AD #Concession1213AD #EBA1933AD #Covenant #Ohio #NewMexico #NewMexican #StateCountryMan	3:17 PM · Aug 4, 2022 https://twitter.com/DarBenThu1/status/1555316932521312256
-0647	KJV Jude Exodus	4:01 AM · Aug 5, 2022 https://twitter.com/DarBenThu1/status/1555509325887508480	2022 August 5 KJV- Jude ~ 1:1 to 1:25 5 I will therefore put you in remembrance though ye once knew this, how that the LORD, having saved the People out of the land of Egypt, afterward destroyed them that believed not. https://www.youtube.com/watch?v=K8PPwoqjUA8&list=PL4L1hz0VIV7O69j-Rqo9MfLdoraCslK8y&index=3	https://twitter.com/DarBenThu1/status/1544320277768806406/photo/1 https://pbs.twimg.com/media/FZZG-rNUsAA0W6Q?format=jpg&name=4096x4096 https://pbs.twimg.com/media/FZZHAJNUIAAveVz?format=jpg&name=4096x4096 https://pbs.twimg.com/media/FZZHBPeUsAAZwJl?format=jpg&name=4096x4096 KJV- Jude 1
-0648	KJV Books – All Read	3:51 AM · Aug 8, 2022	2022 AUGUST 8 : tmantz625	https://www.youtube.com/user/tmantz625/

:Mark	:Matter	:Location	:Claim	:Facts	189 / 199
-------	---------	-----------	--------	--------	-----------



JPH

Un

:Two-Year-Review :Dar-Ben-Thu: Hill ~www.twitter.com/DarBenThu1~ -Authority
https://twitter.com/hashtag/darbenthu1September222020?src=hashtag_click
:DarBenThu1 -Box-Graph: #September2020AD > #August2022AD

		https://twitter.com/DarBenThu1/status/1556593900575281152	https://youtube.com/user/tmantz625/videos :KJV- BOOKS- ALL read	videos
-0649	Protect Your Temple Shon Hedrick	10:29 AM · Aug 8, 2022 https://twitter.com/DarBenThu1/status/1556694104372695041	2022 AUGUST 8 PROTECT YOUR TEMPLE Shon Hedrick God gave me a word about the food today https://youtube.com/watch?v=WCVPRS-dazQ	https://www.youtube.com/watch?v=WCVPRS-dazQ
-0650	Constitution = DOI 1776 by the People with Almighty-God.	12:33 AM · Aug 9, 2022 https://twitter.com/DarBenThu1/status/1556906506083110913	2022 AUGUST 9 CONSTITUTION, verb? noun? a) The constitution ~v & n.~:United-States is the #DOI1776AD ; b) For the #CftUSofA1787AD -document ~with the #BORights1789AD is with the #DOI1776AD - #USofA1776AD -#StateCountryMan -overstanding of the all-oath-takers by the #DOI1776AD .	
-0651	General Milley Constitution = DOI 1776 by the People with Almighty-God.	12:44 AM · Aug 9, 2022 https://twitter.com/DarBenThu1/status/1556909302379532288	#Milley #MilleyOn @dazhillbilly @AspireOnTheFlag @FreedomofPress @jagexx @ultan_nesbitt @JosephBrandtRu1 @Yellomagnehuman @RaiseWisdom #Ohioan #StateCountryManSettlorGrantor #DOI1776AD #EBA1933AD #Ohio #NewMexico #NewMexican #StateCountryMan #CftUSofA1776AD #USofA1776ADPeople	12:33 AM · Aug 9, 2022 https://twitter.com/DarBenThu1/status/1556906506083110913
-0652	Constitution = DOI 1776	12:54 AM · Aug 9, 2022	2022 August 9 The -:Loyalty-Oath of the Office-takers: US-	12:33 AM · Aug 9, 2022

:Mark	:Matter	:Location	:Claim	:Facts	190 / 199
-------	---------	-----------	--------	--------	-----------



[Handwritten signature]

	by the People with Almighty-God.	https://twitter.com/DarBenThu1/status/1556911735730159617	Corp et seq- EBA-1933-AD- Trustee-Licensees is with the allegiance under the #DOI1776AD - #USofA1776ADPeople - Authority by the law of the DOI-1776-AD. See?	https://twitter.com/DarBenThu1/status/1556906506083110913
~0653		12:54 AM · Aug 9, 2022 https://twitter.com/DarBenThu1/status/1556911735730159617	2022 August 9 The -:Loyalty-Oath of the Office-takers: US-Corp et seq- EBA-1933-AD- Trustee-Licensees is with the allegiance under the #DOI1776AD- #USofA1776ADPeople - Authority by the law of the DOI-1776-AD. See?	12:33 AM · Aug 9, 2022 https://twitter.com/DarBenThu1/status/1556906506083110913 https://twitter.com/DarBenThu1/status/1544320277768806406/photo/1 https://pbs.twimg.com/media/FZtCB-VQAAI6b7?format=jpg&name=4096x4096 https://pbs.twimg.com/media/FZtCFD7UsAYt3Bp?format=jpg&name=4096x4096 https://pbs.twimg.com/media/FZtCPgEVEAA3OA2?format=jpg&name=4096x4096 Loyalty-Oath of the Office-takers: US-Corp et seq- EBA-1933-AD- Trustee-Licensees
~0654	BC Authentication Civil-Live-Status Standing	11:53 AM · Aug 9, 2022 https://twitter.com/DarBenThu1/status/	2022 AUGUST 9 After the Birth-Certification-Authentication -BC-Auth~ then the -:civil-live-status is with the making of the public-notice by your chosings and public-recording(s). See	5:10 AM · Jul 14, 2022 https://twitter.com/DarBenThu1/status/

:Mark	:Matter	:Location	:Claim	:Facts	191 / 199
-------	---------	-----------	--------	--------	-----------



Handwritten initials/signature

		1557077715445960705	:Attached. Shalom. What to do next.	1547554026417336320 https://twitter.com/DarBenThu1/status/1544320277768806406/photo/1 https://pbs.twimg.com/media/FZvZqzkVEAA5B0G?format=jpg&name=4096x4096 Authenticated- BC? Than, What to do next.
~0655	Political Election FSIA US-Corp EBA 1933 State Country Man Sovereign Settlor Grantor	<u>7:13 PM · Aug 9, 2022</u> https://twitter.com/DarBenThu1/status/1557188444668903425	2022 August 9 :Our- Political-Elections :2016-AD See: https://twitter.com/DarBenThu1/status/1309314462768267264 Our -First -Political- Election :2016-AD See page: 1- 242. See: Procuration: EBA-1933-AD over US-Corp https://twitter.com/DarBenThu1/status/1367915700866584576 See: Covenant-Docs of #EveryStateCountryMan	<u>8:49 AM · Apr 7, 2022</u> https://twitter.com/DarBenThu1/status/1512095186070827009 https://twitter.com/DarBenThu1/status/1309314462768267264 https://twitter.com/DarBenThu1/status/1367915700866584576 https://twitter.com/DarBenThu1/status/1512095186070827009
~0656		<u>2:24 AM · Aug 10, 2022</u> https://twitter.com/DarBenThu1/status/1557296871906758656	<u>5:50 PM · May 15, 2022</u> https://twitter.com/DarBenThu1/status/1526002077595336704 <u>8:13 PM · May 6, 2022</u> https://twitter.com/DarBenThu1/status/1522776515192139778	https://twitter.com/DarBenThu1/status/1526002077595336704

:Mark	:Matter	:Location	:Claim	:Facts	192 / 199
-------	---------	-----------	--------	--------	-----------



Handwritten signature or initials.

			3:03 AM · May 5, 2022 https://twitter.com/DarBenThu1/status/1522154973630320640	
-0657		2:25 AM · Aug 10, 2022 https://twitter.com/DarBenThu1/status/1557297114517868544	12:20 AM · Jul 8, 2022 https://twitter.com/DarBenThu1/status/1545306920004624384	https://twitter.com/DarBenThu1/status/1544320277768806406/photo/1 Information-Contact-Claim
-0658		2:27 AM · Aug 10, 2022 https://twitter.com/DarBenThu1/status/1557297505112510464	TO: #GenMilley , #GenMilleyOn #CJOS #USAirmedForces #USArmy #USNavy #USMarines #USCoastGuard #USNOAA #USPHS #USAirforce #USSE	12:04 PM · May 17, 2022 https://twitter.com/DarBenThu1/status/1526639844423630849 https://twitter.com/DarBenThu1/status/1526639844423630849 https://twitter.com/DarBenThu1/status/1544320277768806406/photo/1 https://pbs.twimg.com/media/FS-1HsXVEAA9r7T?format=jpg&name=4096x4096
-0659	State Country Man Sovereign Beneficiary Settlor Grantor Executor Procurator Deprivation- Non-Consent Ohioan New-Mexican	2:41 AM · Aug 10, 2022 https://twitter.com/DarBenThu1/status/1557301139497857024	2022 AUGUST 10 -> 2021 DECEMBER 02 DOC: Procurator-Proof-of-notice-7009- 1410 0000 7868 5802- :Executor: PE-2017-A.D.- Nonconsent to :DOI-1776-A.D.- deprivation of -:unalienable-rights upon the man- Ohioan and New-Mexican by the Executor- Procurator https://blackandbluesoulsmatter.files.wordpress.com/2021/12/	https://lackandbluesoulsmatter.files.wordpress.com/2021/12/2021_016195.pdf Procurator- Proof-of-notice-7009- 1410 0000 7868 5802- :Executor: PE-2017-A.D.-

:Mark	:Matter	:Location	:Claim	:Facts	193 / 199
-------	---------	-----------	--------	--------	-----------



Handwritten signature/initials

			2021_0	Nonconsent to :DOI-1776-A.D.- deprivation of -:unalienable-rights upon the man- Ohioan and New-Mexican by the Executor- Procurator
-0660	General Milley Attorney GENERAL is an Warrant-Escrow-Officer DOI 1776	9:23 AM · Aug 10, 2022 https://twitter.com/DarBenThu1/status/1557402236220690432	Laws of war: protecting civilians in an armed conflict. Is a rouge- EBA-1933-AD -Trustee-FBI at war with the State- Country-Man-Beneficiary-Sovereigns? Cointelpro https://en.wikipedia.org/wiki/COINTELPRO ? Did it ever Stop? {NO?} See: top right? Yellow/black. At-Dark => Civilian-sign!!! #MilleyOn!	https://en.wikipedia.org/wiki/COINTELPRO https://twitter.com/DarBenThu1/status/1544320277768806406/photo/1 https://pbs.twimg.com/media/FZz_BSVVUAA468e?format=jpg&name=large FBI continuing Co-Intepro against the Beneficiary https://pbs.twimg.com/media/FZ0BECvVUAAXGiR?format=jpg&name=large Obama, Trump and Gore have stolen my property: DOI-1776-AD
-0661	Constitution = DOI 1776 by the People with Almighty-God General Milley Attorney GENERAL Warrant-Escrow-Officer DOI 1776	12:53 PM · Aug 10, 2022 https://twitter.com/DarBenThu1/status/1557455227766288385	#GenMilley , #GenMilleyOn #CJOS #USAirmedForces #USArmy #USNavy #USMarines #USCoastGuard #USNOAA #USPHS #USAirforce #USSE	9:23 AM · Aug 10, 2022 https://twitter.com/DarBenThu1/status/1557402236220690432 https://twitter.com/DarBenThu1/status/1544320277768806406/photo/1 Obama, Trump and Gore have stolen my property: DOI-1776-AD

:Mark	:Matter	:Location	:Claim	:Facts	194 / 199
-------	---------	-----------	--------	--------	-----------



Handwritten signature/initials

:Two-Year-Review :Dar-Ben-Thu: Hill ~www.twitter.com/DarBenThu1~ -Authority
https://twitter.com/hashtag/darbenthu1September222020?src=hashtag_click
:DarBenThu1 -Box-Graph: #September2020AD > #August2022AD

-0561	General Milley Attorney GENERAL is an Warrant-Escrow-Officer DOI 1776 Arizona State Country County Sheriff	1:43 PM · Aug 10, 2022 https://twitter.com/DarBenThu1/status/1557467657653276672	2022 AUGUST 10 Arizona-Country-State-Sheriff-Trustees #ArizonaSheriffsAssociation #ArizonaApacheCountySheriff #ArizonaCochiseCountySheriff #ArizonaCoconinoCountySheriff #ArizonaGilaCountySheriff #ArizonaGrahamCountySheriff	9:23 AM · Aug 10, 2022 https://twitter.com/DarBenThu1/status/1557402236220690432
-0562	General Milley Attorney GENERAL is an Warrant-Escrow-Officer DOI 1776 Arizona State Country County Sheriff	1:44 PM · Aug 10, 2022 https://twitter.com/DarBenThu1/status/1557467891670269952	2022 AUGUST 10 Arizona-Country-State-Sheriff-Trustees #ArizonaGreenleeCountySheriff #ArizonaLaPazCountySheriff #ArizonaMaricopaCountySheriff #ArizonaMohaveCountySheriff #ArizonaNavajoCountySheriff #ArizonaPimaCountySheriff	9:23 AM · Aug 10, 2022 https://twitter.com/DarBenThu1/status/1557402236220690432
-0563	General Milley Attorney GENERAL is an Warrant-Escrow-Officer DOI 1776 Arizona State Country County Sheriff	1:44 PM · Aug 10, 2022 https://twitter.com/DarBenThu1/status/1557468011182694400	#ArizonaSantaCruzCountySheriff #ArizonaYavapaiCountySheriff #ArizonaYumaCountySheriff #ArizonaConferenceOfPoliceandSheriffs #ArizonaChiefsOfPolice	9:23 AM · Aug 10, 2022 https://twitter.com/DarBenThu1/status/1557402236220690432
-0564	General Milley Attorney GENERAL is an Warrant-Escrow-Officer DOI 1776 Arizona State Country County Sheriff	6:14 PM · Aug 10, 2022 https://twitter.com/DarBenThu1/status/1557535918700916736	#Milley #MilleyOn @dazhillbilly @AspireOnTheFlag @FreedomofPress @jagexx @ultan_nesbitt @JosephBrandtRu1 @Yellomagnehuman @RaiseWisdom #Ohioan #Arizonan #Californian #Utahan #Coloradan #DOI1776AD #EBA1933AD #Ohio #NewMexico #NewMexican #StateCountryMan #CftUSofA1776AD #USofA1776	9:23 AM · Aug 10, 2022 https://twitter.com/DarBenThu1/status/1557402236220690432
-0565	General Milley	11:16 AM · Aug 11, 2022	2022 AUG 11 AUTH FOR RESTORATION;	https://

:Mark	:Matter	:Location	:Claim	:Facts	195 / 199
-------	---------	-----------	--------	--------	-----------



Handwritten initials

	Attorney GENERAL is an Warrant-Escrow-Officer DOI 1776 Arizona State Country County Sheriff	https://twitter.com/DarBenThu1/status/1557793115397885955	CIVILIAN-SIGN 2020 December 12 for the :RIGHT OF :CONUSANCE ~USPS RMN RE 322 387 616 US...[;] is with this :DEMAND: -Authorization for the Restoration of the Lawful-Government. -- with the law by the law ">https://blackandbluesoulsmatter.wordpress.com/2020/12/12/right-of-civilian->	blackandbluesoulsmatter.wordpress.com/2020/12/12/right-of-conusance-usps-rmn-re-322-387-616-us-demand-authorization-for-the-restoration-of-the-lawful-government-this-is-done-as-the-kinsman-redeemer-is-58-et-al/ https://twitter.com/DarBenThu1/status/1544320277768806406/photo/1 https://pbs.twimg.com/media/FZ5jicKVEAAF_8g?format=jpg&name=4096x4096 Civilian sign
~0566	Wuhan Ukraine Gene Targeting Yacob Ysrael Flu-symptoms	3:00 AM · Aug 12, 2022 https://twitter.com/DarBenThu1/status/1558030715995836416	2022 August 12 Yacob's-/Ysrael's Trouble? Gene targeting cells? [Wuhan-Ukraine-] research-work-up better-ways of viral-carrier-vectors ~gene-viruses~ because they can deliver genetic material ~w/ flu-like symptoms~. Some target unhealthy cells. Search: china gene target tech.	
~0567		3:04 AM · Aug 12, 2022 https://twitter.com/DarBenThu1/status/1558031569117270016	#Milley #MilleyOn @dazhillbilly @AspireOnTheFlag @FreedomofPress @jagexx @uitan_nesbitt @JosephBrandtRu1 @Yellomagnehuman @RaiseWisdom #Ohioan #Arizonan #Californian #Utahan #Coloradan #DOI1776AD #EBA1933AD #Ohio #NewMexico #NewMexican #StateCountryMan #CftUSofA1776AD	11:16 AM · Aug 11, 2022 https://twitter.com/DarBenThu1/status/1557793115397885955 https://twitter.com/DarBenThu1/status/1544320277768806406/photo/1

:Mark	:Matter	:Location	:Claim	:Facts	196 / 199
-------	---------	-----------	--------	--------	-----------



seph

			#USofA1776	https://pbs.twimg.com/media/FZ5jicKVEAAF_8g?format=jpg&name=4096x4096 Civilian sign
-0568		1:07 PM · Aug 13, 2022 https://twitter.com/DarBenThu1/status/1558545720801501185	2022 AUGUST 13 https://youtube.com/watch?v=Fgm9UA International house of prayer kansas city	https://www.youtube.com/watch?v=Fgm9UAzdzQY https://twitter.com/DarBenThu1/status/1544320277768806406/photo/1 https://pbs.twimg.com/media/FaEQhYMUIAE_-RT?format=jpg&name=large ihopkc -Notice Child-Trafficking in the US
-0569	Frog California Risk Feasible	7:06 AM · Aug 14, 2022 https://twitter.com/DarBenThu1/status/1558817366355501056	2022 August 14 This is good economic-consideration for us all. Some frogs won't leave BUT WHEN your pain is their game Then... ? California [OR ANYWHERE!] This Video May Trigger You - Watch At Your Own Risk https://youtube.com/watch?v=eu16Qy	https://www.youtube.com/watch?v=eu16QyvgBac #valuetainment #patrickbetdavid
-0570	Two-Year Review	1:54 PM · Aug 15, 2022 https://twitter.com/DarBenThu1/status/1559282357500227584	2022 August 15 Two-Year-Review #darbenthu1September222020	August 25, 2022, 0300
-0571	Bless the Most High God	11:13 AM · Aug 17, 2022	2022 August 17 Devotion to the Most-High-God and Father of	https://www.ihopkc.org/prayerroom/#asset/
:Mark	:Matter	:Location	:Claim	:Facts



Handwritten initials

	Father	https://twitter.com/DarBenThu1/status/1559966633069666304	the Almighty-God- Yushuah-Messiah-33-AD >> :now. :Lord :i-man :love-you -more-than-anything. https://ihopkc.org/prayerroom/#asset/event_site_68FBe1c2dE_10840_4091/auto/true The King is :Exalted, :Amein.	event_site_68FBe1c2dE_10840_4091/auto/true
-0572	Pinned Tweet @DarBenThu1	7:05 PM · Sep 24, 2020	<p>Pinned Tweet</p>  <p>Darrell James hill @DarBenThu1</p> <p>:i- man am wanting you to send this information to others so :Donald-John: Trump may be known to get this. :i- man have been robbed.</p> <p>A: Cover to the Generals https://blackandbluesoulsmatter.files.wordpress.com/2020/09/a-2020-09-20-cover-to-cjos-and-net-all.pdf</p> <p>B: Body of the Document to :Donald. https://blackandbluesoulsmatter.files.wordpress.com/2020/09/b-1020</p>	<p>https://blackandbluesoulsmatter.files.wordpress.com/2020/09/a-2020-09-20-cover-to-cjos-and-net-all.pdf</p> <p>https://blackandbluesoulsmatter.files.wordpress.com/2020/09/b-1020-intro-to-finale-67-djt-compile-final-x-done-110-pages.pdf</p>

:Mark	:Matter	:Location	:Claim	:Facts	198 / 199
-------	---------	-----------	--------	--------	-----------



2470

:Two-Year-Review :Dar-Ben-Thu: Hill ~www.twitter.com/DarBenThu1~ -Authority
https://twitter.com/hashtag/darbenthu1September22020?src=hashtag_click
 :DarBenThu1 -Box-Graph: #September2020AD > #August2022AD

-0573	:Era 3 #2022DarBenThu1	:Era 3 #2022DarBenThu1	:Era 3 #2022DarBenThu1	:Era 3 #2022DarBenThu1
-0574	:Era 3 #Sept2022DarBenThu1			:Era 3 #Sept2022DarBenThu1
-0575	:Era 3 #Oct2022DarBenThu1			:Era 3 #Oct2022DarBenThu1
-0576	:Era 3 #Nov2022DarBenThu1			:Era 3 #Nov2022DarBenThu1
-0577	:Era 3 #Dec2022DarBenThu1			:Era 3 #Dec2022DarBenThu1

:Mark	:Matter	:Location	:Claim	:Facts	199 / 199
-------	---------	-----------	--------	--------	-----------

2022-011769 MISC Page: 2782 of 2782
 09/26/2022 03:35:37 PM Receipt #: 22-9381
 Rec Fee: \$30.00 Darrell James Hill
 Gila County, Az, Sadie Jo Bingham, Recorder



1242